

01/11/2023

Automation 360.27

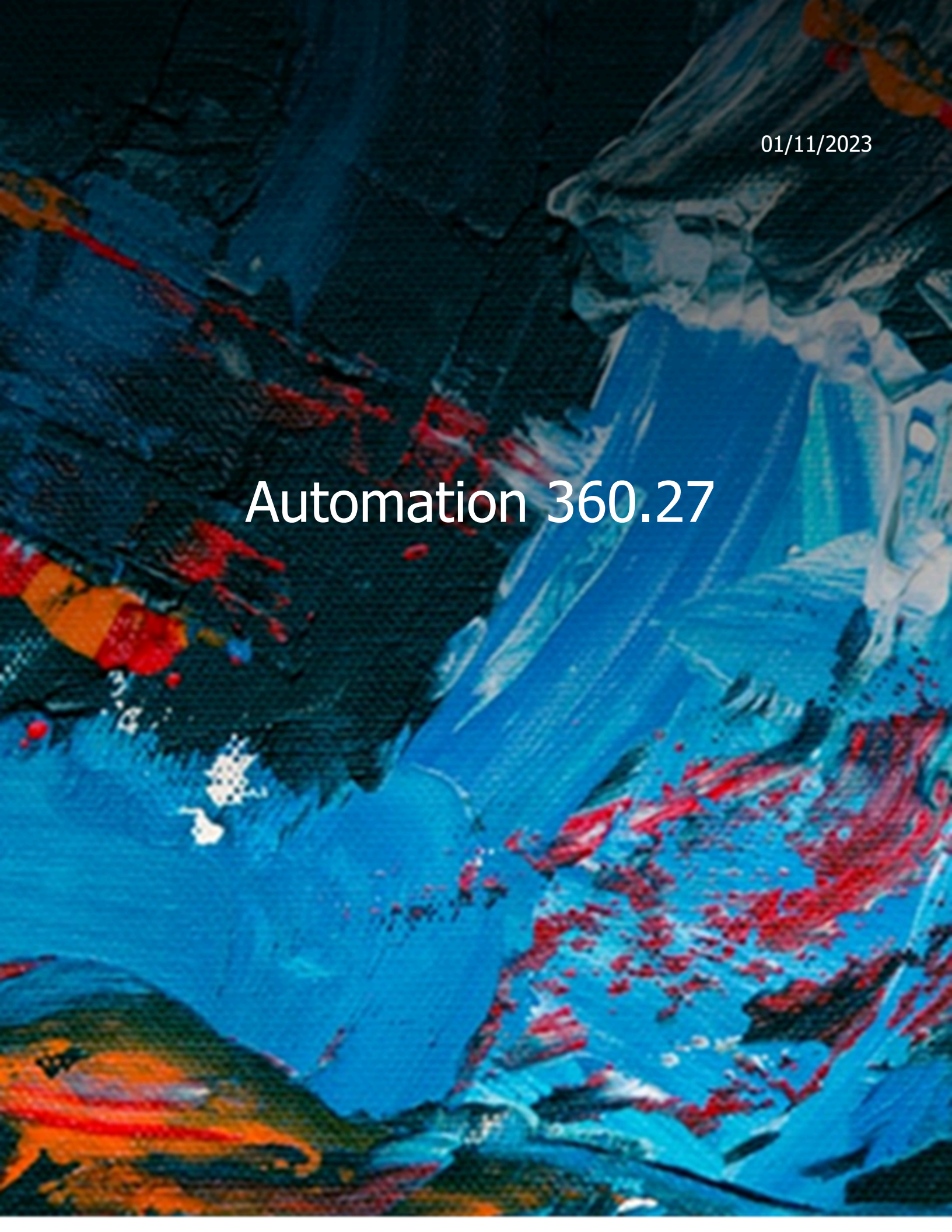

Contents

Explore.....	11
About Automation 360.....	12
Control Room overview.....	19
Distributed architecture.....	20
Security architecture.....	22
General Data Protection Regulation guidelines.....	44
Automation 360 architecture and resiliency.....	44
Automation 360 FAQ.....	48
Automation 360 Cloud FAQ.....	51
Private Bot Store.....	57
Learn.....	58
Automation 360 Release Notes.....	59
Automation 360 v.27 Release Notes.....	59
Automation 360 v.26 Release Notes.....	116
Automation 360 v.25 Release Notes.....	157
Automation 360 v.24R2 Release Notes for Internet Explorer 11 EOL.....	201
Automation 360 v.24 Release Notes.....	209
Automation 360 v.23 Release Notes.....	246
Automation 360 v.22 Release Notes.....	284
Automation 360 v.21 Release Notes.....	315
Enterprise A2019.20 Release Notes.....	343
Enterprise A2019.19 Release Notes.....	374
Enterprise A2019.18 Release Notes.....	395
Enterprise A2019.17 Release Notes.....	415
Enterprise A2019.16 Release Notes.....	441
Previous Automation 360 Release Notes.....	466
Community Edition Release Notes.....	562
Automation 360 v.27 Community Edition Release Notes.....	562
Automation 360 v.26 Community Edition Release Notes.....	569
Automation 360 v.25 Community Edition Release Notes.....	573
Automation 360 v.24 Community Edition Release Notes.....	578
Automation 360 v.23 Community Edition Release Notes.....	586
Automation 360 v.22 Community Edition Release Notes.....	595
Previous Community Edition Release Notes.....	600
Automation 360 Sandbox Release Notes.....	626
Sandbox environment.....	626
Automation 360 Package SDK Release Notes.....	628
Process Discovery Release Notes.....	634
Process Discovery Version 1.60.0 Release Notes.....	634
Neo Sensor Version 2.4.1.....	635
CoE Manager Release Notes.....	636
Automation 360 feature comparison matrix.....	636
Automation 360 IQ Bot feature comparison matrix.....	649
Automation 360 IQ Bot version compatibility.....	654
Automation 360 software lifecycle policy.....	655
Automation 360 Cloud Service Status site.....	659
Automation 360 Cloud updates.....	664
Subscribing to notifications.....	667
Feature deprecations affecting Automation Anywhere products.....	667
Microsoft Internet Explorer EOL overview.....	673

Deprecation of Basic authentication in Exchange Online.....	697
Chrome and Edge Manifest V3 extensions.....	711
Deprecation of Tesseract OCR v3.....	723
Install and update.....	727
Get started with Automation 360 Cloud.....	729
Automation 360 Cloud prerequisites.....	730
Installing Control Room On-Premises.....	740
Automation 360 On-Premises prerequisites.....	742
Installing Control Room using custom mode for Oracle installation.....	799
Installing Control Room using Custom mode.....	800
Installing Control Room using Express mode.....	819
Installing Control Room on Amazon Web Services.....	821
Installing Control Room on Microsoft Azure.....	827
Installing Control Room on Google Cloud Platform.....	836
Installing Control Room on Linux.....	842
Installing Control Room on Microsoft Windows Server using scripts.....	854
Complete Control Room post-installation configuration.....	860
Uninstalling Automation 360.....	870
Installing Control Room for Cloud-enabled deployment.....	870
Naming guidelines for Control Room URLs.....	872
Post-installation user management.....	873
Configure the Control Room as a service provider.....	873
Configure Control Room authentication options.....	874
Preparing for users.....	888
Installed Control Room directories and files.....	894
Licenses and cloud services.....	901
Get started with Community Edition.....	913
Community capacity and limitations.....	914
Log in to Automation Anywhere Control Room.....	915
Install Bot Agent and register device.....	916
About the Bot Agent.....	919
Bot Agent compatibility.....	922
Working with the Bot Agent.....	933
Perform bulk installation of Bot Agent on devices.....	935
Perform installation of Bot Agent on multiple devices.....	938
Bulk install Bot Agent using Microsoft Endpoint Configuration Manager.....	941
Automatically update the Bot Agent.....	943
Manually update the Bot Agent.....	944
Switch Bot Agent to a different Control Room.....	946
Connect Bot Agent to a device with a proxy.....	947
Perform Bot Agent diagnostic checks.....	949
Set user device credentials.....	953
View and update Bot Agent device settings.....	954
Create your first bot.....	954
Run your first bot.....	956
Update to latest Automation 360 version.....	957
Update Automation 360 on Microsoft Windows Server using scripts.....	958
Enhancements to browser extensions.....	960
Browser extensions for web applications.....	961
Install and update Automation 360 IQ Bot.....	962
IQ Bot installation prerequisites.....	964
Installing IQ Bot in Express mode.....	973
Installing IQ Bot in Custom mode.....	975
Installing IQ Bot in Cluster mode.....	978
Installing IQ Bot in Cluster mode on Amazon EC2.....	982

Postinstallation checklist.....	982
Updating Automation 360 IQ Bot.....	1007
Uninstalling IQ Bot.....	1011
High Availability and Disaster Recovery overview.....	1011
Migrate.....	1020
Migration best practices.....	1025
Check migration readiness.....	1028
Supported Control Room versions for migration.....	1028
Bot Scanner overview.....	1048
Get migration license.....	1062
Prepare new Control Room for migration.....	1063
Choose deployment model.....	1064
Prepare for Enterprise 11 to Automation 360 Cloud migration.....	1067
Prepare to manually migrate to Automation 360 Cloud.....	1075
Prepare for Enterprise 11 to Automation 360 On-Premises migration.....	1077
Prepare to manually migrate to Automation 360 On-Premises.....	1088
Prepare for Enterprise 11 to Automation 360 Cloud-enabled migration.....	1089
Prepare for Enterprise 11 to Automation 360 on Linux CentOS migration.....	1090
Prepare for Enterprise 10 to Automation 360 On-Premises migration.....	1091
Prerequisite tasks for migrating bots.....	1098
Migrate and validate bots.....	1099
Bot Migration Wizard.....	1100
Considerations when you migrate and validate bots.....	1101
Migrate Enterprise bots.....	1102
Validating and updating bots after migration.....	1129
Package mapping for migration.....	1131
Variable mapping for migration.....	1163
Global values in migrated bots.....	1179
Verify the bot migration.....	1181
View migration reports.....	1182
View changes to migrated bots using Bot Assistant.....	1184
Migration messages.....	1185
Differences while migrating APIs from Enterprise 11/Enterprise 10 to Automation 360.....	1216
Migrate Community Edition bots.....	1217
Migrate to Automation 360 IQ Bot.....	1219
Prepare for IQ Bot migration.....	1221
Migrate earlier IQ Bot versions to Automation 360 IQ Bot On-Premises.....	1222
Migrate from Automation 360 IQ Bot On-Premises to Cloud.....	1224
Migrating RBAC in IQ Bot.....	1231
Build.....	1236
Bot editor for creating bots.....	1237
Keyboard shortcuts to expand or collapse elements in bot logic.....	1239
Actions palette for bot creation.....	1241
Get started with recorders.....	1777
Working with bots.....	1819
Keyboard shortcuts.....	1846
Variables overview.....	1849
Bot dependencies.....	1871
Get started building bots.....	1874
Build a Go be Great bot.....	1875
Build a basic bot that uses a desktop application.....	1876
Example of extracting data from a web table.....	1878
Examples of building bots.....	1879
Example of entering data into a web form from a worksheet.....	1879

Example of passing a value between bots.....	1881
Example of using a conditional statement.....	1883
Example of using Python script to join a list.....	1885
Example of using the DLL package.....	1886
Example of transferring data from CSV file to Excel worksheet.....	1889
Run TaskBot to merge Excel sheets.....	1892
Example of migrating data from Excel to a database.....	1893
Example of using the Run action.....	1897
Example of using the SOAP web service action.....	1899
Example of using Get structure command from SAP BAPI package.....	1903
Example of writing data to SAP using SAP BAPI package.....	1905
Example of using Run standard workflow from SAP BAPI package.....	1907
Example of using the VBScript package in a resilient bot.....	1909
Build a Bot Insight dashboard bot.....	1912
Example of using multiple analyze actions in a task.....	1915
Example of updating default package version across bots.....	1919
Example of using JSON package actions in a bot.....	1922
Create dictionary type variables.....	1927
Automation Anywhere Robotic Interface (AARI).....	1928
Using AARI on the web interface.....	1931
AARI web interface users.....	1935
Configure roles for AARI on the web.....	1937
Configure processes.....	1943
Deploy processes.....	1974
Bot setup.....	1994
Attended and unattended automation.....	1994
Using AARI on desktop.....	1995
About AARI Assistant.....	1996
Using interactive forms.....	1997
Adding a trigger to run a bot.....	2017
Example for using hot key to trigger a bot.....	2027
Embedded Automation.....	2028
AARI Integrations and AARI Extensions.....	2031
AARI Integrations overview.....	2033
AARI Extensions overview.....	2050
Example of Embedded Automation using AARI Integrations.....	2064
Example of Embedded Automation using AARI Extensions.....	2070
Example of Embedded Automation using AARI Extensions and AARI Integrations.....	2079
Process discovery by using Discovery Bot.....	2089
Get started with Discovery Bot.....	2091
Discovery Bot users.....	2092
Supported licenses for Discovery Bot.....	2094
Prerequisites for Discovery Bot.....	2097
Upgrade Discovery Bot from Enterprise A2019.15 to later versions.....	2098
Create users for Discovery Bot.....	2099
Create a Discovery Bot process.....	2105
Supported applications and browsers for Discovery Bot.....	2107
Record a Discovery Bot business process.....	2108
Record a Discovery Bot process using AARI Assistant.....	2113
Analyzing opportunities for automation.....	2114
Review opportunities, convert to bot, and generate PDD.....	2115
Getting started with Privacy Enhanced Gateway.....	2123
Deployment and networking requirements.....	2124
Install PEG.....	2125
PEG modes overview.....	2135
Determining content for redaction.....	2136

Manage redaction and forwarding settings from the UI.....	2139
Manage disk space.....	2143
Renew and replace certificates and keys.....	2144
Create image viewer user in analytics portal.....	2145
Configuring image viewer.....	2146
Using image viewer.....	2146
Neo Sensor application.....	2147
Installing Neo Sensor.....	2147
Installing Neo Sensor in a VDI environment.....	2148
Verify Neo Sensor Installation.....	2149
Enable and disable the users recording.....	2150
Preprocessing error messages.....	2150
Build advanced bots and packages.....	2151
Package SDK.....	2151
Using Python to parse JSON response.....	2216
Use JavaScript to build a bot to take user input.....	2224
Bot developer recommendations.....	2225
Bot Store submissions checklist.....	2225
Building reusable bots.....	2225
Building reusable packages.....	2231
Troubleshooting and debugging.....	2234
Troubleshoot bot run issue.....	2234
Debugger features.....	2235
Bot Agent log files.....	2237
Digitize.....	2239
Community Edition.....	2240
Create a learning instance in Community Edition.....	2241
Process documents in Community Edition.....	2243
Automation 360 IQ Bot.....	2244
IQ Bot architecture diagram.....	2247
Using Automation 360 IQ Bot On-Premises.....	2247
Using Automation 360 IQ Bot Cloud.....	2247
IQ Bot user personas and roles.....	2248
Languages supported in Automation 360 IQ Bot.....	2252
About the Classifier.....	2256
Create a learning instance.....	2259
Train a learning instance.....	2268
Manage learning instances.....	2296
Rotate the external key.....	2298
Use the IQ Bot Validator.....	2298
Review the dashboard.....	2303
Custom domains in IQ Bot.....	2305
Using IQ Bot for standard forms.....	2307
Evaluate your use case.....	2309
Review extraction service.....	2311
Review implementation prerequisites.....	2312
Set up extraction service.....	2316
Configure IQ Bot for extraction service.....	2316
Build extraction model.....	2317
Transfer third-party extraction service models.....	2318
Create a learning instance for standard forms.....	2318
Edit a standard forms learning instance.....	2319
Upload documents for standard forms learning instance.....	2321
Download extracted content.....	2321
Transfer standard forms learning instance.....	2322

Document Automation.....	2323
Document Automation FAQ.....	2326
Intelligent Document Processing solutions feature comparison matrix.....	2328
Set up your Document Automation environment.....	2330
Create a learning instance in Document Automation.....	2334
Connect learning instance.....	2349
Publish the learning instance.....	2351
Using the AARI Task Manager Validator for Document Automation.....	2359
Export/Import learning instances.....	2363
Create standard form in Document Automation.....	2363
Using Document Automation for Standard Forms.....	2365
Manage.....	2371
Activities.....	2373
Historical activity.....	2375
Scheduled activities.....	2378
Event triggers.....	2384
Devices.....	2388
Packages.....	2402
Administrator settings.....	2413
Audit log.....	2413
Users.....	2443
Roles.....	2451
Settings.....	2479
Code analysis.....	2528
Manage licenses.....	2539
Stop and start Control Room services on Linux.....	2541
Control Room log files.....	2542
Workload management.....	2543
Create workload queues.....	2545
Run bot with queue.....	2553
Manage workload queues.....	2557
Manage Work Items.....	2570
Workload guidelines.....	2573
Working with repositories, credentials and roles.....	2574
Manage user credentials.....	2575
Set up your bot repository.....	2575
Create your users and assign their licensed roles.....	2576
Bot Lifecycle Management.....	2578
Guidelines for exporting and importing bots.....	2580
Export bots.....	2580
Import bots.....	2582
Credentials and lockers in the Credential Vault.....	2584
Set up lockers and credentials in Credential Vault.....	2585
Set up locker and assign credentials.....	2586
Create credential.....	2587
Create locker.....	2589
Credential Vault email notifications.....	2591
External key vaults for Automation 360.....	2591
Integrating external key vault with Control Room.....	2593
External key vault naming conventions.....	2598
Integrating CyberArk Password Vault with Automation 360.....	2602
Integrating Azure Key Vault with Automation 360.....	2622
Integrating AWS Secrets Manager with Automation 360.....	2636
Changing external key vault to another.....	2649
Verify external key vault configuration.....	2650

Troubleshooting external key vaults.....	2651
Notifications.....	2652
Getting started with Notifications.....	2654
Manage notifications for Control Room.....	2659
Enable or disable event categories.....	2660
Capabilities supporting notifications.....	2661
Edit My settings.....	2662
Edit profile settings.....	2662
CoE Manager.....	2663
Getting started with CoE Manager.....	2665
Configure CoE Manager for Single Sign-On (SSO).....	2674
Using CoE Manager.....	2676
CoE Manager FAQ.....	2677
Bot Store.....	2680
Access Bot Store from the Control Room.....	2680
Submit bots or packages to Bot Store.....	2681
Directly import bots and packages from Bot Store to Control Room.....	2682
Download locally and import bots and packages from Bot Store to Control Room.....	2683
Getting started with Private Bot Store.....	2684
Set up A-People user access to Private Bot Store.....	2684
Set up SAML user access to Private Bot Store.....	2685
Submit and approve bots using Private Bot Store.....	2686
Submit and manage bot ideas using Private Bot Store.....	2686
Custom filter management in Private Bot Store.....	2687
Optimize.....	2689
Business analytics through Bot Insight.....	2689
Accessing Bot Insight.....	2690
Access Bot Insight from the Control Room.....	2690
Roles to access Bot Insight.....	2690
Role-based access control in Bot Insight.....	2691
Bot Insight dashboards.....	2692
Using Bot Insight.....	2709
Business analytics.....	2710
Using widgets.....	2711
Adding a dashboard widget.....	2712
Editing a dashboard widget.....	2715
Drilling down information in dashboard widget.....	2715
Renaming a dashboard widget.....	2716
Exporting data from a dashboard widget.....	2716
Data connector for Power BI.....	2716
Deploy Power BI connector.....	2717
Configure Power BI connector.....	2718
Example: Retrieve information in Power BI using business information API.....	2719
Configure Tableau web data connector in Bot Insight.....	2719
API references.....	2721
Bot Agent API: Auto registration.....	2721
Configure the Control Room.....	2722
Authentication API.....	2723
Authenticate (username and password).....	2724
Authenticate (username and apiKey).....	2727
Validate token.....	2731
Refresh token.....	2733
Expire token.....	2736
User management APIs.....	2737

Create role.....	2740
List roles.....	2745
Retrieve role.....	2747
Update role.....	2751
Delete role.....	2757
Create user.....	2757
Search for users API.....	2761
Retrieve a specific user details API.....	2764
Update an existing user details API.....	2766
Delete an existing user API.....	2768
Roles and permissions.....	2770
Audit API.....	2786
Example of createdOndate and userName filters in Audit API.....	2788
Device API.....	2790
List available unattended Bot Runners API.....	2791
Assign default device API.....	2792
Trigger API.....	2793
Create an event trigger.....	2793
Delete an event trigger.....	2795
Credential Vault APIs.....	2796
Set device login credentials API.....	2797
Configure a locker using API.....	2798
Configure a credential with attribute values using API.....	2800
Assign credential to locker API.....	2803
List credentials using API.....	2804
Update attribute values.....	2808
Get Masked credentials.....	2809
Bot Execution Orchestrator API.....	2811
Request device details.....	2812
Activity list.....	2815
Activity job execution.....	2820
Bot Scheduler APIs.....	2824
Schedule bot to run API.....	2825
List automation schedules API.....	2828
Repository Management APIs.....	2831
List files API.....	2833
Create folder.....	2836
Delete folder.....	2838
Edit details of folder.....	2839
List files and folders in a specific folder API.....	2841
List files and folders by workspace API.....	2843
Get Immediate Parents API.....	2845
Delete file/folder API.....	2847
File dependencies.....	2848
Update file dependencies.....	2850
Bot Insight API.....	2851
Get task log data.....	2852
Delete task log data.....	2854
Get bot run data.....	2856
Get Bot Insight audit trail data.....	2859
Get bot variables data.....	2860
Bot Lifecycle Management API.....	2861
Export files using API.....	2862
Import files using API.....	2864
Device pool API.....	2866
List device pools API.....	2866

Retrieve details of device pool by ID.....	2867
Create device pool API.....	2868
License API.....	2870
Retrieve Control Room license details API.....	2871
List Control Room licenses.....	2872
Deploy bots using API.....	2875
Bot deployment - V3.....	2876
Bot deployment - V4.....	2881
Workload Management API.....	2885
Create Work Item model API.....	2886
Create queues API.....	2887
Add queue owner or member API.....	2889
Add queue participants API.....	2891
Add queue consumer API.....	2892
Add Work Items to the queue API.....	2893
Run bot with queue API.....	2896
Workload Management list APIs.....	2898
Migration APIs.....	2906
Start migration API.....	2907
List migration results API.....	2910
Bot migration results by id API.....	2912
Migration action mapping results API.....	2914
Enterprise 10 Migration APIs.....	2917
Filtering, pagination, and sorting.....	2930
API response codes.....	2934
Comparing Automation 360 and Enterprise 11 APIs.....	2935
Index.....	2939

Explore

Welcome to Automation Anywhere Automation 360. Review these pages to get an introduction to our latest RPA and Intelligent Automation platform.

Overview

Automation 360 is the RPA industry's first purely web-based Intelligent Automation platform that is cloud-native. Delivered in the Cloud or On-Premises, Automation 360 is designed for ease of use by all types of users across technical skill levels. The platform enables businesses of all sizes to achieve unprecedented scale with enterprise-class security, data privacy, and reduced time to value and costs of ownership. With Automation 360, businesses can also leverage built-in artificial intelligence (AI) capabilities and easily integrate third-party AI solutions, such as computer vision, natural language processing, and predictive modeling—all with the simplicity of drag-and-drop AI into any automation workflow.

The Automation 360 platform also includes attended automation and plug-ins that enable business users to automate tasks from within their business applications such as Microsoft Excel and Salesforce. This capability makes automation of front-office processes easier, faster, and more cost-efficient.

Automation 360 is available globally and in 10 languages, including English, French, German, Japanese, Korean, Italian, Portuguese, Russian, Spanish, Simplified Chinese, and Traditional Chinese.

Available products

The Automation 360 platform includes the following offerings:

- Automation 360 delivered in the cloud, hosted by Automation Anywhere with no client installation or additional infrastructure required
- Automation 360, the full platform delivered On-Premises
- Automation 360 Free Trial, with 30 days to try the cloud-based offering with full tech support included during the trial period
- Community Edition, a free web-based option for users to experience a wide-range of Enterprise A2019 bot creation capabilities

More resources

- [Training on Automation 360: *Get trained and certified on Automation 360 \(A-People login required\)*](#)
- [Industry first bot security program](#)

Related concepts

[Automation 360 Release Notes](#)

Review the new capabilities, changes, fixes (resolved issues), security fixes, deprecated features, and limitations in each release.

[About Automation 360](#)

The Automation Anywhere Digital Workforce platform is the foundation to deliver the automation of complex business work securely and at scale.

[Security architecture](#)

Many of the largest financial organizations in the world rely on the Automation 360 secure digital workforce platform to automate security-sensitive operations.

Related information

[Automation 360 platform](#)

[What is RPA?](#)

[What is a CoE?](#)

[Automation Anywhere University: RPA Training and Certification \(A-People login required\)](#)

About Automation 360

The Automation Anywhere Digital Workforce platform is the foundation to deliver the automation of complex business work securely and at scale.

Overview

Automation 360 is an industry-leading RPA and digital workforce platform that combines an easy-to-use user interface with enterprise-class reliability and the security to enable real-time self-automation. It delivers a browser-based, intuitive experience for business users to quickly automate tasks and tools for developers to build process automation. Automation 360 provides both On-Premises and Cloud deployment options and is the first platform that provides RPA-as-a-Service as an automation solution. It enables users to automate applications across different infrastructures and industries such as banking, telecommunications, and business process outsourcing (BPO) organizations.

Automation 360 provides capabilities such as the following:

- An intuitive interface to create a bot and design business process automation workflows.
- Support for multiple operating systems including Windows, Linux, and MacOS.
- Different views of bot to facilitate collaboration: flow view for business users, list view for developers, and dual view for collaboration.
- Recorder that works across various platforms such as Microsoft Windows, Citrix, Web, and SAP.
- Advanced variables capabilities and support for JavaScript, Python, and VBScript.
- A flexible architecture that enables you to add new command packages.

Automation 360 components

Automation Anywhere Robotic Interface (AARI)

AARI is an easy-to-use interface that enables business users to collaborate with bots. Users can start process automations, provide feedback to bots to resume processes, and escalate requests to additional users for downstream processing. AARI enables the enterprise to unlock new automation opportunities between humans and bots that RPA could not previously address.

[Automation Anywhere Robotic Interface \(AARI\)](#)

RPA Workspace

A web-based workspace that provides the tools and capabilities to create, upload, and deploy bots to automate repetitive tasks and processes. It includes the following:

- Control Room

- Bot Runner
- Bot editor
- Bot Creator
- Credential Vault

RPA Workspace provides the following capabilities:

- Enables users to manage, schedule, and execute bots
- Enables user management through Active Directory role mapping
- Enables users to manage large number of Work Items through workload management

Process Discovery

An intelligent business solution that delivers a real-time, data-driven map of your business to help you uncover transformational process insights across all applications, through each department, and for every single task. Process Discovery follows the human instead of process logs by using advanced computer vision, machine learning, and artificial intelligence to capture every step in every process across every system. It requires zero integration, is universally compatible, and provides the privacy and security of an on-premises solution.

Privacy Enhanced Gateway

Using Privacy Enhanced Gateway (PEG), enterprises can confidently execute on their strategic business initiatives by filtering their sensitive data in a secure and scalable manner. PEG works by redacting sensitive data that has been obtained on customer's machines within their own network before forwarding the data to the Process Discovery cloud for analysis. As all traffic from the agents goes through PEG before leaving the customer's perimeter, PEG removes personally identifiable information (PII) and sensitive data.

[Getting started with Privacy Enhanced Gateway](#)

Discovery Bot

An intelligent business solution for enterprise businesses that provides capabilities for end users to discover opportunities for automation using process discovery. Discovery Bot focuses on process automation by capturing document processes, identifying opportunities from business centric processes, and prioritizing opportunities based on ROI, and create bots automatically. Discovery Bot aligns business workers to uncover automation opportunities that can optimize the return on your RPA investment.

[Process discovery by using Discovery Bot](#)

IQ Bot

An intelligent document processing solution that can read and process various complex documents and emails. IQ Bot combines RPA with multiple AI

techniques to intelligently capture, classify, and extract semi-structured and unstructured data, allowing document-centric business processes to be automated end-to-end.

Install and update Automation 360 IQ Bot

Bot Insight

The analytics platform that provides real-time, interactive, and smart insights about business processes and operational intelligence. Bot Insight uses the large amount of content-level and productivity data that the deployed bots generate and translates the data into insights through automatically generated and customizable dashboards.

Business analytics through Bot Insight

Bot Store

Online marketplace for pre-built bots and Digital Workers that run on the Automation 360 platform. Access Bot Store directly from the Control Room to download or submit bots and packages.

Bot Store

Private Bot Store

A secure internal bot marketplace for a company to post and share details and documentation for all internally developed bots. Employees can easily discover internal bots and commands to reuse in addition to all of bots from the Automation Anywhere Bot Store.

Private Bot Store

The following image shows the components of Automation 360:

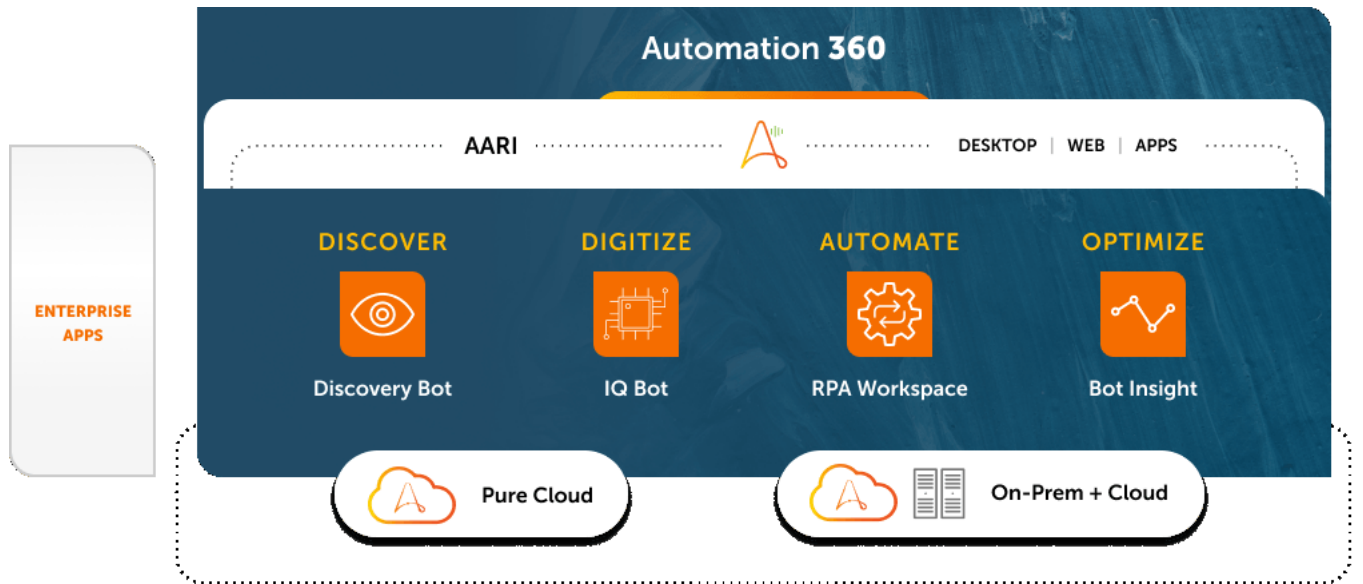

Benefits

Faster time to value

- Instant web-based deployment that enables you to start developing bots quickly
- An intuitive interface that enables users with varying skill levels to easily use the product and speed up the learning process
- Easy collaboration between business, process, and IT

Business agility

- Regular updates to stay up-to-date on any device anywhere
- Business continuity with high availability and disaster recovery
- Scalability

Lowest total cost of ownership (TCO)

- No additional infrastructure investment required
- Single platform across front office, back office, and employee applications
- Reduced maintenance cost

Deployment models

Automation 360 provides the following deployment models:

Cloud

Automation 360 Cloud is hosted by Automation Anywhere, providing an easy consumption model of the Automation 360 platform built on a cloud-native architecture. With the Automation 360 Cloud service, the Automation 360 platform, which includes the Automation 360 Control Room and applications (RPA Workspace, IQ Bot, Bot Insight,

AARI, and Discovery Bot), is hosted by Automation Anywhere and accessed by users through a web browser. The Bot Agent devices where the bots run and execute the automations remain on the customer's infrastructure and securely connect to the Automation 360 Cloud service through HTTPS.

Cloud-enabled

In this deployment model, data is hosted On-Premises. This model is suitable for customers who have to adhere to strict regulatory norms where data sovereignty is mandatory.

On-Premises with packages updates through Cloud

With Automation Anywhere On-Premises with packages updates through Cloud service, all business, personal, and operational data is kept on and deployed from the server on-premises on the customer network.

The following image shows the deployment models for Automation 360:

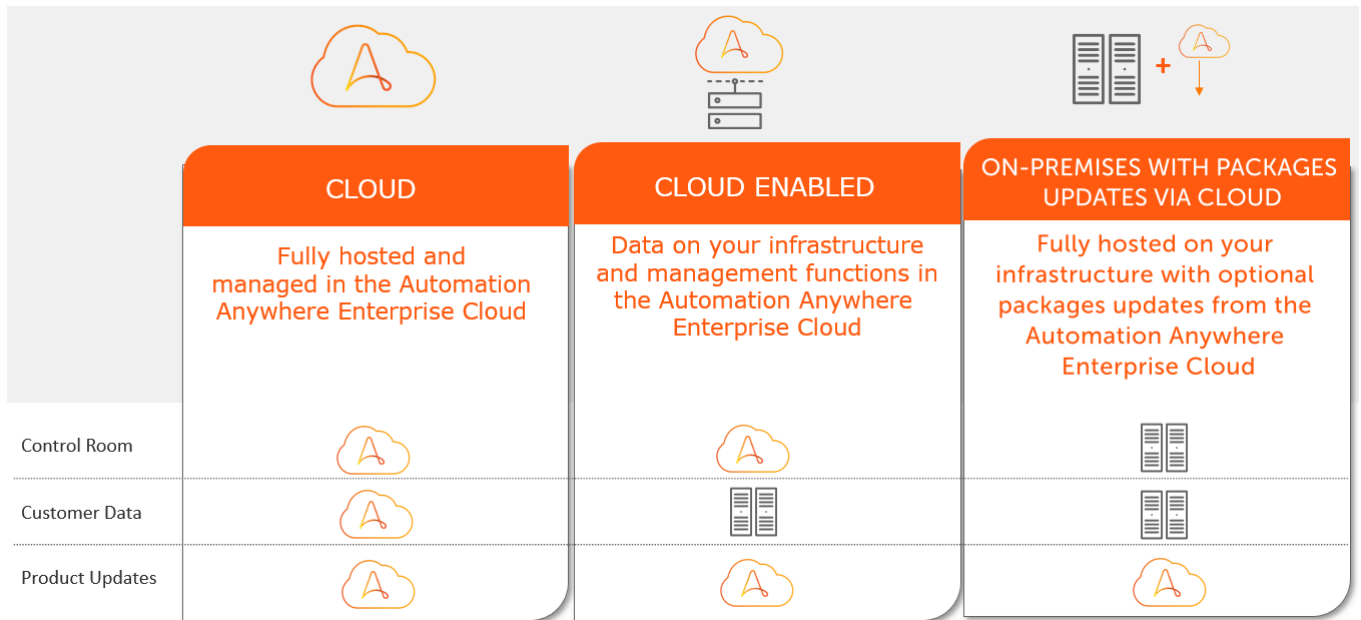

See also [Cloud operational responsibilities](#).

In-product guide

Automation Anywhere uses a digital adoption platform to provide in-product user assistance (guides and walkthroughs) and anonymously analyze product usage such as page views and feature clicks. This data is used to inform user research and improve the overall experience of Automation Anywhere solutions.

Services performed

- In-product guides and user notifications
- In-product educational spotlights
- Informational tips and other contextual user assistance elements within the product to help onboard users
- Anonymized user analytics to understand usage patterns of Automation Anywhere products

Data processed

- Clicks on user interface elements within Automation Anywhere products
- User ID in a form that does not disclose the identity of the user (for example, 159:0a664495-7f3e-126a-817f-513aeedf003e)
- Web-browser type, web-browser version
- Server Control Room URL
- Language selected (English, Japanese, and so on)
- User's first visit and last visit
- User's permissions settings
- List of features to which the user has access
- Product features that are used
- Automation Anywhere license type (Developer, Attended User, and so on)
- Automation Anywhere product version number
- User provided ratings and feedback comments on product features and functionality

Note: The digital adoption platform does not receive the user's IP address or bot information such as which bot was run and what the bot does.

Types of data captured

Automation Anywhere captures the following three types of data when using the digital adoption platform:

- **Event data**

Includes click and focus events providing usage metrics. This enables us to understand the adoption of features and usage patterns to inform future improvements to the experience of our products.

For example:

- Clicking the **Run Bot** option
- Clicking the paths to open a bot in the Bot editor
- Tabbing into a search input

Note: The platform does not collect any user-entered text.

- **Page load data**

Includes data captured as users navigate to various parts of the web application, such as root paths of links and page titles

Note: The platform does not collect any input parameters sent through a link.

- **Metadata**

Includes metadata that is associated with clicks and page loads when a user logs in to Automation Anywhere products.

Metadata that is sent to the digital adoption platform includes the following types of information:

- Pseudonymized user ID
- Pseudonymized account ID
- Selected language
- Build number
- Browser version

Note: The platform **explicitly does not:**

- Record the screen
 - Perform any sort of screen-scraping
 - Capture data entered in any input field
-

Blocking the platform

Blocking the digital adoption platform will block in-product user assistance and important system messages such as the following:

- Productivity boosts through targeted user tutorials
- Targeted important announcements and direct communications
- Opportunity for in-app direct feedback, requests, and support
- In-app integration to Automation Anywhere documentation and support
- Ability to see user behavior so that we can proactively make improvements to the product

Watch the following video to learn more about RPA:

Related information

[Automation 360 platform](#)

[What is RPA?](#)

[What are RPA bots](#)

[RPA for Business Process Outsourcing \(BPO\)](#)

[Automation Anywhere University: RPA Training and Certification \(A-People login required\)](#)

Control Room overview

The Control Room manages, schedules, executes, and configures various capabilities of bots and Bot Runners using a collection of specialized web services.

Components

The Control Room is a centralized management point for all bots. A reverse proxy is responsible for listening for remote connection requests and forwarding those requests to the correct specialized service. The following figure shows the Control Room components and general data center interaction. Control Room components are shown in orange and data center components provided by your organization are shown in blue. Components that are centrally hosted on cloud and managed by Automation Anywhere such as license server are shown in white.

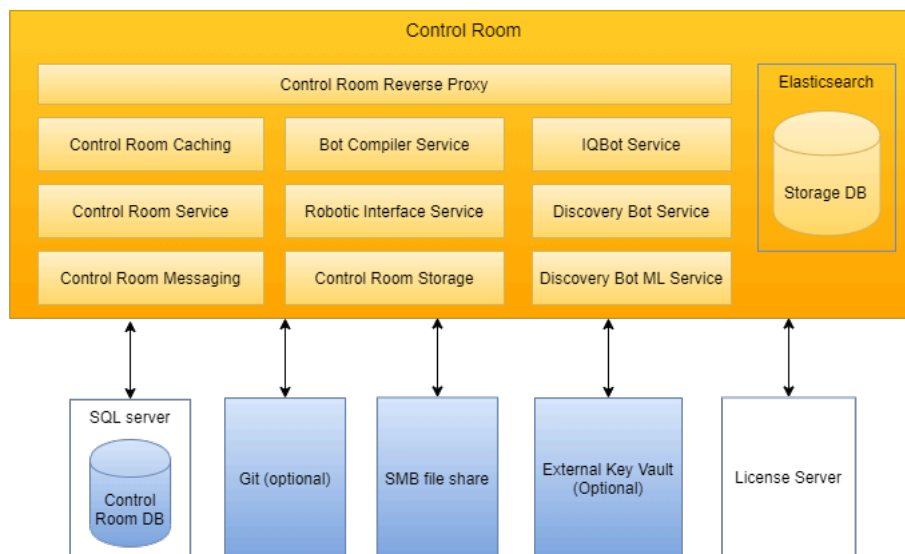

In the data center, Control Room is installed on a server and configured to interact with the other data center components.

The Control Room includes objects that performs the following:

- Control Room reverse proxy is managed through the following functions:
 - Control Room services
 - Control Room messaging
 - Control Room caching
- Elasticsearch
- Licensing

The Control Room required data center components include:

- An SQL server with a Control Room database.
- A Server Message Block (SMB) file share

Centralized Automation Deployment

- Control Room acts as the single point of access and control for bot execution.

- Control Room provides bot upload and download features to facilitate seamless collaboration for end to end business process automation by multiple users.
- All scheduling is managed by the Control Room. Bots are deployed on the Bot Runners either ad hoc or on pre-defined schedules. Once the schedules are created, Control Room automatically and intelligently picks up the subsequent updates to bots, without any need to alter automation schedules.

Centralized Access Control

- Least Privilege and Access controls user access. They are implemented in the Control Room through Role Based Access Control (RBAC).
- All Users and Roles are created and managed from the Control Room.

Collaboration Centralized Workforce Management

- Control Room dashboards provide a single view of the entire automation infrastructure.
- Control Room receives real time heartbeat and telemetry from automations with events, exceptions and alerts.
- Unauthorized users cannot pause, resume or stop any of the ongoing automations on any Bot Runner.
- All historical automation data is logged in and available through Control Room Audit Logs.

Related information

[Control Room overview](#)

Distributed architecture

Automation Anywhere platform is deployed using a distributed architecture.

Centralized management is accomplished via a web-based server, called the Control Room, to manage all development and execution of the digital workforce. The Control Room is connected to Bot Creators and Bot Runners. Bot Creators are development systems used for authoring and tailoring of automations. Bot Runners execute the automations; they are run-time systems installed on machines. Bot Runners can be deployed on desktops, on virtual machines in data centers or cloud.

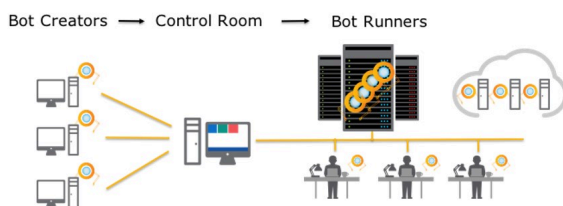

Distributed architecture with HA/DR support

The Automation 360 self-contained platform within the customer environment mitigates the risk of "cross-contamination" from an unlikely event of a security breach from another network.

Automation Anywhere supports distributed architecture to deliver the optimal performance and security. Following are the main distributable components of Control Room which can be clustered to achieve High Availability (HA). In the image below, Automation Anywhere components are shown in orange and

components provided by your organization are shown in blue. Components that are centrally hosted on cloud and managed by Automation Anywhere such as license server are shown in white.

Figure 1: Distributed Mode

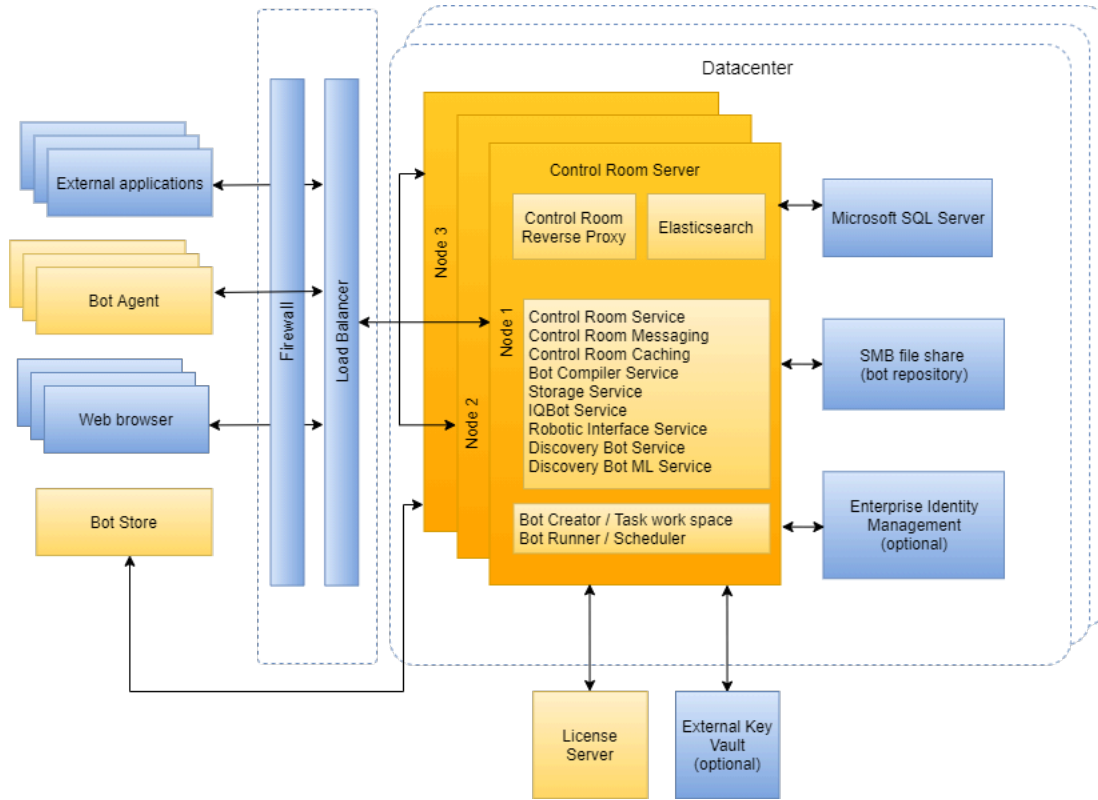

Distributed Cache

Control Room architecture uses distributed cache to update all other nodes as soon as any information is updated in one of the nodes. This ensures fastest data synchronization across all the nodes and delivers seamless user experience. Automation 360 platform uses clustering mechanism to implement distributed cache, to synchronize all data operations. For example, when the Credential Vault is opened from one node, it is automatically opened for all other nodes too.

For information on HA/DR architecture for Automation 360 Cloud, see [Automation 360 Cloud Security and Data Privacy](#).

Related concepts

[HA and DR deployment models](#)

Automation 360 provides several deployment options to meet various levels of enterprise cost/price performance and resiliency requirements. The options include installation on single nodes and on multiple nodes. Multi-node deployments can be configured for highly available (HA) clusters and disaster recovery (DR) sites.

Security architecture

Many of the largest financial organizations in the world rely on the Automation 360 secure digital workforce platform to automate security-sensitive operations.

The platform's security architecture is founded on Least Privilege principles and a strict Separation of Duty model with 41 technical controls implemented across seven NIST 800-53r4 Control Families. Controls are applied across three components: the Control Room, Bot Creators (development systems), and Bot Runners (bot execution run times) through the bot life cycle from creation through decommissioning. This security architecture and the underlying controls are mapped to industry best practices as defined by NIST and can be readily mapped to other frameworks, for example, CoBIT (SOX) and ISO 27002.

Access controls

Automation 360 limits and controls human and bot access to logical resources across components.

- Two independent control planes enforce least privilege. Only developers are enabled to read or write, only authorized Control Room users to execute automations, (Control Room authorizes and executes) subject to fine-grained Role Based Access Controls (RBAC) down to individual automations (bot), Bot Runners and domains.
- Bot- level Separation of Duty is enforced. Each bot is obfuscated and executed by its corresponding authorized Bot Runners.
- Bot execution is controlled via RBAC. Domain privileges are defined across groups of bot and Bot Runners.
- Security at-rest and in-transit: All access credentials are secured at-rest via a central Credential Vault with support for third-party credential stores. All communications are secured in-transit via SSL and TLS.

Configuration management

Configuration management is controlled at both bots and Bot Runner levels.

- The Control Room authorizes, enforces, and logs changes to all Bot Creators and Bot Runners.
- Bots are controlled via a robust version control system, for rollback and full event logging.
- Bot change control on execution is enforced through encryption and authentication.

Identification and authentication

Identification and authentication is controlled through Microsoft Windows authentication services.

- Bot Creators use Active Directory for authentication
- Bot Runners have two levels of authentication, one for autologin authentication of the runner and the other for execution of bots.
- Credentials are secured at-rest and in-motion through the Credential Vault or integration with third-party products.

Risk assessment

Risk assessment is undertaken on Static, Dynamic, and Network-based Vulnerability Assessments. Audit and accountability are established through event capture, logging and auditing on all three components

with granular event capture at the bot level and nonrepudiation. Bot Insight embedded analytics provides near-real-time Incident Response and integration with Security Event and Information Management systems.

Related information

[RPA Security](#)

Security architecture model

Automation Anywhere Cognitive security architecture is founded on Least Privilege principles and a strict Separation of Duty model with 41 technical controls implemented across seven NIST Control families.

The NIST framework was selected as a foundation for best practices as a way to enumerate the controls implemented throughout. Translations from NIST to other control frameworks are widely available, resources are provided at the end of this topic.

The product security architecture is maintained by the Automation Anywhere Product Management team and forms part of a formal policy model as an integral part of the Automation Anywhere Development Roadmap. The following table lists the Control families and the corresponding features and security impacts. Details on each Control family and how the security architecture is implemented in Automation Anywhere products are in the corresponding topics.

Control Family	Control Code	Control Room Feature	Security Impact
Access controls	AC-3, 6, 7, 9, 10, 12	Central policy control	Enforce access restrictions for change control and least privileges on system components: <ul style="list-style-type: none"> • Fine grained access to bots and Bot Runners is controlled via RBAC, • Bot and Bot Runner domains can be assigned to roles via RBAC • RBAC roles are fully audited
	AC-2, 3, 5, 6	Role-based access control (RBAC)	Enable user access, restricts operational privileges, enforces least privilege principles
	AC-17	Bot repository	Bot versioning system with access restrictions
	AC-3, 7, 9, 10, 11	Bot and Bot Runner encryption	Encryption and obfuscation of sensitive information at bot level through credential vault and integration with key management systems

Control Family	Control Code	Control Room Feature	Security Impact
Configuration (change) management	CM-2, 5, 6, 7, 9	Centralized Bot Runner control	Restrict functionality based on roles, domains, implement deny-all and allow-by exception
	CM-10	Centralized licensing	Centralized provisioning, tracking and enforcement of Bot Creator and Bot Runner licensing
	CM-2, 5, 6, 8	Bot operations room	
	CM-8	Inventory control	Maintains centralized inventory control of all bots and runtimes
Bot Creator configuration management	SA-10	Bot Creator management, bot check-in, check-out	Control Room applies software life cycle management to bots from development, test, and production. Bot versioning enables change control of automations.
Audit and accountability	AU-1 through 15	Audit trail	Automated event logs captured on three levels: Control Room, Bot Runners, and Bot Creators. Non-repudiation is assured through read-only logs, all user identities are bound to actions.
Identification and authentication	IA-1 through 5	Active Directory integration, Bot Runner ID and Attestation	Implements Windows platform security including cryptographic bidirectional authentication, Bot Runner identification and attestation, and password management policies. Credential vault with integration with key management systems, protects the integrity of credentials.
Incident response	IR-4, 6	Incident response	Bot Insight embedded analytics capabilities can monitor events and generate alerts to SIEM systems for response.

Control Family	Control Code	Control Room Feature	Security Impact
Controlled maintenance	MA-2	Automated maintenance	Control Room versioning system provides an automated mechanism to roll out updates to bots, historical information is maintained.

(1) Resources: ISACA provides guides that map NIST SP800-53 to other security frameworks such as CoBIT (SOX), SANS Top20.

Cloud operational responsibilities

Learn about secure deployment models, data element locations, and operational responsibilities.

Securing the Cloud

Automation Anywhere Cloud is deployed to only allow access to Automation Anywhere Cloud Operations personnel and Security Team resources. Network and cloud control plane access is restricted using VPN with multi-factor authentication for AAI operational and security personnel. All AAI users must first authenticate using MFA tokens to retrieve short-term credentials to access cloud resources. User credentials are continuously monitored for compliance. All other operational users, cloud resources, and applications are restricted from access to the Control Room. Regular AAI user access certification is conducted to ensure only necessary access is provided to cloud operations personnel.

The cloud service is multi-tenanted and each customer control room environment uses a unique tenant identifier to ensure data separation between the Control Rooms. Automation Anywhere members cannot access a customer environment unless specific permission is provided by the customer, typically under support troubleshooting procedures and controls.

Cloud

With the Automation AnywhereCloud offering, all business, personal, and operational data is stored on Automation Anywhere administered cloud. Automation Anywhere is the cloud data controller and is responsible for customer data privacy as published in accordance with Automation Anywhere cloud security and compliance with data privacy.

[Privacy Policy for Automation Anywhere](#)

Cloud-enabled

With the Automation Anywhere Cloud-enabled solution, business, personal, and operational data is stored and managed on the customer-controlled infrastructure, while specific operational data related to RPA is shared between the Automation Anywhere Cloud and the customer infrastructure. All data privacy and compliance rests with the customer.

On-Premises with updates through Cloud

With Automation Anywhere On-Premises with updates through Cloud service, all business, personal, and operational data is kept on and deployed from the server on-premises on the

customer network. All data privacy and compliance rests with the customer.

The following table lists the securing data and operations responsibilities:

Data requirement	Cloud	Cloud-enabled	On-Premises with updates through Cloud
Infrastructure and data security	Automation Anywhere Cloud	Shared customer and Automation Anywhere Cloud	Customer
Continuity and disaster recovery	Automation Anywhere Cloud	Shared customer and Automation Anywhere Cloud	Customer
High availability	Automation Anywhere Cloud	Shared customer and Automation Anywhere Cloud	Customer
Data localization	Automation Anywhere Cloud	Customer	Customer
Data privacy	Automation Anywhere Cloud	Customer	Customer
Software upgrades	Automation Anywhere Cloud	Shared customer and Automation Anywhere Cloud	Customer

The following table lists data types and storage locations:

Data type	Cloud	Cloud-enabled	On-Premises with updates through Cloud
Customer business data <ul style="list-style-type: none"> Customer personal data Business data used in automation 	Cloud. For more information on Cloud storage information, see Automation 360 Cloud FAQ .	Customer network	Customer network
Operational data <ul style="list-style-type: none"> Operations users, roles, passwords Device information Device credentials Bot schedule Bot definition Audit and application logs Workload management definitions and schedules 	Cloud	Customer network	Management shared: Cloud Action package updates Customer All other data management

Data type	Cloud	Cloud-enabled	On-Premises with updates through Cloud
Personal data <ul style="list-style-type: none"> • Username and password • Security key • User device information and credentials • Bot Runner device access • Bot device IP/FQDN • Bot application credentials • User application logs 	Cloud	Customer network	Customer network

Securing the RPA environment with external controls

The Automation Anywhere architecture consists of a standard desktop and server class infrastructure for the registered devices and the Control Room.

RPA platform

This topic details the best practices for securing the RPA platform with external security controls. Network-based firewalls, Intrusion Detection Systems, anti-malware, and external log servers are all standard security controls that are relevant to RPA deployment and the other infrastructure in your environment. The following figure shows logically where these components are deployed in the RPA deployment:

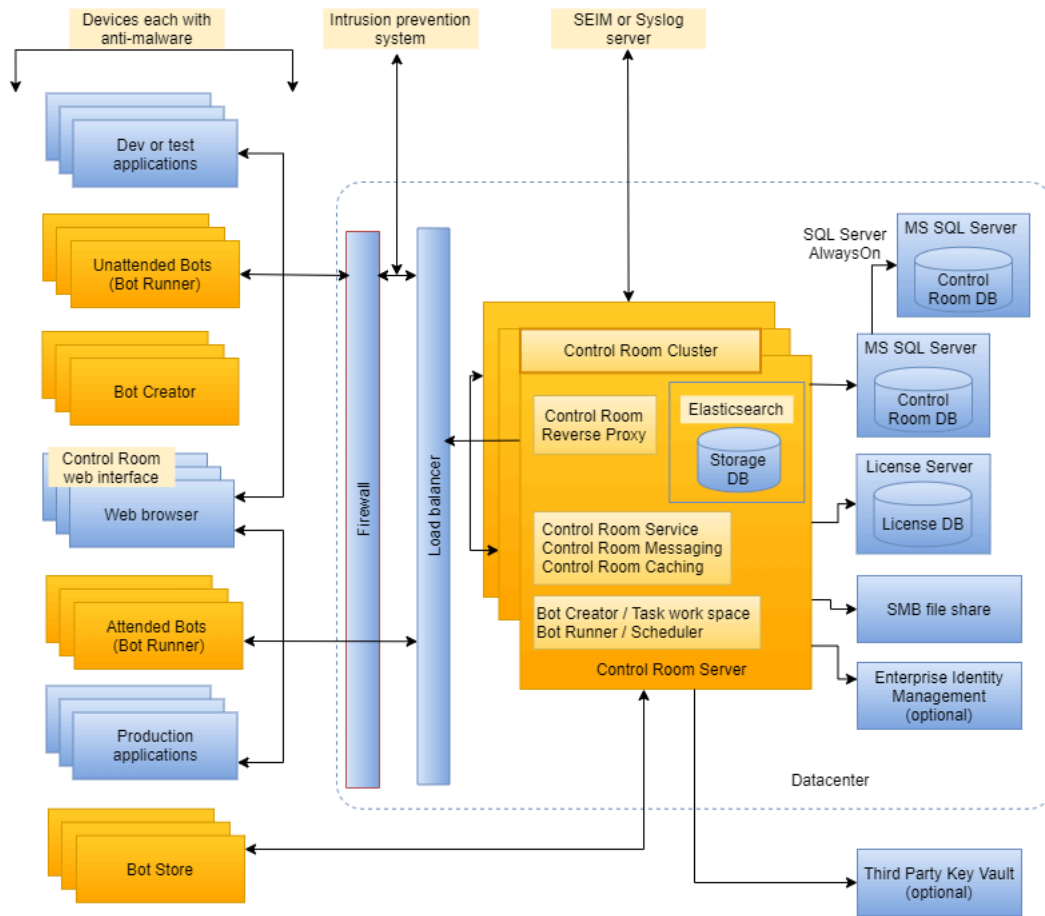

In the image, Control Room components are shown in orange and data center components provided by your organization are shown in blue.

Each external security control is discussed in detail in the following sections, in terms of placement and configuration. Supporting network services such as Active Directory, SMB File Share, Microsoft SQL Server, and production applications, and are accessed through network firewalls or directly, depending on their placement relative to the RPA components.

Network-based access control to protect RPA with firewalls

Network-based firewalls and local server-based firewall are used to protect the Control Room or all nodes in a Control Room cluster. By default, required protocols on the Control Room are permitted from the corporate network. Additionally, all clustering protocols are permitted only between the nodes in the Control Room cluster. Network-based firewalls are used to isolate Development, Test, and Production RPA environments from the corporate network and from each other.

For unattended automation environments, the Bot Runners are placed in a specific isolated network and protected by a network-based firewall. Attended automations run from corporate workstations with the Bot Runner Bot Agent installed and are protected via the corporate perimeter firewalls or internal firewalls protecting the corporate desktop infrastructure, like any desktop.

Anti-malware to protect RPA from viruses and malware

The Automation Anywhere Bot Agent runs on desktop class infrastructure and is considered a corporate desktop. Anti-malware or anti-virus software is used to protect the registered device environment from malicious software in the form of viruses and malware.

Intrusion detection systems to protect RPA from direct attacks

Intrusion Detection and Prevention Systems (IPS) protect the corporate network by detecting network-based attack through network traffic analysis. Like any other critical section of the data center, an IPS protects the RPA platform at the egress point, behind the network-based firewall.

Independent categories for Bot Creators and Bot Runners

For logical separation of duties, Control Room divides automation users into two broad categories: Bot Creators (development) users and Bot Runners (run-time) users.

Bot Creators exist on a separate Microsoft Windows system with its own credentialing system to create, update, and unit test the bots on the Bot Creator. Bot Creators only upload and download bots to and from the Control Room. Users on the Control Room users have privileges to execute bots on Bot Runners but have no access to the Bot Creators. This separation of duty constitutes a dual authorization by requiring both the developer and the business user to create and execute the bot in conformance with NIST AC-3 best practices.

RBAC in Control Room

Control Room implements Least Privileges and Separation of Duties through a configurable Role-Based Access Control (RBAC) capability that conforms to requirements in NIST AC 2, 3, 5, and 6.

All Control Room users are assigned one or more roles. Access are available based on the usage conditions assigned to each role when users are a member. Authorized users can temporarily or permanently suspend other users when needed. RBAC enforces session handling to prevent unauthorized access. If an unauthorized user attempts to view session details or gain access, the Control Room cluster will prevent this progress and immediately terminates the unauthorized session. The unauthorized user will be prompted to log in with valid credentials. Inactive accounts can be disabled.

The administrator controls are responsible for all security functions, consistent with best practices in NIST SC-3: Security Function Isolation.

The Control Room includes segmented administrator roles by default. Many permissions are supported for creating new roles.

Controls are implemented at the Control Room, Bot Creators, and Bot Runners layers, for NIST Access Controls (AC) and Change Management (CM) guidelines. The following technical controls are implemented to ensure access is governed through NIST Least Privileges.

RBAC on bots

Access is deny all and allow by exception based on roles, except for admin roles. Addressing NIST AC-17 (access control), NIST configuration managements for NIST CM-2 (base line configurations), access restrictions for NIST CM-5, NIST CM-6, and NIST CM-7 (least functionality), and monitoring NIST CM-9 for bot activity across the development, test, and production environment.

RBAC on Bot Runners

RBAC on Bot Runners facilitates complete isolation of one department Bot Runner seamlessly from the remaining departments' Bot Runners.

Bots are executed from the Control Room cluster. Local bot executions are protected through multiple layered security, and are designed to prevent fraud as a result from escalation of privileges on Microsoft Windows. The Bot Runner are executed by Windows, addressing access control enforcement in accordance with NIST AC-3 Access Enforcement and AC-6 Least Privilege for Code Execution.

If user roles does not have access to sets of Bot Runners, as a result, these users are unable to view the Bot Runners' executions or remote scheduling automation. See ([Role-based processing domains](#)).

RBAC for Credential Vault credentials management

Credentials created in the Control Room are used across Bot Creators and Bot Runners.

These credentials are securely stored in the centralized Credential Vault to facilitate access control, and to divide in logical groups called lockers. These lockers enable complete separation between the credentials of one department from another.

Role-based permissions

Permissions for credential management-related roles include the following:

Manage my credentials and lockers

By default, all users can manage their own credentials and interact with the lockers to which they have permissions.

Manage my lockers

Allows the user to create and manage their own lockers.

Administer ALL lockers

User can do all the actions in the Admin row of the Locker permissions table below.

Create standard attributes for a credential

User can set an attribute value that remains the same for other users of that credential attribute.

Locker permissions

Locker permissions are set when a locker is created or edited. A user can have the following permissions in a locker:

	View locker	Edit locker	Delete locker	Add participant owner	Remove participant owner	View credential	Assign credential	Remove credential	User-provided value	Standard value
Consume						#			#	
Participate						#	#			
Manage	#	#	#			#	#	#		#
Own	#	#	#	#	#	#	#	#		#
Admin	#	#	#	#	#	#	#	#		#

Related tasks[Create credential](#)

Create a credential and add the required attributes.

[Create locker](#)

Create a locker to group similar credentials to share with other users.

Related reference[Credentials and lockers in the Credential Vault](#)

The Credential Vault securely stores sensitive information such as passwords, account numbers, and social security numbers in credentials and lockers for use in automation tasks. It facilitates role-based access for users of a Control Room and ensures that sensitive values are not stored in bots or on devices.

Role-based processing domains

The Control Room RBAC applies the least privilege principles to domains by implementing Processing Domains, specifying role-based privileges and permissions at the bots and Bot Runners level.

RBAC is applied at a folder level to completely and seamlessly isolate one department bot from the remaining department bots. If the user role does not have access to a set of bots, those bots do not exist, thereby enabling the separation of duties across different domains. For example, finance and accounting roles can access only the bots that automate their respective functions, and specific Bot Runners can execute these bots. This is consistent to best practices as defined by NIST AC-4 Processing Domains.

Authorized users assign various roles based on the business need.

RBAC on Audit Log

Audit is automated for all privileged and nonprivileged roles to conform to best practices, as defined in NIST AC-6.

Access is view-only based on a deny all and allow by exception based on roles and domains as defined in the Audit section 7 addressing Audit and Accountability (NIST AU 1 through 15) and as required by NIST AC-2 Automated System Account Management. If a role does not have permission to view Audit Logs, then the Audit Trail tab is not visible to all members of that role. Audit automatically captures all events related to creation, modification, enablement, disablement, and removal of users, bots, Bot Creators, and Bot Runners.

RBAC on viewing bot activity

The Control Room **Activity** menu provides options shows the status of the Automation Anywhere Enterprise automations. These options are: **In Progress**, **Scheduled**, and **Historical**.

Access to bot Activity status is deny all and allow by exception based on roles and domains as defined in RBAC. Two levels of checks are applied to access the bot Activity data. The user is required to be a member of a role that has access to view the Control Room. Users with Control Room access that can view only the bots belonging to their departments, as applied through RBAC on bots.

RBAC on User Management

Access is deny all and allow by exception based on roles, domains as defined in RBAC. Only those users with access to User Management can manage other users in system.

This permission is further divided into the following sub permissions:

Create Users

Only those users that create new users from the Control Room.

Edit Users

Only those users that edit existing users from the Control Room.

Delete Users

Only those users that delete existing users from the Control Room.

Authorized users assign various combinations of these access permissions to different sets of users and roles based on the business requirements.

RBAC on roles and permissions management

Access is deny all and allow by exception based on roles, domains as defined in RBAC.

Users with access to roles and permissions management can create, edit, and delete roles in the system. This permission is typically assigned to administrators and power users from across enterprises.

RBAC on bot schedules

Access is deny all and allow by exception based on roles and domains as defined in RBAC.

This permission is further divided into the following sub permissions:

Schedule my bots to run

Only those users that create new schedules.

Edit my scheduled activity

Only those users that edit their schedules.

Delete my scheduled activity

Only those users that delete their schedules.

View and manage ALL scheduled activity

Only those users that manage (edit or delete) all the existing schedules created by any user.

Administrators assign various permutation and combinations of these accesses to different sets of users and roles based on the business requirements.

RBAC on license management

Access to license management is deny all and allow by exception based on roles and domains as defined in RBAC.

Only those users with access to license management permission are able to update the license from the Control Room. A common license exists for all the users across Automation 360 for a specific Control Room. The updated license is effective for all the Bot Creators and Bot Runners registered with the corresponding Control Room.

Bot execution access by dynamic access token

The Control Room implements and enforces a Trusted Path for registration and authentication of Bot Creators and Bot Runners in accordance with NIST SC-11 to protect against any attempt to execute unauthorized bots.

The Control Room issues new client access tokens or identifiers through hashing, signed by the Control Room and sent to Bot Creators and Bot Runners over HTTPS. Every subsequent communication between Control Room and Bot Creator or Bot Runner is serviced by the Control Room after validation of the signature of the latest access token sent by the Bot Creator or Bot Runner. Each access token is unique to every Bot Creator or Bot Runner. This ensures that even if an unauthorized user could bypass enterprise security and access the system, the Control Room security restricts any damage.

Secure credential store through Credential Vault

The Automation Anywhere platform provides a centralized Credential Vault to securely store all credentials and provision them to bots on an on-demand basis.

Use the Credential Vault to store other information deemed confidential or sensitive. The credential store implements NIST controls IA-2 to uniquely identify and authenticate organizational users (or processes acting on behalf of organizational users).

Sensitive information does not have to be stored in bots or on Bot Runner systems, the Credential Vault facilitates a logical separation of credentials from the bots.

Credential Vault variables (credentials) are created in the Control Room. They are available to the Bot Creators and Bot Runners who are assigned roles that provide them access to the lockers that contain the credentials.

The Credential Vault adds flexibility and dynamic character to bots because only the credential references are present in the bots, and not the credentials. When bots are moved from one environment to another environment, absolutely no change is required in the bots. Bots can seamlessly pick up the credentials values applicable for the new environment from the Credential Vault of that environment. Additionally, the Control Room automatically stores configuration-related sensitive data into the Credential Vault by default.

Credential Vault encryption

The Automation 360 platform offers the embedded Credential Vault and provides an extensive set of safeguards to protect data at rest and in transit, but also while it is in use on individual systems.

Encryption keys and vault

During the Automation 360 installation process, the system generates an RSA 2048 bit public/private key pair and an AES 256 bit key. The private key of the RSA 2048 pair is referred to as the Master Key, while the AES 256 key is referred to as the Data Key. The Master Key is presented to the installing administrator for safekeeping in a physically secure location off system. The public key is used to encrypt the Data Key. Both the public key and the encrypted Data Key are then stored in the database. When in use, all keys and encrypted data are placed in encrypted secure memory using the Microsoft Data Protection API (DPAPI).

During Automation Anywhere Control Room startup or reboot, the administrator is prompted to supply the Master Key. The encrypted Data Key is retrieved from the database and decrypted using the Master Key. The Data Key is now ready for use. As the system stores and retrieves data from the Credential Vault, the Data Key is used to encrypt and decrypt that data.

vault is used to store all system managed credentials and critical system configuration data. It can also be used to store any other sensitive data used in an organization's automations. As a result, bot builders can avoid the insecure practice of hard-coding credentials and other sensitive data/ arguments directly within their automations.

Multi-layer authentication and fine-grained access control are essential for a tightly controlled environment. So is end-to-end data protection, which is also necessary to maintain the confidentiality and integrity of business-critical processes, sensitive data, and related credentials.

Master key

This RSA-2048 bit key is managed by an administrator outside of the system. This key unlocks the Credential Vault. The administrator types the Master key each time the Control Room is started. When the vault is open, the master key is immediately erased from memory and it is not stored anywhere in the Automation Anywhere product.

Data encryption key

This AES-256 bit key is stored in the Control Room database and is used to encrypt and decrypt the credentials at the time of storage or provisioning. This key is encrypted using the Master key. The Data encryption key does not leave the Credential

Vault at any time. Credential encryption and decryption are done at the Credential Vault.

Protection of data at rest

In addition to encrypting local credentials and selecting runtime data used by bots, the Credential Vault provides secure storage for sensitive configuration parameters and details pertaining to the integral version control and email services.

Credential storage

All sensitive data is stored in the Credential Vault using AES-256 encryption.

These credentials are encrypted by the Credential Vault service to conform to NIST SC-28 and to prevent unauthorized access or disclosure of credentials. Only encrypted credentials travel from the Control Room to the Database server and are stored in the database in an encrypted form. The data encryption key encrypts all credentials using an AES 256-bit key generated by a FIPS 140-2 Level 1 validated module to meet the NIST IA-7, SC-12, and 13 requirements for implementation of mechanisms for authentication to a cryptographic module that meets the requirements of applicable federal laws.

The data for [Active Directory](#) user credentials for autologin to Bot Runners is also encrypted and securely stored in the Credential Vault with the bot credentials.

Credential provisioning to bots

Credentials are provisioned only during the execution of automation.

Bot Runners or bots do not store credentials locally. Credentials are provisioned only during the execution of the automation. When the credentials are requested by Bot Runners, encoded (64 bit) credentials travel from the Control Room to Bot Runner over HTTPS protocol. When the bots finish execution, credentials are erased from the memory.

Cryptographic providers

Use only the listed supported cryptographic providers.

Control Room

Cryptographic Provider	Supported Version
AES-256	All Bouncy Castle FIPS versions mentioned in the Automation Anywhere Open Source Software (OSS) Notice
RSA-2048	
HMAC-SHA256	
PBKDF2-HMAC-SHA512	

Secure recording

You can enable or disable image captures of business applications by setting up secure recording in the Control Room.

Overview

When secure recording is enabled, Bot Creators or Bot Runners cannot capture the application images, values, or texts. As a result, no sensitive data is (intentionally or unintentionally) stored in the bots in the form of images. The remaining automation data, for example, UI object details are captured, and they continue to be captured so that the automation can work seamlessly.

As an administrator, you can apply this setting from the Control Room for all Bot Creators and Bot Runners (for all users or for specific user roles).

Set up secure recording

1. Log in to the Control Room as an administrator.
2. Navigate to **Administration > Settings > Bots**.
3. In the **Secure recording** section, click **Edit** to configure the settings.

4. Select **Enable**.

The default value is **Disable**.

5. In the **Recorder preview image** tab, select one of the following options:

- **Enabled:** A preview of the image is shown in the Bot editor when the object is captured but discarded after you refresh the Bot editor. The image is stored in the Control Room and deleted after 60 minutes.
- **Disabled:** Image is not captured and not stored in the Control Room.

Secure recording

When Secure Recording is on, images and control values will NOT be captured during business process recording when you are automating secure applications (e.g. Bank accounts).

Enable
 Disable

Recorder preview image

Enabled
 Preview image is available in the Bot Editor when objects are captured but discarded after save

Disabled
 Preview image is not available and will not be stored in Control Room

6. Choose the settings based on your requirements:

Option	Action
All users	Select this option to enable secure recording for all users who have access to the product.

Option	Action
Users with selected roles	To enable secure recording for users with specific roles: <ol style="list-style-type: none"> a. From the Available roles column, search and select roles for which you want to enable secure recording. b. Move these roles to the Selected column.

7. Save your changes.

Authentication with Control Room

When a Bot Creator or Bot Runner tries to connect to Control Room, the credentials are encrypted using AES (256 bits key length) and RSA (2048 bits key length) and then transmitted on top of the existing layer of Transport Layer Security (TLS).

This extra layer of message level encryption provides protection against network stack issues (such as Heartbleed where OpenSSL was leaking sensitive data from memory) and also adds protection to the last hop of the connection when TLS is terminated at the load balancer. These credentials are decrypted by Control Room and authenticated against the hashed (PBKDF2 and HMAC SHA512 algorithm) user passwords or against *Active Directory* via Lightweight Directory Access Protocol (LDAP).

Supported authentication methods for Automation 360 On-Premises

Review the authentication methods supported by Automation 360 On-Premises.

Supported authentication methods

- *Active Directory* using LDAP
- Active Directory using Kerberos
- SAML
- Local authentication using a database

The benefits of integrating with Active Directory include the following:

Easier adoption	Integrates with an existing authentication solution, compliant with the standards.
Maintenance	All passwords and password policies are centrally administered.
Better user experience	Fewer passwords to remember.

Kerberos provides additional benefits over NTLM pass-through authentication.

- Open standard versus closed proprietary standard
- Mutual authentication of client and server
- Integration with smart cards for 2FA

Local authentication manages user passwords through the Credential Vault. Passwords are hashed using the HMACSHA512 algorithm, which is keyed by the output of the Password-Based Key Derivation Function (PBKDF2). User passwords are encrypted in transit through TLS 1.2.

All authentication and session management is handled through the well-tested Spring Security framework. Kerberos integration is provided through the well-tested Waffle framework. SAML integration is provided through the well-tested OneLogin framework.

Active Directory integration for authentication

Automation Anywhere offers seamless integration with Microsoft Windows Active Directory for access to the Control Room, Bot Creators, and Bot Runners. When Control Room is integrated with the Active Directory, all the Active Directory users with basic details are directly available in the Control Room without any extra configuration. For Active Directory integration, user passwords stay in only Active Directory and are not saved in the platform.

In addition to Active Directory authentication, the Control Room has its own controls to prevent unauthorized access to an *Dynamic access token authentication of Bot Runners* automation data.

Dynamic access token authentication of Bot Runners

Bot Runner users can also configure their *Active Directory* credentials for Bot Runners machine autologin. These credentials are saved in the centralized Credential Vault.

Multi-domain Active Directory support

Automation Anywhere platform architecture supports multi-forest multi-domain Active Directory integration. Multi-forest multi-domain integration requires trust relationships between the forests and the domains. Refer to *Configure Control Room for Active Directory: auto mode* for details. Automation 360 On-Premises can be configured with Active Directory global catalog server in a way that the Control Room, Bot Creators and Bot Runners can all be in the same or different Active Directory forests and domains. This gives the added flexibility and control for large-scale complex deployment where users are spread across geographies.

Multi-domain support is provided out of the box and no additional configuration is required. The Automation 360 On-Premises user provisioning from different Active Directory domains is also seamless. It enables the Automation 360 On-Premises admin to centrally orchestrate the digital workforce running across the globe.

Support for secure protocols

The Automation Anywhere platform supports secure protocols, for example, TLS 1.2 and HTTPS data transfer.

- Deployment of bots from the Control Room to remote Bot Runners is done over TCP and TLS 1.2.
- Upload and download of bots from the Bot Creator to the Control Room is done over HTTPS.
- Transfer of any information from the Control Room to the database and vice versa is done over TDS and TLS 1.2.
- Transfer of encoded credentials from the Control Room to Bot Runners is done over HTTPS.
- WebSocket communication with the real-time data service in the Control Room is done over HTTPS.

Network security overview

All communication between the Control Room, Bot Creators and Bot Runners is done using outbound WCF TLS 1.2 communications and inbound HTTPS TLS 1.2.

Bot deployment to remote bot runners, provisioning of credentials, automation scheduling, and event capture are done exclusively through the Control Room. Use only HTTPS in the production environment.

- The REST APIs use Distributed Cache Service to get shared cached data required for specific functionality.
- The Scheduler Service makes REST API calls to run a task on a specific client machine at a specific time.
- Real-time Data Service makes REST API calls to authenticate incoming connection requests. It receives task execution progress updates by Bot Runners and sends that information to all connected browser clients using WebSocket Secure (WSS) protocol.
- The Control Room makes REST calls for user authentication and repository operations, for example, upload a task, download a task, or compare two tasks.
- The Control Room makes REST calls to the validate user session at regular intervals. The Control Room deploys and runs a task on a specific device using Bot Agent. It uses a TCP/IP channel.
- The Scheduler Service makes REST calls for autologin credentials. It also communicates to the Control Room to get a license and user session-related information.
- The Control Room makes REST calls to get autologin credentials for a logged-in device. It also communicates to the Control Room to get the license and user session-related information.

Change management

Access restrictions for configuration management.

Baseline inventory controls for Bot Creators, Bot Runners and bots

The Control Room provides a single-pane-of-glass on all automation operations and infrastructure, providing a way to baseline the configuration of the environment. Inventory controls are maintained through the application of RBAC and the use of the Bot Repository, Operations Room, and License Management to establish a single point of control for Base Line Configurations (NIST CM 2) access restrictions for configuration management (NIST CM 5 and 6). Configure automated baseline reporting using the auditing and reporting systems in the Control Room.

Change control and documentation RBAC

The Control Room RBAC provides a point of access control and management for all changes to the Control Room, Credential Vault, Bot Creators, bots, and Bot Runners with an automated mechanism to prohibit changes and report on any attempts to make unauthorized changes. The logging and auditing system on the Control Room provides the reporting mechanism for change management to conform to best practices as described in NIST CM-3 through 5.

Software usage and license management

The Control Room provides an automated mechanism for tracking and controlling the use of licensed software across Bot Creators and Bot Runners, addressing NIST Change Management CM 10.

Dual authorization change management

Separation of duties is implemented at multiple levels. Dual authorization is achieved through separation of control planes for the Bot Creators and Bot Runners. Only bots created by an authorized Bot Creator can be executed by a separately authorized Bot Runner and only by a user who has been given the privileges to do so by an administrator.

Identity and authentication

All automation actions, for example, create, view, update, deploy, and delete, across Automation 360 are done only after Control Room authentication is successfully completed.

After authentication is successful, the platform applies a second mandatory level of access control enforcement in the form of fine-grained Role-Based Access Control (RBAC).

The Control Room has its own controls to prevent unauthorized access to any automation data.

Password hashing

Password hashing does a one-way, permanent transformation of the passwords of the Control Room users, inline with standard password management practices.

Control Room passwords are concatenated with a salt and then hashed using the PBKDF2WithHmacSHA512 algorithm before being stored in the database.

- The salt is 256 bits in size and is randomly generated by a cryptographically secure PRNG.
- The HMAC SHA512 algorithm is used for hashing and provides additional security over traditional approaches.
 - A keyed hash provides protection against hash length extension attacks.
 - SHA 512 bit key is larger than the commonly used SHA 256 bit key.
- The key used for the HMAC is from the secure Password-Based Key Derivation Function (PBKDF2).
- Hashing is done for 100,000 rounds (based on NIST recommendations).

Every time a Bot Creator or Bot Runner authenticates against Control Room, its credentials are authenticated against the hashed credentials.

Authentication failure messages

If an authentication attempt fails, the Automation 360 platform does not specifically state if the username or password is incorrect. It only states that the supplied credentials are incorrect.

This is one critical information security requirement for Automation Anywhere customers and defends the system against a brute force attack.

This authentication involves the following:

- Bot Creator, Bot Runner connection to Control Room
- User log in to the Control Room from the browser
- Connection from the Control Room to the SQL Server

All failed authentication attempts are logged. See [Audit log](#). Audit Log access is provided as per RBAC and audit logs are made available on a read-only basis for all users.

Authentication for Bot Runners

Two layers of authentication are present for deploying the bots on remote Bot Runners.

The Bot Runner is logged on/connected/unlocked using the configured credentials. These credentials are fetched from the centralized Credential Vault over HTTPS. This first level of authentication is done against the *Active Directory* domain automatically, on behalf of the user and is called Bot Runner autologin.

After being authenticated, Bot Runners can be authorized to execute bots independently and asynchronously.

The following table shows what happens to the user session on the Bot Runner after bot deployment.

User session status before bot deployment	During deployment	User session after bot execution finishes
No session exists	Create a new session and deploy the bot	Log off
Unlocked	Deploy the bot	Session remains unlocked
Locked	Unlock the session and deploy the bot	Session is relocked
Disconnected	Unlock the session and deploy the bot	Log off

Dynamic access token authentication of Bot Runners

The Control Room implements and enforces a Trusted Path for registration and authentication of Bot Creators and Bot Runners in accordance with NIST SC-11.

The Automation 360 platform protects the automation data against any attempt to subvert the path. The Control Room issues new client access tokens, or identifiers, after a predefined time period. These tokens are protected to conform to NIST IA-5 by being signed by the Control Room and sent to Bot Creators and Bot Runners over HTTPS. Every subsequent communication between the Control Room and Bot Creator/Bot Runner is serviced by the Control Room only after validation of the signature of the latest access token sent by the Bot Creator/Runner.

The access token is unique to every Bot Creator/Bot Runner. This protects the system from an unauthorized attempt to bypass security and execute an unauthorized bot, and is consistent with the best practices to conform to NIST IA-9 Service Identification and Authorization. These controls implement IA-3 for cryptographically based bidirectional authentication and attestation of Bot Runners and Bot Creators before establishing connections. This also addresses requirements around unique, automated, identifier management IA-4 for multiple forms of authorization and identification. Identifiers are dynamically managed for audit and control purposes. Identifiers are used as authenticators and managed for verification on initial deployment, revoke, and prevent reuse. There are no static, unencrypted, identifiers in use by Bot Creators or Bot Runners and cached tokens are cleared periodically.

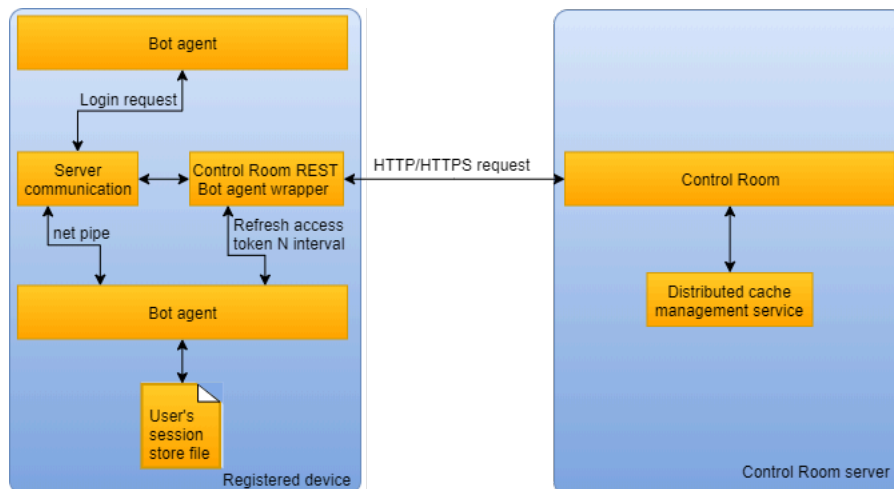

Defenses against common vulnerabilities

The Automation 360 platform provides some defenses against common attacks on applications.

The list below contains several examples of these attacks and the security controls in place to prevent them.

SQL Injection (SQLi)

SQL injection is a high-risk vulnerability that can seriously impact the confidentiality, integrity, and availability of a database. It enables an attacker to execute any SQL of his or her choosing inside the DB, thus allowing them to read sensitive data, modify/insert data, and execute various operations.

The Control Room prevents SQL injection using query provided by the Hibernate framework.

Cross Site Scripting (XSS)

Cross-site scripting is a high-risk vulnerability that can seriously impact the confidentiality, integrity, and availability of any user web session. It enables an attacker to execute any JavaScript inside the victim's browser, allowing them to spy on the user's input/output or take unauthorized actions on behalf of the user. They could also redirect the user offsite to a malicious malware download or a credential phishing page.

The Control Room prevents cross-site scripting using automatic output encoding provided by the ReactJS framework.

OWASP Top 10

Automation Anywhere provides the following controls to protect against the OWASP Top 10:

Risk	Control
A1: Injection	All input is escaped before commands or queries are executed.
A2: Broken authentication and session management	See the identification and authentication section.
A3: Cross-site scripting	All output is encoded before being returned.
A4: Insecure direct object references	Centralized authorization via Spring Security.
A5: Security misconfiguration	No default passwords, stack traces hidden, secure server configuration
A6: Sensitive data exposure	See the Security at rest and Security in motion sections
A7: Missing function level access control	Centralized authorization via Spring Security
A8: Cross-site request forgery	Using authorization HTTP header
A9: Using components with known vulnerabilities	Black Duck software composition analysis tool
A10: Unvalidated redirects and forwards	N/A - No redirect functionality present

Compliance and vulnerability scanning

Review details about Automation Anywhere compliance and vulnerability scanning.

Secure software development life cycle (S-SDLC)

Automation Anywhere has implemented a development security plan and protocol that defines a specific depth of testing and evaluation to be done by the Engineering team on each release, conforming with best practices as defined by NIST SA-11 Developer Security Testing and Evaluation and NIST SA-15, Development Process, Standards, and Tools. This plan has been documented and shared with the Automation Anywhere Engineering teams.

Veracode vulnerability scanning for static and dynamic code analysis

In each weekly build, during the development process and before every release, all Automation Anywhere software is scanned for flaws using the Veracode tool. Automation Anywhere Enterprise meets the requirements for the strictest security policy available in the tool, Veracode Level 5, which is defined as no Very High, High, or Medium severity vulnerabilities. Analysis reports are available with each release.

Dependency analysis

In each weekly build, during the development process and before every release, all of the third-party libraries and dependencies in Automation Anywhere software are scanned for known vulnerabilities using the Black Duck tool. Automation Anywhere upgrades vulnerable libraries when new versions become available. Analysis reports are available with each release.

All Critical/High vulnerabilities are fixed for each release. Medium vulnerabilities will be considered for fixes in future releases depending on the scope of the Automation Anywhere releases. The list of OSS used by the application is published for each release.

Penetration testing

Automation Anywhere does a penetration test through a third-party vendor before each major release. Additionally, Automation Anywhere incorporates the feedback from penetration tests conducted by customers, which includes some of the largest financial institutions in the world. Analysis reports are available with each release.

Additional security controls

Automation Anywhere Control Room restricts the database connection configuration with the system administrator account.

Restrict installation from database system administrator account

All the database level transactions are done with a nonsystem administrator account. The Control Room installer passes the SQL Server 2012 certification test.

Autolock the device

When Automation Anywhere bots are deployed from the Control Room to remote Bot Runners, they revert the Bot Runner system to its original state. For example, if the Bot Runner machine was logged off and our bot logged into the machine, it logs it off after the automation execution finishes. This ensures that system level security is not compromised.

Using SHgetKnownFolderPath function

Automation Anywhere software uses the SHGetKnownFolderPath function and Knownfolder_ID to determine the full path to the special folders. This is a recommended practice from Microsoft and use of this function ensures that system will never redirect automation data to any other folder, even if someone attempts to hack the function call. This is also one of the InfoSec requirements of Automation Anywhere customers.

API level security

Automation Anywhere software does authentication and authorization level checks at the API level. API calls are serviced only for those users who have permission on the automation data. Unauthorized users cannot bypass system security through rogue API calls.

Clean uninstall

When Automation Anywhere Enterprise Client software is uninstalled, it leaves no trailing files or folders behind. This clean uninstall of the Enterprise Client software complies with InfoSec policies.

Store data in Program Data folder

Automation Anywhere software allows storing of automation data in the Program Data folder, for the files which must be edited by end users. Permissions are also set on the directory during the installation so that the user can edit the content of the folder. This complies with the InfoSec requirements of Automation Anywhere customers.

Protected handling of MSVC DLL files

Automation Anywhere Enterprise Client software uses MSVCxxx.dll files for automation purposes, but it does not install these files by itself. Client software directly uses the DLL files installed by only the Microsoft operating system. This ensures that client software does not overwrite the DLL files installed by Microsoft and our customers do not have to worry about doing one more cycle of checking for any introduced vulnerabilities.

Assembly manifest

All the executables (.exe file) of the Automation Anywhere Control Room and Enterprise Client software contain the manifest files which describe assembly metadata, for example, filename, version number, and culture. This makes our platform comply with organizational InfoSec policies.

Application path on network

Automation Anywhere supports configuration of reading and writing automation data to a location on a network drive. This enables users to keep all automation data at one place.

Autologin without disabling legal disclaimer

When Automation Anywhere bots are deployed from the Control Room to remote Bot Runners, our customers do not need to change security settings, for example, disable login page, disable legal disclaimer, or disable screensaver. Automation deployment works seamlessly without disabling these settings.

Secure Java automation

The Automation Anywhere platform can securely automate even those difficult-to-automate business applications which download the Java runtime environment (jre) during automation execution. Whenever these applications are started, an Automation Anywhere agent gets associated with Java executable noninvasive and automates the business application. After the automation finishes, the Automation Anywhere agent is automatically terminated.

Automation in nonEnglish languages

Users can securely use German, French, Italian, and Spanish language keyboard characters through the embedded automation commands in Bot Creators. This enables users to write data into these languages. Automation Anywhere customers do not need to depend on less secure third-party libraries for this automation.

General Data Protection Regulation guidelines

The General Data Protection Regulation (GDPR) is one of the strictest compliance frameworks for maintaining privacy of personal data. The GDPR defines personal data as any data that can be used to identify a natural person (Data Subject).

For the most current description of Automation Anywhere GDPR compliance statement, see [Cloud Automation Agreement](#) and [Privacy Policy for Automation Anywhere](#).

Automation 360 architecture and resiliency

Automation 360 is a single, integrated platform that transcends front office and back office technology silos to automate business processes across all systems and applications, including both SaaS and legacy apps.

The Automation 360 platform is deployed using a distributed architecture.

Centralized management is done through a web-based server, called the Control Room, to manage all development and execution of the digital workforce. The Bot Agent executes automation and are run time systems installed on the devices.

The following image shows the architecture and relation between Control Room and Bot Agent:

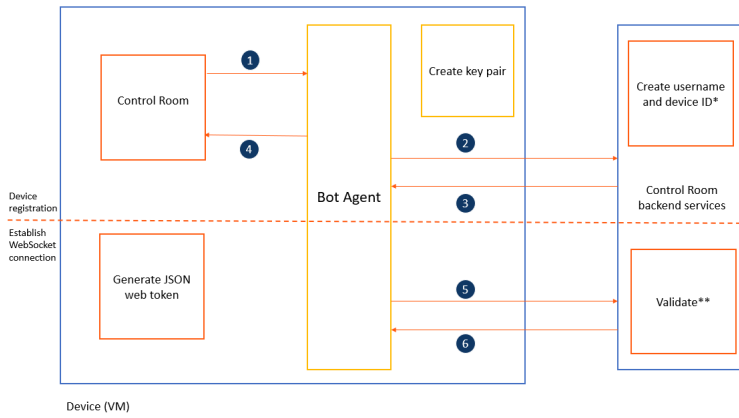

- *indicates that the Control Room creates a unique user name and device ID to persist in the public key in the database.
- **indicates that device public key is validated by the Control Room and a new token is created.

The following table describes the flow and the actions that occur between the Control Room, Bot Agent and the back end services (as numbered in the previous image):

Actions	Description
1	The browser sends the device token to the Bot Agent for registration.
2	The Bot Agent then registers the device request to create a public key and a token.
3	The back end services of the Control Room sends a response to the Bot Agent that the device has been registered with a unique user name and device ID.
4	The Bot Agent sends a message to the browser that the device has been registered successfully.
5	The Bot Agent sends a message to the back end services of the Control Room to indicate that the JSON web token has been authenticated successfully.
6	The back end services of the Control Room then validates the device public key and establishes a Web Socket connection with the new token.

Control Room and Bot Agent resiliency

The following table provides you the behavior and resiliency differences between Automation 360 and Enterprise 11.

Bot Agent in Automation 360	Bot Runner Client in Enterprise 11	Notes
Installation services are run on the local device.	Installation services are run inside an active user session.	

Bot Agent in Automation 360	Bot Runner Client in Enterprise 11	Notes
Registration registered to the Control Room.	An active user is registered to the Control Room.	Bot Agent service runs on the local system.
Authentication stores the agent public key in the database.	Control Room stores the authentication key in the memory.	In Automation 360, the Control Room stores the public key in the database. So when the Control Room restarts, the reconnection is accepted faster. The Bot Agent is resilient across Control Room restarts. However, in Enterprise 11, the Control Room reconnection does not happen after a restart.
Priority of bots is verified at deployment. When bots are queued for a Bot Runner user, higher-priority bots are deployed before lower-priority bots. However, if a lower-priority bot is already running, higher-priority bots are deployed only after the lower-priority bot completes running.	When a low-priority bot is running and a high-priority bot is deployed, the system pauses the low-priority bot and runs the high-priority bot. After the high-priority bot is run, the low-priority bot resumes.	Advantage in Automation 360 is that lower priority bots are not paused and complete their deployment before the high-priority bots are deployed.
Error handler package contains handlers to easily handle exceptions a bot encounters and transfers control to other actions within that bot.	Error Handling command helps in debugging when the TaskBot and MetaBot Logic are run.	
Device is registered when device is registered with the Control Room. Reconnects when the device restarts.	When the Bot Runner Client restarts or loses connectivity with the Control Room, you must re-log to the Client to reconnect.	Bot Agent reconnects without individually logging in to every single device.
Bot Agent reconnects automatically if there is an interruption.	The Bot Runner client needs to be reconnected manually.	Bot registration in Automation 360 is more robust and can reconnect automatically to the Control Room.
Public and private key is generated at the time of device registration. private key This key is used to authenticate to the Control Room.	Same behavior as in Automation 360.	

Bot Agent in Automation 360	Bot Runner Client in Enterprise 11	Notes
<p>Bot Agent is run as a service. When device reboots, the services are automatically connected to the Control Room.</p> <p>Bot Agent continues to check for connection even if the Control Room is down by using the public and private key.</p>	<p>Requires a client to log in and perform tasks.</p>	
<p>Remote Desktop Protocol is supported only on multi-user devices.</p> <p>The Control Room does not maintain the RDP.</p>	<p>Remote Desktop Protocol is supported on both single and multi-user devices.</p> <p>In Enterprise 11, Remote Desktop Protocol connection is established from the Control Room and maintained by the Control Room.</p>	
<p>Control Room administrator can update Bot Agent to automatically update the Bot Agent to a later version using auto-update capability.</p>	<p>Auto-update option is not available.</p>	<p>Auto-update reduces downtime because each user is not required to log in to the Control Room to update the Bot Agent installed on the user device.</p>
<p>Configuration updates are pushed through updates.</p>	<p>No standalone configuration updates, but you can change it manually.</p> <p>Enhancements to the configurations are released as patches.</p>	
<p>Configure device settings to automatically set a user's current device as default device after the user logs in to the Control Room.</p>	<p>Not available</p>	

Bot Agent in Automation 360	Bot Runner Client in Enterprise 11	Notes
<p>Bots that are already running will continue to completion during the update from Bot Agent to Control Room</p>		<p>In general, bots already running can run to completion during the update. Exceptions are as follows:</p> <ul style="list-style-type: none"> • If the bot tags data for Bot Insight, the bot will not run. • Parent/child bots will run to completion because the child bots are downloaded at the start of running the parent bot. However, if child bots are referenced using a variable parameter, calling those child bots need the Control Room to be available during parent bot runs. • Bots that use workload management (WLM) will not run.

Scheduling resiliency

Device pools provide built-in high availability (HA) for the Bot Runner devices if your unattended license is free to use. You are not tied to a single Bot Runner device, so if your device is unavailable for any reason and your unattended license is free for deployment, your automation is not affected. The scheduled automation will automatically run on the next available Bot Runner device, thereby providing high availability.

See [About device pools](#).

Automation 360 FAQ

For details and questions on the latest Automation Anywhere platform, Automation 360, review this FAQ.

What is Automation 360?

Automation 360 delivers a browser-based, intuitive experience for business users to easily automate tasks and powerful tools for developers to build process automation, delivering security, governance, and control on a scalable infrastructure for IT.

What is included in Automation 360?

Everything to build the bots you need to automate your business processes: Control Room cluster, Bot editor, Bot Runner, Universal Recorder, Enterprise-grade security certifications, support, access to the Bot Store, and courses on Automation Anywhere University.

How is Automation 360 deployed?

Automation 360 can be deployed On-Premises as well as in the Cloud.

For Automation 360 On-Premises deployment, the installation is on the customer's servers. With the web-based nature of the Bot Creator, there is no installation or deployment required on the user machines, resulting in a significant reduction in total cost of ownership (TCO).

Automation 360 deployed in the Cloud offers a turnkey solution where the buyers do not have to worry about choosing the cloud provider, or any other infrastructure elements— Automation Anywhere takes care of it all. Admins get the complete set of features for user management, security, governance, and control that they also access through a web browser. The end users can then access the platform using their browser, log in, and start creating their bots.

What additional cloud hosting options are available?

Automation 360 can be hosted on AWS, Microsoft Azure, Google Cloud, IBM, and any public, private, or hybrid cloud service.

How is Automation 360 delivered?

You can start your automaton journey with Automation 360 in one of the following ways:

- Automation 360 (Cloud or On-Premises): Automation 360 is an intelligent cloud-native end-to-end platform you can use to automate your business processes across systems and applications.

For more information see: [About Automation 360](#).

- Community Edition: Community Edition provides a free web-based option for users to experience a range of Automation 360 bot creation capabilities. Community Edition can be used by small organizations (less than 250 machines).

Community Edition provides one Bot Creator license that you can use to log in to one device, and deploy one bot at a time. There is no limitation to the number of automations that you can create, but you will have access to only limited features.

For more information, see: [Get started with Community Edition](#) | [Community capacity and limitations](#).

- Free trial: Free trial license provides an evaluation period of 30 days that you can use to assess the product and make an informed decision. Free trial supports both Cloud and On-Premises deployments and provides access to the full set of features along with full tech support for these 30 days. You will have access

to three Bot Creator and two Bot Runner licenses.

For more information, see: [Trial licenses](#).

What scripting languages does Automation 360 support?

Automation 360 supports JavaScript, Python, and VBScript.

Is Automation 360 available in languages other than English?

Yes, Automation 360 is available in 10 languages: English, French, German, Italian, Japanese, Korean, Portuguese, Spanish, Simplified Chinese, and Traditional Chinese.

How is Automation 360 updated?

For Cloud deployed Automation 360, customers are always on the latest version with updates rolled out by Automation Anywhere on a regular basis. For features such as action packages, admins and users have the ability to test the latest packages before choosing to accept the update.

For On-Premises customers, regular updates are made available through the customer portal, providing admins an opportunity to keep their business-wide installation on the version of their choice.

What are some of the data privacy and security aspects of Automation 360?

Automation Anywhere Cloud privacy is engineered with a comprehensive set of security features that either automatically provide or are configurable by the data owner to provide data protection. Automation Anywhere Cloud includes comprehensive security and encrypts data both in transit and at rest. No personal data goes outside of the environment—unless you tell it to; it remains completely under the control of the IT manager.

To ensure customers can trust the AAI Enterprise Cloud, Automation Anywhere Cloud services are secured based on industry standards and frameworks like NIST Cybersecurity Framework, AWS Cloud Adaptation Framework, Center for Information Security (CIS) baselines, and others.

Is Automation Anywhere Cloud highly available?

Automation Anywhere Cloud is deployed using fully load balanced Control Room environments of Automation 360 deployed on fully HA public cloud infrastructure services within a region.

Is Automation Anywhere Cloud protected with disaster recovery?

Backups are taken every 6 hours to another region (except Australia where backups are kept in country). If a disaster is declared for the primary region, then a secondary region is instantiated for all tenants using the backup. The current objectives for this recovery are:

- RTO (Recovery Time Objective): Time to get a new region up and running with the last backup data restored = 6 hours.

- RPO (Recovery Point Objective): The maximum duration for data loss during a restore = 6 hours.

Note: A DR region might be in a different country.

Related concepts

[Automation 360 Release Notes](#)

Review the new capabilities, changes, fixes (resolved issues), security fixes, deprecated features, and limitations in each release.

Automation 360 Cloud FAQ

Answers to frequently asked questions (FAQ) and related information provide insight into various aspects related to Automation 360 Cloud.

Where can I find an overview of Automation 360 Cloud security?

An overview and details about Automation 360 Cloud security can be found in this document: [Automation 360 Cloud Security and Data Privacy](#).

As a customer, how can I start using Automation 360 Cloud?

The prerequisites and additional, optional steps for getting started can be found on the Automation Anywhere documentation portal at the following location: [Get started with Automation 360 Cloud](#).

For most customers, the basic requirement is to allow secure access, using HTTPS, to their new Control Room environment hosted on Automation 360 Cloud. If this is not already enabled, you need to open port 443 in your firewall to allow outward HTTPS communication from your browser and the Bot Agent to the Control Room. After the Bot Agent is installed, it establishes a web socket connection to the Control Room. No ports need to be open on the customer site for these inbound connections.

Does Automation 360 Cloud provide a service-level agreement (SLA) for service availability?

Yes, an SLA for 99.9 percent monthly availability is provided for the customer's access to their production Control Room environment. The SLA does not include planned downtime for maintenance and updates to the service. If a customer believes that the SLA has not been met, a service credit can be claimed through Support. Details can be found in our [Availability Service Level Terms](#).

How does Automation 360 Cloud support high availability (HA)?

Each customer's Automation 360 environment is deployed using application load balancing across highly available public Cloud infrastructure services. The infrastructure services support both microservices running on Docker containers in Kubernetes clusters and datastores (database, cache, logging, file system, storage) supporting HA

Does Automation 360 Cloud support disaster recovery (DR)?

across multiple zones within a region. Both AWS and GCP public clouds are used.

Yes, Automation 360 Cloud supports DR. Under a disaster recovery scenario the customer's tenants will be brought up in another region using the same URL and their Bot Agent will reconnect automatically. In case of major incidents, where imminent resolution seems unavailable, a disaster situation is declared and all the tenants within the region affected by the incident are failed over to another, remote region. The current objectives for this recovery are as follows:

Recovery Time Objective (RTO)

The time taken to get a new region up and running with the last backup data restored is 4 hours.

Recovery Point Objective (RPO)

The maximum duration for data loss during a restore is 4 hours.

Note: RPO is based on backups taken and pushed to another backup region.

Are there maintenance windows for the Automation 360 Cloud?

Yes, Automation Anywhere updates Automation 360 Cloud every 3 months so that customers will receive automatic and regular updates to the latest software version. For more information, see [Automation 360 software lifecycle policy](#).

The primary channel for communicating the timing of Cloud status and maintenance windows is the [Automation 360 Cloud Service Status site](#). You can subscribe to this website and receive the updates. Note that you cannot choose when the updates are rolled out across the multitenant Cloud. The Automation 360 architecture is designed to allow these timeless updates to roll out without affecting customers' bot development lifecycles.

As a customer, what actions should I take to plan for an Automation 360 maintenance window?

A customer's bot operations should take account of scheduling bots to run outside of the published maintenance windows. These updates are scheduled to run outside of normal business hours on the same day and time per region, and focuses on mid-month, avoiding month ends. More details guiding customers on planning around maintenance windows can be found on this KB article: [Automation 360 Cloud updates](#).

Is customer data stored on the Automation 360 Cloud?

Yes, basic automation processes allow customers to keep customer business data on their own infrastructure using careful bot design. However,

Automation 360 applications increasingly store customer data on the Cloud. Several Automation Anywhere products store customer data as part of customer-defined automations, although typically only temporarily, that is, during the automation process defined by the customer.

For example:

- IQ Bot use typically involves uploading images for processing.
- Recorder and AISense Recorder store recorded screenshots.

Note: Secure recording can be enabled by administrators to ensure that these are not stored.

- AARI stores data processed by attended forms.
- Bot Insight can be used to create dashboards made from tagged business data being processed by a bot.
- WLM stores Work Items in its queues.

The customer has control over what business data is stored on the Automation 360 Cloud. Note that the source data remains with the customer, and the customer is in control of deleting the data on the Automation 360 Cloud. In general, the business data a customer keeps in our Cloud through the use of bots is for automation purposes only and can then be deleted. The primary storage for the data is not on our Cloud. Customers might need to keep audit logs and dashboard data. Both of these can be exported.

What is the Automation 360 Cloud Data Retention Policy?

During a customer's subscription period, data on the Automation 360 Cloud is in their control. Audit logs have a retention policy maximum of 180 days but the audit logs can be viewed at least for the 90 days from the current date. These 90 days are based on the date on which you are checking the logs. The audit log information can be viewed for at least 90 days in the Control Room.

Backups are taken every 6 hours and kept for seven days. After a subscription ends, according to our retention policy, data is held for another 30 days, to allow for renewal or recovery of bots and reports, and is deleted after that. After 60 days, the entire tenant environment is deleted.

Is data stored on the Automation 360 Cloud using common storage infrastructure?

Yes. The data storage services used by Automation 360 Cloud are shared across customers as part of the multitenant design. In this way, the infrastructure and operational costs are not passed on to our customers. Automation Anywhere applications use a unique tenant ID to ensure that

Can Automation Anywhere personnel access customer data stored on the Automation 360 Cloud?

data access is logically segregated by tenant. No data processing or storage operations can expose the data of one customer to another customer.

Yes. However, operational controls governed by Automation Anywhere compliance certifications ensure that such access is limited to a well-defined set of individuals in CloudOps, SecOps, and Support organizations under strict separation of duties. Customer data will be accessed only based on a customer granting permission in order to resolve a support case.

What compliance covers Automation 360 Cloud?

CloudOps is governed by the following certifications based on third-party audits: SOC 1 Type 2, SOC 2 Type 2, ISO 27001, and HITRUST

The Automation Anywhere Business Continuity Management system is also certified with ISO 22301.

Customers rely on industry standard certifications for regulatory and compliance reasons. SOC 2 is created by the American Institute of CPAs (AICPA), and it measures IT security controls. The SOC 2 Type 2 certification verifies that Automation Anywhere CloudOps and SecOps teams have taken the appropriate controls and have put operational processes in place to meet industry standards for secure Cloud operations.

Are the compliance certifications and summary reports for the certifications available for customers to review?

Yes, customers can now access the various summary reports and certifications on the [Security and Compliance Portal](#) under NDA.

How does Automation 360 Cloud support GDPR and an individual's privacy?

Automation Anywhere has put processes in place to handle individuals' data privacy rights, and reviews them on a regular basis to ensure GDPR compliance. For more information, see our [Privacy Policy](#).

Do Automation Anywhere personnel monitor an Automation 360 Cloud tenant's environment?

Yes. All infrastructure and application-level audit logs are monitored to ensure the correct operation of the environment under load. This way, when load thresholds are reached, additional resources can be applied to ensure service availability and performance.

Does Automation Anywhere report unsuccessful data breaches to a customer?

No, Automation Anywhere reports only successful breaches to a customer when that customer's data has been compromised and on a timeline determined by local law.

What data does Automation Anywhere collect to improve the Automation 360 Cloud service?

To operate and support the service, Automation Anywhere captures logs that can include usernames from the system. These rotate and are overwritten every 30 days. Automation Anywhere collects and uses telemetry data only for purposes of improving the service. Collected telemetry data includes the following:

- Audit logs: These reflect user activities in the Control Room and applications, for example, a bot was run successfully or a user created a bot.

Note: The actual username is masked. Logs might include IP addresses, device names, and bot names.

- User clicks on a UX feature: Helps in providing user-specific help and guidance options to the user in the UI based on their experience.
- Where documents are uploaded for processing (for example, when using IQ Bot or AISense), Automation Anywhere may reconstruct the format of the document, without the customer's data, for the purpose of further training the Automation Anywhere AI/ML models to recognize document fields that might contain data for extraction. This aids in improving the application's data extraction accuracy.

This telemetry data can be used to monitor the service and is visible per tenant Control Room, and in aggregate, so that feature usage and adoption can be estimated. This can be used by product management to determine which features to prioritize for improvement and to identify features or applications not being adopted. This data can also help CSMs to advise customers on unused features that they could start using and benefit from.

In which geographical region is a customer's data stored when using Automation 360 Cloud?

In general, for the pure Cloud deployment model, a customer specifies the regional location at the time of provisioning their Control Room instances, for example, US East or Japan.

Note that we cannot provide the detailed address or location of the physical data center because we use public Cloud providers, who reserve the right to move and do not disclose locations for safety and security reasons. We provide this regional capability to ensure that the Control Room is located in the same region where the customer will perform most of their operations to ensure high performance and usability and to reduce latency. For most locations, for business continuity, the disaster recovery element of the service sends data backups every six hours to another region. The other region is usually in another country.

Which regional locations does Automation 360 Cloud support?

Automation Anywhere Control Room environments can be hosted in the following regions:

Primary	Backup/DR
US West	US East
US East	US West

Primary	Backup/DR
EU-West	EU-Central
Japan	Singapore
Singapore	Japan
Brazil	US East
Bahrain	EU-West
India	Singapore
Australia	-
South Africa	EU-West
US Central	US
EU-West4	EU-Central
Canada	-

What if the customer is concerned about data sovereignty (that is, maintaining data in a specified region)?

For customers concerned about data sovereignty, the Pure Cloud model can only guarantee that data is **stored** in the US, EU, and in Australia. This does not prevent the data from being accessed from outside those regions (for example, for support purposes). For the US, the DR region is kept within the US.

Note:

1. The DR service is not supported in Canada and Australia (specifically because most customers in Canada and Australia are conscious of data sovereignty).
2. For EU, we cannot guarantee that data is kept within a specific country within the EU.

What is a sandbox Control Room?

A sandbox is a fully priced and supported Control Room that receives new release updates at least 3 weeks prior to a customer's main Control Room for Bot Lifecycle Management (Dev/Test/Prod). The sandbox environment primarily allows customers to try out new releases and sanity-test their production bots.

Note: IQ Bot and DR are not supported on sandbox environments.

Is the sandbox the same as a trial environment?

No. Unlike a sandbox, a trial or proof-of-concept Control Room is provided free of charge for 30 days ahead of a sale, as part of the selling motion with customers.

Private Bot Store

Private Bot Store is a secure internal bot marketplace for a company to post and share details and documentation for all internally developed bots. Employees can easily discover internal bots and commands to reuse in addition to all of the bots from the Automation Anywhere Bot Store vendors.

Use Private Bot Store to perform the following tasks:

- View, access, and reuse bots to automate processes:
 - Find and reuse bots built by your team
 - Use filters to search for bots by applications, business processes, or a keyword
 - Use bots from the Automation Anywhere Bot Store vendors
 - Review detailed documentation provided with each bot to decide whether to use the bot
- Submit details and documentation about your own bots
- Use the **Suggested bot idea** page to submit a bot idea

Use bots within your company:

- If required, email a bot developer for bot installation assistance
- Review and access bots in your Control Room

Use admin tools to help you with the following tasks:

- Review, approve, and publish bots
- Review your team's bot use case ideas
- Add or remove users and assign permissions

Watch the following video on how to get started with Private Bot Store:

<https://www.youtube.com/embed/ZE5hxVQw-tY>

Related concepts

[Getting started with Private Bot Store](#)

Use Private Bot Store to view and submit bots and bot use cases within your company. Use admin tools to review and publish bots and manage users.

Learn

Learn about software policies and feature deprecations that impact Automation Anywhere products.

Release notes

Learn about what's new, changed, fixed, or the issues (limitations) in Automation 360 releases:

- [Automation 360 Release Notes](#)
- [Community Edition Release Notes](#)
- [Automation 360 Package SDK Release Notes](#)
- [Process Discovery Release Notes](#)
- [CoE Manager Release Notes](#)

Comparison matrices

Compare features between products to review feature parity and understand compatibility in order to update or move to our latest product release.

- [Automation 360 feature comparison matrix](#)
- [Automation 360 IQ Bot feature comparison matrix](#)
- [Automation 360 IQ Bot version compatibility](#)

Software lifecycle policy

The Automation Anywhere software lifecycle policy aims to provide predictability, quality, and importantly nondisruptive access to the latest innovations and enhancements so that you can control when and how you want to adopt these enhancements.

See [Automation 360 software lifecycle policy](#).

Cloud Service status

Our Automation 360 Cloud Service Status site shows real-time operational status, historical operational status, maintenance information, and incident history for all Automation 360 Cloud services worldwide, across all hosting regions.

See [Automation 360 Cloud Service Status site](#).

Feature deprecations

Learn about features and capabilities (from Automation Anywhere or third party) that are deprecated or nearing deprecation to understand how they affect your automation and what action is required.

See [Feature deprecations affecting Automation Anywhere products](#).

Automation 360 Release Notes

Review the new capabilities, changes, fixes (resolved issues), security fixes, deprecated features, and limitations in each release.

Note: Enterprise A2019 is now called Automation 360. Although the release notes for releases earlier than Automation 360 v.21 reference the old product name, the content in these release notes is applicable and relevant to Automation 360.

Use the links to view the release notes updates for each release.

Related concepts

[Community Edition Release Notes](#)

Review the new capabilities in different Automation 360 Community Edition releases.

Related reference

[Automation 360 Sandbox Release Notes](#)

[Automation 360 feature comparison matrix](#)

Use the feature comparison matrix to compare the Automation 360 features with the features in Automation Anywhere Enterprise 11.3.x and Enterprise 10 versions.

[Automation 360 FAQ](#)

For details and questions on the latest Automation Anywhere platform, Automation 360, review this FAQ.

Automation 360 v.27 Release Notes

Release date: 11 January 2023

Review the top five features in this release and view other new features and exciting enhancements for Automation 360 v.27 release (Build 16667).

Highlights of this release

Here are the **top 5** features in the v.27 release:

Smart embedded forms and dynamic data mapping for embedded widgets

Faster design and use of your embedded automation:

You can now design your forms using a responsive and real-time canvas that automatically adjusts to the desired form size. This feature provides a faster way to create embedded interfaces that interact with any web applications. You can also configure these forms in your business applications, such as Workday or ServiceNow, to securely retrieve data when embedded as an iFrame widget.

Eliminate data re-entry and save time: Use our new PostMessage API to map and prepopulate data from business applications in embedded widgets. Dynamic data mapping provides safe and secure communication of data from your business (host) applications to initial process forms in the widget.

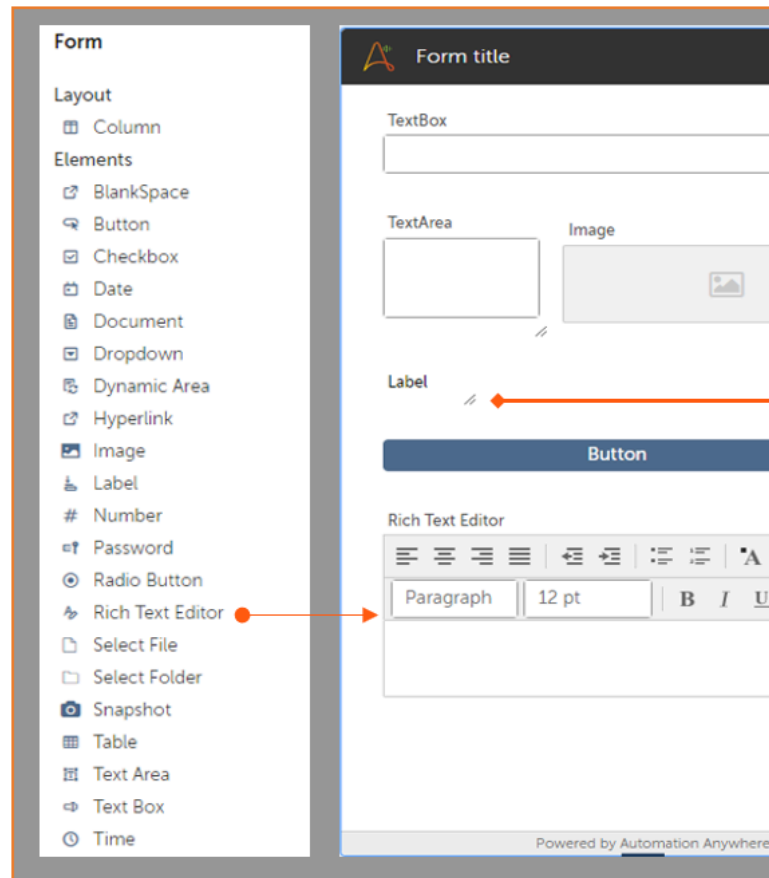

Smart Embedded Forms

Design forms that can embed in any web application via an embedded widget

- Form canvas dynamically adjusts to fit form size
- Drag and drop elements directly into canvas
- Mouse draggable resizing of elements

See [Smart embedded forms and dynamic data mapping](#).

Enhanced citizen developer experience

Our updated and intuitive icons enable citizen developers to quickly select actions and use the Help for contextual information about actions, providing a more seamless development of automations.

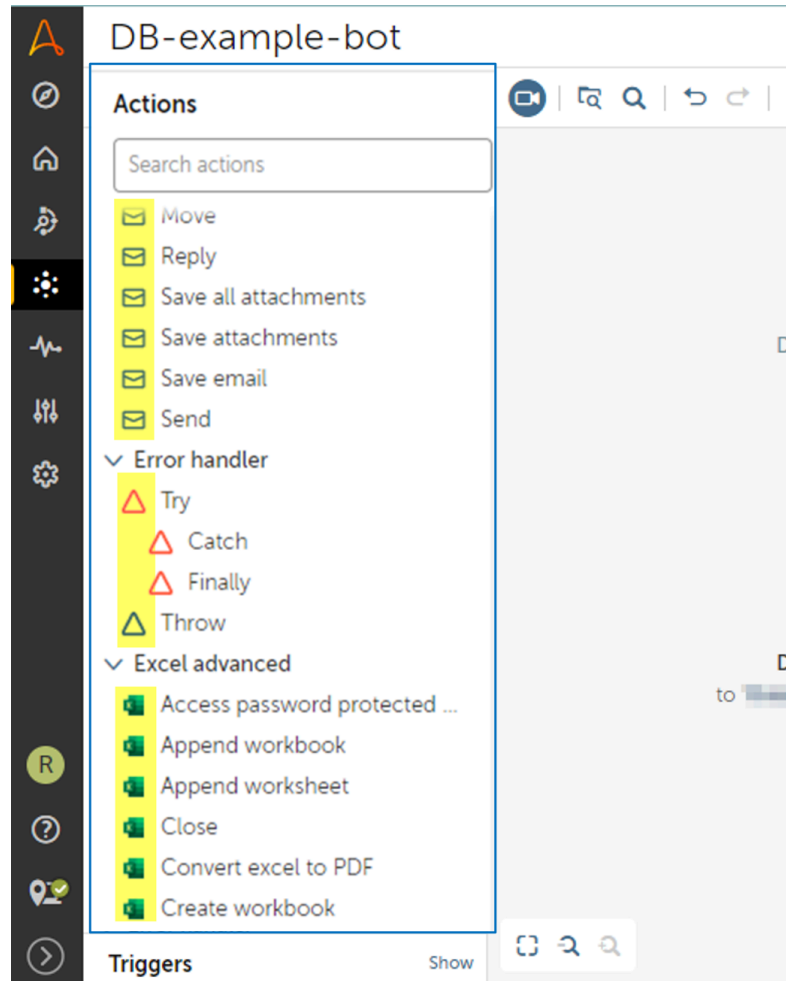

Strengthen governance and management

Notifications: Our new notifications capability provides a centralized, consistent, and proactive medium for users to stay informed on their automation estate and to take actions based on the events they are alerted on. Alerts on various platform events, bot events, and other automation lifecycle events are delivered via in-app (default) and email (based on user preference).

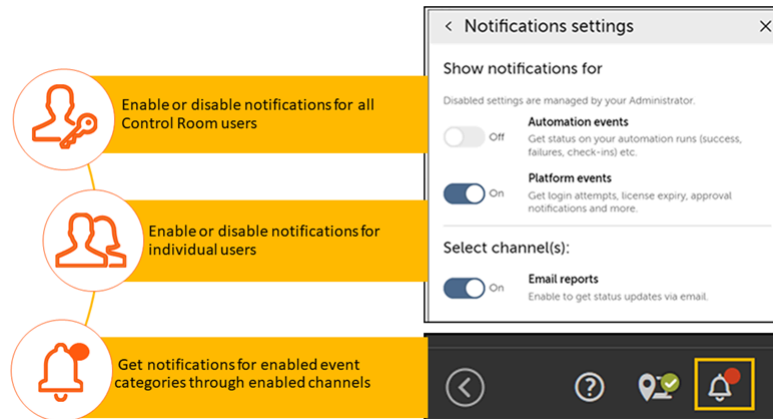

See [Notifications](#).

Automatically pick available Bot Runner users: Scale your automations easily by selecting all the Bot Runner users that can run a given automation and the number of Bot Runners to use. This capability ensures that when you run or schedule an automation, the system automatically picks the available run-as users from the specified list.

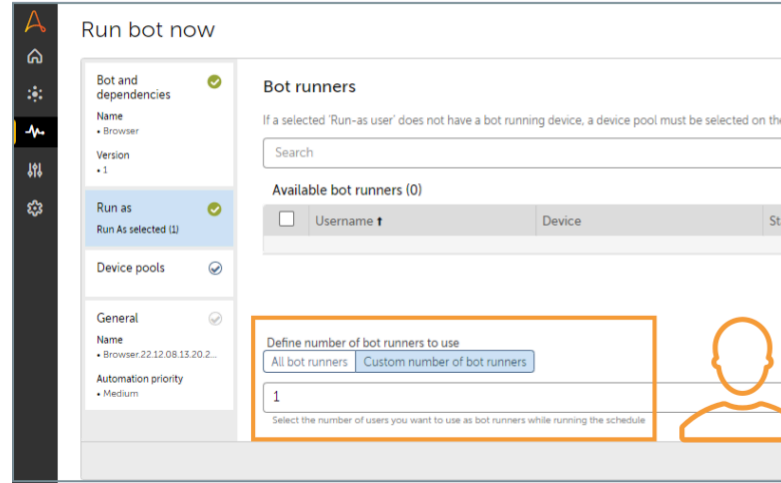

See [Automatically select the number of Bot Runners users](#).

Standard forms

Standard forms is now integrated in Document Automation with the other document processing capabilities. With enhanced accuracy and support for more than 200 languages, this feature enables you to extract data from densely structured forms including those with handwritten input. Use cases for structured documents include tax forms, mortgages, vehicle registration address, and so on.

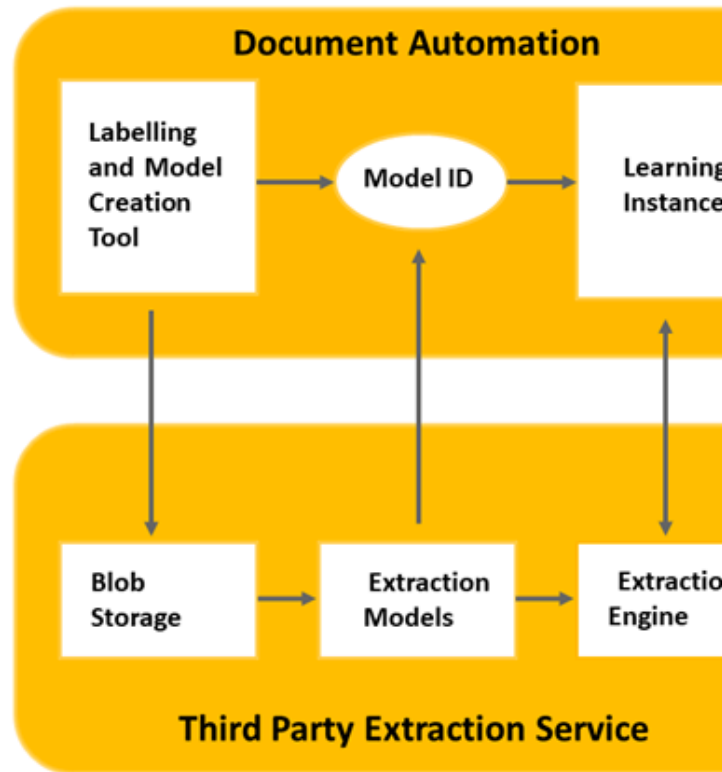

See [Using Document Automation for Standard Forms](#).

PEG enhancements

We continue to improve our Privacy Enhanced Gateway (PEG) for sensitive information redaction with a new configuration UI so you can easily change the configurations in the UI instead of the command line. We have also recently released a new PEG serverless architecture for higher-scale data collection use cases.

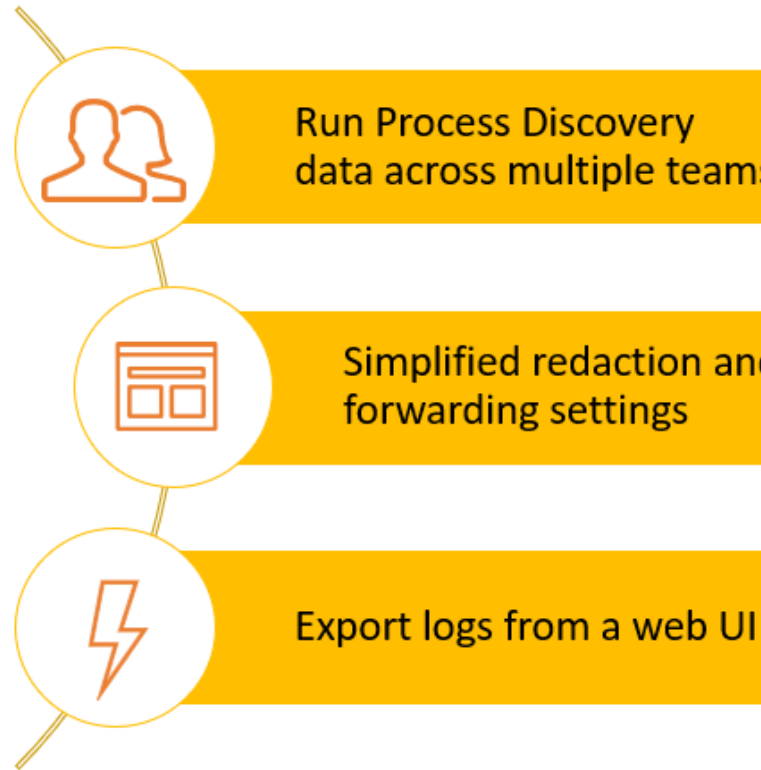

See [Manage redaction and forwarding settings from the UI](#).

What's new and changed in each product

Navigate to the following pages for details on all the updates (what's new, changed, fixed, and limitations) in each product:

<p>RPA Workspace v.27 release</p> <ul style="list-style-type: none"> • Updating to v.27 release • Packages updated in v.27 • Migration updates for v.27 release
<p>Process Discovery v.27 release</p>
<p>AARI v.27 release</p>
<p>IQ Bot and Document Automation v.27 release</p>
<p>Bot Insight v.27 release</p>

Related reference[RPA Workspace v.27 release](#)

Review what's new and changed, and the fixes and limitations in RPA Workspace for the v.27 release.

[Process Discovery v.27 release](#)

Review what's new in Process Discovery for the v.27 release.

[AARI v.27 release](#)

Review what's new and changed, and the fixes and limitations in AARI for the v.27 release.

[IQ Bot and Document Automation v.27 release](#)

Review what's new and changed, and the fixes and limitations in IQ Bot and Document Automation for the v.27 release.

[Bot Insight v.27 release](#)

Review the fixes in Bot Insight for the v.27 release.

[Packages updated in v.27](#)

Review updates to the packages in Automation 360 v.27, including the compatible Control Room and Bot Agent versions.

[Enhancements to browser extensions](#)

Create automation from supported browsers by using browser extensions. Extensions are periodically updated to support feature enhancements and fixes. Therefore, ensure that you have the latest versions of extensions for the Google Chrome, Microsoft Edge, and Mozilla Firefox browsers.

RPA Workspace v.27 release

Review what's new and changed, and the fixes and limitations in RPA Workspace for the v.27 release.

What's new

Control Room, devices, and Bot Agent
<p>Windows 365 Cloud PC now supported as Bot Runner (Service Cloud case ID: 01792699)</p> <p>We support Windows 365 Cloud PC as a Bot Runner to create and run bots on Windows 365 Cloud PC.</p> <p>Automation 360 Bot Runner device requirements</p>
<p>Oracle Database is now supported on Linux (Service Cloud case ID: 00726728)</p> <p>We now support Control Room with Oracle Database on Linux, so you can now choose to install the Control Room with Oracle Database on Linux.</p> <p>Installing Control Room on Linux Database requirements</p>

Control Room, devices, and Bot Agent

Microsoft Edge offline extension is supported (Service Cloud case ID: 01829649, 01880289)

You can now install the Microsoft Edge offline extension for Microsoft Edge Enterprise browser users even when the device is offline.

When the Bot Runner machines do not have Internet connectivity, you can use these features with the Microsoft Edge offline extension:

- Automation of web apps
- User interface triggers
- Device registration

The Microsoft Edge offline extension is transparent and works similarly to the Microsoft Edge online extension for users.

[Install Bot Agent and register device](#) | [Enhancements to browser extensions](#)

Centralized notifications repository for various events and capability updates

You can now track all the platform and automation events through a centralized repository. With this feature, you can identify the severity of events, consider possible actions based on the severity of events, and then take appropriate actions. You can also be notified about platform updates, such as bot export and package updates. Thus, it improves platform and user productivity.

[Notifications](#)

Automatically select the number of Bot Runners (Service Cloud case ID: 00821020, 00715598, 00723191, 00784822, 01830238, 01870817)

You can enable Automation 360 to automatically select the Bot Runner users for specific tasks to:

- Scale automations easily
- Run bots concurrently
- Use resources efficiently

This capability ensures that when you run or schedule an automation, the system automatically picks the available run-as users from the specified list.

[Automatically select the number of Bot Runners users](#) | [Schedule a bot](#)

Manage domain accounts using gMSA (Service Cloud case ID: 00731119)

You can use a group Managed Service Account (gMSA) to manage and run Control Room and other Automation 360 services.

[Configure service credentials](#)

View keyboard shortcuts in Bot editor

In Bot editor, you can now open a menu to view the available keyboard shortcuts.

[Keyboard shortcuts](#)

Validate device credentials prior to bot deployment

Prior to bot deployment, you can select to validate the device credentials for Bot Creator, attended Bot Runner, Citizen Developer, and unattended Bot Runner users. This provides users additional security for bot deployment.

[Switch device registration between Control Room instances](#)

Control Room, devices, and Bot Agent

Export roles to view users and their permissions (Service Cloud case ID: 01804955)

You can export selected roles and their permissions to CSV files to view the following information:

- User information
- Run-as user information
- User permissions
- Folder permissions

[Export roles](#)

Enhanced Automation Anywhere Debugger tool

The Automation Anywhere Debugger tool is available in the **Bot Assistant** utility to provide a better user experience. When you invoke the Debugger tool from the Bot editor, you can add, update, or delete actions and variables in a bot.

By default, the **Watched variables** lists is empty. With a single click, you can add all the used variables in a bot. These variables display in a pop-up window where you can select or deselect, one or more variables, from the list.

[Debugger features](#)

Packages, actions, and Bot editor

Notification for package updates

When you add or update a package or upload a custom package to the Control Room, you are now notified about this platform event. This notification is displayed to all the Control Room users through the **Notifications** repository.

[Capabilities supporting notifications](#) | [Add packages to the Control Room](#) | [Add custom package to your Control Room](#) | [Upload custom package to your Control Room](#)

ServiceNow package

You can use the ServiceNow package from Automation 360 to authenticate and perform several actions with records and attachments in ServiceNow tables.

[ServiceNow package](#)

ServiceNow triggers

You can use ServiceNow triggers to call an action when there is a new or updated record.

[ServiceNow New Record trigger](#)

Cut, copy, paste keyboard shortcuts added for TN3270 and TN5250 Terminal Emulator

In the Terminal Emulator package, the following keyboard shortcuts are now available specifically for TN3270 and TN5250:

- Shift + Control + A = Select all
- Shift + Control + C = Copy
- Shift + Control + X = Cut
- Shift + Control + V = Paste

[Using Send text action](#)

Packages, actions, and Bot editor
<p>Quick assistance at hand for the developers in the Bot editor</p> <p>The accessibility and usability of the Bot editor, actions, and packages have been improved. As a citizen developer or an RPA developer, when you are creating bots, you can quickly look up information about the actions without navigating outside the Bot editor. Under the Actions pane, quick help is enabled with contextual information about actions. Additionally, an icon is configured with a link to the documentation. If you want more information about an action, you can click the link, which redirects you to the relevant page in the documentation portal. This feature is currently available in the following actions and packages.</p> <ul style="list-style-type: none"> • Database • Email
<p>Enhanced user experience through refreshed and intuitive icons</p> <p>With the new and intuitive icons for actions in the Bot editor, citizen developers and RPA developers can quickly locate the correct action while creating automation for a day-to-day task. These unique and renewed icons are developed according to brand and global standards.</p>
<p>Seamless package updates</p> <p>When a package version is added to the Control Room, either from a Cloud download or Control Room upgrade, as an administrator, you have the flexibility to disable the new version of packages. This feature helps you to restrict users from using the new package version until it is verified.</p> <p>Package updates Automatic package updates for On-Premises Control Room Automatic package updates for Cloud Control Room</p>
<p>New option in Read from action of Database package (Service Cloud case ID: 01263940)</p> <p>A new check box is available when you use the Read from action to retrieve records from the database and save the retrieved data in a CSV file. When you select this check box, no CSV file is created if the executed SQL query does not return any data.</p>
<p>Proxy support for EWS-OAuth2 (Service Cloud case ID: 00771400, 01574715, 01815888)</p> <p>When you create a bot with the Email package that uses EWS OAuth2 for authentication and the Bot Runner machine is configured behind the firewall, then all outbound requests are routed through the proxy server configured on the Bot Runner machine.</p>
<p>64-bit ODBC driver now supported in Database package (Service Cloud case ID: 01256142, 01829360, 01849908)</p> <p>We now support connecting to databases by using the 64-bit ODBC driver. This option is available when the connection mode is the default. Organizations transitioning to Office 365 will benefit from leveraging this enhancement and can sustain automation build with 32-bit ODBC drivers.</p> <p>Using Connect action for database</p>

Packages, actions, and Bot editor

OAuth 2.0 support in Email and Email trigger packages (Service Cloud case ID: 01798311, 01803702, 01791859, 01828526)

Microsoft is deprecating the ability to use Basic authentication in Exchange Online for these specific protocols:

- IMAP
- POP3
- EWS

We support OAuth 2.0 authentication for these protocols in the Email and Email trigger packages. For enhanced security, you can maintain the business continuity of your email automations by switching the authentication type from Basic to OAuth 2.0, (as recommended by Microsoft).

[Using Connect action for Email](#)

Retry mechanism supported in credential variables (Service Cloud case ID: 01786319, 01887182)

The credential variables support the retry mechanism. When you create a bot that uses credential variables, if the bot fails during run time to retrieve those variables from the Credential Vault because the Control Room is disconnected or the Control Room services stop intermittently, then the bot tries three times to retrieve the credential variables from the Credential Vault.

Note: Ensure that the Bot Agent version installed on your system is the version that is released with Automation 360 v.27.

Packages, actions, and Bot editor**Support of other domain name in the Active Directory package** (Service Cloud case ID: 01807358, 01910765)

We now support Active Directory user operations by logon name with domain and can provide the domain name to extract user details. When you retrieve the user property or perform any user operation based on the logon name (userPrincipalName), and if the user domain name differs from the domain specified in the LDAP path, the user properties are now successfully retrieved with or without a domain name.

For example, LDAP Path: LDAP://ADServer/DC=automation, DC=net

User	Logon name
userPrincipalName: kim@aaengg.net	User can provide logon name as kim@aaengg.net.
userPrincipalName: shaun@aasales.net	User can provide logon name as shaun@aasales.net.
userPrincipalName:sarah@automation.net	user can provide a logon name as either sarah or sarah@automation.net.

The following list of actions supports logon name with domain.

- Update user details
- Rename user
- Delete user
- Enable user account
- Disable user account
- Set user property
- Get user property

User account operations

Shared mailbox support for Email automation (Service Cloud case ID: 00797231, 01816574, 01829499, 01854615, 01871861, 01933058, 01834152, 01829684, 01853949, 01880386, 01869636, 01894591, 01867553, 01911371. 01925438)

The Email package supports the email automation of a shared mailbox in Outlook for Office 365/ Microsoft 365 using IMAP/EWS protocols, and OAuth 2.0 authentication using Client Credentials and Authorization Code with PKCE grant flows. You can automate emails retrieved from a shared mailbox and perform all email-related tasks by accessing each folder(s) and its subfolder(s) in the shared mailbox.

New action in Text file package

You can use the new **Read variables** action in the Text file package to read the values of variables from the text file.

Note: The **Import string from text file** action in the String package has been deprecated.

Read variables action

Packages, actions, and Bot editor

Call an existing JavaScript function in a webpage

You can use the new **Call a JavaScript function** action in the Browser package to call an existing JavaScript function directly in a webpage or in an iFrame within a webpage in Google Chrome and Chromium-based Microsoft Edge browsers. In the bot, you can also pass one or more input parameters to the JavaScript function and process the return value from the function.

[Call a JavaScript function action](#)

Automate controls using Microsoft UI Automation (COM) technology

You can use the Microsoft UI Automation (COM) technology to automate the following scenarios:

- Capture and automate client controls
- Capture and automate password text controls
- Capture and automate page tab controls

[Actions performed on objects captured with Universal Recorder](#) | [Capture using specific technology](#)

Capture objects on applications running in administrator mode

You can use the Recorder to capture objects on applications running in administrator mode. To capture the object, select the **Capture and run with admin privileges** option from the Bot editor.

[Recorder package](#)

Enhanced bot performance when using global values across bots

When you use global values across a parent bot and a child bot, the bot performance is enhanced by reducing the bot execution time. To enable enhanced bot performance, you must set the **Bot compatibility version** to **3** in the **Advanced settings** page of the Bot editor.

Note: Ensure that the Bot Agent version installed on your system is the version that is released with Automation 360 v.27.

[Bot compatibility version](#)

Enhanced user interface for Define functionality in AISense Recorder

- We have enhanced the user interface of **Define** window in the AISense Recorder that enables you to use anchors easily and automate UI objects that are not detected by AISense Recorder automatically. To improve functional clarity, the following object types are renamed:
 - **Active text** is renamed to **Link**
 - **Passive text** is renamed to **Text value**
- If you unintentionally click the screen or click before the highlighter appears, the AISense Recorder provides visibility into it. You must confirm to capture the object again or use the **Define** functionality to define the object on the screen.
- In the **Define** window, the AISense Recorder shows embedded help for each of the control types so you can select the correct control types for custom objects.

[Use variable anchor](#) | [Capture Textbox, Radio, Checkbox, and Combobox](#) | [Capture text value through AISense Recorder](#) | [Capture link button through AISense Recorder](#) | [Capture Image button through AISense Recorder](#)

Packages, actions, and Bot editor**New virtual key added to the Simulate keystrokes package**

In the **Simulate Keystrokes > Keystrokes** action, a new key named **Return** has been added to the virtual keyboard for Enter functionality and the Enter key in the Number pad has been renamed to **Num Enter**. As a result, the **Return** key is the main Enter key on the keyboard. This enhancement keeps the keyboard in sync with the physical keyboard. The nomenclature has been changed to avoid confusion between the Enter key on the keyboard and the Enter key on the Number pad.

Support for global variable for all Datetime actions

In the Datetime package, you can use the Datetime global variable across all **Datetime** actions. You can select to use either **String** variable or a **Global** variable in the **Source date and time variable** option. This avoids creating multiple local variables and reduces the total number of actions used in a bot.

[Datetime package](#)

Important: For information about the supported packages for this release, see [Packages updated in v.27](#).

Building and running bots**Notification for bot export**

When you export a bot in the Control Room, you are now informed through the **Notifications** repository. This notification is sent only to the user who exported the bot.

[Capabilities supporting notifications](#) | [Export bots](#)

Code analysis runs automatically for all unscanned bots in public workspace

Code analysis now runs automatically on all the bots with the **Not Scanned** status in the public workspace. This ensures visibility on the coding best practices for policies configured in the Control Room and will show the results of code analysis for all the bots in the public workspace without the need to run code analysis on each bot one by one.

Check out multiple bots and files (Service Cloud case ID: 00628344, 00822352)

You can now select multiple bots and their dependent files from different folders that belong to the same process and check them out from the public to the private workspace. You can check out a maximum of 10 parent bots, but there is no limitation on the number of dependent child bots.

[Check out multiple bots](#)

Choose specific version of non-bot dependency to check out with parent bot

When you check out a parent bot, you can now choose the version of a non-bot file dependency to check out. Every version of a parent bot can have different versions of non-bot file dependencies.

With this feature, you can roll back the dependencies while rolling back the parent bot. You can make changes to a specific version of the dependent non-bot file.

[Check out non-bot file dependencies](#)

Building and running bots
<p>Compare bot version in private workspace (Service Cloud case ID: 01761840, 01771389, 01763432, 01904500)</p> <p>You can now see the changes made to your bot logic in the private workspace before checking in your bot. As a Bot Creator, it was difficult to identify the changes made to the bot logic, input, and output parameters. With this functionality, you can now easily identify where you have made the modifications to the bot logic, variables, triggers, dependencies, and packages compared to the latest version or any other previous version of the bot.</p> <p>Compare bot versions</p>
<p>Edit non-empty folder description in public workspace (Service Cloud case ID: 01820406)</p> <p>You can edit the description of non-empty folders in the public workspace. Meaningful descriptions provide more insight of the bots contained in that folder. This feature enables an administrator or a user with rename folder permissions to better manage the repository when it contains many folders.</p> <p>Create and rename folders</p>
<p>Specify queue running times in workload automations (Service Cloud case ID: 01816260, 00331357, 01924895)</p> <p>You can set the specific time period when to run a workload automation. When creating the workload automation, you can set the queue running days and time to ensure that the automation does not run during these scenarios:</p> <ul style="list-style-type: none"> • Applications are not available • During scheduled upgrades • Non-working days (holidays, weekends) <p>Run bot with queue</p>
<p>Check for duplicates when adding work items (Service Cloud case ID: 00825850)</p> <p>You can check for duplicate work items before adding them to the queue. This feature prevents re-processing the same work items multiple times, thus saving time and resources. You can either move the work items marked as duplicate for re-processing or discard them.</p> <p>Insert Work Items</p>
<p>Generation of API Key is audited</p> <p>The generation of the API key is now audited and will display the expiry time of the api-key in the audit logs.</p>

APIs and integrations
<p>Workato Integration</p> <p>You can integrate the Automation 360 platform and Workato by using the Automation Anywhere connector. You can establish a connection with the Automation Anywhere Control Room and perform various operations using the Control Room APIs.</p> <p>Workato integration</p>

APIs and integrations**SnapLogic Integration**

You can now integrate the Automation 360 platform and SnapLogic. You can establish a connection with the Automation Anywhere Control Room and perform various operations by using the Control Room APIs.

[SnapLogic integration](#)

RPA Bots for Salesforce

Now when creating new connections, you have the option to include an API Gateway certificate.

What's changed

Control Room, devices, and Bot Agent**Automated reprocessing of failed WLM work items** (Service Cloud case ID: 00825872)

When you create or edit a queue, you can now use the **Max auto retry attempt** option to ensure that failed WLM work items are reprocessed automatically. With this option, you can specify the number of times for which the automatic reprocessing of failed work items will be attempted.

Automatic reprocessing of failed work items is attempted after all the work items in a queue are processed.

Better device management with improved device permissions (Service Cloud case ID: 01264963, 01871530)

You can now view and manage Bot Agent devices even if you have not registered them by using the enhanced **Edit the device(s)** permission. The **Edit the device(s)** permission is improved as follows:

- **Device(s) from my device pools:** To edit devices from device pools
- **Run as users default device(s):** To edit Run as user(s) default device

The Control Room administrator grants you access to a specific set of devices based on your role. When the **Edit the device(s)** permission with the **Device(s) from my device pools** and **Run as users default device(s)** options is selected, you can view and manage all (registered and non-registered) devices from a specific accessible group.

Enhanced bot Compare versions page

The bot **Compare versions** page shows changes in the dependencies between two versions of the bot. It shows changes for the first level of dependencies only and displays those dependencies sorted in alphabetical order.

Specify time period to put work item on hold (Service Cloud case ID: 00825875)

You can put a work item on hold for a specific date and time. This ensures that the work item moves automatically to processing (new state) on the specified date and time and no longer requires you to manually move it for re-processing. A new column in the **Edit queue** page displays the hold status of the work item, either date and time or indefinite if you do not specify the date and time.

[Edit queues](#)

Packages, actions, and Bot editor
<p>Control Room version compatibility check with specific packages</p> <p>When you manually upload a package or a bot in the Control Room, the system now checks if the specific packages used in the bot are compatible with the Control Room version.</p>
<p>Analyze button renamed in Bot editor</p> <p>The analyze button of Bot Insight (Analyze Task Bot) has been renamed to Bot Insight "Analyze" dashboard in the Bot editor page.</p>

Fixes

<p>When syncing with the Active Directory (AD), the user mapping no longer overwrites the Description field in the Automation 360 Control Room with blanks.</p>
<p>The Automation 360 Control Room no longer generates an error in the User Management log when a mapped security group has no members.</p>
<p>Users without permission cannot view the activities of other users on the Activity > In progress page.</p> <p>Previously, some users were able to view the activities of other users even though they did not have permission.</p> <p>Service Cloud case ID: 01911289, 01910582</p>
<p>If you configured the log collection level as Debug, the logs collected from some packages do not include customer data.</p> <p>Previously, the logs collected from some packages included customer data.</p> <p>Service Cloud case ID: 01862053, 01870001</p>
<p>When you set the device_resource_monitor feature flag to true, and if the CPU utilization and device memory threshold values are within the percentage range defined by the Control Room administrator, the bot is not deployed. A clear error message now indicates the device unavailability and suggests an appropriate action.</p> <p>Previously, the bot deployment failed, and an unknown error message displayed which caused confusion for users.</p>
<p>In the Oracle Database environment, a checked-in bot is now automatically refreshed and can be viewed in the Public folder.</p> <p>Previously, to view a checked-in bot in the Public folder, you had to manually refresh the Automation page by using the Refresh button.</p>
<p>When a Stop Task command is used, WLM work items are now marked as completed successfully and show the correct status in the Control Room.</p> <p>Previously, WLM work items were marked as failed even if the bot was executed successfully.</p> <p>Service Cloud case ID: 01841320</p>

When you run WLM automations, if the Control Room restarts during deployment, the WLM deployment continues without delay when Control Room services are active.

Previously, after the Control Room restarted, there was a delay of 15 minutes before the WLM deployment continued.

In an Oracle Database environment, when you select the number format and sort order for the work items in a queue and then run bot by using the **Run bot with queue** option, the queues are now deployed successfully. Also, the correct log entry is shown in the **Audit log** or **Activity** page.

Previously, queues were not deployed, and no errors were shown in the **Audit log** or **Activity** page.

In the Email package, connect to the **EWS** server and use **Loop > For each mail in mail box**. If the source mail is sent on behalf of some other user, for example, user `xyz@aa.com` sent mail on behalf of user `abc@aa.com`, the email dictionary variable `emailFrom` now returns the correct sender ID, which is `abc@aa.com`.

Previously, the email dictionary variable `emailFrom` returned the sender ID as `xyz@aa.com`.

Service Cloud case ID: 01856149

When you run a stored procedure in Oracle and it returns `SYS_REFCURSOR`, the **Run stored procedure** action closes the cursors.

Previously, the **Run stored procedure** action was not closing the cursor after the maximum cursor limit was reached.

Service Cloud case ID: 01842046, 01898572

In the Active Directory package, when you perform a user account operation such as **Add users to group**, **Delete user**, **Disable user account**, or **Rename user**, and if the username has an asterisk (*), open parenthesis, or close parenthesis, you can now add a user without any error.

Previously, the username did not support the following special characters: asterisk (*), open parenthesis, and close parentheses.

Service Cloud case ID: 01884962

When you create a folder in Outlook with a percentage (%) in its name (for example, `Clients%ClientA`), create a bot using the **Connect** action from the Email package and then use the **Folder exists or Folder does not exist** condition, the bot finds the `Clients%ClientA` and retrieves mail from it.

Previously, the bot was not able to retrieve mails from the folder because percentage (%) was not supported in the folder name.

When you connect to the Microsoft Access Database with JDBC and specify the database path, if you use the following specific aggregation functions in the query, an error is no longer encountered when you run the bot:

```
ASC, ATN, SQR, CBOOL, CCUR, CDATE,
CDBL, CDEC, CDATE, CDBL, CINT, CLONG, CLNG,
CSIGN, CSTR, CVAR, DATEADD, DATEDIFF, DATEPART,
DATESERIAL, DATEVALUE, FORMAT, IIF, INSTR, INSTRREV,
ISDATE, IsNull, ISNUMERIC, LEFT, LEFTS, LEN, MID,
MONTHNAME, DATE, NOW, NZ, SIGN, SPACE, STR, TIME, VAL,
WEEKDAYNAME, WEEKDAY, STRING, TIMESERIAL, CONCAT
```

When using the **Task Bot: Run** action, you can search dictionary and session variables to use as input parameters. Previously, no results displayed when using this Advanced search feature.

Service Cloud case ID: 01879539

When you use the **Save** action in the Email package, and if the email subject includes a comma (,), the emails are saved successfully.

Previously, if the email subject included a comma (,) and you saved the email, the comma (,) was replaced with an underscore (_).

Service Cloud case ID: 01786211

When you select the **Package** details page, and select the **Availability** tab, if the package (all users or selected roles) is changed, then the **Package** details page displays the last modified information of the user who made the changes, and the changes made at the access level (all users or selected roles).

You can create bots using the **Download file** action of the Google Drive package.

Previously, when you used the **Download file** action and marked the **Overwrite existing file** option to overwrite the file of the same name, the downloaded file became corrupted. If you then used the **Excel advanced > Open** action to open this file, or manually tried to open the Excel file, an error message displayed indicating that the Excel file was corrupted.

Service Cloud case ID: 01833815

You no longer have an incorrect starting date when you create an event using the Google Calendar package.

Previously, when you created an event in Google Calendar and entered the value in the **Start Date** field with the event type set to **All Day**, the Google Calendar package decremented the day value by one when you selected the **All Day** option.

Service Cloud case ID: 01815644

When you use the **Excel advanced > Open** action to open an Excel spreadsheet which did not exist and then run the bot, the bot now displays the correct error message in Japanese.

Service Cloud case ID: 01857992, 01925567

You can successfully extract fields from a PDF file when you use the **PDF > Extract field** or **Extract text** actions.

Service Cloud case ID: 01818304

When you use the 3.6.1-20220428-010115 version of the Simulate keystrokes package to enter keystrokes against specific webpages running in the Microsoft Edge browser with IE mode, the bot processes the keystrokes faster.

Service Cloud case ID: 01820418

When you use the **PDF > Split document** action to split multiple PDFs into various folders and then use the **For each file in folder** iterator to run the bot in a loop to split each file in the specified folder, the bot no longer encounters an error.

Service Cloud case ID: 01803983

When you use the **File > Copy Control Room file** action and choose the dynamic file path option to select a file from the Control Room repository, the bot no longer encounters an error. Previously, even if the uploaded file was available in the Control Room, the bot failed and displayed this error message: `Get Resource failed: Error: Could not find the file at the Control Room path.` Check the file path and try again.

Service Cloud case ID: 01805364

When you use the **File > Rename** action to rename and overwrite an existing file, the bot no longer shows an incorrect error message. Previously, when you tried to rename an existing file, the bot showed an incorrect file name in the error message.

Service Cloud case ID: 01845943, 01858350

You can successfully rename the file and remove an extension from the file name by using the **File > Rename** action. Previously, when used the **Rename** action to remove an extension from the file name, the bot trimmed the last character from the file name instead.

Service Cloud case ID: 01842995

When you use the Recorder to capture objects on an application that is installed on a virtual machine, finish the recording after the objects are captured, and then relaunch the Recorder, the bot successfully launches the Recorder and no longer inserts any actions that were recorded earlier.

When you run the bot using the following sequence of actions, the bot shows accurate data for each loop iteration:

1. Use the **Database > Connect** action to connect to the database
2. Use the **Database > Read** action to read the values from the database
3. Use the **For each row in a SQL query dataset** iterator to run the bot in a loop
4. Use the **Database > Disconnect** action to disconnect from the database and select the **Keep database schema in cache until bot finishes running** option.

Previously, during the second loop iteration, the action picked up data from the previous loop.

When exporting data to Excel CSV files, Boolean values return accurately. Previously, a bug caused values to return as -1 while using OLE DB Driver for SQL Server (version 18 or later).

Service Cloud case ID: 01826530

Updating the Bot Agent version sometimes failed. However, when you select the **Automatically update all bot agents** option, the Bot Agent updates to the latest version without failures.

Control Room now supports Windows NT in French.

Service Cloud case ID: 00682337

All `DELETE /v1/configurations` endpoints are not accessible anymore.

Service Cloud case ID: 01920980

While installing Automation 360 on a three-node cluster, the installer prompts you to enter the **Elasticsearch** password for the first node only and replicates this data across the other two nodes.

Bots that are running for longer duration display correctly on the **Activity > In progress** page. Previously, these bots displayed only after bot updates and were removed after the page refresh.

Service Cloud case ID: 01921149, 01839276, 01919244

Limitations

<p>When you check out bots in bulk, you cannot check out the bots for which you have the required permissions. This is because bots for which you have the required permissions are also excluded along with the bots for which you do not have the required permissions.</p>
<p>The bot checkout fails in the following scenarios:</p> <ul style="list-style-type: none"> • If a bot with same name (but different case) exists in your private workspace with the same path. <hr/> <p>Note: In such cases, the bot checkout or overwrite fails even when an overwrite confirmation message displays.</p> <hr/> <ul style="list-style-type: none"> • If a folder with the same name exists in your private workspace with the same path.
<p>We use a third-party parser to convert from HTML format to plain text. As a result, when you convert an email from HTML format to plain text, you will see that, sometimes, the text is not converted into plain text and is not displayed in the correct format. For example, you might see that some lines are added or skipped.</p> <p>Service Cloud case ID: 01822614</p>
<p>In any package, when you select the Add argument option, select String or Number as the Argument type, and then try to insert a value, you might not be able to navigate through the options using the scroll functionality.</p>
<p>When you use the System > Get environment variable action to select the list of environment variables to return the system parameters of the device, some environment variables might not be visible.</p>
<p>After you upgrade to Automation 360 v.27, if a new package (first version) is added to the Control Room and in the setting for packages you selected Disable for the new version of package, you will see that the package will have status as Enabled and set as default instead of Disable.</p>

Limitations from previous releases
<p>When you run a bot in the Google Chrome or Microsoft Edge browser, use the If, Loop, or Wait action, select the webpage from the list of active tabs in the Browser tab, close the browser window, and then run the bot, the bot might take two minutes to open the webpage in the browser irrespective of the timeout value mentioned.</p> <p>Workaround: Move the If, Loop, or Wait action inside the If block and use the Application is running condition with same browser application to check whether the browser is running.</p>
<p>You will encounter an error when you run a standard workflow in the SAP BAPI package.</p> <p>Workaround: To execute SAP BAPI, use the Run Function call (RFC) with a combination of Create function, Set or Get field value, Set or Get structure, and Set or Get table actions.</p> <p><i>A360 : SAP BAPI functions - Run Standard Workflow - Error while selecting BAPI_SALESORDER_CHANGE (A-people login required)</i></p>

Limitations from previous releases

When you migrate a bot that contains **XML command > Get single node**, after migration, the bot encounters the following error: No node found at XPath while executing the Get Single node command.
Workaround: If the XPath expression is not starting with (/) , apply XPath starting with "/" so that at the time of execution, the modification can be skipped or the XPath expression can be designed to get the desired result.

When you use the **Capture** action with the Recorder package (version 2.9.x or earlier) to navigate to another web page in the Google Chrome browser (version 105.0 or later), and then use another **Capture** action to automate objects in the navigated web page, the bot might encounter an error.

Workaround: Before you use the **Recorder > Capture** action in the bot, maximize the Google Chrome window .

When you use the If package, add a specific condition with a variable, then add specific conditions within a group, save the bot, and if you rename the variable that was used, the name of the variable might not update for the **Group** conditions but is only updated for the conditions in the **Condition** tab.

Command prompt API allows you to switch the device registration even if the **Allow devices (single user) to be switched to another Control Room without reinstalling bot agent** option is disabled.

Updates to the interface

RPA Workspace

The **Max auto retry attempt** option is added to reprocess the failed WLM work items automatically.

The screenshot shows the 'Create queue' dialog box with the following settings:

- Name:** Auto-retry-q1
- Queue name:** Auto-retry-q1
- Reaction Threshold:** 1
- Max auto retry attempt:** 2 (highlighted)
- Time it takes for a person to complete 1 work item (optional):** 1 seconds

Automated reprocessing of failed WLM work items

RPA Workspace
 The drop-down menu in the Bot editor now includes an option to open a menu for keyboard shortcuts.

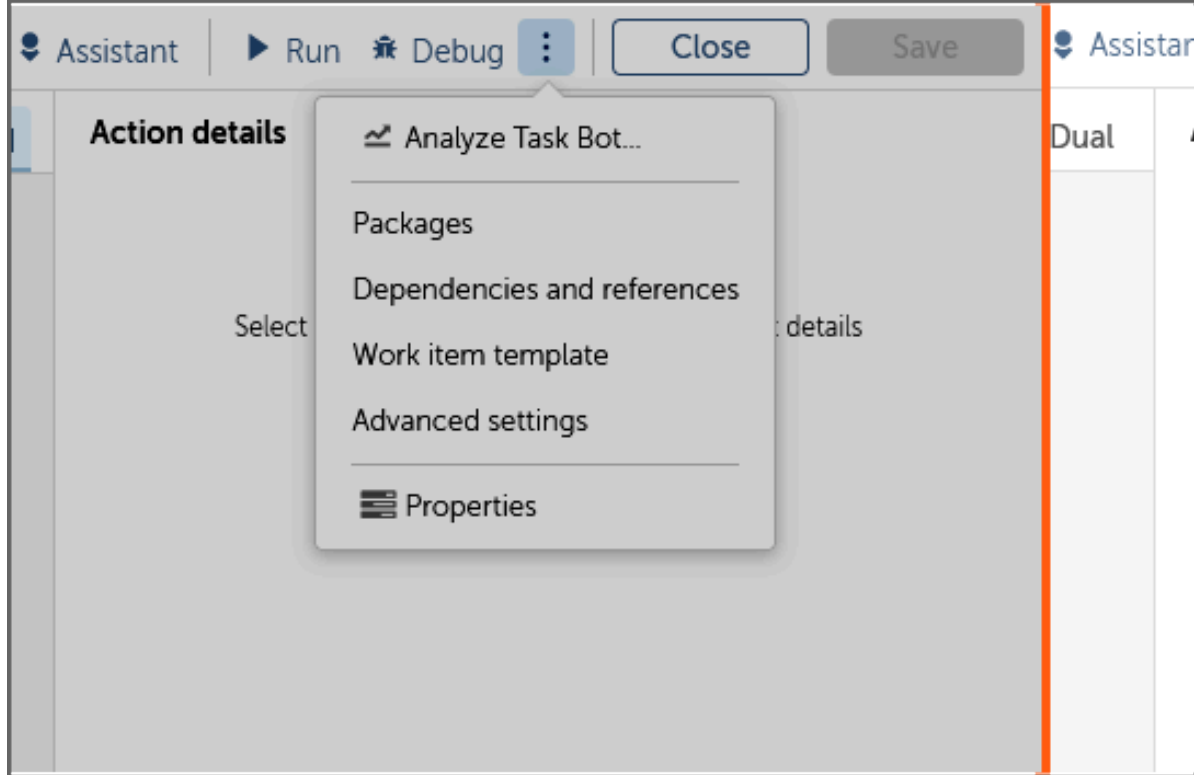

Keyboard shortcuts

The **Device(s) from my device pools** and **Run as users default device(s)** options are added in the **Edit the device(s)** permission to manage registered and non-registered devices.

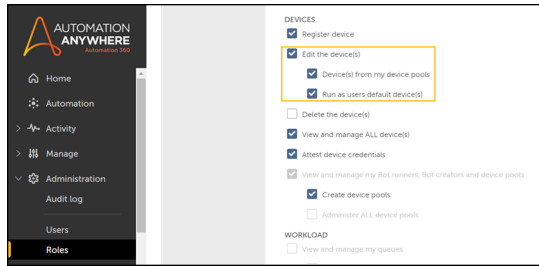

Better device management with improved device permissions

RPA Workspace

The gMSA option enables you to manage your domain accounts across multiple servers.

Service Credentials
Control Room windows service credentials

Local System Account

User Name:
[mydomain]ellie.brown
For eg. Domain\Username

Password:
[.....]

Confirm password:
[.....]

InstallShield

< Back **Next >** Cancel

Service Credentials
Control Room windows service credentials

Local System Account
 Use a Group Managed Service Account

User Name:
[mydomain]ellie.brown
For eg. Domain\Username

Password:
[.....]

Confirm password:
[.....]

InstallShield

< Back **Next >** Cancel

Manage domain accounts using gMSA

The **Custom number of bot runners** option allows you to choose the number of Bot Runners that you want to use to run

Schedule bot

Schedule ✔

Bot and dependencies ✔

Name
• Browser

Version
• 1

Run as ✔

Run As selected (1)

Device pools ✔

General ✔

Name
• Browser.22.11.15.12.50.46...

Automation priority
• Medium

Bot runners

If a selected 'Run-as user' does not have a bot running device, a device pool must be selected on the next tab to continue.

Search

Available bot runners (0)

<input type="checkbox"/>	Username ↑	Device	Status
<input type="checkbox"/>	santhosh.v-migration	Picked at r	

Selected (1)

<input type="checkbox"/>	Username ↑	Device
<input type="checkbox"/>	santhosh.v-migration	Picked at r

Define number of bot runners to use

All bot runners Custom number of bot runners

Select the number of users you want to use as bot runners while running the schedule

bots.

Customize the number of Bot Runners

RPA Workspace

Updated and intuitive icons for all the actions and contextual help for Database and Email actions.

DB-example-bot ✓ Saved

Actions

Search actions

- Move
- Reply
- Save all attachments
- Save attachments
- Save email
- Send

▼ Error handler

- Try
- Catch
- Finally
- Throw

▼ Excel advanced

- Access password protected ...
- Append workbook
- Append worksheet
- Close
- Convert excel to PDF
- Create workbook

Triggers Show

Triggers

Drag a trigger here...

Start

1. Database: Connect

to [redacted] in ses...

End

Database: Co

Connects to a d

Required bot ag

Session name

Default

Connection m

Default

Connection

Enter t

Select

Cred

Enhanced user experience through intuitive icons | Quick assistance at hand for the developers in the Bot editor

RPA Workspace

The drop-down menu in the Bot editor now includes the **Capture and run with admin privileges** option that enables you to capture objects on applications running in administrator mode.

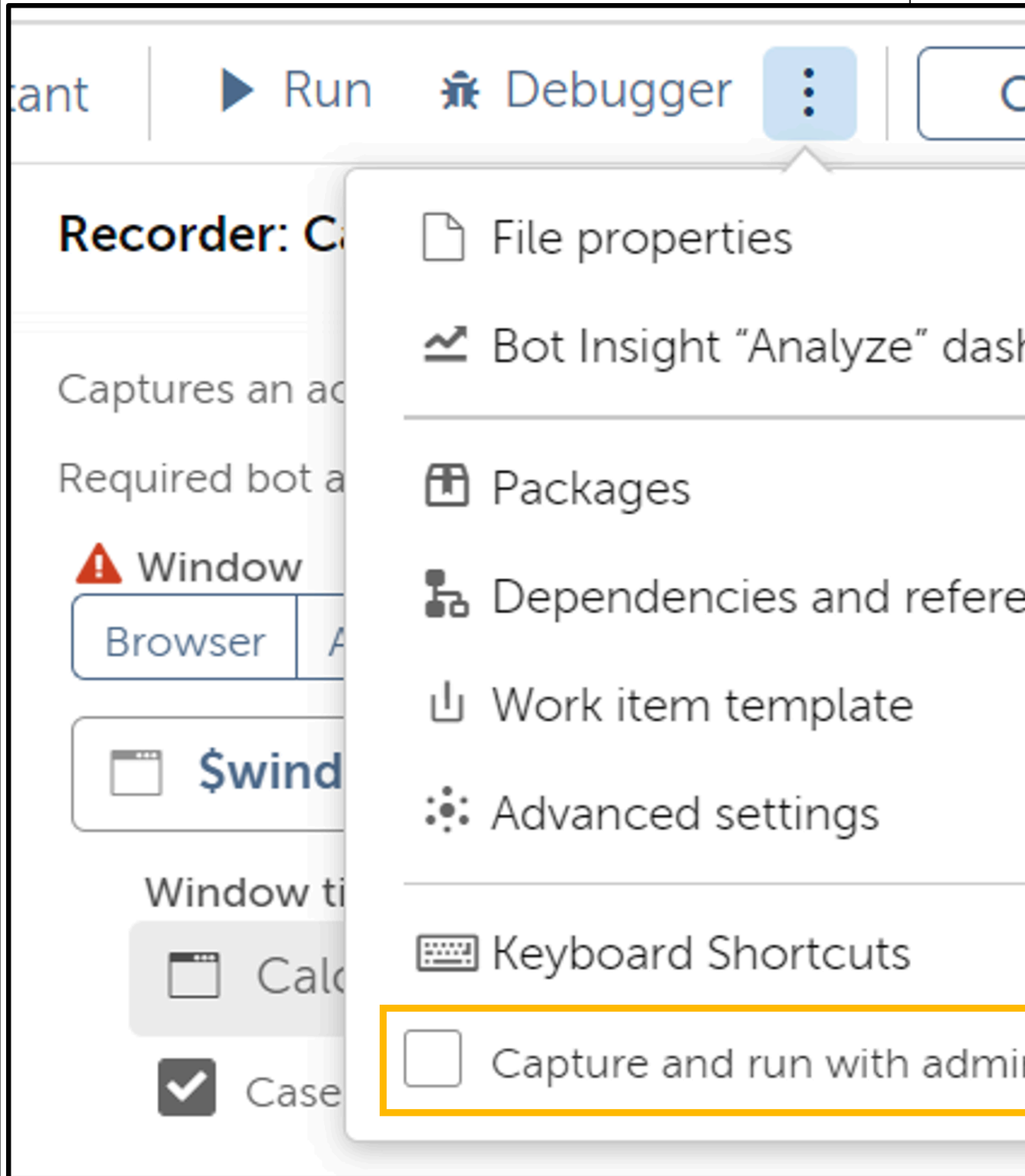

Capture objects in admin mode

Related reference[Automation 360 v.27 Release Notes](#)[Process Discovery v.27 release](#)

Review what's new in Process Discovery for the v.27 release.

[AARI v.27 release](#)

Review what's new and changed, and the fixes and limitations in AARI for the v.27 release.

[IQ Bot and Document Automation v.27 release](#)

Review what's new and changed, and the fixes and limitations in IQ Bot and Document Automation for the v.27 release.

[Bot Insight v.27 release](#)

Review the fixes in Bot Insight for the v.27 release.

[Packages updated in v.27](#)

Review updates to the packages in Automation 360 v.27, including the compatible Control Room and Bot Agent versions.

[Updating to v.27 release](#)

Review requirements and support information about updating your Control Room and Bot Agent for the v.27 release.

[Migration updates for v.27 release](#)

Review what's new, changed, and the fixes and limitations to migrating from Enterprise 11 and 10 versions to Automation 360 v.27.

[Enhancements to browser extensions](#)

Create automation from supported browsers by using browser extensions. Extensions are periodically updated to support feature enhancements and fixes. Therefore, ensure that you have the latest versions of extensions for the Google Chrome, Microsoft Edge, and Mozilla Firefox browsers.

Updating to v.27 release

Review requirements and support information about updating your Control Room and Bot Agent for the v.27 release.

Bot Agent updates

Bot agent update: This release includes an **optional** Bot Agent update. You can continue to run your existing bots without updating the Bot Agent. However, if you want to use the new features in Automation 360 v.27, you must update the Bot Agent available with this release.

For more information on updating to this release, see these resources:

- [Automatically update the Bot Agent | Manually update the Bot Agent](#)
- [Compatibility with Automation 360 builds](#)

Certified Control Room builds for direct update

You can update to the latest version of Automation 360 from the previous three releases (that is, from $n-3$ releases, where n refers to the latest release).

The following previous releases are certified for update to Automation 360 v.27:

- v26 (Build 15450)
- v.25 (Build 15112)

- v.24 (Build 12350)

If you are on one of these previous releases, for information about updating, see [Update to latest Automation 360 version](#). If you are not on an n-3 release, update Automation 360 to one of the n-3 releases before updating to Automation 360 v.27.

Related reference

[Automation 360 v.27 Release Notes](#)

[RPA Workspace v.27 release](#)

Review what's new and changed, and the fixes and limitations in RPA Workspace for the v.27 release.

[Packages updated in v.27](#)

Review updates to the packages in Automation 360 v.27, including the compatible Control Room and Bot Agent versions.

Packages updated in v.27

Review updates to the packages in Automation 360 v.27, including the compatible Control Room and Bot Agent versions.

The following table lists the updates in the packages for this release:

Note: For information about packages related to previous releases, see the PDFs for these releases: [Automation 360 previous release versions](#).

Package	Updates version
Web	20221026-170013 later
Directory	20221027-064844 later <i>New feature</i> <i>Defect fix</i>
or	20220615-020937 later
Integration	20220616-123118 later
Fix*	20211014-042725 later
Fix*	20220919-050851 later

**Botting
Agents
version**

~~2022~~ 20221020-152650

*New
feature*
Migration
later

- *New
feature
2*
- *New
feature
3*
- *Defect
fix
1*
- *Defect
fix
2*
- *Defect
fix
3*
- *Defect
fix
4*
- *Defect
fix
5*
- *Defect
fix
6*

~~2022~~ 20221104-153650

feature
later

~~2022~~ 20220923-115005

*fix**
later

~~2022~~ 20221104-153650

*fix**
later

~~2022~~ 20220930-120805

*fix**
or
later

~~2022~~ 20221025-092104

*fix**
later

Bottinge
Agentes
version

~~DISCONTINUED~~ 20221119-112148

New
or *feature*
later

- *New*
feature
2
- *Defect*
fix
1
- *Defect*
fix
2
- *Defect*
fix
3

~~DISCONTINUED~~ 20220920-155212

table
later

~~DISCONTINUED~~ 20220919-051216

feature
later

~~DISCONTINUED~~ 20220926-132853

*fix**
later

~~DISCONTINUED~~ 20220929-153817

or
later

~~DISCONTINUED~~ 20221027-124401

feature
later

~~DISCONTINUED~~ 20221223-075522

*fix*traction
later

Bottinge
Agendes
version

~~FIXED~~ 20221006-075826

New
or *feature*
later

- *New feature 2*
- *New feature 3*
- *Defect fix 1*
- *Defect fix 2*
- *Defect fix 3*

~~FIXED~~ 20221006-095506

bugger
later

~~FIXED~~ 20220929-040735

bandler
later

~~FIXED~~ 20220919-135308

advanced
later

~~FIXED~~ 20220919-135307

basic
later

~~FIXED~~ 20221003-160340

Defect
or *fix*
later

- *Defect fix 2*
- *Defect fix 3*

~~FIXED~~ 20221014-182105

bird
later

~~FIXED~~ 20221003-160340

*fix**
later

~~Bottinge~~
~~Agendes~~
version

~~20221006-182804~~
FTP
later

~~20221006-182804~~
or
later

~~20221006-143939~~
Calendar
later

~~20221006-142241~~
Drive
later

~~20220616-091303~~
Document
later

~~20221006-123001~~
sheets
later

~~20220416-235104~~
Gr
later

~~20220715-220729~~
key

~~20220928-201537~~
fix*
later

~~20221025-190453~~
fix*
later

~~20221014-074409~~
New
forms
later

- *New feature 2*
- *New feature 3*
- *New feature 4*
- *New feature 5*

Bottinge	Agendes	version
DEFE	1.5.1	20221122-181213
	Trigger	later
DEFE	1.5.1	20221107-102303
	Bot	later
DEFE	1.5.1	20221107-101937
	Bot	later
	processor	
DEFE	1.5.1	20220620-094839
	or	later
DEFE	1.5.1	20221003-172422
	Bot*	later
DEFE	1.5.1	20221019-100134
	AI Sense	later
DEFE	1.5.1	20221027-080331
	Automation	later
	<i>Defect fix</i>	
DEFE	1.5.1	20220919-103920
	Bot*	later
DEFE	1.5.1	20220416-233918
	Bot	later
DEFE	1.5.1	20220928-191723
	Bot*	later
DEFE	1.5.1	20220416-233919
	Bot	later
DEFE	1.5.1	20221021-043050
	Bot*	later
DEFE	1.5.1	20220928-104414
	Bot*	later

**Botting
Agentes
version**

~~202103~~ 20220502-204318
or
later

~~202101~~ 20221006-064900
~~665~~
later

~~202101~~ 20221006-064900
~~665~~
later

~~202101~~ 20221006-064900
~~665~~
later

~~202103~~ 20221012-090203
later
later

- *Defect
fix
2*

~~202105~~ 20220118-154220
or
later

~~202101~~ 20220416-234250
or
later

~~202101~~ 20220421-071315
bound
later

~~202101~~ 20220118-154256
or
later

~~202101~~ 20220118-154818
trigger
later

~~202105~~ 20221024-185703
Discovery
later

~~202101~~ 20220118-154257
or
later

~~202101~~ 20221101-070548
script
later

~~BUG~~ ~~20220919-051027~~
Bottinge
Agendes
version
 later

~~BUG~~ ~~20221122-181034~~
New
 or *feature*
 later

- *New*
feature
 2
- *Defect*
fix

~~BUG~~ ~~20220926-070217~~
Web
Service
 later

~~BUG~~ ~~20220725-133902~~
 or
 later

~~BUG~~ ~~20221021-121957~~
fix*
 later

~~BUG~~ ~~20220424-053247~~
BAPI
 later

~~BUG~~ ~~20220426-033753~~
 or
 later

~~BUG~~ ~~20220930-121118~~
fix*
 later

~~BUG~~ ~~20220425-083711~~
trigger
 later

~~BUG~~ ~~2022021010-154249~~
feature
 later

~~BUG~~ ~~20221021-090235~~
New
 or *feature*
 later

- *Defect*
fix

~~BUG~~ ~~20220419-063009~~
 or
 later

Bottinge	Agendes	version
W3501	20221025-092212	Web Interface
W3501	20220929-044740	fix* later
W3501	20221006-094641	or <i>feature</i> later Defect fix*
W3501	20220921-062556	fix* later
W3501	20221020-114450	fix* later
W3501	20220923-172123	Simulator later
W3501	20221004-130231	<i>feature</i> later
W3501	20220715-220725	top later
W3501	20220707-062607	Task later
W3501	20221020-051711	fix* later
W3501	20221003-160840	fix* later
W3501	20220923-081314	fix* later
W3501	20220118-154823	trigger later
W3501	20220512-164301	or later

Botting Agent version

~~NOTE~~ 20221025-092212

OK*
later

**These fixes are minor, internal updates, so they do not include an update or further details on our documentation site. As these updates relate to improvements in security, resiliency, and efficiency, we recommend that you use the latest package versions to include these updates in your existing bots.*

Related reference

[Updating to v.27 release](#)

Review requirements and support information about updating your Control Room and Bot Agent for the v.27 release.

[RPA Workspace v.27 release](#)

Review what's new and changed, and the fixes and limitations in RPA Workspace for the v.27 release.

[Automation 360 v.27 Release Notes](#)

Migration updates for v.27 release

Review what's new, changed, and the fixes and limitations to migrating from Enterprise 11 and 10 versions to Automation 360 v.27.

What's new

Enterprise 11 and Enterprise 10

Scan Automation 360 bots that use Basic authentication in Email action

This release introduces an option to use the Bot Scanner to scan all Automation 360 bots and identifies those that use Basic authentication in the Email package and Email trigger action so that you do not have to identify them manually.

You can use the Bot Scanner report to analyze the impact to the bots due to the Basic authentication and the estimated effort required to switch the authentication mode from Basic to OAuth 2.0.

For more information, see [Scan Automation 360 bots for Email action with Basic authentication usage | Basic authentication scanning messages](#)

Enterprise 11 and Enterprise 10**Variables created automatically after migration**

In the Bot Scanner utility, bots that contain the following non-referenced system variables are no longer flagged as **Action Required** or **Review Required**:

- \$Excel Column\$
- \$Filedata Column\$
- \$Dataset Column\$
- \$Table Column\$
- \$XML Data Node\$
- \$PDFTitle\$
- \$PDFSubject\$
- \$PDFFileName\$
- \$PDFAuthor\$

After migration, the system automatically creates these variables based on the Automation 360 naming convention, and the migrated bots run successfully.

Support for SMTP server type with Send Email command

When you migrate bots with the Send Email command, you can select the **Use outgoing Email server settings** option in the Bot Migration Wizard to identify and select the server type for the Enterprise 11 bots. You can configure required server details using a new SMTP server type option.

See [Migrate Enterprise bots](#).

Improved automated editing ability for legacy bots

When you migrated legacy bots that contained the Log To File command, the Carriage Return and Line Feed (**CRLF**) characters were converted to LF characters automatically. In Automation 360, the text is displayed in a single line with no line feed, whereas in Enterprise 11, the CRLF is added at the end of each line as a line feed. As a result, you had to add the **\$String:Newline\$** variable to insert a CRLF in the migrated bot.

The new **Convert \n characters to \r\n Log to File action** option in the Bot Migration Wizard enables you to add a new CRLF automatically to migrated bots and avoid manual edits. Migrated bots that use the Log To File sub-commands to log files can use the CRLF characters in a string.

See [Migrate Enterprise bots](#)

Enterprise 11 only**Migration enhancement to packages and actions**

- When you migrate Enterprise 11 bots with variables whose values are read from a text file, the system adds the **String: Import string from text file** subcommand to import the variables from the text file into a string variable. As a result, extra lines are added in the migrated bots.

The **Read variables** action has been added in the Text filepackage to address the extra lines.

You can use this action to read the values of all variables in a text file as a single line in a migrated bot which simplifies the post-migration efforts and reduces the number of lines added in a migrated bot.

See [Read variables action](#)

- Microsoft is removing the capability to use Basic authentication in Exchange Online for the following protocols:
 - RPC
 - MAPI
 - Offline Address Book (OAB)
 - Exchange Web Services (EWS)
 - POP
 - IMAP
 - Exchange ActiveSync (EAS)
 - PowerShell

For those customers running bot for Email automation that connect to Exchange Online using the IMAP, POP3, or EWS protocol with Basic authentication, we have added authentication options to support **OAuth2** authentication.

You can migrate Enterprise 11 botswith the authentication type set to the **OAuth2** option with **Authorization code with PKCE** or **Client credentials**.

- In the **Read from** action of the Database package, the following option is introduced: **Don't create file if no data is found**. This option is selected by default for migrated bots with the Database package, and the migrated bots now follow the same behavior as Enterprise 11. If the executed SQL query does not return any data, the behavior is as follows:
 - If this option is selected, no CSV file is created.
 - If this option is not selected, a 0 KB CSV file is created.

For more information, see [Using the Read from action](#).

- Migrated bots support the newly added **Return** key in the **Simulate Keystrokes > Keystrokes** action. These bots will continue to display the **Enter** key (which has been renamed to **Num Enter**) and the newly added **Return** key.
- Migrated bots support access to the Datetime global variable across all actions in the Datetime commands.

You can successfully migrate TaskBots that contain references to multiple MetaBots which include DLLs with same name. The session name of the first DLL is created using the name of the DLL. When the subsequent DLL with the same name from another MetaBot is migrated, the ID of the folder in which the DLL resides is used as a session name.

For example: `M_DLL_Session-<MetabotFolderId>_<DLLName>`.

Fixes

<p>After migration, bots that are using Visual Basic script or JavaScript in the Run Script legacy automation action and using multiple parameters that include spaces without quotation marks will now display the correct output after execution.</p> <p>Previously, such bots were displaying incorrect output.</p> <p>Service Cloud case ID: 01901882</p>
<p>An error no longer occurs during migration when the Select Query bot runs validation. Previously, the following error randomly occurred with text drivers.</p> <p>[Microsoft][ODBC Text Driver] Object invalid or no longer set.</p>
<p>After migrating to Automation 360, if the Application window does not exist for the bots that use the If, IF/ELSE, or Loop in Windows control, then these bots no longer encounter errors during bot run.</p> <p>Service Cloud case ID: 01846262</p>
<p>The Stored Procedure parameters are set correctly with Nvarchar when you migrate bots to Automation 360.</p>
<p>When a bot that contained the File and Folder loop was migrated to Automation 360, an error was displayed if the corresponding folder did not exist. You can migrate such bots like the corresponding legacy bot as the If condition is now added before the File and Folder loop to check if the folder exists.</p>
<p>You can migrate bots that contain the Substring command from the String package to Automation 360, even if the optional Length attribute is blank.</p>
<p>When you migrate a bot that has \$counter variable within a nested loop to Automation 360, the child loop counter is now set to the parent loop counter and the child loop iteration is processed correctly.</p>
<p>When you run a Select query inside a Loop package, and you reiterate its result set further, the resultant Loop now reiterates the latest record as expected.</p> <p>Service Cloud case ID: 01799961</p>
<p>You can successfully migrate bots that have the Wait for object to exist value option set to 0 seconds in the Object Cloning command.</p>
<p>When you use the Run Logic command with an IF/ELSE condition that uses a Credential variable, all credential variables migrate successfully.</p>
<p>When you migrate Enterprise 11 bots with string variables that have static values, variable parsing through legacy expressions is no longer performed. This avoids unnecessary parse expressions from being added to the migrated bots.</p> <p>Service Cloud case ID: 01819830</p>
<p>You can successfully run migrated bots that contain multiple Clipboard variables as an output. Automation 360 adds the Clipboard:Copy to action after every variable so that migrated bot is run properly.</p> <p>Service Cloud case ID: 01815938</p>

When you run bots in unattended mode, if the **delay_user_profile_creation** feature flag is turned on, the Bot Agent will not create a Windows user folder before the user session is created.

Service Cloud case ID: 01810244

When you migrate Enterprise 11 bots that use the **Connect** action with the Terminal Emulator command, and if the **Hostname** field contains a Credential Variable, then the field is mapped correctly after migration.

Service Cloud case ID: 01861600

Limitations

In Enterprise 11, if bots were using certain keys (such as: Ctrl, Shift, Caps Lock, Num Lock, and so on) in the Insert Keystrokes command, the keys were reset when an error was encountered during the execution of child bots. However; after migration, these keys are not reset when an error is encountered during the execution of child bots. As a result, different output or behavior might occur during the execution of the other subsequent child bots or the main bot.

Service Cloud case ID: 00773679

When you migrate a bot that uses the **Send email** command and run the bot in Automation 360, the predefined placeholders in the email body are not replaced with their actual content.

For example:

```
Task Name: <taskname>
Repeat: <repeat>
Status: <status>
Last Run Time: <lastruntime>
```

Whereas when you run the bot in Enterprise 11 with these placeholders, the following output is generated:

```
Task Name: PLACEHOLDER_SEND.atmx
Repeat: Do not Repeat
Status: Failed
Last Run Time: 11/29/2022 13:04:22
```

Service Cloud case ID: 01908010

When you run a migrated bot with an XML package that contains an **Xpath** expression, the running bot might fail and generate this error message: No node found at XPath

This issue might occur for these specific scenarios:

- If the root element does not have a namespace, and the child element of the XML package has a default namespace.
- If there are more than one xmlns (the default XML namespace) defined in the XML document.

Service Cloud case ID: 01874203, 01798339

See [XML path is not working which works fine in Enterprise 11](#)

Updates to the interface

Migration
The Bots using Email action with Basic authentication option is added to the Bot Scanner to scan bots that use basic authentication in the Email package and Email

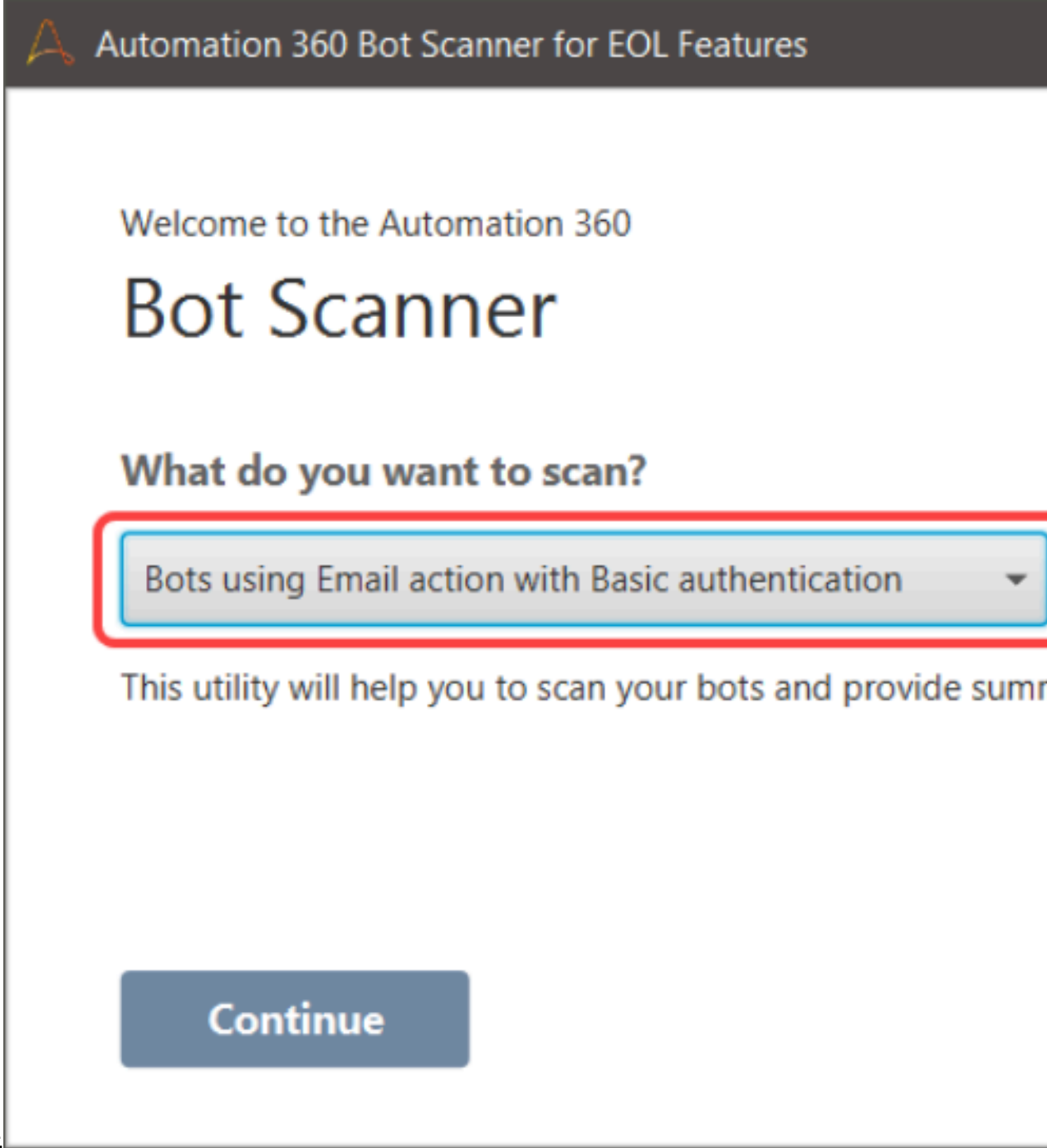

trigger.

Scan Automation 360 bots that use Basic authentication in Email action

Migration

The **Use outgoing Email server settings** option is added to the Bot Migration Wizard to specify the type of email server you use.

Migrate bots

Settings ✔

Name
• Migration.admin.23.01.04...

Description
• --

Bots ✔

• Bots selected (0)

Bot Runners ✔

Bots and Dependent Bots ○

Settings

Name Description (optional)

Maximum = 255 characters Maximum = 255 characters

Bot Migration settings

Overwrite if a bot with the same name exists

Exclude bot dependencies
If this option is selected, all the bot dependencies will be excluded while migrating.

Bot behaviour configuration

Use "Excel Cell Row" legacy behavior
If you are migrating from 11.3.0 and below, we recommend selecting this option.

Use outgoing Email server settings
If this option is selected, settings will be applicable to bots that contain send email action. You may need to update the global value if

SMTP email server

Server uses secure connection (SSL/TLS)

Server requires authentication

EWS email server

Include web services settings
This allows you to migrate along with the web services proxy host and port. If this value is selected, pre-created global values will be used by the bot for connecting with web services proxy.

Convert bots built using Internet Explorer to Edge with Internet Explorer mode
If you are migrating bots built on Internet Explorer, we recommend selecting this option to convert them to Edge with Internet Explorer mode.

Convert \n characters to \r\n in 'Log to File' action
This allows you to convert \n characters (LF) into \r\n characters (CRLF), which automatically take new line in bots using Log to File action.

Bot Insight configuration

Tag bots and variables for analytics
This allows you to tag bots and variables for analytics through Bot Insight. If you are not using Bot Insight in legacy bots, we recommend selecting this option.

Support for SMTP server type with Send Email command

Migration

The **Convert \n characters to \r\n** **Log to File action** option is added to the Bot Migration Wizard to provide you an option to not have to edit the bots manually and a new line is added automatically in migrated

Migrate bots

Settings ✓

- Name
- Description

Bots ✓

- Bots selected (0)

Bot Runners ✓

Bots and Dependent Bots ○

Settings

Name Maximum = 255 characters

Description Maximum = 255 characters

Bot Migration settings

Overwrite if a bot with the same name exists

Exclude bot dependencies
If this option is selected, all the bot dependencies will be excluded while migrating.

Bot behaviour configuration

Use "Excel Cell Row" legacy behavior
If you are migrating from 11.3.0 and below, we recommend selecting this option.

Use outgoing Email server settings
If this option is selected, settings will be applicable to bots that contain send email action. You may need to update the global value.

Include web services settings
This allows you to migrate along with the web services proxy host and port. If this value is selected, pre-created global values will be used for the bot for connecting with web services proxy.

Convert bots built using Internet Explorer to Edge with Internet Explorer mode
If you are migrating bots built on Internet Explorer, we recommend selecting this option to convert them to Edge with Internet Explorer mode.

Convert \n characters to \r\n in 'Log to File' action
This allows you to convert \n characters (LF) into \r\n characters (CRLF), which automatically take new line in bots using Log to File action.

Bot Insight configuration

Tag bots and variables for analytics
This allows you to tag bots and variables for analytics through Bot Insight. If you are not using Bot Insight in legacy bots, we recommend selecting this option.

bots.

Improved automated editing ability for legacy bots

Related reference

[Automation 360 v.27 Release Notes](#)

[RPA Workspace v.27 release](#)

Review what's new and changed, and the fixes and limitations in RPA Workspace for the v.27 release.

[Updating to v.27 release](#)

Review requirements and support information about updating your Control Room and Bot Agent for the v.27 release.

Process Discovery v.27 release

Review what's new in Process Discovery for the v.27 release.

What's new

PEG Serverless

With support of up to 100 simultaneous sensors, businesses can easily redact sensitive data at scale before the data is sent to the platform. Businesses can run data collection across multiple teams simultaneously, while still providing one interface for IT Admins to manage the configuration, and one interface for the business to review the redactions.

PEG Configuration UI

IT Admins can easily manage forwarding configurations, redaction configurations, and export logs from a web UI instead of having to run commands on the command line.

[Manage redaction and forwarding settings from the UI](#)

Related reference

[Automation 360 v.27 Release Notes](#)

[RPA Workspace v.27 release](#)

Review what's new and changed, and the fixes and limitations in RPA Workspace for the v.27 release.

[AARI v.27 release](#)

Review what's new and changed, and the fixes and limitations in AARI for the v.27 release.

[IQ Bot and Document Automation v.27 release](#)

Review what's new and changed, and the fixes and limitations in IQ Bot and Document Automation for the v.27 release.

[Bot Insight v.27 release](#)

Review the fixes in Bot Insight for the v.27 release.

[Packages updated in v.27](#)

Review updates to the packages in Automation 360 v.27, including the compatible Control Room and Bot Agent versions.

AARI v.27 release

Review what's new and changed, and the fixes and limitations in AARI for the v.27 release.

What's new

Smart embedded forms and dynamic data mapping for embedded widgets

You can now design your forms using a responsive and real-time canvas that can automatically adjust to the desired form size. This enables a faster way for you to create an embedded interface for use in any web application. You can also use these forms in your business applications to securely retrieve data when embedded as an iFrame widget.

To save time and eliminate data re-entry, you can use the postMessage API to map and pre-populate data from business applications in embedded widgets. Dynamic data mapping provides a safe and secure communication from your business (host) applications to the initial process forms in the widget.

[Smart embedded forms and dynamic data mapping](#)

Build forms easily by dragging elements to form builder

You can now build your forms by just dragging your elements to a blank form builder. As you add elements to the form builder, it automatically adjusts without your input, letting you focus on the form-building experience. You can also re-size the columns of your elements.

[Create a form](#)

Map data in host web applications for AARI Integrations

You can now map your host applications data to your AARI forms so that when you create a request, the initial form field will be automatically populated with the mapped data.

[Map host data to process](#)

URL parameters support for iFrame widget

You can use URL parameters to pass data types (date, time, number, and text box) through query parameters for your initial forms in the iFrame widget. Because the iFrame URL allows you to modify the URL to add data types, you can now directly populate data from a host application for form elements without having to keep re-entering the data.

[Deploy automations in web application](#) | [URL parameters](#)

Virtual window support for iFrame widget

You can now run your bots in a virtual window (picture-in-picture view) for AARI Integrations. With this option, you can run an attended bot in a small virtual window on your screen (instead of another desktop page or application) simultaneously while you complete tasks on the same page without obstructing your automation experience.

[Deploy automations in web application](#) | [Configure an AARI bot](#)

Select tags in widget setup

When you configure your widget in the **Integrations** page, the **Filter automations** option allows for you to select existing tags that can be added to your widget. You can now reference tags with the corresponding widgets in the **widgets** tab for easier reference in the **tags** column.

[Setup iFrame widget using AARI Integrations](#)

View status and run time details in automation list

You can now view the status and run time of your bots and processes in the automation list. The status and run time are based on your bots and processes last activities. You can quickly review whether a bot was completed in x amount of days or time ago, or shows no activity at all.

[Deploy automations in web application](#)

AARI shortcut link

You can now access AARI directly from your RPA Workspace. The **Explore AARI** link in the new **AARI** tab from the homepage is a shortcut that redirects you to the AARI portal. This is an easier way for you to access AARI if you forget how to access AARI or need to modify the URL to access AARI.

[Deploy processes](#)

New actions in the Process Composer

In the Process Composer, you can now use a set of actions when you build out your process. For example, you can double-click a task, such as **Bot Task** and **Human Task**, and the task will be updated in your process flow automatically. With this, you can save time because you do not need to task specific tasks to your process. In addition, you can now copy, cut, and paste using **CTRL + C**, **CTRL + X** and **CTRL + V**, respectively to retain, reuse, or replace data.

[Behaviors supported in the Process Composer](#) | [Create an AARI process](#)

Use a reference ID meta type in Process Composer

You can now use a reference ID with a **Meta** variable type for your variables in the Process Composer. When you set a reference ID as a meta variable type, you can now use your reference ID data when you run your tasks in the web interface. This simplifies your references because you only need to rely on using the reference ID instead of relying on other variable types or references.

[Create an AARI process](#)

Center your forms in preview

You can now preview your forms in the new preview window and get an accurate assessment on how your form will look when it is rendered. You can select the **Make form preview centered** option to enable the preview window. You can also set the appropriate display resolution, x and y coordinates, and even center your form.

[Create a form](#)

Upload images directly to the form composer

You can now upload images directly to the form composer by using the **Image** element. This saves you time to view the images in the form without a file reference, rather than in the initial step, where the image requires a file reference to be viewed.

[Using the Image element](#)

Change label action for Button element

The change label action in the form rules now applies to the **Button** element. When you use the change label action in form rules and apply it to the buttons in your form, the changes will be automatically applied to the buttons where you set the rules. This keeps the flow consistent with the elements that you are using because all the buttons inherit the same rule.

[Add rules to form elements](#)

Rules editor for Table element

The rules editor is now applicable to the **Table** element. When you use the rules editor for your tables, the rules conditions are applied for each individual columns while any actions that you set are applied for each row in the row level. This makes things consistent for each new or existing row that you use because all the rows inherit the same rule.

[Add rules to form elements](#)

What's changed

Define tags in process configuration

When you edit a process, you can use the **Tags** field to search and specify tags based on keywords, to define your process. You can add tags from new or existing tags and use them to reference specific tags related to your process.

[Configure an AARI process](#)

Fixes

You can now view signatures when you preview files using the AARI document viewer. Previously, signatures could be viewed only when files were opened in a separate tab. (Service Cloud case ID: 01879533)

Limitations

Updates to the interface

AARI

The form builder now automatically adjusts the size for each form element you drag into the canvas. The sizes can also be manually adjusted.

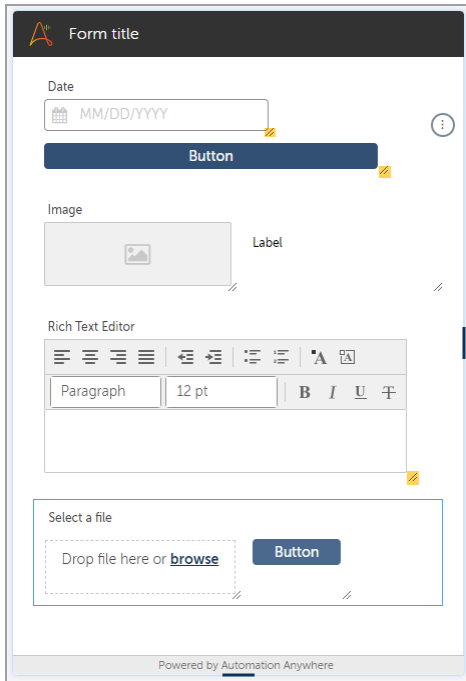

Build forms easily by dragging elements to form builder

The **Tags** field in the Edit Process page now has a drop-down menu for you to create new or select from existing tags.

The screenshot shows the "Edit Process: 35 - Returns" configuration page. The page has tabs for "General", "Teams", and "Deployment", with "General" selected. The "Process name" field contains "Returns" (Maximum 255 Characters). The "Description (Optional)" field is empty (Maximum 1024 Characters). The "Process key" field is empty (Enter 1-5 alphabetical characters. Once saved, the Process Key cannot be changed). The "Tags" field is highlighted with a red box and contains a dropdown menu with the following options: "Account" (checked), "Workspace" (checked), "Support", "Salesforce", "Workspace" (checked), "by user" (checked), and "by bot".

Define tags in process configuration

AARI

The **Filter automations** field in the Add Widget page has a drop-down menu for you to select existing tags.

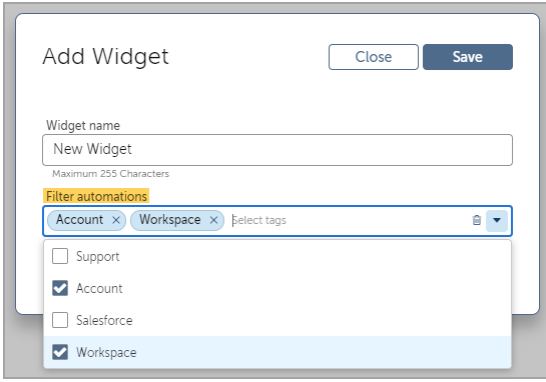

Select tags in widget setup

Related reference

[Automation 360 v.27 Release Notes](#)

[RPA Workspace v.27 release](#)

Review what's new and changed, and the fixes and limitations in RPA Workspace for the v.27 release.

[Process Discovery v.27 release](#)

Review what's new in Process Discovery for the v.27 release.

[IQ Bot and Document Automation v.27 release](#)

Review what's new and changed, and the fixes and limitations in IQ Bot and Document Automation for the v.27 release.

[Bot Insight v.27 release](#)

Review the fixes in Bot Insight for the v.27 release.

[Packages updated in v.27](#)

Review updates to the packages in Automation 360 v.27, including the compatible Control Room and Bot Agent versions.

IQ Bot and Document Automation v.27 release

Review what's new and changed, and the fixes and limitations in IQ Bot and Document Automation for the v.27 release.

Document Automation

What's new

Standard forms integrated with Document Automation

You can create and manage learning instances entirely within Document Automation. Previously, you had to create standard form learning instances in IQ Bot and then process them through the **Connect Learning Instance** feature in Document Automation. With standard forms integrated with Document Automation, you benefit by having an entire workflow consolidated into a single system.

Using Document Automation for Standard Forms.

<p>What's new</p>
<p>Support for Microsoft Form Recognizer v3.0 models in Document Automation</p> <p>Microsoft Form Recognizer v3.0 provides additional capabilities to the existing model creation, including options to select Template and Neural. While training a model, you can select either 2.1 or 3.0 version.</p>
<p>New Document Automation product licenses</p> <p>Document Automation now offers the following licenses to enable users to process documents and track metrics for learning instances in production:</p> <ul style="list-style-type: none"> • Document Automation Standard Forms (Number of pages): Required to create a model and process documents in a Standard form in Document Automation. • Document Automation 360 Extraction (Number of pages): Required to process documents in an Automation Anywhere (Pre-trained) model, including the User-defined document type. <p>Also, there are updates to license consumption tracking.</p> <p>License tracking release note</p>
<p>Extract data with Google Vision OCR</p> <p>If you are a user with a Cloud Control Room, you can process documents using Google Vision OCR technology by creating or updating a learning instance.</p>
<p>Improved table extraction in Automation Anywhere models</p> <p>You can use validation feedback to train a learning instance to extract data from a cell that contains more than one field.</p> <p>For example, if a product description column also includes item number, you can outline the item number in the Validation interface. When the learning instance processes subsequent documents, it will extract the item number and ignore the product description.</p> <p>Using validation feedback to extract specific values in a table</p>
<p>Visualize performance metrics with a new Document Automation widget</p> <p>You can view data visualizations on Validator user performance. This new widget is a horizontal bar chart that shows the weighted average time each Validator user spent performing manual validation per document.</p> <p>Document Workspace dashboard</p>
<p>Document Automation supports regular expression pattern-based extraction</p> <p>When configuring fields that the learning instance will extract, you can specify a regular expression (regex) pattern to help the extraction engine find the field. After entering the regex pattern you can test the expression using sample content within the Create Learning instance window. You can use regex pattern extraction for values that follow a specific pattern, such as a VAT number or a PO number.</p>
<p>Validation interface support for shortcut keys</p> <p>Zoom in and out on documents in the Validation interface by holding the Alt key and scrolling with your mouse wheel.</p>

What's changed
<p>The following updates impact how the Control Room tracks license consumption:</p> <ul style="list-style-type: none"> • The Control Room checks enough product licenses prior to deploying the bot. • The IQ Bot Pages license and the Standard Forms Pages license track documents that are processed through learning instances created in Automation 360 IQ Bot. This includes documents processed in the learning instance in Automation 360 IQ Bot and learning instances connected to Document Automation. • In the Licenses page, the Document AI license is called the Google Document AI (number of documents) • The Control Room also tracks documents processed in Google Document AI for users who brought their own license. Previously, the Control Room only tracked such documents for users who bought their licenses through Automation Anywhere.
<p>You can now configure Oracle Database with on-premises and Linux installations of Document Automation.</p>
<p>When you import a learning instance created in previous versions of Document Automation, the check box to send validation feedback to the system is now not selected by default. You must edit the learning instance to select the check box.</p>

Fixes
<p>The Bot Agent now clears out the resources folder after running actions from the Document Extraction package.</p>
<p>When you import a learning instance created in a previous version of Document Automation, the Improve accuracy using validation check box is now unselected by default.</p>
<p>Document Automation now correctly tracks license consumption in all On-Premises installations, irrespective of the port number.</p>
<p>You can now add formula validation to learning instances with the user-defined document type.</p>
<p>Standard forms in Document Automation is now supported in a fresh installation or upgraded multi-tenant Control Room. Previously, Standard forms in Document Automation was only supported on a fresh installation of a multi-tenant Control Room.</p>
<p>When you refresh the Validator page, the Validator displays the last document you worked on. Previously after a page refresh, the Validator sometimes displayed the first document you had validated.</p>

Limitations
<p>Standard forms only support unique field extraction for any document. If there are fields with the same name on multiple pages, then the document must be trained with different tag names in the model creation tool.</p> <p>For example, if there is a field named <code>date</code> on two different pages, then you must use <code>date1</code> and <code>date2</code> to make the tag names unique in the model creation tool for training.</p>
<p>You cannot use spaces in model names when you create models for Standard forms v3.0. If the model name contains any spaces, then an InvalidParameter error message is generated.</p>

Limitations
There is no average accuracy for standard forms v.3.0 from the Microsoft Azure Form Recognizer service. As a result, the standard forms training displays the average accuracy as 0.00% for the v.3.0 service.
When fetching a Standard Forms model, an incorrect error message displays when no configurations are available in Document Automation.
The resizing functionality is not working properly for the model list table. As a result, you cannot resize the table header or column in Standard Forms.
The run analysis result does not display in standard forms when creating a v.3.0 model with multipages.
There is a default character limit of 100 characters for the table name, and 155 characters for the field name of the table. However, if you reconfigure the table, you can add more characters than the default limit.
The System-Identified Regions (SIRs) for checkboxes or radio buttons are not generated for the standard forms v.3.0 model.
Standard forms is not supported on Linux.
Any re-mapping or re-drawing in the System-Identified Regions (SIRs) in the Validator results in detection of an incorrect check box. However, you can enter the check box value as checked or unchecked after changing the auto-generated mapping.
When migrating a learning instance from one Control Room to another, the same user must export and import the .dw file.
If the learning instance extracts data from a multi-line field and transfers it to a CSV file, an extra space is added at the end of each line.
When you mouse over data points in the "Average validation time" and "Validator performance by number of documents" widgets, the correct values do not immediately display in the pop-up window.
Document Automation prevents you from creating a learning instance if you create a custom table field without providing a field name and field label, even if you have unselected the field.
If you click Test regular expression and replace the value in the Regular expression field, the field now has a limit of 50 characters. Workaround: Click Cancel to leave the Test regular expression window and make the revisions in the Regular expression field.
The Table icon is not generated on the Form OCR Testing Tool (FOTT) for the Standard form v3.0 Model.
If a field name contains more than 100 characters, the scroll bar does not appear and you cannot see the value of the form field.
If a table name contains more than 50 characters, you cannot expand the table size. Additionally, the field name in the table does not display when you hover over it.
If you test an invalid Python script when configuring custom logic, the system returns an error message that contains the Python execution path.

Limitations
<p>Sometimes document extraction fails and one of the following error messages appear in the AARI request status: Extraction bot failed. Please check activity/audit logs for more detail OR Download bot failed. Please check activity/audit logs for more detail with this message in the audit log: Existing deployment in progress for this user session.</p> <p>If this happens, restart the Bot Agent on the impacted device.</p>
<p>The Document Workspace dashboard sometimes shows incorrect page consumption metrics if the Control Room is installed On-Premises.</p>
<p>Documents cannot be processed with Google Vision OCR if your proxy is configured with a Proxy Auto-Configuration (PAC) file.</p>
<p>When you create or edit a Learning Instance, if a field name starts with a numerical value, then the formula validation for that field fails. This issue applies to form fields and table fields.</p>

IQ Bot

What's changed
<p>If you are using an older version of Microsoft SQL Server that does not support TLS 1.2, then you must keep an IQ Bot database backup and update to a Microsoft SQL Server version that supports TLS 1.2.</p>
<p>IQ Bot now uses the latest version of Python (3.11.0) for custom logic validation. To use the latest version, you must upgrade from cx_Oracle 8.3 to python-oracledb. See Upgrading from cx_Oracle 8.3 to python-oracledb</p>

Fixes
<p>IQ Bot now performs post-processing on fields with Python custom logic that contain single quotation marks, such as <code>print('Test')</code>.</p>
<p>In IQ Bot, when a document is either corrupted, deleted, or is not loading in Validator or Designer, a placeholder image is displayed. The applications will not be consistent until you upload new documents.</p> <p>Service Cloud case ID: 00792976, 00835371</p>
<p>During the production process, you must not move the learning instances or bots from Staging to Production, or vice-versa.</p> <p>Service Cloud case ID: 01808931, 00821541, 01253373, 00836954, 01271722</p>
<p>When you upload any invalid document in manual or custom groups, then the document gets processed. However, the System Identified Region (SIR) will not be generated for the unsupported pages.</p> <p>Previously, when an invalid document was uploaded with a valid document and processed for extraction, the See extraction page kept loading.</p> <p>Service Cloud case ID: 01786098</p>

Fixes
In Healthcheck API, the output shows the proper branch name convention, for example: RC-A360.27. Previously, improper health information was displayed when the branch name convention was heads/RC-A360.27.
If an error or exception is encountered during document validation, the error or exception is processed, and the files are displayed consistent in the output. Service Cloud case ID: 00827940
The RabbitMQ log stores the error logs under the IQ Bot logs path and does not create an empty RabbitMQ folder.

Limitations
During the express installation upgrade of IQ Bot, an error message is shown in the installation steps. You must click OK to proceed further.
The maximum upload file size limit is set to 5 GB when importing and exporting files in the IQ Bot archive (IQBA) file. If the file size is greater than 5 GB, then you must delete unwanted groups to decrease the file size and migrate successfully.
If the IQ Bot archive (IQBA) file size is above 2,147,483,647 bits, then the File Storage does not upload the exported file from output folder to the desired location.

Updates to the interface

IQ Bot and Document Automation

The Create learning instance window now contains a drop-down menu to select an OCR provider.

Create Learning Instance

[Cancel](#)

⚠ Name

Description (optional)

Document Type

Language

Provider

OCR Provider

The system learns from user-provided changes in the Validator.

Extract data with Google Vision OCR

Related reference

[Automation 360 v.27 Release Notes](#)

[RPA Workspace v.27 release](#)

Review what's new and changed, and the fixes and limitations in RPA Workspace for the v.27 release.

[Process Discovery v.27 release](#)

Review what's new in Process Discovery for the v.27 release.

[AARI v.27 release](#)

Review what's new and changed, and the fixes and limitations in AARI for the v.27 release.

[Bot Insight v.27 release](#)

Review the fixes in Bot Insight for the v.27 release.

[Packages updated in v.27](#)

Review updates to the packages in Automation 360 v.27, including the compatible Control Room and Bot Agent versions.

Bot Insight v.27 release

Review the fixes in Bot Insight for the v.27 release.

Fixes

In the Bot Insight **Operations > Bots Dashboard**, the bot duration shows the correct data. Previously, there was a mismatch between the bot duration data and the manual calculation of the bot duration from the historical menu because of a start time mismatch.

Service Cloud case ID: 01796106

When you upgrade to Automation 360 v.27 and launch the Control Room, no kernel bootup failure occurs due to a failed Elasticsearch initialization. Thus, it does not show the `Bad Gateway` error. As a result, the Control Room service is available and you can access the Control Room URL.

Previously, Elasticsearch initialization failed during startup which was causing the kernel bootup failure. As a result, the Control Room service was showing the `Bad Gateway` error.

Service Cloud case ID: 01908667, 01919727, 01919309, 01911464, 01921747, 01926887, 01925309, 01924168, 01929814, 01930226, 01931125, 01925270, 01934212

Updates to the interface

Bot Insight

The Bot Insight user interface is changed as per Common Frontend Component (CFC) standards. Only the look and feel of the components (such as colors, fonts, icons, paddings, borders, buttons, and so on) is changed, while the underlying functionality remains the same. You can view these changes from the following user interface elements:

- All Bot Insight pages
- Table pagination position at the center of the page
- The **Create widget** dialog back drop with the **Close** button
- **Add Widget** title in the **Create widget** dialog
- The **Switch Widget** button position in the **Add widget** window for all charts

<https://aa2019packagesdkfordocumentation.s3-us-west-2.amazonaws.com/videos/bi-ui-changes.mp4>

Related reference

[Automation 360 v.27 Release Notes](#)

[RPA Workspace v.27 release](#)

Review what's new and changed, and the fixes and limitations in RPA Workspace for the v.27 release.

[Process Discovery v.27 release](#)

Review what's new in Process Discovery for the v.27 release.

[AARI v.27 release](#)

Review what's new and changed, and the fixes and limitations in AARI for the v.27 release.

[IQ Bot and Document Automation v.27 release](#)

Review what's new and changed, and the fixes and limitations in IQ Bot and Document Automation for the v.27 release.

[Packages updated in v.27](#)

Review updates to the packages in Automation 360 v.27, including the compatible Control Room and Bot Agent versions.

Automation 360 v.26 Release Notes

Release date: 6 October 2022

Review the top 5 features as well as other new features, enhancements, fixes, and limitations in the Automation 360 v.26 release. Automation 360 and IQ Bot are on Build 15450 (for Cloud and On-Premises).

We have released updated builds for fixes after the GA release of v.26 (Build 15436). For information about the fixes in these updated builds, see [Updated release builds](#).

Note: The release builds include Manifest V3 browser extensions for Google Chrome and Microsoft Edge browsers. For more information, see:

- [Chrome and Edge Manifest V3 extensions](#)
 - [Support for Manifest V3 extensions](#)
 - [Enhancements to browser extensions](#)
-

Highlights of this release

Here are the **top 5** features in the v.26 release:

Embedded automation with OAuth 2.0

Business users can directly access authorized automation from within their favorite business applications, without having to open a new interface or learn a new app. OAuth 2.0 enables seamless authentication across systems, reducing complexities of system-specific sign-ins.

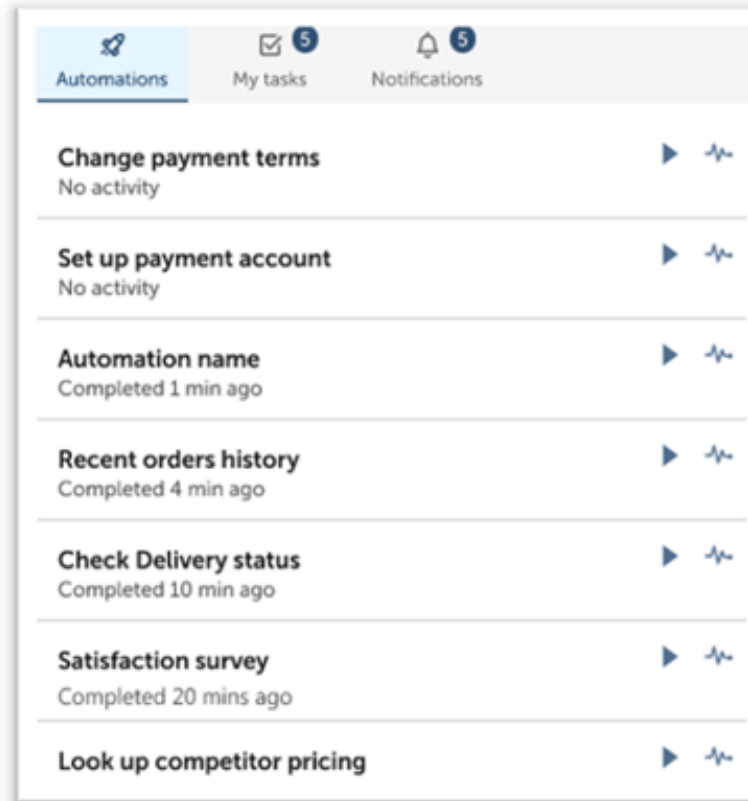

iFrame Widget
for web apps supporting
customization

Learn more: [Embedded Automation](#).

Coding standards through code analysis

Administrators can establish coding best practices by setting a code analysis policy and improve their team's code to quickly find and correct rule violations. They can select which rules to check for and enable summary reports for a snapshot of all bots within a project.

Bot builders can quickly check the status of their bots and receive feedback on what to fix, speeding up bot development and deployment and promoting coding best practices.

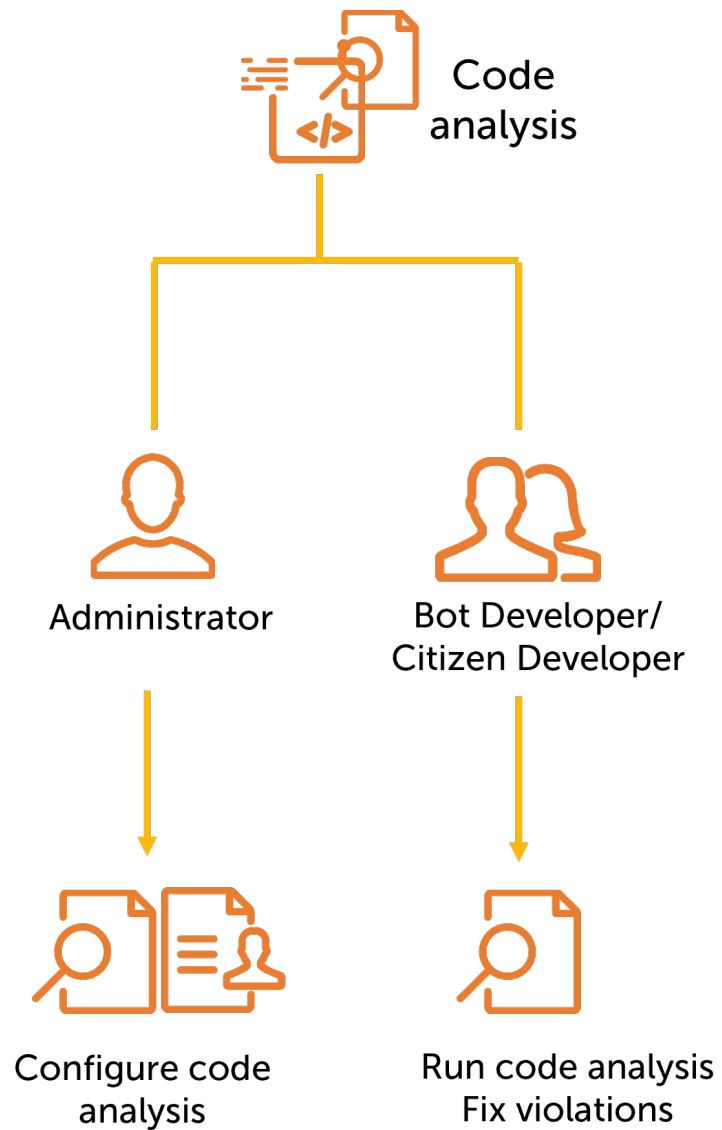

Learn more: [Code analysis](#).

Package role-based access (RBAC)

Administrators can tailor package access to the business needs and expertise of bot developers and enforce access policies for custom groups. They can maintain policy control and ensure confidence and ease-of-use for developers by providing group-based package access with clear policies.

Citizen developers can access simpler packages and build easy-to-complete automation, and professional developers can access a broader set of complex packages.

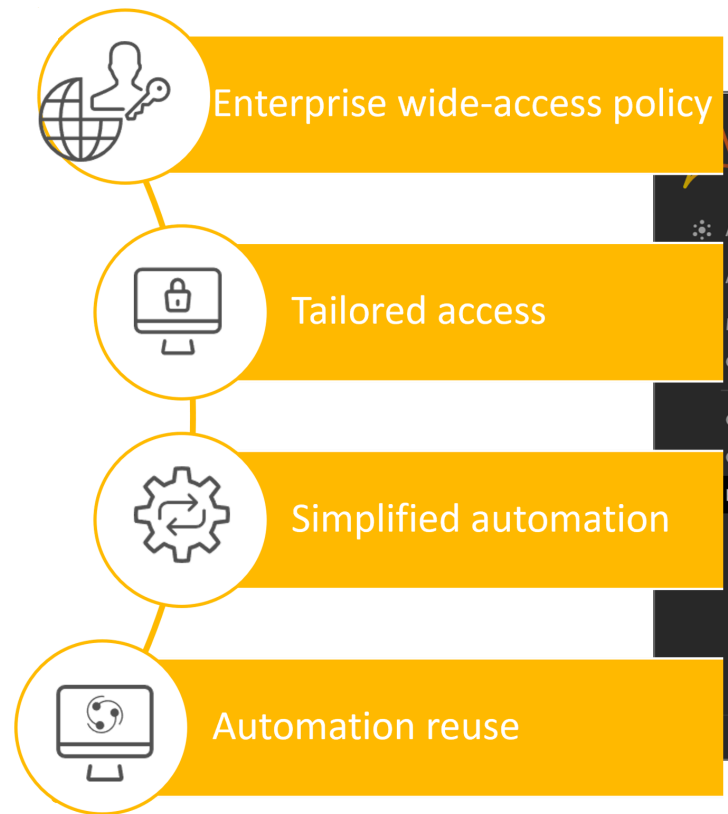

Salesforce integration with command package

Learn more: [RBAC on packages](#).

RPA developers can build robust integrations with Salesforce through direct API interaction. They can automate repetitive processes involving access and updates to Salesforce data, enabling business users to focus on high-value business tasks such as strategic planning and optimization. Commands available include authentication, database querying, record updates, and file processing.

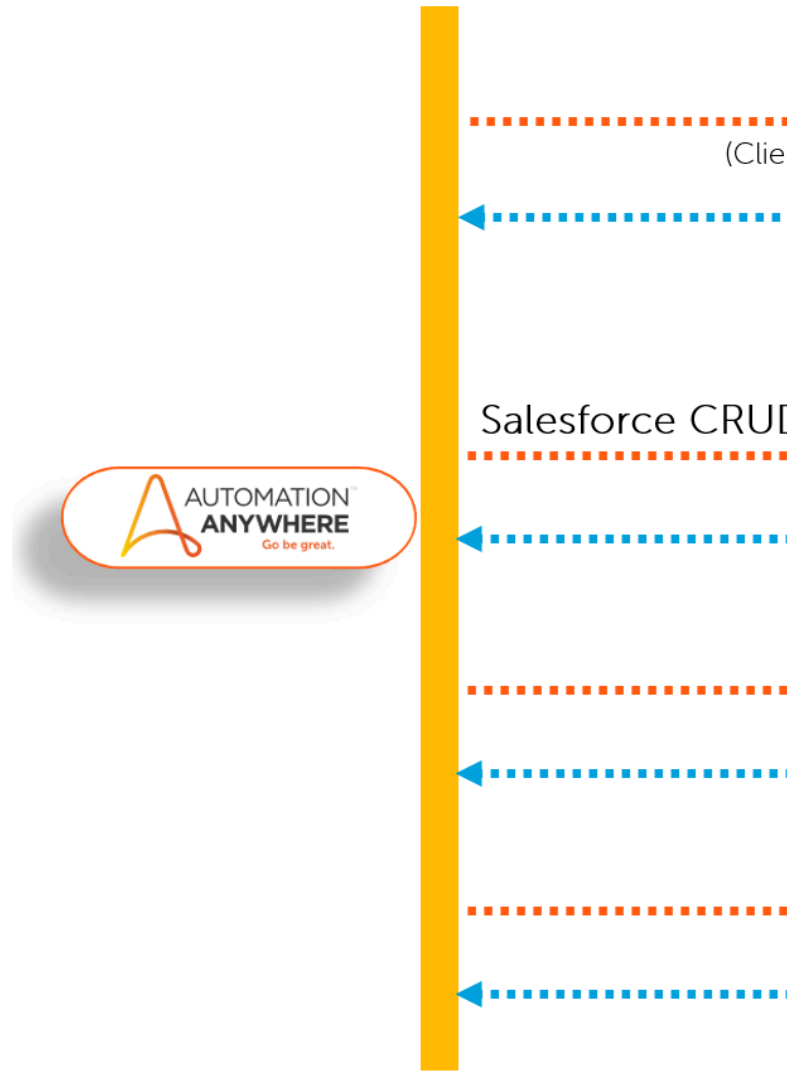

Automation 360 integration with Google Cloud Apigee

Learn more: [Salesforce package](#).

RPA developers can fast-track end-to-end automation development by combining API components from Apigee and RPA bots from Automation 360 to access any data in the enterprise. Our prebuilt integration packages make the integration seamless, enabling you to drive more value from reusing existing assets created by your organization's automation teams.

TV

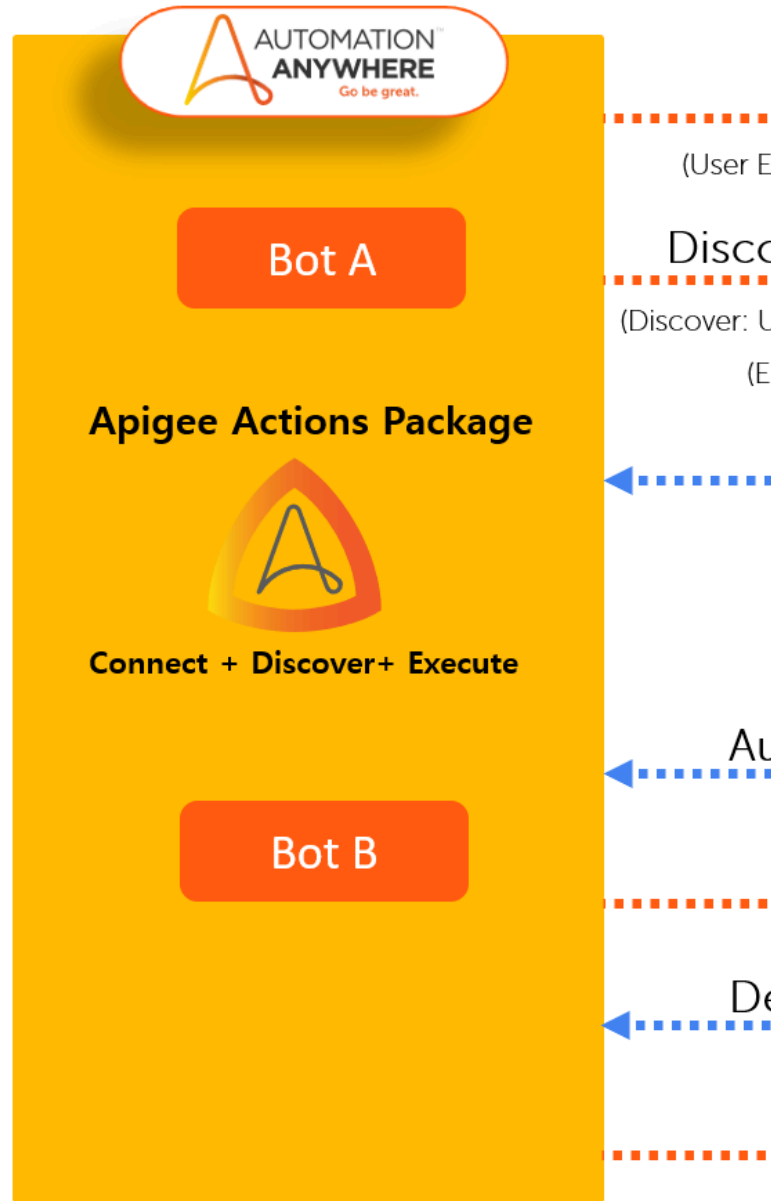

Learn more: [Apigee integration.](#)

Updated release builds

We have released the following updated builds:

- **Build 15450** with fixes for the following issues:
 - When you import a bot or file that is a manual dependency of other bots using the overwrite option, the import process no longer removes the dependencies from the other bots (Service Cloud case ID: 01911410, 01920508).
 - When you have large and complex bots with many dependencies and if the size of the deployment messages that are sent from the Control Room to the Bot Agent is more than 2 MB, the bots run successfully. (Service Cloud case ID: 01882630).
 - The following IQ Bot issues were fixed:
 - IQ Bot can now perform post-processing on a field if the custom logic uses Python script containing single quotes, such as `print('Test')`.
 - If your IQ Bot custom logic uses the `Pandas` library, the script no longer needs to have the `import Pandas` statement.
 - IQ Bot can now perform post-processing on a field if the custom logic uses Python script containing characters from non-Latin languages (Unicode characters), such as `äöüñ`.
 - Security fixes for Cross-Site Scripting (XSS) vulnerabilities (Service Cloud case ID: 01843148).
- **Build 15443 (for US-East and US-West regions only)** Service Cloud case ID: 01911410, 01920508

This build is updated to include a fix for the issue related to the manual dependency file that is shared between multiple parent bots upon export and import. If one of the child bot files is exported and imported into the Control Room with overwrite options in the import process, then links to the manual dependency are unlinked from other parent bots. Use Bot Agent version 21.222 for this issue.

- **Build 15439 (Japan region only)** Service Cloud case ID: 01911093, 01911209, 01911190, 01911116, 01911259

This build is updated to include a fix for the following issue: `Cannot retrieve values assigned to global values having Japanese characters after upgrading Automation 360.` Build 15439 is available for download for On-Premises customers who need this fix.

What's new and changed in each product

Go to the following pages for details on all the updates (what's new, changed, fixed, and limitations) in each product:

RPA Workspace <ul style="list-style-type: none"> • Updating to this release • Migration updates
AARI
IQ Bot and Document Automation
Bot Insight

Related concepts

[View package versions available in the Control Room](#)

Actions are grouped into version-specific packages. Bot Creators can select which package version to use for a specific bot.

Related reference[RPA Workspace v.26 release](#)

Review what's new and changed, fixes and limitations, and the feature deprecations in RPA Workspace for the v.26 release.

[AARI v.26 release](#)

Review what's new and changed and the fixes in AARI for the v.26 release.

[IQ Bot and Document Automation v.26 release](#)

Review what's new and changed, and the fixes and limitations in IQ Bot and Document Automation for the v.26 release.

[Bot Insight v.26 release](#)

Review what's changed and the limitations in Bot Insight for the v.26 release.

RPA Workspace v.26 release

Review what's new and changed, fixes and limitations, and the feature deprecations in RPA Workspace for the v.26 release.

What's new

Control Room, devices and Bot Agent

Microsoft Windows 11 Enterprise now supported (Service Cloud case ID: 01252605, 1252605, 1253745, 01255134, 01379865, 01801610, 01810148)

We now support Microsoft Windows 11 Enterprise, so you can now install and update the Bot Agent and run bots on the Windows 11 Enterprise operating system.

[Bot Agent compatibility](#)

Control Room, devices and Bot Agent**Support for Manifest V3 extensions**

Automations that use Google Chrome Manifest V2 based extensions will stop working sometime after June 2023. The deprecation timelines of Manifest V2 based extensions are currently under review and subject to change by Google.

- For Google Chrome Manifest V2 extensions timelines, see [Manifest V2 support timeline](#).
- For Microsoft Edge Manifest V2 extensions timelines, see [Overview and timelines for migrating to Manifest V3](#).

This might impact your existing automations that use Manifest V2 based extensions for Google Chrome and Microsoft Edge browsers. Automation 360 v.26 and later includes Manifest V3 extensions by default to support features that use Google Chrome and Microsoft Edge browsers.

You can automatically enable Manifest V3 based extensions for Google Chrome and Microsoft Edge on all the Bot Runner devices by enabling the **Browser extensions** option from the Control Room. Enabling this option applies the browser extension settings on all the registered Bot Agent devices.

Note: We will continue to support Manifest V2 based extensions for Google Chrome until June 2023. To know about Microsoft Edge Manifest V2 based extensions timelines, see [Overview and timelines for migrating to Manifest V3](#).

Note: Manifest V3 extension is supported on Google Chrome and Microsoft Edge browsers version 91 and later only.

[Customize browser extension settings](#) | [Chrome and Edge Manifest V3 extensions](#)

Bot Agent updates by using installation file from local drive

You can now download the Bot Agent installation file to your local drive as a one-time activity and then update the Bot Agent on several devices by providing the local drive path to the installation file. This way, you can avoid downloading the installation file multiple times from the Control Room for several devices.

Important: This functionality is implemented in v.26 and can be used from v.27. That is, after you update your Bot Agent to v.26, future updates can be performed from the local drive.

[Automatically update the Bot Agent](#) | [Update the Bot Agent from a local drive](#)

Oracle Database now supported (Service Cloud case ID: 00726728)

We now support Oracle Database, so you can now choose to install the Control Room on Oracle Database.

Note: Oracle database for Control Room installation is supported only in Custom mode and not in Express mode. Oracle Database support on the Control Room starts with the v.26 release.

[Installing Control Room using custom mode for Oracle installation](#) | [Configure Oracle database type and server](#) | [Database requirements](#)

Control Room, devices and Bot Agent**Active Directory mappings filters stored in the database**

When you update to a newer version of the Control Room, you no longer have to define the Active Directory mapping filters again after installation. This is because the Active Directory mapping filters defined in the `um.properties` file are now stored in and can be referenced from the database. However, if you define new filters in the `um.properties` file, the Control Room references the filters defined in the `um.properties` file and overwrites the ones stored in the database.

Packages, actions, and Bot editor**RBAC on packages**

Based on your business requirements, you can now control the access that Bot Creators have to packages in the Control Room. As an administrator or user with the **Manage** package permission, you can restrict access to packages to either **all the users** or **users with specific roles**.

Depending on the access that is configured by the admin, Bot Creators and Citizen Developers can view and use specific packages:

- Bot Creators can access a broad set of complex packages and create bots, which can be reused.
- Citizen Developers can access simpler and easy-to-use packages and build automations quickly.

[RBAC on packages](#) | [Configure RBAC for packages](#)

Salesforce command package

You can now authenticate from Automation 360 to access Salesforce and run several command actions by using the new Salesforce command package.

[Salesforce package](#)

SAP GUI 770 version now supported (Service Cloud case ID: 01793132, 01792775, 1776805, 01792623, 787725, 01805482, 01805479, 01792623, 01810356, 01822839, 01851451, 01853577, 01860050)

SAP GUI 770 (patch 6) is now certified and supported with Recorder and SAP package.

[Recorder actions supported in various SAP versions](#)

Configure and use custom proxy configuration in REST Web Service package (Service Cloud case ID: 01271527, 01765084, 01839282)

REST Web Service package is now enhanced to support custom proxy configuration for each **Delete**, **Get**, **Patch**, **Post**, and **Put** action. This provides you more flexibility in calling REST APIs with different proxy configuration and allow you to create hybrid API automation.

[REST Web Service package](#)

Keyboard shortcuts to reduce scrolling

When developing large bots, you can now use keyboard shortcuts to expand and collapse individual or all sections and move through the lines of code quickly instead of scrolling and minimizing sections individually.

[Keyboard shortcuts to expand or collapse elements in bot logic](#)

Packages, actions, and Bot editor
<p>Set value in any editable control field to be blank in SAP application (Service Cloud case ID: 00821861, 01807129)</p> <p>When you use the Set text action of the SAP package, you can now set the value in any editable control field in the SAP application to be blank. For example, you can set the value in the text field or the date field to be blank.</p>
<p>Loop through emails and move them one at a time (Service Cloud case ID: 00749763, 01807189, 01840743)</p> <p>You can now loop through all the emails in a mailbox and move one email at a time to a destination folder by using the Move action in the Email package.</p> <p><i>Move action</i></p>
<p>Configure p12 certificate for SOAP-based automations (Service Cloud case ID: 00757213)</p> <p>In the SOAP Web Service action, you can now select the p12 certificate file and provide a password for user authentication. With this enhancement, you can now access web services that use the p12 certificate-based authentication (a more secure type of SSL certificate).</p> <p><i>Example of using the SOAP web service action</i></p>
<p>Improved accessibility, usability of content on Terminal Emulator window (Service Cloud case ID: 01609467)</p> <p>You can now have improved accessibility and usability of the content displayed on the Terminal Emulator window. When you use the enhanced Get text action of the Terminal Emulator package, you can now view and extract all the lines and text present in the Terminal Emulator window and perform an operation based on your requirement.</p> <p><i>Using Get text action for Terminal Emulator</i></p>
<p>Run bots with or without window title matching in letter case</p> <p>You can now run bots even when the title of a captured window does not match the letter case. For a bot to identify a static window or browser titles and titles with a wildcard character, you can opt for a case-sensitive match if you want the letter case to be matched, or a case-insensitive match otherwise, by using the Case sensitive option.</p>
<p>Control image preview and storage in Control Room during secure recording</p> <p>You can now choose whether or not the object images are available for preview and stored in the Control Room during secure recording by enabling the Recorder preview image setting. When you enable the setting, the image is previewed in the Bot editor and stored in the Control Room for 60 minutes. If you choose not to preview, images are not captured.</p> <p><i>Secure recording Secure recording mode Settings</i></p>
<p>Automate Microsoft Excel spreadsheets from SharePoint</p> <p>You can now automate Microsoft Excel spreadsheets that are uploaded and shared on SharePoint. Use Excel advanced > Open action to open the Microsoft Excel spreadsheets from SharePoint location.</p> <p><i>Using the Open action for Excel advanced</i></p>
<p>Automate Citrix Virtual Apps in Edge with IE mode</p> <p>When using the Recorder, you can now automate Citrix Virtual Apps running on Microsoft Edge Chromium with IE mode.</p>

Packages, actions, and Bot editor**Automate controls using Microsoft UI Automation (COM) technology**

For automation, you can now use the Microsoft UI Automation (COM) technology in the following scenarios:

- Capturing controls with secure recording mode
- Capturing and automating combo box and list view controls
- Using **Object exists** and **Object does not exist** Recorder conditions in If, Loop, and Wait packages

[Capture using specific technology](#) | [Actions performed on objects captured with Universal Recorder](#)

Seamless automation of Citrix Virtual Apps and other Citrix applications

With the new Automation 360 remote agent for Citrix, you can now seamlessly automate all types of Citrix Virtual Apps and other Citrix applications that are supported on desktop applications using the Recorder.

The new Automation 360 remote agent for Citrix supports the following browsers and technologies:

- Google Chrome
- Internet Explorer
- Microsoft Edge
- Microsoft Edge with IE mode
- Mozilla Firefox
- Java
- Electron apps
- Microsoft Active Accessibility (MSAA)
- Microsoft UI automation

[Installing Automation Anywhere remote agent on Citrix servers](#) | [Using the Recorder on Citrix Virtual Apps servers](#)

Important: For information about the supported packages for this release, see [Packages updated in Automation 360 v.26](#).

Building and running bots**Implement coding standards with code analysis**

You can now implement best coding practices by configuring coding rules in the Control Room. This feature helps you prevent potential errors, improve bot reliability, and makes the code more uniform, accessible, reliable, and efficient.

- As an administrator or a user with **View policies** and **Manage policies** permission, you can configure the code analysis policy for all users.
- As a Citizen Developer, you can run code analysis to analyze your bots against readability, maintenance, security, and compliance best practices.

[Code analysis](#)

Building and running bots
<p>Choose specific version of child bot to check out with parent bot (Service Cloud case ID: 01771388)</p> <p>When you check out a parent bot, you can now choose the version of the child bot to check out. Every version of a parent bot can have different versions of child bot dependencies. With this feature, you can roll back the dependencies while rolling back the parent bot. You can make changes to a specific version of the dependent bot.</p>
<p>Easily move bots and files between folders in the private workspace (Service Cloud case ID: 00733125)</p> <p>You can now move bots and files effortlessly and without requiring any permissions from one folder to another in the private workspace. With this feature, if a bot is placed in an incorrect folder, you no longer have to clone it in the correct folder and then delete it from the incorrect folder.</p> <p>Move a bot</p>
<p>Better organization with bulk checkin of related bots and files</p> <p>You can now select multiple bots or dependent files from different folders that belong to the same process and check them in, in bulk, from private to the public workspace with the same check-in message. You can check in a maximum of 10 parent bots, but there is no limitation on the number of dependent child bots.</p>
<p>Email notifications for failed checkins (Service Cloud case ID: 01598642)</p> <p>As an administrator, you can now configure sending email notifications to bot developers whenever their checkins fail. Without such email notifications, bot developers will be unaware of their failed checkins because although the checkin status is always logged in the audit log, they cannot access the audit log access without permission. With email notifications, bot developers can know about their failed checkins and retry immediately.</p>
<p>Export work items for offline records (Service Cloud case ID: 01769378, 01798514)</p> <p>You can now export work items to a CSV file for offline audits and records. With this feature, you can export selected, filtered, or all work items to a CSV file.</p> <p>Export work items to CSV file</p>
<p>Export and import queues for efficient and flexible usage</p> <p>You can now export and import queues across development, testing, and production environments. This way, you can create a queue in the development environment, test it in the testing environment, and then promote it to the production environment to efficiently execute business process workload. You can also include work items when importing a queue.</p> <p>Export queues Import queues</p>
APIs and integrations
<p>Connect Bot Agent to Control Room through v1/registration/auto API</p> <p>You can now use the <code>v1/registration/auto</code> API to register and connect your device to a Control Room automatically. You must specify the Control Room <code>URL</code> and the <code>userName</code> properties in the API Request.</p> <p>Bot Agent API: Auto registration</p>

APIs and integrations**Fetch execution details for specific execution IDs with new Control Room API**

You can now fetch the execution details, such as `botOutVariables` and `CallbackInfo`, for a specific execution ID by using the new API endpoint, `V3/activity/execution/<id>` API.

Authorization with bearer token

Automation 360 supports the Authorization header with a *Bearer token* for API requests to the Control Room. This header was previously unsupported and ignored on API requests. Obtain the *Bearer token* from our OAuth services. All API calls must contain either an authentication token from Authentication API (generates JSON Web token) or a bearer token from OAuth services. You cannot use both together in an API.

What's changed

Control Room, devices, and Bot Agent**Missed schedules redeployed automatically**

You can now ensure that schedules missed because of Control Room shut down (Control Room maintenance or upgrade) are automatically redeployed.

When you use the **Redeploy the schedule again** option, an audit log entry identifies the event type as `Schedule misfired`, and the bot is automatically redeployed after the Control Room is restarted.

Low disk space issues resolved with automatic deletion of temp files

Automation 360 now supports automatic clearing of the files in the temp folder, thereby resolving low disk space issues.

During bot import operations, temporary files were written to the following path, leading to increased usage of disk space and resultant low disk space issues: `C:\Users\<aa cr admin account>\AppData\Local\Temp`. As a result, the bots failed, and the temp files had to be cleared manually.

Enhanced Active Directory role mappings page

The Active Directory role mappings page no longer has default validation of mappings.

Validating all the role mappings can take a longer time on slow networks and with a higher number of mappings because it requires communication between the Control Room database and the Active Directory server. Also, changes in security groups and roles are infrequent and do not require frequent validation on this page. The Active Directory role mappings page now displays only the list of mappings which loads at a faster speed as validation of mappings is not done.

Enhanced autologin functionality for Bot Agent (Service Cloud case ID: 01788805)

Bot Agent autologin now works successfully even if the **Interactive logon: Do not require CTRL+ALT+DEL** group policy is disabled.

Previously, for the Bot Agent to autologin successfully, you had to enable this group policy, which was not possible due to the security policy. As a result, Bot Agent autologin failed.

Control Room, devices, and Bot Agent**Improved administration for WLM automations**

You can now view all the queues with the **AAE_Admin** role. Also, you can pause, resume, and stop all WLM automations.

Note: If you are not an owner, participant, or consumer of that queue, you can view only queue names and not the queue details.

Packages, actions, and Bot editor**Run DLL file without namespace** (Service Cloud case ID: 01765712)

You can now run a DLL function even if the namespace is not specified because the **Enter the namespace** field in the **Run Function** action of the **DLL** package is now optional.

Casing and format changes in Technology and Control types

When you use the Recorder to capture objects, you can now read and identify the names of technology types and control types easily because the names of the properties now use a more user-friendly casing and format. For example, MS_ACTIVE_ACCESSIBILITY is renamed Microsoft Active Accessibility.

Fixes

Build 15450: This build includes the following fixes (along with fixes from the previous builds):

If you have large and complex bots with many dependencies and if the size of the deployment messages that were sent from the Control Room to the Bot Agent is up to 5 MB, then the bots will run without failure.

Previously, bots were failing to execute when the size of the deployment messages that were sent from the Control Room to the Bot Agent was more than 2 MB.

Service Cloud case ID: 01882630

When you import a bot or file that is a manual dependency of other bots using the overwrite option, the import process no longer removes the dependencies from the other bots.

Previously, manual dependencies were removed for the overwrite option from the other bots during bot import.

Service Cloud case ID: 01911410, 01920508

You can select a path containing a dollar sign (\$) in a folder trigger for a file and folder, and the bot will execute successfully. Previously, the bot failed when you selected a path containing a \$ in a folder trigger for a file and folder.

Service Cloud case ID: 01829534

Build 15443 (for US-East and US-West regions only): This build includes the following fixes (along with fixes from the previous builds):

When you import a bot or file that is a manual dependency of other bots using the overwrite option, the import process no longer removes the dependencies from the other bots.

Previously, manual dependencies were removed for the overwrite option from the other bots during bot import.

Service Cloud case ID: 01911410, 01920508

Build 15439 (Japan region only): This build includes the following fixes (along with fixes from the previous builds):

You can now successfully retrieve values assigned to Global values with Japanese characters after upgrading the Control Room to the Automation 360 v.26 release.

Service Cloud case ID: 01911093, 01911209, 01911190, 01911116, 01911259

Build 15436: This build includes the following fixes:

You can now successfully delete a device from the device pool without any error.

Previously, when you deleted a device from the device pool, it was deleted from the Control Room but remained in the `DEPLOYMENT_ALLOCATION_QUEUE` table. Hence, the device could not be deleted and an error was shown.

Service Cloud case ID: 01791502, 1840575

If you run a bot from the Bot editor workspace for debugging using the **Run from here** option and if the bot contains packages that use the session (**Local** or **Global** session), the following compiler error no longer occurs: `Unable to find any open session`

Service Cloud case ID: 01080318, 01759454, 01785168, 01790014, 01786670

In a multi-user environment, for simultaneous bot deployments, bot launcher logs are now generated for all the users.

Previously, in such cases, bot launcher logs were not generated for all the users.

Service Cloud case ID: 01759506

You can now successfully list a scheduled task, and the following error no longer occurs: `Unknown timezone ID:US-Pacific-New`

Previously, an unsupported time zone could be selected, which resulted in this error.

Service Cloud case ID: 01759074

If a device is shared between a Bot Creator and a Bot Runner, when you try to edit a schedule, the following updated message is now displayed: `UNKNOWN: All runAsUser(s) should have default device as no pool is provided. RunAsUser(s): [dprunner] does not have a default device or that device is shared with a bot creator`

Previously, if a device was shared between a Bot Creator and a Bot Runner, when you tried to edit a schedule, the following incorrect message was displayed: `Automation failure due to deploy failure`

When you update the Bot Agent from user level to system level, you can now capture objects using the Recorder actions or from a window list in a Google Chrome browser. You no longer have to manually delete the registry entry in Windows from the current user level (HKEY_CURRENT_USER).

Service Cloud case ID: 00731155, 00778022

After connecting to a device, when you set the global cache location to an invalid path, an audit log entry is generated against the device, and the default global cache path is now used.

Note: Depending on the device used and the path you specified on your drive, validation of the default cache path might not be supported.

When you want to edit a *DataTable* variable in debug mode, you can now scroll horizontally to view all the columns in the *DataTable* variable.

Service Cloud case ID: 01818834

In the FTP / SFTP package, you can now create bots using actions such as **Delete files**, **Put files**, and **Get files** even if the file name contains characters such as the comma (,) and the colon (:).

Previously, characters such as the comma (,) and the colon (:) were not supported in file names.

Service Cloud case ID: 01772186

You can now run an Enterprise 11.3.3 bot from Automation 360 in the Enterprise 11 Control Room by using the **Run** action.

Previously, the **Run** action did not work for v.11.3.3 because the device V1 API was not working with an empty filter for release 11.3.3.

Service Cloud case ID: 00825696, 01747999

You can now successfully connect to the Excel or Access (Microsoft Office 2016 or later) engines with ODBC drivers.

Previously, if you tried to connect frequently to the Excel or Access (Microsoft Office 2016 or later) engines with ODBC drivers, bot execution failed intermittently.

Service Cloud case ID: 01762290, 01755335, 01778149, 01778899, 01793064, 01788154, 01810754, 01806851, 01811703, 1815437, 01807133, 01799364, 01755642, 01749480, 01767869, 01807133, 01818989, 01815300, 01826839, 01804882, 01842384, 01846477, 01762300, 01331003

When you send an email with multiple file attachments and if attachment size exceeds 24 MB, the bot now waits for 120 seconds before encountering a timeout error.

Previously, when you sent emails with a large file attachment, bot execution failed after 30 seconds if the attached file exceeded the file size.

Service Cloud case ID: 01763214

When you use the **Connect** action to connect with the **EWS** protocol, the **Send** email action and read email now print the email message body in a new line character in the following scenarios:

- When you create a bot and connect with the **EWS** server, then use the **Loop** action to read email as a plain text messages, and then use the **Log to file** action to log text into a file.
- When you use the **Send** email action and connect with the **EWS** server with **OAuth authentication** to send email.

Service Cloud case ID: 01770645, 01780628

In the Email package, when you use the **Move all** action and establish a connection with the EWS server, if the destination folder contains any of the following special characters in the folder name, then use a backslash (\) as escape character before the special character: , + , * , ? , ^ , \$, (,) , [,] , { , } , | , \

For example, if the destination folder name is "4) folder name", enter it as "4\) folder name".

Service Cloud case ID: 01803958

If your bot contains an error, **Bot error** now shows the correct line number of the error within the **Finally** block in the following scenario: When you add the **Try/Finally** block around the corresponding action, then insert more actions in the **Finally** block, and then save and run the bot.

You can now successfully upload files whose file names are in the Japanese language by using the **Rest web service** action with multipart form data.

Previously, file upload did not work for files whose file names were in the Japanese language.

Service Cloud case ID: 01801767

You can now use the Terminal Emulator package to perform tasks associated with the terminal without any issues. We now provide support for the Start PC Command (STRPCCMD), so when you run the bot, the terminal now successfully opens the application with the STRPCCMD command.

Previously, when you passed the appropriate key on the Terminal Emulator, the bot did not open the expected application because the STRPCCMD command was not supported in the Terminal Emulator.

Service Cloud case ID: 01816577

In the Terminal Emulator package, you can now use the **Connect** action to connect with a host machine on which you want to automate a task.

Previously, when you used the **Connect** action, a black screen was displayed for a few terminal hosts.

Service Cloud case ID: 01823081, 01841800

After migration, when you open a **Load Add-ins-enabled** Excel file using the **Excel advanced > Open** action and run a bot, the bot now runs successfully without any error.

Previously, the bot failed because some Excel files with the **Load Add-ins** option enabled stopped functioning and the workbook was closed unexpectedly.

Service Cloud case ID: 00950745, 01835066

When you use the **PDF > Merge documents** action and select **All pages** option in the **Pages** field to merge all pages of multiple PDF documents into a single PDF document, the output PDF now retains and merges all the attributes such as bookmarks, links, layers, attachments, and signatures from the individual source documents.

Service Cloud case ID: 01792105

When the Recorder fails on a computer where the operating system language is not English, the error message for the bot runtime failure is now shown in the same language as that of the operating system.

Previously, the error message was shown in English even on computers where the operating system language was not English.

Service Cloud case ID: 01813050

<p>You can now successfully extract text from within the captured area of a window using the App Integration package even if the screen resolution is more than 100 percent.</p>
<p>Automate and capture window authentication dialog boxes in the Google Chrome browser using a specific technology with the Recorder.</p>
<p>Bots are no longer stuck when you work with Microsoft Access database queries.</p> <p>Service Cloud case ID: 01756390</p>
<p>You can now open local files by using the New window option in the Browser > Open action even if Microsoft Edge is your default browser.</p> <p>Service Cloud case ID: 01799784</p>
<p>At bot runtime, when you assign a new window title to a window variable, the window variable now detects the correct window.</p> <p>Service Cloud case ID: 01788466, 01791773</p>
<p>You no longer encounter a compilation error in the UI in the following scenario:</p> <ol style="list-style-type: none"> 1. Use the Datetime package released with Automation 360 v.23 or earlier to create a bot that uses the Datetime > Assign action. 2. Then, select the Variable option to add the variable value. 3. Then run the bot with the package released with Automation 360 v.24 or later.
<p>You can now successfully capture objects from applications that are launched from a Citrix machine.</p> <hr/> <p>Note: This fix is available only with the new Automation 360 remote agent, which you can use with the upgraded Recorder package (version 2.8.6-20220823-160834).</p> <hr/> <p>Service Cloud case ID: 00831939</p>
<p>When you assign a window title to a window variable, if the variable field has an empty regular expression value, the bot no longer passes it without scrutiny. Instead, the following error message is now displayed: <code>Unable to find the window '<window_name>'. The provided regular expression '<regular_expression>' is invalid. Please provide a valid regular expression for the variable '<variable_value>'.</code></p>
<p>When you merge multiple PDF documents by using the PDF > Merge documents action, all the form field attributes in Adobe Acrobat are merged and the output PDF document is now rendered properly.</p> <p>Service Cloud case ID: 01760279, 01792301</p>
<p>When you use the If > Folder does not exist condition to determine whether a folder does not exist, if the specified folder exists, the bot now successfully recognizes the folder and does not attempt to create it again.</p> <p>Previously, because of the presence of leading and trailing spaces in the input folder path, the bot failed to recognize an existing folder and hence attempted to create the folder, leading to an error.</p> <p>Service Cloud case ID: 01466067</p>
<p>If you migrate a bot and select the HTML Tag, HTML InnerText, and HTML type properties and then select HTML-type properties in Search Criteria, the bot now successfully locates and identifies the object and performs the selected action.</p> <p>Service Cloud case ID: 00829817, 01757049, 01761452, 01822711</p>

<p>When you use the Recorder package for the Get property action, the correct values are now displayed for the top, left, height, and width properties.</p> <hr/> <p>Note: The Get property action does not display correct values for cross-domain iFrames elements.</p> <hr/> <p>Service Cloud case ID: 01251758</p>
<p>The AISense Recorder package now works as expected when you use the Windows 10 operating system in the Japanese language. Because UTF-8 is now enabled, you no longer need to use any workaround.</p> <p>Service Cloud case ID: 01821267, 01822433</p>
<p>When you use 2.8.0-20220601-034227 and later versions of the Recorder package, the automated bot now returns the correct value for the HTML InnerText property in Google Chrome and Microsoft Edge browsers.</p> <p>Service Cloud case ID: 01257098 , 01754795, 01791073, 01787461, 01813080, 01846403</p>
<p>For WLM queues, the date is now displayed in the correct format as <i>YYYY-MM-DD</i>.</p> <p>Previously, this date was shown in the <i>years ago</i> format, which did not match the date format in the CSV file and was confusing.</p>
<p>In a multitenant environment, when you upload a work item file to a queue in one of the tenants, the In progress tab now displays the correct file upload status only in the corresponding tenant.</p> <p>Previously, the In progress tab displayed the upload status for all the tenants.</p>
<p>When a WLM automation is in progress, an administrator can no longer delete the user who created that automation.</p> <p>Previously, the user who created an automation could be deleted, after which that automation could not be paused or resumed by another user.</p>
<p>When you stop a WLM automation, work items are no longer stuck in the ready-to-run state and are now moved to the New state.</p> <p>Previously, when you stopped a WLM automation, a few work items were stuck in the ready-to-run state and could not be deleted.</p>
<p>After you change any configuration field in the Administration > Settings > Devices > Advanced options settings in versions prior to v.25, if the Control Room is updated to v.25, the Global Cache Location is now set to the default <code>C:/ProgramData/AutomationAnywhere/GlobalCache</code> value.</p> <p>Previously, in such cases, no value was shown for the Global Cache Location field, which was confusing.</p> <p>Service Cloud case ID: 01869048</p>
<p>When you use the Run bot option to run a bot in the Activity > Historical > View page for any activity, the bot now runs successfully.</p> <p>Previously, in such cases, bot execution failed with an error.</p>

When you import a bot that contains manual dependencies, for the overwrite option, the import process now removes the manual dependencies.

Previously, during bot import, the manual dependencies were not removed for the overwrite option.

Service Cloud case ID: 01813452

When you import a bot into a folder, if a folder with the same name but different letter case already exists in the repository, bot import now fails with an error.

Previously, in such cases, bot import was successful, but the imported bot failed at the time of execution because of the wrong folder path.

Service Cloud case ID: 01270324, 01816507

You can now successfully access all the folders in the public workspace without any issues.

Previously, when you imported and cloned a bot under a folder in the public workspace and then tried to access that folder, sometimes an error occurred, and the folder could not be accessed. This occurred some times when there were more than 2100 folders under the bots directory.

Service Cloud case ID: 01852748

When you update from Enterprise 11 to Automation 360 or upgrade from an earlier version of Automation 360 to a later version, the earlier defined group mappings are retained, even when the Distinguished Name (DN) column of the mapping entries are empty in the database.

Previously, some of the earlier-defined group mappings were deleted due to the empty value for the DN column.

After you update to Automation 360 v.22 or later, the Repository Management (v2/repository/file/list) API now returns the correct file size as response output.

Previously, the Repository Management (v2/repository/file/list) API returned the file size as zero in the response output.

Service Cloud case ID: 01151460

The Azul Zulu JDK is now updated to version 11.0.15+10. The previous version, 11.0.14+9, contained some vulnerabilities.

Common Vulnerabilities and Exposures (CVEs) for this version are as follows: CVE-2022-34169, CVE-2022-21540, CVE-2022-21541, CVE-2022-21549, and CVE-2022-34169

Service Cloud case ID: 01854652, 01868897, 01857973, 01854652, 01887083

Limitations

When you connect to the Microsoft Access Database with JDBC and specify the database path, and if you use the following specific aggregation functions in the query, an error occurs when you run the bot.

```
ASC, ATN, SQ, CBOOL, CCUR, CDATE,
CDBL, CDEC, CDATE, CDBL, CINT, CLONG, CLNG,
CSIGN, CSTR, CVAR, DATEADD, DATEDIFF, DATEPART,
DATESERIAL, DATEVALUE, FORMAT, IIF, INSTR, INSTRREV,
ISDATE, IsNull, ISNUMERIC, LEFT, LEFTS, LEN, MID,
MONTHNAME, DATE, NOW, NZ, SIGN, SPACE, STR, TIME, VAL,
WEEKDAYNAME, WEEKDAY, STRING, TIMESERIAL, CONCAT
```

Workaround:

1. Go to **Administration > Settings > Devices > Advanced options > Bot launcher JVM options** and set the value as follows: -
`Dhsqldb.method_class_names=net.ucanaccess.converters*`
2. Restart the Automation Anywhere Bot Agent service.

External key vault integrations are not supported on Oracle Database.

Not all missed recurring schedules are redeployed with the **Redeploy the schedule again** option. Also, only one entry is shown for the missed recurring schedules in the **In progress** tab.

As an IQ Bot user, you can check out only the latest version of a process. You cannot check out previous versions of a process because version check is performed based on the Automation Anywhere file version and not the Git version.

The OAuth2 configuration settings in the Control Room will not enable you to connect to the OAuth2 service at this time. Customers planning an OAuth2 integration with our partner application should expect the service to be available by November.

In the Oracle Database environment, you cannot view a checked-in bot in the **Public** folder because version check is performed based on the Automation Anywhere file version and not the Git version.

Workaround: To view a checked-in bot in the **Public** folder, you must refresh the **Automation** page manually by using the **Refresh** button.

In an Oracle Database environment, when you select the number format and sort order for the work items in a queue, and then run bot using the **Run bot with queue** option, the queues are not deployed. Also, no errors are shown in the **Audit log** or **Activity** page.

When feature flag to queue the deployment is enabled and if any of the Unattended Bot Runner devices are down, the deployments (regular or scheduled) get added to the queue on the **In-progress** page. These deployments keep getting queued until the devices reconnect. When the count reaches to 500 at a given time for a tenant in a pod, no further deployments can take place.

Workaround: To run the queued deployments, perform one of the following actions:

- Select the required job on the **In-progress** page and move it to the **Historical** page
- Reconnect the Bot Runner devices.

When you set the default package version using the **Update bots to default package version** option for bots in the public workspace that are using the **Excel Advanced > Open** action, the TaskBots do not display the session name and file path values.

Workaround: Perform one of the following workarounds:

- Update the **Excel Advanced** package manually to use the latest version of the package. See [Select the package version used in your bot](#)
- Check out the bot and revert to the previous version of the **Excel Advanced** package. Then, check in the bot to use the latest version of the package. See [Update bots to default package version](#)

Service Cloud case ID: 01905290, 01882083, 00712719, 00728499, 00737694, 00803673, 01255722, 00838604, 00772147, 01760236, 01762679, 01771416, 01761859, 01782588, 01778220, 01784255, 01789551, 01809167, 01818690, 01831969, 01813413, 01287311, 01923711, 01927867

You will encounter an error when you run a standard workflow in the SAP BAPI package

Workaround: To execute SAP BAPI, use the Run Function call (RFC) with a combination of **Create function, Set or Get field value, Set or Get structure, and Set or Get table** actions.

When you use 2.6.1-20220428-010714 or later versions of the Recorder package to automate a web page on Microsoft Edge browser, the Recorder might not be able to perform **Click** or **Left click** actions on the JavaScript alert, prompt, and confirmation pop-up windows.

Workaround: For performing the click actions successfully, downgrade the Recorder package to 2.5.4-20220309-151830 version or earlier.

When you use the **Browser > Close** action to close a tab or a window opened in the Microsoft Edge browser, if only one Microsoft Edge browser window is open, the bot encounters the following error: Error occurred while closing the tab

Workaround: See [Configure Microsoft Edge browser settings when Close action of Browser package encounters an error \(A-people login required\)](#)

When you run a bot in the Google Chrome or Microsoft Edge browser, use the If, Loop, or Wait action, select the webpage from the list of active tabs in the **Browser** tab, close the browser window, and then run the bot, the bot might take two minutes to open the webpage in the browser irrespective of the timeout value mentioned.

Workaround: Move the If, Loop, or Wait action inside the **If** block and use the **Application is running** condition with same browser application to check whether the browser is running.

When you run a stored procedure in Oracle and it returns SYS_REFCURSOR, the **Run stored procedure** action is not closing the cursors. As a result, after the maximum cursor limit is reached, this action results in an error.

When you migrate a bot that contains **XML command > Get single node**, after migration, the bot encounters the following error: No node found at XPath while executing the Get Single node command

Workaround: If the XPath expression is not starting with (/) , apply XPath starting with "" so that at the time of execution, the modification can be skipped or the XPath expression can be designed to get the desired result.

When you use the **Browser > Open** action to automate a browser window running on Google Chrome and Microsoft Edge browsers, then from the browser window, select **More tools > Name window** option to update the title of this window during bot run and then when you try to run the bot with the updated window title, the bot might fail.

When you use the actions in the App Integration package to extract text from a window, the bot might not be able to detect the new UI of the Windows 11 operating system and capture the text.

Workaround: Enable the old classical UI in Windows 11 operating system. See [Restore Old Classic Notepad in Windows 11](#)

When you use the [List files API](#), the response lists bots restricted by user role. If you use this API as an AAE_Admin, you can view bots from the private repository in the response. Whereas if you use this API as a bot creator, you can view system bots (recorder) in the response.

Workaround: Use the [List files and folders by workspace API](#).

Command prompt API allows you to switch the device registration even if the **Allow devices (single user) to be switched to another Control Room without reinstalling bot agent** option is disabled.

Feature deprecations

Review features and capabilities (from Automation Anywhere or other third-party vendors) that are deprecated or nearing deprecation to understand how they impact your automation.

Automation Anywhere Mobile app deprecated

The Automation Anywhere Mobile app is deprecated as of July 2022 and will not be updated to subsequent versions of iOS and Android. The mobile app is no longer available and no further support will be offered. A replacement product is currently not available.

Tesseract OCR v3 deprecated

Tesseract OCR version 3 is deprecated as of September 2022. If you have created learning instances using Tesseract OCR version 3, we recommend that you plan to train your learning instances with alternative OCRs (including Tesseract4 OCR) before you update to Automation 360 v.26.

[Deprecation of Tesseract OCR v3](#)

Deprecation of IQ Bot Extraction package

The IQ Bot Extraction package has been deprecated as of September 2022. As part of Automation 360 v.26, IQ Bot will no longer support pretrained machine learning models for invoice data extraction.

To move your bots from the IQ Bot Extraction package to Document Automation, see [IQ Bot Extraction package](#).

RPA Bots for Excel deprecated

RPA Bots for Excel has been deprecated as of January 2022. The plug-in is no longer available to download as a product. However, support will be offered to current customers already using the product.

A replacement product as a plug-in for Microsoft Excel is not available. In RPA Bots for Excel, this action was triggered from within the Excel application. However, as an alternative, new customers can develop bots for Excel within Automation 360 RPA Workspace and use input variables to allow specifying file names, worksheets, and ranges for bots to operate on. In RPA Bots for Excel, this action was triggered from within the Excel application, whereas now this action is taken from the Automation Anywhere Control Room.

G-Suite Apps package deprecated

The G-Suite Apps package has been deprecated as of September 2022 and it no longer supports using the **Connect** and **Disconnect** actions to establish a connection with the Google server and automate tasks.

Recommended: For specific G-Suite applications, the functionality of the G-Suite Apps package is available in the following G-Suite packages:

- Google Drive
- Google Calendar
- Google Sheets

To automate tasks, in the appropriate G-suite package, use the corresponding **Connect** and **Disconnect** actions.

Related concepts

[View package versions available in the Control Room](#)

Actions are grouped into version-specific packages. Bot Creators can select which package version to use for a specific bot.

Related reference

[Automation 360 v.26 Release Notes](#)

[Updating to v.26 release](#)

Review requirements and support information about updating your Control Room and Bot Agent for the v.26 release.

[Migration updates for v.26 release](#)

Review what's new, changed, and the fixes and limitations to migrating from Enterprise 11 and 10 versions to Automation 360 v.26.

[AARI v.26 release](#)

Review what's new and changed and the fixes in AARI for the v.26 release.

[IQ Bot and Document Automation v.26 release](#)

Review what's new and changed, and the fixes and limitations in IQ Bot and Document Automation for the v.26 release.

[Bot Insight v.26 release](#)

Review what's changed and the limitations in Bot Insight for the v.26 release.

Updating to v.26 release

Review requirements and support information about updating your Control Room and Bot Agent for the v.26 release.

Bot Agent updates

Bot agent update: This release includes an **optional** Bot Agent update. You can continue to run your existing bots without updating the Bot Agent. However, if you want to use the new features in Automation 360 v.26, you must update the Bot Agent available with this release.

For more information on updating to this release, see these resources:

- [Automatically update the Bot Agent](#) | [Manually update the Bot Agent](#)
- [Compatibility with Automation 360 builds](#)

Supported Control Room builds for direct update

You can update to the latest version of Automation 360 from the previous three releases (that is, from $n-3$ releases, where n refers to the latest release).

The following previous releases are certified for update to Automation 360 v.26:

- v.25 (Build 15112, 15097)
- v.24R2 (Build 13343), and v.24 (Build 12350, 12342)
- v.23 (Build 11513)

If you are on one of these previous releases, for information about updating, see [Update to latest Automation 360 version](#). If you are not on an $n-3$ release, update Automation 360 to one of the $n-3$ releases before updating to Automation 360 v.26.

For the latest updates to the Automation 360 extensions for Google Chrome, Microsoft Edge, and Mozilla Firefox, see [Enhancements to browser extensions](#).

Related reference

[RPA Workspace v.26 release](#)

Review what's new and changed, fixes and limitations, and the feature deprecations in RPA Workspace for the v.26 release.

[Migration updates for v.26 release](#)

Review what's new, changed, and the fixes and limitations to migrating from Enterprise 11 and 10 versions to Automation 360 v.26.

Migration updates for v.26 release

Review what's new, changed, and the fixes and limitations to migrating from Enterprise 11 and 10 versions to Automation 360 v.26.

What's new

Enterprise 11 and Enterprise 10

Migrate parent bots independently, avoiding overwrites and loss of updates (Service Cloud case ID: 01258572, 01778107, 01275417, 01880168)

You can now migrate a parent bot independently even if it has associated child bots. You now have a choice to select whether you want to migrate a parent bot independently or along with its dependent child bots.

This helps in avoiding overwrites and loss of updates that might happen when child bots that are migrated to Automation 360 are updated after migration.

[Migrate Enterprise bots](#)

Enterprise 11 and Enterprise 10**Migrate more bots with specific features**

You can now successfully migrate bots in the following cases:

- Bots that use spreadsheets residing in **SharePoint** by using the **Excel advanced > Open** action.
- You can now migrate bots with REST commands with custom proxy configuration at the **Action** level. For custom proxy configuration support, in the **Bot Migration Wizard**, select the **Include web service settings** option.

When you select this option, the REST commands are migrated with custom proxy configurations that use the following global variables:

- `AAProxyHost` for **Hostname**
- `AAProxyPort` for **Port**

Migrate Enterprise bots

- Bots in which the user interface or window extends beyond the screen on the top-left corner (truncated) for the following actions: Object Cloning, If, Loop, Web Recorder, and Manage Web Control.

Now, migrated bots support windows with negative coordinates (truncated windows).

Enterprise 11 only**Migrate bots independent of Bot Insight migration**

Before migration of legacy bots, you can now declare whether these bots were using the Bot Insight option in Enterprise 11 by selecting the **Tag bots and variables for analytics** option in the **Bot Migration Wizard**. The Bot Insight **Open** and **Close** actions are created only for such migrated bots where this option is selected.

Migrate Enterprise bots

What's changed

Assess migration readiness of processes with Bot Scanner

The Bot Scanner scans your repository for processes that can be migrated to Automation 360 and provides information under the following categories:

Note: A process is a bot that is not used in any other bot and can include child bots.

- **All:** List of all the processes.
- **Action required:** List of processes that require action after migration to Automation 360. A process is flagged as **Action Required** even if one of its child bot requires action.
- **Review required:** List of processes that require review after migration to Automation 360. A process is flagged as **Review Required** even if one of its child bot requires review.
- **No review required:** List of processes that can be migrated. All the bots in the process can be migrated.
- **Non Migratable:** List of processes that cannot be migrated. All the bots in the process cannot be migrated.

Note: For generating processes summary report, the maximum repository size that is supported is up to 10 GB.

[Analyze Bot Scanner report for migration](#)

Direct link to upgrade launchpad and migration resource portal in Bot Scanner

Bot Scanner report now also contains direct links to:

- Upgrade Launchpad: Use the information provided on this page for a self-guided experience that is customized for your migration requirements.

[Upgrade Launchpad](#)

- Enterprise Migration Resources: Use the information on this page to plan for migrating to Automation 360.

[Enterprise Migration Resources | Cloud RPA | Automation Anywhere](#)

[Analyze Bot Scanner report for migration](#)

Direct link to corresponding migration messages

With a direct link to migration messages in **Bot Assistant**, you now have quicker access to information about migrated bots that require action or review.

Validate letter case in window titles

You can now validate the letter case in window titles in window variables. By using the **Case sensitive** option, you can now decide whether to match or not match the letter case in window titles that have the same titles but differ in letter case.

With this option, you can ensure that the migrated bots produce the same output as that of their corresponding Enterprise 11 bots.

Review bots more efficiently with exact line number in Bot Scanner report

The Bot Scanner report now displays the exact line number in the bots that need review or action even in cases where some of the commands used in Enterprise 11 bots are not available in Automation 360.

Fixes

When you migrate bots with the **Select item by index** action of the SAP package, the index is now displayed correctly. The migrated bot selects items according to the correct index, and no error is displayed.

MetaBots that were captured using the following configurations will now be migrated to Legacy AISense in Automation 360:

Linked object play mode	Main object play mode
Text	Text
None	Text

Previously, bots that used such MetaBot configurations failed to migrate.

Service Cloud case ID: 01774261

You can now migrate TaskBots that use MetaBot Logic whose DLL file contains classes without a namespace.

Previously, an error occurred when you ran such TaskBots.

Service Cloud case ID: 01765712

When you migrate from Enterprise 11 to Automation 360, capturing MetaBot screen commands is changed as follows:

Enterprise 11	Automation 360
<ul style="list-style-type: none"> Main objects captured with the Object play mode Linked objects captured with the Coordinate play mode 	Record capture actions with the Object play mode

You can now use commas in the filenames of bots that use FTP actions and use colons in the filenames of bots that use Delete files and Delete folder FTP actions.

Previously, such bots encountered an error during bot run.

Service Cloud case ID: 01772186

When you migrate bots that use the same window titles but have different letter case in window variables, the bots now run successfully.

Previously, bots that used the same window titles but had different letter case in window variables failed to run successfully after migration.

Service Cloud case ID: 00825181

You can now successfully run migrated bots that use the *Email Received Date* variable twice in subactions inside the Email Loop action.

Previously, a parse error occurred in such cases.

Service Cloud case ID: 01275815

In migrated bots, when you use the Recorder package, you can now use the **Click** action on **Client Control** in **HTML technology** without any issues.

Previously, the **Click** action button on **Client Control** did not work as expected.

Service Cloud case ID: 01713357

You can now successfully re-edit a migrated bot with the **Record > Dataset** variable.

Service Cloud case ID: 01807170

When you want to open web pages, in the Browser package, when you use the **New window** option of the **Open** action, you can now specify a URL without the protocol information, such as http, https, or file.

Previously, when protocol information was not provided in the URL, some web pages did not open properly.

You can now successfully migrate Enterprise 11 bots with analytics flags.

Previously, migration failed when variables with analytics flags were checked.

Service Cloud case ID: 01768545

When you click the **Back** button in the migration details page for a migration run, you are now redirected to the **Migration runs** tab.

Previously, when you clicked the **Back** button, you were redirected to the **Overview** tab.

Service Cloud case ID: 01816558

When you migrate a bot that uses the **Manage Window Controls** action, the height value is now set correctly after migration.

Previously, after migration, the last digit of the height value was not available.

Service Cloud case ID: 01756996

When you run a bot to automate spreadsheet data, all the requests are now processed successfully in the following scenario:

When an Excel session is active in SAP and a corresponding Excel process starts in the background, Automation 360 creates a separate Excel process other than the one that SAP started, and the correct window is now activated for all the subsequent requests.

Previously, only the first request was processed successfully because the correct window was not activated for automating the spreadsheet data for the subsequent requests.

Service Cloud case ID: 00815159

When you migrate bots from Enterprise 11, the automation priority of each bot is now adjusted to match its equivalent priority level in Automation 360, as follows:

- In Enterprise 11, if the automation priority for a bot was set to low, after migration, the automation priority for the bot is changed to medium.
- In Enterprise 11, if the automation priority was set to medium, the automation priority in the migrated bot is set to high.

Note: There is no change in automation priority when it is set to high.

Previously, the automation priority of migrated bots remained the same as in Enterprise 11.

You can now migrate bots even if the properties value of the Manage Window Controls action is set to 65536 or more.

Previously, when the properties value was set to 65536 or more, the bots encountered an error during bot run.

Service Cloud case ID: 01768555, 01825071

After migration, you can now get all the lines of text from the Terminal Emulator by using the **Get text > All lines** action.

Previously, you could get only 24 lines of text from the Terminal Emulator.

Service Cloud case ID: 01609467

In the Bot migration wizard, the Bot Scanner and the Bot migration report now display the correct status for bots that are flagged for the R134 migration message.

Previously, in the Bot Scanner and the Bot migration report, the status of bots that required review was incorrectly displayed as **No review required**.

You can now successfully migrate bots whose queue category name contains a space.

Previously, migration of such bots failed because Enterprise 11 bots whose queue category name contained a space went into an infinite loop until the loop timed out at 90 minutes.

Service Cloud case ID: 01850864

After you migrate a bot that uses the Terminal Emulator package, when you run the bot, the terminal window is now activated and remains in the front. This is because the **Show terminal window in the front** option in the **Connect** action is now enabled by default.

Previously, when you ran such a bot, the terminal window was not activated and remained minimized because the **Show terminal window in the front** option was not present in the **Connect** action.

When you run a bot with the Database package, the bot no longer becomes stuck at the **Insert** or the **Update** command when run for a long duration.

Previously, in such cases, the bot became stuck intermittently.

Service Cloud case ID: 01836733

Limitations

In Enterprise 11, if bots were using the **String > Replace** action to find a carriage return line feed (CRLF) character and replace it with another character, after migration, the output might not be the same as the output seen in Enterprise 11.

Workaround: In the **Find string** option, instead of the **Enter** (LF) variable, use the **Newline** (CRLF) variable.

Service Cloud case ID: 01808878

In Enterprise 11, if bots were using the If, IF/ELSE, or Loop While command in Windows Control and if the Application window does not exist, after migration, the bots will encounter an error during bot run.

Service Cloud case ID: 01846262

When the **Select** query is used inside a Loop command and its result set is further iterated, if the query returns no record, the result set Loop reiterates the previous record.

Service Cloud case ID: 01799961

Related reference

[RPA Workspace v.26 release](#)

Review what's new and changed, fixes and limitations, and the feature deprecations in RPA Workspace for the v.26 release.

[Updating to v.26 release](#)

Review requirements and support information about updating your Control Room and Bot Agent for the v.26 release.

AARI v.26 release

Review what's new and changed and the fixes in AARI for the v.26 release.

What's new

Embedded automation with OAuth 2.0

Embedded automation streamlines access to the automation experience.

[Embedded Automation](#)

- AARI Integrations embeds in web applications as a widget, so if you are an end user, you can access automated processes and bots without leaving your environment.
- AARI Extensions offers further adaptability through Chrome browser extensions, enabling automation directly in any web scenario. Business users can now access automations through a widget, available through an extension in their web browser.
- With an OAuth 2.0 connection, existing access to automations in the Control Room are now shared with the Extensions to offer you a seamless user experience.

[AARI Integrations and AARI Extensions](#)

Oracle Database support

We now support AARI on Oracle Database. When you install or update to this release, you can now choose Oracle Database to work with AARI.

Delete files permanently from AARI cloud storage

You can now delete files permanently from AARI cloud storage. When you delete a request, the associated file is also permanently deleted now and not just sent to the recycle bin.

[Cloud storage usage](#)

Append or overwrite operations in your form

Append or overwrite operations in your form by using the **Assign** form rules for the web, with the **Checkbox** and **Radio Button** elements, which now support form rules.

Assign dynamic values with support for new elements in your forms

When you use the interactive forms package, you can now assign dynamic values with the **Assign** action, which now supports **Checkbox** and **Radio Button** elements in your form.

You can also change the label of the selected form elements with the **Change label** action for the **Button** element.

[Interactive forms package](#)

Run processes more seamlessly by setting expiration time for human tasks (Service Cloud case ID: 00806522)

You can now run your process more seamlessly even when a human task takes longer to run. You can achieve this by setting an expiration time for your tasks in **Human Task** in a process.

When you set an expiration time, if a human task takes longer to address, the task times out and the process moves to the next step to ensure there is no break to the flow.

You can set the expiration time by number of days, hours, and minutes, depending on your requirement.

[Create an AARI process](#)

What's changed

Simplify your workflow by grouping multiple conditions in form rules

You can now group multiple conditions for your form rules by using the **And** logic with the **Or** logic. Previously, you could group only the **And** logic or the **Or** logic. This change, which is similar to the **If-Then-Else** logic, facilitates grouping multiple conditions and helps simplify your workflow.

Fixes

<p>You can now have greater security validation because it is no longer possible to upload files that have double extensions, such as File.PDF.PDF, to your web application.</p> <p>Previously, uploading files with double extensions was possible, which represented a significant risk to applications.</p> <p>Service Cloud case ID: 00828289</p>
<p>When you use the Has Errors rule to show the number of errors in your form, the error message now shows the correct number of errors.</p>
<p>When you update from Automation 360 v.24R2 to Automation 360 v.25, the bot setup now correctly shows the number of bots and assigned teams.</p>

Related reference

[Automation 360 v.26 Release Notes](#)

[RPA Workspace v.26 release](#)

Review what's new and changed, fixes and limitations, and the feature deprecations in RPA Workspace for the v.26 release.

[IQ Bot and Document Automation v.26 release](#)

Review what's new and changed, and the fixes and limitations in IQ Bot and Document Automation for the v.26 release.

[Bot Insight v.26 release](#)

Review what's changed and the limitations in Bot Insight for the v.26 release.

IQ Bot and Document Automation v.26 release

Review what's new and changed, and the fixes and limitations in IQ Bot and Document Automation for the v.26 release.

Document Automation

What's new
<p>Improve extraction by providing changes to the Validator</p> <p>You can now improve extraction by providing learning instances with validation feedback for Automation Anywhere models. You can achieve this by enabling the Validation feedback option in the Create learning instance and Edit learning instance windows.</p> <p><i>Data extraction in Document Automation</i></p>
<p>Search for form or table fields</p> <p>When creating a learning instance, when you are configuring fields, you can now search for fields by field name, field label, or data type.</p>

What's new**Process invoice-like documents with user-defined document type**

You can now process documents that are visually similar to invoices, such as purchase orders and sales orders, which contain key-value pairs and a table structure. You can achieve this by create learning instances with the user-defined document type, using which you can also achieve the following results:

- Extract from English, Dutch, French, German, Italian, Portuguese (Brazilian), and Spanish language documents.
- Define exactly which values to extract from a field, such as when a date of birth field also contains the age.
- Use the Address data type for form fields, which identifies and extracts the structure of an address.

Enhancements to the Validator

- The Validator now shows the group number for documents processed in a learning instance connected from Automation 360 IQ Bot
- You can now configure a list of valid values when creating learning instance.
- When you click a field that requires validation, a message now appears with the confidence level determined by the system and the threshold set in the learning instance.

Monitor document processing metrics in Bot Insight dashboards

You can now visualize data, such as the number of documents uploaded per day, extraction time per document by learning instance, and STP percentage by learning instance, by using the customizable dashboards in the **Document Workspace** tab.

[Document Workspace dashboard](#)

Document Automation now supports the bring your own key (BYOK) use case for the Google Document AI product license

Users can now configure their Control Room environment with Google Document AI licenses purchased from Google. This allows the learning instance to send documents to Google Document AI for extraction and for the Control Room to track consumption in the **All licenses** page.

[Configure key for Google Document AI | Automation 360 licenses](#)

View Document Automation user activities in the audit log

With the **AAE_Admin** role or a custom role with the **View audit log** permission, you can now view the status of events related to learning instances, domains, and documents.

[Audit log](#)

What's new**Create and train standard forms within the Control Room**

Users with the **AAE_IQ Bot Admin** or **AAE_IQ Bot Services** roles can now create new standard forms in Document Automation. It is no longer necessary to leave the Control Room and open a third-party service to create or modify a standard form. The interface to configure the extraction model is launched from the **Learning instances** page.

Note: To process documents in a learning instance which uses the standard forms model in Document Automation:

1. Create the standard form in Document Automation.
2. Create and train the learning instance in Automation 360 IQ Bot.
3. Connect the learning instance to Document Automation.

[Create standard form in Document Automation](#)

What's changed

To connect a learning instance from Automation 360 IQ Bot, you must have one of the following roles:

- **AAE_IQ Bot Admin**
- **AAE_IQ Bot Services**
- A custom role with the **Connect learning instance** permission

Uploaded documents and extracted data are now removed after 90 days even if a document has not completed processing, except in the following cases:

- If data is downloaded and deleted, the source documents are immediately deleted.
- If the document is manually validated, the document is stored for 90 days from the date of extraction.

If a document is renamed to a new file extension and uploaded to a Google Document AI pretrained model, the document will fail processing.

Workaround: Rename the document to the correct file extension.

Fixes

Beside the **Validate documents** link, the value that reflects the number of documents awaiting validation is no longer hidden, and you can now view it without adjusting the width of the Actions column.

Previously, you had to adjust the width of the Actions column to see the value.

You can now successfully draw a box, zoom in, fit the box to match the screen size, and then redraw the box without any issue.

Previously, when you drew a box, zoomed in, clicked **Fit to screen**, and then tried to redraw the box, the box appeared at a different location from where you clicked.

Fixes
<p>In the Validator, you can now adjust the system-identified region (SIR) by dragging the corners of the SIR when you zoom in or zoom out.</p> <p>Previously, you could drag the corners of the SIR but not when you zoomed in or zoomed out.</p>
<p>When you connect to a learning instance from Automation 360 IQ Bot, if the learning instance has an optional field with a set default value and some fields that are unmapped, when you process documents in that learning instance in Document Automation, the default value now appears only in the mapped fields.</p> <p>Previously, the default value appeared incorrectly in the unmapped fields.</p>
<p>In Community Edition, when you try to delete a learning instance, the following, correct message is now displayed and you can successfully delete the learning instance: <code>Community edition users are limited to 5 learning instances</code></p> <p>Previously, although you could delete the learning instance, the following, incorrect message was displayed: <code>Community edition users are limited to 5 learning instances and will not be able to delete.</code></p>
<p>Fixed an issue where Document Automation sometimes failed to extract data from tables that span across multiple pages. Document Automation now supports data extraction from tables that span across multiple pages for Automation Anywhere models.</p>
<p>You can now use the Document Extraction > Download action in a standalone bot that is not part of an AARI process.</p> <p>Previously, this action could be used only in the <code>Downloadbot</code> within the AARI process that was automatically generated when a user created a learning instance.</p>
<p>After the Validator times out because of inactivity, when you refresh it, instead of showing the most recent document that you validated, the Validator shows the first document that you validated.</p>

Limitations
<p>Document Automation does not support Cloud-enabled (SDS) deployment.</p>
<p>Formula validation does not support numbers that contain delimiters. For example, <code>1,000</code> and <code>2.0</code> are not supported.</p>
<p>In some cases, the Bot Agent does not clear out its resources folder. Until the disk space is freed, the production documents in processing will be affected. This issue occurs intermittently.</p> <p>Workaround: Based on the issue, you must create a task scheduler to clean out the resources folder every day or every week.</p>
<p>There is no notification when the product license is about to expire. When the product license expires, the Learning Instances tab is removed from the Control Room.</p>
<p>Learning instances that use Google Document AI models do not reliably extract all the fields in a table, if the table that spans multiple pages.</p>
<p>In On-Premises installation in Linux environments, document processing sometimes fails because of a storage service error.</p> <p>Workaround: In the command prompt, run the following script:</p> <pre>cd /opt/automationanywhere/automation360/appdata/Server Files/ sudo chown -R crstorage:controlroom storageservice</pre>

Limitations
Document Automation does not support Oracle Database for On-Premises installations.
Document Automation supports only the following standard ports for On-Premises installations: <ul style="list-style-type: none"> • For HTTP: Port 80 • For HTTPS: Port 443
Sometimes, files uploaded to train a standard form appear corrupted although the data is still usable.
Standard forms in Document Automation is not supported in a multi-tenant Cloud Control Room that was upgraded from v.25. This limitation does not occur on a fresh installation of a multi-tenant Cloud Control Room.
Learning instances with the user-defined document type do not support Dutch language documents.
The first time you click a learning instance connected from Automation 360 IQ Bot, you are redirected to the IQ Bot homepage instead of the details page for that learning instance.
Formula validation is not supported for custom fields if the field name contains a space.
When you import a learning instance created in a previous version of Document Automation, the check box to send validation feedback to the system is unselected by default. You must edit the learning instance to select the check box.
Document Automation does not perform post-processing on connected learning instances that contain Python custom logic with either of the following: <ul style="list-style-type: none"> • Single quotes, such as <code>print('Test')</code>. Ensure the Python script uses only double quotes. • Characters from non-Latin languages (Unicode characters), such as <code>äöüññ</code>.
Formula validation is not supported in learning instances with the user-defined document type.
When you process documents using the IQ Bot Extraction package, the Python scripts are not applied properly on the form fields for the classic learning instances connected on Document Automation. This results in improper data extraction in the output CSV files and the Validator.
When you click the Table icon on Form OCR Testing Tool (FOTT) editor, the text appearing on the pop-up window is not readable.

IQ Bot

What's new
<p>When user logs out, lock released immediately on documents in Validator</p> <p>When a user logs out of IQ Bot, the lock on the documents in validation is now released immediately so that other users can view or validate the documents. Previously, when a document was in the Validator queue, if the logged out, the lock on the document in the validator was not released immediately, as a result of which other users could not view or validate the document.</p> <p><i>Use the IQ Bot Validator</i></p>

What's new**IQ Bot Database Migration Assistant Tool now supports Windows Authentication**

When you migrate from Enterprise 11 to Automation 360 by using the Database Migration Assistant Tool, you can now use Windows Authentication for connecting to the IQ Bot database server.

Choose classification type while creating learning instance

When you create a learning instance, you can now choose which aliases and fields are considered for classification by using the **Disable classification changes on domain modification (fields, alias)** check box.

- When this check box is selected, the classification process uses only the aliases or fields that were present in the domain when the learning instance was created. Aliases and fields added to the domain after the learning instance was created are not considered for classification.
- When this check box is cleared, the classification process uses all the aliases or fields that are part of your domain. Aliases and fields added to the domain after the learning instance was created are also taken into consideration for classification.

This feature classifies the document to the same group even if there are any updates in the domain.

What's changed**Upgraded machine learning models**

IQ Bot now uses an upgraded machine learning model for detection of check boxes and Advanced tables.

Python libraries upgraded to 64-bit

All the Python libraries provided in IQ Bot by Automation Anywhere for this release are now upgraded to 64-bit from 32-bit. If you are using third-party libraries, ensure that you upgrade to 64-bit libraries. After upgrading the third-party libraries, ensure that these libraries work successfully.

Fixes

When you download an unclassified document, click **Delete from the server**, and then toggle the learning instance from production to staging and back, the document no longer appears in the untrained folder. Previously, when you downloaded an unclassified document from the untrained groups, even after you deleted it, the document still reappeared in the folder.

Service Cloud case ID: 01781935

When you upload documents, the Classifier no longer halts or becomes stuck. Documents that are not classified are now cleared from the queue, allowing smoother processing of subsequent documents. If these documents fail to be processed within the timeout limit, they are now categorized as unclassified and you can download these unclassified documents.

Service Cloud case ID: 01762844, 01272642, 01750753

You can now install IQ Bot by using Windows authentication and CyberArk Vault and then rotate the key. Previously, when you tried to rotate the Vault key, the following error message was displayed: `Error occurred while setting up the new key. Please check the logs`

Fixes
<p>You can now select multiple learning instances for backup by using the Search drop-down list. Previously, after you clicked the Create Backup option on the Migration Management page, if you selected a learning instance and then used the Search drop-down list to select another learning instance, the previously selected learning instance became deselected.</p>
<p>The value displayed in the My totals > Accuracy field now matches the value in My learning instances > Field accuracy for the available learning instances.</p>
<p>You can now add documents to manually created groups and upload documents to staging. Previously, when you edited a manually created group or tried to upload a document, you encountered an error and the following error message was displayed: <code>Failed to update manual group: Duplicate label found.</code></p> <p>Service Cloud case ID: 01849616, 01845590</p>
<p>You can now use the migration utility to successfully migrate learning instances created for a custom domain. When you import IQBA files with duplicate fields (even through an API), the following message is displayed alerting you to the existence of duplicate fields: <code>Error: Duplicate field found Invoice number.</code> Previously, the migration utility could not be used to migrate learning instances created for a custom domain.</p> <p>Service Cloud case ID: 00729627</p>
<p>During migration, you can now successfully import and export IQBA files. Previously, the import and export of IQBA files failed because the content classification table contained duplicate training fields.</p> <p>Service Cloud case ID: 00826891</p>
<p>When a document is successfully downloaded, it is now placed in the Success folder. Previously, documents that were successfully processed were sent to the untrained folder, causing inconsistencies in the download process.</p> <p>Service Cloud case ID: 00780227,00842077</p>
<p>When there is an update in the domain, IQ Bot now classifies a document to the same group. Previously, whenever there was any update in the domain, IQ Bot created new groups for the same document.</p> <p>Service Cloud case ID:01622981</p>
<p>If a document without content is uploaded to a learning instance in production, the following message is logged in the <code>bot_launcher.log</code> file: <code>Unable to upload file <filename> to the Learning Instance. No content in file, size 0" whenever there is a 0 KB file is uploaded.</code></p>
<p>The security vulnerability related to Unquoted Service Path has been fixed. Previously, the Windows host referred to an installed service that used an unquoted service path containing whitespace Automation Anywhere Cognitive Console: <code>D:\Program Files (x86)\Automation Anywhere IQ Bot\Portal\node modules\winser\bin\nssm64.exe</code>, which resulted in the vulnerability.</p> <p>Service Cloud case ID:01880370</p>

Limitations
You cannot create a bot in IQ Bot when an invalid document is uploaded to a custom or manual group. Also, when an invalid document is uploaded along with a valid document and processed for extraction, the See extraction page keeps loading.
IQ Bot does not support Oracle Database for on-premises installations.
During production processing, if a learning instance is switched from Production to Staging or the other way around, for any documents processed during this switch, the production document that appears in Validator is blurred and not in human-readable form.
IQ Bot does not perform post-processing on a field if the custom logic uses Python script containing single quotes, such as <code>print('Test')</code> . Ensure the Python script uses only double quotes. <i>Custom Logic Python script challenges in A360.26 IQBot (A-people login required)</i>
If your IQ Bot custom logic uses the <code>Pandas</code> library, the script must have the <code>import Pandas</code> statement.
IQ Bot does not perform post-processing on a field if the custom logic uses Python script containing characters from non-Latin languages (Unicode characters), such as <code>äöüññ</code> .
In IQ Bot, when you run a script created on versions prior to Automation 360 v.26, you might see a warning. However, this does not impact the script execution and the functionality.

Related reference

[Automation 360 v.26 Release Notes](#)

[RPA Workspace v.26 release](#)

Review what's new and changed, fixes and limitations, and the feature deprecations in RPA Workspace for the v.26 release.

[AARI v.26 release](#)

Review what's new and changed and the fixes in AARI for the v.26 release.

[Bot Insight v.26 release](#)

Review what's changed and the limitations in Bot Insight for the v.26 release.

Bot Insight v.26 release

Review what's changed and the limitations in Bot Insight for the v.26 release.

What's changed

With the expanded user interface, you can now gain more insights into the Document Workspace. A new dashboard is available that delivers insights to Document Automation activity and trends, such as number of uploaded documents, pages and average extraction time. See more information in the following topic.

[Document Workspace dashboard](#)

Limitations

DataTable widgets for Bot Insight dashboards currently show a maximum of 100 records.

Service Cloud case ID: 01820004, 01851999, 00760252, 00806950

To avoid errors from occurring during bot lifecycle management, the private workspace dashboards will be imported only when the bot is imported directly to the private workspace.

Importing a bot to the public workspace and checking the bot out to the private workspace will not import the associated private workspace dashboards.

Service Cloud case ID: 00760022, 01803726, 01794757, 01777561, 01780407, 01842554, 01874606

Connectors for Bot Insight, such as Tableau or Power BI, work only with the following authentication mechanisms:

- Authentication based on Control Room database
- Authentication based on Active directory

Service Cloud case ID: 01863601, 01909212

Related reference

[Automation 360 v.26 Release Notes](#)

[RPA Workspace v.26 release](#)

Review what's new and changed, fixes and limitations, and the feature deprecations in RPA Workspace for the v.26 release.

[AARI v.26 release](#)

Review what's new and changed and the fixes in AARI for the v.26 release.

[IQ Bot and Document Automation v.26 release](#)

Review what's new and changed, and the fixes and limitations in IQ Bot and Document Automation for the v.26 release.

Automation 360 v.25 Release Notes

Release date: 28 June 2022

Review what's new and changed, and the fixes and limitations in the Automation 360 v.25 release.

- **Control Room:** Cloud Build 14304 (replaces Build 14298) and On-Premises Build 15112 (replaces Build 15097)
- **IQ Bot:** Cloud Build 14304 (replaces Build 14298) and On-Premises Build 15112 (replaces Build 15097)

Important: Manifest V3 based extensions - Google will deprecate Manifest V2 based extensions for Google Chrome by **January 2024**. . To know about Microsoft Edge Manifest V2 based extensions timelines, see [Overview and timelines for migrating to Manifest V3](#). The deprecation might impact your existing automation that use current Manifest V2 based extensions in Google Chrome and Microsoft Edge browsers. Use the Automation 360 v.25 Build 15118 and Bot Agent version 21.211 for the latest Manifest V3 based extensions updates to support features that use Google Chrome and Microsoft Edge browsers. This build is available for download in the link provided in the following article: [Everything about the Chrome/Edge Manifest V2 Deprecation](#). See [Chrome and Edge Manifest V3 extensions](#) and [Everything about the Chrome/Edge Manifest V2 Deprecation](#).

If you want to continue using the earlier builds of Automation 360 v.25 (Build 15112 or 15097) but want to upgrade to Manifest V3, you can manually upgrade to Manifest V3. See [Manifest extension manual upgrade](#).

Important: We have updated the Cloud Build 14304 and On-Premises Build 15112 to include fixes for the following issues. Fixes specific to On-Premises or Cloud builds are indicated.

- When you created or deleted new users, multiple, duplicate audit log entries were generated for a single user (Service Cloud case ID: 01836296).
- When you logged in to the Control Room with bot export permissions, when you exported a task, no corresponding entry was immediately visible in historical activity (Service Cloud case ID: 01834139, 01839933, 01841993, 01839817, 01834108, 01846407, 01845706, 01843349, 01846220, 01846819, 01845547, 01847028, 01847024, 01847094, 01847114, 01847115, 01846998, 01847840, 01846757, 01848123, 01846944, 01848104, 01848294, 01848905, 01846596, 01849748).
- When you updated to Automation 360 v.25 and attempted to use the previous settings with instance names, the previous settings were not allowing an update (Service Cloud case ID: 01838276, 01835897).
- (On-Premises only) When you deployed a task On-Premises without direct Internet access, the compilation slowed down (Service Cloud case ID: 01841448, 1839118, 1844817, 01846153, 01846332, 01839254).
- When the wait for condition package was used with any command package, the set timeout value for the wait was not met (Service Cloud case ID: 01842547, 01846156, 01847338, 01846324, 1842368, 01847054, 01848080, 01848789, 01848151, 01848963, 01847054, 01847121, 01848236, 01848260, 01849016, 01848248, 01848572, 01847828, 01847055, 01848826, 01848191, 01848944, 01851181, 01849792, 01852057, 01846152).
- When you update from any build to Automation 360 v.25, if changes were made to the If/Else logic in nest and saved, a new Go to End point element was added, which created a process error (Service Cloud case ID: 01848192).
- (On-Premises only) When an AARI process was checked in and then checked out, the mapped variables did not persist and were lost (Service Cloud case ID: 01847675).

This page includes the following sections:

- **Migration**
 - [11.x and 10.x](#)
 - [11.x only](#)
- **RPA Workspace**
 - [What's new](#) | [What's changed](#) | [Summary of changes in packages](#)
 - [Fixes](#) | [Limitations \(this release\)](#) | [Limitations \(previous releases\)](#)
- **Internet Explorer EOL updates**
 - [Features](#)
- **AARI**
 - [What's new](#) | [What's changed](#) | [Fixes](#) | [Limitations](#)
- **Discovery Bot**
 - [Fix](#)
- **Document Automation**
 - [New capability](#) | [Limitations](#)

- **IQ Bot**
 - [What's new](#) | [What's changed](#) | [Fixes](#) | [Limitations](#)
- **Bot Insight**
 - [What's changed](#) | [Fixes](#)
- **Automation Anywhere for Genesys**
 - [What's new](#)
- **Feature deprecations**
 - [Summary list](#)

Top 5 developer features in this release

View the following video on the **top 5** developer features:

Updating to this release

If you are on the previous build (Build 15097) of Automation 360 v.25, you must update to the latest Build 15112.

You can update to the latest version of Automation 360 from the previous three releases (that is, from $n-3$ releases, where n refers to the latest release).

The following previous releases are certified for update to Automation 360 v.25:

- v.24R2 (Build 13343), and v.24 (Build 12350, 12342)
- v.23 (Build 11513)
- v.22 (Build 10526)

See also [A360 | Upgrading to A360.23, A360.24, A360.25 from A360.22 \(A-People login required\)](#).

When updating from previous releases to v.25 (Build 15097), ensure that you review the information in the following article: [Error parsing the SQL instance name while upgrading to Automation 360 v.25 \(A-People login required\)](#).

If you are on one of these previous releases, for information about updating, see [Update to latest Automation 360 version](#). If you are not on an $n-3$ release, update Automation 360 to one of the $n-3$ releases before updating to Automation 360 v.25.

Bot agent update: This release includes an **optional** Bot Agent update. You can continue to run your existing bots without updating the Bot Agent. However, if you want to use the new features in Automation 360 v.25, you must update the Bot Agent available with this release.

For more information, see these resources:

- [Automatically update the Bot Agent](#) | [Manually update the Bot Agent](#)
- [Compatibility with Automation 360 builds](#)

For the latest updates to the Automation 360 extensions for Google Chrome, Microsoft Edge, and Mozilla Firefox, see [Enhancements to browser extensions](#).

Migration

Enterprise 11 and Enterprise 10 features
<p>Migrate TaskBots when the referred MetaBot Logic is renamed</p> <p>You can now successfully migrate TaskBots where referred MetaBot Logic name is renamed or has changed the relative path after mapping.</p> <p>If a MetaBot Logic is renamed or changed the path after being mapped in the TaskBot then the TaskBot is now migrated with the new MetaBot Logic name or path.</p> <p>The command path in the TaskBot is updated with the renamed name or with the updated path.</p> <p>Changing the relative path is applicable in the following scenarios:</p> <ul style="list-style-type: none"> • Logic is moved from one folder to another. • Logic is moved from a MetaBot root level folder to a sub folder. • Logic is moved from a sub folder to a folder at MetaBot root level. • The folder that has the Logic is renamed. <p>This enhancement applies to the following commands:</p> <ul style="list-style-type: none"> • Run Logic • If > Logic Successful • If > Logic Unsuccessful • Error Handling
<p>Enhanced Bot Scanner output report</p> <p>In the Bot Scanner output report, when you click the name of a bot that requires corrective action, you can now view the Line number of commands instead of the Total message count (frequency).</p>
<p>Migration support for Send Email action with multiple attachments</p> <p>You can now migrate bots that have the Send Email command with a filepath in a variable for the following scenarios:</p> <ul style="list-style-type: none"> • A single file is sent as an attachment. • Multiple attachments are sent in a single email. • Files are attached from a network drive.
<p>Migration support for Work Item variable (Service Cloud case ID: 01270496)</p> <p>You can now migrate bots with the Work Item variable for scenarios in which the Work Item variable includes the following:</p> <ul style="list-style-type: none"> • A number • Both number and string, for example, a message box • A date • A combination of Datetime and string, for example, a message box <hr/> <p>Note: If the Work Item variable is a Datetime type, the action Record:Assign is added automatically, which then gets converted to Datetime type string variable, before applying the Work Item variable.</p> <hr/>

Enterprise 11 and Enterprise 10 features

Variables created automatically after migration

In the Bot Scanner utility, bots that contain the following non-referenced variables are no longer flagged as **Action Required** or **Review Required**:

- \$FileName\$
- \$Error Description\$
- \$Error Line Number\$
- \$Extension\$
- \$Folder Name\$

After migration, the system automatically creates these variables according to the Automation 360 naming convention, and the migrated bots run successfully.

Migration enhancement to packages and actions

- If the migrated bots use the **PDF Extract Text > Structured Text** action, the new **Reduce Data Loss** option ensures that characters are retained in the extracted text and the bots run successfully.
- If you have bots with a specific Xpath expression in the SOAP Web Service package, ensure that the SOAP command output for **Selected Response** is returned accordingly by selecting **String Delimited** or **List of Strings**. For migrated bots, the **String delimited by None** option is selected by default.
- If migrated bots use the Terminal Emulator, the **Set cursor position to the beginning** option now enables you to edit the Terminal Emulator screen manually, and the focus is set to the beginning of the editable field. Note that this option is selected by default only when the **Show terminal** option is selected for these bots. (Service Cloud case ID: 00812730, 01252363, 01804623)

Support for 7-Zip

We have certified 7-Zip, a third-party tool, to handle backing up the Control Room repository with lengthy file names, bot names, and folder names. You can now back up and restore the repository of bots even when the length of the filepath to the repository of bots exceeds 256 characters. You can run either 7z.exe commands using the command line interface or run the 7.Zip as an application.

The 7-Zip tool support is available on the following Automation Anywhere certified Windows operating systems:

- Microsoft Windows Server 2016
- Microsoft Windows Server2019

You can download the 7-Zip tool from [7-zip Download page](#).

New Update window title action to update browser name in window title

When you are migrating Enterprise 10 or Enterprise 11 bots that use the Internet Explorer browser, the **Update window title** action now converts the window titles of these bots to Microsoft Edge with IE mode. The window titles are updated based on browser used by the bots. For example, consider bots that use Internet Explorer and have `Internet Explorer` in the window title. After migration, the new action updates the window title to reflect the new browser, Microsoft Edge, and the format of the text as `*Microsoft*Edge`.

[Using legacy Web actions](#)

Enterprise 11 only features**Automate objects that appear behind bot runtime window** (Service Cloud case ID: 00710929)

For the following commands, when you run a bot, you can now automate objects that appear behind the bot runtime window:

- **Image Recognition > Find window in window**
- **If/Else > Image Recognition > Window is found in window or not**
- **Mouse > Click**
- **OCR > Capture area or window**

RPA Workspace

What's new**Support for Azure Application Gateway**

On Microsoft Azure cluster environment for On-premises, Azure Application Gateway is now a supported load balancer..

[Supported data center component versions on Microsoft Azure](#)

Install Bot Agent on devices that have Enterprise 11 Enterprise Client

When you are creating a bot in Automation 360, you can now install the Bot Agent on a device with an existing Enterprise 11 Enterprise Client. You can create or run bots from both the Control Room instances.

[Install Bot Agent and register device](#)

IE 11 EOL notification banner displayed in Control Room

Starting from the Automation 360 v.25 release, if you use the Microsoft Internet Explorer browser to access the Control Room, you will be prompted to use an alternative supported browser, such as Google Chrome or Microsoft Edge (Chromium). When you log in to the Control Room, a notification banner is displayed indicating that support for Internet Explorer 11 is ending.

[Log in to Automation Anywhere Control Room](#)

Switch Bot Agent to another Control Room without reinstalling the Bot Agent

You can now enable a single-user device to be switched to another Control Room without reinstalling the Bot Agent. Log in as an administrator and select **Enabled** and the **Allow fast switching** check box from the device settings.

[Switch device registration between Control Room instances](#)

Configure the VM instance to delay Bot Agent registration

You can now configure the VM instance (golden image) to delay the Bot Agent registration until the user logs in to the Control Room from that instance. You can also configure up to 20 Control Room URLs so that you can use the same golden image to connect to any Control Room from that list.

[Perform installation of Bot Agent on multiple devices](#)

What's new
<p>Automation 360 support for Amazon Linux 2 on AWS EC2 environment</p> <p>Automation 360 now supports the Amazon Linux 2 operating system for Automation 360 On-Premises Control Room installation on the AWS Elastic Compute Cloud (EC2) environment.</p> <p>Amazon Linux 2</p>
<p>Out-of-sync licenses and Control Room license expiry</p> <p>When licenses are oversubscribed, the Control Room enters the fail-safe state and continues to operate in fail-safe mode for 30 days, after which the Control Room becomes locked.</p> <p>When a Control Room license is within 30 days of expiration, a warning message is displayed in a banner until the license either expires or is renewed.</p> <p>Control Room fail-safe status Control Room license expiry notifications</p>
<p>Support for integration with SIEM</p> <p>The Automation 360 Cloud Control Room now supports integration with security information and event management (SIEM) to forward the audit logs.</p> <p>Configure integration with SIEM</p>
<p>Enforce coding standards with code analysis</p> <ul style="list-style-type: none"> Code analysis enables you to define and enforce coding standards to improve automation coding practices. You can set different rules that will govern how you code. With code analysis, you can implement coding best practices and make the code more uniform, accessible, reliable, efficient, and secure. Two new permissions, View policies and Manage policies, are introduced in the Control Room for code analysis policy. <p>Code analysis</p>
<p>Two-factor authentication for Control Room users</p> <p>If you are a Control Room administrator, you can now enable two-factor authentication (2FA) for users logging in to the Control Room. 2FA provides an additional security layer for all logins to the Control Room, which can be set either for all users or for users with specific roles.</p> <p>Two-factor authentication</p>
<p>View version history of non-bot file dependencies (Service Cloud case ID: 01615105)</p> <p>You can now view the version history of your non-bot file dependencies. This helps to identify relevant changes made to your file by other users during a specific date and time along with the check-in messages.</p> <p>View version history of non-bot file dependencies</p>
<p>Edit non-empty folder names in private workspace (Service Cloud case ID: 00535388, 00730075, 00786633, 00791528, 01615295, 01820406)</p> <p>You can now edit your non-empty folder names in the private workspace. With this feature, you can now manage folders more easily. Ensure the following when you rename a folder:</p> <ul style="list-style-type: none"> It does not contain checked-out or cloned bots even at subfolder levels. It does not contain more than 100 items including subfolders and files. <p>Create and rename folders</p>

What's new**View dependency maps for bots**

You can now view the dependency map for your bot in both the public and private workspaces. The dependency map shows the immediate parent and child bots for any selected bot. If you are an RPA developer, you can use the dependency map to better understand where a bot is invoked and which child bots are invoked by the bot. With this information, you can gauge the impact of the change in a bot, use the bot effectively, maintain better bot code and reusability, and prevent conflicts.

[View bot dependency map](#)

Support to automate applications supported on Citrix Workspace app (Service Cloud case ID: 01758063)

The Citrix Workspace app is now supported on Automation 360. You can now automate applications that are accessed through the Citrix Workspace app by using the **Recorder** > **Capture** action or the **Start recording** option.

AI Sense Recorder: Support for Korean language and complex table operations

- You can now use AI Sense Recorder to automate applications that use Korean and a combination of Korean and English interfaces.

[AI Sense for recording tasks from remote applications](#)

- With AI Sense Recorder, you can now extract tabular data from complex tables. You can capture and automate tables with wider columns and tables that have columns with controls such as check boxes and options. You can also capture specific columns from tables.

Note: If the table is not detected automatically, use the **Define** option to detect the table.

[Table data extraction through AI Sense Recorder](#)

Enhancements to Recorder

- When you run a bot, you can now automate objects that appear behind the bot runtime window by using the **Recorder** > **Capture** action. (Service Cloud Case ID: 00684306, 00770636, 01146672)
- You can now use the Recorder to capture and automate objects with a specific technology. The **Capture object** tab now has the option to select a specific technology and capture using that technology. You can capture objects with the following technologies:
 - Microsoft Active Accessibility (MSAA)
 - UI automation
 - Microsoft (MS) COM UI Automation

[Capture using specific technology](#)

(Service Cloud Case ID: 01760871, 01865823)

- You can now use the Recorder to automate third-party plug-in window objects on Google Chrome or Microsoft Edge browsers by using a specific technology.

What's new
<p>Reduce Data Loss option in PDF package</p> <p>In the PDF > Extract text action, for the Structured text type field, a new Reduce Data Loss option is now available. When you use this option, you can extract the complete text with minimal overlap of characters.</p> <p><i>Using Extract text action from PDF</i></p>
<p>Enhancement to the String package (Service Cloud case ID: 00770822)</p> <p>In the String > Extract text action, a new When extracting option is now available. You can use this option to specify whether the case of the text in the extracted substring must match that in the source string.</p> <p><i>Using Extract text action of String package</i></p>
<p>Download files from URLs that require NTLM authentication (Service Cloud case ID: 01189873)</p> <p>With the enhanced Browser package, you can now download files from URLs that require NTLM authentication by using the Browser > Download file action.</p>
<p>New option in Connect action of the Terminal Emulator package (Service Cloud case ID: 00812730, 01252363, 01804623)</p> <p>You can now edit the screen of the Terminal Emulator session manually by selecting the Set cursor position to the beginning check box. By selecting this option, you can now set the focus to the first editable field. By default, this option is not selected.</p>
<p>Bulk update to default package version across bots (Service Cloud case ID: 00712719, 00728499, 00737694, 00803673, 01255722, 00838604, 00772147, 01760236, 01762679, 01771416, 01761859, 01782588, 01778220, 01784255, 01789551, 01809167, 01818690)</p> <p>Use Update bots to default package version to update bots to use the default version for any package. User with the View Packages and the permission to edit the bots can now update bots in bulk to use the default package version. This feature provides you with an efficient way to securely update all the bots in the Control Room repository that you have access to with the default package version in a few clicks.</p> <p><i>Update bots to default package version Example of updating default package version across bots</i></p>
<p>Advanced search feature in the Bot editor (Service Cloud case ID: 01615310, 01780115)</p> <p>The Bot Assistant now provides Advanced search capabilities to enhance the overall search experience in the Bot editor. This helps improve the productivity of the Bot Creator. The Advanced search page allows you to enter a search text, select the search filter criteria, and navigate through the search results. You can use the filter criteria to narrow down the search results and quickly locate the search text. When you edit or view a bot, you can use the advanced search feature to find the exact line of action and the corresponding action details where the search text appears, that is, as a string, text value, or a variable name.</p>
<p>Note: Find in this bot is now renamed to Search in this bot.</p>
<p><i>Advanced search feature in the Bot editor</i></p>

What's new
<p>Enhancement to multiple attachments option in Send email action (Service Cloud case ID: 00800976, 00817136, 00821405, 00936080, 01256523, 01256320, 01262069, 01259369, 00936080, 01801928)</p> <p>When you send email from bots, you can now send multiple attachments as a list of files or a variable that contains the list of file objects. With this feature, you can attach files such as data files, spreadsheets, and word processor documents to your email. You can attach multiple filepaths from a local drive or a network drive, or you can use a variable that contains a filepath.</p> <p><i>Using the Send action</i></p>
<p>Enhancement to SOAP Web Service package</p> <p>When you build a SOAP response for an Xpath expression in the SOAP Web Service package, the result of the Xpath expression can be stored as a list of strings.</p> <p><i>Example of using the SOAP web service action</i></p>
<p>Common table expression supported in Export to data table action (Service Cloud case ID: 00655318)</p> <p>You can now simplify complex joins and subqueries by using common table expressions (CTE) in SQL-compliant databases. Use CTEs in the Export to data table action of the Database package by using the WITH keyword.</p>
<p>Enhancement to OCR package</p> <p>When you use actions from the OCR package, such as Capture area or Capture window, the bot now identifies the controls even if the controls are behind the bot runtime window. It also extracts the text behind the Automation 360 bot runtime window from any application window.</p>
<p>New package SDK version</p> <p>You can now set up the default value for a global session by using default_session_value in CommandPkg in the newly released package SDK version.</p>
<p>Configure packages for On-Premises</p> <p>On-Premises administrators can now disable the latest package version from becoming the default version automatically. Administrators can also enable a feature that fetches and installs new package versions as and when they are released even without a Control Room upgrade.</p> <p><i>Automatic package updates for On-Premises Control Room</i></p>
<p>Workload automations supported on PostgreSQL and Oracle databases</p> <p>Workload automations are now supported on the PostgreSQL and Oracle databases, as well. All the workload automations work well with both the databases.</p> <p><i>Workload management</i></p>
<p>Trigger API</p> <p>Map triggers to users or roles for an attended Bot Runner user by using the Trigger API. With the Trigger API, you can also create and delete event triggers.</p> <p><i>Trigger API</i></p>
<p>Enhancement to the Authentication using apikey</p> <p>With .24 or previous versions, you must replace any escape character '\' with '\\' in the API key. With .25 or later versions, the API key will no longer have any escape characters('\').</p>

What's new
<p>Newly implemented Activity List API</p> <p>With the newly implemented Activity List API (<code>v3/activity/list</code>) you can return the job executions without call back and bot output information. The old Activity List API (<code>v2/activity/list</code>) is now deprecated.</p> <p>Activity list</p> <hr/> <p>Definition: <i>Deprecation</i> refers to features or capabilities available in the current (latest) release that will be removed or unsupported from a future release.</p> <p>You can use the specified alternatives or updated versions when they are made available.</p> <hr/> <p>Migrate from Enterprise 11 Control Room version 11.3.4.7 to Automation 360 On-Premises</p> <p>We now support migrating from Enterprise 11 Control Room version 11.3.4.7 to Automation 360 On-Premises v.25 and later releases.</p> <p>Supported Control Room versions for migration</p>

What's changed
<p>Enhancement to the String package (Service Cloud case ID: 00770822)</p> <p>After migrating bots, when you are extracting a text string based on a source string, the default option is set to not match the case of the source string. For new bots, the default option is set to match the case of the source string.</p>
<p>Enhancement to the Browser package</p> <p>In Enterprise 11, if a bot is using the Launch Website action to open a URL in Internet Explorer and when migrating the bot to Automation 360, if you select the Convert bots built using Internet Explorer to Edge with Internet Explorer mode option in the Settings panel of the Bot Migration Wizard, the URL is automatically set to open in Microsoft Edge after migration.</p>
<p>Option to change the global cache location (Service Cloud case ID: 00745395, 00781135, 00831182, 01124360, 01764952)</p> <p>As an administrator, you can now change the default location for global cache according to your requirements by going to Administration > Settings > Devices > Advanced options.</p> <p>Configure default device settings</p>
<p>Enhancement to database server for Control Room instance</p> <p>To set up the connection and authentication for your database server, use the port number of your database server instance (default port number, 1433) instead of the instance name.</p> <p>Configure Microsoft database type and server</p>
<p>For user credential changes, add new configuration for LDAP settings without causing in-progress authentication to fail</p> <p>When a user's credential is changed or updated, an LDAP settings page is now provided so that the Control Room administrator can add the new configuration for the LDAP settings without causing the in-progress authentication to fail.</p>

What's changed
<p>Support for exact match in the subject field for email triggers (Service Cloud case ID: 00953823)</p> <p>When you connect the Control Room to one of the email services on your system and trigger a bot when you receive a new email, the email trigger is now executed depending on the following subject conditions:</p> <ul style="list-style-type: none"> • When the subject line is provided within double quotation marks (""), for example, "ABC spreadsheet", the trigger is executed only when the email subject has an exact match for the string provided within quotation marks. • When multiple subject lines are separated by semicolons, for example, ABC spreadsheet; ABC project logs, the trigger is executed when the email subject matches any of the subject lines mentioned.
<p>Import Enterprise 11 bots with or without MetaBots (Service Cloud case ID: 01261325)</p> <p>You can now import the Enterprise 11 bots (.aapkg file) with or without the dependent MetaBots into the public workspace. If you are importing the .aapkg file into the private workspace, ensure that the dependent MetaBots are included.</p>

Summary of changes in packages

The following table summarizes the new and updated features in the Control Room packages:

Name of package or action	New or changed feature	Version number	Bot agent version
AI Sense Recorder	Support for Korean language and complex table operations <i>Korean language and complex table support</i>	2.7.3-20220527-004608	21.210 or later
Browser package	Support to download files from URLs that require NTLM authentication <i>NTLM authentication</i>	3.5.1-20220527-172031	21.210 or later
Database package	Support for common table expression in Export to data table action <i>CTE support in Export to data table</i>	4.8.0-20220504-130202	21.88 or later

Name of package or action	New or changed feature	Version number	Bot agent version
Email package	Support for sending mail with multiple attachments through bots <i>Send email with multiple attachments</i>	3.12.3-20220516-114854	21.210 or later
OCR package	Support to identify and capture controls behind bot runtime window <i>Support to capture controls that appear behind the runtime window</i>	2.10.0-20220502-204318	21.118 or later
PDF package	Support to extract complete text with minimal overlap of characters <i>Extract text accurately</i>	3.5.2-20220414-101844	21.31 or later
Recorder	<ul style="list-style-type: none"> • Support to automate objects that appear behind bot runtime window <i>Automate objects behind bot runtime window</i> • Support to automate objects with specific technology <i>Automate objects with a specific technology</i> • Support to automate applications accessed through Citrix Workspace app <i>Automate applications on Citrix Workspace app</i> 	2.7.3-20220527-004608	21.210 or later
SOAP Web Service package	Support to store output of Xpath expression as list of strings <i>Store Xpath expression output as a list of strings</i>	3.11.3-20220426-064423	21.90 or later

Name of package or action	New or changed feature	Version number	Bot agent version
String package	Support to match case of text in extracted substring to that in source string <i>Match case of substring to that of source string</i>	5.4.2-20220412-134724	20.18 or later

Important: For information about the packages supported with this release, see also [View package versions available in the Control Room](#).

Fixes		
Build	Service Cloud case ID	Description
15112	01838276, 01835897	When you update to Automation 360 v.25, an error no longer occurs when the database server includes the instance name.
Builds 14304 and 15112	01834139, 01839933, 01841993, 01839817, 01834108, 01846407, 01845706, 01843349, 01846220, 01846819, 01845547, 01847028, 01847024, 01847094, 01847114, 01847115, 01846998, 01847840, 01846757, 01848123, 01846944, 01848104, 01848294, 01848905, 01846596, 01849748	When you successfully export a bot, the latest bot export activity is now displayed on the Historical activity page. Previously, the latest export event was not displayed as the Ended on column was displaying the value as N/A.
Builds 14304 and 15112	01836296	When you delete a user or a role, only one entry is now generated for each action in the audit log. Previously, multiple duplicate audit log entries were generated for a single action, affecting the user management workflows.

Fixes		
Build	Service Cloud case ID	Description
Build 14304 and 15112	01842547, 01846156, 01847338, 01846324, 1842368, 01847054, 01848080, 01848789, 01848151, 01848963, 01847054, 01847121, 01848236, 01848260, 01849016, 01848248, 01848572, 01847828, 01847055, 01848826, 01848191, 01848944, 01851181, 01849792, 01852057	When you use the Wait > Wait for condition action with conditions that have specific timeout values set, the bot now waits only for the specified waiting time then runs the subsequent action. Previously, even when you specified a timeout value, the bot waited indefinitely.
15097	01274643, 01812436	If you have a function in a DLL that uses a credential variable as an input parameter and if the credential variable is not available in Automation 360, you will see the A108 migration message. Previously, you used to see the E153 migration message. <i>Migration messages</i>
15097	--	You can now migrate bots even if the date and month are in single-digit or double-digit format and the year is in single-digit, double-digit, or quadruple-digit format for the Modified before and Modified between dates in the File and Folder action. Previously, you had to specify the dates in the MM/DD/YY format before migrating the bots.
15097	01260742	After migration, when the system passes a Credential Value (CV) type variable from a parent bot to a MetaBot Logic's non-CV variable, the temporary string-type variable that is created to hold the CV now does not exceed 50 characters or include an invalid space character.
15097	00796546	The Bot Insight pre-migration utility can now resolve corrupted dashboard IDs that are present in the BI tables and generate the dashboards.zip file for the migration. Previously, when corrupted dashboard IDs were detected in the BI tables, the Bot Insight pre-migration utility encountered an error and closed.

Fixes		
Build	Service Cloud case ID	Description
15097	01758427, 01805913	<p>In the SAP application, when you use the Click action control, the tabs are now selected precisely.</p> <hr/> <p>Note: The Type value in Enterprise 11 is renamed as Role in Automation 360.</p> <hr/> <p>When you migrate from Enterprise 11 to Automation 360, the Role value is automatically set to the value that was the SAP Control Type value under SubType if the Type value in Enterprise 11 was set to GuiShell. For example, in Enterprise 11, if the Type value was set to GuiShell and the SubType value was set to Gridview, in Automation 360, the Role value is automatically set to GridView.</p>
15097	01376353, 01449535, 01713118, 01627144, 01762404	<p>When you update your Control Room from Automation 360 v.21 or v.22 to Automation 360 v.25, the installation now completes successfully without any issues. Previously, the installation failed when users who created migration schedules lost the permissions after migration.</p>
15097	01257547, 01722892, 01291187, 01770716, 01777450	<p>You can now edit or delete a schedule because you can no longer delete an .atmx file that is associated with a schedule from the Automation 360 Control Room. Previously, the .atmx file could be deleted, which resulted in an error that prevented you from editing or deleting a schedule.</p>
15097	01255723, 01252824, 01260677, 01608653	<p>When you migrate Enterprise 11 bots with the Comment command enabled, the command now remains enabled after migration.</p> <hr/> <p>Note: If the Comment command contains a variable or a \$ symbol, the command is disabled after migration.</p> <hr/>
15097	01755175	<p>You can now migrate bots with system variables (such as date, month, or year) as an Export Data to CSV option without encountering an error.</p> <p>Previously, a preprocessing error was displayed in such cases.</p>
15097	01261863	<p>You can now migrate bots with system variables or expressions that include array variables without an error. Previously, a preprocessing error occurred in such cases.</p>

Fixes		
Build	Service Cloud case ID	Description
15097	01758814	You can now migrate bots when the MetaBots Logic call each other and another, third Logic calls one of these in recursion. Previously, in such cases, bot migration failed with an "An unexpected error occurred" message.
15097	01255810	When you perform the Send Text action two times for the same value in the Terminal Emulator and the first field is protected, when the Terminal Emulator screen is loaded for the second time, it now works properly after the migration. Previously, when the Terminal Emulator screen was loaded for the second time, an incorrect behavior was observed.
15097	01770547	In Automation 360 commands, expressions in which a variable is included within parentheses and is preceded by a \$ character are now migrated properly, with the variable inside parentheses prefixed and suffixed with the \$ character.
15097	01258964	After migration, the Capture action can now identify popup windows that use the same title as that of a main window in the SAP GUI. Previously, the Capture action could not identify popup windows that used the same title as that of a main window.
15097	00745395, 00781135, 00831182, 01124360, 01764952	If the path for global cache exceeds 256 characters, Automation 360 automatically changes the path to the default location although the path in the UI displays the path configured by the user. Previously, when the path for global cache exceeded 256 characters, Automation 360 displayed an error when downloading packages.
15097	01767018, 01755092, 01765551, 01764245, 01778477, 01782790, 01795043	If a user does not have access permission for a trigger or a folder with trigger under the public tab, no error message is now displayed on the event triggers page. Previously, if a user did not have access permission, the event trigger page for the user displayed an error under the public tab.
15097	01765445,01759831, 01779960, 01799422	When you log in to the Control Room as an administrator, you can no longer delete users that have active schedules.
15097	01255678	In the Manage > Devices page, the Modified by column now correctly displays the username of the latest user to modify the details. For example, if user1 registers a device and later user2 modifies the device details, such as Deployment type , the username of user2, instead of the username of user1, is displayed in the Modified by column.

Fixes		
Build	Service Cloud case ID	Description
15097	--	When you are installing the Control Room (On-Premises), even if an external key vault is configured, you can now manually enter the database credentials and configure them for database authentication in the Windows installer Database Server page.
15097	01753671	When you update to this release, in the View history Task Bot page, the Checked In and Checked In By columns now display the correct information.
15097	--	Now when you run bots that have the Get Total Rows command in the SAP GUI, the values are returned as Integer data type. Previously, such commands returned values as a Float string type.
15097	01212822	During workload automation, you can now view and use queues even if the name of a work item template contains leading or trailing spaces. Although the spaces are displayed in the queue name, they are automatically removed when the work item template is created. Also, leading or trailing spaces in queue names are ignored during execution. Previously, queue names and template names with leading or trailing spaces were not displayed and hence were unavailable for selection.
15097	01772061	When you update to this release, Automation 360 does not allow multiple license-sync jobs to run concurrently. Previously, when multiple license-sync jobs were running, the audit logs displayed Licenses synced errors.
15097	01754415	When you update from Automation 360 v.21 or later, the Bot Agent devices are no longer shown as disconnected in the Control Room Manage > Devices page. When you try to update Bot Agent in versions prior to Automation 360 v.21, a message now indicates that the device is not compatible.
15097	01780460	<p>When you update to this release, the Control Room Advanced options for devices (Administration > Settings > Devices), such as Autologin timeout, Maximum simultaneous downloads, and Bot response wait time, no longer revert to default values.</p> <p>For example, if you set the Autologin timeout to 70, after updating to this release, the value remains at 70 and does not change back to the default value.</p> <p>Previously, when you upgraded the Control Room, for example, from Automation 360 v.22 to Automation 360 v.23, the Advanced options for devices reverted to default values.</p>

Fixes		
Build	Service Cloud case ID	Description
15097	01762582, 01808698, 01815446	The Control Room Activity page now displays the total number of scheduled activities correctly. Previously, when you had more than 200 scheduled activities, the Control Room Activity page displayed only 200, and you had to sort by the Activity name , Automation priority , or Modified by columns to view the correct number of scheduled activities.
15097	01764492	When you install Automation 360 Control Room, the installer-generated log file no longer displays the password in clear text.
15097	--	In the Administration > Settings > Email page, if the Require verification option is not selected, you no longer receive a verification link in the email notification to verify you as a user. You can now log in to the Control Room without verifying the email ID and setting the login credentials. Previously, an email notification with verification link was sent to verify the email address even if you did not select the Require verification option.
15097	01783110	When you launch a bot, if the bot fails during the run, the Activity > Historical page in the Control Room now shows the correct Started on time, that is, the time when the bot started running. Previously, when a bot run failed, the Started on time incorrectly showed the time when the bot failed. As a result, the Started on and Ended on columns displayed the same time, which was incorrect and confusing.
15097	01826944, 01828683	When you log in to the Control Room, the Activity > Historical page now loads without error. For the historical data in the <i>JOBEXECUTION</i> table, a new Cloud data retention policy of 90 days is implemented, whereby the Cloud historical data is deleted along with the rollout of Automation 360 v.25 to the different regions. Previously, when you logged in to the Control Room, the Activity > Historical page did not load because of a large number of records, and the following error message was displayed: An unexpected problem has occurred <ul style="list-style-type: none"> • View completed activity • Automation 360 Cloud FAQ
15097	01753337, 01785865	On the Activity > In progress page, when you use the sort function to list the items in the Started on column in ascending or descending order, the items are listed correctly now.

Fixes		
Build	Service Cloud case ID	Description
15097	--	You can now successfully establish a secure SQL connection in the Linux environment by choosing the Enable option in the Database Configuration > Secure Configuration > Secure Connection field. The Linux installer now successfully imports the SSL certificate, and the connection is established. Previously, the Linux installer failed to import the SSL certificate and the connection was not established.
15097	00781974	In the Linux environment, you will no longer encounter issues with services stopping due to disk storage issue. Previously, some of the Control Room log messages were stored in the /var/log/messages file instead of the /var/log/automationanywhere directory, leading to low disk space.
15097	01260701	When you run bots on user devices, bots no longer become stuck in queues. Also, the following messages are no longer displayed: <ul style="list-style-type: none"> • Waiting for user <i>username</i> • Picked at runtime
15097	01760032	Domain names are no longer case-sensitive, and you can now create users by using the Active Directory group mapping and map a role to a user in the Control Room. Previously, because some Active Directory servers were returning domain names in uppercase whereas others were in lowercase, domain names could not be found and there was an issue with the group mapping feature.
15097	00828289	The Global Value fields are now validated and have a maximum length of 4000 characters.
15097	00828289	When you navigate to My settings > My Profile > Edit in the Control Room and provide a link, for example, <code>LinkInjection</code> , the email sent contains a link, and the email text sent is validated against HTML injection and you will no longer see a functional link.

Fixes		
Build	Service Cloud case ID	Description
15097	01754431, 01773662, 01789555, 01791065, 01784255, 01785653, 01780070	<p>When you use the Recorder to capture an object, set the waiting time for detecting the object to fewer than 30 seconds in the Keep trying for (seconds) field, and run the bot, the Recorder now waits for the specified time to detect the object and waits for the page to load completely. Previously, the Recorder waited for a minimum of 30 seconds to detect the object regardless of the time specified.</p> <hr/> <p>Note: This fix is applicable only to Google Chrome and Microsoft Edge Chromium browsers.</p>
15097	01614810	You can now use a blank space as the delimiter in the Specify delimiter (optional) field. In the Open action of the CSV/TXT package, when you browse the filepath to open a file, add a blank space as the delimiter in the Specify delimiter (optional) field, and run the bot, the blank space is now treated correctly as a delimiter and the bot no longer fails.
15097	01387738	When you use the Browser > Open action to open a new window in Google Chrome, the new window is now activated and displayed in front of the other open windows. Previously, when you ran a bot, the window remained in the minimized state.
15097	01273095	When you enter a decimal value with 16 or more decimal points in a cell of a Microsoft Excel spreadsheet and when you use the Read cell value option in the Excel advanced > Get single cell, Get multiple cells, or Get worksheet as data table actions to retrieve the decimal value from the cell, the format of the cell value no longer changes from General to Scientific .
15097	01144509, 01767881	When you connect to an SAP session, use the If > Object exists Recorder condition to identify and capture objects on the SAP application, disconnect the SAP session, and then run these actions in a loop, the bot now detects the objects correctly in every iteration of the loop. Previously, when the bot was run in a loop, it captured the objects correctly only during the first iteration and failed during subsequent iterations.
15097	01769573	If you use the App integration > Capture text of window action to capture the text in a command prompt window, when you run the bot, the bot now captures all the characters in each line correctly. Previously, the bot failed to capture the last characters in each line.

Fixes		
Build	Service Cloud case ID	Description
15097	01628448, 01766957, 01788709, 01788801, 01789538, 01803156, 01781597, 01810230, 01811694, 01802054, 01815687, 01823526,01814962, 01833962, 01835418, 01835382, 01837832,01830790	The Excel advanced package now works as expected and without any issues. Previously, the package threw a generic exception error intermittently.
15097	00824995, 01451063, 01274854	In the PDF > Extract field action, when you select the Open PDF viewer option, select a PDF file from the Control Room or Desktop, click Load , and open the PDF viewer, you can now view the PDF document. Previously, when you selected the Open PDF viewer option to view the selected PDF document, a blank page was shown, and you could see the value in the PDF document only when you selected a specific rectangular area in the blank field.
15097	00957308	In the File > Copy Desktop file action, when you specify a source filepath where the folder name contains a number sign (#) character or the filename contains a wildcard character, specify a destination filepath to copy the file, and run the bot, the bot now detects the source filepath and copies the file to the specified destination location successfully. Previously, when you ran the bot, the bot failed to detect the source filepath and hence did not copy the file to the destination folder.
15097	01685239	You can now use the Recorder to capture objects on the Citrix Xenapp application, use the If > Object does not exist condition to verify whether a specific object exists in the application, and successfully run a bot from a parent bot. Previously, when you tried to do this, an error occurred.

Fixes		
Build	Service Cloud case ID	Description
15097	01260387	A password-protected Microsoft Excel file is no longer corrupted when you open the file manually after successfully running a bot using the Excel basic package. Previously, when you used the actions in the Excel basic package to open a password-protected Excel file, made some updates to the file, and closed the file by selecting Save changes when closing file in the Excel basic > Close action, the password-protected Excel file became corrupted when you opened it manually from its location.
15097	00920617	When you connect to your mailbox through the IMAP protocol, use For each mail in mail box as email loop iterator to retrieve all email message received before date filter, and run the bot, the bot now retrieves all the email messages received before the specified date, including the email messages received on the specified date before the specified time.
15097	--	In Google Chrome, Microsoft Edge, and Mozilla Firefox browsers, you can now successfully open network URLs that start with two backslash (\) characters by using the Browser > Open action.
15097	01015001	When you specify the total number of packages that you want to view per page under the Manage > Package section in the Control Room, the page now displays the correct number of packages specified. Previously, all the packages were displayed on a single page even if you chose to view only a specific number of packages.
15097	01711629	In the Recorder > Capture action, when you select a specific browser window whose title matches another browser window from the Browser tab and run the bot, the bot now accurately opens the selected browser window. Previously, when the title of two browser windows matched, the bot randomly opened a browser window with a matching title.
15097	--	You can now use the Browser > Run JavaScript action to successfully run JavaScript on web pages that have iFrames.
15097	01075660, 01273111	The Excel advanced > Open and Create workbook actions now display the Default session value under the Local session field.

Fixes		
Build	Service Cloud case ID	Description
15097	01252773, 01278029, 01772301, 01765017	<p>An error no longer occurs when you use the Excel advanced > Open action to open a worksheet that is a type of hidden chart or a macro. You can specify the sheet name to open the worksheet of type macro.</p> <hr/> <p>Note: When you open the default sheet, ensure that the active sheet is an Excel Worksheet. If the active sheet is of type chart, the following error message is now displayed: The Excel file does not contain an active sheet to open. Please make sure the Excel file you want to open has at least one active sheet.</p> <hr/>
15097	--	After migration, when you run the bots that use File and Folder packages, the year under the Date option now accepts the value 00 as input, which is considered as year 2000.
15097	01257829	In the REST Web Services package actions, you can now add a <code>Custom</code> content type, using which you can add content that does not fall under a standard content type.
15097	--	In the REST Web Services package actions, you can now perform Add Substitution , using which you can enter variables in the REST request body.
15097	01784553, 01794924	In the SOAP Web Service package actions, the ampersand character (&) is now automatically escaped. Previously, the ampersand character (&) which is a reserved control character, was not automatically escaped, which resulted in invalid XML files.
15097	01767571	In the REST Web Services package actions, new lines in the request body are no longer altered at runtime. For example, when the request body contains a new line, it is no longer replaced by a space at runtime. Previously, when a request body contained a new line, it was replaced by a space.
15097	00773353, 00787270	In the REST Web Services package actions, you can now use the user token option to access the Control Room APIs. When you log in to the Control Room, a token is generated, which is used by the bot to access the endpoints of the Control Room API used within the bot.
15097	01372460	You can now run bots by using the RunScript action of the Legacy Automation package. When you pass multiple arguments to replace values from a Microsoft Word document, the bot now runs the function and replaces and displays the text on a new line. Previously, the text was displayed on the same line.

Fixes		
Build	Service Cloud case ID	Description
15097	01758458	When you use the Connect action to establish a connection with an email server, use the Disconnect action to close the connection with the same session name. You will then not encounter any issue when you establish a new connection again with the same or different credentials.
15097	01273357	You can create a bot to run a standard workflow in SAP BAPI , and the output is now generated correctly as a .CSV file. Previously, when you ran a standard workflow in SAP BAPI , the generated output was varied.
15097	01342887	When you run a process by using the Terminal Emulator package, the terminal window is now activated and remains in the front. Previously, when you ran a process, the terminal window was not activated and stayed minimized.
15097	01251933	In the Terminal Emulator package, when you use the Connect action to establish a connection with TN3270E, an error no longer occurs. Previously, an error occurred, and the following error message was displayed on the mainframe screen: ISPP904 Panel ISR@PRIM error - x'0E' or x'0F' is invalid as an attribute character
15097	01432885	When you run a bot, the Task bots run metric on the Home dashboard page of the Control Room now displays the correct count. Previously, the metric displayed an incorrect count. For example, on the Home dashboard page, if the Task bots run count showed 39, when you ran the bot, the count displayed was 42 instead of 40.
15097	00742840	When you use actions such as Open and Run function from the DLL package, you no longer encounter any issues. The bot now opens the DLL file even if the DLL filepath length is fewer than 256 characters.
15097	01261786, 01615115	When you edit a bot and disable any action within it, you can now use the Ctrl+Z keyboard shortcut to undo an action. Previously, the Ctrl+Z keyboard shortcut did not work as expected.
15097	01080067	In the Active Directory package, when you use usernames with special characters, the bot now runs successfully. Previously, when you added a user to a group, if the username had special characters, when you tried to remove the user from the group, the bot failed.

Fixes		
Build	Service Cloud case ID	Description
15097	00962414	You no longer encounter an issue when you connect to a puTTY application through Terminal Emulator. Previously, when the terminal was connected to the host, the host prompted for a password. Subsequently, the terminal screen went blank, and the bot displayed the following error: <code>Unable to connect to a terminal. Please check connection details</code>
15097	00829259	In Active Directory, you can now successfully create a user with one of the following options: Require password change at next login or Do not require password change at next login . Previously, when you used the Connect action to establish a connection, if the LDAP connection path contained the <code>OU</code> attribute with a space value such as <code>OU=aa unit</code> , an error occurred when you ran the bot.
15097	00961069	When you are using the Send text action from the Terminal Emulator package, you can now send numeric keyboard minus (-) keys with Alt+- (Alt +hyphen) keys to the mainframe application.
15097	00825675	When you delete the variables mapping from parent and child bots and then run the parent bot, the bot no longer encounters an error. Previously, when you deleted the variables mapping from parent and child bots and then ran the parent bot, the bot failed.
15097	00798604	When you use the Run Function action from the VBScript package, the bot no longer encounters an error. You can now specify the function name to run and pass arguments that contain brackets ([]). Previously, the Run Function action failed to run if an open or close bracket was included in any position in a string parameter.
15097	--	When you use a DLL file that is available in the Control Room, and if the DLL filepath is fewer than 260 characters, the bot now retrieves the DLL file successfully.
15097	01149730	You can now connect to an email server, select the IMAP protocol, use Loop > For each mail in mail box iterator, and successfully download attachments from an email message and save them to a specified folder. Previously, if the attachments had a <code>bin</code> file, the attachments were not downloaded or saved to a folder.

Fixes		
Build	Service Cloud case ID	Description
15097	00919896	When you use actions such as Send text or Send key from the Terminal Emulator package, the bot launcher no longer stops working. Previously, bots created using actions from the Terminal Emulator package sometimes stopped working at random when a double-byte character set (DBCS) was enabled and the host screen had a wrapped field.
15097	00950682	You can now use the Open spreadsheet action in the Google Sheets package without any issue, even if you use a Proxy Auto-Configuration (PAC) file or a proxy-enabled environment.
15097	01257464	When you connect to an email server with the IMAP configuration and use the Move all action with a filter for all mail received before a certain date, all email messages that meet the criterion can now be moved from one folder to another without any issue.
15097	01753270	In the Google Drive package, you can now use the Create file permission action with the File ID option. Previously, when you used Create file permission , if no other Google Drive action was placed before it, an error occurred.
15097	01276141	In the email package, when you use the Move all action or the Loop > For each mail in mail box iterator, you can now add any number of email addresses in the From specific sender field. Previously, the email loop did not work if the From specific sender field had more than two email addresses.
15097	01689348	You can no longer import bots with incomplete package files from one Control Room to another because the system now disallows and rejects the import of incomplete package files.
15097	01763262, 01762153	You can now create a bot and run stored procedures successfully. Previously, if you had two stored procedures in different databases, for example, <code>Database_A.dbo.SP_A</code> and <code>Database_B.dbo.SP_B</code> , in the SQL Server, if you were connected to <code>Database_A</code> and wanted to run the stored procedure in <code>Database_B</code> , the execution failed because the fully qualified stored procedure name was not supported in the Run stored procedure action.
15097	--	You can now successfully download exported bots by navigating to Activity > Historical > Bot Export: Export.<date_name > Download exported zip file .

Fixes		
Build	Service Cloud case ID	Description
15097	01762348	Bots that are deployed from the Control Room on user devices are no longer stuck in a queue after the unattended Bot Runners are added from a device pool.
15097	01151181	If you have the required permissions, you can now successfully delete an inactive schedule from the Manage > Scheduled > Scheduled activity page. Previously, even if you had the required schedule permissions, when you tried to delete an inactive schedule, you encountered an error message about permissions.
15097	00917927, 01255618	The Modified by field in the Manage > Scheduled page now displays the correct username for recurring schedules. Previously, when schedules were imported from one environment to another, the Modified by field showed the username of the original Bot Creator or administrator.
15097	01778350, 01803570	When you create a schedule in the Control Room, the Manage > Scheduled > View activity > Schedule page now displays the correct end time for the End date field. Previously, when an end date was selected for a schedule, the end time shown for the End date field was incorrect.
15097	--	In the Kubernetes environment, when you try to create a queue, you no longer encounter an error.
15097	00716776, 00778659, 01820190, 01856732	If you check out an item at certain time T1 and then cancel the checkout later at time T2, the canceled checkout is not considered as a modification to the item. Also, the last modified time is rolled back to time T1 that is when the bot was checked-out last time from the Public folder. Previously, the canceled checkout at certain time T2 was incorrectly considered as a modification to the item. Also, the last modification time was incorrectly shown as time T2 that is when checkout was canceled. Thus, it was difficult to keep track of actual modification dates of items.
15097	--	In the Kubernetes environment, you can now delete work items even after pausing a queue. Previously, when you paused a queue and tried to delete a work item, an error sometimes prevented you from deleting the work item.
15097	01255617	The WLM filters in the Queue > Work items page now return accurate results. Previously, filters were not working accurately when you combined them.

Fixes		
Build	Service Cloud case ID	Description
15097	01806221, 01805371, 01818356, 01828330	After you update to Automation 360 v.24, WLM tasks no longer fail. Previously, after an update, bot execution processes or actual bot execution sometimes failed, resulting in the failure of WLM tasks as well.
15097	01769740	Bot descriptions are now displayed even after you check in or check out bot. Previously, after you checked in or checked out a bot for the first time, the bot descriptions stopped being displayed.
15097	01764336	An appropriate error message is now displayed when you try to change the work item status from Ready to run to On hold or Complete . The error message now informs you that because the queue is already in use, you must either pause or stop a queue automation to change the status of the work item. Previously, the error message displayed did not help with rectifying the issue.
15097	01273374	The <code>gettasklogdata</code> API now shows real-time data, whereby local time values are converted to UTC values for that API request.

The following table lists the limitations identified in the current release:

Limitations
<p>Bots whose queue category name contains a space (for example, Input – Emails) cannot be migrated because during migration, such bots enter and remain in an infinite loop until the loop times out at 90 minutes. (Service Cloud case ID: 01850864)</p> <p>Workaround: You can migrate to Automation 360 v.26 release where this issue is fixed or remove the space in the queue category name and then migrate the bots.</p>
<p>After you migrate your bots, an error occurs in the following situations:</p> <ul style="list-style-type: none"> • When you use FTP actions on bots with commas in filenames • When you use the Delete files and Delete folder FTP actions on bots with colons in filenames <p>Workaround:</p> <ul style="list-style-type: none"> • For bots that use FTP actions, ensure that you remove commas from the filenames. • For bots that use the Delete files and Delete folder FTP actions, ensure that you remove colons from the filenames.
<p>When you try to migrate bots in which the If condition is used for more than 95 times in a single line, migration fails with the following error message: <code>Unexpected response status: 500</code> (Service Cloud case ID: 01830793)</p> <p>Workaround: Divide the bot into multiple logical sub-bots.</p>

Limitations
<p>(Service Cloud case ID: 01773164) If the number of cells in a table object exceeds 300,000, the Control Room might become unresponsive.</p> <p>Workaround: Ensure that the number of cells in a table object does not exceed 300,000.</p>
<p>Even if the Control Room path is invalid or does not exist, the invalid path is still displayed instead of the default path: C:\ProgramData\AutomationAnywhere\GlobalCache\</p>
<p>When you run a migrated bot with the Recorder package, the Click Action on Client Control might not work. This issue occurs because some Microsoft Windows operating systems might not be activated properly on a few Windows applications.</p> <p>Workaround: Use the Left Click action.</p>
<p>When you try to re-edit a migrated bot with the Record > Dataset variable, an error occurs, and the following error message is displayed: An unexpected problem occurred. If the problem persists, please contact your system administrator.</p> <p>Workaround: Refresh the Bot editor page to reload the details.</p>
<p>A parse error occurs when you run a migrated bot with the Email Received Date variable used twice in subactions inside the Email loop action.</p>
<p>When you create a bot by using the Send email action, if the attachment includes the less-than symbol (<) as a special character in the filepath, the special character will be removed after bot execution. The Windows operating system does not support this special character.</p>
<p>In a bot, when you create a List variable with the File subtype, select the value as a Control Room file, and add the List package, the bot execution fails when you run the bot.</p>
<p>If your bot has an error, you add the Try/Finally block around the corresponding actions, and insert more actions in the Finally block, when you save and run the bot, the Bot error dialog shows the wrong error line number within the Finally block.</p> <p>Workaround: If you are using Try and Finally without using the Catch action, the Bot error dialog does not show the correct line number. Instead, use Try/Catch. The Try action handles the error and sends execution to Catch with line number and description. This gives the correct line number within the Finally block.</p>
<p>When you frequently connect to the Excel or Access (Microsoft Office 2016 or later) engines with ODBC drivers, bot execution fails intermittently.</p>
<p>When you use the Connect action to connect with the EWS protocol, read email skips the newline characters and prints the email message body on a single line. This issue is also observed in the Send email action. Following are the scenarios where these issues are observed:</p> <ul style="list-style-type: none"> • Create a bot and connect with the EWS server. Use the Loop action to read emails as a plain text message and use the Log to file action to log text into a file. • Use the Send email action and connect with the EWS server with OAuth authentication to send the email.
<p>In a device pool, when you select the Run bot now option for a WLM bot, the WLM bot run is triggered and an error message is also displayed.</p> <p>Workaround: To run a WLM bot in a device pool, ensure that you select the Run bot with queue option.</p>
<p>In a multitenant environment, when you upload a work item file to queue in one of the tenants, the In progress tab displays the same work item file for all the other tenants, as well.</p>

Limitations
<p>In a device pool, when you stop a WLM automation, a few work items are still in the ready-to-run state. As a result, these work items cannot be deleted.</p> <p>Workaround: To delete work items that are in the ready-to-run state, perform one of the following actions:</p> <ul style="list-style-type: none"> • Pause and stop the automation. • Rerun, pause, and then stop the automation.
<p>After migration, when you use the Excel advanced > Open action to open a file with the Load Add-ins option enabled and the system has COM add-ins enabled, when you run the bot, the bot might fail with an error.</p> <p>Workaround: Disable the Load Add-ins option to run the bots successfully.</p>
<p>When you use the If > Folder does not exist condition to determine that a folder does not exist, even if the folder exists, the bot might fail to identify it due to the leading and trailing spaces in the input folder path. As a result, the bot might throw an error.</p>
<p>When you update the Control Room to the latest version, you might see some packages with two default versions.</p> <p>Recommendation: Sometimes, you might notice the duplicate packages a few weeks after the Control Room is updated. Hence, we recommend that you compress and save the Control Room logs dir that contains all the WebCR*.log files 30 minutes after the Control Room is updated. This way, if you discover the issue later, these logs from the time of update will be available and help in investigating this issue.</p>
<p>In the Data Table > Assign action, when you select the Table with values option, select the Edit table (1 X 1) option to edit a table, enter variables in the rows and columns and then run the bot, the output still shows the input \$variable\$ instead of the evaluated value of the variable.</p>
<p>When you try to upload packages to the Control Room manually, the system does not check for the minimum required version of the Control Room that is compatible with the packages before they are uploaded. It allows the packages to be uploaded in the Control Room even if the version of the packages is not compatible with the currently installed version of the Control Room.</p>
<p>When you use the Run bot option to run a bot in the Activity > Historical > View page for any activity, the bot execution fails with an error.</p>
<p>(Service Cloud case ID: 01784401) To ensure that multiple Git processes are not modifying the same repository at the same time in the Control Room, Git lock is implemented for a short interval. After the lock is released, repository-related operations are resumed without any issues. However, in some instances, the Git lock is not released, and new Git operations cannot be processed. As a result, repository-related operations, such as edit, save, import, and check-in, are delayed and eventually time out.</p> <p>Workaround: Contact Automation Anywhere Support.</p>
<p>When you use the If package, add a specific condition with a variable, then add specific conditions within a group, save the bot, and if you rename the variable that was used, the name of the variable might not update for the Group conditions but is only updated for the conditions in the Condition tab.</p>

Limitations from previous releases
When you migrate a bot that was using the Manage Window Controls action, the last digit of the height value is not available after migration. However, the bot will execute successfully. (Service Cloud Case ID: 01756996)
When an Excel session is active in SAP, a corresponding Excel process starts in the background. In such a scenario, Automation 360 uses the same Excel process that SAP started. When you run a bot to automate spreadsheet data, Automation 360 processes the first request successfully. However, during execution, if the Excel is closed and a subsequent request is sent for automating the spreadsheet data, Automation 360 does not process the request because the Excel process is still being accessed by SAP. Therefore, the correct window is not activated for automating the spreadsheet data. (Service Cloud Case ID: 00815159)
<ul style="list-style-type: none"> If you are updating from Automation 360 On-Premises v.21, remove the following Bot Agent files and folders: <ul style="list-style-type: none"> C:\Windows\System32\config\systemprofile\AppData\Local\AutomationAnywhere\AA-DB.mv.db C:\ProgramData\AutomationAnywhere\GlobalCache\embedded-resources Before you update from Automation 360 On-Premises v.22, refer to the upgrade considerations in Update to latest Automation 360 version.
(Service Cloud case ID: 00837271) If you are migrating from Enterprise 11 with a database that has a large amount of repository data, the installation might fail. This issue occurs because Liquibase update for a few SQL queries is not completed during migration. Workaround: Contact Automation Anywhere Support.
When you try to automate any process in a Java application that uses version 11.0.8 of AdoptOpenJDK, the Recorder might not capture the drop-down elements on the application.
When you use the Recorder to capture an object, select HTML Tag , HTML InnerText , and HTML type properties in Search Criteria , or migrate a bot with similar properties selected in Search Criteria , the bot fails to identify or locate the object and perform the selected action. Workaround: Modify the DomXPath according to the controls you capture, or add more properties in Search Criteria .
When you use the Browser > Close action to close a tab or a window opened in the Microsoft Edge browser, if only one Microsoft Edge browser window is open, the bot encounters the following error: Error occurred while closing the tab Workaround: See Configure Microsoft Edge browser settings when Close action of Browser package encounters an error (A-people login required)

Internet Explorer EOL updates

Note: This release (Automation 360 v.25) includes features from Automation 360 v.24R2 (Build 13331). For information about what's available in the v.24R2 release, see [Automation 360 v.24R2 Release Notes for Internet Explorer 11 EOL](#).

Features
<p>Packages and actions</p> <p>You can now migrate Internet Explorer bots from Enterprise 11 and Enterprise 10 to Automation 360 and convert the bots to Microsoft Edge with IE mode for the following actions and commands in the Web Recorder package:</p> <ul style="list-style-type: none"> • Navigate URL, Go Back, and Search by Caption actions. • Open Browser and Close Browser commands. These commands are mapped to the Legacy Automation > Open Page and Close Page actions in Microsoft Edge with IE mode. <p>To launch Internet Explorer bots, in the Legacy Automation package, select the Launch Internet Explorer in Edge compatibility mode option.</p> <p>To migrate and convert Internet Explorer bots, in the Control Room, from Administration > Migration > Migrate bots, select the Convert bots built using Internet Explorer to Edge with Internet Explorer mode option.</p>

Automation Anywhere Robotic Interface (AARI)

Note: For Automation 360 v.25, AARI does not support an Oracle Database. You can continue to use AARI with Microsoft SQL Server.

What's new
<p>Use Bot Task labels to identify bot version to run</p> <p>In Bot Task, you can now select the version of a bot for deployment by choosing between the Latest version and Production label options. When you deploy the bot, the version of the bot that you selected is run.</p> <p>Create an AARI process</p>
<p>Bot priority reference</p> <p>In Bot Task, you can now refer to the priority level of your bots. For bots that were set to a priority level, the Bot priority section now displays a Low, Medium, or High read-only label.</p> <p>Create an AARI process</p>
<p>Create request in new tab</p> <p>You can now open and run your new requests in a separate tab when you select the Open request in New Tab option in the initial form. With this option, you can create requests concurrently without changing your current page navigation.</p> <p>Create a request and complete a task</p>
<p>Invalid scheduler</p> <p>An invalid scheduler is when a scheduler user has their role removed or when they cannot access a file because of missing permissions. Users who are notified of the invalid scheduler are the Control Room admin, the AARI admin, and the AARI user. Now, the Control Room admin will see an audit log change, the AARI admin will see an error message to reassign a new scheduler user, and the AARI user will see an error message in their process.</p> <p>Assign scheduler user to process in the web interface</p>

What's new**Duplicate rows for Table element**

In the web interface, when you are adding rows to your form by using the **Table** element, you can now save time by duplicating a row in the table with the new **Duplicate row** option. The duplicated row will now be placed under the highlighted row that you had selected.

Interface triggers support more technologies

You can now use interface triggers with the following technologies:

- Windows native
- SAP Desktop
- Google Chrome and Edge Chromium browsers

[Add an interface trigger](#)

Enhancements to form rules

- **Use custom formatting**

When you are adding a rule, if you use the **If** menu to set the rule conditions on certain elements such as **Text Box** or **Text Area**, you can now select **Is** from the drop-down menu to enable additional options. Select the **Custom** option and click **Add regular expression** to apply custom formatting requirements on the selected element.

Consider a scenario where the user IDs of all your employees have AV as prefix. For example, for an employee whose name is Adam, the user ID is AVAdam. Use the **Add regular expression** option to set the value in the **Regular expression** field as ^AV. If a user enters Adam in the user ID field, an alert is displayed.

- **Set custom value or append element value**

When you are adding a rule, use the **Then** menu to select a form element. For this form element, you can set one of the corresponding actions using **Set Value** or **Append value**:

- **Value:** Data entered in the **Enter value** field is applied to the selected element.
- **Form element:** Data from the form element selected in the **Select element** drop-down menu is appended.

Consider a scenario where a user registration form has 'First name' and 'Employee ID' fields. You can set one of the following rules for the value in the Employee ID field:

- Select **Value** and enter *Emp1013* as preset value.

This value is displayed in the 'Employee ID' field when the bot runs.

- Select **Form element** and set 'First name' element in the **Select element** drop-down menu.

The value from the 'First name' field is appended to the 'Employee ID' field when the bot runs.

You can use elements in the same way that variables are used in the Bot editor. You can enter **\$** to view a list of elements.

[Add rules to form elements](#)

What's changed
<p>Request reference for AARI web package</p> <p>The AARI web package now supports reference IDs. A reference ID is a combination of a prefix and a number that is created from a process key and is incremented every time a request is created. Request ID is replaced by Request Reference, and Team ID is replaced by Team Reference.</p> <p><i>AARI Web package</i></p>
<p>Process and package version changes in Get Storage file action</p> <p>The Get Storage file action now requires the matching of versions between the version of the process and the version of the package. Processes created before Automation 360 v.25 must be used with package versions from before Automation 360 v.25. Similarly, processes created after Automation 360 v.25 must be used with package versions after Automation 360 v.25.</p> <p><i>AARI Web package</i></p>

Fixes		
Build	Service Cloud case ID	Description
15112	01841448, 1839118, 1844817, 01846153, 01846332, 01839254	When you download a series of packages from the bot compilation, the download is now faster.
15112	01847675	After you update to Automation 360 v.25, when you modify a process in a private workspace, you can now save your changes successfully, without encountering an error. Previously you will get a process error when you attempt to modify and save your process, or when you open the same process again.
15112	01848192	After you update to Automation 360 v.25, you can now insert or modify conditions, such as the If/Else logic, to your process without any issues. Previously when you made changes or add the If/Else element to the process logic, a Go to element would be added to the logic which caused a process error.
15097	01807181, 01809192, 01816444	Cloud users: You can now successfully upload a file for your requests. This applies to some scenarios when you upload a file and the request creation fails.
15097	01771877	In the process editor, at the end of your process, you can now drag Go To and add it to your End Point .
15097	01774331	When you use the Row before scrolling option from the Table element and specify a number of rows, the web interface now renders the correct number of rows that you specified.
15097	--	When you use the Document element and click the Fit option to fit your document in request view, the document is now scaled to fit the frame entirely.

Fixes		
Build	Service Cloud case ID	Description
15097	--	If you design a form with a drop-down rule applied to it, when you view the drop-down in read-only mode in the web interface, you can now view the changed data.
15097	--	After you are disconnected, when you log back in to the web interface, the next= parameter is no longer shown in the URL and you are now redirected to the page that you were on before you were disconnected.
15097	--	For the Text Box element, the Does not contain form rule now works correctly.
15097	--	For the Rich Text Editor element, the Contains form rule is now working correctly.
15097	--	When you create a form with the Document and Dropdown elements, you can now submit your form without issues.
15097	--	You can now use Request Reference as a parameter in the AARI web package.
15097	01803846	You can now use Request Reference in the AARI web package, for example, as an output for the Create a Request action. Request ID is now replaced by Request Reference .
15097	--	You can now successfully submit an initial form that has a table with no content, data, or rows.
15097	01803019	When you open and view a task, the task assignment now correctly shows the user assigned to that task.

Limitations
When you attempt to delete a request that is associated with more than one file, the deletion fails.
After you create a request from a private process, when you attempt to open and run the request in a new tab, a new tab is generated but it fails to run the request and the URL is not correct.

Discovery Bot

Fix	
Service Cloud case ID	Description
00971940, 01018262, 01255326, 01829662	<p>You can now successfully record a process without encountering an error because when you log in to the Control Room, the proxy settings now support the following scenarios:</p> <ul style="list-style-type: none"> • No proxy is enabled. • Proxy is entered with username and password. • Proxy is entered without username and password. <p>Previously, when you recorded a process, if there was no proxy and if you entered a username and password with proxy enabled, an error occurred.</p>

Document Automation

New capability: Document Automation is the new Cloud-native intelligent document processing solution that business users can set up to automatically read and process documents quickly using pretrained models and validation feedback.

Document Automation is fully integrated into Automation 360: Document Automation is installed as part of the Control Room, RPA bots are used to extract semi-structured data to automate document-centric business processes, and Automation Anywhere Robotic Interface manages the end-to-end extraction process and validation tasks.

Document Automation

Limitations
Although the v.26 Document Extraction package appears in the .v25 On-Premises Control Room, features will not work as expected.
Workaround if the package version is auto-synced: Manually change the Document Extraction package version to v.25. See Update bots to default package version .
Document Automation does not support SDS deployment.
Google Document AI pretrained models are available only for Cloud customers who purchased licenses through Automation Anywhere.
Customers who install Document Automation on Linux must separately download the Document Extraction package.
Document Automation supports a device username of 21 characters or fewer.
The value beside the Validate documents link, which indicates the number of documents awaiting validation for a learning instance, sometimes does not appear.
Learning instances that use Google Document AI models do not reliably extract tables that span multiple pages.
When you are validating a document in public mode, if you zoom in or out, you cannot drag the corners of the system-identified region (SIR) selection.

Limitations
When you are validating a document, if you draw a box, zoom in, and then click Fit to screen , the box appears at a different location from where you clicked.
If you connect to a learning instance from Automation 360 IQ Bot with an optional field that has a set default value and some fields that are unmapped, when you process documents in that learning instance in Document Automation, the default value appears in the unmapped fields.
There is no notification if the product license is about to expire. When the product license expires, the Learning Instances tab is removed from the Control Room.
You might encounter extraction issues when you process documents with tables that span multiple pages. Workaround: Contact your Customer Success Manager to download a patch for the Document Extraction package.
When a bot runs an action from the Document Extraction package, the Activity > In progress page shows the item name as IQBotAutoExtract.
The Bot Agent does not verify whether the Document Extraction package version is compatible with the Control Room version prior to running a bot.
Document Automation cannot process documents in Automation Anywhere pretrained models if the Bot Agent runs through a proxy. Workaround: <ul style="list-style-type: none"> • With authentication: Create a Windows environment variable HTTP_PROXY with a value of <code>http://<username>:<password>@<proxyhost>:<proxyport></code>. • Without authentication: Create a Windows environment variable HTTP_PROXY with a value of <code>http://<proxyhost>:<proxyport></code>.
If a document is renamed to a new file extension and uploaded to a Google Document AI pretrained model, the document will fail processing. Workaround: Rename the document to the correct file extension.
Bots containing actions from the Document Extraction package must be deployed as part of an AARI process. Standalone bots are not supported.
In some cases, the Bot Agent does not clear out its resources folder. Until the disk space is freed, the production documents in processing will be affected. This issue occurs intermittently. Workaround: Based on the issue, you must create a task scheduler to clean out the resources folder every day or every week.

IQ Bot

Note: For Automation 360 v.25, IQ Bot does not support an Oracle Database. You can continue to use IQ Bot with Microsoft SQL Server.

What's new
<p>Migrate the roles associated with a learning instance</p> <p>You can now retrieve a list of custom roles with access to a learning instance in a source environment and grant users in a destination environment access to the learning instance by using the Roles migration API.</p> <p>IQ Bot roles migration APIs (A-People login required)</p>
<p>Track the number of pages processed in standard forms separately from IQ Bot</p> <p>The Control Room Licenses page now shows the number of pages processed in standard forms, the Classifier, and through IQ Bot. If the licenses are added to the Control Room from the Cloud, the Licenses page also shows the number of pages processed in other Control Room instances.</p> <p>Automation 360 licenses</p>

What's changed
<p>Reinstall IQ Bot services using a new script</p> <p>You can now reinstall all the IQ Bot services together in a batch or choose to reinstall them individually by using the <code>reinstall-allservices.bat</code> script.</p> <p>Postinstallation checklist</p>

Fixes	
Service Cloud case ID	Description
00780662	A round-off error no longer causes documents to fail formula validation. Previously, these documents were manually validated.
01763658	For the Concatenate Images action in the IQ Bot Pre-processor package, if a filename does not exceed 256 characters, the output is now successfully generated.
01795651	When you export the IQBA file from a learning instance of a custom domain type with manual groups to another learning instance, the manual Group Label is now exported successfully. Previously, without a manual Group Label , it was difficult to distinguish between system-generated groups and manual groups for new learning instances.
00780712	When you import IQBA files using VisionBot data, among the learning instances, you can now see new groups created. Previously, new groups were not created when documents were uploaded.
--	An error message is no longer displayed when you change the display language of any learning instance that has a document in Validator. Previously, even if the selected display language was applied successfully to a learning instance, the system showed an error.
--	When you use the Overwrite option to import a learning instance, the Default validations group is now successfully overwritten. Previously, the Default validations group was not overwritten, and you needed to manually edit the learning instance after importing the IQBA file and then change the default group.

Fixes	
Service Cloud case ID	Description
--	When you use the IQ Bot Extraction package, you can now view your document count on the Details page of the learning instance. Previously, if you processed documents that did not belong to any created groups, they were not displayed on the Details page of the learning instance.
--	You can now sort the PagesUpload column in the Learning instance > Document Group tab. Previously, the following error message was displayed: <i>System error, please try again after some time</i>
--	On the Designer, when you resize the system identified region (SIR) of an automapped field, the values from the resized selection are now captured accurately in the corresponding value field.
--	Database Migration Assistant Tool now notifies with an error if there are any environmental issues (such as missing DLL). Previously, the tools and logs indicated that migration was complete, even if a unified database was not created.
--	When a non-English filename is uploaded using the Invoice domain and processed using the AutoExtract command, system identified regions are now generated. Previously, to process the documents successfully, you had to convert the non-English filename to English characters.
--	If you import a learning instance with a set default validation group to an environment where the learning instance was previously deleted, the default validation group setting stays intact. Previously, the imported learning instance appeared without the default validation group.
--	The column header name for the Default validations group now appears in the <code>Projectdetails.csv</code> file obtained from exporting a learning instance.
--	For a standard forms learning instance, if you try to process a large number of documents (more than 10,000) by using the Process documents action from the IQ Bot Extraction package, some of the documents might not be processed.
--	During IQ Bot Extraction package updates, even when you use the Tesseract4 OCR, there is no delay in the document processing time and throughput results.
--	In standard forms learning instances, you can now set a default value for optional fields. If extraction fails for an optional field, the system uses the default value you set.
--	You can now access standard forms learning instances created in earlier IQ Bot versions that were installed with the CyberArk vault key.

Limitations
<p>IQ Bot Cloud: If you do not access IQ Bot within the configured Ideal time out value set on the IQ Bot server, the following things happen:</p> <ul style="list-style-type: none"> • A message to restart IQ Bot is displayed. • Bots that use IQ Bot APIs fail when the server is restarted. <p>Refresh the IQ Bot web page after some time (more than 5 minutes) to log in to IQ Bot.</p>
<p>On the Validator screen, if incorrect values are used to update a field on which you have applied validations, an alert is not displayed when the focus is lost from that field.</p>
<p>If you use the Process documents action from the IQ Bot Extraction package to extract content from a large number of documents (more than 1 million), an error message is displayed and IQ Bot might stop responding.</p>
<p>When you access the IQ Bot application on Internet Explorer11, the following functions do not work as expected:</p> <ul style="list-style-type: none"> • Export option on the dashboard • Icons in the menu list • Actions list on the Bots page • Action icon for learning instance • Validator functionality, such as the following: <ul style="list-style-type: none"> • Add rows • Delete rows • Search functionality • Hide icon • Data type for form fields
<p>In the IQ Bot Community Edition, when you use a Cloud OCR to create a learning instance, if you use the IQ Bot Process document action from the IQ Bot Extraction package, the values from the uploaded invoices or documents are not processed successfully.</p> <p>Workaround: If you use the Cloud OCR to create a learning instance, use the IQ Bot Upload Document action from the IQ Bot package.</p>
<p>When you click the Create Backup option on the Migration Management page and select the learning instances to be backed up by using the Search drop-down list, the learning instances selected become deselected. As a result, you cannot take a backup of the learning instances.</p> <p>Workaround: Instead of using the Search drop-down list, select learning instances from the list on the Backup Learning Instance page.</p>
<p>In a Native Validator learning instance, when you try to enter data into or modify the data in a child table that does not exist in the parent table, no error is prompted, which leads to documents being saved with incorrect values.</p>
<p>When you use the IQ Bot Extraction package along with other OCR-based commands (such as IQ Bot Pre-processor, IQ Bot Classifier, AISense Recorder, and OCR) in a single bot, the bot fails.</p> <p>Workaround: Ensure that you create separate bots for IQ Bot Extraction, and do not run IQ Bot Extraction in conjunction with other packages that include the 12.2 Abbyy OCR.</p>
<p>When you install IQ Bot with Windows authentication and CyberArk Vault, it is not possible to rotate the key, and the following error message is displayed: <code>Error occurred while setting up the new key. Please check the logs</code></p>

Limitations
<p>In some cases, the Bot Agent does not clear out its resources folder. Until the disk space is freed, the production documents in processing will be affected. This issue occurs intermittently.</p> <p>Workaround: Based on the issue, you must create a task scheduler to clean out the resources folder every day or every week.</p>
<p>If you have a document with more than 100 pages, an error message is displayed intermittently when you click See extraction results for an existing learning instance.</p>
<p>If you use the ABBYY FineReader Engine version 12.4 instead of version 12.2, the MICR feature does not support data extraction from documents in Japanese language.</p>
<p>When you download an unclassified document, click Delete from the server, and then toggle the learning instance from production to staging, and vice versa, as a consequence, the same document starts reappearing in the untrained output folder, and when you download the document from untrained groups, the same document reappears even though it has been deleted.</p>
<p>When you upload documents to production using IQ Bot Upload > Run the command, toggle the learning instance from production to staging, and then toggle back to production, all unprocessed documents appear blurred.</p> <p>Workaround: Upload documents to Staging using an API. Upload document to Staging API (A-People login required)</p>
<p>As a result of upgrading Control Room and IQ Bot from A360.21 to A360.25, you are unable to edit groups in the learning instances, and move groups from Staging to Production.</p> <p>Workaround:</p> <ol style="list-style-type: none"> 1. Restore the latest IQ Bot database backup. 2. Run the delete query. 3. Delete from EncryptionKey. 4. Run the following query: <code>INSERT INTO EncryptionKey ([Key], [Type]) VALUES ('xDxQoAhIc/R0nF+bFXHuo6/UGnmm6Hqs/uBVxYpz1IdU6UAEUUVYf5vnFJU6qkBcnCAvdQOUjdwRjWwWW4LdKA==','data')</code> 5. Start the A360.25 installer.Post upgrade checklist: 6. Ensure that following logs details are not available in installion-helper.log file: [INFO]: main/com.automationanywhere.cognitive.installationhelper.infrastructure.datarotation.DataRotationServiceImpl - Rotation starts. 7. Run the API, and ensure that the filename has proper value (it should not be "fileName" : "THIS STRING IS NOT ENCRYPTED"), http://localhost:9996/organizations/1/projects/%7BLearningInstanceID%7D/categories/%7BgroupNumber%7D/files <hr/> <p>Note: Replace the value of {LearningInstanceID} and {groupNumber} properly. Also, GroupNumber should belong to same learning instance.</p> <hr/>
<p>There is no notification if the product license is about to expire. When the product license expires, the Learning Instances tab is removed from the Control Room.</p>

Bot Insight

What's changed	
Dashboards now require the use of the Analyze package version 2.3.0-20210922-121532 or later. This version of the package is available from Automation 360 v.23.	
Bot Insight dashboards	

Fixes	
Service Cloud case ID	Description
01755186	When you use a filter on an individual widget, the filter is now correctly applied only to that filter, as expected. Previously, a filter meant for a specific widget was sometimes applied to other widgets, as well.

Automation Anywhere for Genesys

What's new
<p>Automate tasks for Genesys platform with Genesys package for Automation 360</p> <p>Use the actions in this package for onboarding and updating records in the repository. Each action palette offers single and bulk record creation and delete/remove actions for records. You can list or search records for referencing the IDs required for updating other records. You can also organize the records for communication purposes and contextual insight. The action palettes in this package include the following:</p> <ul style="list-style-type: none"> • Record creation: User, Division, Phone, External contacts • Organize records: Group, Queue, External organization • Record attributes: Language, Role, Skill <p>Genesys package</p>

Feature deprecations

Review features and capabilities (from Automation Anywhere or other third-party vendors) that are deprecated or nearing deprecation to understand how they impact your automation. For more information, see also this page: [Feature deprecations affecting Automation Anywhere products](#).

Human-Bot Collaboration 11.3.x deprecated

The Human-Bot Collaboration (HBC) 11.3.x was deprecated from August 2020 with the release of Enterprise A2019.15, after which the product has not been actively developed or maintained. Customers that are using HBC 11.3.x are required to migrate to the Automation 360 platform to use Automation Anywhere Robotic Interface (AARI), Web or Desktop. For this migration, there is no automated migration path because of an absence of parity between the two products (including sets of features). Any path that you take to migrate from HBC 11.3.x to the Automation 360 platform will involve significant manual steps to convert and map bots and other assets (such as forms, teams, and tasks) to AARI assets (such as bots, forms, processes, teams).

[Feature deprecations affecting Automation Anywhere products](#)

Basic authentication in Exchange online

Microsoft has announced that starting October 1, 2022 Basic authentication will be permanently disabled in Exchange Online. This change will impact bots used for email automation that connect to Exchange Online with Basic authentication using IMAP, POP3, or EWS protocols. Hence, Microsoft recommends customers to switch from Basic authentication to OAuth 2.0.

To maintain business continuity of the impacted bots, Automation 360 customers and partners can leverage the OAuth 2.0 feature support in Email package and Email trigger that will be delivered in the week of Aug 29th, 2022.

[Deprecation of Basic authentication in Exchange Online | Everything about Basic Authentication deprecation in Microsoft Exchange online \(A-People login required\)](#)

Manifest V2 extensions for Google Chrome and Microsoft Edge

As Google will deprecate Manifest V2 extensions by June 2023, this might impact your existing automations that use our current MV2 extensions in Google Chrome and Microsoft Edge browsers. You can choose to use the enterprise group policy to continue to use Manifest V2 extensions until June 2023([Manifest V3 transition timeline](#)). However, post this date, you have to switch to Manifest V3 extensions for your automations to work.

We plan to provide Manifest V3 extensions for Google Chrome and Microsoft Edge with our next release Automation 360 v.26. We recommend that you now start planning to switch to Manifest V3 extensions.

[Chrome and Edge Manifest V3 extensions](#)

Tesseract v3 OCR planned change from October 2022

Tesseract is an open source OCR engine leveraged by Automation 360 IQ Bot as part of document processing and extraction. Tesseract v3 has not been updated since 2018, and it will no longer be packaged with Automation 360 IQ Bot from the next release v.26 (planned for October 2022).

Tesseract 3 OCR was removed as an option from the IQ Bot learning instance creation user interface about 2 years back (in our v.13 release). However, we continued to package this older OCR version, which ensured that learning instances previously created on Tesseract 3 can function.

Starting from our next release Automation 360 v.26, Automation 360 IQ Bot will no longer package Tesseract 3. From v.26 release, document processing against learning instances with Tesseract 3 will result in an error, indicating that this OCR version is not available. However, the learning instances will remain in the system, allowing customers to view their details and train with alternative OCR options (including Tesseract v4 OCR).

For all existing learning instances trained using Tesseract v3 OCR, we recommend that you plan to train them with alternative OCRs (including Tesseract v4), before you update to v.26. Note that Automation 360 IQ Bot Cloud customers will receive v.26 release by default from October.

IQ Bot Extraction package deprecation from October 2022

As part of Automation 360 v.25, IQ Bot Extraction package will no longer support pre-trained machine learning model for invoice data extraction, but will continue to support learning instance group based-training extraction.

We have released a new set of capabilities on pre-trained models with Document Automation as part of v.25 release, including a new command package called **Document Extraction**. IQ Bot Extraction package will be deprecated starting from the next release Automation 360 v.26, so we recommend our customers to start leveraging this new Document Extraction package.

For more information about Document Extraction package and instructions on how to move learning instances to Document Automation, see [Move from IQ Bot Extraction package to Document Automation](#).

Automation 360 v.24R2 Release Notes for Internet Explorer 11 EOL

Release date: 17 May 2022

This release notes applies to the Automation 360 v.24R2 patch release for **Cloud, On-Premises, Sandbox, and Community Edition** users impacted by the Internet Explorer end-of-life (IE EOL) and who have therefore chosen to convert IE bots.

Cloud, On-Premises, IQ Bot, Sandbox, and Community Edition are on **Build 13343**.

Note: The IQ Bot build does not include any specific updates and is available to match the Control Room build.

Why this release

Microsoft has announced end-of-life (EOL) for Internet Explorer beginning June 2022 and recommends Microsoft Edge or Microsoft Edge in IE mode. This release contains packages certified on Edge in IE mode and an IE Update Bot wizard to help you update bots in bulk to work with Edge in IE mode. The upcoming IE EOL might affect your deployments based on the operating system you are currently using where the bots are run.

See the following table for details:

Microsoft operating system	Automation 360 bots
Windows 10 Semi-Annual Channel	Upgrade the bots to use a compatible browser. For a list of supported browsers, see Browser requirements for RPA Workspace .
All other supported operating systems	No immediate impact

Starting from the upcoming Automation 360 v.25 release, you will be prompted to access the Control Room through an alternative supported browser, such as Google Chrome or Microsoft Edge (Chromium) instead of Internet Explorer. Your Control Room will no longer be accessible on Internet Explorer. By aligning with Microsoft's strategy for browser support, we can provide you with enhanced functionality that latest browsers such as Google Chrome and Microsoft Edge make technologically possible.

Updating to this release

You can update to Automation 360 v.24R2 On-Premises from the following previous releases that are certified for update:

- v.24 (Build 12350)
- v.23 (Build 11513)
- v.22 (Build 10526)
- v.21 (Build 9664, 9642, 9595)

As Community Edition and Sandbox are Cloud deployments, no manual upgrade is required. These environments are automatically updated to Automation 360 v.24R2 Build 13343.

If you are not on any of the above certified releases, update Automation 360 to one of the certified releases (listed previously) before updating to this release.

For information on updating to this release, see these resources:

- [Update to latest Automation 360 version](#)
- [Automatically update the Bot Agent | Manually update the Bot Agent](#)
- [Compatibility with Automation 360 builds](#)

For the latest updates to the Automation 360 extensions for Google Chrome, Microsoft Edge, and Mozilla Firefox, see [Enhancements to browser extensions](#).

Bot Agent updates

This release includes an **optional** Bot Agent update. To use the features in Automation 360 v.24R2 patch, update the Bot Agent available with the following builds:

- Bot Agent version 21.200 for Build 13343
- Bot Agent version 21.1000.14009 for Build 13331 (On-Premises pre-GA)

Note that if you want to run your existing bots, you do not have to update your Bot Agent to this release.

If you have installed the Automation 360 v.24R2 pre-GA patch (Build 13331) with Bot Agent version 21.1000.14009, perform the following steps.

1. Uninstall the pre-GA Bot Agent version 21.1000.14009.
2. Install Bot Agent version 21.200 for Automation 360 v.24R2 (Build 13343).

Important: If you have moved your bots from the user acceptance testing (UAT) environment and deployed them in a production (PROD) environment with Bot Agent version 21.1000.14009, you must update the packages with the latest Bot Agent version 21.200.

Community Edition features

Packages
<p>Microsoft Edge browser support for Browser package and window variables</p> <ul style="list-style-type: none">• The following actions of the Browser package now support Chromium-based Microsoft Edge browser:<ul style="list-style-type: none">• Close• Get source code• Go back• Open• Run JavaScript• In the Browser option, you can now select the Microsoft Edge tabs from the list of active tabs.
<p>Support for last used browser tab in Browser > Open action for Microsoft Edge and Google Chrome</p> <p>You can now open a web page on a new tab or an existing tab using the Last used browser tab preset in the following browsers:</p> <ul style="list-style-type: none">• Microsoft Edge• Microsoft Edge with IE mode• Google Chrome
<p>Automate Java web applications</p> <p>You can now automate Java web applications that run on Microsoft Edge Chromium with IE mode by using the Recorder > Capture or the Start recording option.</p>
<p>Default wait time for loading page in Microsoft Edge browser with IE mode</p> <p>When you automate any web applications in Microsoft Edge browser with IE mode, the Recorder now waits for 30 seconds by default to allow the web page to load completely before recording any objects on the page, thereby making object detection more reliable.</p>

Cloud, On-Premises, and Sandbox features

Control Room and Packages
<p>New Update Bot wizard for Internet Explorer</p> <ul style="list-style-type: none">• Use the new Update Bot wizard in the Control Room to convert your existing Internet Explorer bots to Microsoft Edge with IE mode to ensure that these converted bots continue to run after IE EOL. <i>Update Bot wizard for converting IE bots</i>• As an administrator, you can enable a user to use the Update Bot wizard by assigning the new Bot update feature permissions to access and convert a bot from Internet Explorer to Microsoft Edge with IE mode. <i>Feature permissions for a role</i>• Use the View Bot update action in a bot conversion instance to view the summary and status of each bot conversion. You can review action details at the individual line numbers and take action if required for the bots that are in failed status, or in completed with action or review required status. <i>View conversion details for IE bots</i>
<p>Automate Java web applications</p> <p>You can now automate Java web applications that run on Microsoft Edge Chromium with IE mode by using the Recorder > Capture or the Start recording option.</p>

Control Room and Packages

Convert Automation 360 bots with browser-specific packages using Internet Explorer to Microsoft Edge with IE mode

You can convert bots that use Internet Explorer to Microsoft Edge Chromium with IE mode for the following packages:

- Recorder
- Browser
- Application
- Simulate keystrokes
- Screen
- Mouse
- Window
- OCR
- App Integration
- Image Recognition
- If
- Loop
- Wait

To convert these bots, use the Update Bot wizard in the **Administration** > **Bot update** tab in the Control Room.

Update Bot wizard for converting IE bots

The following properties of browser-based packages and actions are updated from Internet Explorer to Microsoft Edge browser with IE mode:

- Bots created using the browser or application-based window, window title, and application path
- Window variable's default value, window title, and window application path
- Browser variables and browser title

Microsoft Edge browser support for Browser package and window variables

- The following actions of the Browser package now support Chromium-based Microsoft Edge browser:
 - Close
 - Get source code
 - Go back
 - Open
 - Run JavaScript
- In the **Browser** option, you can now select the Microsoft Edge tabs from the list of active tabs.

Support for last used browser tab in Browser > Open action for Microsoft Edge and Google Chrome

You can now open a web page on a new tab or an existing tab using the **Last used browser tab** preset in the following browsers:

- Microsoft Edge
- Microsoft Edge with IE mode
- Google Chrome

Control Room and Packages**Default wait time for loading page in Microsoft Edge browser with IE mode**

When you automate any web applications in Microsoft Edge browser with IE mode, the Recorder now waits for 30 seconds by default to allow the web page to load completely before recording any objects on the page, thereby making object detection more reliable.

Migration features**Scan bots that use Microsoft Internet Explorer**

You can now use the Bot Scanner to scan and identify Internet Explorer bots. You can also analyze the report generated by the Bot Scanner to get usage statistics about Internet Explorer used in your bots.

[Scanning bots that use Internet Explorer](#) | [Analyze report for Internet Explorer bots](#) | [Internet Explorer conversion or scanning messages](#)

Migration features

Packages and actions

You can now migrate and convert Internet Explorer bots from Enterprise 11 or Enterprise 10 to Automation 360 with Microsoft Edge with IE mode for the following packages and actions:

- App Integration
- Delay
- IF/ELSE and Loop
- Image Recognition
- Launch Website
- Manage Window Controls
- MetaBot Screen
- Mouse
- Object Cloning

Image Play mode and **Coordinates Play** mode are supported. **Coordinates Play** mode supports the mouse click action with keystrokes after it.

- OCR
- Open Program/File
- Screen
- Simulate keystrokes
- Wait

Support for **Wait for condition**, **Wait for screen change**, and **Wait for window** actions

- Web Recorder
- Windows Actions

For more information, see [Package mapping for migration](#).

To migrate and convert bots, go to **Administration > Migration > Migrate bots** and select the **Convert bots built using Internet Explorer to Edge with Internet Explorer mode** option in the Control Room.

The following properties of browser-based commands and actions are updated from Internet Explorer to Microsoft Edge with IE mode:

- Bots created using the browser or application-based window, window title, and application path
- Window variable's default value, window title, and window application path

Note: Bots that use value type variables are not updated to Microsoft Edge. You must first enable the configure settings in the Legacy Automation package to open bots built using Internet Explorer to Microsoft Edge compatibility mode.

- Browser variables and browser title

Convert IE bots to Microsoft Edge with IE mode

When you migrate your bots from Enterprise 10 or Enterprise 11, you can use the new **Convert bots built using Internet Explorer to Edge with Internet Explorer mode** option in the Bot Migration Wizard to convert your bots from Internet Explorer to Microsoft Edge with IE mode.

[Migrate Enterprise bots](#)

Migration features**History and version updated for migrated bots**

In the Bot Migration Wizard, when you migrate your Enterprise 10 or Enterprise 11 bots, the version history is now updated to show that it is a migrated bot (the check-in comment shows that the bot is migrated from Enterprise 10 or Enterprise 11 version). You can use this check-in comment to identify which version of the bot is migrated.

[Bot Migration Wizard](#)

Fixes

The following fixes are available for **Cloud**, **On-Premises**, and **Sandbox**:

Service Cloud case ID	Description
01784593	You can now run migrated bots successfully even when a \$ (dollar sign) is present as a value in the User Variables field. The Bot Scanner no longer displays a preprocessing error.
--	When you automate web applications running on Microsoft Edge Chromium with IE mode or Internet Explorer, the Recorder now captures the object from the currently selected browser tab. Previously, the Recorder captured the object from the last used tab.
01189873	After migration, when you use the Browser > Open action to open a URL that has a space character, use the Browser > Download files action to download the file from the specified URL, and then run the bot, the bot now opens the URL in a single tab and downloads the file from the specified URL. Previously, when the specified URL had a space character, the bot split the URL and opened it in two separate tabs.

Known behavior and limitations

The following limitations apply to **Cloud**, **On-Premises**, and **Sandbox**:

- When you execute a stored procedure with name parameter arguments that resides in another database in the SQL Server, the bot displays an error because of the JDBC driver issue with executing a stored procedures with name parameters of another database in the same SQL instance.

Workaround: When you add parameters to provide an input parameter or configure an output parameter, ensure you do not enter any value in the **Parameter name** field. The bot will not encounter any error when executing the stored procedure because the Database package considers blank values as indexing.

- Note that even when the number of schedules listed on the Control Room **Schedules** page is less (for example, five or six schedules), you might see the following error because of a query timeout: `An unexpected problem occurred`. This is an existing Control Room database performance related issue.
- There are other limitations and behavior that apply to bots migrated from Enterprise 11 to Automation 360 and to Automation 360 bots that run on Internet Explorer and are converted to Microsoft Edge with IE mode. For more information, see [Known behavior and limitations](#).

- When you use the **Browser > Close** action to close a tab or a window opened in the Microsoft Edge browser, if only one Microsoft Edge browser window is open, the bot encounters the following error:
Error occurred while closing the tab
Workaround: See [Configure Microsoft Edge browser settings when Close action of Browser package encounters an error \(A-people login required\)](#)
- When you use the **Browser > Open** action to open network URLs that start with two backslash (\\) characters in the Google Chrome, Microsoft Edge, or Mozilla Firefox browser, the URLs might not open properly.
Workaround: Replace the two backslash (\\) characters with file:// protocol.
- When you use the **Browser > Open** action, select **New tab** or **Existing tab** option to open a specific webpage in Microsoft Edge with IE mode, the bot might throw an error after opening the webpage.
Workaround: Use any of the following workarounds based on specific scenarios:
 - **Option 1:** Add **Try/Catch** block around the **Open** action and ignore the exception as the website opens.
 - **Option 2:** In the **Browser > Open** action, select the **New window** option instead for such websites.
- When you use the **New window** option in the **Browser > Open** action with the 3.4.x version of the Browser package to open a URL with arguments, the bot might not perform the specific action as the 3.4.x version of the Browser package does not support argument flags.
Workaround: Use any version other than the 3.4.x version of the Browser package to automate.

See also these resources:

- [Microsoft Internet Explorer EOL overview](#)
- [Microsoft Internet Explorer 11 EOL FAQ](#)

Related concepts

[Microsoft Internet Explorer 11 EOL FAQ](#)

Microsoft has announced end-of-life (EOL) for Internet Explorer beginning June 2022 and recommends using Microsoft Edge or Microsoft Edge in Internet Explorer (IE) mode. This will impact automations (bots) based on the operating system currently in use where the bots are run.

[Microsoft Internet Explorer EOL overview](#)

Microsoft has announced retiring Internet Explorer (IE) for certain versions of Windows operating systems and recommends impacted users to move their apps or websites running on IE to Microsoft Edge with IE mode.

Related information

[Enterprise 11 and upcoming Internet Explorer 11 EOL FAQ](#)

Automation 360 v.24 Release Notes

Release date: 08 April 2022

Review what's new and changed, and the fixes and limitations in the Automation 360 v.24 (Build 12350) release.

Important: We have updated the Automation 360 v.24 (Build 12350) to include fixes for the following issues:

- After migration, when you ran the migrated bots, they displayed an error for variables within double quotation marks (" ") (Service Cloud case ID: 01802575, 01803323, 01803800, 01804121, 01804820).

- When you clicked the AARI icon, the Control Room was displayed instead of the AARI Assistant sign-in screen (Service Cloud case ID: 01803979).

- **Migration**

[11.x and 10.x](#) | [11.x only](#) | [10.x only](#)

- **RPA Workspace**

[What's new](#) | [What's changed](#) | [Fixes](#) | [Limitations](#)

- **AARI**

[What's new](#) | [What's changed](#) | [Fixes](#) | [Limitations](#)

- **Discovery Bot**

[What's new](#) | [Fixes](#) | [Limitations](#)

- **IQ Bot**

[What's new](#) | [Fixes](#) | [Limitations](#)

- **Bot Insight**

[What's changed](#) | [Fixes](#) | [Limitations](#)

Updating to this release

You can update to Automation 360 v.24 from the previous three releases (that is, from $n-3$ releases, where n refers to the latest release). The following previous releases are certified for update to this release:

- v.23 (Build 11513)
- v.22 (Build 10526)
- v.21 (Builds 9664, 9642, 9595)

You can directly update to v.24 from any of these builds (see [Update to latest Automation 360 version](#)). If you are not on an $n-3$ release, update Automation 360 to one of the three certified releases (listed previously) before updating to this release.

- If you are directly updating to this release from Automation 360 On-Premises v.21, remove the following Bot Agent files and folders:
 - C:\Windows\System32\config\systemprofile\AppData\Local\AutomationAnywhere\AA-DB.mv.db
 - C:\ProgramData\AutomationAnywhere\GlobalCache\embedded-resources
- Before you update to this release from Automation 360 On-Premises v.22, refer to the upgrade considerations in [Update to latest Automation 360 version](#).

Bot agent update: This release includes an **optional** Bot Agent update. To use the new features in v.24 (including updates to Bot Migration, Browser, DLL, Process Discovery, and Recorder packages), update the Bot Agent available with this release. However, note that if you want to run your existing bots, you do not have to update your Bot Agent to this release.

For information on updating to this release, see these resources:

- [Automatically update the Bot Agent](#) | [Manually update the Bot Agent](#)
- [Compatibility with Automation 360 builds](#)

For the latest updates to the Automation 360 extensions for Google Chrome, Microsoft Edge, and Mozilla Firefox, see [Enhancements to browser extensions](#).

Important: This release includes new command packages in which the Apache log4j2 library is no longer bundled. However, older command packages, from Automation 360 v.23 and earlier, might continue to have the log4j2 library bundled within. If you want to use command packages without the log4j2 bundled within, we recommend that you use the newer Automation 360 v.24 packages in your tasks.

Migration

Enterprise 11 and Enterprise 10 features
<p>Self-service Control Room migration</p> <p>You can now manage the migration provisioning process with self migration capabilities. You can also choose between manual and automated migration.</p> <p>Self-service Control Room Migration</p>
<p>Enhancement to migration of Credential Vault variables</p> <p>Migration is now supported when Credential Vault variables are passed from one MetaBot Logic to another MetaBot Logic for the following commands:</p> <ul style="list-style-type: none"> • IF > Logic Successful • IF > Logic Unsuccessful • Begin Error Handling > Run Logic
<p>You can now successfully migrate Enterprise 11 bots that use the 32-bit <code>wscript.exe</code> to the 64-bit architecture, without exception errors. This enhancement helps you to successfully execute VBScript.</p>
<p>Migrate MetaBot with parent and child Logic with renamed Logic</p> <p>You can now migrate a MetaBot with a Logic (parent) that includes a renamed Logic (child). If a child Logic is renamed after it is mapped to the parent Logic, this parent Logic mapping is now migrated with the new name.</p> <p>This enhancement applies to the following commands:</p> <ul style="list-style-type: none"> • IF > Logic Successful • IF > Logic Unsuccessful • Else If > Logic Successful • Else If > Logic Unsuccessful • Error Handling > Run Logic • Run Logic

Enterprise 11 and Enterprise 10 features

Migrate when MetaBot and Logic have the same name

You can now successfully migrate your Enterprise 11 bots when the name of the MetaBot and the assets folder or the Logic name inside that MetaBot are the same. The Logic name is suffixed with *-bot*. The name is appended only when the Logic or the folder is on the same hierarchy as the MetaBot.

- If an existing bot has the renamed Logic or assets folder, the Logic is then renamed with the next available number. For example, *-botn*, where *n* indicates the next available number. Additionally, an action required message is displayed.
- If a MetaBot or a Logic calls a renamed Logic or TaskBots, the command path is updated to include the new name.
- If a Logic, MetaBot, or a folder name exists with a new name, the existing bot is overwritten.

[Migration messages](#)

Consolidated view of migrated bots and their status

Use the **Overview** tab in the Control Room to get a consolidated view of the status of the migrated bots. View the overall status of bot migration for all the bots that are successfully migrated, those that failed to migrate, and those that require review or action. You also have the option to rerun migration on selected bots and view the history of each bot that has gone through multiple migrations.

[Bot Migration Wizard](#)

Enterprise 11 only features

Update to AAApplicationPath, CurrentDirectory, and AAInstallationPath variables

If your migrated bot contains \$AAApplicationPath\$, \$CurrentDirectory\$, or \$AAInstallationPath\$ variables in any file or folder path, a validation check for the absolute path is no longer performed during migration. Also, a temporary variable (\$m-string-start-in-path\$) is not created and assigned to the migrated bot for validation. As a result, the size of a migrated bot is now reduced and the bot performance is enhanced.

Enhancement to migrate bots with Email Connect command

When you migrate Enterprise 11 bots that contain the **Email > Connect** and **Email > Send** commands configured for EWS server, the **Azure Cloud** field is set to **Azure Global** and the **Authentication type** is set to **OAuth2-Silent** which was previously called OAuth2.

Note that **OAuth2** now supports two modes: **Silent** and **Interactive**.

[Using Connect action for Email](#)

Migrate bots with timeout configured to send REST and SOAP request

The timeout value configured in Enterprise 11 to send REST and SOAP requests is now migrated to Automation 360 as part of the global values (AARestTimeOut and AASoapTimeOut). The default timeout value is set as 60000 ms in Automation 360. You can update this value if the REST Web Service takes more time to receive a response.

[REST Web Service package](#) | [Example of using the SOAP web service action](#)

Enterprise 10 only features**Migrate new or modified Enterprise 10 bots to Automation 360** (Service Cloud case ID 00719524)

You can now migrate new or modified Enterprise 10 bots to Automation 360 after an earlier migration. A new export utility is now available that enables you to export such new and modified bots from the Enterprise 10 Control Room repository. You can then import the exported bots later to Automation 360 using Bot Lifecycle Management (BLM) and then finally migrate them using the Bot Migration Wizard.

[Migrate new or updated Enterprise 10 bots to Automation 360](#)

RPA Workspace

What's new**Bot Agent updates and early availability of packages**

Starting from this release, you can choose or skip some Bot Agent updates and start using packages as soon as new package versions become generally available regardless of your region.

Bot Agent updates that support new packages or updates to packages will be made available quarterly, with updates alternating between mandatory and optional.

Previously, Bot Agent updates were available automatically across user device pools without affecting bot execution. In some large and complex deployment scenarios, these updates were cumbersome but could not be skipped. (Examples include deployments where the device pools were deployed using standard device Amazon Machine Image (AMI) on separate schedules requiring greater coordination, change management processes, and approvals in the user environment for the Bot Agent update.) Now, you can skip an optional update and update to the next mandatory Bot Agent update as Automation 360 will start providing reverse compatibility with Bot Agent for a release every six months.

Also, with every release, you can start using the latest packages as soon as new package versions are released. For Automation 360 Cloud users, package updates are now available asynchronously across all regions, so you can start using the latest packages on the current Control Room version even before the Control Room update is made available for your region.

[Compatibility with Automation 360 builds](#)

Create multi-login users

You can now create a multi-login user. A multi-login user is allowed multiple sessions to the Control Room through the API.

[Multi-login user](#) | [Authenticate \(username and password\)](#) | [Authenticate \(username and apiKey\)](#)

Do more with Microsoft Edge Chromium

You can now use the Microsoft Edge Chromium browser extension for the following:

- Bot Agent proxy configuration
- Automatic population of device credentials

[Browser requirements for RPA Workspace](#)

What's new
<p>Reduce turnaround time</p> <p>You can now reduce the turnaround time for collecting information on issues by capturing log files from the Bot Runner device. You can save the log files by using the new <code>-collectlogs</code> command with the Bot Agent diagnostic utility.</p> <p><i>Perform Bot Agent diagnostic checks</i></p>
<p>Google Chrome policy change impact on Bot Agent</p> <p>From Google Chrome version 101, Google Chrome is deprecating direct access to private network endpoints from public websites as part of the Private Network Access (PNA) specification for URLs using <code>https</code>. To mitigate its impact, starting from this release, response headers are added to the Bot Agent that enable the Bot Agent to communicate with Control Room on Google Chrome browsers. This will ensure that operations such as device registration, bot recording, playback, and deployment are not adversely affected because of this change.</p>
<p>Enhancement to AISense Recorder</p> <p>You can now use AISense Recorder to automate applications that use Japanese and a combination of Japanese and English interfaces.</p> <p><i>AISense for recording tasks from remote applications</i></p>
<p>Wait time option in SOAP Web Service and REST Web Service packages (Service Cloud case ID: 00756730, 00792793, 01255869, 01753287)</p> <p>When you create a bot, you can now set a time-out value for actions in REST and SOAP requests. To indicate how long a bot should wait for a response from the server before timing out, you can set a wait time (in milliseconds) in the Wait for actions to complete field. You can enter a number or a variable or provide a global value.</p>
<p>Format text with new HTML editor in Email package</p> <p>In the Email package, when you use the Send, Reply, and Forward actions, you can now create and customize your email layout and body by using the new HTML design editor. Use the editor toolbar to make various changes to your text, such as applying bold, italic, and other formatting effects, inserting links, and changing the font and size of the text. You can copy the content from the design editor and paste it to other windows.</p>
<p>Task Bot package now supports passing Window variable to child bot (Service Cloud case ID: 00691890, 00804359, 01258948, 01764292)</p> <p>In the Run action of the Task Bot package, when you select Input values fields and enter the values or variables to pass to the child bot, you can now choose the <code>Window</code> type variable and pass it from parent bot to child bot.</p>
<p>New option in Content type field of REST Web Service package (Service Cloud case ID: 00666852, 00789910, 00771194, 00785116, 00825945, 01762199)</p> <p>You can now use the multipart/form-data option to upload files and data through REST Web Service. The content type <code>multipart/form-data</code> can be used to submit form elements containing files, non-ASCII data, and binary data. This option is available for actions such as POST, PUT, and PATCH.</p>
<p>Custom delimiter option in SOAP Web Service package</p> <p>For responses specific to XPath, you can now use the custom delimiter option to delimit the return content from the SOAP response. In the Custom Delimiter field, you can provide a character or a variable, and the output of the delimited response will be a complete string.</p>

What's new
<p>New option in Run function action of DLL package (Service Cloud case ID: 00830568, 01063654, 01259336, 01767965)</p> <p>In the Run function action of the DLL package, when the C# DLL interacts with the Windows API to perform system-related operations, such as keystroke, mouse click, or window switching, an intermediate window (AAZeroSizeForm) is displayed occasionally and interrupts the user's operation when the bot is running. In some cases, the DLL function does not interact with the Windows API to perform actions, such as keystroke, mouse click, or window switching, on the operating system UI through the DLL function. In such cases, you can now select the Run function in background check box to bypass the intermediate window (AAZeroSizeForm) and run the C# DLL in the console application without the form. This feature also helps to improve the performance of the DLL execution if the Run function in background check box is selected.</p>
<p>Autoscroll supported in Bot editor (Service Cloud case ID: 00730747)</p> <p>When you are creating or editing bots with a large number of lines of code and when you drag actions up or down the page, the page now automatically scrolls up or down accordingly. This feature is supported in both Flow and List views.</p>
<p>Configure session timeout in Control Room settings (Service Cloud case ID: 00765320)</p> <p>You can now ensure that your web session does not time out, such as when you are creating a bot, by configuring a suitable session timeout duration in the Control Room settings. Depending on the timeout duration configured, you will be timed out only after the specified number of minutes of inactivity, which prevents loss of work due to early timeout.</p>
<p>New JSON package</p> <p>Use the JSON package to automate JSON data. You can now extract the required information from JSON text or file and directly use the values in the bot.</p> <p><i>Json package</i></p>
<p>New option in Catch action of Error handler package (Service Cloud case ID: 00766117)</p> <p>In the Error handler package, you can now ignore errors from actions inside the Catch block by using the Catch > On error, continue with next action option. When you select the On error, continue with next action check box, even if there is an error from an action in the Catch block, no exception is thrown and the bot ignores the error and continues to the next action.</p> <p>Note: This enhancement applies to all nested actions in the Catch block. For example, if you have a Try/Catch action inside a main Catch action, if the check box is selected on the main Catch action, any error from actions within the nested block will also be ignored.</p>
<p>Enhancements to the Connect action of the Email package (Service Cloud case ID: 00830611, 01264796, 00788467)</p> <ul style="list-style-type: none"> You can now connect to an EWS server hosted on Azure US GCC high cloud. The action now enables Federated Azure users to connect to an EWS server in Attended Automation mode. <p><i>Using Connect action for Email</i></p>
<p>Enhancement to String package</p> <p>In the Extract text action of the String package, when you use the After or Before and/or after option, you can now extract a substring from a specified source string that occurs in the range of 1 through 999999 times in a file.</p>

What's new**Search for files by specific date**

You can now search for files created or modified on a specific date by using the new **On a date** option available in the **File Date** condition of various packages.

You can use this feature with the following packages and actions:

- File package
 - **Copy Desktop files** action
 - **Delete** action
 - **Print** action
 - **Print multiple files** action
 - **Rename** action
- Folder package
 - **Copy** action
 - **Delete** action
 - **Rename** action
- If > File date condition
- Loop > While > File date condition

New action in Excel advanced package (Service Cloud Case ID: 01263892, 01782290)

When you perform actions in a Microsoft Excel worksheet, you can now disable or enable real-time screen update by using the new **Disable or enable real-time screen update** action of the Excel advanced package. This action is useful to improve the performance of Excel-based automations at run time when dealing with large data sets.

[Worksheet operations in Excel advanced](#)

Support for copying metadata from one bot to another

You can now copy image and metadata files from one bot to another by using the **Copy to shared clipboard** option.

Add document extraction capabilities to bots

You can now make bots connect to your Google Cloud service account, send documents to a specific processor, and retrieve the extracted data in JSON format by using the actions in the Google Document AI package.

[Google Document AI package](#)

Use Recorder conditions in Chromium-based Microsoft Edge with Internet Explorer (IE) mode

You can now use the **Object exists** and **Object does not exist** Recorder conditions in Chromium-based Microsoft Edge with IE mode for the following packages:

- Loop > While condition
- Wait > Wait for condition
- If package

What's new
<p>Use custom datetime formats</p> <p>Use the following conventions to specify custom datetime formats and convert a datetime value:</p> <ul style="list-style-type: none"> • D: Specify a day in a year as D or DD. • a: Specify an AM/PM marker for the 12-hour time format. <p><i>Datetime formats</i></p>
<p>Internet Explorer browser support for Browser package and window variables</p> <ul style="list-style-type: none"> • The following actions of the Browser package now support the Internet Explorer browser: <ul style="list-style-type: none"> • Open • Close • Go back • Get source code • In the Browser option, you can now select the Internet Explorer tabs from the list of active tabs. <p><i>Browser package</i></p>
<p>Enhancement to Datetime package</p> <p>The Variable option in the Datetime > Assign action is now enhanced and divided into two options:</p> <ul style="list-style-type: none"> • Datetime: Enables you to select the date and time along with the time zone manually and assign it to a Datetime variable. • Variable: Enables you to select the Datetime variable or other variables that can have Datetime as a subtype, such as the Dictionary, Record, and list variables. <p><i>Using the Assign action</i></p>
<p>Enhancement to Recorder package</p> <p>You can now capture and automate objects inside a cross-domain IFrame that has multiple IFrames with the same frame source and IFrames that are loaded at run time in Google Chrome and Microsoft Edge Chromium browsers. You can do this by using the Recorder > Capture or the Start recording option. This support is also available for offline Google Chrome extensions.</p> <p><i>Recorder package</i></p>
<p>Support for pop-up windows and dialog boxes in Google Chrome, Microsoft Edge Chromium, and Mozilla Firefox browsers (Service Cloud Case ID: 00762207, 00769773, 00781196, 00786646, 00777907, 00795677, 00785995, 00808600, 00811044, 00767486, 01282172, 01286665, 01256750, 01762040)</p> <p>When you are automating a web page on the supported browsers, you can now capture the pop-up windows, alert dialog boxes, confirmation dialog boxes, and prompt dialog boxes that appear. You can do this by using the Recorder > Capture or Start recording option.</p> <p><i>Recorder package</i></p>

What's new**Retrieve source code of an iFrame in Google Chrome browser**

You can now retrieve the source code of an iFrame in the Google Chrome browser by using the **Browser > Get source code** action. You can use the new **Capture object** option to capture these iFrames.

Note: The **Capture object** feature is optional and is only used to retrieve the source code of an iFrame.

Run JavaScript inside an iFrame in Google Chrome browser

You can now run JavaScript in a page that contains iFrames in the Google Chrome browser by using the **Browser > Run JavaScript** action. You can use the new **Capture object** option to capture iFrames on which you want to run JavaScript.

Note: The **Capture object** feature is optional and is only used to run JavaScript inside an iFrame.

Global session support for Excel basic package

- The Global session option is now supported for the Excel basic package. Use the Global session option to share a Microsoft Excel session across multiple bots so that you can use the same Excel worksheet across these bots.
- The **Session name** field is now renamed **Create Excel session**.

[Using the Open action for Excel basic](#)

Default variable to hold number type data

When you are building or testing a bot, you can now use the default number variable `SampleNumber`, which is included in the Variables palette.

Note: The default number variable is only available in new bots.

Export and import password-protected files

To improve security by providing protection against unauthorized access and malicious editing and also to protect privacy, the export and import features are now enhanced to include the password option. With this feature you can now perform the following:

- Set a password for the files that you want to export from your Control Room.
- Import the password-protected exported file into your Control Room.

[Export bots](#) | [Import bots](#)

What's new
<p>New options in Git configuration (Service Cloud case ID: 00782957, 00837059, 00687394, 00783715, 00714059, 00659476, 00749755, 00786233, 00748166, 00776417)</p> <p>You can now perform the following actions for Git configuration:</p> <ul style="list-style-type: none"> • Choose either the HTTPS or SSH authentication method to set up the Git configuration. The SSH authentication method is more secure as the authentication is based on a public and private key pair. • Specify the branch to which you want to push your Git commits. This helps with team coordination and workflow management. • Connect to your Git repository by using a proxy server. <p>Configure a remote Git repository in Control Room Restore bots from Git repository</p>
<p>Force push now a configuration setting for Git Integration in the Control Room (Service Cloud case ID: 00683762)</p> <p>You can now configure the Git push to be with or without the force push flag. Previously, updating a remote Git from the Control Room exclusively functioned as a force push. This force push is the recommended and optimal setting.</p>
<p>Support for Azure DevOps (On-Premises or Cloud) Git for SSH authentication (Service Cloud case ID: 00652012, 00690526)</p> <p>You can now use either the SSH or the HTTPS authentication method to connect to Azure DevOps (On-Premises or Cloud) Git through the Control Room to check in a bot and its dependent files to the remote Azure DevOps Git repository.</p> <p>Connect to Azure DevOps Git from Control Room</p>
<p>Spring core vulnerability - CVE-2022-22965 (01793279, 01793398, 01793497, 01793679, 01794189)</p> <p>Updated to the Spring Framework which has the patch for CVE - CVE-2022-22965 vulnerability.</p>

What's changed
<p>Migration validation checks for default device settings</p> <p>The prerequisites validation for migration now validates whether Bot Runners selected for bot migration have the default device set. If the default device is not set, then bot migration cannot proceed and the validation report lists a validation error. The report also shows the specific Bot Runner devices that do not have a default device.</p> <p>Note that bot migration cannot use devices that are selected at runtime.</p>
<p>Bot migration report shows migrated bot with action and review required</p> <p>The bot migration report now separately lists bots that might require an action or review after migration. This feature enables you to view the list of bots that will require action or review and to plan post-migration steps accordingly.</p>
<p>Migrate 11.x bots with forward slash in file and folder path (Service Cloud case ID 00808534)</p> <p>You can now migrate Enterprise 11 bots that include a forward slash in the path used within the File and folder action. Previously, only the backslash was supported in the path and so the user could not create a folder on SharePoint.</p>

What's changed
You can now manually migrate Enterprise 11 bots even when the <code>My MetaBots</code> folder is not present in the Control Room because this folder is no longer validated during migration.
Enhanced user management
You can now view the activity of bots started by other users from the folders for which you have run and scheduling permissions.
Enhancement to API key validity setting (Service Cloud case ID: 00543590, 00719480, 01373359)
You can now increase the duration of validity for API keys to 9999 days from the Control Room settings for authentication. Previously, the duration of validity for API keys was 45 days. With this enhancement, a Control Room admin need not regenerate the API key every 45 days to authenticate Automation 360 APIs.
Enhanced security in Image Recognition package
You now have enhanced security when you use any of the Image Recognition actions from the Image Recognition package. Image logging is now disabled to ensure that if a bot fails while running one of the Image Recognition actions, the captured source and target images are no longer stored in the log folder.
Enhancement to subject filter in Email package (Service Cloud case ID: 00776374, 00953823, 975605)
When you connect to an Exchange Web Services (EWS) server, to repeat a set of actions on all the email messages that meet a set of criteria, use the Move all action from the Email package or use Loop > Iterator > For each mail in mailbox . The When subject contains field is now case sensitive. When you enter text inside a pair of double quotation marks (") in the When subject contains field, the bot retrieves all the email messages whose subject exactly matches the text and the case that you entered inside a pair of double quotation marks.
Change to default variable name
The name of the default string-type variable is now changed from <code>prompt-assignment</code> to <code>SampleString</code> .
Note: This change only impacts new bots.
Change in activity information on Historical page
The information about bot execution activity is retrieved for 90 days in the Control Room Historical activity page. Information older than 90 days can be viewed in the audit logs. View completed activity
Enhanced Secure Recording mode control
If you are an administrator, you can now enable or disable the Secure Recording mode based on assigned user roles (permissions) for more granular control of the Control Room. Secure recording

The following table lists fixes alongside the build in which each issue was fixed. Build 12350 is the latest build and includes fixes from the previous builds.

Fixes		
Build	Service Cloud case ID	Description
12350	01768021, 01803781	After the upgrade, the Control Room is no longer unresponsive and behaves normally. Previously, the Control Room was unresponsive after the upgrade due to Java deadlocks.
12350	01802575, 01803323, 01803800, 01804121, 01804820	<p>After you update from a previous release to this release, when you run the bots, the migrated bots no longer show an error for variables within double quotation marks (" "). You do not have to remove the double quotation marks as a workaround to run the bots.</p> <p>For example, after you update from Automation 360 v.23, you can run a bot with the Excel advanced package that contains the following variable: "\$HeaderCounter\$"</p>
12342	00827504, 00788652, 00827730, 01259452	With the required permissions, you can now view the correct information in the Historical Activity page. Previously, a "Do not have sufficient permissions" error sometimes prevented even users with administrative permissions from viewing some of the entries in the Historical Activity page.
12342	00823799, 01623586	<p>When you migrate Enterprise 11 MetaBots with Input, Output, and None variable parameter types, these are now correctly mapped to the respective parameter type in Automation 360 after migration.</p> <p>Previously, the Enterprise 11 Input, Output, or None variable types were mapped to Input/Output type after migration.</p>
12342	00819756	After migration, when you run a bot that contains Switch to sheet action and the action is performed, the worksheet is now visible and is activated for further operations.
12342	01773270, 01781001	<p>The Cloud Migration Utility can now connect successfully to the database even when the database credentials contain the following special characters:</p> <p>& # @ % \$</p>
12342	00988580, 01200161	<p>After you migrate from Enterprise 11 to Automation 360, you can now Check out bots and dependent files to the Control Room Public workspace.</p> <p>Previously, the dependent files were not available for Check out in the Control Room Public workspace. The parent bots had to be checked out first so that the dependent files could be automatically cloned and available for Check out.</p>

Fixes		
Build	Service Cloud case ID	Description
12342	00788046	When you run a bot with the Wait, File, Folder as Actions or If/Loop as Conditions and if the Start Date and End Date options are set to the same date, these bots now execute the respective action or conditions based on the end date that is set.
12342	01598462	The Run Logic command now works correctly when MetaBots contain Logic with different parameters assigned to each Logic. If you disable one Logic in a MetaBot, the other Logic and its command will work correctly. Previously, if one Logic in a MetaBot was disabled, commands related to another Logic were disabled.
12342	01251985, 01264753, 01272804	In the SAP BAPI package, the Get Table command for the Table subtype now successfully retrieves results for the Import, Export and Table parameters. Previously, if you ran the Get Table command for the Table subtype for Import or Export parameters, the command failed.
12342	01262390	When you migrate Enterprise 11 bots that use the IF > File exists condition with a wildcard in the file name, they now run successfully irrespective of whether the parent folder is available in the path. Previously, if the parent folder was not present in the condition path, the bot stopped running and encountered an error. If you are on this release or an earlier one, you can use IF > File exists condition with the parent folder, along with current IF > File exists condition with wildcard.
12342	--	A migrated that includes the File and folder command has the Include start and end dates check box enabled by default. As a result, Enterprise 11 bots no longer fail in Automation 360 when the file rename operation is performed, even if the start and end dates specified are the same for comparison using the Is between condition.
12342	01751462	When the Run Task command with a variable path is disabled and the variable used in the path is deleted, the TaskBot can now be migrated, without any error. Previously, migration failed and a preprocessing error was displayed.
12342	00824337	The migration result no longer shows an error message when you migrate a bot with the credential name in Japanese.

Fixes		
Build	Service Cloud case ID	Description
12342	00783883	The HTML technology-based action (for example, GetProperty) now supports the retry mechanism, which enables you to migrate bots that include the recorder command with an inner text.
12342	--	You can now successfully migrate Enterprise 11 bots that have negative values for x and y coordinates for top and left fields.
12342	00827997	Bot Scanner now allows the migration of bots with multiple expression conditions that include a disabled line of code and no longer shows an error.
12342	00834597	Bot Scanner now successfully analyzes a MetaBot screen and no longer shows an error for the preprocessing of the source file.
12342	01213241	All plug-ins now successfully load when you open an Excel sheet using the Excel > Open action.
12342	01504682	Bot Scanner no longer shows an internal error even if a bot contains any of these special characters: .
12342	--	You can now successfully migrate Enterprise 10 bots that have roles with folder permissions. Previously, such permissions were not migrated. Note: The Run and Schedule role is not migrated.
12342	01632298	You can now successfully migrate bots with the Analytics variable through the Bot Migration Wizard, and after migration the status is displayed as successful. Previously, these bots were stuck in the In Progress state and therefore the bots did not run.
12342	00828781, 01258567, 01273170, 01469879	Bots now complete their execution faster than previously when a proxy is enabled through a PAC file in Cloud deployments.
12342	01385567, 01749465	The Control Room now correctly shows the information for Display intranet sites in Compatibility View in Compatibility View Settings . Previously, in Automation 360 v.23, a blank page was displayed because of an internal issue.
12342	00807226, 01148097	If an IP subnet address contains the numeral 80 (for example, 192.30.80.25), you can now configure the Control Room port to 80 in the installer. Previously, if the subnet address contained the numeral 80, the Control Room port could not be configured to 80. A different port number that did not contain 80 had to be configured for the IP.

Fixes		
Build	Service Cloud case ID	Description
12342	00836549	When you copy a role by using Create Role within a Control Room, user and bot permissions are now correctly retained. Previously, editing the associated role caused all associated bot permissions to be lost.
12342	01434341, 01755003, 01755713, 01756244, 01757083, 01756871, 01758346	You can now successfully search for Japanese characters within bots by using the Find in this bot search box. Previously, the Japanese characters typed through the keyboard were not entered correctly and you had to use a workaround to search for Japanese characters. <i>Japanese language search support</i>
12342	--	If you Check in a bot to the Control Room Public workspace after filtering any dependency data, when you export the bot, only the filtered data is displayed now. Previously, even after filtering the dependency data, all data was displayed.
12342	00819477	You can now view dependent files when you open a bot in the bot editor. Previously, the dependent files were listed only in view mode.
12342	--	When a device pool name includes the underscore character (_), the MSI Installer now completes autoregistration of device pool properties, resulting in device pool names with underscores to populate. Previously, the MSI Installer did not complete autoregistration of a device if the device pool included an underscore character.
12342	01758029, 017596611	You can now use Azure AD authentication to connect to Azure database server when you install the Control Room using Windows installer and installation script. Previously, if Azure AD authentication was selected on the Database server window, Control Room installation failed.
12342	--	After you install or upgrade Automation 360 from a previous release, the Control Room Installation summary page now displays the correct version number. Previously, the page displayed an incorrect version number.
12342	00796190, 00827493, 01251725	When you deploy a bot, the run-time window now displays the correct line number and package name for the capture desktop action of the Error Handling package. You can find the exact line number that caused the error by using a variable in the Error handler: Catch > Assign line number to option.

Fixes		
Build	Service Cloud case ID	Description
12342	00800990	<p>You can now rename a bot by changing the text from uppercase to lowercase or from half-width to full-width characters. For example, you can rename a bot from Automate to automate.</p> <p>Previously, the text in the bot name could not be changed. When the text was changed, the following error message was displayed:</p> <pre>Unable to create a file with the name <filename>. That name is already in use. To continue, please rename your file. Code: repository.exception.file.exists</pre>
12342	01258242	<p>When you run a bot that contains multiple conditions and a missing operator in one of the conditions through the Bot editor, an error message is now displayed about the missing operator. When you update an action and save the changes and if there is a missing operator, an AND operator is now added by default. Previously, bots with multiple conditions failed intermittently with a preprocessor error.</p>
12342	00805738	<p>An error message is now displayed and you can no longer check in or check out files whose filepaths are identical except for differences in case. Previously, when the filepath had different cases and was checked in or checked out, there were issues during bot deployment.</p>
12342	01753711	<p>You no longer encounter any issue when you check out a folder that contains tasks with dependencies. Previously, casing-related issues occurred in string comparison operations, which caused errors in check-in and check-out operations.</p>
12342	01271474, 01761856	<p>When you assign a production label to a child bot that has more than one version, the production version is now displayed during bot operations. Previously, instead of the production version, the latest version of the child bot was displayed.</p>
12342	01270601, 01260628, 01255632, 01758499, 01775489,01773778	<p>When you connect with Microsoft Outlook, IMAP, or POP3, you can now create a bot and save all emails to a folder even if the email subject line contains slash (/) or backslash (\) characters. When you save the emails, the slash (/) and backslash (\) characters in the subject line are now replaced by an underscore (_) character.</p>

Fixes		
Build	Service Cloud case ID	Description
12342	01755993, 01782945, 01775161, 01792954	In the Email package when you connect to Microsoft Outlook to automate an email-related task, you can now use the Move all action followed by Loop action to move unread emails from one folder to another folder. Previously, when you ran the bot, the bot failed to move the unread emails because of an error.
12342	01264563	You can now create a bot using the Global session option in the Open action of the DLL package and choose DLL session does not exist for the If condition. Previously, an error was encountered when the Open action of the DLL package and the If (DLL session does not exist) condition were called multiple times in a sequence.
12342	01258059	In the XML package, when you create a bot to retrieve the data by using the Get single node action and if the XML file has some lines that are commented out, the output no longer shows those lines. Previously, the output displayed the lines that were commented out.
12342	--	In SOAP Web Service, when you select Raw data parameter and use the Build Xpath option, you can now successfully extract values from the SOAP response and store the XML output in a variable. Previously, you could not extract values from the SOAP response because the Build Xpath option did not work as expected.
12342	01071731, 01762875	When you open a CSV or TXT file, read data from that file, and write data from a <i>Table</i> type variable to the file, the bot no longer fails if the CSV or TXT file contains large data sets. The bot now runs successfully even when the Create folders/files if it doesn't exist and Override existing file check boxes are selected in the Write to file action.
12342	00968574	An error no longer occurs when you create a bot by using the Open action of the VBScript package and select a <code>VBScript</code> file from the desktop with the file extension in uppercase. Previously, if the file extension was in uppercase, the bot failed because the file was considered an invalid script file.
12342	00831463	Using the Email package, you can now send emails with the email subject containing a combination of Japanese half-width characters and katakana characters. Previously, if email subject contained a combination of Japanese half-width characters and katakana characters, the output displayed was garbled in the mail received.

Fixes		
Build	Service Cloud case ID	Description
12342	00822222	When you connect to the EWS server to automate an email-related task, you can now send multiple emails without providing any value in the subject field when you use the Send email action in a loop. Previously, when there was an empty value in the subject field, the bot failed to read such mails.
12342	00823283	In the FTP / SFTP package, you no longer encounter an error when you provide the folder name as a dot (.) in the Get folders action. When you run the bot, it downloads all the folders from the current directory to the local folder path provided in the action.
12342	00824379	In the Google Sheets package, when you open a spreadsheet and use the Go to cell with the cell option as Specific cell and if the spreadsheet has more than 40000 rows and you select the One cell below option, the bot now executes successfully. Previously, an error occurred on bot execution.
12342	00788970	The bot name is now translated correctly in Chinese (Simple Chinese) in the Bot running window. Previously, the bot name was displayed as garbled in the Bot running window.
12342	01270344, 01767148	When you use the Google Sheets package and open a Google spreadsheet, you can now use the Get all sheet names action to successfully retrieve the names of all the sheets. Previously, if the Google spreadsheet had more than five sheets in it, the bot encountered an error.
12342	01709026, 01755897, 01768689, 01761434, 01554474	An error no longer occurs when you establish a connection by using the ODBC driver in the Database package. For Microsoft SQL Server, the blank value is now inserted as 0 in the database table for the <code>int</code> column.
12342	01602081	When you use actions from the REST Web Service package to send requests and receive responses from a REST API and to store the response status of the API in a dictionary variable, REST now returns headers and empty body content in response even if the API does not have response body.
12342	01758733	When you migrate from Enterprise 11 to Automation 360, after you edit or add some actions to a bot that does not exist in a parent bot, when you save the bot, it is now saved without any delay. Previously, it took some time to save the bot.
12342	01254323	An error no longer occurs when you use the Create workbook action of the Excel advanced package to create a workbook inside a folder in a network drive path.

Fixes		
Build	Service Cloud case ID	Description
12342	01036851	When you open a file with <code>.xlsx</code> extension by using the Open action of the Excel advanced package, the bot no longer fails even if an intermediate parent folder does not have access privileges. For example, the Open action can open the file from <code>\\share\A\b\c\file.xlsx</code> if the <code>\\share\A\b\c</code> folder has access privileges even if the <code>\\share\A</code> or <code>\\share\A\b</code> folder does not have access privileges.
12342	00827204	On computers that use the Japanese and Chinese versions of operating systems, an error no longer occurs when you try to return a tab to the first web page it opened by using the Go back action of the Browser package and deselect the Throw an error if step exceeds history option.
12342	00777283, 00829912	When you use the Open action of the Excel advanced package to open a Microsoft Excel worksheet, use the Replace action of the Excel advanced package to replace a string in the worksheet, and then run the bot, the bot now runs as expected and is not stuck even if the string to be replaced is not present in the Excel worksheet.
12342	00835312	An error no longer occurs when you create a shortcut to a folder by using the Open program/file action of the Application package to open a file and then using the Create shortcut action of the Folder package.
12342	00757943, 00787404, 00788421, 00807528, 00822941, 01018972	You can now use the AI Sense action in a parent bot and the OCR action in a child bot, or both actions together, to successfully run your bot. Previously, this caused an ABBYY FineReader Engine 12 error.
12342	01212753, 01470071	When the current session of an application on Citrix is closed and the application is restarted, the Recorder now identifies the object and successfully performs the correct action. Previously, the Recorder failed to identify the object.
12342	00742936, 00808117	You can now convert a datetime value by specifying custom datetime formats (for example, <code>hh:mm:ss</code>). Previously, an error occurred when you used the <code>hh</code> convention to specify a custom datetime format.
12342	01266752	When you use the 6.2.0-20210903-141520 version of the Excel advanced package to run a macro on a Microsoft Excel worksheet, the values in the referenced cells in the Excel worksheet are now updated correctly.

Fixes		
Build	Service Cloud case ID	Description
12342	01755439	An error no longer occurs when you use the 2.5.3-20220304-010651 version of the Recorder package to capture an object. Previously, when you used the 2.4.0-20211118-080716 version of the Recorder package, the bot failed with the following error message: <code>The bot could not be executed due to an error in setting up the execution environment</code>
12342	01276429	After migration, you can now call a reusable bot with the new package version from the same parent bot with which it shared a session. You can do this by inserting a session variable initialized with a value to a key in the dictionary with the Dictionary > Put action.
12342	00805417, 00815023, 01049408	You can now use the Recorder to successfully run keystrokes and capture objects on a new tab opened in the Google Chrome browser.
12342	--	In the Browser > Open action, when you select the Last used browser tab preset for the Internet Explorer window under the Existing tab option, the corresponding tab and window are now activated.
12342	01755590	In RPA Workspace, when you navigate to Automation > Bot Store and log in, you can now access the Bot Store without issues.
12342	--	When you add or remove a consumer role from the locker, role values are no longer changed when you sort the table. Previously, the values in the Modified By and Last Modified columns were inadvertently modified.
12342	01272058, 01752731	You can now pause or stop your in-progress workload automations and the <code>Internal server error</code> no longer occurs. Previously, the workload automation could not be paused or stopped after the user who created the automation was deleted from the Control Room.
12342	01181402, 01260706	When you run your workload automations, you no longer have to pause and then resume to run the queued bots that are stuck in the In progress state.
12342	00790086	The incorrect Japanese translation for schedule description of the daily and monthly frequency fields for the Run repeatedly option (Manage > Schedules > Schedule a bot) is now fixed. The correct Japanese description is now available on the Schedule a bot page.

Fixes		
Build	Service Cloud case ID	Description
12342	00852637	When you edit a bot schedule in the Control Room, the schedule column on the Scheduled page now displays the correct schedule date instead of the previous day. Previously, for example, if a bot was scheduled for 01-Oct-2021, the Scheduled page displayed the schedule date incorrectly as 30-Sep-2021.
12342	00821057, 01188160	If a file is exported after the bot name and folder path are changed, the bot name now reflects the new name. Previously, the bot was exported with the old name.
12342	01252294	You can now successfully import the zip files in the <code>zip64</code> format from the development environment to the production environment.
12342	--	You can now run multiple queues without any delay in between queues. Previously, when you ran multiple queues, a delay of 5 to 15 minutes sometimes occurred between queues.
12342	00800831, 00815411, 00826054, 00826058	When you use the Export checked items to csv option, the schedule data in a <code>.csv</code> file is now saved correctly. Previously, when you exported the schedule data to a <code>csv</code> file from the Control Room Scheduled activity page, the file data was saved incorrectly. For example, the schedule type was saved as Recurring in the <code>csv</code> file instead of One time .
12342	01754721, 01753460, 01767806 01759361, 01763327, 01764201, 01767827, 1770574	If the system locale setting is changed, the weekly scheduled bots now run as scheduled from the Control Room. Previously, when the system locale setting was changed, the bots did not run according to schedule.
12342	00714546, 00759029, 01257992	The Control Room can now integrate a Git repository that rejects force push. Previously, some security protocols rejected all force push updates making the git integration incompatible without a configuration for the force push flag. You can now change the configuration of the Git push from the Control Room to disable the force push flag.

The following table lists the limitations identified in the current release:

Limitations
(Service Cloud case ID: 01765712) If a MetaBot Logic was using a DLL file that used classes without namespaces, after migration, any TaskBot that uses the MetaBot Logic does not work. Workaround: Manually update the DLL file to include namespaces for classes.

Limitations
<p>If you created the Active Directory role mapping in previous releases, when you update to Automation 360 v.24, some previously defined group mappings are deleted because the Distinguished Name (DN) column of the mapping entries in the database contains empty rows, with no values. Before you update to Automation 360 v.24, run a script to populate the DN column. (Service Cloud case ID: 00751756)</p> <p>For support on this issue, contact the support team: Open a support case (A-People login required)</p>
<p>The Bot Insight premigration utility encounters an error and closes when it detects corrupted dashboard IDs in BI tables. (Service Cloud case ID: 00796546)</p> <p>Workaround: Download and install the latest Bot Insight premigration utility from the Automation Anywhere Support site.</p>
<p>When you build bots by using drag actions from the Actions palette, the bot workflow shifts to the right side in the Flow view.</p> <p>Workaround:</p> <ul style="list-style-type: none"> When you create or edit a bot in the Bot editor, add new actions from the Actions palette by double-clicking the action that you want to use. <p>For example, if you are editing a bot and you want to add an action after line 7, place the insertion point after line 7, and then, from the Actions palette, double-click the action that you want to add.</p> <ul style="list-style-type: none"> If you want to use the drag option, ensure that when you drag the actions, you move them a little faster on the canvas.
<p>(Service Cloud case ID: 01798098) When you update Automation 360 from a previous release to this release on a Windows machine, you might see the following error message about an invalid digital signature:</p> <pre>Error 1330: A file that is required cannot be installed because the cabinet file E:\AA\...\Data1.cab has an invalid digital signature.</pre> <p>Workaround: A360.24 Installation Failure "Error 1330 Invalid Digital Signature" (A-People login required)</p>
<p>If the Automatically update all bot agents option is selected and if you update to this release, some Bot Agent might fail to automatically update to the latest version.</p> <p>Workaround:</p> <ol style="list-style-type: none"> Manually uninstall the existing version of the Bot Agent. Install the latest version of the Bot Agent.
<p>When you migrate Enterprise 11 bots with the Comment command enabled, the command is disabled after migration. (Service Cloud case ID 01255723, 01252824, 01260677, 01608653)</p>
<p>When you log in as an administrator after migration and then start a bot migration, the Audit Logs pane intermittently displays an unsuccessful message with a <code>Bot Launcher has crashed</code> error.</p>
<p>When you migrate bots with system variables (such as date, month, or year) as an Export Data to CSV option, a preprocessing error is displayed. (Service Cloud case ID 01755175)</p>

Limitations
<p>When you update your Control Room from Automation 360 v.21 or v.22 to Automation 360 v.23 or v.24, the installation might fail because of schedule migration issues. (Service Cloud case ID: 01376353, 01449535, 01713118, 01627144, 01762404)</p> <p>Workaround: Open a support case (A-People login required).</p>
<p>Administrators can export data, up to 100,000 entries, to a CSV file. Downloaded audit .csv files are stored in the C:\Windows\TEMP\ folder in the On-Premises environment temporarily. Files in this folder with names starting with <code>cr-audit</code> should not be deleted for at least 90 days and can be downloaded from the Control Room.</p> <p>See .Export audit data to CSV</p>
<p>When you autoupdate the Bot Agent simultaneously on 500 to 1000 devices in the Control Room (On-Premises), the autoupdate fails.</p> <p>Workaround: Manually update the Bot Agent on a few devices at a time from the Control Room Devices page.</p>
<p>In browsers such as Microsoft Edge (Chromium) and Mozilla Firefox, when the Bot Agent installer file is downloaded, the download information is shown at the top-right corner although the download arrow points to the bottom-left corner of the browser's taskbar.</p> <p>The download arrow points to the correct direction only for the Google Chrome browser, in which the download information is shown at the bottom-left corner of the browser's taskbar.</p>
<p>For a Control Room installed on Linux operating system, the <code>AutomationAnywhereBotAgent.msi</code> file is not available for download with the Download installer option from the Control Room > Administration > Settings page.</p> <p>Workaround: To install the Bot Agent, use the <code>AutomationAnywhereBotAgent.msi</code> file from the <code><application filepath>\crui\asset</code> folder of a Control Room (On-Premises) installed on Windows operating system. For more information, see Sample steps to create Bot Agent golden image (A-People login required).</p>
<p>In the Email package, when you use the HTML design option to create and customize your email layout and body and then paste content copied from another source, such as Outlook or Notepad+, the font style, size, and color are currently not retained for the following actions:</p> <ul style="list-style-type: none"> • Send • Reply • Forward
<p>When you create a bot using actions such as Send, Reply, or Forward from the Email package, choose an option from Plain text, HTML design, or HTML code to format your email body. When you switch between these tabs (Plain text, HTML design, or HTML code), the previously set value in the message body is not retained, and the message body is blank.</p>

Limitations
<ul style="list-style-type: none"> Nested IFrames are not supported in the Google Chrome and Microsoft Edge Chromium browsers. Support to capture window authentication pop-ups is not available when automating Google Chrome browser. After performing an action in an application or page, if a frame is added at run time to the application or page, and if any pop-up windows, alert dialog boxes, confirmation dialog boxes, or prompt dialog boxes appear on that frame, then the pop-up windows and dialog boxes are not captured. <p>Workaround: Use the actions in the Image recognition package or the Mouse > Click action instead to run the bot.</p>
<p>On computers where SystemLocale is set to a non-English language, when you open multiple tabs in a browser, try to execute any action on a new tab that is currently inactive, and run the bot, the inactive new tab does not become activated.</p>
<p>In Internet Explorer, to activate one among multiple web pages with no titles, only the fully qualified domain names (FQDN) are compared. If pages that have no titles but have the same FQDN are opened in Internet Explorer, any tab that matches the FQDN is activated.</p>
<p>In Internet Explorer, when you use the Close action to close a tab or a window, it is closed only if it does not have an alert dialog box.</p>
<p>Note: An Internet Explorer tab or window with an alert dialog box is closed only when the alert dialog box is closed manually.</p>
<p>When you use the Open action of the Excel advanced package to open files with <code>.x1sm</code> extension that have charts, the bot fails with an error.</p> <p>Workaround: Provide the Excel sheet name in the Specific sheet name field and then run the bot. If there are any hidden sheets, unhide the specific sheet and make it as the active sheet.</p>
<p>When you automate web applications running on Microsoft Edge Chromium with IE mode or Internet Explorer, the Recorder sometimes fails to capture the object from the currently selected browser tab and captures from the last used tab instead.</p> <p>Workaround: Refresh the Bot editor and then start recording again.</p>
<p>When you use the Recorder to capture an object, select HTML Tag, HTML InnerText, and HTML type properties in Search Criteria, or migrate a bot with similar properties selected in Search Criteria, the bot might fail to identify or locate the object and perform the selected action.</p> <p>Workaround: Modify the DomXPath according to the controls you capture or add more properties in Search Criteria.</p>
<p>When you use the Datetime package released with Automation 360 v.23 or earlier to create a bot that uses the Datetime Assign action, then select the variable option to add the variable value and try to run the bot with package released with Automation 360 v.24 or later, the UI shows a compilation error, and the user must select the variable value again.</p>
<p>In the Recorder package, the Run in background option that enables an automation to run in the background is not supported for applications running on Google Chrome, Microsoft Edge, and Mozilla Firefox browsers for any of the Recorder actions.</p>

The following table lists limitations from previous releases that are also applicable to this release:

Limitations from previous releases
<p>When you migrate a bot that was using the Manage Window Controls action, the last digit of the height value is not available after migration. However, the bot will execute successfully. (Service Cloud Case ID: 01756996)</p>
<p>When an Excel session is active in SAP, a corresponding Excel process starts in the background. In such a scenario, Automation 360 uses the same Excel process that SAP started. When you run a bot to automate spreadsheet data, Automation 360 processes the first request successfully. However, during execution, if the Excel is closed and a subsequent request is sent for automating the spreadsheet data, Automation 360 does not process the request because the Excel process is still being accessed by SAP. Therefore, the correct window is not activated for automating the spreadsheet data. (Service Cloud Case ID: 00815159)</p>
<p>If you are directly updating from Automation 360 On-Premises v.21 to this release, you might face issues updating your Bot Agent on some Bot Runner machines in the following scenarios:</p> <ul style="list-style-type: none"> • After a Control Room update, the device status keeps changing and the Bot Agent fails to update automatically. • If the <code>embedded_resources</code> file is missing, the Recorder does not recognize the user interface elements or does not capture a single object in the Google Chrome browser. <p>Workaround: Before updating to this release, remove the following Bot Agent files and folders:</p> <ul style="list-style-type: none"> • <code>C:\Windows\System32\config\systemprofile\AppData\Local\AutomationAnywhere\AA-DB.mv.db</code> • <code>C:\ProgramData\AutomationAnywhere\GlobalCache\embedded-resources</code> <p>For more information, see Bot agent auto update fails post the Control Room Upgrade with 'device.connection.lost' (A-People login required) The recorder is not able to recognize the GUI elements in Google Chrome browser (A-People login required)</p>
<p>When you use the Terminal Emulator command with the Send Text action that contains the LF key (Enter), the command might fail if the LF key is not supported by the Terminal Emulator.</p> <p>Workaround: Ensure that you replace the LF key with supported characters such as the space character.</p>
<p>After migration, a user is able to delete an <code>.atmx</code> file even when the file is associated with a schedule from the Automation 360 Control Room.</p>
<p>If you configure an external key vault in External Key Vault Integration and select the SQL authentication mode for database authentication in the Windows installer Database Server page to install Control Room (On-Premises), the installation fails, and the following error message is shown: <code>Control Room database tables fail to create.</code></p> <p>Workaround: Add the database credentials in the external key vault and use those credentials for database configuration.</p>
<p>Newly created Control Room users on Windows for On-Premises Google Cloud Platform VMs cannot change their password. The security questions option is not available on the Change password screen and as a result the Control Room displays an error when they try to save the password.</p> <p>Workaround: Refresh the page and change the password again.</p>

Limitations from previous releases**(Service Cloud case ID: 01768545) Update status stuck as IN_PROGRESS during migration from Enterprise 11 to Automation 360**

When you migrate from Enterprise 11 to Automation 360, even if bot migration is successful, Bot Insight does not update the status to the Control Room. Until version 11.3.2, the analytical flag was historically enabled by default, so all created bots are identified as analytical bots. Some bots identified as analytical bots have no processed data available to the Bot Insight dashboard. As a result, the migration status becomes stuck as `IN_PROGRESS` even if bot migration is successful.

When you try to automate any process in a Java application that uses version 11.0.8 of AdoptOpenJDK, the Recorder sometimes does not capture the drop-down elements on the application.

Automation Anywhere Robotic Interface (AARI)

What's new**Microsoft Edge Chromium and Safari supported for AARI**

You can now create forms and processes in the RPA Workspace and run your requests, tasks, and bots in the web interface on Microsoft Edge Chromium and Safari browsers.

[Browser requirements for RPA Workspace](#)

Create password fields and hide sensitive information (Service Cloud case ID: 00714159, 01063512)

In the RPA Workspace, you can now create password fields by using the **Password** element in your form builder. You can use the **Password** element in the web interface to add masked text to your password fields in the initial forms to hide sensitive information.

[Configure processes](#) | [Password element properties](#)

Configure a scheduler user for each team

You can now access the **Process** page in the web interface to edit a process and assign a scheduler user for each team. This ensures that the bots in the process are deployed on the devices assigned to a team and that these devices are not used by another team. The **Team** scheduler user is set by default, but if a scheduler user is undefined, then the **Process** scheduler user is selected. The **Global** scheduler user will be selected only if the **Team** or **Process** scheduler users are not selected.

[Assign scheduler user to process in the web interface](#)

Configure scheduler deployment type (Service Cloud case ID: 00814885, 01276257)

You can now configure the scheduler deployment type for bot tasks in your process setup and determine how the bots in the process will be deployed. You can define the mapping between run-as user and the device that helps take care of constraints, such as credential constraints that require one-to-one mapping between the run-as user and the device.

[Configure deployment type for bots](#)

What's new
<p>Reference ID enhancement to requests</p> <p>You can now view the reference ID associated with your process in the Reference column of the Requests page. The reference ID is a combination of a prefix and a number that is created from a Process Key that you can enter when you edit your process for the first time. This reference ID is incremented whenever a request is created from the corresponding process.</p> <p>Reference ID properties Configure an AARI process</p>
<p>Request retention settings</p> <p>When you edit a process, you now have the option to set when your completed requests are moved from the Requests page to the Recycle bin. With this feature, you can avoid manually moving completed requests individually to the Recycle bin. You can choose to disable the settings to move completed requests to the Recycle bin. You can also set the number of days after which requests are deleted from the Recycle bin.</p> <p>Configure an AARI process</p>
<p>Default team assigned to process</p> <p>You can now edit a process to display the default team that the process is assigned to in the Default team field. The first team that a process is assigned to is automatically set as the default team. With this feature, you can view the default team that a process is assigned to without viewing each individual team.</p> <p>Configure an AARI process</p>
<p>View status of queued bots</p> <p>You can now view the status of your bots that are queued and are not actively running. The request view page now shows the In Queued label next to your queued bots that are not active.</p>
<p>Cancelled status for tasks</p> <p>You can now filter tasks by the Cancelled status in the Tasks page. This status will show a Cancelled label next to the filtered results to inform you of the tasks that were cancelled by a user. You can filter by this status from the drop-down menu in the status bar.</p> <p>Filter and search for a task</p>
<p>Fill initial form elements by URL parameters</p> <p>When you create a request, you can now fill initial form elements by creating query scripts that enter specific parameters in the initial form URL. These parameters are applicable only for Date, Number, Text Box, and Time elements.</p> <p>URL parameters</p>
<p>Storage service enhancement (Service Cloud case ID: 00768394)</p> <p>As a tenant admin, you can now set a configuration option to block upload of executable files to prevent a security breach. You can block the upload of files with the following extensions: .acm, .ax, .cpl, .dll, .drv, .efi, .exe, .mui, .ocx, .scr, .sys, and .tsp.</p>
<p>Run virtual window in bot configuration</p> <p>If you are an AARI Admin, you can configure bots in the Bots page and enable the Run your bot in virtual window option. With this option, an attended user in AARI Assistant can run bots in a virtual window without losing their user experience.</p> <p>Configure an AARI bot</p>

What's new
Add rules to Button element <p>You can now add rules to the Button element.</p> <p><i>Using the Button element</i></p>
Customize text in forms using updates to Label element <p>You can now customize the text in your forms in various ways, such as applying bold, italic, underline, and other formatting effects, changing the font size and color, and so on, by using the Label element. With these options, you can highlight specific messages or texts, such as next steps, warnings, or errors, when they are rendered in the initial form in the web interface.</p> <p>The Label element now provides the following formatting options:</p> <ul style="list-style-type: none">• Emphasis• Font color• Font size• Text alignment <p><i>Using the Label element</i></p>
Search and filter columns in a table <p>On the form builder screen, if you select the Enable column filtering check box for the Table element, users can search and filter the content for all the available columns when the bot is running.</p> <p>When you use the Table element to render a table in your initial forms, you now have the enhanced ability to search each column of your table by value.</p> <p><i>Using the Table element</i></p>
Additional options for rules <p>With additional options included for rules in the form builder, you can now perform the following:</p> <ul style="list-style-type: none">• Find a rule but using the search bar. In the search bar, enter the name of the rule or the element label that is associated with any condition or action in the rule.• Create a copy of a rule by using the Duplicate rule option.• For multiple rules, you can use the following options to rearrange the order in which these rules are executed at bot run time:<ul style="list-style-type: none">• Move up• Move down• Move to top• Move to bottom <p><i>Add rules to form elements</i></p>
Apply an action to multiple elements <p>If you are adding or editing a rule, when you are adding an action, you can now apply an action to more than one element by selecting multiple elements in the Then menu.</p>

What's new
<p>Additional If conditions for some elements</p> <p>When you are creating or editing a rule, you can now select additional If conditions for the following elements:</p> <ul style="list-style-type: none"> • Dropdown • Checkbox • Radio Button • Date • Time • Hyperlink
<p>Use Assign for updating the value of the Dropdown element</p> <p>When you are adding a rule, if you select the Dropdown element as an action item from the Then menu, you can now use the Assign drop-down menu to append or overwrite values when the bot is running.</p> <p>Add rules to form elements</p>
<p>Elements in If condition are available in Then action</p> <p>All the elements that are used as part of the If condition are now available as part of Then action.</p>
<p>Multiple lines supported for Text Area and Rich Text Editor</p> <p>Text across multiple lines is now supported for Text Area and Rich Text Editor elements within If and Then options.</p> <p>Add rules to form elements</p>

What's changed
<p>Enhancements to importing process to public folder</p> <p>When you import your process to a public folder, the process is now automatically published in AARI. Previously, you were required to check in the imported processes in the private repository and then check in the process again for it to be published in AARI.</p> <p>Import an AARI process Import process dependencies</p>
<p>Process page layout updated</p> <p>The layout of the Process page has now been updated to be consistent with the Bot and Team pages. The changes include columns for reference ID, key, name, description, tags, and teams. You can now filter your results in the search bar for faster sort and quickly reference the current global scheduler user on the page.</p>
<p>Active bot status</p> <p>In the request view page, you can now view the exact status of your bots by referring to the In Progress label next to your active bots that are currently running. Previously, the In Progress label showed both active bots and queued bots that were not running.</p>

What's changed
<p>Reference to replace Request ID in AARI on the web</p> <ul style="list-style-type: none"> You can now filter or query your requests in the Requests and Recycle bin tabs and tasks in the Tasks tab (Table View and Detail View) using the new Reference instead of the Request ID. The Requests, Team, Process, and Bots URL is now changed to <code>entity/ref/:ref</code> from <code>entity/:id</code>. If you open any request using Request ID, the URL now redirects using Reference. For example, consider the Request ID as 896 and Reference as 2-34 for a request. If you view the request using the Request ID (<code>/aari/#/requests/all#/requests/896</code>), the URL will redirect using the Reference (<code>/aari/#/requests/all#/requests/ref/2-34</code>). <p>Reference is a unique key that helps you identify your related processes and requests in the Requests, Team, Process, and Bot pages. Reference is easier to use and more meaningful than Request ID as it provides a logical sequence of referential number incremented per tenant. Reference is unique within a tenant, but it can be the same for two tenants.</p> <p>Reference ID properties</p>

The following table lists fixes alongside the build in which each issue was fixed. Build 12350 is the latest build and includes fixes from the previous builds.

Fixes		
Build	Service Cloud case ID	Description
12350	01788376	You can now launch AARI using the Bot Agent (version 21.133) connection without errors.
12350	01803979	If you have Control Room configured with SAML and you click the AARI icon on the Windows Desktop, you are now redirected to the AARI Assistant web page instead of the Control Room home page.
12342	01759135	When you use the Date element and select the Use the local system date when this form is loaded option, the date is now correctly displayed, with the local system date.
12342	01766579	If you are a Bot Creator, after creating a request using your AARI process, you can now submit the initial form and complete tasks without being stuck on the request view page.
12342	--	For RPA Workspace with SDS setup, when you enter data or upload files in your initial forms after selecting a process to run the request, you no longer encounter an exception error message.
12342	--	When you use the Checkbox element to create a CheckBoxGroup in your form and set form rules and conditions for each box in this group (C1, C2, C3, and so on), the selections now function properly in the initial form as defined your form rules.

Fixes		
Build	Service Cloud case ID	Description
12342	--	If you are a Bot Creator and an AARI manager, you no longer encounter an error when you run a bot by using the Team Members action from the AARI Web package to access teams.
12342	--	If you are a member of a team by role (that is, if you were first added to a role in the Control Room and the role was then synced to a team), you will now be able to view updated information for your requests and tasks. The page now automatically refreshes the latest request and task details.
12342	--	In the web interface, when tasks are completed in the request view, and you confirm by clicking Finish , Cancel , or any other primary or secondary option, these types of events are now captured in the Audit log history in RPA Workspace, as an AARI Human Task type of event.
12342	--	In Linux environment, you can now use the file upload functionality of AARI on the web without any issues. Previously, the file upload functionality failed with an access denied error because the <code>filestorage</code> directory was not automatically created to store the files.
12342	--	The Edit button no longer appears enabled for processes that are checked in, checked out, or cloned. Previously, you could edit the names of processes that were checked in, checked out, or cloned although the changes were not saved.
12342	--	For any element in a form, if you use the Mark field uneditable option on the form builder or disable it when you run the associated bot, form validations applied to that element are overruled.

Limitations
<p>In some scenarios, when you launch a bot that was configured to run in a virtual window, the virtual window starts and you are prompted to log into the window with your credentials.</p> <p>Workaround: Reboot your system and launch the bot again.</p>
<p>When you design a form, you can create references for hidden elements by using the Hidden elements option from the form properties. However, after you have designed the form, you cannot view or change the variables among hidden elements.</p>
<p>After you design a form with a drop-down rule assigned to your form, if you view the drop-down in read-only mode, you will not be able to view the changed data in read-only mode.</p>
<p>If you have Select file element in the form, then you cannot upload a file that has special characters (such as , () & ; - =) in the filename when you run the bot.</p>

Limitations
In the web interface, when you are on a page other than the main page and your login session disconnects and returns you to the login page again, the next= parameter is shown in the URL indefinitely. This can be an issue as the next= parameter is used to redirect the URL to a previous page but is currently not supported.
For the Text Box element, the Does not contain form rule is not working.
For the Rich Text Editor element, the Contains form rule is not working.
For the Table element, the Rows before scrolling option can support only up to four rows. If you specify five or more rows, this option is not supported and you must scroll instead.
If you create a form with the Document and Dropdown elements, when you attempt to submit this form, an error occurs. This error is due to the dynamic form schema, such as a drop-down field filled by a process that is present in the form with the document field and causes an error.

Discovery Bot

What's new
<p>Save the recording with a name</p> <p>After recording a process, you can now save the recording with a name. The name of the recording is displayed on the Recordings page for that process.</p> <p>Record a Discovery Bot business process</p>
<p>Share a description of the recording</p> <p>You can now provide a description for a recording of a process by using the Recordings page for that process. In the Recordings page, use the Description field to share the context and the purpose of the recording with the analyst. The description provided is also displayed in the PDD.</p> <p>Record a Discovery Bot business process</p>
<p>Delete a recording</p> <p>After you record a process, if you do not want to submit the recording data to an analyst for review, you can delete the recording by using the Recordings page for that process. In the Recordings page, use the Delete option to delete the recording.</p> <p>Record a Discovery Bot business process</p>
<p>Record business processes using AARI Assistant</p> <p>You can now use AARI Assistant to record business processes without signing in to the Control Room. To record a business process, start AARI Assistant by double-clicking the AARI icon on your desktop.</p> <p>Record a Discovery Bot process using AARI Assistant</p>
<p>Enhancements to custom opportunities</p> <p>You can now update the potential cost and savings for custom opportunities and save your changes to the process diagram. The potential cost and potential savings can be updated at any time as you review the steps from various recordings and make changes within the process diagram.</p> <p>Review opportunities, convert to bot, and generate PDD</p>

What's new
<p>Enhancement to PDD</p> <p>You can now view the entire process diagram from within Discovery Bot by clicking the URL link provided in the PDD. The PDD does not display the process diagram if more than 100 steps are selected.</p> <p><i>Review opportunities, convert to bot, and generate PDD</i></p>

What's changed
<p>The process discovery document (PDD) now displays Chinese Unicode characters in both Word format and PDF.</p>

Fixes	
Service Cloud case ID	Description
--	Cloud users: When you capture more than 250 steps, you can now create a customized opportunity for automation and generate a PDD.
--	You can now download a PDD for custom opportunities and recordings without any issue. Previously, an error occurred intermittently and the following error message was displayed: <code>Error generating PDD</code>
--	An error message is now displayed when you cannot connect to the Control Room. For example, this occurs when a signed or wildcard certificate is used for the Control Room setup for On-Premises deployments and you have not pre-installed the certificate. The Processes page fails to load. Follow the instructions in the message to connect to the Control Room.
00829246	Cloud users: You can now download a PDD for an automation opportunity with 200 or more steps. Previously, when you created an opportunity with 200 or more steps, clicking Download PDD returned an error.
--	For autogenerated and custom opportunities, the Recordings table now works as expected. Previously, it encountered an error intermittently.
00827381	When you search for the Recorder package in the Japanese UI, you can now view the correct package name for the Recorder.

The following table lists the limitations identified in the current release:

Limitations
<p>In rare situations when a device CPU is busy, the recording screenshot might not be captured from the Recordings page for a process. However, user actions, such as text selection, are displayed on the Recordings page.</p>

The following table lists limitations from previous releases that are also applicable to this release:

Limitations from previous releases

When you add branches to the left and right sides of a main branch, the Recording flow chart section of the PDD might not capture the entire process workflow, including all the branches.

IQ Bot

What's new**Document Automation limited availability release**

A select group of early adopters can now use Document Automation to automate processing business documents in the new Automation Anywhere Cloud-native intelligent document processing solution.

Document Automation is integrated into the Control Room. When you create a learning instance, IQ Bot automatically creates RPA bots to extract and download the data and an AARI process to manage the entire process. Learning instances do not require training. Instead, Document Automation uses pre-trained models to process invoices and receipts.

[Document Automation](#) | [Intelligent Document Processing solutions feature comparison matrix](#)

Total number of pages uploaded for Process Documents action

In Automation 360 IQ Bot, when you use the **Process documents** action from the IQ Bot Extraction package to process documents, you can now view the total number of pages uploaded displayed under **Dashboards > My totals**

[Using IQ Bot Process documents action](#)

Role-based access control (RBAC) available

Automation 360 IQ Bot now offers role-based access control (RBAC). You can use RBAC to handle the following user permissions:

- Edit learning instance
- Delete learning instance
- Send learning instance to production
- Import domain

[Defining a custom role for IQ Bot](#)

Rotate encryption key as AAE_IQ Bot Admin

With the **AAE_IQ Bot Admin** role, you can now rotate the encryption key by changing the object name in the new **Administration > Key rotation** page.

[Rotate the external key](#)

New model for Cognitive MLWeb Service

In On-Premises installations of Automation 360 IQ Bot, you can now achieve improved check box and table detection when you use the new model of the Cognitive MLWeb Service.

What's changed
For on-premises installations of IQ Bot, the MLScheduler Service in the Microsoft Windows services window is now disabled, by default, to free up system resources.

Fixes	
Service Cloud case ID	Description
00764550, 00765854	When you migrate from Enterprise 11 to Automation 360, any learning instance with custom domain that has Chinese language fields is now displayed correctly. Previously, these fields were populated with incorrect values in place of Chinese characters.
00758208, 00632965, 00727063, 00715124, 00828988, 01251514	The MLScheduler service is now disabled on IQ Bot On-Premises, and the system no longer slows down or stops responding. Previously, the autocorrection and autosuggestion features, which are part of the MLScheduler service, used system resources extensively and caused the system to slow down or stop responding.
01757917	Documents are now successfully classified using Microsoft Azure 3.2 OCR. Previously, due to deprecation of the Microsoft Azure preview OCR v3.2-preview.2, the documents remained unclassified.
--	Documents extracted using the Auto Extract command are now successfully processed. Previously, when documents were extracted using the Auto Extract command, validations from the default validation group were not applied to them.
01261531	When you create a learning instance and use the IQ Bot upload command, the display is now stable, without any issues. Previously, this caused resizing and toggling between larger and smaller fonts, making the display flicker.
--	To manually create a group, you require only the IQBot_admin role now. Previously, to manually create a group, you required both the aae_basic and IQBot_admin roles.
--	In the IQ Bot UI, for groups that were created manually, you can now see the Group label in its entirety. Previously, you could see only a part of the Group label .
--	Documents whose file names begin with a special character, such as a hyphen (-), are now properly classified and processed. Previously, such documents were held up in the classification queue or remained unprocessed.
01063054	You can now import a learning instance that has a lengthy name, with more than 50 characters, without any errors because the Label field now supports more than 50 characters.
--	For a standard forms learning instance, if you upload a document that contains a table with an empty cell, the document is now sent to IQ Bot Validator. Previously, documents with empty table cells were sent to the Failed folder.
--	An error no longer occurs when you run a bot that contains actions from IQ Bot Pre-processor, IQ Bot Classifier and OCR packages. Previously, in such cases, an 'Assertion failed' error occurred.

Fixes	
Service Cloud case ID	Description
01777853	You can now create standard forms learning instances using pretrained models that have long field names (up to 250 characters). Previously, pretrained models that had lengthy field names caused an error.

Limitations
When you upload vector PDF documents to a new learning instance, a few documents are identified as unclassified. Alternatively, if you convert the documents from PDF to TIFF and upload them, the documents are processed successfully.
When you are running IQ Bot using service account credentials, if the password contains a space, IQ Bot logs will not be updated.
In some cases, even if the correct number or amount is accurately reflected, some documents still fail the validation rule because of a round-off error and are sent for manual validation.
In formulas, if you use delimiters, such as commas or periods as thousand separators, formula validation fails. Workaround <ul style="list-style-type: none"> • For English language: Remove all delimiters, such as commas used as thousand separator. • For other European languages: Remove all delimiters, such as periods used as thousand separator. Use the English number convention for formula validations.
If you use the ABBYY FineReader Engine version 12.4 instead of version 12.2, the MICR feature does not support data extraction from documents in Japanese language.
After you back up the databases and run the DB Migration Assistant tool, the tool and the logs indicate that migration is successfully completed even if the unified database is not created. Workaround: Ensure that you install both the x86 and x64 versions of the Microsoft Visual C++ 2015-2019 Redistributable package.

Bot Insight

What's changed
startDateTime data now in standard format When you export data to Microsoft Excel, the date format will be exported based on the date format of the widget.

Fixes	
Service Cloud case ID	Description
--	Now when you are using a proxy network, when you click Analyze , the network dashboard generates an analysis. Previously, this dashboard did not generate an analysis.

Fixes	
Service Cloud case ID	Description
--	When you run a bot that was checked in to a public folder and then checked out into a private folder, the last refreshed date is now displayed accurately. Previously, the last refreshed date was displayed as invalid.
01252869, 01259449	The Business Dashboard is now visible to users assigned the BI Admin Role and BI User License. Previously, users with this role and license were not able to access this dashboard.

Limitations
<p>Cannot drill down for data used in group by duration</p> <p>When Group By is selected as duration (time/date) in the widget, the drill down is applicable only to a single level. If you try to drill down for data at the second level or further, you might encounter the following error: <code>No data found</code>.</p> <p>(Service Cloud case ID: 00777595) When you attempt to refresh the data in a Microsoft Excel worksheet, an authentication error can occur from multiple simultaneous attempts through open windows and tabs.</p> <p>Workaround</p> <ol style="list-style-type: none"> 1. In the Power BI desktop application, navigate to File > Options and settings > Options. 2. From the Current File section, select Data Load. <hr/> <p>Note: Do not select Data Load from the Global section.</p> <hr/> <ol style="list-style-type: none"> 3. Disable the check box Enable parallel loading of tables.

Automation 360 v.23 Release Notes

Release date: 30 December 2021

Review what's new and changed, and the fixes and limitations in the Automation 360 v.23 (Build 11513) release. Build 11513 replaces Builds 11499 and 11486.

Important:

- This build includes the Apache Log4j2 library version 2.17.1 to address the exposure to CVE-2021-44832, CVE-2021-45105, CVE-2021-44228, and CVE-2021-45046 vulnerabilities.

Though the command packages are not upgraded to Apache Log4j2 library version 2.17.1, the Bot Agent is upgraded to Apache Log4j2 library version 2.17.1. At runtime, the packages will use Apache Log4j2 library version 2.17.1 through the Bot Agent and hence will not be exposed. As an additional security measure, the Automation 360 v.23 Bot Agent installer also disables the Apache Log4j2 library look-up feature by default.

Third-party security scans might find traces of earlier versions of the Apache Log4j2 library. However, with the upgrade to Automation 360 v.23 and the mitigation in place, there will be no exposure to vulnerabilities. For more information, see [FAQs related to Automation Anywhere Releases regarding zero-day vulnerabilities \(CVE-2021-44228, CVE-2021-45046\) \(A-People login required\)](#).

- This build also includes fixes for the following issues:
 - When you update from Automation 360 v.22 to v.23, background jobs related to cloud license server sync-ups were deleted because of incorrect license job name.
 - When you install or update to Automation 360 v.23 for On-Premises deployments, log files were not updated for a few additional services.
 - If you did not have the **View Package** permission, bot deployments failed when you scheduled or ran a bot.

- **Migration**

[11.x and 10.x](#) | [11.x only](#)

- **RPA Workspace**

[What's new](#) | [What's changed](#) | [Fixes](#) | [Security fixes](#) | [Limitations](#)

- **AARI**

[What's new](#) | [What's changed](#) | [Fixes](#) | [Limitations](#)

- **Discovery Bot**

[What's new](#) | [Fixes](#) | [Limitations](#)

- **IQ Bot**

[What's new](#) | [What's changed](#) | [Fixes](#) | [Limitations](#)

- **Bot Insight**

[What's changed](#) | [Fixes](#) | [Limitations](#)

Updating to this release

The updated Build 11513 for Automation 360 v.23 includes Log4j2 library version 2.17.1 and fixes. If you are on the previous v.23 Build 11499 (with Log4j2 library version 2.17.0) or Build 11486 (with Log4j2 library version 2.16.0), update to Build 11513 for the updated Log4j2 library version and the fixes.

You can also update to Automation 360 v.23 from the previous three releases (that is, from $n-3$ releases, where n refers to the latest release). The following previous releases are certified for update to this release:

- v.22 (Build 10526)
- v.21 (Builds 9664, 9642, 9595)
- v.20 (Build 8815)

You can directly update to v.23 from any of these builds (see [Update to latest Automation 360 version](#)). If you are not on an $n-3$ release, update Automation 360 to one of the three certified releases (listed previously) before updating to this release.

If you are directly updating to this release from Automation 360 On-Premises v.20 or v.21, remove the following Bot Agent files and folders:

- C:\Windows\System32\config\systemprofile\AppData\Local\AutomationAnywhere\AA-DB.mv.db
- C:\ProgramData\AutomationAnywhere\GlobalCache\embedded-resources

Bot agent update: To use the new features in v.23 (including updates to Recorder packages) and for the Log4j2 vulnerability fix, update the Bot Agent for this release. Note that the Bot Agent update from the previous release is not required if you want to run your existing bots as Bot Runners.

For information on updating to this release, see these resources:

- [Automatically update the Bot Agent | Manually update the Bot Agent](#)
- [Compatibility with Automation 360 builds](#)

For the latest updates to the Automation 360 extensions for Google Chrome, Microsoft Edge, and Mozilla Firefox, see [Enhancements to browser extensions](#).

Migration features

Enterprise 11 and Enterprise 10 features
<p>MetaBots containing linked objects</p> <p>Migrate MetaBots that contain a text play type linked object that is linked with the object play mode object, an image play type linked object linked with the image play type object, and a coordinate play type linked object linked with the coordinate play type object.</p>
<p>Migrate bots with the following attributes:</p> <ul style="list-style-type: none"> • Bots with variables that contain data larger than 64 KB (Service Cloud case ID: 00716311,00756449,00819149) <p>The migration process stores the data in a text file. The text file is uploaded to the Cloud Control Room and is used in the migrated bot.</p> <ul style="list-style-type: none"> • MetaBots with DLLs that return list and array type values with any delimiters combination and store these values in the clipboard • You can now migrate MetaBots with image play mode that use the action GetVisibility • You can now migrate bots with the GetSelectedIndex and GetSelectedText actions for the UI Automation technology used in the Object Cloning command and MetaBot screens. • You can now migrate bots which automate applications with Java technology Type using the Object Cloning command with the action GetDataofAllchildren.
<p>Bots with different variable casing</p> <p>When you migrate a bot that has passed a variable from a TaskBot to a MetaBot Logic or from a MetaBot Logic to a TaskBot and if the casing of the variable name is modified in the MetaBot Logic, the migration process updates the variable name with the same casing as that of the bot corresponding to the migrated MetaBot Logic in the parent TaskBot.</p>
<p>Migrate bots with locator image (Service Cloud case ID: 00754508, 00776192)</p> <p>You can now migrate bots that contain images that are captured using the Object Cloning command.</p>
<p>MetaBots as dependencies are not downloaded</p> <p>The migration process does not download MetaBots that are available as dependencies. This restriction is to avoid downloading MetaBots and creating multiple copies of the same MetaBots because they are already available in the Control Room repository.</p>
<p>New action in Legacy Automation package for migration (Service Cloud case ID: 00797140, 00849161)</p> <p>Use the Get keystrokes delay action to match the duration of delay defined in Enterprise 11 bots for the Insert keystrokes command and simulate the same value in Automation 360 for the Simulate keystrokes action.</p>

Enterprise 11 and Enterprise 10 features

Notification about bots with issues in Bot Scanner report

The Bot Scanner report now flags Enterprise 11 or Enterprise 10 bots that have issues and therefore require action or review. For example, bots that have security issues or bots that refer to non-existent variables are flagged with an icon in the action or review message.

Improved validation of migrated bots

- Additional compile time validations are now available to validate a bot at run-time. For example, if a parent bot calls a child bot and the child bot has compilation errors, these errors are displayed when you try to run the parent bot. This ensures that an error does not occur in the middle of an automation or make it an incomplete automation.

This feature enables you to proactively identify all migrated bots that have compilation errors. Migrated bots with compilation errors are shown in **Successful with Review** section of the **Migration Report** and ensures that you can get a list of bots that require your attention.

To enable the bot validation feature, navigate to **Administration > Settings > Bots > Bot validation** and set it to **On**. See [Settings](#).

- The Bot Migration Wizard now displays validation error details for each bot in the bot migration results. Details about the errors help you to review and take action on the migrated bots, thereby saving time.

[Migrate Enterprise bots](#)

Enhanced bot migration assistant

The migration assistant is now merged with the error assistant to provide a comprehensive view of all the lines in a bot that require review or action by you, or which have errors in these and therefore require you to address them. This feature helps you to quickly identify the areas of bots that require your attention.

Support for 32-bit driver to connect database (Service Cloud case ID: 00757466)

To enable migration of Enterprise 11 bots with VBScript, 32-bit drivers are now supported in Automation 360 to connect the database.

Enterprise 11 only features

Migrate bots with the following attributes:

- Bots that include images that are captured using the **Object Cloning** command, **OCR > Capture area** command, **App Integration > Capture area** command, and **Mouse click** action.
- Bots that contain an HTML email body with local image references if the referenced images are available on the Bot Runner machine (Service cloud case ID: 00780065, 00790657, 00827527, 00822092, 00928116, 01181845)
- Bots that contain Microsoft Excel commands with file extensions such as `.ods`, `.htm`, `.html`, `.mht`, `.mhtml`, `.slk`, and `.pdf` to open an Excel file (Service Cloud case ID: 00799071)
- MetaBots that use the credential variable of non-string type to pass a numeric value as an input to a DLL function

RPA Workspace

What's new
<p>Enhanced administrator capabilities Properly licensed Automation Anywhere Control Room administrators can now create valid RPA users based on authentication with username and password and select not to require live authentication via email response. This feature enables administrators to resend "Welcome" authentication emails without having to reset the credentials assigned to RPA users.</p>
<p>Microsoft Edge (Chromium) supported for Control Room and Bot Agent</p> <p>You can now perform Control Room operations, and install and register your Bot Agent device using the Microsoft Edge based on Chromium browser.</p> <p>Browser requirements for RPA Workspace</p>
<p>Support for Azure Key Vault</p> <p>Automation 360 now supports Azure Key Vault, and you can now retrieve the following from the external key vault:</p> <ul style="list-style-type: none"> • Active Directory (AD), services account, and SMTP credentials • Auto-login credentials • Credentials by automations
<p>Bot Validation</p> <p>Bot validation check happens for new bots and when you run a bot. Control Room administrators can now turn the Bot Validation feature on or off. By default, this feature is turned off for every Control Room.</p> <p>Migrate Enterprise bots</p>
<p>Credential Vault variable supported in Run function action of the DLL package</p> <p>As a Bot Creator, you can now use the Credential Vault variable or credential type variable for the Number data type and pass it as an input parameter in the DLL function.</p> <p>Using the Run function action</p>
<p>File ID supported in Check permission action of Google Drive package (Service Cloud case ID: 00777716)</p> <p>The Check permission action of the Google Drive package now supports the File ID option to refer to files available in the <code>Shared with me</code> folder of Google Drive. By providing the File ID, you can now verify the Read, Write, or Delete access granted to you in the <code>Shared with me</code> folder of the Google Drive files.</p> <p>Google Drive package</p>
<p>New Credential package</p> <p>You can now use the Assign action in the Credential package to assign an insecure string or a variable directly to the credential variable.</p> <p>Credential package</p>

What's new**Web Services security supported in SOAP Web Service package** (Service Cloud case ID: 00481836)

As a Bot Creator, you can now provide credential variables in the raw data of the **SOAP Web service** action. You can create a credential variable, map the credential with a reference name in the credential mapper, and use the reference name in the raw data. Because this ensures that all security-related data can be defined in the Credential Vault and the credentials can be used in bots, you can safely deploy tasks without compromising security.

Example of using the SOAP web service action

New option in SOAP Web Service package

Use the **Build Xpath** option in the SOAP Web Service package to extract values from the SOAP response. You can now specify the Xpath expression or select the appropriate node from the response body and store the output in a variable.

Outlook server supported in Change status, Save email, and Delete actions (Service Cloud case ID: 00544534, 00557623, 00642506, 00659724, 00763565, 00680801, 00803975, 00818304, 00819362)

In the Email package, to automate a task you can now establish a connection with the **Outlook** server for the **Change status**, **Save email**, and **Delete** actions.

Read email from shared mailbox in Microsoft Outlook (Service Cloud case ID: 00728579, 00831622)

To automate email-related tasks, you can now select a shared account in Microsoft Outlook so that email messages can be read from the shared mailbox.

New encoding types supported in the Write to file action of Data Table package (Service Cloud case ID: 00767158)

When you use the **Write to file** action to write data from a Table type variable to a CSV or TXT file, you can now use the following encoding types from the encoding list:

- UTF-8: Works as UTF-8 without BOM
- UTF-8 with BOM (called UTF-8 previously)
- UTF-16LE
- Shift-JIS (Japanese encoding)

What's new
<p>Auto-save functionality in Bot editor</p> <p>In the Bot editor, when you use actions to build an automation, when a bot is not manually saved, an auto-save is performed and the bot now automatically saves the changes for specific events.</p> <hr/> <p>Note: The auto-save functionality is currently available only for specific events.</p> <hr/> <p>Some of the events that support auto-save functionality are as follows:</p> <ul style="list-style-type: none"> • Recorder: When you create a bot with certain actions and click Recorder, the event is saved, and when the recording is complete, the event is automatically saved. • Variable manager: When you create or edit a variable to insert it in an action, the changes are saved. <hr/> <p>Note: The auto-save functionality is not supported when you delete a variable or insert it by pressing F2 to open the variable list.</p> <hr/> <ul style="list-style-type: none"> • Actions menu (vertical ellipsis): When you select any action from this menu, for example Packages, the event is saved automatically. When you make any change to the Packages page and return to the Bot editor, the event is saved. • Find a file: When you click the Find a file icon, the bot is saved if it is not manually saved. Also, after you click the Add option, the bot is automatically saved. • Dialog boxes: When a dialog box is opened, it is automatically saved if any changes are made. <hr/> <p>Note: Auto-save is triggered only for top-level dialog boxes and not for nested dialog boxes.</p> <hr/> <ul style="list-style-type: none"> • Deleting variables: When you delete unused variables, the event is saved. • Bot name change: If you edit the name of a bot, the event is saved.
<p>New option in FTP / SFTP package (Service Cloud case ID: 00792346)</p> <p>Use the Credential option when you connect with the Secure FTP server type to automate a task. You can now use username and password for authentication.</p> <p>Using Connect action for FTP/SFTP</p>
<p>Enhancement to AISense Recorder</p> <p>AISense Recorder now supports automation of applications that use Brazilian-Portuguese and a combination of Brazilian-Portuguese and English interfaces.</p> <p>AISense for recording tasks from remote applications</p>
<p>Support for Capture anchor in AISense Recorder</p> <p>The AISense Recorder now supports the Capture Anchor option. When you run a bot to search for an object in an application in which the anchor changes frequently, you can use Capture anchor to override the default anchor and manually select an anchor to detect the object.</p> <p>Edit a task recorded using AISense</p>
<p>Enhanced support when selecting Object property in Recorder package</p> <p>After you capture an object using the Recorder > Capture action, you can now select a particular object property name from the list of available properties in order to retrieve the value of the object property using the Get property action. The list includes suggested property names from the search criteria in the Object Properties table.</p> <p>Recorder package</p>

What's new
<p>Enhancements to Number package</p> <ul style="list-style-type: none"> In the Random action of the Number package, you can now specify and limit the number of decimal digits required in the random number generated in the output. The existing Save the outcome to a number variable field is now renamed as Save the outcome to a variable. <p><i>Number package</i></p>
<p>Enhancements to Wait package</p> <p>Use the new Capture region feature in the Wait for screen change action of the Wait package to capture a specific region on an application by drawing a rectangle around it so that the bot automatically captures the coordinates of this region. You can perform the following actions:</p> <ul style="list-style-type: none"> Capture a specific region on a Windows application. Preview the captured image in the Preview window. Recapture a region if the image in the Preview window is not per user requirement. <p>The coordinates are renamed as follows:</p> <ul style="list-style-type: none"> Left is now X Top is now Y Right is now Width Bottom is now Height <p><i>Using Wait for screen change action</i></p>
<p>Enhancement to String package</p> <p>In the Extract text action of the String package, you can now extract a substring from a specified source string that occurs more than 1000 times in a file and up to a maximum limit of 999999.</p>
<p>Enhancement to File conditions in If package</p> <p>You can now use the new File extension condition from the Condition list in the If package to check the extensions of files and then execute actions based on the results.</p>
<p>Support for cross-domain IFrames in Google Chrome and Microsoft Edge Chromium browsers (Service Cloud case ID: 00825656)</p> <p>You can now capture and automate objects inside a cross-domain IFrame in Google Chrome and Microsoft Edge Chromium browsers by using Recorder > Capture or the Start recording option. After you capture an object inside a cross-domain IFrame, the path to the frame is stored in the FrameDOMXPath property, by default.</p> <p>The new FrameDOMXPath property identifies the path to the frame in which the object is located. You must select this property to run the bot successfully to capture objects on a cross-domain IFrame.</p> <hr/> <p>Note: This feature is available for the bots you create using the 2.4.0-20211016-070100 version of the Recorder package starting from this release.</p> <p><i>Recorder package</i></p>

<p>What's new</p>
<p>Support to automate Microsoft Edge Chromium with Internet Explorer compatibility mode (Service Cloud case ID: 00767502, 00787186)</p> <p>You can now automate web applications running on Microsoft Edge Chromium, by enabling the Internet Explorer compatibility mode, using the Universal Recorder where the objects are captured using HTML technology.</p> <p>Record a task with the Universal Recorder</p>
<p>Global session support for loop iterator based on Excel advanced</p> <p>You can now use the Global session option when you loop through each row in an Excel advanced worksheet. Use the Global session option to share a Microsoft Excel session across multiple bots so that you can use the same Excel worksheet across these bots.</p> <p>Using the Open action for Excel advanced</p>
<p>Enhancement to Excel advanced package (Service Cloud case ID: 00799071)</p> <p>Use the Open action of the Excel advanced package to open files with .ods, .htm, .html, .mht, .mhtml, .slk, and .pdf extensions.</p> <p>Excel advanced package</p>
<p>Check out a specific version of a bot</p> <p>To edit a bot in the Control Room Automation page, when you check out a bot from the Public to a Private workspace, you can now choose a specific version of the bot along with its dependencies by using the new Advanced options.</p> <p>Check out a single bot</p>
<p>New APIs for devices</p> <p>You can now allocate default devices by using the new APIs introduced in the <code>v1/Devices</code> section. Choose to set or not set a specific device as the default deployment device for a specified user by using the following APIs respectively:</p> <ul style="list-style-type: none"> • <code>/runasusers/default</code> • <code>/runasusers/default/unset</code>
<p>Configurable API-key validity (Service Cloud case ID: 00763420)</p> <p>You can now configure the validity of the API-key using the API-Key Duration feature available in the Administration > Setting > Security Configuration in Automation 360. You can set validity minimum of 1 minute or maximum of 45 days.</p>
<p>Bot version comparison</p> <p>You can now compare various versions of the bots in your public workspace. You can use the Compare versions option to select two versions of a bot and compare them for differences, and any modifications in your work flow are highlighted for your reference. You can also view the differences in the actions, packages, triggers, and variables between the versions.</p> <p>Compare bot versions</p>

What's new
<p>Production label support in bot development work flow</p> <p>You can now assign a Production label to a particular version of a bot. After you assign a label, you can run or export bots with a bot version of your choice. You can select the version associated with a production label to schedule, run, queue, and trigger bot development work flows.</p> <p>Assign label to a bot</p>
<p>Access to Automation Anywhere RPA Training & Certification</p> <p>A direct link to Automation Anywhere RPA Training & Certification is now added in the Automation 360 Help Center.</p> <p>Automation Anywhere University: RPA Training and Certification (A-People login required)</p>

What's changed
<p>Bot Scanner recommendation</p> <p>The Bot Scanner now recommends to proceed with migration (with or without review or action) when 95% or more than 95% of your bots can be migrated.</p>
<p>Assign credential variable to non-credential type variables for migrated bots</p> <p>For migrated bots, Automation 360 no longer restricts you from assigning the credential variable to a non-credential type variable in an insecure (non-secure) way. So you can now successfully run migrated bots that use the Run Logic command to pass the credential variable to a non-credential type variable in an insecure manner.</p>
<p>Enhancement to Recorder package</p> <p>The search algorithm for the Recorder package is now enhanced so that when you run a bot an object is captured only if its properties match the exact search criterion that you selected in the Object properties table. If the properties of the object do not match the search criterion exactly, then the bot fails with an error message. However, if the search criterion includes a wildcard character, then the bot captures the first object that matches the criterion.</p> <p>For example, to capture a text box from an application that has three text boxes named firstname1, firstname2, and firstname3, if you select HTML name as the search criterion, enter the value <code>firstname</code> in the HTML name field, and run the bot, then the bot fails with an error message because a text box with the HTML name <code>firstname</code> does not exist. However, in the HTML name field, if you enter <code>firstname*</code>, and run the bot, then the bot captures the first text box that matches the criterion.</p> <p>Previously, if there were no objects whose properties matched the search criterion exactly, instead of failing, the bot captured the first object whose properties matched the search criterion partially. For instance, in the previous example, if you selected HTML name as the search criterion, entered the value <code>firstname</code> in the HTML name field, and ran the bot, then instead of failing, the bot captured the first text box that matched the criterion partially.</p> <p>Note: This enhancement is available for the bots you create using the 2.4.0-20211016-070100 version of the Recorder package starting from this release. To use this functionality in the bots created using a previous version of the package, you must recapture the objects.</p>

What's changed**Enhancement to File package** (Service Cloud case ID: 00755631, 00780237)

- In the **Copy Control Room file** action of the File package, the new **Dynamic file path** option in the **Control Room file** field now enables you to use variables in the file path to copy a file from the Control Room repository where the file path is dynamic.
- Some actions and properties in the File package are now updated, as follows:
 - The **Copy** action is now renamed **Copy Desktop file**.
 - The **Download CR file** action is now renamed **Copy Control Room file**.
 - In the **Copy Control Room file** action, the following fields are renamed:
 - The **Select a Control Room file** field is now renamed **Control Room file**.
 - The **Save CR file to location** field is now renamed **Target file path**.
 - In the **Copy Control Room file** action, the **Control Room file** field now has two new options: **Static file path** and **Dynamic file path**.

The **Static file path** option is an existing feature in the **Control Room file** field that enables you to browse the Control Room repository and select the file. When you browse the repository using **Static file path**, files with `.bot` extension are no longer displayed.

Note: The renaming of actions within the File package does not impact existing bots that use these actions.

*File package***Changes to Connect action in FTP / SFTP package** (Service Cloud Case ID: 00792346)

The following changes are made to the **Connect** action:

- **SSH FTP** server type is now renamed **Secure FTP**.
- When you select the server type **FTP Secure**, the **User credentials** authentication type is now renamed **Username & Password**.

Note: From this release, if you use the Secure FTP credentials in FTP Secure, the bot will fail. Instead, we recommend you to use the **Credential** option available in **Secure FTP** to connect with the Secure FTP server.

- Change in **Connect** action: If you created bots using the **Connect** action using Automation 360 v.22 and earlier releases and you update to v.23, the bots display some of the **Connect** action settings as deprecated due to changes in the interface. However, your existing bots will continue to run successfully. For new bots, we recommend that you create them using the **Connect** action available from this release.

Support for copying one or more variables (Service Cloud case ID: 00549368, 00751052, 01260498)

You can now copy one or more variables from one bot and then paste them in another bot. Previously, the copy operation also copied the actions along with the variables.

Support for reserved characters in Distinguished Names (DN) for Active Directory Control Room (Service Cloud case ID: 01133364, 00952301)

You can now use reserved characters, such as the comma (,), in the DN or the username of a Control Room configured for Active Directory users.

The following table lists the fixes and the builds in which they were fixed. Build 11513 is the latest build and includes fixes from the previous builds.

Fixes		
Build	Service Cloud case ID	Description
11513	00797196, 00818347	<p>Updates to the Private workspace API (/v2/repository/workspaces/{workspaceType}/files/list):</p> <ul style="list-style-type: none"> • Only private workspace authorized users can list the bots from the private workspace. • Admin cannot list the private workspace bots. • Only public workspace authorized users cannot list the private bots. • One private workspace authorized user cannot list another user private workspace files.
11513	00808478, 00814198, 01260666	<p>If you are a Control Room administrator, when you change the viewing permissions of some bot folders so that they can be viewed only by specific users, the change is now correctly applied. Previously, changes made to the viewing permissions of bot folders were not applied correctly.</p>
11513		<p>When you update from Automation 360 v.22 to v.23, background jobs related to cloud license server sync-ups are no longer deleted because of incorrect license job name.</p>
11513	01753484, 01754939	<p>You can now deploy (both schedule and run) bots from the Control Room without any issue if you have the View Package permission.</p> <hr/> <p>Note: The View Package permission is required to deploy (both schedule and run) bots from the Control Room.</p> <hr/>
11513	--	<p>When you install or update to Automation 360 v.23 for On-Premises deployments, the log files are now updated for all the services without any issue. Previously, the log files for a few additional services were not updated with any information or time stamp of the activities.</p>
11486	00793800	<p>When you migrate to this release, issues related to JRE while installing the Control Room on machines using Microsoft Hyper-V servers are now fixed. The following error no longer occurs: Unknown Failure. Please check the database login credentials and check if this machine has a network connection to the database server.</p>

Fixes		
Build	Service Cloud case ID	Description
11486	00815340	User folder names given similar leading portions or naming conventions no longer display folders that share naming conventions but not the assigned or specific user permissions.
11486	00836898, 01259938	The Cloud Migration Utility now includes enhanced logic to enable you to successfully upload data even when the network is connected through a proxy server.
11486	00817173	You can now perform a Run DLL function when both the input and output parameters are set to a String value, and the Date and Time value is now passed as a String parameter successfully. Previously, the Date and Time value was converted and not displayed as expected.
11486	00754305, 00769128	The configuration tagging works properly now, based on the settings configured in the nodemanager-logging.xml file. Previously, the node manager and bot launcher logs were purged either after two days or if the log count was increased by specific amounts due to tagging issues with tags such as the following: "IfLastModified age" and "DirectWriteRolloverStrategy"
11486		When you decide to select or deselect all the bots and dependencies, you can now select or clear the Select All check box without any issues. Previously, after selecting the Select All check box, when you cleared the check box, it did not work as expected, and you had to deselect the bots and dependencies individually.
11486	00798037, 00814184	The Manage and Administration labels in the navigation pane are now updated to ensure that roles and permissions are distinct in the following languages: Simplified Chinese, Traditional Chinese, Japanese, and Korean.
11486	01218053	You can now import parent and child bots with dependencies even if you do not have permissions to all folders. Previously, if a user with no folder permissions imported parent and child bots with dependencies, the dependency between them was lost.
11486	01046249	When you migrate from Enterprise 11 to Automation 360, duplicate entries are no longer created for any of the existing commands.

Fixes		
Build	Service Cloud case ID	Description
11486	--	<p>You can now migrate an Enterprise 11 bot that uses the Run Task command successfully even if the Upon error, continue with next repeat option is not selected.</p> <p>Previously, the parent bot stopped running if the child bot encountered an error. Now, when this option is not selected, an error handler ensures migration is successful even if the child bot encounters an error.</p>
11486	--	If you used the Go to cell action from the Excel advanced package in an Enterprise 11 bot, the setting is now retained when you migrate it to Automation 360.
11486	00779016	You can now use the XML package to open any <code>.xml</code> files without any issue after migrating to Automation 360.
11486	00794202	You can now migrate Enterprise 11 bots with If command to Automation 360 without any issues.
11486	00790245	You can now use the SOAP Web Service action of the SOAP Web Service package without any issues after migrating to Automation 360.
11486	00795518, 00832462	If you used the Delete cells action from the Excel advanced package in an Enterprise 11 bot, correct cell addresses are now displayed when you migrate it to Automation 360.
11486	00808601	Migrated bots that include Extract and Substring actions of the String Operation no longer encounter an error if the input string is empty.
11486	00807945, 01258127	When you migrate Enterprise 11 bots using the Error Handling command, an error no longer occurs if the file path value in the variable is missing the file extension from the Snapshot and the Log to file . After migration, the Snapshot file now saves files with <code>.png</code> extension and Log to file with <code>.txt</code> extension.
11486	00777395, 00807705, 00814087	The migration process now adds the Window > Set title action for all the ElseIf-window exists conditions. This setting enables you to make the window title dynamic, eliminating the need for you to recapture the window title when it changes.
11486	00820094, 01019195	After you migrate to Automation 360 from Enterprise 11 or Enterprise 10, the Error Handler snapshot error is now logged to the Snapshot image path. If the snapshot image path is provided as a variable, then the snapshot error is logged to the default application path.

Fixes		
Build	Service Cloud case ID	Description
11486	00810389	You can now migrate bots with variables whose names start with or contain <code>arrayRows</code> . You no longer encounter a stack overflow error and the bots are successfully migrated.
11486	00795347	The DLL Run action now successfully copies your data from one Excel sheet to another even if the .Net DLL uses the OLE mechanism (for example, clipboard) to copy data. Previously, when data was copied from one Excel sheet to another, a threading-related exception occurred.
11486	00787562	After migration to Automation 360, an Enterprise 11 large bot (with 2000 or more commands) no longer encounters the <code>Code too Large for try statement</code> preprocessing error when the bot is used in Automation 360. However, if the migrated bot includes a Loop or Trigger Loop command with Continue or Break as a child command, a preprocessing error might still occur when the bot is run.
11486	00782594, 00786968	When you migrate to Automation 360, an Enterprise 11 bot with large array sizes no longer encounters Java heap errors. If the total size of the arrays in one bot exceeds the threshold value of the array size, then the arrays variables are migrated as is till it breaches the threshold value. However, the remaining array variables are migrated as table variables with no default value using the Database > table action.
11486	00792346	If your Enterprise 11 bot was configured with Secure FTP without Key File Authentication , the migration process now appropriately configures the bot with the Secure FTP server type in Automation 360. Previously, the migration process incorrectly configured the bot with the FTP secure server type.
11486	--	Users with the AAE_Bot Migration Admin role no longer encounter an issue when they migrate bots using the Bot Migration Wizard.
11486	--	The Bot Migration Wizard now displays the correct number of MetaBots on the Select bots to migrate screen.
11486	--	Enterprise 11 bots that are migrated no longer encounter an error when a variable that is mapped between the parent bot and a child bot is not available in either of the bots.
11486	00729719, 00959356	You can now add or update SAP automation using the Capture action of the Recorder package when the SAP scripting is disabled in the Enterprise 11 bot.

Fixes		
Build	Service Cloud case ID	Description
11486	00639940, 00770561	If the migration process fails, the All migration screen now shows the status as <code>unsuccessful</code> . Previously, when the migration process failed because of invalid device credentials, the screen showed that the migration process is in progress but the Audit log displayed the correct status.
11486	00840456	The migration process no longer encounters an error when you migrate a MetaBot that contains a logic that has an extra space character at the end of its name.
11486	00786646, 00808600, 00822029	Migrated bot no longer encounter an error when they contain commands that perform an action on a pop-up window of a browser.
11486	00777467	Migrated bots no longer encounter an error when they are checked out in Automation 360 and they contain an invalid expression that is added by the migration process.
11486	00786002	You can now delete <code>.atmx</code> and <code>.mbot</code> files from the Control Room if you have all the required permissions.
11486	00796725	The Bot Scanner no longer encounters an error when it scans a bot in which the window title is specified using a variable within brackets.
11486	00790861, 00836849	Migrated Enterprise 11 or Enterprise 10 bots no longer encounter an error when they use the Run Logic command to run a MetaBot logic and the location of the logic is specified up to the folder that contains that logic. For example, consider that you have a MetaBot named <code>Finance1</code> and you want to run <code>Logic1</code> that is available in the MetaBot at the <code>Metabots\Logics\Finance</code> location. Previously if you specified only <code>Metabots\Logics\Finance</code> instead of the complete path (<code>Metabots\Logics\Finance\Logic1</code>) of the logic, an error occurred.
11486	00804550	You can now import bots from an Enterprise 11 production environment to an Automation 360 development environment even if these bots include the user ID of the user who had checked out the bot in Enterprise 11.
11486	--	When you search for bots with the following characters, the bots are now displayed in the search results: <code>r\$@1&#klu%)((){,!~`\$^&()_+=[]</code>
11486	00729393	After you migrate from Enterprise 11 to this release, you can now view the bot subfolders in your Control Room Public workspace on the Automation page.

Fixes		
Build	Service Cloud case ID	Description
11486	--	After you migrate from Enterprise 11 to this release, you can now check in bots to the Control Room Public workspace from a folder for which you have the Check in permission using the Repository Manager API. The API response code no longer shows the following: "upload": false.
11486	01032367, 01066099	An issue with the bot deployment progress window is now fixed. Previously, even after the bot completed the run, the window was displayed for a long time (for example, for more than 10 seconds in some cases).
11486	00826923, 01081380, 01259907	After you migrate from Enterprise 11 to this release, you can now add work items to queues using the Workload API through AWS Lambda. A StackOverflow error no longer occurs in the Control Room logs.
11486	00801810	<p>When you update Automation 360 On-Premises to this release, Bot Agent devices now remain in connected state. WebSocket errors are no longer generated in the C:\ProgramData\AutomationAnywhere\BotRunner\Logs\Node_manager.log file.</p> <p>Previously, when you updated from Automation 360 v.19 (Build 8147) to Automation 360 v.21 (Build 9664), some issues were reported where the Bot Agent devices remained in disconnected state and WebSocket errors were generated even without any proxy configuration changes.</p>
11486	00831028, 00830336, 00827031, 00832413, 00833089, 00833436, 00832850, 00839997, 00849904, 00857296, 00831062, 00833436, 01140913, 01145306, 01252819, 01127960, 01256324, 01257414, 01258281, 01263606	When you update your Control Room that is configured with Active Directory to this release, you can now use the log in with Windows option and the following error no longer occurs: <code>java.lang.NoSuchMethodError</code> .

Fixes		
Build	Service Cloud case ID	Description
11486	00719407	For On-Premises deployments, when you configure multiple IP addresses for Control Room nodes in a cluster, the primary IP address is now automatically configured. You no longer have to manually configure the primary IP addresses in the <code>cluster.properties</code> file.
11486		When you are installing the Bot Agent, if you run out of disk space and click OK on the Out of disk space window, the wizard returns you to the previous Setup type window so that you can cancel the Bot Agent installation. Previously, when you clicked OK on the Out of disk space window, the wizard displayed multiple windows.
11486	--	When the Bot Agent is updated automatically from a previous release to this release, you can perform various operations simultaneously, such as running bots, configuring device settings in the Control Room, and updating the Control Room. You no longer have to restart the Bot Agent service from the Task Manager.
11486	00781135	After you install the Bot Agent on a user device, when you restart the Bot Agent, the global cache folder (<code>C:\ProgramData\AutomationAnywhere\GlobalCache\</code>) is no longer deleted.
11486	00709309, 00766163	You can now upgrade the Control Room installed on Linux to this release and the Elasticsearch service now starts successfully. Previously, the upgrade failed because the service did not start and the following message was displayed: <code>Elasticsearch service fail to start during certificate retrieval process.</code>
11486	00742074	License allocation for users configured to use multi-user devices is now honored for concurrent bot deployments on unattended Bot Runners.
11486	00822176	On multi-user devices, you can now create an RDP session that uses a custom port. Previously, if you configured a multi-user device to use a custom port for RDP-based deployments, the deployments failed.
11486	00806583, 00805381	When you perform RDP-based deployments on a device, FreeRDP no longer fails when connecting to a Windows server for per-device RDS licensing.

Fixes		
Build	Service Cloud case ID	Description
11486	--	If you deploy bots using event triggers and install the Bot Agent on a device as a non-admin user for yourself or a local admin user, the Bot Agent is now updated automatically. The device is no longer shown as disconnected in the Control Room.
11486	00803434	Issues with the change in Jetty HTTP client behavior on load balancers with custom rule for host headers to route a request are now resolved. Device registration now does not fail and the port numbers are added to the host when default ports are used.
11486	00815334	Performance issues related to logging in to the Control Room and editing and running bots in the Cloud Control Room are now fixed.
11486	00543141, 00674098, 00714238, 00744991, 00750325	With Splunk integration and enhancements to syslog, you can now forward audit logs to remote Splunk servers and view audit logs on Splunk dashboards.
11486	00776569	When a bot you run encounters an error, an appropriate preprocessing or runtime error message is now shown. Previously, a preprocessing or runtime error message was shown even if the bot did not contain an error or if the bot was empty.
11486	00781638, 00805371, 00804784	Issues with a checked-out bot and its clone are now resolved. When one user checks out a bot, makes changes to it, and checks in the bot, the clone of the bot in another user's Private workspace is now updated with the changes.
11486	00784252	If you do not have Control Room admin privileges and you check in bots to the Cloud Control Room Public workspace in subfolders, the bot folders no longer take time to load in the Control Room.
11486	00786716, 00801631, 01189873	An error no longer occurs when you use the Download action in the Browser package to download a file from a web URL. Previously, if a web URL had a backslash at the end or space characters at the beginning or end, the bot failed to download the file.
11486	00783197, 00818698, 00820666	When you use the Assign action of the Number package to assign decimals to an existing number variable, an error no longer occurs irrespective of the device locale settings on the machine.
11486	00778496	You can now successfully import the bot archive into the public workspace even if the archive creates a folder named System in the Bots folder.

Fixes		
Build	Service Cloud case ID	Description
11486	00774026	You no longer encounter an issue when you use the CSV/TXT > Open action and the Task Bot > Run action to search for a file or a bot with a name that contains Japanese characters.
11486	00761035, 00786113	You can now use the Recorder > Capture action to capture an object on a window that has a tree view and also retrieve the Item name property of that object by using the Get property action. Previously, when you ran a bot, the recorder captured the object on the window successfully but failed to retrieve the item name of that object in the output.
11486	00763925	An error no longer occurs when you use the Split action of the String package to split a source string that has any combination of Unicode characters.
11486	00767074	In Internet Explorer, when you use the Browser > Open action to open a new window or tab, the new window or tab is now displayed in front of the other, non-admin open windows.
11486	00819664	You can now create bots using the SOAP Web Service action. XML calls no longer return corrupted data when the SOAP response has an XML document as an inner element.
11486	00748494, 00829735, 01018622	You no longer encounter any issues when you deploy a bot containing email triggers. Now, each time an email message is sent, the bot is triggered and runs successfully. Previously, the email trigger worked only for the first time an email message was sent, and for subsequent email messages, the bot was not triggered and did not run.
11486	--	The Task bots runs metric on the Home dashboard page of the Control Room now displays the correct count. Previously, the Task bots runs metric displayed the count as zero even if you have run bots from the same Control Room.
11486	00824309	In the Run stored procedure action of the Database package, when you click Add parameter to provide an input or output parameter, the label for the parameter type field now displays as Parameter type . Previously, the label for the parameter type field was not displayed correctly.
11486	00810212	When you use the Run action of the Task Bot package and select the Multiple variables option in the Save outcome to a variable field, the variable name is now displayed in the correct case. Previously, the variable name was displayed in lowercase even if the variable name was created using uppercase.

Fixes		
Build	Service Cloud case ID	Description
11486	00796913, 00836389	You can now use the Move all action from the Email package to move multiple email messages from Inbox to another folder. Previously, the Move all action was not able to process a large number of email messages because disk storage ran out of space.
11486	00798673, 00815700	An error no longer occurs when you use the Database Connect action, enter the connection string that uses Windows authentication, and run the Run stored procedure action that has an input parameter value of more than 36 characters. Previously, an error was displayed when the length of the input parameter value exceeded 36 characters.
11486	00799450	When an excel spreadsheet is opened in the SAP editor and simultaneously you use Open action of the Excel advanced package to open an excel file, any error no longer occurs when the bot is run and the Excel file is opened successfully. Previously, an Excel file opened in the SAP editor was considered the default window and therefore when you ran the bot, an error was displayed stating that the Excel file could not be opened.
11486	00794102	In the REST Web Service package, the description below the Assign the output to a variable field is now translated correctly for the following languages. <ul style="list-style-type: none"> • Japanese • French • Italian • Portuguese (Brazil) • Simplified Chinese <p>Previously, the description was not correctly translated for these languages.</p>
11486	00788920, 00796452	In the Email package, when you use Connect action to connect to the Outlook or IMAP server, you can now successfully download the email attachment in .eml file format. Previously, if you had email attachments in .xlsx and .eml file formats, only .xlsx files were downloaded.
11486	--	If you create a <i>Dictionary</i> variable with the <i>Any</i> subtype and select Datetime as the default value, when you click the time icon, you can now see the time values displayed in the drop-down list. Previously, when you clicked the time icon to select the time from the drop-down list, the values were not displayed.

Fixes		
Build	Service Cloud case ID	Description
11486	00746630	You can now create a new task using Excel advanced with Loop and you select the For each row in worksheet (Office 365 Excel) option from the Iterator list, create a <i>Record</i> type variable, and run the bot. An error no longer occurs when you edit the same bot and select the For each row in worksheet (Excel basic or Excel advanced) option from the Iterator list. Previously, a preprocessing error was displayed on bot execution.
11486	00762978	If you use the Windows > Close action and select Currently active as the window title to close active windows, when you run the bot, the Shut Down Windows pop-up is no longer activated even if there are no active windows on the machine.
11486	00805654	The Split action of the String package now allows you to select the Any variable type to hold the output values. Previously, you could select only the list variable.
11486	00761189, 00764563, 00785751, 00794273, 00835194	Performance issues related to the Run macro action in the Excel advanced package are now fixed.
11486	00796120	When you use the Data table > Sort action to sort a column, if the column does not contain any value, the bot now runs as expected and does not get stuck. Previously, you had to stop the bot manually.
11486	00830011	In the Excel advanced package, when you perform the Go to next empty cell action on an Excel sheet, the system no longer runs out of memory.
11486	00765210, 00790641	An error no longer occurs when you use the Excel advanced > Open action to open an Excel file that contains a pivot table.
11486	00776021	When you use the Open action of the Excel advanced package to open an Excel workbook, even if the workbook has invalid links, the bots now run as expected.
11486	00692220, 00785965, 00798035	Performance issues related to the Write from data table action of the Excel advanced package are now fixed, and the action now performs better on Excel sheets with large amounts of data.

Fixes		
Build	Service Cloud case ID	Description
11486	00808137	<p>The format of Start date and End date under the Date condition is now updated to MM/dd/YY for the following actions of the File and Folder packages, where dd now correctly shows the date:</p> <ul style="list-style-type: none"> • File package <ul style="list-style-type: none"> • Copy Desktop files action • Delete action • Print action • Print multiple files action • Rename action • Folder package <ul style="list-style-type: none"> • Copy action • Delete action • Rename action <p>Previously, the format of Start date and End date was MM/DD/YY, where DD gave the day count of the year instead of date.</p>
11486	--	<p>When you run a bot with the following sequence of actions, the file is now successfully deleted at the end of the sequence:</p> <ol style="list-style-type: none"> 1. CSV/TXT > Open action to open a <code>.csv</code> file 2. A loop action within another loop action to retrieve values from the <code>.csv</code> file 3. CSV/TXT > Close action to close the file <p>Here, all the actions are using the same, default session.</p> <ol style="list-style-type: none"> 4. File > Delete action to delete the file <p>Previously, the file was not deleted because the bot failed to close the default session.</p>
11486	01164436, 01209626, 00975390, 01080879, 01254846, 01256132, 01255004, 01263774,01253240	<p>An error no longer occurs when you use the 2.4.0-20211118-080716 version of the Recorder package to capture a control using HTML technology in the Google Chrome or Microsoft Edge Chromium browser and run the bot. Previously, when you used the 2.3.0-20210806-215200 version of the Recorder package, the bot failed with the following error message:Unable to find control. Search Criteria did not match</p>

Fixes		
Build	Service Cloud case ID	Description
11486	00818990	The capture anchor option in the Recorder package is now supported for the Citrix XenApp application. You can now select an anchor to search for an object in a user interface during bot run and execute actions based on it.
11486	00782962	An error no longer occurs when you loop through multiple Excel sheets and use keystrokes inside the loop to copy and paste the retrieved values into another Excel sheet. Previously, when you opened and closed multiple Excel sheets within a loop, the bot did not identify the correct Excel sheet for performing the keystroke action.
11486	--	You can now use the String > Import string from text file action to read values from a text file when a bot runs if the text file encoding was set to any of the following encodings: <ul style="list-style-type: none"> • UTF-16BE • UTF-8 • ANSI • Window-1251 • UTF-16LE • Shift-JIS
11486	--	When you update the Control Room on Linux from any earlier version to Automation 360 v.21, the Control Room now displays the updated interface. Previously, when you updated to Automation 360 v.21, the Control Room continued to display the old interface from the previous version.
11486	00816941	You can now run bots with a queue based on the sorting order that was selected for the work item column in the work item template. Previously, the bots were deployed based on the sequence in which work items were inserted into the queue.
11486	00804330, 00822092	After a bot is deployed on a user device, the Run History page (Manage > Scheduled) now shows the correct details about the run history of the bot.
11486	--	When you pause and resume a workload automation after using the run bot with queue in the Control Room, the audit entries are now captured on the Audit logs page.
11486	00803717	In the Control Room Historical activity page, the Modified by column now shows the name of the user (Bot Creator or Bot Runner) who scheduled a bot on a user device. Previously, the column displayed the username of the latest bot user.

Fixes		
Build	Service Cloud case ID	Description
11486	--	When you deploy workload bots from the Control Room, you can now run workload automation with elevated privileges by using the Run as administrator option.
11486	00780635, 00791587, 00795559, 00795632, 00797130, 00797113, 00791783, 00765770, 00826805, 01859661	When you update from a previous release, schedules no longer disappear from a Control Room configured on a single-node or multi-node environment. Also, previously deactivated schedules no longer disappear and become reactivated automatically after the update.
11486	00974353	You can now deploy workload bots on Bot Runner devices because the bots associated with a queue cannot be deleted. Previously, user had permission to delete the workload bots while running with queue.
11486	00830546, 01181402	When work items are inserted for workload automations, an Apache Ignite StackOverflow error no longer occurs, and the Control Room server no longer stops running.
11486	01021889	When you schedule or deploy a bot from the Control Room, if a bot fails to run, an email notification is now sent. Previously, even if the Control Room administrator enabled the A Task Bot stops running because it is unsuccessful setting in the Control Room, an email notification was not sent.
11486	00949288	Scheduled bots are no longer stuck in the pending execution status intermittently on the Activity page, and subsequent bots scheduled for execution are not stuck in queue.
11486	01253045, 01256337	Each scheduled bot is now deployed on Bot Runner device one time in a day. Previously, some scheduled bots were deployed twice on Bot Runner device.
11486	00750399	You can now capture objects from Microsoft Internet Explorer running as XenApp on a Citrix Server that has multiple Citrix applications installed.

The following table lists the limitations identified in the current release:

Limitations in this release
<p>In Enterprise 11, if bots were using windows variable where the window title value did not use the exact case as that of the application window title, after migration, the bots will fail to execute.</p> <p>Workaround: You can migrate to Automation 360 v.26 release where this issue is fixed or ensure that you change the case of the window titles in windows variables to match the case of the window titles and then migrate the bots.</p>

Limitations in this release
<p>When you migrate a bot that was using the Manage Window Controls action, the last digit of the height value is not available after migration. However, the bot will execute successfully. (Service Cloud Case ID: 01756996)</p>
<p>When an Excel session is active in SAP, a corresponding Excel process starts in the background. In such a scenario, Automation 360 uses the same Excel process that SAP started. When you run a bot to automate spreadsheet data, Automation 360 processes the first request successfully. However, during execution, if the Excel is closed and a subsequent request is sent for automating the spreadsheet data, Automation 360 does not process the request because the Excel process is still being accessed by SAP. Therefore, the correct window is not activated for automating the spreadsheet data. (Service Cloud Case ID: 00815159)</p>
<p>When you run the bot, the Task bots run metric on the Home dashboard page of the Control Room does not display the correct count. For example, the task bot run count shows 39 on the Home dashboard page, but when you run the bot, the count is displayed as 42 instead of 40.</p>
<p>(Service Cloud case ID: 01753337) In the "In progress" table, the column sort function cannot be used to list items in ascending or descending order.</p>
<p>After migration, when you run a parent-child bot that share a session and use different DLL package versions, the bot fails with a run-time error message.</p>
<ul style="list-style-type: none"> • Nested IFrames are not supported in Google Chrome and Microsoft Edge Chromium browsers. • After performing an action in an application or page, if a frame is added during run time to the application or page, and the frame is populated and page is not refreshed or reloaded, elements in the application frame or page cannot be captured or played until you manually refresh that page.
<p>(Service Cloud case ID: 00988580, 01200161) After you migrate from Enterprise 11 to Automation 360, you might not be able to Check out some bots and dependencies to the Control Room Public workspace.</p> <p>Workaround: Check out the parent bots to the Control Room Public workspace. The dependencies are then automatically cloned.</p> <p>For more information, see Cannot Check Out With Child Dependencies Due To No Versions (A-People login required).</p>
<p>If you are directly updating from Automation 360 On-Premises v.20 or v.21 to this release, you might face issues updating your Bot Agent on some Bot Runner machines in the following scenarios:</p> <ul style="list-style-type: none"> • After a Control Room update, the device status keeps changing and the Bot Agent fails to update automatically. • If the <code>embedded_resources</code> file is missing, the Recorder does not recognize the user interface elements or does not capture a single object in the Google Chrome browser. <p>Workaround: Before updating to this release, remove the following Bot Agent files and folders:</p> <ul style="list-style-type: none"> • C:\Windows\System32\config\systemprofile\AppData\Local\AutomationAnywhere\AA-DB.mv.db • C:\ProgramData\AutomationAnywhere\GlobalCache\embedded-resources <p>For more information, see Bot agent auto update fails post the Control Room Upgrade with 'device.connection.lost' (A-People login required) The recorder is not able to recognize the GUI elements in Google Chrome browser (A-People login required)</p>

Limitations in this release
<p>In some cases, if you Check in a bot to the Control Room Public workspace after filtering any dependency, when you export the bot, all the dependencies are displayed instead of the filtered data.</p>
<p>(Service Cloud case ID: 00773700) The migration process fails to migrate bots that contain more than 96 conditions in a single If command.</p> <p>Workaround: Split the If command into two If commands in Enterprise 11 and then migrate the updated bot.</p>
<p>If you create a bot that has invalid JSON tags with an Error Handling action (Try/Catch) in it, and if the Bot validation service is enabled (ON) in the Settings > Bots page, when you run the bot, the bot fails because of a preprocessing error.</p> <p>Workaround: In the Bot editor, open the bot that displays the error. Select and click any line of code, edit it, and save it. For example, if you have created a bot using the Comment action, select and click the Comment action, edit it by entering a space in the comment box, and then click Save. When you run the bot now, it no longer displays a preprocessing error.</p>
<p>In SOAP Web Service, selecting the Raw data parameter and using the Build Xpath option to extract values from SOAP response to store the XML output in a variable does not work.</p> <p>Workaround: Enter the Xpath expression manually instead of using the Build Xpath option in the selected response.</p>
<p>When you try to establish a secure SQL connection in the Linux environment by choosing the Enable option in the Database Configuration > Secure Connection field, the Linux installer fails to import the SSL certificate, and the connection fails.</p> <p>Workaround: Select the Disable option in the Database Configuration > Secure Connection field. The Linux installer successfully establishes a secure SQL database connection.</p>
<p>In Linux environment, the file upload functionality of AARI on the web fails with an access denied error. This error occurs because the <code>filestorage</code> directory is not automatically created to store the files.</p> <p>Workaround: Create the filestorage directory in the Automation 360 repository path and assign the appropriate permissions as outlined in the following steps:</p> <ol style="list-style-type: none"> 1. Navigate to the Automation 360 repository path: <code>/opt/automationanywhere/automation360/appdata/Server Files</code> 2. Enter the following commands in the Linux console: <ol style="list-style-type: none"> a. <code>sudo mkdir storageservice</code> b. <code>sudo chown -R crkernel:controlroom storageservice</code> c. <code>sudo chmod -R 775 storageservice</code>
<p>When you upgrade the Control Room from the previous version, the Task bots runs metric on the Home dashboard page does not display the historical count of tasks bot that ran in the earlier version. It shows only the count of task bot runs from the upgraded Control Room.</p>

Limitations in this release
<p>When you use the Recorder to capture objects on applications running on Microsoft Edge Chromium with Internet Explorer mode, use Recorder conditions in the bot to check whether the element exists in the application, try to capture UI elements in the application based on the result of the condition, and run the bot, then the bot always goes to the next action because the Recorder condition is unable to locate the UI element in the application.</p> <p>Workaround: Use the Image Recognition condition instead to locate a UI element in an application.</p>
<p>Copying Form variables across bots by using the Copy to shared clipboard option is not supported.</p>

The following table lists limitations from previous releases that are also applicable to this release:

Limitations from previous releases
<p>If you configure an external key vault in External Key Vault Integration and select the SQL authentication mode for database authentication in the Windows installer Database Server page to install Control Room (On-Premises), the installation fails, and following error message is shown: <code>Control Room database tables fail to create.</code></p> <p>Workaround: Add the database credentials in the external key vault and use those credentials for database configuration.</p>
<p>Newly created Control Room users on Windows for On-Premises Google Cloud Platform VMs cannot change their password. The security questions option is not available on the Change password screen and as a result the Control Room displays an error when they try to save the password.</p> <p>Workaround: Refresh the page and change the password again.</p>
<p>(Service Cloud case ID: 00837271) If you are migrating from Enterprise 11 with a database that has a large amount of repository data, the installation might fail. This issue occurs because Liquibase update for a few SQL queries is not completed during migration.</p> <p>Workaround: Contact Automation Anywhere Support.</p>

Security fixes	
Service Cloud case ID	Description
00836486, 00942844, 01264029	Disabled the module for caching that was using credential authentication.

AARI (Automation Anywhere Robotic Interface)

What's new
<p>New query filter in Query Requests and Query Tasks actions</p> <p>Use the new filter now available in the Query Requests and Query Tasks actions of the AARI Web package to filter query requests and tasks by team name in the AARI web interface.</p>

What's new
<p>Team name filter</p> <p>You can filter your tasks and requests by team name in the Task and Request pages in the web interface, respectively. Select the Team label from the filter and search by team name to view the teams assigned to a task or request.</p> <p>Filter and search for a request Filter and search for a task</p>
<p>Support for audit logs (Service Cloud case ID: 00801166)</p> <p>You can now view the audit logs and refer to events relating to requests, teams, scheduler, process setups, bot setups, human tasks, and bot tasks that you have created, deleted, updated, submitted, or recovered.</p> <p>Audit log</p>
<p>Enhancement to user task assignment in Human Task</p> <p>In the process editor, the Auto-assign this task option in Human Task provides the following alternatives:</p> <ul style="list-style-type: none"> • The user who created the request: The task is automatically assigned to the user creating the request in the web interface. • The user who opens this task: The task is automatically assigned to the user who opens the task in the web interface. <p>This feature helps to reduce conflicts in assigning a task to oneself, particularly in case of specialized users such as Validator for whom the action of opening a task is equivalent to assigning the task to oneself.</p>
<p>Enhancement to team setup</p> <p>You can now simultaneously add multiple users with similar roles (custom role) to the AARI team in the web interface. The custom role in the Control Room is now aligned with a team in the AARI web interface, and the enhanced team setup works as follows:</p> <ul style="list-style-type: none"> • The users added with the role are assigned a Member role in the team. The role cannot be changed to Owner or Admin. • You cannot view these users in the Users tab of the Team page. • If a user is both part of a role and added manually to the team, their role in the team will be the same as the role assigned to them manually. For example, if a user is a member, they will continue to have the Member role whereas if the user is an owner, they will be assigned the Owner role in the team. • If the user is no longer part of a role, the user will also not be a part of the team. <p>Also, the Team page is now enhanced with navigation options at the top so that you can navigate through the various tabs (General, Users, Roles, Processes, and Bots). Use the General, Users, and Roles tabs to create teams and add users to them. The Processes and Bots tabs display the processes and bots assigned to teams, respectively.</p> <p>Team management Create an AARI team and assign team roles to members</p>

What's new**Bot setup support**

The AARI Admin can use the **Bot Setup** page to view the bots that are assigned to a team, assign teams to a bot, and edit bots to remove or reassign teams. Attended Bot Runners who can view all the bots that are checked in to the **Public** workspace can now view the bots that are assigned to teams in AARI Assistant.

[Bot setup](#)

Enhancement to the form logo

You can now use the **Logos in footer** field to select up to two separate logos that are displayed in the footer of the form during bot runtime.

Add rules to various form elements

When you are creating or editing a form in the form builder, you can now add rules to the following form elements by using the **Form rules** tab:

- **Checkbox**
- **Date**
- **Document**
- **Dropdown**
- **Label**
- **Number**
- **Password**
- **Radio Button**
- **Rich Text Editor**
- **Text Area**
- **Text Box**
- **Time**

For the **Checkbox** and **Radio Button** elements, the rules are triggered only if the corresponding presets are selected. For example, if a form has two mutually exclusive options, such as **Yes** and **No**, the rules associated with these options are triggered only when you select one of the two options.

[Add rules to form elements](#)

What's new
<p>Updates to triggers</p> <p>The following triggers are now available to run a bot:</p> <ul style="list-style-type: none"> • Process trigger: Starts a bot when the status of the specified process in Microsoft Windows meets one of the following preset conditions: <ul style="list-style-type: none"> • Starts • Stops <p><i>Add a process trigger</i></p> • Service trigger: Starts a bot when the status of the specified service in Microsoft Windows meets one of the following preset conditions: <ul style="list-style-type: none"> • Starts • Stops • Resumes • Pauses • Is running • Has stopped • Is paused <p><i>Add a service trigger</i></p> • Window trigger: Starts a bot when the specified application window meets one of the following preset conditions: <ul style="list-style-type: none"> • Opens • Closes <p><i>Add a window trigger</i></p>

What's changed
<p>Enhancement to Create a Request package</p> <p>In the Create a Request package, you can now browse and choose the public process for which you want to create a request. With this enhancement, you can choose the public process without having to contact the AARI admin for the URI of the public process and enter the URI manually. This feature also simplifies mapping process inputs for initial form fields.</p> <p><i>AARI Web package</i></p>

Fixes	
Service Cloud case ID	Description
00800192	You can now use an email trigger to start a bot without any issues, even when the email server is POP3.
00801428	You can now add an email trigger to a Gmail account to start a bot for new email messages.
00736309, 00765069, 00784362	For documents that are in the .csv, .xlsx, or .xls format, you can now use a file trigger to start a bot when a document is modified.

Fixes	
Service Cloud case ID	Description
00796697	When you check in a bot, the associated private event trigger is now retained.
00802427	With the Bot Creator license, you can now view all the requests and tasks regardless of your role or other licenses assigned to you.
00829282	When you create a request in the web interface, your bot now runs properly and does not encounter any processing issues, such as an idle status that prevents progress on your bot.
--	When more than four text box elements of a form are populated in a process, the document is now displayed correctly on the document viewer irrespective of the state of the text box elements. Previously, the document was not displayed.
--	When you delete a request from the Request tab and it is sent to the recycle bin, the related task from the Task tab is now removed.
--	When you use the Date and Boolean type If/Else conditions, there is now parity in validating conditions between a bot and a process. Also, the String type If/Else condition now allows the target values to be empty. Previously, validation for Date and Boolean type conditions were not supported when used in a process and the target values could not be empty.
--	Issues with the Hyperlink element in the Human Task are now fixed. The Hyperlink element now works correctly with the following behaviors: <ul style="list-style-type: none"> • If the hyperlink URL is empty, either at design time or when passed from the process, the hyperlink is now unavailable. Previously, the hyperlink was set to the Control Room domain. • If the Hyperlink element is used in a Human Task that is read-only, data is now passed from the process editor to the form. Previously, the data from the process editor was ignored.
--	For Time element in forms, when the Use the local time when form is first displayed and Make field required options are selected, the time element now treats the system time as the default value and can be modified in the initial form.

The following table lists the limitations identified in the current release:

Limitations in this release
The web interface lacks the Set Warning action and the Set Error action for the Checkbox , Dropdown , Radio Button , and Rich Text Editor elements.
For the Date and Time elements, when the date and time are included in a rule, changes made to the rule format are not reflected in the rules section. As a result, when you try to process a rule that contains that date and time, bot execution fails. Workaround: Open the rules editor, expand the corresponding rules, and select a respective data value from the calendar before saving. Do not change the format after the date and time element are included as part of any rule. You can also delete older date and time elements.

Limitations in this release
When you use the Select File element in your forms and select the Make field uneditable option, the element can still be edited.
When you run a bot using the Team Members command from the AARI Web package, you will be prompted with an exception error.
In AARI on the web interface, if you create a variable by using the Form type in a bot, you cannot copy that variable to another bot even when you select the Keep or Overwrite option.
When a user is a member of a team by role (the user was added to a role in the Control Room then the role was synced to the team), the user will not be able to view updated information on the user interface of the request or task details. This is due to the Request page not automatically refreshing. Workaround: Refresh the Request page to view the updated request or task details.

The following table lists limitations from previous releases that are also applicable to this release:

Limitations from previous releases
In an SDS setup, when you create a request to upload a file, the upload fails and a <code>SecurityTokenInvalidException</code> error message is displayed.

Discovery Bot

What's new
<p>Install Bot Agent seamlessly</p> <p>If you have not already installed the Bot Agent, you are now prompted to install the Bot Agent from the Processes tab. Follow the screen instructions to install the Bot Agent. After the installation, you are prompted to enable a Chrome plug-in in order to proceed with your recording tasks.</p> <p><i>Prerequisites for Discovery Bot</i></p>
<p>Enhancement to auto-generated opportunities</p> <p>You can now begin reviewing an auto-generated opportunity from the Opportunities tab when at least one process recording is submitted for review. Review the auto-generated opportunity and choose to create a custom opportunity from an auto-generated opportunity, as required.</p> <p><i>Review opportunities, convert to bot, and generate PDD</i></p>
<p>New recordings for review for custom opportunity</p> <p>You can now review new recordings submitted by a Discovery Bot user for a custom opportunity. You can choose to accept or dismiss the recording updates as part of the custom opportunity work flow. This option allows you to quickly and easily review new recordings in real time as the recordings are submitted by the user for that process.</p> <p><i>Review opportunities, convert to bot, and generate PDD</i></p>

What's new
<p>Enhancements to Opportunities page</p> <p>The opportunities page is now updated to include an opportunities evolution map, along with other graphs, to help you review and analyze data for a potential opportunity for automation. Use the opportunities evolution map to help guide you on which opportunities to automate first.</p> <p>Analyzing opportunities for automation</p>
<p>Download PDD document from the Recordings page</p> <p>You can now download and export a PDD document from the Recordings page. After you submit a recording for an analyst to review, the PDD begins processing in the background automatically. When the PDD is generated, the field changes from Processing PDD to Download. You can now choose to download the document in Word format, PDF, or both. An email notification to the business user is also sent to the email address on file. The Download PDD for Word or PDF document is also available for a custom opportunity from the Opportunities list table.</p> <p>Review opportunities, convert to bot, and generate PDD</p>

Fixes	
Service Cloud case ID	Description
--	You will now receive one email notification for a PDD generated in Automation 360 v.21. Previously, when you upgraded to Automation 360 v.22, you might have received multiple email notifications about the PDD generated in Automation 360 v.21.

The following table lists the limitations identified in the current release:

Limitations in this release
<p>During upgrade the PDD documents are not getting generated intermittently, for both recordings and opportunities.</p> <p>Workaround: Edit the flowchart for the custom opportunity that displayed an error, and save. Or alternatively, create a new opportunity from the existing opportunity.</p>
<p>Depending on the memory available in your system, the PDD (in PDF or Microsoft Word format) can support up to 250 recorded steps captured in the document. If a process is recorded with more than 250 steps, the PDD generation periodically stops functioning.</p> <p>Workaround: Regenerate the PDD and click Download.</p>
<p>The PDD PDF document for business users and analysts does not display Unicode characters when entered in the opportunity name and step description fields.</p>
<p>Cloud users: For an auto-generated or custom opportunity, an error is displayed from the Recordings table intermittently.</p> <p>Workaround: Refresh the page to update the Recordings table.</p>

Limitations in this release
<p>After you save your changes, if you update a process workflow by adding or removing steps, the values from the Overview pane might not be updated to include the recent changes.</p> <p>Workaround: Refresh the page to update and include the recent changes made to the opportunity values in the Overview pane.</p>
<p>Cloud users: Creating a custom opportunity with more than 250 steps is not supported.</p>
<p>Linux users: The recording flowchart section is not displayed in the PDD.</p>
<p>For On-Premises deployments, when a self-signed or wildcard certificate is used for the Control Room setup, the Processes page fails to load.</p> <p>Workaround: Update or add the Control Room certificate to the Java Credential Store on all your Bot Runner machines for the Processes page to load.</p> <p>Add Control Room certificate to Windows certificate stores</p>
<p>For custom opportunities and recordings, there is an intermittent issue and error generating PDD message. You will not be able to access and download a PDD and instead see an <code>error generating PDD</code> error message.</p> <p>Workaround: Only for custom opportunities, you can either create a new opportunity in your workflow using the Save As option OR edit the your workflow chart with any small change and save it. After doing this, the PDD generation will work properly.</p>

IQ Bot

What's new
<p>Document Automation released in Community Edition</p> <p>Community Edition now offers limited features from the Document Automation version. This version is integrated with the Community Control Room. When you create a learning instance, IQ Bot automatically creates RPA bots to extract and download the data and an AARI process to manage the end-to-end process. Validation now takes place in AARI tasks.</p> <p>Use IQ Bot Community Edition to extract data from invoices in English.</p> <p>Community Edition</p>
<p>IQ Bot standard forms enhancements</p> <p>IQ Bot now provides the following enhancements related to standard forms:</p> <ul style="list-style-type: none"> You can now extract data from tables. You can now use container deployment. <p>Using IQ Bot for standard forms</p>

What's new
<p>CyberArk support</p> <p>The On-Premises installation process now enables users to connect to CyberArk to store their custom keys for encrypting and decrypting IQ Bot data.</p> <hr/> <p>Note: This feature is only available for new installations.</p> <hr/> <p>Installing IQ Bot in Custom mode</p>
<p>Classifier enhancements</p> <p>You can now create custom document groups in a learning instance. This reduces the possibility of an OCR failing to detect fields in a document, which will cause the Classifier to create a document group unnecessarily or send the document to a wrong group.</p> <p>About the Classifier</p>
<p>View the number of pages purchased and uploaded</p> <p>The IQ Bot dashboard now shows the number of pages purchased and uploaded in the current license period.</p> <p>Review the dashboard</p>

What's changed
(Service Cloud case ID: 00656822) Credential Vault integration is now available for passwords in IQ Bot.

Fixes	
Service Cloud case ID	Description
00727633	When you import or export learning instances, duplicate classification entries no longer occur.
00768600, 00783773, 00815546, 00795424 , 00788180	When you import an existing IQ Bot archive (IQBA) file, you can now use the Overwrite option without any issues.
00770638, 00746545, 00827208, 00746545, 00827208	When you import the IQ Bot archive (IQBA) file, you will no longer see duplicate group entries.
00773631	(On-Premises) After you install, restart the IQ Bot services using a different Windows user. Prior to this release, IQ Bot services could not be run with a different account post-installation, resulting in an incompatible FilePath for Liquibase changesets.
--	You can now access IQ Bot > Explore IQ Bot with a refined user experience. Previously, a user could not navigate back to the Control Room landing page. Users can now access the landing page by clicking the back button.
00766454	The Manage your IQ Bots no longer displays the incorrect UI for trained bots currently in production. Previously, it displayed a link to create a bot.

Fixes	
Service Cloud case ID	Description
00804476	When you update the classification report, you can now successfully classify the documents in IQ Bot. Previously, because the classification report field name was longer than 75 characters, document classification failed.
--	On the Learning Instance summary page, the number of unclassified documents and the number of documents uploaded are now accurately displayed.
00695159	An internal exception in the RemoveLines module that caused documents to remain unprocessed has now been fixed, and documents no longer remain unprocessed due to this error.
00806557	You can now successfully assign a group to a bot, and move the bot to production. Previously, in a few instances, the IQBA contained multiple bots for the same group, making the state of the bot inconsistent.
-	You can now download output files without any issues even if API requests are sent frequently to the database during download for any standard forms learning instance.
-	You can now use the IQ Bot Extraction action without any issues even if you selected the Only for me option when you installed the Bot Agent.
--	For bots associated with standard forms learning instances, you can now successfully upload a large number of documents.
00776423, 00829915, 00949561	You can now use a custom port (apart from port 1433) to run the Migration Assistant tool on the database server.
--	When documents with lengthy non-English (for example, Japanese) file names fail, the issue is now logged in the bot_launcher.log file.
00814577, 00812300, 00823120	An unexpected error that occurred due to large unnamed RabbitMQ message queues has been fixed and the user can now navigate to the Learning instances page.
--	The MLScheduler service is now disabled on IQ Bot Cloud, and the system no longer slows down or stops responding. Previously, the auto-correction and auto-suggestion features, which are part of the MLScheduler service, used extensive system resources and caused the system to slow down or stop responding.
--	The Process Document action in IQ Bot Extraction package now fetches the ABBYY pre-processing settings from the IQ Bot server and applies these settings to the classic side of processing during bot runtime.

The following table lists the limitations identified in the current release:

Limitations in this release
<p>When a bot is moved to production, documents become unavailable in the validator output folder or the following error is displayed: <code>Project not found/No documents found</code>.</p> <p>Workaround: Ensure that the length of the filename does not exceed 100 characters.</p>
<p>In a cluster setup, sometimes, a specific document in production becomes unavailable. Also, an incorrect learning instance summary is displayed.</p> <p>Workaround: Upload again and reprocess documents that are not successfully processed.</p>
<p>In the Designer, some documents for the user-created group and their extraction results do not load.</p> <p>Workaround:</p> <ol style="list-style-type: none"> 1. Reload the Designer. 2. To obtain extraction details on On-Premises, go to the <code>Settings.txt</code> file and increase the value for See extraction timeout.
<p>On the learning instance details page, because of the 150-character limit, the group labels for user-created groups are not displayed completely.</p>
<p>When you create an IQ Bot administrator user, if you do not include the AAE_Basic role along with the AAE_IQ Bot Admin role, that administrator user cannot add a new group to a learning instance.</p> <p>Workaround: Ensure that you include the AAE_Basic role along with AAE_IQ Bot Admin role in the Control Room.</p>
<p>For a standard forms learning instance, if you upload a document that contains a table with an invalid field, that document is sent to the Failed folder.</p>
<p>For the Concatenate Images action in the IQ Bot Pre-processor package, no output is generated if a filename contains more than 256 characters.</p> <p>Workaround: Use English language characters and number convention.</p>
<p>When you use the IQ Bot Extraction package along with other OCR-based commands (such as IQ Bot Pre-processor, IQ Bot Classifier, AISense Recorder, and OCR) in a single bot, the bot fails.</p> <p>Workaround: Ensure that you create separate bots for IQ Bot Extraction, and do not run IQ Bot Extraction in conjunction with other packages that include the 12.2 Abbyy OCR.</p>
<p>From a learning instance of custom domain type with manual groups, when you export the IQBA file to another instance, the manual Group Label is not exported. Without a manual group label, it is difficult to differentiate between system-generated groups and manual groups in new learning instances.</p>

The following table lists limitations from previous releases that are also applicable to this release:

Limitations from the previous releases
<p>If you have a document with a large number of pages (> 100), an error message is displayed intermittently when you click See extraction results for an existing learning instance.</p>

Bot Insight

What's changed
To change the language in Bot Insight, you must apply the language settings from either your browser or operating system that is configured to the language of your choice. <i>Internationalization, localization, and language support</i>

Fixes	
Service Cloud case ID	Description
00799262, 00826862	An error no longer occurs when you run a bot that includes special characters in the name and the analyze command. Previously, bots with an ampersand (&) in the name and the analyze command included encountered an error.
	The calculation in the device dashboard is now corrected to show an accurate maximum of 100 percent for daily utilization. Previously, a calculation error caused the device dashboard to display over 100 percent.

The following table lists the limitations identified in the current release:

Limitations in this release
Bot Insight is not compatible with Microsoft Internet Explorer 11. For a list of alternative browsers, see <i>Browser requirements for RPA Workspace</i> .

Important: For information about the packages supported with this release, see *[View package versions available in the Control Room](#)*.

Automation 360 v.22 Release Notes

Release date: 21 September 2021

Review what's new and changed, and the fixes and limitations in the Automation 360 v.22 release. Build 10535 is for Cloud and Build 10526 is for On-Premises. For Automation 360 IQ Bot, Cloud is on Build 10535 and On-Premises is on Build 10520.

Important: We have updated the Automation 360 Cloud build to include additional fixes for the Apache Log4j2 component vulnerability. The build includes the new Log4j2 library version 2.16.0.

- **Migration**

[11.x and 10.x](#) | [11.x only](#)

- **RPA Workspace**

[What's new](#) | [What's changed](#) | [Fixes](#) | [Limitations](#)

- **AARI**

[What's new](#) | [What's changed](#) | [Fixes](#) | [Limitations](#)

- **Discovery Bot**

[What's new](#) | [Fixes](#) | [Limitations](#)

- **IQ Bot**

[What's new](#) | [What's changed](#) | [What's deprecated](#) | [Fixes](#) | [Limitations](#)

- **Bot Insight**

[Fixes](#) | [Limitations](#)

Updating to this release

You can update the Automation 360 v.22 release from the previous three releases (that is, from $n-3$ releases, where n refers to the latest release).

The following previous releases are certified for update to this release:

- v.21 (Builds 9664, 9642, 9595)
- v.20 (Build 8815)
- v.19 (Builds 8147, 8145, 8122, 8098)

You can directly update to v.22 from any of these builds. For details on how to update, see [Update to latest Automation 360 version](#).

Recommendation: If you are not on an $n-3$ release, update Automation 360 to one of the three certified releases before updating to this release.

Bot agent update: This release includes a required update to your . Ensure that you complete the update to continue with your automation activities when upgrading from a previous release to this release.

[Automatically update the Bot Agent](#) | [Manually update the Bot Agent](#)

To verify which version is compatible with this release, see [Compatibility with Automation 360 builds](#).

For information about the latest updates to the Automation 360 extensions for Google Chrome, Microsoft Edge, and Mozilla Firefox, see [Enhancements to browser extensions](#).

Migration features

Enterprise 11 and Enterprise 10 features
<p>Migrate bots that use Credential variables (Service Cloud case ID: 00705937, 00761271, 00776189)</p> <p>You can now migrate bots that use Credential variables that are not available in the Cloud Control Room. However, you must create the required credentials after migration in the Credential Vault and use them in the migrated bots to run these bots successfully.</p>
<p>Migration support for Browser, Java, and Java Applet applications for App Integration command</p> <p>You can now migrate bots that contain the App Integration command with application types such as Browser, Java Applet, and Java applications.</p>

Enterprise 11 and Enterprise 10 features**New Action Required tab in Bot Scanner report**

In the **Bot Scanner** report, we have introduced the **Action Required** tab within the **Bots that can be migrated now** section to provide advance notification about bots that require manual intervention after migration so that they can run successfully in Automation 360. View messages associated with the bot that requires action to understand the cause and the specific action you must perform in Automation 360.

[Analyze Bot Scanner report for migration](#)

Action required, Review required, and Error messages for migration

Migration messages are now classified into the following categories: Action required, Review required, and Error messages:

- **Action required** and **Review required** messages are displayed for bots that contain unsupported commands but which you can still migrate and run after migration by performing specific actions. The messages provide specific actions you have to perform or information that you have to review to ensure that these bots run successfully after migration to Automation 360.
- **Error messages** are displayed when a specific bot is not migrated successfully. The messages also include the cause for the failure.

[Migration messages](#)

Enterprise 11 only features**Migrate bots with the following attributes:**

- Bots with timeout specified in their property
- Bots that contain the **GUI Automation** command with the **Restore Window** or the **Execute Script** option selected
- Bots that open a session for Terminal Emulator and Microsoft Excel in the parent bot and close that session in the child bot
- Bots that automate email-related tasks on Microsoft Exchange 2013
- Bots that use SAP BAPI standard and custom workflows to automate tasks on SAP applications
- Bots that contain the Window command with the **Close All Open Windows** selected to close all multiple active windows (Service cloud case ID: 00773227)

RPA Workspace

What's new**Save bandwidth on devices through preloaded offline bot packages**

Customized or most commonly used bot packages in a bot are now saved offline on a user device to the following new folder: `AAPreloadedPackages`. When a bot is deployed on a user's device, the packages are used from this `AAPreloadedPackages` folder instead of downloading them from the Control Room.

When a specific version of the package is available, you can download it from the Control Room repository to save the time required to download the package during bot execution.

[Preload packages](#) | [Devices](#)

What's new
<p>Introducing Text file package</p> <p>A new Text file package is now available and includes the Get text action. Use this action to extract text from files that have Japanese characters with Shift-JIS encoding and then save the content in the files to a string variable.</p> <p><i>Text file package</i></p>
<p>New actions in Window package</p> <ul style="list-style-type: none"> • Use the Close all action to close all windows or programs running on the system, except the windows added in the Add window field. • Use the Restore action to restore the size of a maximized or a minimized window or application running on the system. <p><i>Window package</i></p>
<p>Share session across bots</p> <p>Share a DLL, Excel, and Terminal Emulator session across multiple bots using the Global session option. You can also share a session with specific child bots using the Variable option and share a session with only the current bot using the Local session option.</p> <p><i>Sharing sessions across bots</i></p>
<p>Enhancements to Excel advanced package</p> <ul style="list-style-type: none"> • Open files with <code>.xml</code> and <code>.txt</code> extensions using the Open action. • Use the wildcard character (*) in the Open action for file names to search based on the wildcard pattern. • When you use the Run macro action and specify an argument that has a blank value, this blank value can now be passed to the macro.
<p>New option in Database: Disconnect action</p> <p>In the Database: Disconnect action, you can now use the Keep database schema in cache until bot finishes running option to enable the Loop action to iterate the dataset by using cached schema after disconnecting from the database.</p>
<p>TNS name supported for Oracle Database connection</p> <p>TNS (Transparent Network Substrate) name is now supported in the Oracle Database. You can connect to the Oracle Database by specifying the TNS name and path of the <code>tnsnames.ora</code> configuration file.</p>
<p>New Exchange version supported in Email package</p> <p>In the Email package, when you choose an EWS server to establish a connection, you can now use the Exchange2013 option in the Exchange Version field.</p>
<p>Enhancement to AISense Recorder</p> <p>AISense Recorder now enables automation of applications that use Russian and a combination of Russian and English interfaces.</p> <p><i>AISense for recording tasks from remote applications</i></p>

What's new
<p>Enhancements to recorder conditions for packages</p> <ul style="list-style-type: none"> Use the new Object does not exist condition from the Condition list of any package to verify whether a specific object in a window exists and then execute actions based on the result. <p>This condition works with SAP technology as well.</p> <ul style="list-style-type: none"> The existing Object condition is now renamed as Object exists. <p><i>Loop package</i></p>
<p>Enhanced support for SOAP Web Service URI (Service Cloud case ID: 00759811)</p> <p>In the SOAP Web Service package, if the input to the Address location field is empty, the bot now retrieves the address location from the WSDL file.</p>
<p>New option in SOAP Web Service package</p> <p>Use the Build SOAP request option in the SOAP Web Service package to retrieve SOAP request details from the SOAP URI or the WSDL file. You can now select any operations from the list of services and ports available in the SOAP Request to automatically populate data in the fields of the SOAP Web Service action.</p> <p><i>Example of using the SOAP web service action</i></p>
<p>New option in REST Web Service (Service Cloud case ID: 00764198, 00800287)</p> <p>In the REST Web Service package, you can now use the Allow insecure connection when using https option to skip SSL certificate validation and to allow non-secure connections.</p>
<p>Relative click and occurrence supported in packages (Service Cloud case ID: 0055643,00754173)</p> <p>When you capture a target image using the Image Recognition package, you can now use the Preview option to select a specific captured occurrence and position your click location relative to the image.</p> <p>The feature is supported in the following packages and actions:</p> <ul style="list-style-type: none"> Image Recognition > Find image in window Image Recognition > Find window in window If > Image Recognition condition Loop > While > Image Recognition condition Wait for condition action > Image Recognition condition <p><i>Using Find image in window action Using the Find window in window action</i></p>
<p>Wait time option in Google Sheets package (Service Cloud case ID: 00738249, 00817449, 00814775)</p> <p>When you use the Connect in the action in the Google Sheets package to establish a connection with the Google server, you can now set a wait time in the Wait for actions to complete field when performing actions such as Get, Set, or Delete. For example, if you have a large file that takes a long time to open, you can now set the wait time for the file to open before the system executes the next set of actions.</p>

What's new
<p>New option for Put action in Dictionary package</p> <p>You can now assign a static value to a key for a dictionary variable by using the Static value option in the Put action in the Dictionary package.</p> <p>Dictionary package</p>
<p>Java applications supported in App integration package</p> <p>The App integration package now supports Java applications that are based on the Standard Widget Toolkit and Abstract Window Toolkit, which can draw text using Windows text-drawing APIs.</p>
<p>Use regular expressions in File > Open action (Service Cloud case ID: 00737614)</p> <p>Use regular expressions (regex) in the Open action of the File package to support pattern-based search.</p>
<p>Specify timeout for bots (Service Cloud case ID: 00667049, 00690892, 00699158, 00706491, 00739420, 00739415, 00741590, 00769795)</p> <p>You can now specify the amount of time by which the execution of a bot must be completed. The system stops the bot execution if it is not completed within the time you specified.</p> <p>Configure timeout for bot execution</p>
<p>New option to search text within bot content in Bot editor (Service Cloud case ID: 00735685, 00736201, 00739122, 00740481, 00733885, 00748970, 00746459, 00738181, 00756441, 00759037, 00761453, 00764478)</p> <p>In the Bot editor, use the search box in the Flow, List, or Dual view to search for text, variables, or actions in the entire bot content such as package name, action name, string name, or variable name. This feature helps you to view or edit a bot with long code lines to determine where the searched text, such as variables, strings, or actions, is used and in which line.</p> <p>Actions palette for bot creation</p>
<p>Enhancements to the bot structure</p> <p>We have enhanced the overall readability of the bot structure and updated the node labels of the bot to show selected properties and parameters of each action in detail in the Flow, List, and Dual views. You no longer have to expand each action to view these details.</p> <p>The Flow, List, and Dual views display the following properties of actions:</p> <ul style="list-style-type: none"> • The value you enter for actions such as Set text for all supported technologies • Names of objects on which actions such as Set text, Click, Left click, Get property, and Select item by index are performed • Name of the object property mentioned in the action • Name of the return variable if some value is assigned to a variable • List of properties for the Get property action
<p>Enhanced network security control</p> <p>As a Control Room administrator, you can now configure and audit specific, permitted URLs for more granular control of the network access points.</p> <p>Set callback URLs</p>

What's new
<p>Enhanced proxy support</p> <p>Connections to the internet are often run through proxy servers. Automation 360 provides enhanced support for proxy configuration for packages, such as REST and SOAP packages, for building and running bots.</p> <p>Connect Bot Agent to a device with a proxy</p>
<p>Connect to Azure DevOps (Cloud) Git from Control Room</p> <p>You can now connect to Azure DevOps (Cloud) Git through the Control Room to check in a bot and its dependent files to the remote Azure DevOps (Cloud) Git repository.</p> <p>Connect to Azure DevOps Git from Control Room</p>
<p>Work item ID and time filters for workload automations</p> <p>Combine the work item ID and start time of a queue to search for specific work items and monitor the progress of these work items. The start time filters the list of all work items that start between specified start date and start time.</p> <p>Actions allowed on view queue page</p>
<p>Enhancements to execution type key in AATaskExecutor variable</p> <ul style="list-style-type: none"> When you schedule a bot to run, the <code>Execution_Type</code> key in the <code>AATaskExecutor</code> variable now returns information about the execution type with schedule type (frequency) such as <code>Run as schedule Daily</code>, <code>Run as schedule Weekly</code>, or <code>Run as schedule Monthly</code>. When you use a trigger in a bot, the <code>Execution_Type</code> key can be accessed through the trigger data. The <code>Execution_Type</code> key returns the <code>Run through Trigger</code> as a string for triggers.
<p>Language support for variable names</p> <p>Variable names now support Greek and Japanese languages. You can now create variable names using the following characters:</p> <ul style="list-style-type: none"> Greek uppercase and lowercase characters Japanese Katakana full-width and half-width characters.
<p>ML services support in Linux package installer</p> <p>The python package in the Linux installer package is now updated to support ML services. When you download and install Control Room on Linux, ML services are up and running as part of the installation process.</p> <p>Installing Control Room on Linux Stop and start Control Room services on Linux</p>
<p>Direct download support in Bot Store</p> <p>Users who cannot connect their Control Room to the internet can now directly download Automation 360 bots and packages locally from Bot Store and then import them to their Control Room.</p> <p>Download locally and import bots and packages from Bot Store to Control Room</p>

What's new**MS-SQL database management enhancement**

Administrators are no longer required to re-install Automation 360 to have the ability to change MS-SQL configuration related settings. The editable settings include username, password, database server name, database server IP and port numbers.

What's changed**Changes to Runtime Window**

The title on the **Runtime Window** is now changed to **Bot running** from the previous **Automation Anywhere**.

If any issue occurs in your automation due to this title change, see this article on how to resolve it: [A360.22 | Runtime Window: Minimize Command Fails Due to Title Change \(A-People login required\)](#)

Changes to Run DLL package

- The **Run function (Legacy)** action is no longer available in the Run DLL package. We recommend that you use the **Run Function** action from the Run DLL package because this action is an improved version of the **Run function (Legacy)** action.
Note that existing bots that use the **Run function (Legacy)** will continue to run successfully without any issues.
- The **Set session variable** action is no longer available in the Run DLL package. Instead, we recommend that you create a new DLL session using the **Variable** option in the **Open** action of the Run DLL package.

Note that existing bots that use the **Set session variable** action will continue to run successfully without any issues.

Messages for migrated bots for which referenced MetaBot logic is not available

Bot Scanner and Migration Assistant now display action required messages for Enterprise 11 or Enterprise 10 bots for which the referenced MetaBot logic is not available.

Migration of bots with missing variable is blocked

The migration process does not migrate Enterprise 11 bots that use a variable which is no longer available and that variable is used in the If, Loop, Variable Operation, or Clipboard command. Previously, these bots were successfully migrated but an error occurred when the bots were run.

Update to MetaBots that use same DLL in multiple logic (Service Cloud case ID: 00684185, 00730248, 00742840, 00742840, 00779629, 00779788, 00727977, 00743986, 00764872)

Migrated bots that use the same DLL in multiple MetaBot logic now work as expected without any modification. Previously, you had to update the migrated bots to run them successfully.

Migrated bots run successfully when mapped variables are not available (Service Cloud case ID: 00746651, 00785703)

Migrated bots now run successfully when mapped variables are not available in the child bot or the parent bot.

What's changed
<p>Enhancements to Bot Agent device settings</p> <p>To easily access local and remote devices, a user can now change the Bot Agent device settings from the My Settings page in the Control Room pane below your username. You can perform the following actions:</p> <ul style="list-style-type: none"> • Update device credentials • Change the default Bot Runner device • View local device name, status, and Bot Agent version <p>Set user device credentials View and update Bot Agent device settings</p>
<p>Enhancement to auto discovery for multiple domains</p> <p>You can now configure the maximum number of sites that can be discovered across the domain in the <code>um.properties</code> file for a Control Room set up for auto discovery across multiple domains in different locations.</p> <p>Configure Control Room for Active Directory: auto mode</p>
<p>Enhancement to OpenDistro for Elasticsearch</p> <p>As part of enhanced security, OpenDistro (cron-utils) is now upgraded to v.1.13.2 for Elasticsearch v.7.10.2</p>
<p>Update to Printer package</p> <p>In the Remove and Set default actions of the Printer package, you can now select a specific printer from the list of available printers.</p> <p>Printer package</p>
<p>Insert recorded actions in the middle of a bot</p> <p>You can now insert any recorded actions that are newly captured at a specified location in an existing bot. Previously, recorded actions were added to the existing bot at the end by default and users had to drag the action to the specified location.</p> <p>Universal Recorder for object-based automation</p>
<p>Migration: system variable behavior outside a loop (Service Cloud case ID: 00761281)</p> <p>When you migrate bots that use system variables outside a Loop package, the variables are now converted to record type or string type user-defined variables as applicable and assigned to a record action. As a result, when bots that contain these variables are run, data from the last row is displayed. Previously, an empty value was displayed after migration.</p> <p>The following system variables are converted to record type variables:</p> <ul style="list-style-type: none"> • \$Filedata Column\$ • \$Excel Column\$ • \$Dataset Column\$ • \$Table Column\$ <p>The system variable \$XML Data Node\$ is converted to a string type variable.</p> <p>Variable mapping for migration</p>

What's changed
<p>Support removed for Redirect URI attribute in Google Sheets package (Service Cloud case ID: 00777287)</p> <p>The Redirect URI attribute in the Connect action of the Google Sheets package is now removed. After updating to this release from previous Automation 360 releases, you can continue to successfully execute your bots by entering the fixed redirect URL in Google Cloud Platform: <code>http://localhost:8888/Callback</code></p>
<p>Updates to device credentials recorded in audit log (Service Cloud case ID: 00691511)</p> <p>You can now view audit log entries if your device credential is updated either manually through the Bot Agent device or through the Control Room API. Activity details such as the user name updating the device credentials and the time of the update are logged.</p>
<p>Enhancement to Image Recognition package</p> <p>When secure recording is enabled, the target image that is captured using the actions in the Image Recognition package is now hidden after the initial capture to enhance security. Previously, the user was able to view the target image even when secure recording was enabled.</p> <p><i>Image Recognition package</i></p>
<p>Enhancement to File and Folder package</p> <p>Users with a valid role permission can now create a shortcut to a selected source file at a specified location using the Create shortcut action in the File and Folder package.</p>
<p>Support for HTTP method HEAD (Service Cloud case ID: 00754096)</p> <p>The HTTP method <code>HEAD</code> is now supported as an API call to connect to the load balancer of a Control Room configured for high availability.</p>
<p>Update to Linux installation and log path</p> <ul style="list-style-type: none"> • Installation files <ul style="list-style-type: none"> • If you are on a version earlier than Automation 360 v.22 or if you have updated from an earlier version to v.22, the installation files are now stored in this path <code>/opt/automationanywhere/enterprise</code> • If you perform a new installation of v.22, the files are stored in this path: <code>/opt/automationanywhere/automation360</code> • Log files <ul style="list-style-type: none"> • If you are on a version earlier to v.22 or if have updated to v.22 from an earlier version, the log files are stored in this path: <code>/var/log/automationanywhere/enterprise</code> • If you perform a new installation of v.22, the log files are stored in this path: <code>/var/log/automationanywhere/automation360</code>
<p>Check out a TaskBot with specific version</p> <p>If a bot has multiple versions, you can now select and check out the specific version of the bot. As a Bot Creator, this enables you to roll back to an earlier version of the bot.</p>

What's changed
<p>Signed DLLs for bots and packages</p> <p>Automation 360 now signs all DLLs, including third-party DLLs, for bots and packages.</p> <p>The following are exceptions:</p> <ul style="list-style-type: none"> • The IQ Bot Pre-processor package does not have a new version in this Automation 360 v.22 release. The v.21 package version is copied to v.22 without modification, including a few unsigned DLLs. • The Process Discovery package in this v.22 release does not have the signing applied. • Automation Anywhere • Azul Systems (Java JRE in Bot Agent) • TeamDev Ltd. (third-party library)

Fixes	
Service Cloud case ID	Description
00712808, 00765752	In previous releases, Automation Anywhere related files were sometimes generated in <code>C:\Windows\Temp</code> . This issue is now fixed.
00800392	An error no longer occurs when you migrate from a Enterprise 11 version where a database is stored on Google Cloud Platform.
00811887	The Cloud Migration Utility no longer encounters an error when you use a custom port number to connect to the Enterprise 11 database.
00815097	Enterprise 11 bots that are checked out by a user are now successfully migrated to Automation 360 Cloud.
00802360	You can now update the value of Enterprise 11 credential attributes after they are migrated to Automation 360 Cloud. Previously, the system encountered an error when you updated the value of a credential attribute that was added or updated by a user in Enterprise 11 and that user was no longer available when Enterprise 11 data was migrated to Automation 360 Cloud.
--	When you migrate from Enterprise 11 to Automation 360 Cloud, an error no longer occurs when a locker is deleted in Enterprise 11 but its related permissions are still used in other entities.
--	An error no longer occurs when you update from Version 11.3.5.2 to any Enterprise 11 version and then migrate from that Enterprise 11 version to Automation 360 Cloud.
--	The Refresh and Back options are now available on the Summary screen of the Cloud Migration Utility when enough disk space is not available to store the backup of Enterprise 11 Control Room data.
00787240, 00781349	Migrated bots no longer encounter an error when a parent bot and its child bot are opened through Internet Explorer and the child bot extracts a table from Internet Explorer.
--	There is no limitation now on the number of ActiveMQ connections that are allowed when running an automation that is looped 5 times, with each loop running over 20 bots. In previous releases, the automation sometimes failed after the fourth loop.

Fixes	
Service Cloud case ID	Description
0074312	You can now successfully migrate bots that contain Trim operation of the String and the output is assigned to an Array variable.
00760963	Migrated bots that contain the Go To Cell command now work properly in Automation 360 after migration.
--	Bot Scanner now loads the modified <code>cache.properties</code> file from the <code>conf</code> folder. Previously, you had to place the modified <code>cache.properties</code> file in the executable file location of the Bot Scanner for the file to be loaded.
00754003	Bots that contain the SOAP Web Service command now successfully run after migration without encountering any error. Previously, an unexpected error occurred when the SOAP Web Service with WSDLs defined with external dependencies were not invoked.
00790360	In the Terminal Emulator package, when you send any key to the terminal with the Send text or Send key action, if the terminal is in a busy state or the keyboard is in a locked state, these actions now wait for 5 seconds for the terminal to return to a normal state. After 5 seconds, the system moves to execute the next action without any exception.
00742000	Migrated bots that contain the Prompt > For value command with the Don't write in any windows option selected now work as expected in Automation 360 after migration and no text is written in the file if any window is open. Previously, even if this option was selected, if any text file window was open, the text was written in the file.
00781072	When bots are migrated using the Bot Migration Wizard, migration no longer fails if the bot name includes a special character. Previously, an internal error occurred when the bot name included an apostrophe (') character.
00780713, 00778164	A migrated bot is no longer unresponsive when that bot uses the App Integration package to capture text from a target application and the target application becomes unresponsive.
--	Migrated Enterprise 11 bots that use the Terminal Emulator command to clear the terminal screen of the VT and ANSI type terminals no longer encounter an error when they are executed.
00748647	Migrated Enterprise 11 bots that use two-dimensional array and the Variable Operation command no longer encounter an error. Previously, the migration process used to set the number of rows and columns for the two-dimensional array to 1x1 irrespective of the values set in Enterprise 11.
--	The migration process continues to migrate bots if the connection between the Control Room and the Bot Agent is lost and then reestablished. Previously, the migration process failed when the connection between the Control Room and the Bot Agent was lost.

Fixes	
Service Cloud case ID	Description
00764441	In the Excel: Get single cell action of the Excel advanced package, you can now access the value of a specific cell defined in the cell address. Previously, migrated bots encountered a <code>Must match pattern</code> error when a Japanese character was entered in the Cell address field.
00757713, 00764985, 00820376	The Excel advanced package now enables you to read from a protected sheet. Previously, migrated bots encountered an error when you retrieved a cell from a protected sheet using the Excel advanced: Open action.
00761911	You can now migrate bots using the Excel column system variable where the key is the column name ; an error is no longer encountered.
00769321	Migrated bots no longer encounter an error when the Run Excel Macro command is included in the bots. Migrated bots now run properly using the Run macro action of the Excel advanced package.
00790858	You can now migrate a bot when there is a variable mismatch and the respective command is disabled. Previously, when the bot was assigned a certain variable type and the Variable Operation command in that variable was disabled, Bot Scanner displayed an error for the variable when the type was later changed.
00744318, 00744326, 00745318	You can now download an exported bot file with Japanese characters in the filename through email. Previously, when an exported file with a Japanese name was downloaded using the email link, an error occurred or the characters in the exported zip filename were garbled and <code>.zip</code> was appended to the filename.
00762975	After you migrate Enterprise 11 bots that use the Error handling command with the Send email function and the Attach variable and Attach snapshot option, the bots now correctly send error emails with attachments containing a snapshot or variable text file.
00731577, 00746226, 00760649, 00759973, 00767618, 00789545, 00821824	The <code>includePackages</code> parameter of the Export API now works as expected. If you set the value of the parameter as True the packages are included in the exported file, and if the value is set to False the packages are not included in the exported file.
--	You can now migrate bots with variable names that include full-width and lowercase characters. Previously, migration of bots with a variable name that included full-width and uppercase characters was not supported because the variable was mistakenly converted to a half-width character.
00759189	Migrated bots now use the date format specified in the <code>AADefaultDateFormat</code> global value for email-related automation. You must create the <code>AADefaultDateFormat</code> global value before migrating the bots and specify the date format you want to use in the migrated bots. Recommended: Specify the same date format in the <code>AADefaultDateFormat</code> global value that is used in Enterprise 11.

Fixes	
Service Cloud case ID	Description
00784001	Enterprise 11 bots that are migrated now contain all the properties of an object captured from a SAP application.
00786362, 00802274	Enterprise 11 bots that are migrated no longer encounter an error when the child bot and parent bot use different versions of the If package.
00807986	Enterprise 11 bots that are migrated no longer encounter an error when a variable that is mapped between a child bot and the parent bot is not available in the child bot.
00808026	<p>Enterprise 11 bots that are migrated no longer encounter an error when they use a shared session for Terminal Emulator related tasks when a session is shared between nested child bots and an intermediate child bot does not contain any Terminal Emulator actions.</p> <p>For example, consider that you have three bots: Bot1, Bot2, and Bot3, where Bot1 calls Bot2 and Bot2 calls Bot3. Bot1 and Bot3 share a session for Terminal Emulator related tasks; however, Bot2 does not contain any actions from the Terminal Emulator package. When you share a session between Bot1 and Bot3, an error is no longer encountered.</p>
00762368	Previously, when bots were migrated using Oracle database processes with passwords containing the symbol, an issue occurred. The issue is now fixed and passwords using the "@" symbol are now supported.
00768466, 00769099	An error no longer occurs when you migrate MetaBots that contain logic that are available within a folder.
00772885	The system now retrieves all rows in a table in a SAP application when the last page of the table contains a single row.
00801733	An increase in CPU usage no longer occurs when the Control Room is in an idle state.
00774821	An error no longer occurs when you run migrated bots that contain a Loop action within another Loop action.
00786732	For Enterprise 11 bots that use the Extract Table command along with other commands within the Error Handling command and only the Extract Table command is disabled, only the equivalent action for the Extract Table command is disabled after migration. Previously, all the actions within the Error Handling action were disabled in the migrated bot.
00743892	An error no longer occurs when you run migrated bots that use DLLs that return a value of user-defined type. Such values are converted to the string type in the migrated bots.
--	Enterprise 11 bots that use variable operations to re-initialize an array type variable to contain more than 160,000 cells (for example, 400 rows and 400 columns, or 800 rows and 200 columns) no longer encounter an error when they are executed after migration.
00737025	Enterprise 11 bots that pass system variables such as Month, Year, and Day as an input variable to a MetaBot no longer encounter an issue after they are migrated.

Fixes	
Service Cloud case ID	Description
00773407	Previously, historical activity reports exported to CSV did not display the Last Modified information correctly because some of the Modified On and Modified By information was not accurately processed. The error is now fixed and historical activity reports can now be correctly exported to CSV files.
00767597	The Last Modified (date) value displayed in the historical activity and bot page reporting was previously not translated correctly when the Control Room language was changed from English to non-English, and then back to English. This error is now fixed, and the data is preserved when the language is changed in the Control Room.
00762975	Japanese language text is now updated in the interface for recent user experience (UX) changes. Previously, there were some errors in the translated text in the interface, which are now fixed.
00763228, 00776154	Database constraints, such as foreign key constraint violations, previously prevented users from deleting bots after migration. This limitation is now fixed and users can delete migrated bots (.atmx files) without any issue.
00749375,00763262	After migration, if text file encoding was set to UNICODE or UTF8 , you can now use the String: Import string from text file key to read values from the text file during bot runtime.
00739268	You can now migrate bots that have large <code>html</code> data associated with the Object Cloning command without any issues.
00674147, 00682390	The Stop service action of the Service package now enables you to stop all child and dependent services of a selected window or application. Previously, the dependent service did not stop automatically when a user tried to stop any window or application service.
00754835	Temporary devices are now automatically deleted if the auto-delete option is enabled for device settings in the Control Room.
00751058, 00761099	When you use the Database Connect action for workload automation, work items from the second iteration are now executed for automation. Previously, only the first work item in the workload automation was executed.
00771098	After you edit a schedule from the Scheduled activity page and save the schedule, the correct page (Scheduled activity) is now opened instead of the In progress activity page.
00733614, 00741358	You can now use the Extract image action of the PDF package to convert a PDF file that contains JPX images to any other image format. Previously, the action failed to extract image from the PDF file because the JPX image reader was not supported.
00765851	Recorder actions now work properly and do not cause any delay when the Set text value contains brackets or [] (which enables you to run a migrated bot without delay). Previously, it took a longer time to run the bot when Set text contained [] (brackets).

Fixes	
Service Cloud case ID	Description
00771197	In the Open action of the Browser package, the description below the Time out after (seconds) (optional) field is now translated correctly as <code>Min= 9 seconds</code> in the Japanese language. Previously, the description was translated as <code>Max= 9 seconds</code> .
00761395	In the Database package, when you connect with the Oracle Database and use the Read from action option in a loop to retrieve records from the database, the bot is now executed successfully. Previously, bot execution failed with an error.
00727530	The Move all action in the Email package now works properly and does not encounter any issue.
00739978	An error no longer occurs when you choose the Manual input option to open a VB Script file.
00728180	The issue with event triggers when creating folders in bulk is now resolved. If you configure an event trigger to start a bot whenever a folder is created and then create folders in bulk, the bot is now deployed for every folder that you create. Previously, the bot was not deployed for all the folders created.
00711134, 00750164, 00847916	If you configure multiple triggers to start bots based on file events and if all the files reside in the same folder, the bots associated with all the triggers are now deployed. Previously, only some bots were deployed.
00719612	When you log in to the Control Room as an unattended Bot Runner, you can now execute bots using the Run as self option. Previously, an unattended Bot Runner could not run the bot with the Run as self option even when the device was set as the default device.
00745095	In the Database package, when you connect to the Microsoft Access database using the JDBC connection, the select query now extracts the file name for the Attachment data type. Previously, an error was displayed.
00772194	Data from any database type is now exported correctly in CSV format. Previously, if the data had special characters such as double quotation marks, the output was displayed in a new line.
00773961	When you create a new worksheet by name in the Google Sheets package, an error no longer occurs when you execute the bot.
00762029	An error no longer occurs when you execute a bot using the Google Calendar package. Previously, when the Disconnect action was used to terminate the connection, the email address attribute was stored in the session name instead of the user session name attribute. As a result, bot execution failed with an error.
00758333	If all versions of a particular package are disabled, then the package is no longer listed in the Actions palette of the Bot editor. Previously, when a package was disabled, the Bot Creator still displayed it in the Actions palette and users were able to use the package when creating a bot. However, these bots failed on execution because the package was disabled.

Fixes	
Service Cloud case ID	Description
00780221	A bot created using the Run function action in the Run DLL package now executes without any issues. Previously, an error was displayed on bot execution due to the unavailability of some embedded resources such as satellite assembly.
--	An error no longer occurs when you create a bot using the Send text action of the Terminal Emulator package and pass a variable with an empty value. Previously, the bot failed to execute when any variable options (Credential, Variable, Insecure String) that had no value was selected.
00776430	When you connect to the Terminal type TN3270E in the Terminal Emulator package, select any of the Terminal model options from the list, and execute the bot, the correct screen resolution is now displayed. Previously, a wrong value was sent for each Terminal model and a screen with incorrect resolution was displayed.
00773415, 00781487	When you open a spreadsheet in the Google Sheets package and select the Beginning of the row option in the Go to cell action, the output is now displayed correctly. Previously, the output was displayed at the column level.
00773415, 00781493	An error no longer occurs when you open a new or blank spreadsheet in the Google Sheets package and you select an action such as Go to cell or Set cell to perform an operation. Previously, bot execution failed with an error.
00779561	In the System package, when you use the Get environment variable action in view mode, the environment variables are now always displayed in the list. Use the refresh option to retrieve all the environment variables in the list. Previously, the environment variables were sometimes not displayed in the list.
00775073	In the Excel advanced package Get worksheet as data table > Read option, the description for the Read cell value option now reads correctly as 50% will be read as 50 when it is translated to the Japanese language. Previously, the description was translated as 50% will be read as 50%.
00767246	The SOAP Web Service package now works for URIs, where the service endpoint can be passed as a URI parameter. Previously, an error was displayed for such requests.
00734463, 00754570, 00766456	When the Connect action of the Database package is used to establish a connection with the Microsoft SQL Server using Windows authentication, the bot now executes successfully even when the parent and child bots use different versions of the Database package. Previously, the bot failed if the parent and child bots used different versions of the Database package.
00780921	An error no longer occurs when you use the PDF extract text action to extract text from a PDF file. Previously, when structured text was extracted from a PDF file, an error was displayed because the index exceeded the 1000 range.

Fixes	
Service Cloud case ID	Description
--	In the Excel advanced package, when you use the same session name to open multiple Excel spreadsheets, the bot now displays an error on execution. Previously, if the same session name was used in multiple spreadsheets, the bot overwrote the existing open session when the second Open action was executed.
00785198	In the Data Table package, when you now use the Write to file action to extract data from a table with large records, 1000 rows of data are read in batches and written to a CSV file. Previously, a Java heap space error was displayed because the configured Java heap memory ran out of space. As a result, data could not be retrieved from a table with large data and written to a CSV file.
00757593	In a Cloud deployment, child bots can now be migrated using the Migrate Bot action from the Bot Migration package. Previously, child bots were not migrated but a migration successful message was displayed.
00731012, 00747385, 00746320	If you install the Control Room in the default location in C:\ and configure the logs directory in another location (for example, E:\), WebCr logs are now generated dynamically in the custom location.
00768318, 00760835	An error no longer occurs when you try to capture objects using AISense Recorder on any version of Windows that does not have the default media feature pack. Previously, the AISense Recorder did not highlight the objects on a page.
00737710	In the Capture action of the Recorder package, when you select the Set Text action and enter a string variable with a delay set for each keystroke, the output is now displayed correctly on a new line for all Microsoft applications. Previously, on bot execution, the output was shown on one line when a delay was set in the Keystroke .
--	If you deploy bots using event triggers and you install the Bot Agent on a device as a non-admin user for self or a local admin user, the Bot Agent is now updated automatically. The device is no longer shown as disconnected in the Control Room.
00782596	You can now migrate workload automation bots from Enterprise 11 to this release. A client protocol exception message is no longer displayed.
00743810, 00785703	You can now map variables with different letter cases between parent and child bots when you run bots after migrating them from Enterprise 11 to this release. For example, if the variable name in Enterprise 11 is <code>Var1</code> and the variable name is changed to <code>var1</code> after migration, you can map the variables and continue to run the bots.
--	Bot deployments on Bot Agent devices no longer fail when you close a terminal window using the close Window action from the Window package or manually close the Terminal Emulator window.

Fixes	
Service Cloud case ID	Description
00767587	You can now run bots from the In progress activity page. Previously, bots were stuck in the Pending execution state and as a result other bots did not run. You had to manually move the bots stuck in this state to the Historical activity page to run the other queued bots.
00789682, 00798933	You can now delete, reset, or place on hold workload automations because work items are no longer stuck in the ready to run status. Also, the following message is no longer displayed: <i>Work item cannot be deleted in this state.</i>
00720471	An error no longer occurs when you use the Recorder package to capture an object and perform the click action on the capture coordinates. Previously, when you captured the object properties and if the download bar in Google Chrome was open, object properties in the browser could not be captured.
00754651	In the If action of the If package, when you select any condition from the Condition list, and drag any other action inside the If action, the condition is no longer deleted from the Condition list and the action no longer disappears from the List and Flow view.
00768354	An error no longer occurs when you use the AISense Recorder in child bots when running them in a loop. Previously, when the AISense Recorder was used in a child bot and the bot was executed, external processes were not terminated, causing the system to run out of memory.
--	Previously, when bot migration was performed, the process sent various, occasionally multiple, email notifications to all existing Control Room users, even if the administrator had disabled email notifications. An option is now added to enable the administrator to disable email notifications when Credential Vault data is created during bot migration.
00762368	Previously, when bots were migrated using Oracle Database processes with passwords containing the "@" symbol, an issue occurred. The issue is now fixed and passwords using the "@" symbol are now supported.
--	Previously, during migration, a parent bot was successfully processed even if associated child bots did not exist. This created errors during runtime. In this release, if associated child bots do not exist for the parent bot, a message notifies the user of the required action before migration can continue.
00762975	Bots that used the Error Handling action to capture screenshots were incorrectly modified and appended as .PNG files. Migrated bots are no longer modified and appended in this manner.
00751496	Attended Bot Runner devices now show an improved time performance when running bots on Microsoft Edge browser.
00753673	When you run a migrated bot that contains the Excel Advanced > Delete cell > Specific cell option with comma-separated input cell values such as A1, B1 , the migrated bot now runs successfully and displays the output correctly.

Fixes	
Service Cloud case ID	Description
00736473	Fixed an issue where a migrated bot containing the Excel Advanced > Open action did not load the Excel add-ins even when the Load Add-ins check box was selected. Now, the Excel add-ins are loaded successfully.
00767917	You can now run bots with a queue on single user devices that were previously configured for multiple users.
00712719	An error no longer occurs when you run bots that contain actions from the Terminal Emulator package on your device. Previously, bots could not be run due to a synchronization issue with the terminal.
00753121	An error no longer occurs when you use the Convert excel to PDF action of the Excel advanced package to save a converted PDF to a shared network drive.
00763746, 00773924	When you select the Keystrokes action in the Simulate keystrokes package and enter a variable or static text containing half-width Japanese characters, the output now displays the correct Japanese characters. Previously, on bot execution, the output displayed incorrect characters.
00774872, 00807106, 00824486	When you use the Close action of the Browser package to close the last Chrome browser window, the last tab of a Chrome browser window, or all Chrome browsers, the bot no longer encounters an error. Previously, when the Close action was used to close the last Chrome browser window, the last tab of a Chrome browser window, or all Chrome browsers, bot execution failed because the Chrome communication channel was shut down.
00762178	When you deploy bots using RDP on unattended user devices configured for multiple users, a black screenshot is no longer captured.
00800573, 00796393, 00804854	When you select a run-as user to deploy a bot, you can add a Bot Runner user back from the list of Selected Bot Runners to the list of available Bot Runners on the Run bot now page.
00744929	When incorrect Git credentials are entered, the credentials are now hidden and not recorded in the <code>WebCR_Commons.log</code> file. Previously, incorrect Git login credentials were recorded and not hidden in the log file.
00751304	The error model in Swagger docs is now updated to display all the fields appearing in the API response body. Previously, there was a mismatch between the fields displayed in the API response body and the error model in Swagger docs.
00763398	An error no longer occurs when multiple Excel files are opened and you use the Run macro action in the Excel advanced package. Previously, an error was displayed when a macro was run with multiple sessions.
00759183	The Open action of the File package now opens any file using the default application set by the user. For example, if Microsoft Paint is set as the default application for all <code>.jpg</code> files, the action now opens these files without any error. Previously, bot execution failed with an error.

Fixes	
Service Cloud case ID	Description
00750185	An error no longer occurs when you run a migrated Enterprise 11 bot containing the Object Cloning command even if it contains some Unicode 8964 characters in some of its properties. The bot now captures objects after migration without any error. Previously, the bot failed to capture objects after migration if it contained Unicode characters in its properties.
00774091	All object properties of the Object Cloning command are now migrated without any errors. Previously, bot execution failed with an error because the HTML ID and HTML name properties were changed after migration.
00796322, 00823082	When you insert a variable as a parameter in any action of a package, add additional text to this variable, save the bot, and then edit the name of the variable from the variable list, the additional characters added to the variable are no longer deleted.
00731066	The Capture action in the Recorder package now works properly, and you no longer encounter any delay when creating and running new bots to extract any data from a DataGridView control in certain UI automation applications.
00784177	A bot deployment error is no longer displayed when you edit and run a bot using Run bot now from the Bot editor of a Cloud Control Room.
00782307, 00787807, 00811404, 00788178	Bot deployments are no longer stuck in a queue and now display the error <code>Picked at runtime</code> after Automation 360 On-Premises is updated from the previous release to this release.
00786786, 00806775	You can now capture a single object using a recorder from Google Chrome browser, and the following message is no longer displayed: <code>Error performing single capture.</code>
00780202, 00798826, 00808779	When you deploy bots using RDP on unattended user devices configured for multiple users and you set the RDP screen resolution to 1366x768, the resolution no longer changes to 1368x768 during bot execution.
00769647, 00767674, 00773115, 00777239, 00778972, 00777752, 00792839, 00804603, 00806606, 00815687, 00829496	The View historical activity page now shows the correct run details of start date and time for bots that fail during execution.

Limitations
<p>If you configure an external key vault in External Key Vault Integration and select the SQL authentication mode for database authentication in the Windows installer Database Server page to install Control Room (On-Premises), the installation fails, and the following error message is shown: <code>Control Room database tables fail to create.</code></p> <p>Workaround: Add the database credentials in the external key vault and use those credentials for database configuration.</p>

Limitations
<p>The Task bots runs metric on the Home dashboard page of the Control Room displays the count as zero even if you have run bots from the same Control Room.</p>
<p>(Service Cloud case ID: 00837271) If you are migrating from Enterprise 11 with a database that has a large amount of repository data, the installation might fail. This issue occurs because Liquibase update for a few SQL queries is not completed during migration.</p> <p>Workaround: Contact Automation Anywhere Support.</p>
<p>When you are installing the Bot Agent, if you run out of disk space and click OK on the Out of disk space window, the Bot Agent installation wizard might display the previous installer windows.</p> <p>Workaround: In the Setup type window, click Cancel and relaunch the Bot Agent installation wizard.</p>
<p>(Service Cloud Case ID: 01021889) In this release, when you schedule or deploy a bot from the Control Room, you will not receive an email notification if the bot fails to run.</p>
<p>(Service Cloud Case ID: 00780635, 00791587, 00795559, 00795632, 00797130, 00797113, 00791783, 00765770, 00826805, 01859661) When you update from the previous release, schedules disappear from Control Room instances configured on a single-node or multi-node environment. In some cases, after the update, previously deactivated schedules disappear and are reactivated automatically.</p> <p>Workaround: Divide large schedules into smaller schedules or reduce the schedule frequency.</p> <ul style="list-style-type: none"> • Divide large scheduled automations into smaller schedules of two hours each. For example, divide an automation schedule that runs for a 12-hour period, such as 9 AM to 9 PM daily, into two-hour intervals, such as 9 AM to 10:59 AM, 11:00 AM to 12:59 PM, and 1:00 PM to 2:59 PM. • Reduce the schedule frequency to 10 minutes.
<p>Migration of Enterprise 10 MetaBots with the password type variable with null value is not yet supported. To migrate successfully, provide a default value to the password variable when creating MetaBots in Enterprise 10.</p>
<p>When you attempt to log in to the Control Room configured with Active Directory, using the Log in with Windows option is not currently supported in this release. Selecting this option can generate a <code>java.lang.NoSuchMethodError</code> error.</p> <p>Recommended: Enter the domain credentials directly.</p>
<p>(Service Cloud case ID: 00831886) As a Bot Creator, you cannot run bot tasks through the AARI process. Although human tasks appear fine, the Activity page displays the In Progress state and seems stuck on the Waiting for user and/or device action.</p> <p>Workaround: Remove the process discovery license - recorder from the AARI Bot Creator user. Please refer to AARI process discovery license assignment for more information.</p>
<p>You cannot use the Global session option to share a Microsoft Excel session using the Excel advanced package with the Loop package.</p> <p>Alternate solution: Use the Get multiple cells action and save the data into a datatable variable. Then, use the Loop package with the Data Table option selected.</p>

Limitations
<p>The migration process successfully migrates bots that contain brackets or [] but the process fails when you migrate the same bots again to migrate the delta changes even when the overwrite option is selected.</p> <p>Workaround: Delete existing bots from Automation 360 that contain brackets or [] before migrating them again.</p>
<p>Users with the AAE_Bot Migration Admin role are not able to run migrated bots because the Run my bots and Create folders permissions are not available in this role. As a result, these users can start the migration process, convert the bots but cannot run the migrated bots.</p> <p>Workaround: Create a custom role with the Run my bots and Create folders permissions and assign this role to the users with the AAE_Bot Migration Admin role.</p>
<p>When Enterprise 11 MetaBots that use a DLL that returns a two-dimensional array of type single as output and stores the value to a file using the Log To File command are migrated as TaskBots to Automation 360, these TaskBots encounter an error when they are executed.</p>
<p>Migrated bots that are used to automate tasks using RDP encounter an error when the DPI of the remote device is different from the current device.</p>
<p>Newly created Control Room users on Windows for On-Premises Google Cloud Platform VMs cannot change their password. The security questions option is not available on the Change password screen and as a result the Control Room displays an error when they try to save the password.</p> <p>Workaround: Refresh the page and change the password again.</p>
<p>(Service Cloud case ID: 00770816) When you connect to an Exchange Web Services server, multi-factor authentication (MFA) must be disabled, including in all organizational level security policies where multi-factor authentication might be enabled. If multi-factor authentication is not disabled completely, users might encounter connection and or authorization errors.</p>
<p>Automation 360 does not support the Kibana version in Elasticsearch for which a privilege escalation error is shown in the Black Duck report.</p>
<p>The Bot Agent is not updated automatically from a previous release to this release when you perform different operations simultaneously such as running bots, configuring device settings in the Control Room, and updating the Control Room.</p> <p>Workaround: Restart the Bot Agent from the Task Manager.</p>
<p>A file is not deleted when you execute the bot with the following sequence of actions:</p> <ol style="list-style-type: none"> 1. You use the CSV/TXT > Open action to open a <code>.csv</code> file. 2. You use a loop action within another loop action to retrieve values from the <code>.csv</code> file. 3. You use the CSV/TXT > Close action to close the file. Here, all the actions are using the same Default session. 4. You use the File > Delete action to delete the file. <p>The issue (file is not deleted) occurs because the bot fails to close the Default session.</p>

Limitations
<p>Bot execution can fail with an error when you execute the bot with the following sequence of actions inside a loop:</p> <ol style="list-style-type: none"> 1. You use the Browser > Open action to open a window. 2. You use the Recorder > Capture action to capture required objects on the window. 3. You use the Browser > Close action to close the window. <p>Workaround: Use the Window > Close action to close the window instead.</p>
<p>If you update the device information from the Administration > Settings > Devices page, only the first update is captured in the Audit Log page. Subsequent updates to the device are not captured.</p>
<p>When you register a new Bot Agent user device from the bot editor after creating and running a bot, the following message is intermittently displayed: <code>Device is either disconnected or it needs to be upgraded.</code></p> <p>Workaround: Click Run to deploy the bot on the new Bot Agent user device.</p>
<p>When you use the Universal Recorder to record multiple tabs in a SAP application, the Set text action in the Client control of SAP does not work because it is currently not supported.</p>
<p>When multiple users check in their bots simultaneously, some of the check-ins fail although Git is not corrupted and no data is lost.</p>
<p>When you use the 2.3.0-20210806-215200 version of the Recorder package to capture any control using HTML technology in Google Chrome or Microsoft Edge Chromium browser and run the bot, the bot might fail with the following error message: <code>Unable to find control. Search Criteria did not match</code></p> <p>Workaround: Use the 2.2.0-20210722-211132 version of the Recorder package instead.</p>
<p>When you try to automate any process in a Java application that is using version 11.0.8 of AdoptOpenJDK, the Recorder might not be able to capture the drop-down elements on the application.</p>

AARI (Automation Anywhere Robotic Interface)

What's new
<p>Output variables support in Process Editor</p> <p>The Output variables section in the process editor enables you to create a user-defined variable that can be set as an output to any process. This helps you pass the output from the child (sub) process, which was called in the Process Task, to the parent (main) process.</p> <p>Use an Output variable</p>
<p>Select File element input supported for Create a Request action</p> <p>The Create a Request action in the AARI Web package now supports passing input in the request creation forms for the Select File element. You can now use bots to create a request and upload or download files as input with the Select File element. These input files are uploaded to the storage service to be available for further processing in the request.</p>

What's new
<p>Detail view in Tasks page</p> <p>The new Detail view option in the Tasks page provides better insight into individual tasks for better task management. The detail view previews each task in its respective request view page without opening another page, which helps organize and correspond your tasks with the available requests. Users can interact with their tasks as well.</p>
<p>Additional support for interface triggers on Google Chrome</p> <p>You can use the following additional actions for interface triggers on the Google Chrome browser during bot runtime:</p> <ul style="list-style-type: none"> • Hyperlink element: Click, Set focus, or Lost focus actions • Checkbox element: Select, cleared, Set focus, Lost focus, or Selection changed actions • Radio Button element: Select, deselect, Set focus, Lost focus, or Selection changed actions <p>Add an interface trigger</p>

What's changed
<p>Font size retained during bot runtime</p> <p>When you create a form, the font size that you selected in the Formatting > Font size drop-down menu is retained on the form during bot runtime.</p>
<p>Cancel option in the process and team setup page</p> <p>When a user edits a process or team in the Process setup and Process setup pages, the Cancel option replaces the previous X option to provide better clarity for the user to cancel the current page.</p>

Fixes	
Service Cloud case ID	Description
00781358	You can now add bots with table variables that do not have a default value to a process without encountering any errors.
00791703	When you use the desktop tray icon to open AARI Assistant, dependent files are no longer displayed along with the application.
--	In the process editor, the Go To option now shows the Filter Task and Process Task options.
--	When you enter data in a form of your process that contains a hyperlink, the process data is no longer ignored and now works correctly.
--	When you use Process Task in the process editor, you can now use the Public folder option in the Select process file field.
--	In Bot Task and Human Task , when you select a box, the input is now accurately selected.
--	The Requests page is now correctly updated with the latest request events (such as completion of tasks) for users with an Attended license.

Fixes	
Service Cloud case ID	Description
--	When you update to this release, a built-in scheduler now periodically checks for any disconnected or temporary devices and clears these entries.
--	When you open a form in the public folder, it cannot now be edited by changing the term View to Edit in the URL.
--	When a user logs in to AARI Assistant, all the triggers associated with that user name are now available.

Limitations
<p>Users cannot edit a form or process in a public workspace, they must check out a form or process in order to edit in a private workspace. However, when users attempt to edit a form or process in a private workspace, they receive an Access denied error message due to the cache not being refreshed.</p> <p>Workaround: Navigate to the your private workspace, refresh the page to clear the cache, then edit your form or process.</p>
<p>An AARI user with the AAE_Robotic Interface User license who is not part of an assigned team can view all requests and tasks from other teams in the web interface. However, when the user attempts to access a request or task, they are prompted with an error message.</p>
<p>When a form is opened during bot runtime, the automated focus on the first form element is lost. For example, consider that Form A has various elements, and a Text Box element called Name is the first one. When Form A is opened during bot runtime, the focus is lost from the Name element and you cannot enter any values.</p> <p>Workaround: When a form is opened during bot runtime, click the form element to enter or change the value.</p>
<p>When you log in to the web interface as an administrator, for certain languages, the translated text on the left navigation pane is truncated (not displayed completely).</p> <p>Workaround: Hover over the menu item to view the tooltip, which displays the completely translated text.</p>
<p>In the Google Cloud Platform instance of the AARI on the web interface, when you open a request that contains previously uploaded files, you might intermittently experience an error while downloading the files.</p> <p>Workaround: Retry downloading the file.</p>
<p>If a form has a table element and you use the Set action from the Interactive forms package during bot runtime, values are not applied to the table element.</p>
<p>If you selected the action trigger as Changed value for a Dropdown element within a trigger loop, any associated event is triggered during bot runtime even when there is a Reset action.</p>
<p>In an SDS setup, when you create a request to upload a file, the upload fails and a <code>SecurityTokenInvalidException</code> error message is displayed.</p>
<p>The Override output variable option in the End Process endpoint is not currently functional for users to override a variable definition.</p>

Discovery Bot

What's new
<p>View Groups of steps</p> <p>When reviewing a process view, you can now use the group option or icon to display groups of steps that belong to the primary level action and secondary level action (and subgroup level actions) used during the recording session.</p> <p>Use the group icon to help you decide what groups of steps to select for a task you want to automate. For example, a primary level action displays Microsoft Outlook, a secondary level action displays Outlook mail notification, and subgroup level actions display terms such as Email -Add To, Email – Add Subject.</p> <p><i>Create a process view with branches and opportunities</i></p>
<p>Use Dynamic option for system-generated views</p> <p>You can now use the Dynamic option from the Model options to view recordings where groups of steps display a set of repeating patterns that belong to the same application or same primary level action used during the recording session.</p> <p>Use this option to decide the context of the process or the task you want to automate. Groups of steps that are labeled belong to supported applications such as Microsoft (Excel, Outlook, and Notepad), Notepad++, text editors, most windows use cases, and Chrome browser functionality.</p> <p><i>Create a process view with branches and opportunities</i></p>
<p>Enhancements to PDD Word document</p> <p>The PDD Word document now includes a process recording flow chart and the time on each individual step in hours, minutes, and seconds.</p> <p><i>Review opportunities and convert to bot</i></p>

Fixes	
Service Cloud case ID	Description
--	The Control Room installer for Red Hat Enterprise Linux (version 7.7 or 7.9) now includes the Discovery Bot package. Previously, you had to log in to the Control Room as admin, select Manage > Package > Upload , and upload the Discovery Bot package.

Limitations
<p>In a Linux environment, when you record a process using the Discovery Bot recorder, the recorder window opens for 4 seconds and then disappears. The error occurs because the <code>ProcessDiscovery</code> folder is missing in the following directory: <code>/var/automationanywhere/enterprise/appdata/Server Files/</code>.</p> <p>Workaround: Perform the following steps to create an empty <code>ProcessDiscovery</code> folder manually and provide write access to the folder:</p> <ol style="list-style-type: none"> 1. Navigate to the following path in the Control Room directory: <ol style="list-style-type: none"> a. If you have updated from an earlier version to v.22, navigate to <code>/opt/automationanywhere/enterprise/appdata/Server Files</code> b. If you perform a new installation of v.22, navigate to <code>/opt/automationanywhere/automation360/appdata/Server Files</code> 2. Run the <code>sudo mkdir ProcessDiscovery</code> command to create an empty folder for <code>ProcessDiscovery</code> in the specified Control Room directory. 3. Run the following command to provide the required read and write permission for the newly created <code>ProcessDiscovery</code> folder: <ol style="list-style-type: none"> a. <code>sudo chown -R crkernel:controlroom ProcessDiscovery/</code> b. <code>sudo chmod -R 775 ProcessDiscovery/</code>
<p>When you upgrade to A360 v.22, you might receive multiple email notifications about the PDD generated in A360 v.21.</p>
<p>When you add branches to the left and right sides of the main branch, the Recording flow chart section of the PDD might not capture the entire process work flow, including all the branches.</p>

IQ Bot

What's new
<p>IQ Bot standard forms integration with IQ Bot Extraction</p> <p>You can now use the IQ Bot Extraction package for data extraction from standard forms documents.</p> <p><i>Using IQ Bot Process documents action</i></p>
<p>Confidence threshold applicable on standard forms learning instance</p> <p>For a standard forms learning instance, if the Confidence threshold value that you have set does not match any field, the document is moved to the Validator and a notification icon is displayed. This update now enables you to validate the document for the learning instance and also save the document.</p>

What's new
<p>Additional OCR engines for IQ Bot Extraction package</p> <p>In addition to the existing OCR engines, IQ Bot Extraction package now supports the following OCR engines:</p> <ul style="list-style-type: none"> • Microsoft Azure 2.0 • Google Vision API <p>IQ Bot Extraction package</p>
<p>Export IQ Bot dashboard data</p> <p>A user with the AAE_IQ Bot Admin role can now export the following data from the dashboard to a CSV file using the Export icon:</p> <ul style="list-style-type: none"> • Documents processed • Pages uploaded • Straight-Through Processing • Accuracy <p>The CSV file is saved to the local <i>Downloads</i> folder.</p>
<p>IQ Bot support for self-signed certificates</p> <p>You can create a self-signed certificate with Subject Alternative Name (SAN) to use an SSL certificate for multiple domains.</p> <p>Creating a self-signed certificate with Subject Alternative Name</p>

What's changed
<p>IQ Bot package supports external proxy server settings (Service Cloud case ID: 00727414, 00725235, 00757568, 00753560, 00753560, 00786609)</p> <p>The Download all documents and Upload Document actions in the IQ Bot package now support external proxy server settings.</p>
<p>IQ Bot Python library upgrade (Service Cloud case ID: 00756943, 00791511)</p> <p>IQ Bot now uses Python version 3.9.5 for data extraction.</p>

What's deprecated
<p>IQ Bot [Local Device] package</p> <p>The IQ Bot IQ Bot [Local Device] package is deprecated from this Automation 360 v.22 (Build 10526). Instead, use the IQ Bot Extraction package, which provides the same capabilities as the IQ Bot [Local Device] package, along with additional improvements.</p> <p>IQ Bot [Local Device] package replaced by IQ Bot Extraction package (A-People login required)</p> <hr/> <p>Note: Before using the IQ Bot Extraction package, update the bots associated with the IQ Bot [Local Device] package and restructure the output folders.</p> <hr/> <p>IQ Bot Extraction package</p>

Fixes	
Service Cloud case ID	Description
--	If you delete a <code>.csv</code> file from the <code>Success</code> folder, you can now download the remaining files from that folder.
--	When you use the IQ Bot Extraction package for processing a large set of documents, you no longer encounter any document processing issues with Bot Agent.
--	If an incorrect value was used in the <code>providerVersion</code> field when you uploaded standard forms configurations to IQ Bot, an error notification is now displayed when you select this configuration when creating a standard forms learning instance.
00806805	You can now import a learning instance using the Migration Utility feature as the <code>Invalid Group</code> error message is now resolved.
--	When you creating a learning instance using standard forms, all the available pre-trained models are now listed in the Select Model drop-down menu.
00703856	IQ Bot now correctly extracts table rows with numeric values even when they are within parenthesis.
--	The File Download API now returns a correctly formatted JSON response with a colon (<code>:</code>) separating the key-value pairs.
00694656	IQ Bot now successfully extracts values from the documents that have new table fields added after training.
00636887	An error notification is now displayed if you upload documents with file names longer than 150 Asian language characters in the staging environment. Note: This is not applicable to a production environment.
--	IQ Bot cloud data query is now optimized to prevent overloading of the Amazon Relational Database Service.
00782994	When you use the Migration Utility to move a learning instance between environments, unclassified data is no longer exported.
00747137	You can now import learning instances using the Migration Utility feature without any issues.

Limitations
The value displayed in the My totals > Accuracy field sometimes does not match the value in the My learning instances > Field accuracy for the available learning instances.
If you try to import a learning instance into an IQ Bot environment that has a deleted learning instance with the same name, the following message is displayed even though the learning instance is not imported: <code>Import process initiated</code>
If you access IQ Bot without the correct permissions, they are redirected to an <code>Access denied</code> page, where the back button does not work. Workaround: Close the current tab and open the Control Room.

Limitations	
When you select Other domain in the learning instance creation page, the tooltips for the table and form fields state that these fields are optional. However, these fields are required to create a learning instance.	
IQ Bot installation sometimes fails and the following message is displayed: <code>Failed to upgrade the DB: -1</code> . When this issue occurs, retry the installation.	
(Service Cloud case ID: 01016516, 00757943, 00787404, 00788421, 00807528, 00822941, 01018972) If you add multiple ABBY OCR based commands (such as IQ Bot Pre-processor, IQ Bot Classifier, AISense Recorder, OCR) in a single bot, an error message is displayed when you run the bot. Workaround: Ensure that you do not add multiple commands in a single bot.	
(Service Cloud case ID: 01063054) You cannot import a learning instance with a long name (>50 characters) because IQ Bot only supports up to 50 characters in the Label field.	
If you use the Process documents action from IQ Bot Extraction package to upload documents, the validation rules from the default the validation group that you set are not applied. As a result, the failed documents are not classified into any of the existing groups and are moved to Validator.	
In the IQ Bot Community Edition, when you use a Cloud OCR to create a learning instance, if you use the IQ Bot Process document action from the IQ Bot Extraction package, the values from the uploaded invoices or documents are not processed successfully. Workaround: If you use the Cloud OCR to create a learning instance, use the IQ Bot Upload Document action from the IQ Bot package.	
After you train a bot and click Save and go to next group , the system fails to load the next group. Instead, it reloads the same group. Workaround: Perform the following steps: <ol style="list-style-type: none">1. Refresh the page.2. Navigate to Learning Instances and click Bots to edit the Learning Instances.	
System identified regions are not generated when a non-English filename is uploaded using the Invoice domain and processed with the AutoExtract command. Workaround: To process the document, convert the non-English filename to English characters.	

Bot Insight

Fixes	
Service Cloud case ID	Description
00788583	In the Profile tab, when you edit, save and generate a business dashboard and the dashboard is not saved, the error message description is now translated correctly in the Chinese language. Previously, if an error occurred when you saved the edits in the Profile tab of the Business dashboard, the error message description displayed garbled text.

Fixes	
Service Cloud case ID	Description
00729920	When you migrate a task from a source (UAT) to a target (production) environment, a Published dashboard copy is no longer deleted from the source environment.
00742260	You can now export data from operational or custom dashboards after applying a non-metric variable in the filter. Previously, the data was not exported when you toggled between different chart types.
00738228	Multiple dashboards are no longer created for a TaskBot when you update and execute a bot that is checked out from the public workspace. Previously, when a bot was executed after an update, multiple dashboards were created.
00757992	A user with the Bot Creator license can now access all the Bot Insight dashboards (Operations and Business tabs) irrespective of their assigned role. Previously, if the user had the Bot Creator license with the AARI Admin role, they were not able to access these dashboards.

Limitations
(Service Cloud case ID: 00733555, 01912503) In a dashboard, the data labels in the pie chart overlap if it contains many slices. As a result, the labels in pie chart are not clear and shown only when you hover over the slices. Workaround: To view the data labels in a pie chart in clear and readable format, export the dashboard data to Excel file. Note: Due to a limitation within the third-party recharts library, you might observe labels overlapping issue with data in downloaded PDF as well.

Important: For information about the packages supported with this release, see [View package versions available in the Control Room](#).

Automation 360 v.21 Release Notes

Release date: 09 June 2021

Review what's new and changed, and the fixes and limitations in the Automation 360 v.21 release. Automation 360 (Cloud and On-Premises) is on Build 9664. Automation 360 IQ Bot Cloud is on Build 9664 and On-Premises is on Build 9642.

Patch release updates

We have updated Automation 360 Build 9664 (Cloud and On-Premises) for the following fixes:

- Process deployments containing forms with empty table, check box, or text box are failing after the AARI Cloud build is updated from the previous release to this current release (Service Cloud case ID 00788255).

- The layout of the request view page changes when another language other than English is selected (Service Cloud case ID 00772925).
 - Warning messages in the process editors render garbled characters due to missing UTF-8 encoding (Service Cloud case ID 00781891, 00784947).
 - Users (with the attended license) are not redirected to the AARI Assistant application due to users (without the attended license) trying to connect to the AARI Assistant application beforehand on the same device.
 - Not able to capture keystroke actions on an application using the Universal recorder (Service Cloud case ID 00785310).
 - Files were missing from the embedded resource folder, causing issues in using the Recorder package (Service Cloud case ID 00767315, 00777786, 00775209, 00788523, 00797261, 00795511, 00785246).
 - Bot deployments are getting stuck in a queue after Automation 360 Cloud is updated from the previous release to this release (Service Cloud case ID 00784333, 00784890, 00784382, 00784338).
 - Cloned bots are losing their dependency when they are checked-in (Service Cloud case ID 00780756).
 - The recording duration was not updated correctly under **Process Cycle** on the process card, and the recorded steps were not captured by the recorder (Service Cloud case ID 00790884, 00781022).
- **Migration**
[11.x and 10.x](#) | [11.x only](#) | [10.x only](#)
 - **RPA Workspace**
[What's new](#) | [What's changed](#) | [Fixes](#) | [Limitations](#)
 - **AARI**
[What's new](#) | [What's changed](#) | [Fixes](#) | [Limitations](#)
 - **Discovery Bot**
[What's new](#) | [Fixes](#) | [Limitations](#)
 - **IQ Bot**
[What's new](#) | [What's changed](#) | [Fixes](#) | [Limitations](#)

Updating to this release

You can update the Automation 360 v.21 release from the previous three releases (that is, from n-3 releases, where *n* refers to the latest release). The following previous releases are certified for update to this release:

- v.20 (Build 8815)
- v.19 (Builds 8147, 8145, 8122, 8098)
- v.18 (Build 7560)

You can directly update to v.21 from any of these builds. For details on how to update, see [Update to latest Automation 360 version](#).

Recommendation: If you are not on an n-3 release, update Automation 360 to one of the three certified releases before updating to this release.

Bot agent update: This release includes a required update to your . Ensure that you complete the update to continue with your automation activities when upgrading from a previous release to this release.

[Automatically update the Bot Agent](#) | [Manually update the Bot Agent](#)

To verify which version is compatible with this release, see [Compatibility with Automation 360 builds](#).

Enhancements to browser extensions: The Automation 360 extensions for Google Chrome (version 1.2.0.0), Microsoft Edge (version 1.2.0.0), and Mozilla Firefox (version 1.2.0.2) now include the following enhancements:

- Support for HTML buttons and text actions in Interface trigger
- Enhancements to the default search criteria for text boxes and check boxes using Recorder package.
- Fixes for capturing objects with characters not valid in XML using the Recorder package.
- Fixes to the Discovery Bot recorder with default browser (Google Chrome) search page.

Migration features

Enterprise 11 and Enterprise 10 features
<p>New system role to perform migration</p> <p>Assign the AAE_Bot Migration Admin system role to the user who will perform migration. This role contains all the permissions required to view and manage the bot migration process. Using this role eliminates the manual effort of creating custom roles, selecting the required permissions, and assigning them to the users who perform the migration.</p>
<p>Enhanced bot runtime window</p> <p>When you migrate bots using the Bot Migration Wizard, the bot runtime window now shows the name of the Enterprise 11 or Enterprise 10 bot file that is currently migrated.</p>
<p>You can now migrate bots with the Open webpage in a new window and Open a webpage in an existing window settings.</p>
<p>You can now migrate Enterprise 11 and Enterprise 10 bots with multiple versions of a DLL.</p>

Enterprise 11 only features
<p>MetaBot screens: Custom objects and play mode enhancements</p> <ul style="list-style-type: none"> • Custom objects within the Image play mode are now fully supported. • Linked objects are now captured.
<p>Enhanced Hide/Show option in Control Room</p> <p>For bots available in the Control Room (the <code>My bots</code> folder), a filter is available to hide or show older <code>.mbot</code> and <code>.atmx</code> files displayed in the window.</p>
<p>Global values for SAP</p> <p>The migration process creates the <code>JcoDllPath</code> and <code>JcoJarPath</code> global values of type string to support migration of SAP BAPI.</p>
<p>Enhanced Database action functionality</p> <p>The Database action now supports connecting to Oracle databases using <code>SID</code> and or <code>Service_name</code>. In previous releases, only connecting with <code>SID</code> was supported.</p>
<p>New email variable strings</p> <p>New email sent and received string variables are available for the Loop, Import DataSet, and Export Dataset actions to insert sent values for date and time.</p>

Enterprise 11 only features**Enhanced Microsoft Exchange Web Services support**

The Send function in the Email package supports EWS OAuth2.0, improving backward-compatibility.

Manually migrate from Enterprise 11 to Cloud-enabled environment

You can now manually migrate from Enterprise 11 to a Cloud-enabled environment. In this migration, you must create all the entities such as users, roles, and credentials manually, except bots. All Enterprise 11 versions are supported for this migration.

[Prepare for Enterprise 11 to Automation 360 Cloud-enabled migration](#)

Enterprise 10 only features**Migrate MetaBots screen with Password type variable**

You can now migrate Enterprise 10 bots based on the MetaBot screen, which uses the **Password** type variable. During the migration, the logic (.logic file) in the .mbot file is migrated as a new TaskBot within the MetaBot folder. Also, the **Password** type variable is migrated as a credential variable and is assigned to a predefined locker.

Migrate TaskBots based on MetaBot Screen and DLL assets without using Logic

You can now migrate a TaskBot that references the Run MetaBot action for the MetaBot Screen and DLL assets directly, without using the MetaBot Logic. So you can migrate a TaskBot that contains MetaBot Screen and DLL assets.

RPA Workspace

What's new**Automation 360 navigation enhancements**

We have enhanced the overall readability and accessibility of the Automation 360 interface. To make navigation easier, menus and views are organized based on frequently used features and related tasks.

The interface includes the following updates:

- The Device, Profile, and Help icons are now located at the bottom of the navigation menu, consolidating all controls on the left for easy access.
When you click these icons, flyout panels of content and actions are shown.
- The side navigation menu can be collapsed to a slim bar to maximize the main workspace area.
You can continue to use the side navigation in collapsed mode, with flyouts for each section.

[Automation 360 navigation updates](#)

Authenticate database connection with Microsoft Azure Active Directory credentials (Service Cloud case ID 00676448)

You can now authenticate the Control Room database connection using Microsoft Azure Active Directory credentials when you install the Control Room on Microsoft Azure.

[Configure Microsoft database type and server](#)

What's new
<p>External Key Vault enhancements</p> <p>External Key Vault support for AWS Secrets Manager and CyberArk for Auto-login and Automation credentials has been added to Automation 360. Auto-login credentials and Automation credentials (credentials used by bots) can now be retrieved from the configured external key vault.</p> <p>Integrate external key vaults</p>
<p>Deploy workload automation on a multi-user Windows terminal server</p> <p>To optimize workload automation and multi-user devices, you can deploy workload automations on a multi-user Windows terminal server so that a single device can process multiple work items concurrently.</p> <p>About multi-user devices About device pools</p>
<p>Control Room and Bot Agent compatibility checks for automation</p> <p>To manage the lifecycle of your automation, you can view dependency information about minimum compatible Control Room and Bot Agent versions when you create and deploy automations. You can then update your automation and reduce runtime errors caused by an incompatible Control Room or Bot Agent version.</p> <p>Actions palette for bot creation</p>
<p>New actions in the SAP BAPI package</p> <p>Use the following new actions:</p> <ul style="list-style-type: none"> • Run standard workflow: Runs a standard workflow in SAP BAPI. • Run custom workflow: Runs a custom workflow in SAP BAPI. <p>SAP BAPI package</p>
<p>New actions in File package</p> <p>Use the following new actions:</p> <ul style="list-style-type: none"> • Get name: Reads a file name and stores it to a string. • Get path: Reads the path of the file and stores it to a string. <p>File package</p>
<p>Common table expression supported in Database package</p> <p>You can now use common table expression (CTE) in the Read from action using the <code>WITH</code> keyword in SQL-compliant databases such as Oracle and MySQL. Use CTE statements within a SQL query to simplify complex joins and subqueries.</p> <p>Using the Read from action</p>
<p>Support for large numbers in Number package (Service Cloud case ID:00557619)</p> <p>You can now perform mathematical operations for large numbers with more precision in the Number package.</p> <p>Number package</p>

What's new
<p>Snowflake database support using ODBC driver (Service Cloud case ID:00761695)</p> <p>Snowflake ODBC driver is now supported in the Database package. You can connect to the Snowflake database using ODBC-based client applications.</p> <p>The following actions support this feature:</p> <ul style="list-style-type: none"> • Connect • Disconnect • Read from • Export to data table • Insert/Update/Delete
<p>Variables: new features and enhancements (Service Cloud Case ID:00740585)</p> <ul style="list-style-type: none"> • Edit the variable name after the variable is created. • Delete all or a specific selection of unused variables from a bot.
<p>Universal Recorder new features and enhancements</p> <ul style="list-style-type: none"> • Record object interactions in applications built on the Electron framework. • Perform double-click in all supported applications and browsers.
<p>Limit credential attribute use to password fields only (Service Cloud Case ID:00740585)</p> <p>When you create or edit a credential attribute, ensure that bots input the attribute value only in fields that are identified as password fields by selecting the Set this attribute as a password option.</p>
<p>Organize device pools to check for available devices in a preferred order</p> <p>If you select multiple device pools (either in the Run now or Schedule window), you can now arrange the device pools in the order of preference. When a bot is deployed, the Control Room selects the first available device based on the order in which you organized the device pools. If none of the devices are available at the time of deployment, the bot is queued.</p>
<p>Default names for output variables</p> <p>When you configure an output variable for the actions in the Error handler and Python Script packages, the Control Room automatically generates a descriptive default variable name. If you create more than one output variable for an action, the subsequent variable names are appended with a -1, -2, -3, and so on to avoid a variable name conflict.</p>
<p>New string action to support nested variables</p> <p>Use the String > Evaluate value action to compare a user-specified string variable with the string variables in the bot. If a match is found, the action returns the value of the matching variable.</p> <p><i>String package</i></p>
<p>Delete Global values</p> <p>A user with the AAE_Admin role can delete a global value from the All global values page.</p> <p><i>Global values</i></p>
<p>High availability support</p> <p>For Cloud-enabled users, high availability is supported through three-node deployments.</p>

What's new
<p>String package enhancement</p> <p>A new option to support local numbering styles is now available in the String package. You can now select your local format, represented by ISO-3166.</p>
<p>Dependent files and package information in Export package audit details</p> <p>In the Audit details of an exported package, you can now view the list of dependent files and packages associated with the exported package. This feature enables you to analyze what the exported package contains and identify any discrepancies. If you chose to include packages during an export, then only the package information is included in the audit details.</p>
<p>ODBC driver support for all connection strings (Service Cloud Case ID: 00748887, 00777676)</p> <p>An Open Database Connectivity (ODBC) driver is now available to support all the ODBC connection strings in the same way it was used in the Enterprise 11 version. Using SQL as a standard for accessing and managing data, you can connect to MySQL, Google BigQuery, Snowflake, and other databases using the ODBC driver.</p>
<p>Share a DLL session</p> <p>You can now share a DLL session between bots.</p>
<p>New CredentialAllowPassword annotation</p> <p>Use the new CredentialAllowPassword annotation in the package SDK to allow the selection of a credential attribute marked as a password. You can use this annotation when creating a new SDK package or when modifying an existing one.</p> <p><i>Configure and use credential allow password annotation</i></p>
<p>Enhancements to check-in, check-out, and cloning permissions (Service Cloud Case ID: 00645904, 00720237, 00752197, 00760306, 00764684)</p> <ul style="list-style-type: none"> • When performing a check-in, you can now choose the dependencies to check in along with the bot. Directly referenced dependencies will be automatically checked in with the bot. • When a bot is checked in along with a cloned bot and there are no other bots dependent on the clone, the cloned bot is now deleted. • When performing a check-out, you can now choose the dependencies you want to check out with the bot. The dependencies that are not selected during the check-out are now cloned. • During check-out, you can now overwrite or replace a cloned bot.
<p>Bot Agent installer includes shortcut for AARI Assistant</p> <p>A shortcut to access AARI Assistant easily is added on the desktop and Windows menu when you install a Bot Agent.</p> <p><i>Install Bot Agent and register device</i></p>

What's changed
<p>Bot Scanner shows invalid bots in "cannot be migrated" list</p> <p>The Bot Scanner is updated to show invalid bots as blocked from migration because these invalid bots were failing before and after migration. For example, Enterprise 11 or Enterprise 10 bots that referenced non-existent variables failed. So some bots will no longer be shown in the can be migrated list of bots but will instead be shown in the cannot be migrated list in the output report. This can decrease the number of bots that can be migrated to Automation 360.</p>

What's changed
<p>Change in names of file locations and folders</p> <p>File locations and folder names are now updated for the change in product name (from Enterprise A2019 to Automation 360). For example, the file location for the default installation path is changed from <code>C:\Program Files\Automation Anywhere\Enterprise\</code> to <code>C:\Program Files\Automation Anywhere\Automation360</code>. We will be updating these locations and names on our documentation pages soon.</p>
<p>Source string is optional in Split action (Service Cloud case ID: 000687257, 00702258)</p> <p>In bots (including bots migrated from Enterprise 11), when you use the Split action in the String package, the Source string field is now optional. You can run the bot without providing a source string value. Migrated bots that contain empty input strings now execute successfully.</p>
<p>Mandatory prerequisites validation before migrating bot</p> <p>When you migrate bots using the Migrate bots option in the Bot Migration Wizard, a prerequisite validation message appears with a checklist of all the validation items. The system now validates these prerequisites automatically to ensure that all prerequisites are met before you start the bot migration. Previously, validating prerequisites was optional.</p> <p>If the prerequisite validations are completed with a failure, a validation report appears with the list of items for which validation failed. If the prerequisite validations are completed without any failure, the bot migration is started.</p>
<p>Change in default Control Room database name</p> <p>The default Control Room database name is now changed from <i>AAE-Database</i> to <i>Automation360-Database</i>.</p> <p>If you are upgrading from an earlier release to this release, enter your existing Control Room database name to preserve your data.</p>
<p>Microsoft SQL Server clustering for high availability</p> <p>You can now use Microsoft SQL Server clustering for automatic and graceful failover of high availability deployments in Control Room clusters.</p> <p>Database requirements</p>
<p>Bot Agent nickname is hidden</p> <p>The nickname of a Bot Agent (added during installation) is now hidden when you switch the registration of a user device from one Control Room instance to another.</p>
<p>User interface change in the Open action of Excel packages</p> <p>In the Excel basic and Excel advanced packages, the Sheet contains header check box now appears below the Select file field.</p>
<p>User interface change in the Variables palette</p> <ul style="list-style-type: none"> The User-defined variables list is now named Your variables System, String, and Clipboard variables are organized within Predefined variables
<p>Digits with comma considered a valid number (Service Cloud case ID: 00623458)</p> <p>In migrated bots, a set of digits that uses a comma is now considered a valid number. This change enables you to successfully verify mathematical operations and If, ElseIf, and Loop variable conditions containing various operators.</p>

What's changed
<p>Date comparison works with dates in different formats (Service Cloud case ID: 00723479)</p> <p>Date condition actions are now successfully migrated to the equivalent date conditions in On-Premises. The date condition now works with multiple subformats of the main format (MM/dd/yyyy). Therefore, you do not have to manually change the date format per the source format of the migrated bots that contain date strings.</p>
<p>Use string value with numeric operators</p> <p>Migrated bots that contain If or While actions that use string values or a variable containing a string value with <, <=, >, and >= numeric operators now run successfully.</p>
<p>Enhancement to Extract field action in PDF package</p> <p>Use the PDF viewer in the Extract field action to extract all the form field data and selected text, and store the form data to variables.</p> <p><i>Using the Extract field action</i></p>
<p>Connect automatically to SQL server for Windows authentication (Service Cloud case ID: 00691554)</p> <p>When you upgrade the Bot Agent, you no longer have to add <code>d11</code> files manually to connect to the Microsoft SQL Server using Windows authentication.</p> <p>Previously, users had to manually add <code>d11</code> files to configure devices and use the Connect action from the Database package to connect to the Microsoft SQL Server with Windows NT authentication.</p>
<p>Enhancement to Active Directory mapping</p> <p>You can now create AD groups using commas in the naming on the AD server side and the Control Room side. Previously, this caused an error.</p>
<p>Enhancement to the Split action of String package</p> <p>Migrated bots now run successfully when the Split action is used to split a string available in an input variable and that variable is empty.</p>

The following table lists the fixes and the builds in which they were fixed. Build 9664 is the latest build for Cloud and includes fixes from the previous builds. On-Premises is on Build 9664.

Fixes		
Build	Service Cloud case ID	Description
9664	00803314	<p>The following issues are fixed in the latest version of the Cloud Migration Utility:</p> <ul style="list-style-type: none"> • The utility checks the current version of your Enterprise 11 Control Room and proceeds only if that version is supported for migration to Automation 360. • The utility displays the target tenant information on the successful validation screen when you navigate to the migration code screen. • An error is no longer encountered when access is provided to: https://aws.amazon.com and https://aa-provsvc.globalservices.automationanywhere.com • The utility uploads all the required data to Automation 360 Cloud.
9664	00790884, 00781022	<p>The recording duration for a process is now correctly displayed under Process Cycle on the process card. Previously, you were not able to view the recording duration because of a delay in the network connectivity. You can now view all recorded steps captured by the recorder from the Recordings page.</p>
9664	00785310	<p>You no longer encounter any issue when you use Universal Recorder to record keyboard actions on an application. The Universal Recorder now captures the value of keystrokes properly. Previously, the Universal Recorder captured only the first value of the keystroke.</p>
9664	00767315, 00777786, 00775209, 00787736, 00797261, 00795511, 00796245, 007956217, 00798533, 00795084	<p>You no longer face issues because of global cache expiry and partially deleted files in the embedded-resources folder (C:\ProgramData\AutomationAnywhere\GlobalCache\embedded-resources) when you install a Bot Agent for this release and capture objects in Google Chrome using the Recorder package.</p> <p>Note that, if the Bot Agent device has embedded resources folder partially deleted, you must first delete the global cache and update the Bot Agent.</p>
9664	00796598	<p>When you run workload bots with queue on Bot Runner devices, the bots do not fail intermittently after Automation 360 Cloud is updated from the previous release to this release.</p>

Fixes		
Build	Service Cloud case ID	Description
9642	--	Control Room instances configured with Active Directory for authentication with the retrieval of credentials from an external key vault were unsuccessful due to incorrectly prepending domain names in object names (CyberArk) and secret names (AWS) and caused authentication to fail. This issue is now fixed and object names (CyberArk) and secret names (AWS) are now properly formatted.
9637	00784333, 00784890, 00784382, 00784338, 00780635, 00791587, 00795559, 00795632, 00797130, 00797113, 00791783	Bot deployments are no longer stuck in a queue after Automation 360 Cloud is updated from the previous release to this release.
9637	00780756	You can now check in bots that have a shared dependency with other bots successfully. Previously, check-in failed because of an issue with the cloned bots losing the dependency during check-in, irrespective of their existing parent bots.
9595	00733638, 00756399	Bots that use a variable to specify the child bot to run no longer encounter an error because the variablized path contains a backslash.
9595	00711390	The retry mechanism now enables you to migrate large .atmx files. Previously, when a large .atmx file was migrated, the connection with the Control Room became stale or unauthenticated, resulting in a <code>NoHttpResponseException</code> error. With the retry mechanism, the Migration utility attempts to build a connection with the Control Room 5 times until the connection is successfully rebuilt.
9595	00730369, 00747866	Recorder actions now work properly, which enable you to run the migrated bot without any delay. Previously, it took a longer time to run the bot due to a long delay.
9595	00733383, 00754559	The Loop counter variable now works properly for migrated bots. The variable is now migrated as part of the XML and the Data Table commands.

Fixes		
Build	Service Cloud case ID	Description
9595	--	When updating the SQL queries on a migrated bot using the Read from and the Insert/Update/Delete actions of the Database package, the existing format of the query is no longer automatically modified. Previously, when editing the SQL queries on a migrated bot, the characters were being misplaced.
9595	00721238	You can now use the Browser action to access a URL with parameters using the Microsoft Edge browser. Previously, when a URL with parameters through the Browser action was accessed using Microsoft Edge, the URL parameters were truncated from the & (ampersand) character after the bot was run.
9595	00721488	Enterprise 11 bots that use the Get multiple nodes command no longer provide a different output after migration. Previously, the migrated bot returned output per the structure of the XML file, while the Enterprise 11 bot provided output in a single line.
9595	--	You no longer encounter an issue when you run bots migrated from Enterprise 11 that use identical names for variables differentiated by a hyphen or an underscore (for example, L-Lower and L_Lower). The variable name that contains a hyphen is now appended with some keywords (for example, variable Arr-val is updated to Arr-val-MIG-SPL-25). Previously, bots failed to execute after migration.
9595	00729931	After migration, when the bot file is generated, the correct DOMXPath is now migrated. Previously, an incorrect DOMXPath was migrated.
9595	00738643	The If and Loop conditions when used in a combination of multiple AND or OR conditions now works properly. Previously, using the If and the Loop conditions with multiple conditions resulted in a bot logic error.
9595	00743808, 00754554	Migrated bots that use the If command with a variable in the HH:MM format now work properly and no longer encounter any issue.

Fixes		
Build	Service Cloud case ID	Description
9595	00678059	You can now download exported packages if the bot name contains Japanese characters and an underscore (_). Previously, if the name contained such characters, an unexpected error occurred that restricted the user from downloading the package.
9595	--	When you run a migrated bot that contains the Excel Advanced > Find action, the found cell is now active and subsequent actions can perform operations on that active cell.
9595	00731512	You can no longer edit a bot and change the bot repository file path from the public to private folder by updating the Control Room URL and repository path in the browser.
9595	00734059	INFO type messages are no longer duplicated in the Control Room <code>WebCR.log</code> file.
9595	--	When you install a Bot Agent at the user level, the user device is now registered as admin.
9595	00744663, 00747831, 00737488, 00752613	You can now successfully export a bot that contains the Recorder package.
9595	00726433	Fixed an issue with Microsoft Graph APIs that caused errors when a bot downloaded files from OneDrive. Bots can now successfully run the Office 365 OneDrive > Download file action.
9595	00703553	When a new user is created, the Audit API now returns the correct values for the eventDescription and userName parameters.
9595	00729563	The <code>atmx</code> file extension is no longer case-sensitive. You can now migrate tasks that include uppercase or lowercase letters in their file extensions. Previously, tasks with uppercase letters in their file extensions were not migrated by the Bot Migration Wizard.
9595	00740548	Bot status is now correctly displayed after a process is executed. Previously, scheduled bots were occasionally mislabeled as <code>In progress activity</code> even though the bot had completed the process.
9595	00731508	You can now enter Nordic characters in the credential attribute and credential variable values.

Fixes		
Build	Service Cloud case ID	Description
9595	00695176, 00692676	Newly copied bots containing an event trigger now run when the triggering event occurs.
9595	00759742	When you insert a variable in a text string, the variable is now inserted at the cursor position. Previously, the variable was inserted at the end of the string and not at the cursor position.
9595	--	You can now successfully deploy bots from the Bot editor. Previously, when the Bot Creator or Bot Runner (attended or unattended) user logged in to the Control Room and if the package download option was enabled, the package download took priority and bot deployment had to wait until the package download was completed.
9595	00730211	When you use the Recorder package > Get property action to extract the path property of the object, the recorder now retrieves the value of the height and path attributes of the captured object. Previously, the height and path attributes of the recorded object were not retrieved by the bot.
9595	00716793	An issue is no longer encountered when you execute a bot using the SOAP Web Service package with unformatted input parameters. Previously, bot execution failed with an error because the unformatted input parameters were not formatted in XML format by the bot.
9595	00706709	In the Email package, when you use the Outlook connection to retrieve emails with the date filter, all emails are now retrieved correctly. Previously, all the emails were not retrieved from the application when the date filter was applied.
9595	00714292	To support double backslashes (\\) in the file location for actions that use file input, you must now set the Bot compatibility version as 2 in the Advanced settings page of the Bot editor. Previously, the bot execution failed because the double backslash (\\) in the file location was replaced with a forward slash when you select a network path using Browse option.

Fixes		
Build	Service Cloud case ID	Description
9595	00697460	When you select the recorder in the If condition, the recorder now locates the object in the Oracle EBS application and captures the correct object properties without any error. Previously, the recorder failed to find the object when captured in the If condition.
9595	--	In Microsoft Edge or Firefox, when a bot opens a website inside a loop, the Recorder Capture action now works properly after the launch website operation is executed. Previously, the action failed after launch website was executed.
9595	00710257	In the Recorder package, the Capture action now works without encountering any issues. Previously, the Recorder failed with a timeout error because the network proxy details were not retrieved.
9595	00735480	A TaskBot now performs better when you use the Loop action to execute a bot. Previously, the TaskBot took a long time to complete execution.
9595	00559868	When you use Datetime package > Assign action to convert a DateTime variable using the custom format dd-MMM-yyyy, the bot now executes without any errors. Previously, the bot execution failed due to case-sensitive characters in the DateTime format.
9595	--	Migration of PaaS database (Azure SQL) connection strings by using an ODBC driver is now supported.
9595	00733651	You can now view the average time spent to create a TaskBot metric in the Control Room on different pages when you click a page number.
9595	00742305	When you turn off one node on a three-node cluster and log in to the Control Room, the following error is no longer displayed: Cluster group is empty.
9595	00712190, 00698197, 00700574	When you deploy a bot with string values that exceed the allowed limit of 2 - 4 MB, the Control Room recognizes it as an exception and now shows the following error message: 400 Bad Request.
9595	00754585, 00755448	When you run a bot, dependencies including the child bots are now downloaded. The bot no longer shows an unknown status and session as expired.

Fixes		
Build	Service Cloud case ID	Description
9595	--	When you now migrate the Database command, no additional configuration is required.
9595	00745046	You can now check in your bots without encountering any issues. Previously, bot check-in failed because the Git repository was corrupted intermittently.
9595	00677638	When you add a user device as the default device in the Control Room, the Devices page now automatically displays it as the default device. You no longer have to re-log in to the Control Room or refresh the Control Room page.
9595	00733370	Users signed in to temporary (non-persistent) shared devices can now sign in to the Control Room after a previous session on the temporary device is deleted by the Control Room administrator.
9595	00736950	MetaBots using Japanese characters (double-byte string) as the output variable can now be successfully saved and executed after the MetaBots are migrated to On-Premises using the migration wizard.
9595	00723924	The Terminal Emulator type ANSI now accepts a password that contains braces or {}. Previously, when braces were used in the password, an invalid username and password error message was shown in the terminal screen.

Limitations
<p>(Service Cloud Case ID: 00797199) If multiple instances of Bot Agent in Google Chrome browser are displayed and multiple Google profiles (accounts) are open in the browsers, you might not be able to use the Recorder > Capture command. You might see an error message that informs you that the Google Chrome plug-in not installed.</p> <p>Workaround: Automation 360 supports only a single profile for automation. Therefore, we recommend that you either configure a single Google profile in Google Chrome or, if you are using multiple profiles simultaneously in Google Chrome and want to automate one profile, enable the Automation 360 extension for Chrome on only one of the Google profiles.</p>

Limitations
<p>(Service Cloud Case ID: 01071731) When you open a CSV or TXT file, read data from that file, and write the data from a Table type variable to the file, the bot fails with an error if the CSV or TXT file contains large data sets. Also, Create folders/files if it doesn't exist and Override existing file check boxes are selected in the Write to file action.</p> <p>Workaround: Perform one of the following:</p> <ul style="list-style-type: none"> • In the task, when you use the Open action for a CSV or TXT file, select the Contains header check box to prevent your bot from failing. • Use the Excel advanced Open action to open a CSV file and then use the Write from data table action to write data into the file.
<p>(Service Cloud case ID: 00793818) If you edit a large number of schedules simultaneously (for example, more than 40) in the Control Room from the Scheduled activity page, the schedules will not be activated.</p> <p>Recommendation: Use the edit option for each schedule to avoid overwhelming the scheduler.</p>
<p>(Service Cloud case ID: 00805571) When the Bot Agent is automatically updated for Cloud deployments, the status of the Bot Agent flickers (changes) between Connected and Updating on the Devices page. The Bot Agent logs indicate that the auto-update process is initiated, but the device does not connect to the WebSocket server.</p> <p>Workaround: Delete the local database file <code>AA-DB.mv.db</code> from <code>C:\Windows\System32\config\systemprofile\AppData\Local\AutomationAnywhere</code> and restart the Bot Agent service. If auto-update is enabled in the Control Room settings, the Bot Agent will be updated automatically. Note that if the setting is disabled, you have to update the Bot Agent manually.</p>
<p>If a device or Bot Agent service restarts when you are running bots, the bots are shown as Active in the Activity page instead of Failed because of response schema changes in the product.</p> <p>Workaround: Delete the <code>AA-DB.mv.db</code> file from <code>C:\Windows\System32\config\systemprofile\AppData\Local\AutomationAnywhere</code> and restart the Bot Agent service. The deployments stuck in Active state will be moved to the Historical page and will be marked as Failed so that subsequent deployments can continue to run.</p>
<p>Intermittent issues occur with the execution of scheduled bots where some existing schedules behave inconsistently or some newly created schedules disappear. The new feature to set the priority to High has been reverted to address this occurrence. For users who have used this feature in Build 9637 or earlier and have updated to Build 9664, the schedules work without the relevance of the priority setting.</p> <p>Workaround: If you encounter these issues, split large scheduled automation to smaller schedules of 2 hours each to run throughout the day. For example, reconfigure an automation that is scheduled for a 12-hour period such as 9 AM to 9 PM daily to two-hour intervals such as 9 AM to 10:59 AM, 11:00 AM to 12:59 PM, and 1:00 PM to 2:59 PM. We strongly recommend that you use 2-hour intervals in such deployments. Further recommendations for schedules and time intervals: any schedules with a lower time frequency (< 10 minutes) should be spaced out to at least 10 minutes (Service Cloud case ID 00792385, 00785679, 00795915, 00793147, 00794555).</p>

Limitations
<p>Known behavior for configured ports on multiple instances</p> <p>When you install the Control Room and configure the database, the ports for multiple instances should match the TCP ports configured in TCP/IP properties. For example, for the first instance if the configured TCP port is 1434 and for the second instance the configured TCP port is 1435, ensure you add 1434 as the port for the first instance and 1435 as the port for the second instance during Control Room installation.</p>
<p>The Universal Recorder has the following limitations when capturing objects in Electron apps:</p> <ul style="list-style-type: none"> • The Check action in a check box is not currently supported. Workaround: Use Toggle, Click, or Left click instead. • The Universal Recorder cannot capture tabular data. Workaround: When the Universal Recorder captures an object control of <code>Client</code>, select the GetAllChildrenNames action and store the data to a list variable. • The Universal Recorder might capture the window containing Microsoft Teams as a Client technology, instead of the intended object. Workaround: Close and reopen Microsoft Teams. • The Universal Recorder only supports object capture from Electron apps in a computer that has the display scale configured to 100% or has a DPI awareness setting.
<p>If the maximum number of allowed activeMQ connections is exceeded, an AMQ failure can occur when running a RunTask automation that is looped 5 times, with each loop running 20+ bots after the fourth loop.</p>
<p>External key vault</p> <p>The Create/Edit User configure options still include the field permitting the administrator to enter the device credentials for the user. When auto-login is configured for the external key vault, these fields are still viewable and appear editable; however, the credentials added have no effect on the auto-login credential retrieval from the external vault.</p>
<p>You might observe an increase in CPU usage by about 10 percentage when the Control Room is in an idle state (Service Cloud case ID 00801733).</p>
<p>When you update the Control Room on Linux from Automation 360 v.19 or v.20 to Automation 360 v.21, the Control Room continues to display the interface from the previous version. Workaround: Refresh the browser to load the user interface in the new version.</p>

Automation Anywhere Robotic Interface (AARI)

What's new
<p>AARI Assistant for attended Bot Runners</p> <p>The AARI Assistant application enables users with the attended Bot Runner license to access their bots without logging in to the Control Room. AARI web users can use the AARI Assistant when the attended Bot Runner license is enabled along with their AARI User license without impacting their existing functionality.</p> <p>About AARI Assistant</p>

What's new
<p>Download, delete, or view files in browser in initial forms or tasks</p> <p>Users can now use the Select File element to download files that are uploaded to the initial forms or tasks, and they can also delete files or access the hyperlink file to view the file in within the browser. The uploaded file can be accessed as a hyperlink, and new icons are available for download and delete.</p>
<p>Enhancement to team roles</p> <p>The AARI team consists of three roles:</p> <ul style="list-style-type: none"> • Member: Can create, view, and delete their own requests. All the tasks are automatically assigned to the member when they create the request in a private team. In a shared team, the member can assign tasks to other members. • Owner: Can create, view, delete, and assign all the requests from the members in the team. • Admin: Can create, view delete, and assign all the requests from the members in the team. The admin can also modify the team. <p>An AARI admin or manager can edit their teams and update their team members' roles. They also have the option to add or remove team members. The AARI manager is the team admin by default when they create a team.</p>
<p>Enhancement to creating requests</p> <p>A request can now be created either by a user or by a bot in the Edit Process page.</p> <ul style="list-style-type: none"> • Choose the by user option to view the process in the Processes page. • Choose the by bot option so that the request is created either by a bot or by another process using the Process Task. <p>You cannot view the process or create a request with this option. Because the request is created from within a team, specify the default team in the Default team to take the bot created request field in the Edit Process page.</p> <p><i>Assign an AARI team to a process</i></p>
<p>Assign to me feature in tasks</p> <p>When a task is unassigned and users access the tasks, use the Assign to me option to allow the tasks to be assigned to the current user so that they can immediately access the form.</p> <p><i>Assign or unassign a task</i></p>
<p>New Bot page</p> <p>When AARI team members with attended Bot Runner licenses access the web interface, they are automatically redirected to AARI Assistant. Users can view all the bots created by them on this page. They can also pin, search, and sort their assigned bots.</p>
<p>New team reference in Request and Process pages</p> <p>The user can now reference the team from which a request is created by referring to the new Team column in the Request page or the team name added in the process tile in the Process page, to help guide their team assignment.</p>

What's new
<p>New Request Visibility field (Service Cloud case ID: 00718119)</p> <p>Request visibility enables users to allow or restrict access to a request they created to other team members. When the Request Visibility field is set to Shared, all the requests are accessible by all members, owners, and team admins. If the field is set to Private, the requests are available only to the user who has created the request, owner, and the team admin.</p>
<p>Enhancement to the Processes page</p> <p>The following enhancements are available on the Processes page:</p> <ul style="list-style-type: none"> • Sort the processes by name, in ascending or descending order. • Toggle the pinning of a process. • Use the responsive view to adjust the display to the screen size.
<p>Cloud storage usage</p> <p>Based on the maximum file and storage sizes, users who upload files can use cloud storage. The quota for storage is as follows:</p> <ul style="list-style-type: none"> • The size of the file uploaded using the Select File element cannot exceed 25 MB. • By default, the storage can store a maximum of 100 MB of data. • It is extended to an additional 1 GB for every AARI user license allocated.
<p>Copy process to URI feature</p> <p>The AARI admin can use the new Copy process to uri to clipboard feature in the Process setup page to obtain the URI data and share with team members as reference when they enter the URI data to the Create a Request action.</p> <p><i>AARI Web package</i></p>
<p>Add rows from header row context menu</p> <p>Only the header row is displayed when a form that has a table is launched during bot runtime. Use one of the following methods to add new rows to the table:</p> <ul style="list-style-type: none"> • Header row context menu of the table <p><i>Using the Table element</i></p> <ul style="list-style-type: none"> • The Set action in a bot <p><i>Using Set action</i></p>
<p>Support for interface triggers on Google Chrome</p> <p>Interface triggers are now supported on the Google Chrome browser for the following actions during bot runtime:</p> <ul style="list-style-type: none"> • When you click a button element in a form • For Got focus and Lost focus actions in a text box • When a preconfigured hot key is used with the Got focus action in a text box <p><i>Add an interface trigger</i></p>

What's changed
<p>Upgrade changes to teams and processes</p> <p>For users who had access to processes, when they upgrade to the latest Automation 360 version, their existing teams remain the same but is now set to a shared team type, regardless of their existing team assignment. AARI users and managers, are now converted to member and admin team roles, respectively. While any existing processes assigned to your team are shown as Team Migrated for Process after the upgrade.</p> <p>For AARI managers (process manager) who could create requests without assigning process to teams. After the upgrade, the AARI managers must create teams, ask the AARI admin to assign teams to a process in order to create new requests.</p> <p>Processes have the by user option set by default for teams to view a process. You must choose the by bot option to have request be created by bots or another process.</p> <p><i>Using AARI on the web interface Assign an AARI team to a process</i></p>
<p>Update to Auto Assign feature</p> <ul style="list-style-type: none"> • In the Human Task, you can no longer use the auto-assign feature to assign the task automatically to the manager. You can auto-assign the task to the user who created the request. • The option to assign the target task to the manager is now removed from the Go to element. <p>You can now override the previous auto-assign setting by selecting the Override task assignment setting option in the Go to panel by either unassigning the task or assigning the task to the user who created the request.</p>

The following table lists the fixes and the builds in which they were fixed. Build 9664 is the latest build for Cloud and includes fixes from the previous builds (including Build 9604). On-Premises is on Build 9664.

Fixes		
Build	Service Cloud case ID	Description
9664	00788255	After upgrading from v.19 to this release version, processes containing forms with the Table , Checkbox , or Text Box element now execute successfully. Previously, if the process contained a form with an empty table, check box, or text box, it failed during execution if no changes were made in the form.
9664	00772925	The layout of the request view page no longer changes when the user selects a language other than English.
9664	00781891, 00784947	Warning texts in the process editor now render correctly with UTF-8 encoding.
9664	--	Users with the attended license are now correctly redirected to the AARI Assistant application when they log in from the same device where a user without the attended licenses tried to access the application beforehand.

Fixes		
Build	Service Cloud case ID	Description
9604	00765406	When you enter more than four number values with a comma in a Number element field in the initial forms or tasks, the field can now accept the large number value without issues.
9595	00719862	In the Team Setup page, you can now view the members of your team and check if the member count is consistent with the number of team members.
9595	00738934	Users can now view, upload, download, or delete their files when they add the Select File element to forms to complete tasks in the web interface.
9595	00767008	When you upload a file with the Select File element in your tasks, the bot now downloads your file through the Get Storage file action without issues.
9595	--	Long text for the label name of Radio button and Checkbox elements in a form is now displayed completely.

Limitations
<p>(Service Cloud case ID: 00831376) When you use the storage service to upload or download files from the web interface, the download is redirected to an AWS and GCP presigned URL. You will not be able to download files unless you whitelist the AWS and GCP URLs.</p> <p>Workaround: You must whitelist the following URL in order to download:</p> <ul style="list-style-type: none"> • AWS: <a href="https://<bucket-name>.s3.<region>.amazonaws.com/">https://<bucket-name>.s3.<region>.amazonaws.com/ • GCP: <a href="https://storage.googleapis.com/<bucket-name>/">https://storage.googleapis.com/<bucket-name>/
<p>(Service Cloud case ID 00789181) When a bot is deployed in AARI and the deployment is not completed even after an hour, the bot fails and the status changes to <i>failed</i> in AARI. However the same bot still executes in the Control Room.</p> <p>Workaround:</p> <p>Choose one or both of the following options:</p> <ul style="list-style-type: none"> • Define an adequate duration for your bot execution. • Increase the size of your device pool.
<p>For On-Premises, when you log in to AARI Assistant application as a non-attended user, it shows an error as expected. However if you use that same credentials, or credentials from another non-attended user, and log in again to the application, it takes you to the web interface page.</p> <p>Workaround:</p> <ol style="list-style-type: none"> 1. Log in to the AARI Assistant application as an attended user. 2. First, log in to the web interface (<code>aari/#/assistant</code> URL) then log out without changing anything in the browser. Second, navigate to the AARI Assistant application on your desktop and log in as an attended user.

Limitations
<p>The Teams column in the Process setup page is not automatically updated when the AARI admin adds or removes their team in a process.</p> <p>Workarounds: Use the following options on the Process setup page:</p> <ul style="list-style-type: none"> • Click the Refresh the list option. • Click the browser's refresh option to reload the page. • Navigate to another tab then return to this page.
<p>When you use the Process Task in the process editor, you cannot use the Public folder option in the Select process file field because adding a public process as a dependency to the private process is not supported.</p>
<p>When users use the Image element to render images, the images does not render external images in the request view when users run their tasks.</p>

Discovery Bot

What's new
<p>Sort for a process tile from the Processes page</p> <p>You can now use the sort field to help you locate a process tile quickly. From the Processes page, use the drop-down menu to sort on a process tile based on the process name in alphabetical order. Alternatively, you can sort in the order of the newest process created to the oldest process and vice versa.</p> <p>Create a Discovery Bot process</p>
<p>Enhancements to opportunities</p> <p>You can now review and analyze automatically generated (or system-generated) opportunities immediately from the Opportunities page. Auto-generated opportunities are created when at least two recordings are approved by the user. You can create a custom opportunity from an auto-generated opportunity and apply the Model and Filter options to target a specific opportunity for automation.</p> <p>You can now prioritize opportunities based on a simple formula for all recordings in a process. From the Opportunities table, you can view the cost without automation and savings for an opportunity. The system automatically calculates the cost and potential savings for each opportunity generated. You can customize these metrics based on your organization's model for cost and savings.</p> <p>Review opportunities and convert to bot</p>
<p>Generated PDD files are available on your local server</p> <p>The generated PDD file for an opportunity is now stored locally on your server for On-Premises deployments. The existing PDD files are automatically moved to the new location and are not deleted when a re-installation or upgrade is performed in the Control Room.</p> <p>Prerequisites for Discovery Bot</p>

Fixes	
Service Cloud case ID	Description
--	Double-click, drag-drop, click and hold, and text select are now supported when you are recording a business process.
--	When you record a process with more than 1000 steps, the Recordings page now displays the process without any delay. Previously, the Recordings page took some time to load.

Limitations
The Control Room installer for Red Hat Enterprise Linux (version 7.7 or 7.9) does not include the Discovery Bot package.
Workaround: Log in to the Control Room as an admin, select Manage > Package > Upload and upload the Discovery Bot package. The package is included in the list of default packages.
<ul style="list-style-type: none"> • Cloud users: When an opportunity is created with 50 steps, the Download PDD option is disabled and the PDD is not available for download. • On-Premises users: When an opportunity is created with 100 steps, the Download PDD option is disabled and the PDD is not available for download.

IQ Bot

What's new
<p>IQ Bot standard forms</p> <p>Create learning instances using the standard forms, which use an existing pretrained model and classification for extracting a large number of data fields from structured documents that typically have less or no variations in the layout.</p> <hr/> <p>Note: Standard forms are currently available only as a beta feature.</p> <hr/> <p><i>Using IQ Bot for standard forms</i></p>
<p>Additional learning instances for IQ Bot Process documents action</p> <p>Use the new Azure 3.2 and japanese_Tegaki learning instances for the IQ Bot Process documents action in the IQ Bot Extraction package.</p> <p><i>Using IQ Bot Process documents action</i></p>

<p>What's changed</p>
<p>IQ Bot file paths</p> <p>File locations and folder names are updated to use the new product name. For example:</p> <ul style="list-style-type: none"> • The default installation path is changed from <code>C:\Program Files (x86)\Automation Anywhere IQ Bot A2019\</code> to <code>C:\Program Files (x86)\Automation 360 IQ Bot\</code>. • The default log path is changed from <code>C:\Users\Public\Documents\Automation Anywhere IQ Bot A2019</code> to <code>C:\Users\Public\Documents\Automation 360 IQBot Platform</code>.
<p>Provider column on Learning Instances page updated</p> <p>The Provider column in the Learning Instances > My learning instances page is now updated to display a list of all available OCR engines associated with the corresponding learning instance.</p>
<p>Enhancements to IQ Bot Extraction package</p> <p>IQ Bot Extraction package now supports the following OCR engines:</p> <ul style="list-style-type: none"> • Microsoft Azure Computer Vision OCR engine 3.2 This significantly improves the OCR extraction from Chinese language documents. • Tegaki API OCR engine <p><i>IQ Bot Extraction package</i></p>
<p>Enhancement to IQ Bot security (Service Cloud Case ID: 00677507)</p> <p>You can now further improve security in IQ Bot by configuring RabbitMQ v3.8.18 communication through a secure SSL/TLS channel. Set <code>secureRabbitMQCommunication = true</code> in the <code>system.properties</code> file and then restart all IQ Bot services, including RabbitMQ v3.8.18. By default, this flag is set to <code>false</code>.</p> <p>This enhancement also fixes an issue that caused a RabbitMQ v3.8.18 security vulnerability.</p>
<p>Reuse the name of a deleted learning instance Automation 360 IQ Bot On-Premises</p> <p>While creating or editing a new learning instance, you can now reuse the name of a learning instance that was deleted. Ensure you backup the documents in your Output folder before deleting a learning instance. You can then clear the documents of the Output folder before creating or editing a new learning instance with the same name.</p> <p>If you have not cleared the documents from the Output folder for the deleted learning instance, you cannot download the contents. However, you can download only the documents processed by the new learning instance.</p>
<p>Support for Microsoft Azure SMB</p> <p>IQ Bot now supports Microsoft Azure files storage system using the SMB (Server Message Block) protocol. You can now also install IQ Bot using the shared folder configured with SMB and access the output files from the same directory.</p>

What's changed
<p>Switch between databases without re-installing IQ Bot</p> <p>You can now switch between configured databases without re-installing IQ Bot using the <code>SwitchDBServer.bat</code> utility.</p> <p>To use this utility, perform the following steps:</p> <ol style="list-style-type: none"> 1. Download and extract the <code>SwitchDBServer.bat</code> utility from the <code><IQBot installation Dir>\Configurations</code> folder, and then open the command prompt in this directory. 2. Run the batch (.bat) file with an IP address or hostname of the destination DB server. <p>Example: <code>SwitchDBServer 171.xx.xx.11</code></p>

The following table lists the fixes and the builds in which they were fixed. Build 9642 is the latest build for On-Premises and includes fixes from the previous build.

Fixes		
Build	Service Cloud case ID	Description
9596	00777932, 00766332	While you update to this IQ Bot release, the output path from the previous version is now retained during installation.
9595	00686444	When exporting learning instances from one environment to another, IQ Bot now updates the <code>visionBotId</code> in the exported data. So you can now edit bots in the destination environment without any errors.
9595	--	Duplicate table row entries in the Validator are now significantly reduced due to the improved table extraction logic.
9595	00651057	IQ Bot can now connect to Control Room Ignite cache without any errors. This fixes an issue where all learning instances were not displayed.
9595	00616038	When you update or restart Control Room, error messages are no longer displayed when you use the link or click Explore IQ Bot to open IQ Bot.
9595	00668412, 00644948, 00717414	When you now upload a document in production, deadlocks no longer occur in the system and documents are correctly sent to the Validator.
9595	00651572, 00650959	If no files are available in the <code>Output \Successful</code> folder and you click the Download all documents action, IQ Bot now displays the correct error message.
9595	--	Documents in Chinese (Simplified) language are now processed successfully without any issues.

Fixes		
Build	Service Cloud case ID	Description
9595	--	If you add a blocked library to a custom Python logic and click Test Run for any field, an error message is no longer displayed on the Designer page.
9595	--	The Enterprise 11 IQ Bot command can now be migrated to the Upload Documents action in Automation 360 IQ Bot. Therefore, you no longer have to manually create bots when you migrate the learning instances.

Limitations
<p>IQ Bot Cloud: If you do not access IQ Bot within the configured Ideal time out value set on the IQ Bot server:</p> <ul style="list-style-type: none"> • A message to restart IQ Bot is displayed. • Bots using IQ Bot APIs fail when the server is restarted. <p>Refresh the IQ Bot web page after some time (more than 5 minutes) to log in to IQ Bot.</p>
<p>When you create a learning instance, if the PDF that you upload contains small fonts, the document is classified as an image. If you use the PDFBox OCR to create a learning instance for a multipage document, the segments are not displayed.</p> <p>Workaround: Turn off the PDFBox OCR.</p>
<p>For a standard forms learning instance, when you try to download output files and at the same time send frequent API requests to that database, the system might stop responding.</p> <p>Recommended: When using the standard forms learning instance, wait for the files to be downloaded. After the download, ensure you allow some time (> 60 seconds) between the API requests.</p>
<p>If an incorrect configuration is used to create the <code>providerVersion</code> file of a standard forms learning instance, an error message is displayed when you move this learning instance to production.</p> <p>Note: Ensure you use valid configurations.</p>
<p>If you use a bot associated with a standard forms learning instance to upload a large number of documents, some of the documents are not processed.</p> <p>Workaround: Because this issue might be caused due to a timeout, try to upload the documents after some time.</p>
<p>If you have used an earlier version of IQ Bot (11.x) to move documents to the Validator, you cannot download these documents when you migrate to this Automation 360 IQ Bot version.</p> <p>Workaround: If you are migrate to this version, ensure you clear all the documents in Validator.</p>
<p>When you use the Download all documents or Upload Document actions from the IQ Bot package, the upload and download can fail as the proxy settings specified in the Control Room are not used.</p>

Limitations
<p>If you manually delete any <code>.csv</code> file from the <code>Success</code> folder, other files in the folder might not be downloaded when you use the Download option.</p> <p>Ensure you do not manually delete any files from the <code>Success</code> folder.</p>
<p>Only SQL authentication is supported when you use the Migration Assistant tool to migrate from IQ Bot 11.x to Automation 360 IQ Bot.</p>
<p>If you have a document with a large number of pages (> 100), an error message is displayed intermittently when you click See extraction results for an existing learning instance.</p>
<p>The unclassified documents count in Staging results and Production results in the Summary tab of a learning instance might be displayed incorrectly.</p>
<p>On the Validator screen, if incorrect values are used to update a field on which you have applied validations, an alert is not displayed when the focus is lost from that field.</p>
<p>If any of the available number fields include parenthesis or (), the selected system identified region (SIR) on the document panel changes to a hyphen (-) when you click the extracted value.</p>
<p>If you use the name of a deleted learning instance when creating a new learning instance, both the instances are listed in the Learning instance name drop-down menu of the Upload document action when a bot is created.</p> <p>Workaround: Click the new learning instance to remove the old learning instance from the list.</p>
<p>If you use the Tesseract4 OCR during IQ Bot Extraction package updates, there is a delay in the document processing time and throughput results.</p>
<p>For a learning instance created with standard forms, if the extraction is not successful for the Field options > Optional field, the value set in Default value is not assigned to that form field.</p> <p>Workaround: Use Python script from the Logic tab to set the value that must be assigned as the Default field.</p>
<p>(Service Cloud case ID: 00601790) For documents processed using the IQ Bot Extraction package, document details such as Documents processed and Pages uploaded are not displayed correctly in the Dashboard page.</p>
<p>As the Preview2 version of the Microsoft Azure 3.2 is deprecated, if you have used the Microsoft Azure 3.2-Preview2 OCR engine to create a learning instance, the documents will be unclassified.</p> <p>Workaround: Ensure that you replace all occurrences of Microsoft Azure 3.2-Preview2 with Microsoft Azure 3.2:</p> <ul style="list-style-type: none"> In <code>Azure3OCREngineSettings.json</code> file, change Version: v3.2-preview.2 to Version: v3.2. You can then update the OCR engine version by uploading this file to database using API How to change OCR Settings in IQ Bot (A-People login required) In the IQ Bot Installation > Configurations folder, update <code>Azure3ContainerOCREngineSettings</code> with Microsoft Azure 3.2. This is for the containerized deployment of Microsoft Azure 3.2 OCR engine.

Limitations

(Service Cloud case ID: 00799842) When you process vector-based PDF documents in IQ Bot, the OCR results are sometimes inaccurate. For instance, in some cases, spaces between words are missed in the extracted data. This might happen because of reasons related to the document that you uploaded or the tool that you used to generate the PDF file.

Workaround: To process your vector-based PDF document successfully, perform either of the following steps:

1. Convert your vector-based PDF document again to a vector-based PDF document by using a tools such as Adobe Acrobat.
2. Convert your vector-based PDF documents to a raster file format, such as TIFF.

Important: For information about the packages supported with this release, see [View package versions available in the Control Room](#).

Enterprise A2019.20 Release Notes

Release date: 20 April 2021

Review what's new and changed, and the fixes and limitations in the Enterprise A2019.20 release. Build 8846 is for Cloud and Build 8815 is for On-Premises. IQ Bot A2019 is on Build 8815.

Important: We have updated the Cloud build to include the following fixes:

- Migrated bots failing to execute due to preprocessing error (Service Cloud case ID 00760877, 00761211)
- Unable to deploy bots because the resource path exceeds the maximum length supported by Microsoft (Service Cloud case ID 00764731, 00763373, 00765172, 763334)

- **Migration**

[11.x and 10.x](#) | [11.x only](#)

- **Enterprise A2019**

[What's new](#) | [What's changed](#) | [Fixes](#) | [Limitations](#)

- **AARI**

[What's new](#) | [What's changed](#) | [Fixes](#) | [Limitations](#)

- **Discovery Bot**

[What's new](#) | [What's changed](#) | [Fixes](#) | [Limitations](#)

- **IQ Bot**

[What's new](#) | [What's changed](#) | [Fixes](#) | [Limitations](#)

- **Bot Insight**

[What's new](#)

Updating to this release

You can update to this release from the previous three releases (that is, from $n-3$ releases, where n refers to the latest release). The following builds are certified for update to this release:

- Build 8147 (v.19)
- Build 7560 (v.18)
- Build 7103 (v.17)

For details on how to update, see [Update to latest Automation 360 version](#).

Recommendation: If you are not on an $n-3$ release, update to one of the three certified releases before updating to this release.

Bot agent update: This release includes a required update to your . Ensure that you complete the update to continue with your automation activities when upgrading from a previous release to this release.

[Automatically update the Bot Agent](#) | [Manually update the Bot Agent](#)

To verify which version is compatible with this release, see [Compatibility with Automation 360 builds](#).

Migration features

Enterprise 11 and Enterprise 10 features
<p>Select folders for migration (Service Cloud case ID: 00689307)</p> <p>In the Bot Migration Wizard, you can now select folders that contain bots (TaskBots and MetaBots) that you want to migrate to Enterprise A2019. As a result, you no longer have to migrate individual bots from that folder.</p>
<p>Migrate MetaBots with screens</p> <p>Migrate MetaBots that contain screens as assets. You can migrate screens based on HTML, MSA, Java, .Net technologies and use credential variables.</p>
<p>Migrate bots with the following attributes</p> <ul style="list-style-type: none"> • Bots that contain the IF > Logic successful or IF > Logic unsuccessful command and these commands return a variable as output • Bots that contain the Run Task command with the Repeat until I stop it option to the Run action in the TaskBot package • Bots that use the \$Clipboard\$ system variable as input and output variables to pass the value to the MetaBot logic

Enterprise 11 only features
<p>Migrate bots that use SAP BAPI to automate SAP-related tasks</p> <p>Migrate bots that use SAP BAPI to automate the SAP-related tasks. The SAP commands are migrated to equivalent actions of the SAP BAPI package, and the username, password, and hostname attributes used to connect to the SAP server in the Enterprise 11 bots are migrated as credential variables in Enterprise A2019.</p>

Enterprise 11 only features**Retain legacy behavior of \$Excel Cell Row\$ system variable**

Use the **Use "Excel Cell Row" legacy behavior** option in the Bot Migration Wizard to retain the legacy behavior of the \$Excel Cell Row\$ system variable used in bots created in versions earlier than Version 11.3.1 after they are migrated to Enterprise A2019.

Migrate bots with the following attributes:

- Bots that use the **Delete** or **Get All Messages** command to delete or download attachment from all emails that use Exchange Web Services (EWS) using OAuth authentication.
- Bots that contain objects captured using the Object Cloning command that are based on Firefox and Silverlight technologies
- Bots that use the **Modify user** command with the **Update Account Options** and the **Change Password** option in the Active Directory command
- Bots that use the **Create user** option in the Active Directory command
- Bots that use the Variable Operation command and the **Decimal configuration** option is selected
- Bots that use the \$AATaskExecutor\$ system variable
- Bots from Version 11.3.5 or later that use the **Get Single Cell** command with the **Specific cell** and **Get Cell Value** options selected to retrieve value from a cell in a Microsoft Excel file.

Enterprise A2019

What's new**Support for IPv6 addresses**

You can install Enterprise A2019 in distributed load balancer cluster mode in an IPv6 network to comply with your organization's infrastructure and information security requirements.

The following are not supported:

- Geo location is not available for IPv6 addresses.
- Link-local addresses for IPv6 addresses are removed from the Enterprise A2019 installer's IPv6 list.

[Configure IP cluster](#)

Switch device registration between Control Room instances

You can now switch your device registration between multiple instances of the Control Room without reinstalling the Bot Agent. This setting is applicable to single user devices installed at the system or user level.

[Switch device registration between Control Room instances](#) | [Switch Bot Agent to a different Control Room](#)

New permission to attest device user name (Service Cloud case ID: 00576058)

Use the new permission to assign a default device to a user name to bypass credential validation when you deploy a bot on unattended Bot Runners. The permission is applicable to default device users with an unlocked and active user session.

[Feature permissions for a role](#)

What's new
<p>Resource threshold settings to optimize bot deployments</p> <p>Configure resource threshold settings in the Control Room so that the system deploys the next bot only when the system resources on the device are within the specified thresholds. Specify the settings at the Control Room level for all devices, and customize these settings at each device level.</p> <p>Customize device settings</p>
<p>Reduce bot startup time</p> <p>You can now reduce the bot startup time using settings in the Control Room to preload the most frequently used packages in the automation on all user devices when they connect to the Control Room.</p> <p>Automatic package updates for Cloud Control Room</p>
<p>Express queue in workload automation</p> <p>You can now quickly create workload automation queues with default parameters in the Control Room by using the Create express queue option in the Queues page.</p> <p>Create express queues</p>
<p>Group filters for Active Directory users</p> <p>You can provide additional filters for the <code>Users</code> directory as part of the <code>um.properties</code> file. As a result, you can filter the security groups that are in the <code>Users</code> directory for role mapping in the Control Room.</p> <p>Manage Active Directory role mapping</p>
<p>Automate SAP-related tasks using SAP BAPI</p> <p>Use the actions available in the SAP BAPI package to automate SAP-related tasks using SAP BAPI.</p> <p>SAP BAPI package</p>
<p>Default names for output variables</p> <p>When you configure an output variable for the following packages, the Control Room shows a descriptive default variable name. If you create several output variables, subsequent variable names are appended with a <code>-1</code>, <code>-2</code>, <code>-3</code>, and so on to avoid duplication.</p> <ul style="list-style-type: none"> • Browser • CSV/TXT • Email • Excel advanced • JavaScript • Loop • Recorder • VBScript • Window
<p>PDF split with blank pages supports scanned image documents (Service Cloud case ID: 00683923)</p> <p>Use the PDF Split action to separate a blank page from pages with scanned images. With pixel-based split, you can now use Split document to split a PDF with blank page separators for scanned (image-based) documents.</p>

What's new
<p>SMTP port range expanded to include ports 1 through 65535</p> <p>The Email package now supports ports in the range of 1 through 65535 for the SMTP server. You can use the Send email action by configuring the SMTP port in this range.</p>
<p>New actions in the Active Directory package</p> <ul style="list-style-type: none"> • Update account options: Sets account attributes for the user. • Change user password: Use this option to change a user's password. <p><i>User account operations</i></p>
<p>Enhancement to Create user action in Active Directory package</p> <p>You can now use the Create user action to create an Active Directory user with password.</p> <p><i>Using the Create user action</i></p>
<p>Universal Recorder expanded support and new features</p> <p>Use the Universal Recorder to perform the following:</p> <ul style="list-style-type: none"> • Automate clicks and data retrieval in drop-down lists and combo boxes in Oracle EBS applications such as Compass. • Link an object that the bot cannot reliably identify to a nearby object (such as a link or button) that is easier for the bot to find. Use this feature in MSAA, UI Automation, or Java applications.
<p>Support for new languages in variable names</p> <p>You can now use Czech, Danish, Dutch, Finnish, French, German, Hungarian, Italian, Norwegian, Polish, Portuguese, Romanian, Spanish, and Swedish characters in variable names.</p> <p><i>Unicode range supported in variables</i></p>
<p>Search and add child bot in the parent bot</p> <p>Search for a child bot in the public and private workspaces so that you can add it in the parent bot. You can search for the child bot from the Bot editor and the Run action of the Task Bot package.</p> <p><i>Using the Run action Bot editor for creating bots</i></p>
<p>Obtain information about user that deployed the bot</p> <p>Use the <i>AATaskInvoker</i> system variable to return the username, first name, last name, and email of the user that ran or scheduled the bot. If the bot is deployed to an attended Bot Runner, this variable returns information about the logged-in user. If the bot is deployed by a trigger, this variable returns information about the user who set the trigger.</p> <p><i>System settings and parameters</i></p>
<p>Git restoration enhancements</p> <ul style="list-style-type: none"> • If your database is deleted or corrupted, as an administrator you can now restore files from the Git repository to a repository that is not fully empty. • You can also overwrite or skip the files if you have duplicate files in the Git repository. • If you are restoring files in an empty repository, you can choose to use either your existing credentials (configured with Control Room) or the credentials of any other repository. <p><i>Restore bots from Git repository</i></p>

What's new
<p>View version history of TaskBots</p> <p>You can now view the version history of your TaskBots to identify relevant changes performed by other users to your TaskBots during a specific date and time along with the check-in messages.</p> <p>View TaskBot version history</p>
<p>External key vault support</p> <p>Use external key vaults to securely store and retrieve credentials using a third-party key manager such as CyberArk and AWS Secrets Manager. External Key Vault support for AWS Secrets Manager and CyberArk for Bootstrap (database credentials,) and System (Service account credentials, Active Directory service account credentials, and SMTP credentials).</p> <p>Integrate external key vaults</p>
<p>New condition in If package (Service Cloud case ID: 00536088, 00690073,00717514, 00737243, 00702383)</p> <p>Use the new Window with same title does not exist or Window with same title exist condition available in the If package to verify whether a window with the same title exists or whether the window title has changed.</p> <p>If package</p>
<p>Google packages are now generally available</p> <p>Google Calendar, Google Drive, and Google Sheets packages are now generally available in Enterprise A2019, with a major change to the authentication method:</p> <ul style="list-style-type: none"> • Each Google package contains a Connect action to authenticate your account before adding other actions from that package to your automation. This action replaces the deprecated OAuth action from the G-Apps package. • Each Google package contains a Disconnect action to terminate the connection. <p>Using the Connect action for Google packages</p>
What's changed
<p>Bots wait for Internet Explorer to fully render in Mouse package</p> <p>Bots (including bots migrated from Enterprise 11) that use the Mouse package now wait for the Internet Explorer to finish loading the page before executing the Click action. This prevents the bots from failing while the page is loading.</p>
<p>Interface change in the Edit variable window</p> <p>When editing a variable, if you deselect the Use as input, Use as output, or Constant (read-only) check box, a message now informs you of the impact of this change and requests you to confirm this update.</p>
<p>Enhancement to audit log entries (Service Cloud case ID: 00656155)</p> <p>The audit log entries are now enhanced to display the Item Name and Event Type for import, export, check-in, and check-out requests.</p>

What's changed
<p>The .atmx file not downloaded during migration</p> <p>The migration process does not download the <code>.atmx</code> file if the associated bot is used as a child bot in the parent bot. The Download CR file action from the File package is no longer added in the migrated bot to download the depended bot (<code>.atmx</code>) file during migration.</p>
<p>Option to either upgrade Recorder package version or downgrade to older Google Chrome extension</p> <p>Bots that use the Recorder package version 2.0.5 or older to automate in the Google Chrome browser, now need to be updated to use a Recorder package version that is newer than 2.0.5. This is only necessary for Bot Runner devices that have the new Google Chrome extension (ID:kammdlphdfejllopponbapgpbgakimokm) installed, and have not previously run bots that use the Recorder package version 2.0.5 or older.</p> <p>If you do not want to upgrade the Recorder package, you can manually install the old Google Chrome extension. See Google Chrome extension troubleshooting.</p>

The following tables lists the fixes and the builds in which they were fixed. Build 8846 is the latest build for Cloud and includes fixes from the previous builds. On-Premises is on Build 8815.

Build 8846	
Service Cloud case ID	Description
00764731, 00763373, 00765172, 763334	You can now deploy bots and dependent files stored in a repository with a file path that exceeds the maximum supported character length (256 characters) for your Windows operating system.
00714248	Only those Bot Runners and Bot Creators expressly configured as credential vault consumers for a given bot can use that bot.
00751728	When you migrate Enterprise 11 bots that use the String Operation command with the space character as a delimiter, the extracted value now retains the space and works properly. Previously, after migration, the space from the String Operation command was removed.
00760877, 00761211	Bots that are migrated, modified, and scheduled now successfully deploy without a preprocessing error. Previously, migrated bots failed to execute due to the following preprocessing error: <code>Attribute type ANY is not supported</code> .

Build 8840	
Service Cloud case ID	Description
00747869, 00750571, 0744918	When you create a bot using a loop with the Recorder Capture action to perform operations on the Chrome browser, the bot now executes without any disruption. Previously, the bot failed to run and displayed an error.

Build 8840	
Service Cloud case ID	Description
00733635, 00743082, 00750865	When you run a bot that contains the Excel Advanced > Find action, the found cell is now active and subsequent actions can perform operations on that active cell.
00723075, 00717920	When a bot encounters a workbook that contains links to cells in other workbooks, the system suppresses the Excel pop-up message so that the bot can run without interruption.
00746651, 00757879	After migrating bots, you can successfully run the bots without any preprocessing error. Previously, using variables inside brackets failed to process the task.
00742159, 00743092	The Excel Advanced Set cell and Delete cell actions now select the correct cells when the cell address column name contains more than one letter.
00743636	The Excel Advanced Set cell, Delete cell, and Go to cell actions now support all ranges. Previously, the actions encountered errors with ranges greater than AB1:AB100.
00726030	Bots can now use the Recorder to capture objects that contain characters that are not valid in XML.

Build 8815	
Service Cloud case ID	Description
00750668	A workload bot is no longer stuck in a queue, and the device does not display a <code>Pick up at run time</code> status.
00733227	Control Room database tables are now created when you use the restored 11.x database while installing Enterprise A2019.
00733720	Bot Migration Wizard no longer encounters an error when processing a large bot for migration. Previously, this issue was encountered when a large bot was downloaded to the Bot Runner device for migration from the Control Room and the connection between the Bot Runner device and Control Room was reset.
--	Bot Scanner is now updated to include scenarios that were previously failing after migration. As a result, some bots might be moved from the list of bots that can be migrated to the list of bots that cannot be migrated in the output report. This can decrease the number of bots that can be migrated to Enterprise A2019.

Build 8815	
Service Cloud case ID	Description
00703679, 00711398, 00729399	Enterprise 11 or Enterprise 10 bots that use the string variable or an object captured from Internet Explorer whose property is null or empty no longer encounters an error after these bots are migrated.
00667326	<p>Bot Scanner no longer becomes unresponsive when scanning bots for any of the following reasons:</p> <ul style="list-style-type: none"> • Scanning a corrupted .atmx file of a bot • Bots that contains the If, IF/ELSE, or Loop command and that command is commented out • Bot that contains an object that is captured using the Object Cloning command using the Coordinate play mode and the Click action is performed on that object
00731068, 00737025	An error is no longer encountered when you run a bot that contains multiple variables that return a number value in the same command after that bot is migrated.
00720261	An error is no longer encountered when you run a migrated bot that contains a special character.
00713303	In a migrated bot that uses the Run Task command, when you run a subtask within the main task and the subtask name contains Unicode characters, the bot now executes successfully without any error. Previously, the bot failed and displayed an error message.
00691133	You can now successfully delete migrated bots in your private workspace without encountering any issue. Previously, an error message was displayed when a migrated bot was deleted in the private workspace.
00736166	Previously, when the migration process was initiated, the process sometimes remained in the <i>In progress</i> status in the Bot Migration Wizard. Now the process starts running.
00730131	Bots that use the Run Script command with the \$Clipboard\$ system variable as an input or output variable no longer encounter errors when you run these bots after they are migrated to Enterprise A2019.
00726833	Enterprise 11 Work Items and queues that are associated with bots that use the Variable Operation command no longer encounter an error after the first item in the queue is processed successfully after migration to Enterprise A2019.

Build 8815	
Service Cloud case ID	Description
--	Bot Scanner no longer encounters an error when scanning MetaBots that contain the Object Cloning command that is commented out and the MetaBot is trying to find the play mode from those commented out commands.
00716557	An error is no longer encountered when you run a MetaBot in Enterprise A2019 that was created in Enterprise 10, migrated to Enterprise 11, and then migrated to Enterprise A2019.
00710569	When you migrate a MetaBot that contains screens as assets from Enterprise 11 to Enterprise A2019, Japanese characters in the object properties are now displayed correctly in the migrated bots. Previously, the Japanese characters in the object properties were garbled in the migrated bots.
00702262	The Historical activity page now shows a detailed error message that specifies the cause of the error and the line where the error is encountered for bots that are migrated from Enterprise 11 and use the Error Handling command.
00703513, 00708988	Parent bots that use the Run action of the Task Bot package with the Upon error, start next repetition option selected no longer encounter an error if their child bots encounter an error at runtime and do not return the output variable to the parent bot. Previously, parent bots encountered an error if the child bots did not return the output variable to the parent bots because the child bots encountered an error during runtime.
00702601	A bot that uses an array variable that contains a system variable and which returns an integer no longer encounters an error after that bot is migrated.
00707801	You can now migrate an Enterprise 11 bot that contains Mouse Click to capture the coordinates of a maximized window. Previously, the bot with a Mouse Click encountered an issue during migration because the window left and top parameters were set to negative values for maximized windows.
00710315, 00728228, 00729082, 00744242	Migrated bots that use the Object Cloning command with legacy technology to capture objects with multiple lines of text now work properly, without any issues.
00716650	When you migrate an Enterprise 11 bot that contains an Excel command with two Excel sessions in it, the Get column name or Get row number actions now displays the correct values in the output. Previously, the actions set the wrong session values in the migrated bot if it contained two Excel sessions.

Build 8815	
Service Cloud case ID	Description
00711148	Enterprise A2019 installation no longer fails if there is a space in the data and log path (for example, D:\Automation Anywhere\ProgramData). And, the following error message is no longer displayed: Control Room database tables fail to create.
00708902	You can now use the Google Drive package to upload files in the Google Shared Drive. Use only the Folder ID option to upload files to a shared folder in the drive and enter the ID of the shared folder. Previously, an error occurred when a user tried to upload a file in the shared folder in the Google Drive.
00735479	When you create a bot that has a dependency with a long repository path that exceeds the maximum limit of 256 characters and when you run the bot on the Bot Runner machine, the bot now displays a message, prompting you to reduce the length of the file path. Previously, the bot execution failed without any message providing the reason for the failure.
00727406	You can now successfully send an email in HTML format with an HTML attachment using the Email server . Previously, when an email was sent in HTML format along with an attached HTML file, the email body content and the content of the attached file were merged. As a result, only the attachment was seen in the mail without the body content.
00707734	In the App Integration package, when you use the Capture text of window action in a Japanese browser, the window title now displays properly for Japanese language. Previously, the output was not displayed correctly in the Japanese text format.
00699149,00707670	You can now use the Unzip action of the Folder package and execute your bots on a Windows 10 server. Now, if two Windows users with different device credentials try to deploy a bot on the same machine, the deployment does not fail. Previously, if a user deployed the bot on the same machine with a different user profile, the bot failed to execute.
00695224, 00730472, 00739431	When you use the Find Image in a Window action in the Image Recognition package, image files are now deleted from the Temp location and storage space is freed after bot execution. Previously, the image files were not deleted from the Temp location and as a result disk storage ran out of space.

Build 8815	
Service Cloud case ID	Description
00709162	The CSV/TXT Open action now works without encountering any issue even if there are blank values in the last row of the .txt file. Previously, if there were blank values in the last row of the file, the bot encountered an issue.
00711124	In the Email package, when you use the Connect action, add a loop, and select For each in mail box to read emails as the Iterator option, a new line is no longer deleted and correctly displays the email content. Previously, the new lines were deleted when the mail was sent and received in plain text format.
00673049	In the SAP package, if an error is encountered when the Connect action is used to connect with a SAP system, the error is now captured in the Try and Catch blocks. Previously, the connection issue was not captured in the Try and Catch blocks in the action.
00697215	A bot now executes successfully when you use the Throw action with an expression. Previously, when an expression such as <code>\$number.ToString\$</code> was used in the Exception message field of the Throw action, the bot encountered a preprocessing error.
00714260	Runtime errors are no longer displayed when you use the following: <ul style="list-style-type: none"> • A MetaBot with run DLL migration function that takes more than one parameter type as Array or any type other than String • A TaskBot with run logic calling a child bot that takes more than one input parameter of type Array, which is mapped to a List variable in the parent bot run logic migration function
00704547	The Pause action of the TaskBot package now works properly when you use it as the last task in the bot. Previously, the bot did not wait for the task to complete if the Pause action was used as last task in the bot.
00675344	A TaskBot now performs better when you use the Terminal Emulator Send text and Send key actions to execute a bot. Previously, the TaskBot took a long time to complete the execution.

Build 8815	
Service Cloud case ID	Description
00699650,00716648	When you use Image Recognition actions to execute a bot and if the bot fails during execution, the captured source and target images are stored in C:\ProgramData\AutomationAnywhere\BotRunner\Logs\IR with a maximum of 10 source and target image pairs. Now, when the maximum limit is reached, the oldest image pairs are overwritten with new images. Previously, the image logs were not overwritten.
00716817	A bot now executes successfully when you use the PDF Extract text action to extract structured text from PDF files. Previously, bot execution failed to extract structured text if it contained Thai characters.
00717204	You can now use a credential from the Credential Vault in the URI field of the REST Web Service actions.
00682726, 00678580, 00695359, 00684985	You can now use the Universal Recorder to automate in Oracle Fusion Middleware applications. Previously, an issue with the Java API caused the Recorder to select the entire window instead of the specific object.
00693770	Fixed an issue where numbers extracted from an SQL database to a data table variable were automatically converted to scientific notation.
00669959	You can now select the same start date and end date when you schedule bots with the Run repeatedly option (Activity > Scheduled > Schedule bot) in the Control Room.
00702841, 00700915	Disconnected devices are now displayed in the Control Room (Devices > My Devices) when you filter the devices list by Status as Disconnected .
00707318, 00711529	Work items in an active queue are now processed and you no longer have to delete the active queue and create another queue after you upgrade from a previous release to this release.
00705046	Bots that include embedded dependent files instead of a zipped folder are no longer queued intermittently for deployment on Bot Runner devices.
--	Disabled tenant IDs or removed tenants that are later reused on the same deployment with a different tenant might produce a licensing error. This conflict is now removed and deboarded tenants in later reuse no longer generate the error.

Build 8815	
Service Cloud case ID	Description
00685926	When you import an exported bot into the private workspace and check in the imported bot, the bot is now checked in successfully without any issues. Previously, the check-in failed due to a metadata validation error.
00682025	When a bot or a file is modified in the public workspace, the cloned dependent file in the private workspace now reflects the changes and the bot executes successfully. Previously, the cloned dependent file did not reflect the changes and the bot execution failed.
00726018	The Google Drive Upload file action now uploads files to subfolders.
00715080, 00731152	You can now perform concurrent unattended bot deployment on a multi-user device with multiple user sessions running simultaneously.
--	A non-admin Bot Agent user now remains connected to the Control Room and is not disconnected frequently.
00709737	Actions in the Google Sheets package now support worksheets that contain empty cells.
00710354	A hibernate exception error is no longer displayed when you log in to the Control Room as an admin user.
00732178	You can now check out bots from folders with similar names but in different letter cases and edit the bots in your private workspace in the Control Room. For example, if there is a folder named <code>Automation1</code> in the public workspace and a folder named <code>automation1</code> folder in the private workspace, you can now check out bots from the <code>Automation1</code> folder in the public workspace.
--	Bots are now deployed on a multi-user device in a non-admin user session when another admin user session is also active on the device if auto-login setting in the Control Room is set to lock the session after the bot finishes executing from an existing unlocked session.
00719407	During a cluster installation of Enterprise A2019 on Red Hat Enterprise Linux, the installer now uses the same user ID across all cluster nodes.
00703325	The log file permission for an Control Room installed on Linux now maps to the <code>crkernel</code> user. Previously, it was mapped to the root user.

Build 8815	
Service Cloud case ID	Description
--	When you access the Control Room with the Login with Windows option selected, you must now enter the FQDN to log in successfully.
00732141, 00722919,00743006	When you preload a package, after the download is complete, the completion status updates in the Activity > Historical activity page and the pending record is no longer displayed in the Activity > In progress page.
00731376	When you migrate MetaBot logic, if there is case mismatch in the variable name and the mapping variable, variables are no longer created twice. As a result, a preprocessing error does not appear when you execute the task.
	Now, the migration of run logic with CV variables is supported.
	Now, when using the Date system variable in the File folders command, a migrated bot is no longer failing.
	When migrating bots (v11.x to A2019) with OC properties more than 64KB, such properties will be truncated and the bot will be migrated.

The following table lists the fixes and the builds in which they were fixed. Build 8846 is the latest build for Cloud and includes fixes from the previous builds. On-Premises is on Build 8815.

Fixes		
Build	Service Cloud case ID	Description
8846	00764731, 00763373, 00765172, 763334	You can now deploy bots and dependent files stored in a repository with a file path that exceeds the maximum supported character length (256 characters) for your Windows operating system.
8846	00714248	Only those Bot Runners and Bot Creators expressly configured as credential vault consumers for a given bot can use that bot.
8846	00751728	When you migrate Enterprise 11 bots that use the String Operation command with the space character as a delimiter, the extracted value now retains the space and works properly. Previously, after migration, the space from the String Operation command was removed.
8846	00760877, 00761211	Bots that are migrated, modified, and scheduled now successfully deploy without a preprocessing error. Previously, migrated bots failed to execute due to the following preprocessing error: Attribute type ANY is not supported.

Fixes		
Build	Service Cloud case ID	Description
8840	00747869, 00750571, 0744918	When you create a bot using a loop with the Recorder Capture action to perform operations on the Chrome browser, the bot now executes without any disruption. Previously, the bot failed to run and displayed an error.
8840	00733635, 00743082, 00750865	When you run a bot that contains the Excel Advanced > Find action, the found cell is now active and subsequent actions can perform operations on that active cell.
8840	00723075, 00717920	When a bot encounters a workbook that contains links to cells in other workbooks, the system suppresses the Excel pop-up message so that the bot can run without interruption.
8840	00746651, 00757879	After migrating bots, you can successfully run the bots without any preprocessing error. Previously, using variables inside brackets failed to process the task.
8840	00742159, 00743092	The Excel Advanced Set cell and Delete cell actions now select the correct cells when the cell address column name contains more than one letter.
8840	00743636	The Excel Advanced Set cell, Delete cell, and Go to cell actions now support all ranges. Previously, the actions encountered errors with ranges greater than AB1:AB100.
8815	00750668	A workload bot is no longer stuck in a queue, and the device does not display a <code>Pick up at run time</code> status.
8815	00733227	Control Room database tables are now created when you use the restored 11.x database while installing Enterprise A2019.
8815	00733720	Bot Migration Wizard no longer encounters an error when processing a large bot for migration. Previously, this issue was encountered when a large bot was downloaded to the Bot Runner device for migration from the Control Room and the connection between the Bot Runner device and Control Room was reset.
8815	--	Bot Scanner is now updated to include scenarios that were previously failing after migration. As a result, some bots might be moved from the list of bots that can be migrated to the list of bots that cannot be migrated in the output report. This can decrease the number of bots that can be migrated to Enterprise A2019.
8815	00703679, 00711398, 00729399	Enterprise 11 or Enterprise 10 bots that use the string variable or an object captured from Internet Explorer whose property is null or empty no longer encounters an error after these bots are migrated.

Fixes		
Build	Service Cloud case ID	Description
8815	00667326	<p>Bot Scanner no longer becomes unresponsive when scanning bots for any of the following reasons:</p> <ul style="list-style-type: none"> • Scanning a corrupted <code>.atmx</code> file of a bot • Bots that contains the <code>If</code>, <code>IF/ELSE</code>, or <code>Loop</code> command and that command is commented out • Bot that contains an object that is captured using the <code>Object Cloning</code> command using the Coordinate play mode and the Click action is performed on that object
8815	00731068, 00737025	An error is no longer encountered when you run a bot that contains multiple variables that return a number value in the same command after that bot is migrated.
8815	00720261	An error is no longer encountered when you run a migrated bot that contains a special character.
8815	00713303	In a migrated bot that uses the <code>Run Task</code> command, when you run a subtask within the main task and the subtask name contains Unicode characters, the bot now executes successfully without any error. Previously, the bot failed and displayed an error message.
8815	00691133	You can now successfully delete migrated bots in your private workspace without encountering any issue. Previously, an error message was displayed when a migrated bot was deleted in the private workspace.
8815	00736166	Previously, when the migration process was initiated, the process sometimes remained in the <code>In progress</code> status in the Bot Migration Wizard. Now the process starts running.
8815	00730131	Bots that use the <code>Run Script</code> command with the <code>\$Clipboard</code> system variable as an input or output variable no longer encounter errors when you run these bots after they are migrated to Enterprise A2019.
8815	00726833	Enterprise 11 Work Items and queues that are associated with bots that use the <code>Variable Operation</code> command no longer encounter an error after the first item in the queue is processed successfully after migration to Enterprise A2019.
8815	--	Bot Scanner no longer encounters an error when scanning MetaBots that contain the <code>Object Cloning</code> command that is commented out and the MetaBot is trying to find the play mode from those commented out commands.
8815	00716557	An error is no longer encountered when you run a MetaBot in Enterprise A2019 that was created in Enterprise 10, migrated to Enterprise 11, and then migrated to Enterprise A2019.

Fixes		
Build	Service Cloud case ID	Description
8815	00710569	When you migrate a MetaBot that contains screens as assets from Enterprise 11 to Enterprise A2019, Japanese characters in the object properties are now displayed correctly in the migrated bots. Previously, the Japanese characters in the object properties were garbled in the migrated bots.
8815	00702262	The Historical activity page now shows a detailed error message that specifies the cause of the error and the line where the error is encountered for bots that are migrated from Enterprise 11 and use the Error Handling command.
8815	00703513, 00708988	Parent bots that use the Run action of the Task Bot package with the Upon error, start next repetition option selected no longer encounter an error if their child bots encounter an error at runtime and do not return the output variable to the parent bot. Previously, parent bots encountered an error if the child bots did not return the output variable to the parent bots because the child bots encountered an error during runtime.
8815	00702601	A bot that uses an array variable that contains a system variable and which returns an integer no longer encounters an error after that bot is migrated.
8815	00707801	You can now migrate an Enterprise 11 bot that contains Mouse Click to capture the coordinates of a maximized window. Previously, the bot with a Mouse Click encountered an issue during migration because the window left and top parameters were set to negative values for maximized windows.
8815	00710315, 00728228, 00729082, 00744242	Migrated bots that use the Object Cloning command with legacy technology to capture objects with multiple lines of text now work properly, without any issues.
8815	00716650	When you migrate an Enterprise 11 bot that contains an Excel command with two Excel sessions in it, the Get column name or Get row number actions now displays the correct values in the output. Previously, the actions set the wrong session values in the migrated bot if it contained two Excel sessions.
8815	00711148	Enterprise A2019 installation no longer fails if there is a space in the data and log path (for example, D:\Automation Anywhere\ProgramData). And, the following error message is no longer displayed: Control Room database tables fail to create.
8815	00708902	You can now use the Google Drive package to upload files in the Google Shared Drive. Use only the Folder ID option to upload files to a shared folder in the drive and enter the ID of the shared folder. Previously, an error occurred when a user tried to upload a file in the shared folder in the Google Drive.

Fixes		
Build	Service Cloud case ID	Description
8815	00735479	When you create a bot that has a dependency with a long repository path that exceeds the maximum limit of 256 characters and when you run the bot on the Bot Runner machine, the bot now displays a message, prompting you to reduce the length of the file path. Previously, the bot execution failed without any message providing the reason for the failure.
8815	00727406	You can now successfully send an email in HTML format with an HTML attachment using the Email server . Previously, when an email was sent in HTML format along with an attached HTML file, the email body content and the content of the attached file were merged. As a result, only the attachment was seen in the mail without the body content.
8815	00707734	In the App Integration package, when you use the Capture text of window action in a Japanese browser, the window title now displays properly for Japanese language. Previously, the output was not displayed correctly in the Japanese text format.
8815	00699149,00707670	You can now use the Unzip action of the Folder package and execute your bots on a Windows 10 server. Now, if two Windows users with different device credentials try to deploy a bot on the same machine, the deployment does not fail. Previously, if a user deployed the bot on the same machine with a different user profile, the bot failed to execute.
8815	00695224, 00730472, 00739431	When you use the Find Image in a Window action in the Image Recognition package, image files are now deleted from the <code>Temp</code> location and storage space is freed after bot execution. Previously, the image files were not deleted from the <code>Temp</code> location and as a result disk storage ran out of space.
8815	00709162	The CSV/TXT Open action now works without encountering any issue even if there are blank values in the last row of the <code>.txt</code> file. Previously, if there were blank values in the last row of the file, the bot encountered an issue.
8815	00711124	In the Email package, when you use the Connect action, add a loop, and select For each in mail box to read emails as the Iterator option, a new line is no longer deleted and correctly displays the email content. Previously, the new lines were deleted when the mail was sent and received in plain text format.
8815	00673049	In the SAP package, if an error is encountered when the Connect action is used to connect with a SAP system, the error is now captured in the Try and Catch blocks. Previously, the connection issue was not captured in the Try and Catch blocks in the action.
8815	00697215	A bot now executes successfully when you use the Throw action with an expression. Previously, when an expression such as <code>\$number.ToString\$</code> was used in the Exception message field of the Throw action, the bot encountered a preprocessing error.

Fixes		
Build	Service Cloud case ID	Description
8815	00714260	<p>Runtime errors are no longer displayed when you use the following:</p> <ul style="list-style-type: none"> • A MetaBot with run DLL migration function that takes more than one parameter type as Array or any type other than String • A TaskBot with run logic calling a child bot that takes more than one input parameter of type Array, which is mapped to a List variable in the parent bot run logic migration function
8815	00704547	The Pause action of the TaskBot package now works properly when you use it as the last task in the bot. Previously, the bot did not wait for the task to complete if the Pause action was used as last task in the bot.
8815	00675344	A TaskBot now performs better when you use the Terminal Emulator Send text and Send key actions to execute a bot. Previously, the TaskBot took a long time to complete the execution.
8815	00699650,00716648	When you use Image Recognition actions to execute a bot and if the bot fails during execution, the captured source and target images are stored in C:\ProgramData\AutomationAnywhere\BotRunner\Logs\IR with a maximum of 10 source and target image pairs. Now, when the maximum limit is reached, the oldest image pairs are overwritten with new images. Previously, the image logs were not overwritten.
8815	00716817	A bot now executes successfully when you use the PDF Extract text action to extract structured text from PDF files. Previously, bot execution failed to extract structured text if it contained Thai characters.
8815	00717204	You can now use a credential from the Credential Vault in the URI field of the REST Web Service actions.
8815	00682726, 00678580, 00695359, 00684985	You can now use the Universal Recorder to automate in Oracle Fusion Middleware applications. Previously, an issue with the Java API caused the Recorder to select the entire window instead of the specific object.
8815	00693770	Fixed an issue where numbers extracted from an SQL database to a data table variable were automatically converted to scientific notation.
8815	00669959	You can now select the same start date and end date when you schedule bots with the Run repeatedly option (Activity > Scheduled > Schedule bot) in the Control Room.
8815	00702841, 00700915	Disconnected devices are now displayed in the Control Room (Devices > My Devices) when you filter the devices list by Status as Disconnected .

Fixes		
Build	Service Cloud case ID	Description
8815	00707318, 00711529	Work items in an active queue are now processed and you no longer have to delete the active queue and create another queue after you upgrade from a previous release to this release.
8815	00705046	Bots that include embedded dependent files instead of a zipped folder are no longer queued intermittently for deployment on Bot Runner devices.
8815	--	Disabled tenant IDs or removed tenants that are later reused on the same deployment with a different tenant might produce a licensing error. This conflict is now removed and deboarded tenants in later reuse no longer generate the error.
8815	00685926	When you import an exported bot into the private workspace and check in the imported bot, the bot is now checked in successfully without any issues. Previously, the check-in failed due to a metadata validation error.
8815	00682025	When a bot or a file is modified in the public workspace, the cloned dependent file in the private workspace now reflects the changes and the bot executes successfully. Previously, the cloned dependent file did not reflect the changes and the bot execution failed.
8815	00726018	The Google Drive Upload file action now uploads files to subfolders.
8815	00715080, 00731152	You can now perform concurrent unattended bot deployment on a multi-user device with multiple user sessions running simultaneously.
8815	--	A non-admin Bot Agent user now remains connected to the Control Room and is not disconnected frequently.
8815	00709737	Actions in the Google Sheets package now support worksheets that contain empty cells.
8815	00710354	A hibernate exception error is no longer displayed when you log in to the Control Room as an admin user.
8815	00732178	You can now check out bots from folders with similar names but in different letter cases and edit the bots in your private workspace in the Control Room. For example, if there is a folder named <code>Automation1</code> in the public workspace and a folder named <code>automation1</code> folder in the private workspace, you can now check out bots from the <code>Automation1</code> folder in the public workspace.
8815	--	Bots are now deployed on a multi-user device in a non-admin user session when another admin user session is also active on the device if auto-login setting in the Control Room is set to lock the session after the bot finishes executing from an existing unlocked session.

Fixes		
Build	Service Cloud case ID	Description
8815	00719407	During a cluster installation of Enterprise A2019 on Red Hat Enterprise Linux, the installer now uses the same user ID across all cluster nodes.
8815	00703325	The log file permission for an Control Room installed on Linux now maps to the crkernel user. Previously, it was mapped to the root user.
8815	--	When you access the Control Room with the Login with Windows option selected, you must now enter the FQDN to log in successfully.
8815	00732141, 00722919,00743006	When you preload a package, after the download is complete, the completion status updates in the Activity > Historical activity page and the pending record is no longer displayed in the Activity > In progress page.
8815	00731376	When you migrate MetaBot logic, if there is case mismatch in the variable name and the mapping variable, variables are no longer created twice. As a result, a preprocessing error does not appear when you execute the task.
8815		Now, the migration of run logic with CV variables is supported.
8815		Now, when using the Date system variable in the File folders command, a migrated bot is no longer failing.
8815		When migrating bots (v11.x to A2019) with OC properties more than 64KB, such properties will be truncated and the bot will be migrated.

Limitations
<p>(Service Cloud case ID: 00822176) When you create an RDP session on multi-user devices and enter a custom port, RDP-based deployments will fail.</p> <p>Recommended: Use the default port 3389 for RDP sessions.</p>
<p>When you create a bot with Open and Close browser actions in a loop and select the Window option to close the selected tab, an error might occur when you execute the bot.</p> <p>Workaround: Use the Close action of the Window package instead of the Close action in the Browser package to close the window.</p>
<p>If you deploy bots using event triggers, and you install the Bot Agent on a device as a non-admin user for self or a local admin user, the Bot Agent will not be updated automatically. The device is will be shown as disconnected in the Control Room.</p> <p>Workaround:</p> <ol style="list-style-type: none"> 1. End the trigger listener Java process (javaw.exe) from the Task Manager. 2. Re-install the Bot Agent to reconnect the user device in the Control Room.

Limitations
<p>Configuring multiple IP addresses for Control Room nodes in a cluster is not supported during installation in On-Premises deployments. You must manually configure the primary IP address in the <code>cluster.properties</code> file.</p> <p>Add primary IP address for cluster Configure additional IP address for a new cluster node</p>
<p>Bot deployment on multi-user sessions is not supported for workload automation.</p>
<p>Using an Enterprise A2019.20 SDS On-Premises Control Room with an Enterprise A2019.19 SDS Cloud Control Room is not supported.</p>
<p>When you run a bot containing a Capture action that uses the anchor object feature, your device DPI settings must match the settings at which you configured the anchor object.</p>
<p>The Control Room does not allow hyphens and underscores to be used interchangeably when creating and calling global value names.</p>
<p>When you migrate an Enterprise 11 bot that uses Object Cloning command with Silverlight technology and execute that bot in Enterprise A2019, the bot might fail with an error due to a play reliability issue. The same play reliability is also seen in Enterprise 11 when you use Object Cloning command with Silverlight plugins.</p>
<p>For actions that use file input, when you select a network path using Browse, bot execution fails because the double backslash (\\) in the file location is replaced with a forward slash.</p> <p>Workaround: Do not use the Browse option to select the file location. Instead, manually enter the complete file path.</p>
<p>When a Bot Creator, attended Bot Runner or unattended Bot Runner user logs in to the Control Room from their Bot Agent machine and if the package download option is enabled, the package download takes priority, and bot deployment waits until the package download is complete. This occurs only when the package is downloaded for the first time.</p>
<p>When a bot runs an automation in the Microsoft Internet Explorer browser, the Microsoft API responsible for the browser delay might encounter an exception, causing the bot to fail and a Chrome-related error message to appear in the Control Room.</p>
<p>(Service Cloud case ID: 00712808) Automation Anywhere related files are sometimes generated in <code>C:\Windows\Temp</code>. These files can be safely deleted.</p>
<p>For Enterprise 11 bots that contain an object that is captured using the Object Cloning command using the Image or the Coordinate play mode, the Set Text is performed on that object and the credential variable is used to set text for the object. The credential variable for these bots is not migrated when the bots are migrated to Enterprise A2019.</p>
<p>If you use the Set text action in the Recorder > Capture action to enter data into a text box, when you run the bot, the data appears over the old data in the text box and is not entered. The old data is not cleared from the text box because the application requires a physical event to clear the old data.</p> <p>Workaround: To ensure that the data is entered into the text box, along with the Set text action, add a value greater than 0 in the Time between keystrokes field.</p>
<p>When you use the Recorder to capture an object, set the waiting time for detecting the object to less than 30 seconds in the Keep trying for (seconds) field, and run the bot, the Recorder waits for a minimum of 30 seconds by default to detect the object.</p>

Limitations

When you use the Recorder to capture objects on an application that is installed on a virtual machine, finish the recording after the objects are captured, and relaunch the Recorder, the bot inserts the actions recorded earlier instead of launching the Recorder.

Workaround: Refresh the Bot editor or run the bot to launch a new session to start recording again.

Automation Anywhere Robotic Interface (AARI)

What's new**Get Storage file action**

The new **Get Storage file** action in the **AARI Web** package enables you to download storage files to a bot device.

[AARI Web package](#)

Upload files in initial forms or tasks

Add the **Select File** element to forms to enable users to select and upload files in the initial forms or tasks in the web interface. Users can browse to upload a new file or replace an existing file. The uploaded file is shown as a hyperlink and redirects users to a new tab when opened.

[Configure processes](#)

Hyperlinks support for initial forms or tasks

Use the new **Hyperlink** element to add links to forms and access them in initial forms and tasks.

[Configure processes](#)

Configure a scheduler user for each process (Service Cloud case ID: 00713786)

As an AARI administrator, you can now configure a scheduler user for each process to allocate the Control Room resources (devices and unattended Bot Runners) on the web interface. By default, the **Global scheduler** user is selected if a scheduler user is not configured for individual processes.

[Configure scheduler user for AARI on the web](#)

Update to properties panel for human task (Service Cloud case ID: 00718109)

As a Bot Creator, you can choose to not configure any actions in the human task by selecting the **Make the form read-only** check box in the **Properties** panel. The human task does not require any input and it is executed automatically to the next task.

Bookmark any page as landing page for AARI on the web

The web interface is now enhanced to a new multiple page system so that you can directly bookmark any page (**Requests**, **Tasks**, or **Recycle Bin**) as your landing page. Also, the tabs in the web interface have been removed so that the requests are opened one at a time and not simultaneously. To perform multiple tasks, you can open the requests pages in different browser tabs.

What's new
<p>Navigation enhancement in AARI on the web</p> <p>The web interface is now enhanced with a side navigation pane so that you can easily navigate to various pages (Processes, Requests, Recycle Bin, and Tasks).</p>
<p>New processes page (Service Cloud case ID: 00694786)</p> <p>As an AARI user, navigate to your assigned processes and create new requests by using the new Processes page in the web interface. Use the navigation bar to quickly access the page.</p>
<p>Enhancements to the Button element</p> <ul style="list-style-type: none"> • Use the Disallow button click when this form is first loaded option to disable the Button element in a form when it is displayed for the first time during bot runtime. • Use the Subtle option in the Button type drop-down menu if you want the button element to appear as a link during bot runtime. <p><i>Using the Button element</i></p>
<p>Enhancement to the form logo</p> <p>You can now use the Logos in footer field option to select up to two separate logos that are displayed in the footer of the form during bot runtime.</p> <p><i>Create a form</i></p>
What's changed
<p>Enhancement to the delete process</p> <p>An AARI administrator or a user with the Delete from Public permission can now delete a process in the public workspace. When the process is deleted from the public workspace, it is removed from the process management page in the web interface. Additionally, if the process is already assigned to any AARI user or team, access is removed after the process is deleted.</p> <p><i>Delete an AARI process</i></p>
<p>Variable selector window update</p> <p>The variable selector is now organized by Variable Source, Variable Type, and Variable sections. The variable source contains a request or task. The variable type is now an interface option for you to select an input, output, or meta types. The variable option specifies the variable names and type.</p>
<p>Request variable source</p> <p>The variable selector now enables users to select a Request variable source with an Input (previously InitialData) and Meta variable types.</p> <p><i>Create an AARI process AARI variable types</i></p>
<p>Insert variables to existing text</p> <p>You can use the variable selector in the process editor to insert or add variables without replacing the existing texts.</p> <p><i>Create an AARI process</i></p>

What's changed
<p>Filter update</p> <p>In the web interface, when you filter or search for keywords, the filter user interface now updates and reflect the filter criteria accordingly. For example, if you search for the ending status of requests, the filter shows <code>Status: Pending</code>.</p>

Fixes	
Service Cloud case ID	Description
00702607	If you have a Message box action within a trigger loop, you can now use the Run from here option to run the bot without any error messages.
00725237	Error messages are no longer displayed when the Dropdown element in the form is populated with dynamic values during bot runtime.
00733978	Forms with read-only elements can now be submitted successfully without any issues when the value of the form field exceeds 100.
-	If you select any of the Advance behavior options in the Dropdown element, error messages are no longer displayed during bot runtime.
--	A Bot Task can now pass data to the next task (Human Task or Bot Task) if it contains Japanese characters in its output variable name. Previously, English characters had to be used for the variable name in the Bot Task .
--	In a cloud environment, the AARI web interface now displays the correct screen for the selected locale. Previously, the screen was not displayed correctly for the selected locale.

Limitations
<p>In the process editor, the If/Else condition of string type does not allow the source and target values to be empty. As a result, you cannot validate if a string variable is empty.</p> <p>Workaround: Create an empty string output variable for the bot. Use this variable as the target value to compare with a form or bot source variable so that the validation in the If/Else condition does not fail.</p>
<p>When you enter data in a form of your process that contains a hyperlink, the data is ignored when you try to submit the form. The hyperlink instead displays the following behaviors:</p> <ul style="list-style-type: none"> • When the hyperlink URL is configured at a designed time (the process of designing the interface or setting properties), the URL remains unchanged by the process. • When the hyperlink URL is not configured at a designed time, then the URL is set to the Control Room domain.

Discovery Bot

What's new
<p>Search for a business process from the Processes page</p> <p>You can now use the search field to help you locate a specific process by name. The field is not case-sensitive. The search field is available from the Processes page.</p> <p>Create a Discovery Bot process</p>
<p>View all captured images from the screenshot modal window</p> <p>You can now navigate across all captured screenshots when you click an image in full size from the modal window. Click the pagination located below the image to select a step number or use the right or left arrows to quickly display all captured images.</p> <p>Record a Discovery Bot business process</p>
<p>Process Discovery package is included in default packages</p> <p>The Process Discovery package is now included in the default packages. You can preload the default package when you connect to your device. Preloading the package helps to speed the start time of the recorder the first time you begin recording a process</p> <p>Prerequisites for Discovery Bot</p>
<p>Recorder enhancements</p> <p>You can now perform actions such as double-click, drag-drop, click and hold, and text select when recording a business process. Actions performed using keyboard strokes are displayed in the Data field. Double-click is captured by the recorder and displayed in the screenshot from the Recordings page.</p> <hr/> <p>Note: The Discovery Bot recorder does not capture the drag-drop and click and hold actions from the Recordings page. To include these actions performed during the recording, you can document the individual steps in the Step description text field for the analyst.</p> <hr/> <p>Record a Discovery Bot business process</p>
<p>Support for IPv6 addresses</p> <p>IPv6 addresses are now supported for Discovery Bot.</p>
<p>Linux support</p> <p>Discovery Bot is now supported on Red Hat Enterprise Linux and Linux CentOS platforms.</p> <p>Installing Control Room on Linux</p>
<p>Support for high availability</p> <p>Discovery Bot now supports high availability deployment.</p> <p>High availability deployment</p>

What's changed
<p>Changing default repository path for custom installation</p> <p>For custom installation, you can now change the default repository path location to a new location on your server after installation.</p> <p><i>Prerequisites for Discovery Bot</i></p>

Fixes	
Service Cloud case ID	Description
--	You can now export a PDD for an opportunity with 2000 steps by using the Download PDD option from the Opportunities page.

Limitations
When Tab is used to move across fields to a password-type field, the entered data is displayed as clear text, for example, when you move from the Username to Password field. Review the text in the Data field for confidential information before you submit the process.
Some actions might not be supported during a recording session, for example, when you click through the Network tab in Inspect mode using Chrome. For such unsupported actions, pause the recorder, complete the action, and then resume the recording.
When you record a process with 1000+ steps, the Recordings page takes some time to load. Workaround: Depending on your environment, you can perform one of the following actions: <ul style="list-style-type: none"> • Split the recording into multiple recording sessions. For example, you can divide 1000 steps into 10 separate recordings. • Wait for all the steps to load on the page before submitting the process for review.

IQ Bot

What's new
<p>Enhancement to the IQ Bot Classifier package</p> <p>The Train Classifier action now provides an option to retrain the documents using an existing model file.</p> <p><i>Using Train Classifier action</i></p>

What's changed
<p>IQ Bot Pre-processor actions renamed</p> <p>The names of all the available actions in the IQ Bot Pre-processor package are now changed. For example, the Get barcodes action is now renamed as GetBarCodes.</p> <p><i>IQ Bot Pre-processor package</i></p>

What's changed
<p>Download all processed documents without any timeout (Service Cloud case ID: 00587817)</p> <p>You can now download all your processed files from the Amazon S3 server to your local machine without causing any timeout, irrespective of the number of files. Even when you choose the Delete files from the server after downloading option and if your download fails, a compressed .zip file containing the failed documents is available for downloading again.</p> <p>Download all documents action</p>
<p>Enhancements to IQ Bot APIs (Service Cloud case ID: 00688683, 00688678, 00688675)</p> <ul style="list-style-type: none"> • File upload API now returns the file ID of the uploaded file. • File status API now accepts a file ID and returns its status as a status code. • File download API now returns the extracted data in JSON format for a successfully uploaded file. <p>APIs to upload files, check file status, and downloading CSV file (A-People login required)</p>
<p>IQ Bot license renamed</p> <p>The license required to run IQ Bot is now renamed to IQBot Platform from the previous Cognitive Platform.</p> <p>Licenses overview</p>

Fixes	
Service Cloud case ID	Description
00708806	You can now save documents of up to 20 MB after validating, without any issues.
00662968	Fixed an issue that caused the gateway service to become unresponsive.
00644948	When you now upload a document in production, deadlocks no longer occur in the system and documents are correctly sent to the Validator.
00707965	When you now migrate from IQ Bot Enterprise 11 to A2019 using the Migration Assistant tool, all database tables are correctly migrated, without any errors.
00715124	IQ Bot now deletes temporary files downloaded from Amazon S3 server in the C:\windows\temp\ folder when they are no longer required. As a result, storage is no longer consumed by these temporary files.
--	Logs are now available for the IQ Bot node servers in the C:\Users\Public\Documents\Automation Anywhere IQBot Platform\Logs\ folder.
--	IQ Bot now displays the correct error message when you refresh the extraction results page for a learning instance when its associated bot is moved to production.

Fixes	
Service Cloud case ID	Description
--	<p>When creating a table on the Designer page, if you click See Extraction results without completing the table creation, the correct error message is now displayed.</p> <p>Previously, the following incorrect message was displayed: Preview will be opened in a new tab.</p>
--	<p>When a bot is deleted and you click the Test bot option on the Bots listing page, the following correct error message is now displayed: Bot not found.</p>
--	<p>Python logic is now correctly applied on all the tables. Previously, IQ Bot failed to execute Python logic for tables other than the default one.</p>
--	<p>You can view more granular logs for troubleshooting RabbitMQ v3.8.18 issues. These logs are now stored in the <code>C:\Users\Public\Documents\Automation Anywhere IQBot Platform\Logs\RabbitMQ</code> folder, depending on the log level, log size, and the rotation limit.</p> <p>If any error occurs in the RabbitMQ v3.8.18 connection, those crash logs are stored in <code>C:\Users\Public\Documents\Automation Anywhere IQBot Platform\Logs\RabbitMQ\log</code> folder.</p>
--	<p>When you now create a user role with 2-byte non-English characters, services no longer fail to execute.</p>
--	<p>If there is an existing database, IQ Bot installer now does not check for the <code>db_creator</code> role for that user.</p>
--	<p>A user with <code>AAE_IQ Bot Validator</code> role and <code>AAE_Basic</code> role can now successfully launch and validate documents in the IQ Bot Validator.</p>

Limitations
IPv6 addresses are not supported for IQ Bot, so ensure that you use IPv4 addresses only.
If you try to apply Python logic to a linked column between two tables, an error message is displayed for the linked column in the second table and the applied logic fails.
<p>If you add a blocked library to a custom Python logic and click Test Run for any field, an error message is displayed on the designer page.</p> <p>Workaround: Remove the blocked library from the Python logic.</p>

Limitations
If you use the Overwrite option to import a learning instance, all the available bots and groups are imported.
When you use the Process documents action from the IQ Bot Extraction package to run a bot through workload management, the Current Action tab displays <code>Downloading additional resources</code> along with your command instead of <code>IQ Bot extraction</code> in the In progress activity page.
Average processing time increases when you use the IQ Bot Extraction package on a document with more than 30 pages.
Running existing bots that use the IQ Bot Pre-processor package might fail after you upgrade to this release. Workaround: Because the names of the available actions in the IQ Bot Pre-processor package have changed, delete the existing actions in the bots and update them with the new names before running the bot.
(Service Cloud case ID: 00601790) You cannot register IQ Bot when the Control Room is installed on a Linux machine.
When you run a bot that has the IQ Bot Extraction package, the activity information under In progress > Current Action does not display the details correctly.
If you use the File Download API option, the <code>json</code> response you receive does not have a valid format. Workaround: This issue occurs because the <code>:</code> (colon) is replaced by <code>=</code> (equal sign) in the <code>json</code> key value. After you receive the <code>json</code> response, use these options: <ul style="list-style-type: none"> • Replace <code>=</code> with <code>:</code> • Add <code>"</code> (double quotation marks) in each text
When you try to sort the PagesUpload column in the Learning instance > Document Group tab, an error message is displayed.
On the Designer, if you resize the system identified region (SIR) of an auto-mapped field, the values from the resized selection are not captured in the corresponding value field. Workaround: To update the content of an auto-mapped field: <ol style="list-style-type: none"> 1. Select the entire SIR region. 2. Draw a bigger bounding box around the region.

Bot Insight

What's new
<p>AAE_Admin role access to operations API from Power BI connector</p> <p>The Power BI connector now provides the AAE_Admin user role access to the botrundata operational API. With this role, you can connect to the botrundata API and extract operational metrics to be analyzed and visualized within Power BI.</p>

What's new**Enhancements to the publish (production) dashboard**

Users with the **AAE_Bot Insight Admin** and **AAE_Bot Insight Expert** role can now edit the published dashboard. You can use the save as option to save the production dashboard as a custom production dashboard and add widgets to your custom dashboard. You can also delete a default production dashboard and a custom production dashboard.

[Save a published dashboard](#) | [Delete a published dashboard](#)

Important: The supported packages information is moved to this topic: [View package versions available in the Control Room.](#)

Enterprise A2019.19 Release Notes

Release date: 11 February 2021

Review the new features, changed features, fixed features, security fixes, deprecated features, and known limitations in the Enterprise A2019.19 release. Enterprise A2019.19 Build 8147 is available for On-Premises and Build 8145 is available for Cloud. IQ Bot is on Build 8098.

Important: We have updated the Enterprise A2019.19 builds to include fixes for the following issues:

- System variables that are displaying blank in the action field (Service Cloud case ID 00737695, 00737698)
- Editing the table size when creating a new table variable in On-Premises (Service Cloud case ID 00725978, 00727695, 00736105)
- Issues editing a bot in the Bot editor and opening the packages listing page that includes special characters (Service Cloud case ID 00733529, 00739634)
- Assigning a bot from the private workspace to a file variable (Service Cloud case ID 00727695)
- Actions in the Image Recognition package not allowing the use of files with .PNG extension and files with uppercase letters in the extension (Service Cloud case ID 00734972, 00734266)
- Variable names in uppercase changing to lowercase, hyphen changing to underscore, and variable not being displayed if it contained an uppercase character (Service Cloud case ID 00734784, 00734842, 00734999)
- Bots not getting deployed on a multi-user device when the user session is signed out and no active session existed (Service Cloud case ID 00727228, 00722888, 00732830, 00732835, 00733877, 00733362, 00726489, 00733070, 732959, 733160, 733269,733321, 733391, 733435, 733438, 733451, 733680, 733765, 733770, 733790, 733940, 00734067)
- Child bots encountering an error if they contained the **Find window in window** action of the Image Recognition package (Service Cloud case ID 00727031, 00730358, 00733607, 00733544, 0073464)
- Use of variables with camel case names in the Data Table, List, and Loop packages (Service Cloud case ID 00733263,00733459, 00733007, 00733988, 00734168, 00733141, 00733074, 00733087, 00733001,00734019)

For more information, see the *Fixed features* sections for Enterprise A2019 and AARI.

-
- [Migration features](#)
 - [Enterprise A2019](#)
 - [AARI](#)
 - [Discovery Bot](#)
 - [IQ Bot](#)

- [Bot Insight](#)

Migration features

Enterprise 11 and Enterprise 10 features
<p>Review messages in Migration Assistant</p> <p>The Migration Assistant displays review messages for migrated bots. Open the migration assistant for a bot to review messages for that bot.</p> <p>View changes to migrated bots using Bot Assistant</p>
<p>Migrate MetaBots with screens</p> <p>Migrate MetaBots that contain screens as assets. You can migrate screens based on UI Automation technology and captured using the Object play mode.</p> <p>How MetaBots are migrated</p>
<p>Review messages in Bot Scanner report</p> <p>The Bot Scanner report shows review messages about the behavior change in commands that are used in bots that can be migrated to Enterprise A2019.</p> <p>Analyze Bot Scanner report for migration</p>
<p>Stop, or pause and resume migration</p> <p>You can stop, or pause and then resume the migration process from the bot launcher and the Activity > In progress page.</p> <p>Stop bot migration Pause and resume bot migration</p>
<p>Migrate bots that use capture scrollable text action in App Integration command</p> <p>Enterprise 11 and Enterprise 10 App Integration commands that capture text from an application window with a vertical scroll bar are migrated to the App integration > Capture scrollable text action in Enterprise A2019.</p> <p>Package mapping for migration</p>

Enterprise 11 only features
<p>Map output of PDF integration command to multiple variables</p> <p>The output of an Enterprise 11 bot that uses the PDF integration command is mapped with multiple variables in the equivalent actions of the PDF package after the bot is migrated to Enterprise A2019.</p>
<p>Migrate bots that use the following attributes:</p> <ul style="list-style-type: none"> • Bots that send Japanese text in the VT100 terminal using the Send Text command • Bots that use the Get Single Node or the Get Multiple Nodes command to extract nodes that contain namespaces from an XML file • Bots that contain the Connect command of the Terminal Emulator command and the value in the Wait Time Out field that is less than hundred milliseconds

Enterprise 11 only features**Migrate bots that use the following options in the Active Directory command:**

- The **Modify Object** command with the Rename, Delete, Move, and Set Property actions for the **Computer** and **Organizational Unit** object type.
- The **Modify Group** command with the **Add users to a group** and **Remove users from a group** actions.

[Package mapping for migration](#)

Enterprise 10 only features**Migrate latest version of Enterprise 10 bots enabled with version control**

You can now migrate the latest version of bots from your Enterprise 10 Control Room configured with SVN version control to Enterprise A2019. Use the **Copy 10.x data** option to copy the latest version of the Enterprise 10 bots to Enterprise A2019 and then use the Bot Migration Wizard to migrate the bots to Enterprise A2019.

[Copy Enterprise 10 data](#) | [How Enterprise 10 data is copied to Automation 360](#)

Enterprise A2019

Bot agent update: This release includes a required update to your . Ensure that you complete the update to continue with your automation activities when upgrading from a previous release to this release.

[Automatically update the Bot Agent](#) | [Manually update the Bot Agent](#)

To verify which version is compatible with this release, see [Compatibility with Automation 360 builds](#).

New features**Auto-login settings**

Use the auto-login configuration in the Control Room to reduce bot startup time by reusing an existing user session. Configure auto-login in the **Administrator** settings for all devices or customize it from the **Devices** page for each device.

- Configure the auto-login settings for a user session to create a new session or reuse an existing session
- Keep user sessions unlocked
- Log off from a user session after the bot completes execution

[Configure auto-login settings](#) | [Devices](#)

New CPU utilization and device memory settings

Configure the CPU utilization and device memory threshold value in the Control Room settings to determine whether to deploy bots on devices or not.

[Configure threshold settings for user devices](#)

New features
<p>Install Bot Agent on devices without administrator privileges</p> <p>You can now choose to install the Bot Agent on user devices with either local user privileges (without administrator privileges) at the local user level or administrator privileges at the system level.</p> <p><i>Install Bot Agent and register device Create device pools Users</i></p> <p>When you install the Bot Agent at the user level, the device will not be available as a default device for another user or for device pool selection during bot deployment. For more information, see <i>Bot Agent known limitations</i>.</p>
<p>New diagnostic utility for Bot Agent</p> <p>Use the Bot Agent diagnostic utility to perform diagnostic checks on Bot Runner devices and to resolve Bot Agent connectivity issues.</p> <p><i>Perform Bot Agent diagnostic checks</i></p>
<p>New features in Data Table package (Service Cloud case ID: 00656843, 00707635)</p> <ul style="list-style-type: none"> • Use the Change column type action in the Data Table package to perform operations on the column of a data table. Use this action to change the column data type to Boolean, Datetime, Number, or String. • Sort the data in the data table in Number, Datetime, Boolean, or String format. <p><i>Data Table package</i></p>
<p>New action in App Integration package</p> <p>Use the Capture scrollable text action to extract text from the selected window or any control within the selected window and save it to a variable. If you click any control within the window, then text from that specific control is extracted. If you click outside the window, then all the text from that window is extracted.</p> <p><i>App Integration package</i></p>
<p>New encoding combo box option in Terminal Emulator for VT Series</p> <p>To send and receive Japanese text, you can now use the Encoding and CodePage combo boxes when you connect to the Terminal Emulator for the VT series terminal type.</p> <p><i>Using Connect action for Terminal Emulator</i></p>
<p>New actions in Active Directory package</p> <p>Use the following actions in the Active Directory to automate a task:</p> <ul style="list-style-type: none"> • Move a computer <i>Using the Move computer action</i> • Move an organizational unit <i>Using the Move organizational unit action</i> • Add users to a group <i>Using the Add users to group action</i> • Remove users from a group <i>Using the Remove users from group action</i>

New features
<p>New system variable for new line character (Service Cloud case ID: 00669232, 00672775, 00673578)</p> <p>Use the <code>\$String:Newline\$</code> system variable to add a new line character. This variable adds a new line character in various applications regardless of the operating system of the device.</p>
<p>Zero-size form for Enterprise A2019 (Service Cloud case ID: 00677611)</p> <p>The Run action uses the zero-size form with name <code>AAZeroSizeForm</code> that can be used by DLLs to identify zero-size forms created by Enterprise A2019.</p>
<p>Enhancement to define parent path in Active Directory</p> <p>When you establish a connection with an LDAP server, you can now select the LDAP path by connecting to the server.</p> <p><i>Using Connect action for Active Directory</i></p>
<p>Obtain information about Run-As user after bot deployment</p> <p>Use the <code>AATaskExecutor</code> system variable to return the username, first name, last name, and email of the user that ran the bot. If the bot is deployed on an attended Bot Runner, this variable returns information about the logged-in user. If the bot is deployed by a trigger, this variable returns information about the user associated with that Bot Runner license.</p> <p><i>System settings and parameters</i></p>
<p>Enhancements to the Recorder</p> <ul style="list-style-type: none"> • Universal Recorder now supports object capture in Mozilla Firefox. <ul style="list-style-type: none"> You must install the A2019 extension from Mozilla Firefox browser add-ons. • Capture table, grid view, and main window objects from SAP applications. <p><i>Universal Recorder supported applications and browsers Actions performed on objects captured with Universal Recorder</i></p>
<p>Multi-user device supported on Citrix Windows 10 Enterprise (Service Cloud case ID: 00526001)</p> <p>Multi-user device sessions are now supported on Windows 10 Enterprise on Citrix, enabling multiple users to access the same device at the same time.</p>
<p>Event triggers on unattended Bot Runners (Service Cloud case ID: 00681548)</p> <p>Ensure that you select the Reuse an existing session option for auto-login settings in the Control Room to use event triggers on unattended Bot Runners when a device is locked or is in a disconnected state (such as RDP).</p> <p><i>Configure auto-login settings</i></p>
<p>Auto Login support on Citrix VDI (Service Cloud case ID: 00680200)</p> <p>Auto Login is now supported on Citrix VDI, which enables bot deployment in unattended mode.</p> <p><i>Configure auto-login settings.</i></p>

New features
<p>Restore bots from Git repository</p> <p>If your database is deleted or corrupted, the admin user can restore all your bots and the associated dependent files from the Git repository to your new empty database.</p> <p>Restore bots from Git repository</p>
<p>Bot Deploy API checks for available devices in the order of listed pool IDs</p> <p>If you enter multiple pool IDs in the request body, the API checks the pools for available devices in the order that you listed the pool IDs. If none of the devices are available at the time of deployment, the automation is queued.</p> <p>Bot deployment - V3</p>
Changed features
<p>Enhanced security for multi-user Bot Agent devices (Service Cloud case ID: 00695858)</p> <p>The Bot Agent configured on multi-user devices for RDP-based deployments now uses the updated version of <code>wfreerdp.exe</code> for enhanced security.</p>
<p>Deployment API enhancement (Service Cloud case ID: 00655548)</p> <p>When you invoke a regular deployment API, if a RunAsUser is being used to deploy a bot, the deployment API will not deploy other bots until the RunAsUser is free to run the other bots.</p>
<p>Status change initiates workload automation deployment</p> <p>When you change the status of a Work Item from Failed to New in the Control Room (Queues), the deployment of a workload automation in queue is initiated.</p>
<p>Install Google Chrome Enterprise extension offline with Bot Agent (Service Cloud case ID: 00623511, 00689623, 00715413)</p> <p>You can now install the extension for Google Chrome Enterprise offline from the Bot Agent setup and MSI files.</p>
<p>ANSI as default encoding in Data Table package</p> <p>For text write operations, Data Table package > Write to file action supports ANSI as default encoding type.</p> <p>Bots created in the previous version of Enterprise A2019 with UTF-8 is not impacted by this change.</p>
<p>Enhancement to PDF package</p> <p>In the PDF package, when you enter an incorrect page range in the Page range field and execute the bot, an error message is now displayed, requesting you to provide the correct page range. The message is displayed for the following actions:</p> <ul style="list-style-type: none"> • Merge document • Split document • Extract text • Extract image

Changed features
<p>Bots wait for Google Chrome web page to load</p> <p>When automating a task in the Google Chrome browser, bots now wait up to 30 seconds for the web page to load, and then run the subsequent Recorder > Capture action. When the page loads, bots search for the object for the duration specified in the Wait for control field. Waiting for the web page to fully render increases the bot's ability to identify the target object in the web page.</p>
<p>Enhancement to desktop operations</p> <p>When you create a bot and select an option for desktop operations, the data selected from the drop-down list now persists even when you navigate to other fields.</p>
<p>Flow view updates in the Bot editor (Service Cloud case ID: 00701626)</p> <ul style="list-style-type: none"> The Flow view is disabled when you create or edit a bot and the bot exceeds 500 lines of code. Use the Show list view option to navigate to the list view. In the Bot editor Flow view, a warning message is displayed when the bot exceeds 400 lines of code or if the bot has more than 100 variables.

The following table lists the fixed features and the builds in which they were fixed (Build 8147 is the latest build, and builds 8145, 8134, 8122, and 8098 are the previous builds). These fixes are cumulatively available in the latest build.

Fixed features		
Build number	Service Cloud case ID	Description
8147	00737695	When you insert a system variable into an action field, the variable now appears in that field.
8147	00725978, 00727695	When you create a table variable in On-Premises, the table expands to the full size of the window. Previously the table only showed three rows at a time.
8147	00733529,00739634	You no longer encounter any issues when you edit a bot in the Bot editor and open the packages listing page. Previously, if an installed package had an object name with a space (' ') character in it, the package listing page displayed an error.
8145	00727695	You can now assign a bot from your private workspace to a file variable.
8145	--	When you create a variable in an action, the variable automatically appears in the field for which you created the variable.
8145	--	You can now use .png files in actions in the Image Recognition package.
8145	00734972, 00734266	You can now select a Control Room file with uppercase letters in the file extension in the Image Recognition > Find image in window action.

Fixed features		
Build number	Service Cloud case ID	Description
8145	00734784	Variables names are now displayed correctly in the Bot editor List view; uppercase letters in the variable name are no longer changed to lowercase letters and hyphens are not changed to underscores.
8145	00734842, 00734999	Actions now display Boolean, date time, or list type variables if the variable name contains uppercase letters.
8145	00727228, 00722888, 00732830, 00732835, 00733877, 00733362, 00726489, 00733070, 732959, 733160, 733269, 733321, 733391, 733435, 733438, 733451, 733680, 733765, 733770, 733790, 733940, 734067	You can now deploy bots on a multi-user device when the user session is signed out and no active session (signed in, locked, or disconnected) exists either for that user or any other user. The following error message is no longer displayed on the View historical activity (Activity > Historical) page: Unable to perform auto-login for user <username>.
8145	--	The Cloud migration utility no longer keeps running in the background if you close the utility when the Enterprise 11 data is being uploaded.
8134	00727031, 00730358, 00733607, 00733544, 00734642	You can now successfully execute bots when you use Image Recognition with the Find window in window action in a child bot. Previously, bot execution failed when you used Image Recognition with this action in the subtask.
8134	00733263,00733459, 00733007, 00733988, 00734168, 00733141, 00733074, 00733087, 00733001,00734019	The Data Table, List, and Loop packages now support variables with camel case names.
8122	00713867	Variables are now listed in alphabetical order in the Variables palette and in the Insert a value window that appears when you press the F2 key.
8122	--	The Control Room now does not take time to launch, and the following error message is no longer displayed: An Unexpected Problem Occurred.
8098	00689022, 00697417, 00697420, 00697079	A Bot Agent device no longer disconnects from the Control Room that is configured on Microsoft Azure. The following error message is no longer displayed: disconnecting due to outstanding pong.

Fixed features		
Build number	Service Cloud case ID	Description
8122	00719167, 00721731	Tasks such as scheduling bots and connecting to user devices are not delayed in an Control Room hosted on Cloud.
8098	00626595, 00680433	The actions in the Image Recognition package no longer return an incorrect error message about the target image data type.
8098	00698201	Fixed an issue where bots were stuck in the preprocessing mode when the bot was used as a child bot in several running bots or was deployed back to back using the Deploy API. Now bots are deployed from the cache and fewer calls are made to the database, thus avoiding a database deadlock.
8098	--	The Bot Scanner now displays the correct message for the MetaBot logic that contains credential variables that cannot be migrated to Enterprise A2019.
8098	00687223	An Enterprise 11 bot that passes a blank value as an input to the string, list, one-dimensional array, and two-dimensional array of string type variable used in a DLL no longer encounters an error when you run that bot after migrating to Enterprise A2019.
8098	00677231	A bot is no longer unresponsive if it contains an action to close the Google Chrome browser followed by an action to open the Google Chrome browser.
8098	00687207	When an Enterprise 11 bot contains objects captured using the Object Cloning command and that object has a property that contains an expression within the \$ character, the Enterprise 11 bot no longer encounters an error after migration.
8098	00689286	The Bot Scanner no longer encounters an error when you scan an Enterprise 11 bot that contains the If command with the Windows control condition selected and is automating a task on a Microsoft Excel file.
8098	00706438	An error is no longer encountered when you are installing Enterprise A2019 and: <ul style="list-style-type: none"> You are migrating from Enterprise 11 to Enterprise A2019 Active Directory is configured on the Enterprise 11 Control Room The restored Enterprise 11 database contains the AAE_Meta Bot Designer role

Fixed features		
Build number	Service Cloud case ID	Description
8098	00708522	An error is no longer encountered when you clone a dependent file of an Enterprise 11 bot after it is migrated to Enterprise A2019. The error is encountered only when the migrated bot contains a null description.
8098	00626664	You can now migrate bots that automate tasks in BMC applications. The migrated bots use the Legacy automation > Manage web controls action to automate interactions with objects.
8098	--	You can now select the regular expression Case insensitive option in actions that contain a window title field and successfully perform a recapture in the application window.
8098	00688134	In the Database package, Korean characters are now displayed properly when you use the Insert/Update/Delete action in an Excel file. Previously, the Korean characters were not displayed properly when the action was used.
8098	00675749	In the Email package, you can now forward an email using groupId or Alias. Previously, the mails were not sent by the SMTP server if the email address contained groupId or Alias in the To address field.
8098	--	You can now use a double backslash (\\) in the Send text action of the Terminal Emulator and execute bots. Previously, when a double backslash (\\) was used in this action and the bot was executed, the terminal displayed a single slash (\).
8098	00688692	When you connect to the EWS server to read mails using Loop, the retrieved email now displays the content correctly per the selected mode (HTML or plain text formats). Previously, when connecting to the EWS server to read an email in HTML format, the email body displayed a blank output.
8098	00659456	In the Loop package, when you select For each file in folder as the Iterator option, the Note below the Assign file name and extension to this variable field now displays the key name in English. Previously, the key name in the Note was translated to the languages you selected.
8098	--	A bot no longer runs intermittently when the focus changes from one window to another window and does not display the Type_015 Google Chrome plug-in error.

Fixed features		
Build number	Service Cloud case ID	Description
8098	00683528	In the Database package, single entries are now inserted in the database when you execute a store procedure to add rows in the table and the option Export data to CSV is selected. Previously, duplicate entries were added in the database.
8098	00693664	Fixed an issue where Japanese characters did not display correctly when input into a field that contained a variable.
8098	00677167	The locker Participants tab now shows only the assigned participants for that specific locker. Previously, the tab displayed the participants of the previously viewed locker, requiring the user to refresh the browser to see the correct participants.
8098	--	The Control Room services can now be run using the non-administrator service account users. The <code>Bad Gateway</code> error message is no longer displayed.
8098	00691232	Fixed an issue that did not allow users to update the value of a file type input variable after saving the bot.
8098	--	The Save option is now correctly enabled when users make any changes to the metadata, unique entity, or SAML assertion mode.
8098	--	The username is no longer saved in the login window after the user logs out unless the user has selected the Remember my username option.
8098	00682021	When you check in a bot that has cloned bots as dependencies, the dependent files are no longer lost from the private workspace. Also, after the check-in, if you create a new bot using the same dependencies as in the earlier bot, the new bot executes successfully.
8098	--	Work Items are now processed for workload automation after you add more Work Items to an existing queue.
8098	--	Work Items are now reprocessed for workload automation after you change the status from failed to new.
8098	00711410	You can now migrate workload automations in an Control Room configured to use a manual mode for Credential Vault.

Fixed features		
Build number	Service Cloud case ID	Description
8098	00667047, 00673289	Auto-login for a user session no longer fails for bots deployed on virtual machines when the VDI session is disconnected or is in a locked state, and the following token error message is no longer displayed: An attempt was made to reference a token that does not exist.
8098	00560593, 00585092	Universal Recorder is now aligned with the Bot Agent, so the recorder can capture objects on devices with any proxy server configuration.
8098	00675695	When you use the Excel advanced package, the bot now opens an Excel file without any issues. Previously, the bots failed to open an Excel file in some scenarios due to internal hardware components.
8098	00678567	CSV formulaic entries are no longer permitted in data fields of web applications, such as device names. These fields are limited to accept alphabetic characters, numbers, hyphen, and underscore entries only.
8098	00691551	Turkish characters are now supported in user names.

Known limitations
<p>When you update the Bot Agent from user level to system level, the user is unable to capture objects using recorder actions or from a window list in a Google Chrome browser.</p> <p>Workaround: Remove the registry entry for the user. Ensure the registry entry is in HKLM: <code>Computer\HKEY_CURRENT_USER\SOFTWARE\Google\Chrome\NativeMessagingHost\Automation*</code>.</p>
<p>When you uninstall the Bot Agent, the Bot Agent service and registry entry are not removed. Therefore, subsequent Bot Agent installations fail.</p> <p>Workaround:</p> <ol style="list-style-type: none"> 1. Stop the Bot Agent service from the Task Manager. 2. Delete the Bot Agent registry key from <code>Computer\HKEY_LOCAL_MACHINE\SYSTEM\ControlSet001\Services\Automation Anywhere Bot Agent</code>. 3. Reinstall the Bot Agent.
<p>When you install a Bot Agent at the user level, the user device is not registered as admin.</p> <p>Workaround: Before installing the Bot Agent, ensure that the user has write permission to the user profile folders (for example, <code>C:\Program Files</code>).</p>

<p>Known limitations</p> <p>When you deploy a bot using a custom package and if the package has an object name with a semicolon (;) or percentage (%) character in it, the bot execution fails.</p> <p>Workaround: Do not use special characters such as a semicolon (;) or percentage (%) in the custom package name.</p>
<p>Limitation for multi-user deployments with auto-login</p> <p>If the auto-login setting in the Control Room is set to lock the session when the bot finishes executing from an existing unlocked session, deployments will fail when you deploy a bot on a multi-user device with non-admin user session and another admin user session is also active on the device.</p> <p>Workaround: Restart the Bot Agent service from the Windows Start menu and log off from the admin user session.</p>
<p>Bot Agent installation</p> <p>Starting from this release, when you install the Bot Agent at the local user level, keep the following in mind:</p> <ul style="list-style-type: none"> • You cannot install the Bot Agent at the user level if you log in to the device as the root administrator. • Auto-login is not supported for local users and unattended Bot Runners. • The auto-update feature for the Bot Agent will be applicable from the subsequent release because the option to install the Bot Agent at the local user level is introduced in this release. • You cannot configure multi-user devices. • Enterprise A2019 recorders for third-party applications: <ul style="list-style-type: none"> • No separate setup is required for JRE 6 and 7. • Citrix XenApp is not supported because administrator privileges are required to set up Citrix. • You must upgrade to the Enterprise A2019.19 Recorder package to use Discovery Bot. • You must have write permission to AISense Recorder logs.
<p>Bots encounter a Java heap space error when they use the Excel basic package to open an Excel file that is 20 MB or larger.</p> <p>Workaround: Increase the Java virtual machine heap space to 8 GB:</p> <ol style="list-style-type: none"> 1. Navigate to <code>C:\Program Files\Automation Anywhere\Bot Agent\config</code>. 2. If it does not already exist, create a new text file named <code>nodemanager.properties</code>. 3. Open the file and copy the following text and paste it in the file: <code>bot.launcher.jvm.options=-Xmx8092m</code> 4. Open Windows Services and restart the Bot Agent.
<p>Bots wait a maximum of 30 seconds for an object to appear in the Google Chrome browser, regardless of the value in the Wait for control field in the Recorder > Capture action.</p>

Known limitations
<p>Limitations in Cloud migration</p> <ul style="list-style-type: none"> • The backup of the Enterprise 11 data created by the Cloud migration utility is not deleted when you close the Cloud migration utility after the Enterprise 11 data is uploaded to Cloud. • Enterprise 11 bots that contain Japanese characters in their name encounter an error when you run these bots after they are migrated to Cloud. • The Cloud migration utility does not show a validation error when you run the utility and the Automation Anywhere Control Room Reverse Proxy service is running if you have reinstalled Enterprise 11 Control Room using the same database that you have used in the previous Enterprise 11 instance.
<p>(Service Cloud case ID: 00737669) When you upgrade to this release, the Bot Agent is also updated. As a result, all the event triggers associated with Bot Runner (attended or unattended) users are stopped.</p> <p>Workaround: Bot Runner (attended and unattended) users must re-login to the Control Room to activate the associated event triggers.</p>
<p>Enterprise 11 bots that use identical names for variables that are differentiated by a hyphen or an underscore (for example, L-Lower and L_Lower) encounter an error when you run them after migrating to Enterprise A2019.</p> <p>Workaround: Update the name of one of the variables to a different name before migrating the bot.</p>
<p>String system variables do not function in Email action fields when the format is set to HTML.</p> <p>Workaround: Use HTML tags that perform the same function as the string variables. For example, instead of <code>\$String:Enter\$</code> or <code>\$String:Newline\$</code>, you can use the HTML tag <code>
</code>. Similarly, for the string variable <code>\$String:Tab\$</code>, you can enter <code>&nbsp;</code>.</p>
<p>When you insert a variable into an action field that contains other content, the variable appears at the end of the content, regardless of the cursor position.</p> <p>Workaround: Highlight the variable name, and then cut and paste it to the correct position in the action field.</p>
<p>(Service Cloud case ID: 00781974) In a Linux environment, some of the Control Room log messages are stored in the <code>/var/log/messages</code> file instead of the <code>/var/log/automationanywhere</code> directory. As a result, disk space increases, and the services might stop when the disk space is full.</p> <p>Workaround: Clear the messages file regularly to avoid a disk storage issue.</p>

Automation Anywhere Robotic Interface (AARI)

New features
<p>New filter task in the process editor</p> <p>In the process editor, the Filter Task enables users to filter variables such as human or bot task output with a specific filter criterion.</p> <p>Create an AARI process</p>

New features
<p>New process task in the process editor</p> <p>Use the new Process Task option in the process editor to call a subprocess within the main process. This feature enables you to separate tasks into different processes instead of including all the tasks in a single process. Multiple teams can now work at the same time on different tasks within the main process and remain segregated, without any conflicts.</p> <p><i>Create an AARI process</i></p>
<p>Hide a task or view a hidden task</p> <p>With a Bot Creator license, you can now perform the following:</p> <ul style="list-style-type: none"> • Hide the display of human and bot tasks by selecting the Hide this task after completion option in the process editor. • View a hidden human or bot tasks by selecting the View hidden tasks option in the tasks view page. <p><i>Create an AARI process</i></p>
<p>Edit title in process editor</p> <p>Users can now edit the title in the process editor.</p>
<p>Rich-text editor updates (web interface)</p> <p>In the web interface, you can use rich-text editor features such as bold text, italics, underline, alignment, formatting, color, and size in tasks.</p>
<p>Table element updates (web interface)</p> <p>In the web interface, the Table element now supports the use of date, number, drop-down, and text values in tasks.</p>
<p>Updates to elements in form builder</p> <p>The form builder now includes the following new elements:</p> <ul style="list-style-type: none"> • Select Folder element: Add an upload folder option in the form. <i>Using the Select Folder element</i> • Hyperlink element: Assign a URL in the form. <i>Using the Hyperlink element</i>
<p>Enhancement to the Checkbox action trigger</p> <p>If a form with a Checkbox element is used within a trigger loop package, you can now use the Value selected and Value unselected trigger actions.</p> <p><i>Trigger loop package</i></p>

Changed features
<p>Create and view requests (AARI manager)</p> <p>An AARI manager can create and view requests from processes that are assigned to the team they belong to or own. They can also create and view requests from processes that are assigned to themselves but not to the team.</p>

Changed features
<p>Same device cannot be assigned to Bot Creator and unattended Bot Runner for triggers</p> <p>After you update to this Enterprise A2019 version from an earlier version, a default device that is assigned to a Bot Creator or an attended Bot Runner cannot be assigned to an unattended Bot Runner for deploying triggers.</p> <p>Recommended action: Use separate devices or device credentials (auto-login) for a Bot Creator and an attended Bot Runner as deployments can overlap or override across licenses.</p>
<p>Create a Request action URI</p> <p>The process selector in the Create a Request action is replaced with a public repository uniform resource identifier (URI).</p> <p>AARI Web package</p>

Fixed features		
Build number	Service Cloud case ID	Description
8134	--	The table element now renders properly even when the Row before scrolling parameter value does not match the number of rows. Previously, the table did not render properly and displayed empty cells.
8122	--	When you check out a process, and add, modify, or remove tasks in the process editor, the dependencies are now correctly updated when the process is checked in.
8098	00707684, 00707688, 00707192, 00706781, 00707900, 00709109	All event triggers are now retained when you update to this version from an earlier version.
8098	--	In the process editor, undo and redo functions are now available for both canvas and properties panel interactions by default. Previously, the undo and redo functions were only available for canvas interactions.
8098	--	Previously during bot runtime, if you deleted all the existing rows from a table before adding a new row, the columns and rows of the table were misaligned. You can now drag and resize any column to reset the table alignment.
8098	--	All the trigger events within a form are now retained and no longer fail when the form is closed and reopened during bot runtime.
8098	--	In the process editor, if you replace the Go to option with an End process , the End process icon now displays the correct status (Completed, Failed, Canceled). Previously, the status was not displayed correctly and had to be changed manually by using the End process option.

Fixed features		
Build number	Service Cloud case ID	Description
8098	--	When you delete a request from the Request tab and it is sent to the recycle bin, the related task from the Task tab is now removed.
8098	--	When you filter your tasks in the Task tab, the results shown in the tab now retain the information when you navigate between different tabs.

Deprecated features
<p>Support removed for device pool configuration</p> <p>An AARI administrator can no longer use the device pool configuration to deploy bots in a process. After upgrading to Enterprise A2019.19 from an earlier version, verify that the scheduler user configuration is set up in order to successfully execute your bots in the process.</p> <p>Configure scheduler user for AARI on the web</p>

Known limitations
<p>When you create a request from a process (public or private) and enter all the required information in the initial form, the initial form cannot be submitted because the Submit option does not work. This issue occurs for all initial forms with at least one mandatory field.</p> <p>Workaround: Make all fields optional.</p>
<p>When you submit an initial form or task in a request view that contains a check box with at least two options and at least one option is selected, the check box value is not changed and defaults to a false Boolean value.</p>
<p>If the Set action is used immediately after a Get action, the value assigned to a variable using the Get action is not retrieved in the specified form element of the Set action during bot runtime.</p>
<p>An AARI manager can create a request from a process that is assigned to them but not to their team. They can create and complete the request if the process contains only bot tasks. If the process contains a human task, the manager cannot assign the human task to themselves.</p> <p>Workaround: Assign the process to both the manager and their team.</p>
<p>In the process editor, the Go To option shows only the Human Task and Bot Task, it does not show the Filter Task or the Process Task.</p>
<p>(Service Cloud case ID: 00736309, 00765069, 00784362) If you use a file trigger for a document that is in <code>.csv</code>, <code>.xlsx</code>, or <code>.xls</code> format, the corresponding bot is not triggered when that document is modified.</p>

Discovery Bot

New features
<p>View the duration of each recorded step</p> <p>A recorded step is now displayed in minutes and seconds for the business user and analyst. Use this information to understand which steps are a bottleneck in the current process and will provide most benefit from automation. The step duration is displayed from the Recordings page (below the screenshot image), and from the View process and View opportunities page from the Preview pane window.</p> <p><i>Record a Discovery Bot business process</i></p>

Changed features
<p>Enhancement to the screenshot</p> <p>The screenshot image of the recorded step is now increased to full size for a more clear, detailed view of the recorded step.</p>

Fixed features	
Service Cloud case ID	Description
--	You can now click the Screen icon to display an image that you have hidden and saved. Previously, you had to click Screen and then click Save to display the image again.
--	When an opportunity is created for a system-generated view with filters applied, the filter now persists across the view displayed in the Aggregated tab from the Opportunities page. The filter is not reapplied on the view from the Opportunities page and the <code>No recording data</code> message is no longer displayed.
--	When you now cancel a recording, the recording is not displayed on the process tile in Process Cycle .
--	You can now approve a recording with 2000 steps. The Recording status is displayed as approved.

Known limitations
Actions such as double-click, drag-drop, click and hold, and text select are not supported when you are recording a business process.

IQ Bot

New features
<p>Support for variables in IQ Bot actions (Service Cloud case ID: 00511178)</p> <p>IQ Bot On-Premises and Cloud</p> <p>You can now use variables in the Download all documents and Upload Document actions in the IQ Bot package.</p> <p>Create a variable IQ Bot package</p>

Changed features
<p>Rename a learning instance (Service Cloud case ID: 00675803)</p> <p>You can now rename a learning instance in staging in IQ Bot.</p>
<p>Sequential document processing (Service Cloud case ID: 00662968, 00665331)</p> <p>When you click See Extraction Results, IQ Bot now opens that request in a new browser tab where its number in the queue is displayed. This number keeps decreasing as the previous requests in queue are processed.</p>
<p>Dutch language support</p> <p>IQ Bot now supports the Dutch language with ABBYY FineReader Engine.</p>
<p>Configure OCR settings using REST APIs</p> <p>A user with AA IQ Bot Administrator role can now use the <code>appConfigurations</code> API to read and update the OCR settings.</p> <p>Select an OCR engine</p>

Fixed features	
Service Cloud case ID	Description
00639117	Numeric format in the Polish language is now accepted in the IQ Bot Validator.
--	When you upload a document immediately after deleting a bot it was associated with, extraction results are now displayed irrespective of when the bot was deleted. Previously, an interval of 3 minutes was required to view the extraction results of the deleted bot.
00636899, 00683451	When you create a learning instance using the custom domain, the field names now appear correctly, irrespective of the custom domain language.
00459301, 00677204, 00532325, 00658245	Custom Python logic now displays extraction results in the Designer without any errors.

Fixed features	
Service Cloud case ID	Description
00657928, 00679540	Exported IQ Bot archive (.iqba) files no longer contain any unclassified records in the .csv files.
00704365	If documents uploaded during production have fewer pages than the staging documents that the bot was trained with, these production documents are now processed without any errors.
00703560, 0062442	When you migrate learning instances using the append option, all records are now correctly migrated, irrespective of the number of records in the IQBA file.
00715124	IQ Bot now deletes temporary files downloaded from Amazon S3 server in the C:\windows\temp\ folder when they are no longer required. As a result, storage is no longer consumed by these temporary files.
00686297	IQ Bot machine learning services are now correctly installed when you install IQ Bot.
00657928, 00679540, 00727633	You can now migrate learning instances to production, even if they contain unclassified documents.

Known limitations
<p>IQ Bot On-Premises and Cloud</p> <p>If you click See Extraction results multiple times, the Learning instances listing page is opened instead of the extraction results.</p>
<p>IQ Bot On-Premises and Cloud</p> <p>When creating a table on the Designer page, if you click See Extraction results without completing the table creation, extraction results are not displayed.</p> <p>Workaround: Create the table first and then click See Extraction results.</p>
<p>IQ Bot On-Premises and Cloud</p> <p>An error message is displayed when you refresh the extraction results page for a learning instance when the associated bot is moved to production.</p>
<p>IQ Bot On-Premises and Cloud</p> <p>When a bot is deleted, an incorrect error message is displayed when you click the Test bot option on the Bots listing page.</p>
<p>IQ Bot On-Premises and Cloud</p> <p>If you rename a learning instance in production and download the files, all the files associated with the original learning instance are also downloaded. For example, if you rename a learning instance from Sales1 to Sales2, all the files associated with Sales1 are also downloaded when you download Sales2.</p>

Known limitations
<p data-bbox="289 205 649 235">IQ Bot On-Premises and Cloud</p> <p data-bbox="289 254 1435 315">If you have multiple learning instances and you click See Extraction results for all of them, the extraction results are not processed in the order of their request.</p>
<p data-bbox="289 342 649 371">IQ Bot On-Premises and Cloud</p> <p data-bbox="289 390 1443 451">When you create a learning instance with check box fields and run a Python script associated with the check box, an error message is displayed on the Designer page.</p>
<p data-bbox="289 478 649 508">IQ Bot On-Premises and Cloud</p> <p data-bbox="289 527 1390 651">When you upload staging or production documents to a learning instance, temporary files are created in the <code>C:\Windows\Temp</code> folder, and the folder size might increase over a period of time. Therefore, manually delete the files from this folder because it can cause IQ Bot to stop responding.</p>
<p data-bbox="289 682 649 711">IQ Bot On-Premises and Cloud</p> <p data-bbox="289 730 1455 791">If you select the Only for me option when installing the Bot Agent, the IQ Bot Extraction action has the following issues:</p> <ul data-bbox="289 810 1040 871" style="list-style-type: none"> <li data-bbox="289 810 873 840">• Takes a very long time to process a document. <li data-bbox="289 842 1040 871">• Some of the documents might not be processed successfully. <p data-bbox="289 911 1442 972">Workaround: During Bot Agent installation, choose the Anyone who uses this computer (all users) option.</p>
<p data-bbox="289 1003 524 1033">IQ Bot On-Premises</p> <p data-bbox="289 1052 1468 1113">(Service Cloud case: 00762174) Using the Database Migration Assistant to migrate from IQ Bot 11.x (five databases) to A2019 (unified database) in Microsoft Azure Database is not supported.</p>
<p data-bbox="289 1140 649 1169">IQ Bot On-Premises and Cloud</p> <p data-bbox="289 1188 1438 1281">When you change the display language of any learning instance that has a document in Validator, although the selected display language is successfully applied to the learning instance, an error message is still displayed.</p>
<p data-bbox="289 1312 443 1341">IQ Bot Cloud</p> <p data-bbox="289 1360 1463 1421">The auto-correction and auto-suggestion features, which are part of the MLScheduler service, use system resources extensively and cause the system to slow down or stop responding.</p>
Deprecated features
<p data-bbox="289 1549 1101 1579">IQ Bot On-Premises is no longer supported on Windows Server 2012.</p>

Bot Insight

Fixed features	
Service Cloud case ID	Description
00669196	When you apply date filters on a dashboard and then apply an attribute filter in the widget, the system now filters by a specific date. Previously, the date filter applied at the dashboard level was ignored when the attribute filter was selected at the widget level. As a result, historical data was also displayed.

Important: The supported packages information is moved to this topic: [View package versions available in the Control Room.](#)

Enterprise A2019.18 Release Notes

Release date: 11 January 2021

Review the new features, changed features, fixed features, known limitations, and supported packages in the Enterprise A2019.18 (Build 7560) release. For IQ Bot, Build 7553 is available for Cloud customers and Build 7554 is available for On-Premises customers. There are no security fixes in this release.

Important: We have updated Enterprise A2019.18 to Build 7560 to include fixes for issues with workload management (Service Cloud case IDs 00696614 and 00703339) and SSO authentication on Automation Anywhere Cloud (Service Cloud case IDs 00706042, 00706074, 00706201, 00706195, 00706134, 00706022, and 00707033). See the [Fixed features](#) section for more information.

- [Migration features](#)
- [Enterprise A2019](#)
- [AARI](#)
- [Discovery Bot](#)
- [IQ Bot](#)
- [Bot Insight](#)
- [Supported packages](#)

Migration features

Enterprise 11 and Enterprise 10 features
<p>Migrate MetaBots with screens</p> <p>Migrate MetaBots that contain screens as assets. You can migrate screens based on HTML, MSA, and .NET technologies and captured using the Object, Image, and Coordinate play modes.</p>
<p>Configure timeout in Bot Migration package</p> <p>When migrating bots, you can now set a timeout value in the range of 3 through 90 minutes (default value is 90 minutes). If the migration of any specific bot is not completed within the set time, a timeout message is displayed and the migration process moves to the next bot.</p>

Enterprise 11 and Enterprise 10 features
<p>Use regular expressions in variables (Service Cloud case ID: 00628227)</p> <p>Use regular expressions (regex) in value type variables to specify the entity on which you want to perform an operation. For example, actions in the File, Folder, String, and Window packages allow use of regular expression in variables.</p> <p>When Enterprise 11 or Enterprise 10 bots with commands that use regular expressions in variables are migrated, if their equivalent actions in Enterprise A2019 do not support regular expressions, the regular expression is converted to string in the migrated bots.</p>
<p>Migrate MetaBot that returns a list variable</p> <p>You can now migrate MetaBots that contain logic that return a list variable to the parent bot.</p>
<p>Migrate bots that use functional keys</p> <p>Migrate bots that use functional keys such as F1, F2, and F3 in the Send Text command.</p>
<p>Migrate bots that extract information from PDF</p> <p>Migrate bots that use the Extract Form Fields command to extract data from the fields in a PDF file.</p>

Enterprise 11 only features
<p>Migrate bots to Enterprise A2019 Cloud</p> <p>You can now migrate to Enterprise A2019 Cloud by using the Cloud Migration Utility. Use the utility to upload your Enterprise 11 data to Automation Anywhere Cloud.</p> <p>Migrate from 11.x to Cloud</p>
<p>Migrate to Enterprise A2019 on Linux CentOS (Service Cloud case ID: 00654757)</p> <p>You can now migrate from Enterprise 11 to Enterprise A2019 installed on Linux CentOS.</p> <p>Migrate to Linux CentOS</p>
<p>Migrate imported Enterprise 11 bots to Enterprise A2019</p> <p>You can now migrate Enterprise 11 bots that you imported using the Bot Lifecycle Management feature or the Import API to Enterprise A2019 by using the migration wizard.</p>
<p>Migrate bots that use the following attributes:</p> <ul style="list-style-type: none"> Bots that use regular expression (regex) to search for the string and title of an application window on which you want to perform an operation (Service Cloud case ID: 00616115) Bots for which custom format is configured for system dates <ul style="list-style-type: none"> The system uses the AADefaultDateFormat global value to store the format of the date. Bots that use the Search Field command to search a field index or field name by using text in the Terminal Emulator

Enterprise A2019

Bot agent update: This release includes a required update to your . Ensure that you complete the update to continue with your automation activities when upgrading from a previous release to this release.

[Automatically update the Bot Agent](#) | [Manually update the Bot Agent](#)

To verify which version is compatible with this release, see [Compatibility with Automation 360 builds](#).

New features
<p>Create a Citizen Developer user</p> <p>Administrators can now use the Citizen Developer license to create Citizen Developer roles and users in the Control Room. Users with this license can create and run bots (including bots with triggers) on their devices.</p> <p>Automation 360 licenses Create a Citizen Developer role Create a Citizen Developer user</p>
<p>Recorder enhancements</p> <ul style="list-style-type: none"> • Use the AISense Recorder Define option to record an interaction, such as click active text, with an object that is only visible when you hover the mouse over the object. • If you record a click and keystrokes in a text box with a Control Type of <code>PASSWORD_TEXT</code>, the Recorder does not capture the keystrokes entered into the field. Instead, the action selects the Set text option and offers users the option to select a credential from the Credential Vault, enter a credential variable, or enter an insecure string.
<p>Export and import Bot Insight dashboards using Bot Lifecycle Management</p> <p>The Bot Lifecycle Management feature now enables you to export and import Bot Insight dashboards (default, custom, and published) associated with analytics bots from one Control Room instance to another. You can also export and import Bot Insight dashboards using the Bot Lifecycle Management export and import APIs.</p> <p>Export bots Import bots</p>
<p>Support for non-persistent VDI</p> <p>Non-persistent virtual desktop infrastructure (VDI) is now supported for temporary devices so that you can configure settings for temporary devices in the Control Room or during Bot Agent installation.</p> <p>The feature includes the following capabilities:</p> <ul style="list-style-type: none"> • Automatically register a device. • Automatically mark a device as default for the logged-in user. • Automatically add a device to an existing pool. • Delete offline devices from a list of devices. • Add parameters for temporary devices in the Bot Agent MSI file. <p>Configure default device settings Configure auto-delete temporary device settings Perform bulk installation of Bot Agent on devices</p>

New features
<p>Efficiently map input and output variables between parent and child bots (Service Cloud case ID: 00537090, 00698697)</p> <p>For input variables, use the Quick map option to select the variables and set the values for the parent bot to pass. For output variables, use the Multiple variables tab to associate each dictionary key with a variable. This feature eliminates the need to use actions to extract the output dictionary values.</p> <p><i>Task Bot package Using the Run action</i></p>
<p>Support for PowerBuilder application in App Integration package (Service Cloud case ID: 00680703)</p> <p>The App Integration package now supports PowerBuilder to capture and extract text from a window application. The Capture text of window action enables you to open a PowerBuilder screen to capture all the data and verify the captured text.</p>
<p>Enhancements to check-out option in the private workspace</p> <ul style="list-style-type: none"> • The My bots page in the private workspace displays a new status Checked out edited for bots that are checked out and edited. • Use the Revert edits option to cancel any changes you made to the checked-out bot in the private workspace.
<p>Programmatically delete bots, files, and folders</p> <p>Use the <code>Delete files/folders</code> API to delete objects from the private or public workspace.</p> <p><i>Delete file/folder API</i></p>
<p>Manage scheduled bots using APIs</p> <p>Use the <code>Bot Scheduler</code> APIs to create, update, and view details, and delete bot schedules. Bots can be scheduled to run at a specific date and time on an unattended Bot Runner, or on a recurring basis.</p> <p><i>Bot Scheduler APIs</i></p>
<p>New action in Terminal Emulator package</p> <p>Use the Search Field action in the Terminal Emulator package to search for a field based on the text it contains. This action returns the name or index of the field based on the option selected.</p> <p><i>Terminal Emulator package</i></p>
<p>New action in PDF package</p> <p>Use the Get Property action in the PDF package to retrieve the properties of a PDF file and assigns the properties to a dictionary variable.</p> <p><i>Using the Get property action</i></p>

New features

New actions in Browser package

Use the following actions in the Browser package:

- **Close:** Closes a Google Chrome browser window or tab.
- **Get source code:** Retrieves the source code of a web page and saves it to a string variable.
- **Go back:** Returns to a web page that you previously visited in the current tab.
- **Open:** Opens the browser to a specific web page in an existing tab, new tab, or window.
- **Run JavaScript:** Executes JavaScript in a web page.

Browser package

Specify application window dimensions

Use the **Resize windows** option to set the window height and width to specific dimensions or to the dimensions at which it was captured. This feature enhances the bot's ability to identify the target object.

The following packages support this feature:

- App Integration
- If **Image recognition** condition
- If **Legacy Automation > Window Control** condition
- Image Recognition
- Simulate keystrokes
- Legacy Automation **Desktop > Manage windows controls** action
- Loop **While > Image recognition** condition
- Loop **While > Legacy Automation > Window Control** condition
- Mouse
- OCR
- Screen

Support for function keys in Terminal Emulator package

Function keys (F1 through F24) are now supported to automate processes using ANSI and VT100 terminals in the Terminal Emulator package.

Use regex case insensitive flag for Window title

Enable the regex **Case insensitive** flag to identify a **Window title** field as not case-sensitive. This feature enables you to successfully run the bots even if the letter case does not match the captured window title.

The following packages and actions support this feature:

- Wait
- Image Recognition
- Simulate keystrokes
- Mouse > **Click** action
- Legacy Automation **Desktop > Manage windows controls**
- OCR > **Capture window, Capture area**
- Screen > **Capture window, Capture area**
- Recorder > **Capture**
- Window: **Activate, Close, Maximize, Minimize, Resize**

New features
<p>Unattended Bot Runner supported on Citrix devices</p> <p>You can now deploy bots on unattended Bot Runners on virtual machines on Citrix XenDesktop and Citrix VDI Windows 2016.</p>
Changed features
<p>Only Bot Scanner related files and folders are deleted</p> <p>The Bot Scanner now deletes only Bot Scanner related files and folders from the destination folder.</p> <p><i>Scan Enterprise 11 or 10 bots using Bot Scanner</i></p>
<p>Enhanced transport layer security (Service Cloud case ID: 00677546, 00681830)</p> <p>The default Elasticsearch ports (47599, 47600) now use the more secure TLS version 1.2 and later as the communication channel between the Control Room and Elasticsearch server.</p>
<p>Enhanced Update node action in XML package (Service Cloud case ID: 00663089)</p> <p>When you edit and save an XML node, the bot updates the required attributes and their values in an alphabetical order, without removing any existing attributes of the node.</p> <p>For example, consider two existing attributes in an XML node such as <code>Name=Peter</code> and <code>Phone=9829xxxxxxx</code>. If you change the value of the phone attribute as <code>9887xxxxxxx</code> and add a new attribute <code>Gender</code> with value as <code>Male</code>, the bot updates the phone value and adds the gender as a new attribute, without removing the existing name attribute.</p>
<p>Interface change in Excel basic and Excel advanced packages</p> <p>The session name field is now the last field in actions in the Excel basic and Excel advanced packages.</p>
<p>Access at subfolder level in Control Room repository (Service Cloud case ID: 00634847, 00681221, 00685654)</p> <p>An administrator can now allow access at the subfolder level in the Control Room by assigning the Run, Check-in and Check-out permissions to the subfolder. You can only access the contents of the subfolder and not the other bots or files in the parent folder.</p>
<p>Increased working area in the Bot editor</p> <p>More horizontal and vertical screen area is available in the Bot editor for developing bots. You can hide or display the Actions and Details panels to maximize the working area in the Bot editor.</p>

The following table lists the fixed features and the builds in which they were fixed (Build 7560 is the latest build, and Build 7554 is the previous build). The fixes are cumulatively available in the latest build.

Fixed features		
Build number	Service Cloud case ID	Description
7560	00696614	Bot deployment is no longer delayed after you insert Work Items if idle devices are available for the deployment in queues.
7560	00703339	The post Work Item insertion flow is now improved so that bot deployments are not delayed.

Fixed features		
Build number	Service Cloud case ID	Description
7560	00706042, 00706074, 00706201, 00706195, 00706134, 00706022, 00707033	An issue with Control Room login page not supporting SAML for SSO and reporting an errant IPD response has been addressed. The SSO function of the Control Room login works as expected.
7554	00659336	Enterprise 11 bots that use the Image Recognition command or Image Recognition condition of the If command now run successfully after migration.
7554	00647634	The Bot Scanner no longer becomes unresponsive when scanning a large repository.
7554	00678614	An error is no longer encountered when you migrate a bot with a credential name that contains a space character or a special character.
7554	00669247	An error is no longer encountered when you download a file from a URL that contains a Unicode character using the Download files action of the Browser package.
7554	00685916	If you have used the Date system variable as an input variable in a MetaBot, the Date system variable is now available after migration.
7554	00674594	The Bot Scanner no longer encounters an error when scanning a bot that uses the Excel Column system variable after the Loop command and the column name specified in that variable contains a space character.
7554	00691905	An error is no longer encountered when you edit a user after migrating to Enterprise A2019 from Version 11.3.3.
7554	00691072	An error is no longer encountered because of the bypass configuration of proxy settings when you use the Bot Migration Wizard.
7554	00689910	You can now import more than 2100 bot files without any SQL exception error.
7554	00669927	When you execute the Bot Insight Business Data and Operations Data APIs, only information limited to the logged-in tenant is now retrieved in the API response.
7554	00639779	After you log in to the Control Room and connect manually to a VPN, the Bot Agent now reconnects automatically. You do not have to restart the Bot Agent service to reconnect.

Fixed features		
Build number	Service Cloud case ID	Description
7554	00622075	When you run a bot on a user device that has an extended display, the runtime window is now completely visible on the main display. Previously, the window was partially visible between the main and extended display.
7554	00678454	In Excel advanced, you can now use the Set cell action to write more than 4100 characters in the excel file. Previously, the bot execution failed when the cell value had more than 4100 characters.
7554	00675333	In the Number package, the field in the Assign action is now corrected as Select the source number variable/ value . Previously, the Select the source string variable/ value field was incorrect.
7554	00674315, 00677925, 00684201	When you create a TaskBot using the If and Else if actions and change the placement of the Else if block action, there is improved visibility in the Flow view. Previously, the TaskBot was not displayed properly on a low contrast display when the Else if block placement was changed.
7554	00662072, 00674336	In the Terminal Emulator package, you can now correctly page up using the KEY_PGUP function key and page down using KEY_PGDOWN for the TN5250 terminal type.
7554	00658261	The PDF Extract image action now supports CMYK (cyan, magenta, yellow, black) images format when you extract and save a CMYK image to an RGB (red, green, and blue) image. Previously, if PDF files contained CMYK images, the bot could not extract them and displayed an error.
7554	00675749	When you receive emails using the EWS server option, the <code>emailCc</code> and <code>emailTo</code> variables now return the proper value. Previously, these variables returned blank values.
7554	00663610	In the Ftp/Sftp package, you can now connect to <code>ftp.box.com</code> and use the Get folder action. Previously, the Get folder action downloaded files in the folder, causing the bot to run in an infinite loop.
7554	00675710	In the Data Table package, the Remove duplicate rows action now removes all duplicate rows rather than a single duplicate row.

Fixed features		
Build number	Service Cloud case ID	Description
7554	00539762	In the For value action of the Prompt package, characters are no longer visible during keystrokes of masked values.
7554	00679370, 00673085, 00674546, 00676912, 00678852, 00678796, 00692420, 00695390	An unknown error is no longer encountered when you run the Open Excel file action from a network drive.
7554	00672719, 00673048	Audit log entries in the Control Room are now retained even if the Elasticsearch data is configured to a file path other than C:\ (C drive) during installation.
7554	--	You can now insert Work Items from one queue to another queue for workload automation.
7554	--	You no longer have to pause and resume queues because Work Items are now processed and not randomly skipped when you use the priority queuing or round-robin method for workload automation.
7554	--	The Recorder package no longer takes time to upload to a remote application repository path of an On-Premises Control Room deployed on Microsoft Azure.
7554	00683744	You can now capture objects from the Google Chrome browser using the Recorder capture action. The plug-in not installed or disabled error is no longer displayed.
7554	00672446, 00671782, 00671065, 00683870	When you upgrade to this release from an earlier release (for example, Enterprise A2019.16), the Elasticsearch OpenDistro error message is no longer displayed. Also, the previous <code>application_log</code> indices from Elasticsearch are deleted to free up disk space for the upgrade.
7554	00690003	You can now use the Terminal Emulator package without any change in the screen resolution for the mainframe terminal type TN3270. Previously, the screen resolution was not supported for terminal type TN3270.
7554	00679244	In Dictionary and List packages, you can now use the Datetime data type in the source dictionary variable field of the Assign action. Previously, an error was encountered during bot execution if you used Datetime data type in the source dictionary variable field.

Fixed features		
Build number	Service Cloud case ID	Description
7554	00673591	Fixed an issue in the Task Bot package where the system selected all the input variable options when the user clicked away from and returned to the action.
7554	00684905, 00703481	A TaskBot now runs as scheduled and no longer shows the device status as Picked at runtime on the View task in progress (Activity) page when the TaskBot is running.
7554	00573081	The audit log page in the Control Room now records all entries related to bot deployment. Also, when a parent task with many child bots is deployed, the audit log now shows correct entries. Previously, some audit log entries were missing for bot deployment and if a parent task with many child bots was deployed, the entries displayed were incorrect.

Known limitations
Enterprise A2019 does not yet support the counter behavior of the \$Excel Cell Row\$ system variable in Enterprise 11 when the variable is used in the Loop command and the Each row in Excel Dataset option is selected. This behavior is available in 11.3.0 and earlier versions by default, and in the Version 11.3.1.2 and later versions when the <code>retainexcelcellrowlegacybehavior</code> tag in the <code>AASettings.xml</code> file is set to true.
A bot fails when it runs an action that reloads the web page, such as the Recorder > Capture action when it is used to click a link or the Browser > Open action, followed by a Browser > Run JavaScript or Browser > Extract source action. You must add a delay of at least 5 seconds to give the browser time to load.
A bot fails when it runs the Browser > Close action to close the last Google Chrome window and the window contains only one tab. Use the Tab or All browsers options instead.
A bot can return only a maximum of 3 MB to an output variable. Workaround: Store the bot output on the device, such as in a .txt file. If the output must be shared across multiple Bot Runners, store the output in a shared drive.
The AISense Recorder fails if you manually upgrade the Recorder package version, such as by importing a bot that contains a Recorder package version from a more recent build than the destination Control Room. Always upgrade the Recorder package through the Control Room.
If you install the Google Chrome extension in the Microsoft Edge browser, it causes recording and runtime errors in bots that interact with the Google Chrome browser. Even if you did not manually install the Google Chrome extension, the auto-sync settings in the Microsoft Edge browser might have automatically installed the extension. If the Google Chrome extension is installed in the Microsoft Edge browser, you must remove the Google Chrome extension from the <code>edge://extensions</code> page.

Known limitations
<p>When the regex Case insensitive flag is enabled for actions that include the window title, a recapture of the application window fails.</p>
<p>The input parameters for DLLs are not automatically passed from the parent bot to the child bot in Enterprise A2019 for migrated MetaBots.</p>
<p>Workload automation limitation for manual Credential Vault mode (Service Cloud case ID: 00711410)</p> <p>You might face issues when migrating your workload automation if the Control Room is configured to use a manual mode for Credential Vault.</p> <p>Workaround: As the Control Room administrator, perform the following steps:</p> <ol style="list-style-type: none"> 1. Change the Credential Vault mode to express from manual in the Control Room database configuration table. 2. Add the credential vault key to the <code>CredentialVault.dat</code> file in the Control Room server repository. 3. Restart the Automation Anywhere Control Room Service. 4. Re-register the Bot Agent or restart the Bot Agent service.
<p>Cloud migration limitations</p> <ul style="list-style-type: none"> • The Cloud migration utility keeps running in background if you close the utility when the Enterprise 11 data is being uploaded. • If you have configured Enterprise 11 Control Room in cluster mode, you must stop the Automation Anywhere Control Room Service on all the nodes available in the cluster. • If the Cloud migration utility is installed on a different device than the device on which the Enterprise 11 Control Room you want to migrate is installed, an Elasticsearch unavailable error occurs. • If you have SSO configured on the Enterprise 11 Control Room, an error is encountered after migration to Cloud if you change the authentication from database to SSO. • If you provide the validation code within double quotation marks, the utility successfully validates the code but fails when uploading the Enterprise 11 data.
<p>If you open a table variable for editing and then open another table variable and click Cancel in the Edit table window, the schema of that table reverts to the same schema of the first table. This occurs only in the interface; it does not impact the bot.</p> <p>Workaround: Refresh the window containing the Control Room.</p>
<p>If you use different versions of a package in a parent bot and a child bot, the capability to share a session across bots is currently not supported in the following packages: DLL, Excel advanced, Excel basic, and Terminal Emulator</p> <p>To share a session across parent and child bots, ensure that you use the same version of the package in both the parent and child bots.</p>

Automation Anywhere Robotic Interface (AARI)

<p>New features</p>
<p>New AARI on the web package</p> <p>Use the AARI on the web package to perform actions such as assign, query, and cancel tasks; create and query requests; and retrieve a list of team members.</p> <p>AARI Web package</p>
<p>Filter by time</p> <p>You can now filter your requests and tasks by time:</p> <ul style="list-style-type: none"> • Requests tab: Use the Created and Updated options in the Filter window to select any dates. • Tasks tab: Use the Task created and Task updated options in the Filter window to select any dates. <p>Filter and search for a request Filter and search for a task</p>
<p>View updated dates</p> <ul style="list-style-type: none"> • Use the new Updated column in the Requests tab to view the dates and time of a request that was last updated. • Use the new Task Updated column in the Tasks tab to view the date and time of a task that was last updated.
<p>Variable options</p> <p>In the Insert a variable window, the Variable field now shows child elements of available references, which include Dictionary, List, Record, and Table variable types.</p>
<p>Delete a request</p> <p>AARI administrators, managers, and users can now delete requests created by the AARI process. The AARI administrator can delete any requests. AARI managers can delete requests of the team for which they are the owner. AARI users can delete only the requests they have created.</p> <p>Delete a request</p>
<p>Automatically assign managers and users</p> <p>Users can now select the Auto assign this task option in the Human Task to assign managers or users to the task. Users can also select the Auto assign the target task to option in the Go to element to assign managers to the task.</p> <p>Create an AARI process</p>

New features

Enhancements to elements in the form builder

- **Time** element: Includes the time element in a form.
Using the Time element
- **Date** element: Set the date format of the user machine as the default format for the date element in the form.
Using the Date element
- **Select file** element: Drag the selected file into the form during bot runtime.
Using the Select File element
- **Password** element: View the password you enter in this field during bot runtime.
Using the Password element

Updates to interactive forms

- Use the **Change Form Title** to edit or change the title of the selected form during bot runtime.
- Use the **Validate form** option now for the **Table** element.

Interactive forms package

Changed features

Process package renamed to AARI on the web package

The **Process** package is now renamed to the AARI on the web package, which includes the **Create a Request** action and additional new actions.

AARI web package

Enhancement to process management page

In the process management page, the AARI admin can now edit the **Process Title** and **Process Description** metadata. You can now add a title and provide a short description for the process.

Enhancement to the activity page

All the Bot Runner (attended or unattended) trigger deployments in queue are now displayed in the **Activity > In progress** page.

Activities

Edit check box, radio button, and drop-down form elements in process editor

In the process editor, you can now edit and update the **List of options** and **Default value** fields for the following form elements: **Checkbox**, **Radio button**, and **Dropdown**.

Fixed features	
Service Cloud case ID	Description
00678572	You can now view the strict-transport-security header when using the AARI on the web interface. This attribute informs the web browser to automatically convert websites requesting HTTP to load HTTPS instead in order to comply with the HTTP Strict-Transport-Security (HSTS) policy.
--	The Display message field in the If/Else pair action now displays the status message in request view. Previously, the status message was not displayed in the request view.
--	When you access AARI through the web interface, the Request ID and Task ID now correctly identify the data as numeric data type and sort it accordingly. Previously, the data was considered as string type and the sorting was not appropriate.
00646148	A bot is no longer deployed multiple times when the files and folders triggers are used.

Known limitations
When a user with a Citizen Developer license deletes an event trigger, this activity is not captured in the Audit log tab.
When you delete a request from the Request tab, the tasks associated with the request are not deleted and they are displayed in the Tasks tab.
If you click the refresh option in the Tasks tab and navigate away and back to the tab, the task filter applied does not remain the same. The filter always switches to Pending status.

Discovery Bot

New features
<p>Use Model option for system-generated views</p> <p>You can now use the Model option to compare and find the best aggregated view for your recordings. Use this option to save as many views with different combinations as required.</p> <p>You can also save the view as a manual view to further customize your view and compare side-by-side. Select either an Easy or Strict model so that you can view recordings where the steps are the same versus recordings with different results with more branches in the process path.</p> <p><i>Create a process view with branches and opportunities</i></p>

New features
<p>Use Filter option for system-generated views</p> <p>You can now use the Filter option to use a set of values to compare different sections of a process across various recordings by selecting a specific path and step filter. Used along with the Model option, the path and step filter options for a system-generated or manual view can help you to determine and decide on a good candidate for automation.</p> <p><i>Create a process view with branches and opportunities</i></p>
<p>Use toggle frequency counter option for system-generated views</p> <p>You can now use the toggle frequency counter to display the number of recordings that a particular path takes in the flow in a system-generated view. Use this option to help you understand the frequency of the path compared to other recordings or views.</p> <p><i>Create a process view with branches and opportunities</i></p>
<p>Remove recording screenshot for data privacy</p> <p>Use the Screen option (icon) to display or hide the recording screenshot before submitting the recording for the analyst to review. Use this option when you do not want to share personal image details with the analyst.</p> <p><i>Record a Discovery Bot business process</i></p>
<p>Download PDD from the Opportunities table</p> <p>You can now download a process definition document (PDD) for an opportunity directly from the Opportunities table listed on the Opportunities page. The PDD is automatically generated when the opportunity is created. After the PDD is generated, the field changes from generating PDD to Download PDD. You can then download and save the document.</p> <p><i>Review opportunities and convert to bot</i></p>

Changed features
<p>Screenshot image is increased</p> <p>The screenshot image is now increased to allow for better readability of captured steps. You can now use the scroll wheel to get a zoomed-in view of the step.</p>
<p>The Export to Word option now supports 2000 steps.</p>
<p>The Convert to Bot option now supports 2000 steps.</p>

Fixed features	
Service Cloud case ID	Description
--	The Delete icon is now properly visible in the edit recordings screen in Internet Explorer.
--	You can now change the zoom level in any canvas using the two-finger swipe on the trackpad of the Aggregated and Comparison tabs.

Fixed features	
Service Cloud case ID	Description
--	The red highlight is now visible on the captured screenshots from the Recordings page and from the preview pane from the Aggregated and Opportunity tabs for analyst review.

Known limitations	
When upgrading to this release, you must regenerate all PDDs created in Enterprise A2019.17. Click Retry PDD Generation to regenerate the PDDs.	
If you want to display an image that you have hidden and saved, you must first click the Screen icon and then click Save to display the image again.	
In the Opportunities table, the search field and filter drop-down option are not available for the Process and Owner columns.	
When an opportunity is created for a system-generated view with filters applied, the filter is reapplied on the view displayed within the Aggregated tab from the Opportunities page. The filter incorrectly displays <i>No recording data</i> . The Convert to Bot and the Download PDD options are not affected.	
When a recording is canceled, the recording is incorrectly incremented and displayed on the process tile in Process Cycle .	
You cannot approve a recording with more than 500 steps.	

IQ Bot

New features
<p>New IQ Bot Extraction package</p> <p>On-Premises and Cloud</p> <p>IQ Bot now includes the IQ Bot Extraction package for processing invoices. The package uses Bot Runners on your local device instead of an IQ Bot server for processing.</p> <p>IQ Bot Extraction package</p>

Changed features
<p>Enhancement to Migration Utility</p> <p>When you now export an IQ Bot archive (.iqba) file, only a single document associated with every available bot (group) training is exported.</p>
<p>Enhancement to IQ Bot Classifier package</p> <p>The IQ Bot Classifier package now supports all languages supported by ABBYY FineReader Engine. Previously, only English language was supported.</p> <p>ABBYY FineReader Engine OCR supported languages</p>

Fixed features	
Service Cloud case ID	Description
00668625	When you upload documents containing digital signatures to learning instances, the Designer now displays the correct success or error message.
00619139, 00695157	When you now run a bot and try to edit it while it is still running, the following correct message is displayed: Staging Documents for this Vision bot is in progress. Please try after some time. Previously, the following incorrect message was displayed: Learning instance not found.
00408482	You can now successfully export a custom domain created using Korean or other Asian languages.
00669197, 00681599	Node.js is now upgraded to version v10.22.1 to fix a security vulnerability.
--	Fixed an issue that caused the following error: failed to upgrade DB -1. You can now install IQ Bot in express mode without any errors.
00633197	During validation, if there is an error in the validation pattern, the validation process now fails, the correct message is displayed, and error logs are generated.
00689326	You can now view the extraction results correctly even when the bot is trained with check box fields.
00666456	IQ Bot machine learning services are now correctly installed when you install IQ Bot.

Known limitations
<p>IQ Bot On-Premises and Cloud</p> <p>The following limitations apply to the IQ Bot Extraction package:</p> <ul style="list-style-type: none"> • If you process documents that do not belong to any created groups, they are not displayed in the Details page of the learning instance. • The Checkbox extraction option is not supported. • Some of the input invoices are not processed when you set up workload management with shared input and output folders. • Pre-processing settings from IQ Bot server are not applied.
<p>IQ Bot On-Premises and Cloud</p> <p>When creating learning instances, IQ Bot sometimes does not restrict users from creating duplicate fields.</p>

Known limitations
<p>IQ Bot On-Premises and Cloud</p> <p>Occasionally IQ Bot fails to execute Python logic for tables other than the default one.</p> <p>Workaround: Retry after you perform one of the following actions:</p> <ul style="list-style-type: none"> • Click Save and close. • Click See Extraction results.
<p>IQ Bot On-Premises and Cloud</p> <p>In PDF documents containing multiple pages, at times the segments do not display correctly on all pages.</p> <p>Workaround: Use PDFBox OCR to process the documents.</p>
<p>IQ Bot On-Premises and Cloud</p> <p>For the Get page content action of the IQ Bot Pre-processor package, if you select the Create variable option from the List of strings extracted from page menu, you can only use Any from the Subtype drop-down menu.</p>
<p>IQ Bot Community Edition, On-Premises and Cloud</p> <p>If you use Internet Explorer version 11.0.973.17763 to log in to IQ Bot and open See extraction results for a learning instance, you cannot open or download the <code>Preview.csv</code> file.</p>
<p>IQ Bot On-Premises</p> <p>You must be a service account user to install IQ Bot on a fresh machine.</p>
<p>IQ Bot On-Premises and Cloud</p> <p>The auto-correction and auto-suggestion features, which are part of the MLScheduler service, use system resources extensively and cause the system to slow down or stop responding.</p>

Bot Insight

New features
<p>Access Bot Insight data from Tableau</p> <p>Use the Tableau connector in Bot Insight to access business and operational information. The Tableau connector connects to the Bot Insight APIs to create various business and operational metrics that you can analyze and visualize within Tableau.</p> <p>Configure Tableau web data connector in Bot Insight</p>
<p>Assign Bot Insight license (Service Cloud case ID: 00651973)</p> <p>Assign the Bot Insight license to users to enable them to view and perform tasks on the Business dashboard. You can now assign the license on a per-user basis, irrespective of the assigned roles.</p> <p>Automation 360 licenses</p>

Fixed features	
Service Cloud case ID	Description
00689802	You no longer encounter an issue when you create and view default dashboards in a development (dev) environment. Previously, an error was displayed when you open the bot and clicked Analyze to create the default dashboard.

Supported packages

Package	Version
Application	2.1.0-20201112-22332
App Integration	2.3.0-20201210-171315
Active Directory	2.1.0-20201112-223323
Boolean	2.1.0-20201126-165109
Browser	2.3.0-20201211-222811
Clipboard	2.1.0-20201126-165124
Comment	2.3.0-20201126-165125
CSV/TXT	2.3.0-20201126-165126
Database	2.2.0-20201112-223343
Data Table	2.5.0-20201201-130615
Datetime	2.2.0-20201126-165136
Delay	2.2.0-20201126-165137
Dictionary	3.2.0-20201126-165138
Run DLL	3.3.0-20201126-165850
Email	3.2.0-20201120-062604
Error handler	2.3.0-20201126-165148
Excel basic	2.4.0-20201126-165604
Excel advanced	5.3.0-20201208-090251
File	3.2.0-20201126-165151
Folder	3.1.0-20201126-165154
FTP / SFTP	2.2.0-20201115-072759
Image Recognition	2.2.0-20201117-081754
JavaScript	2.4.0-20201126-165412
Simulate keystrokes	2.5.0-20201112-223902
Legacy Automation	3.2.0-20201124-064544 1.5.0-20201125-004358

Package	Version
List	2.2.0-20201126-165427
Log To File	2.2.0-20201126-165428
Loop	2.1.0-20201126-165429
Message Box	2.1.0-20201126-165430
Mouse	2.2.0-20201112-223917
Number	2.1.0-20201126-165444
OCR	2.3.0-20201126-081210
Office 365 Excel	2.2.0-20201104-062559
Office 365 Calendar	2.1.0-20201111-162101
Office 365 OneDrive	2.2.0-20201126-165550
PDF	2.6.0-20201126-165555
PGP	2.2.0-20201126-165557
Ping	2.1.0-20201126-165559
Play Sound	2.1.0-20201127-115706
Prompt	2.2.0-20201109-192507
Python Script	2.4.0-20201208-064944
Recorder	2.10-20201215-211402
REST Web Service	3.2.0-20201112-224735
SAP	2.2.0-20201126-165852
Screen	2.2.0-20201126-165855
SNMP	2.1.0-20201126-165859
SOAP Web Service	3.2.0-20201123-093411
String	3.1.0-20201126-165909
System	3.0.0-20200921-090225
Terminal Emulator	3.6.0-20201213-084139
VBScript	2.4.0-20201208-065526
Wait	3.1.0-20201126-165922
Window	2.3.0-20201123-093430
Workload	2.1.0-20200825-071644
XML	2.1.0-20201126-165927

Related reference

[Community Edition A2019.18 Release Notes](#)

Enterprise A2019.17 Release Notes

Release date: 2 December 2020

Review the new features, changed features, fixed features, security fixes, known limitations, and supported packages in the Enterprise A2019.17 (Build 7103) release. IQ Bot is on Build 7082.

- [Enterprise A2019](#)
- [AARI](#)
- [Discovery Bot](#)
- [IQ Bot](#)
- [Bot Insight](#)
- [Supported packages](#)

Migration features

Important: Migration to Enterprise A2019 (currently available only to customers in the Migration Early Adopter Program)

Migration to Enterprise A2019 is currently only available to select customers through our Migration Early Adopter Program. If you are interested in learning more about this program or a timeline for when migration will be available to all customers, contact your Automation Anywhere representative.

The following features apply to both **Enterprise 11** and **Enterprise 10**:

Obtain information about upcoming support for commands and variables

Bot Scanner provides information about the upcoming Enterprise A2019 release in which a specific command or variable will be supported or available.

Migrate MetaBots with screens

Migrate MetaBots that contain screens as assets. You can migrate screens based on the Java technology and captured using the **Object**, **Image**, and **Coordinate** play modes.

[How MetaBots are migrated](#)

View progress of bot migration

A progress bar is displayed in the migration results tab when the system starts migrating the bots.

Migrate bots that use SAP command

You can migrate Enterprise 11 bots that use the **GUI Automation** command to capture various objects from an SAP application.

[Package mapping for migration](#)

Migrate bots that use the following attributes:

- Regular expression to search for files on which you want to perform an operation.
- Variable to specify the child bot you want to run.
- System variables to retrieve information about a device's settings and its performance.
- The **Save header To** option and containing array and dictionary variables in the REST Web Service command to store the response header.

- Bots that contain failure responses from the REST Web Service command by using the **Capture failure response** option in Enterprise A2019. For Enterprise 11 bots, this option is enabled by default.

REST Web Service package

- Variables with names containing Arabic or Russian characters, or Japanese double-byte numbers.

Unicode range supported in variables

The following features apply to **Enterprise 11** only:

Increment loop counter value by 1

The \$Counter\$ variable used in loop in Enterprise 11 bots is replaced with the \$Condition-Counter\$ variable in the migrated bots and value for the variable set to 1.

Service Cloud case ID: 00659314

View audit log migration reports

View the status of audit log migration and other related information in the **All migrations** page. View additional information by using the **View migration** option for each audit migration instance.

Migrate Enterprise 11 audit logs | View migration reports

Migrate Enterprise 11 Bot Insight data and dashboards

- Migrate Enterprise 11 Bot Insight data and published dashboards of bots enabled for analytics by using the Bot Insight pre-migration utility and Bot Migration Wizard.

Export Enterprise 11 Bot Insight dashboards for migration | Migrate Enterprise bots

- View Bot Insight migration reports from the new **Bot Insight results** tab on the **Administration > Migration > View migration** page.

View migration reports

Migrate bots that use the following attributes:

- MetaBots with DLLs that use credential variables of string, character, or byte data type.
- The **Launch website** action of the Browser package to open a website in the Microsoft Edge browser.
- Shared session to establish a connection with a terminal server or open a Microsoft Excel spreadsheet and close the shared session from the child bot.
- IBM 5555 B01 and C01 models for TN5250 terminal types and the **Default** terminal for the VT100 terminal type.

Enterprise A2019

Bot agent update: This release includes a required update to your . Ensure that you complete the update to continue with your automation activities when upgrading from a previous release to this release.

[Automatically update the Bot Agent](#) | [Manually update the Bot Agent](#)

To verify which version is compatible with this release, see [Compatibility with Automation 360 builds](#).

New features
<p>Connect to EWS server with OAuth authentication</p> <p>A new authentication is available for the Exchange Web Services (EWS) protocol with OAuth. You can use the OAuth authentication and enable your EWS-managed API applications to access Exchange online in Office 365.</p> <p>Using Connect action for Email</p>
<p>Google Cloud Platform supported for On-Premises deployment</p> <p>You can now host the Control Room, and create and deploy automation on devices configured to use the Google Cloud Platform environment.</p> <p>Operating system, environment, and platform supported for Control Room</p>
<p>LDAP channel binding for enhanced network security in On-Premises deployment</p> <p>Control Room supports LDAP channel binding in order to comply with a security release from Microsoft. LDAP channel binding provides enhanced security for network communications between an Active Directory and its clients. It provides a more secure LDAP authentication over SSL and TLS.</p> <p>Configure LDAP channel binding</p>
<p>Use Bot Agent with AWS WorkSpaces (Service Cloud case ID: 00652474, 00676112)</p> <p>You can now deploy bots on Bot Agent devices that are configured on AWS WorkSpaces.</p> <p>Bot Agent compatibility</p>
<p>VT220 terminal type supported in Terminal Emulator</p> <p>To establish a connection and communicate with another machine, you can now use the VT220 terminal for sending and receiving text.</p> <p>Using Connect action for Terminal Emulator</p>
<p>Permission to cancel checkout in Control Room</p> <p>Use the Cancel checkout permission to cancel checked-out TaskBots or files from the public or private workspace.</p> <ul style="list-style-type: none"> In the public workspace, the status of the bot changes to public. In the private workspace, the status of the bot changes to new if any changes were made to the bot. If there are no changes, the bot is replaced with a clone. <p>Check out a single bot</p>

New features
<p>Enhancements to the Recorder</p> <ul style="list-style-type: none"> Record a task using the Universal Recorder or AISense Recorder from a single point of entry. Both recorders are now managed through a single package, which enables faster and more efficient updates. You can now record tasks in a Microsoft Edge browser that runs on Chromium (versions 79 and later). Use the AISense Recorder Define option to capture an object that is only visible when you hover the mouse over the object. Use the Resize window option in the Recorder > Capture action to set the window width and height. <p>This option delivers a more reliable bot. It resizes the window to the dimensions at which the task was recorded, thus increasing the likelihood that the bot identifies the target object.</p> <p>Get started with recorders Universal Recorder supported applications and browsers Using the Capture action</p>
<p>Use shared session in Terminal Emulator</p> <p>Use the new Shared session option to pass the exact state of an application to a concurrently occurring TaskBot or MetaBot logic. For example, instead of connecting to the same application multiple times for different tasks, you can use the option to connect to the application using a single task, thus optimizing your automation logic in the long run.</p> <p>Share session between TaskBot logic</p>
<p>Share an Excel session between bots</p> <p>Use the Set session action from the Excel basic or Excel advanced package to assign an Excel session to a variable, and then pass that variable from a parent to a child bot. This enables the child bot to access the worksheet opened in the parent bot.</p> <p>Excel basic package Excel advanced workbook operations Example of sharing an Excel session between bots</p>
<p>New option for Run Task</p> <p>In the Task Bot package, you can now use the Run action with an option to repeat the selected task until you choose to stop it.</p>
<p>New search for roles in User Management API</p> <p>Use the new <code>Search for roles</code> API in the User Management APIs in Swagger to obtain a list of all the roles or details for a specific role.</p> <p>List roles</p>
<p>Capture response status of REST API</p> <p>In the REST Web Service package, you can capture the response status of the REST API in the dictionary variable. The dictionary variable now shows the response key with its value.</p>
<p>New option for REST Web Service (Service Cloud case ID: 00489741, 00646436)</p> <p>Use the Capture failure response action in the REST Web Service package to capture response details in the response body.</p>

New features

Use regular expressions in packages

You can use regular expressions (regex) in certain actions to support pattern-based search in a file, folder, or Windows title. Regular expressions are supported in the actions of the File and File and Folder packages such as **Copy**, **Delete**, **Rename**, **Print Multiple files**, and **Zip**.

You can also use regular expressions in some packages that support the wildcard character in their window titles.

The following packages and actions support regular expressions:

- Wait
- Image Recognition
- Simulate keystrokes
- Mouse > **Click** action
- Legacy Automation > **Manage windows control**
- OCR
- Screen
- Recorder > **Capture**
- Run DLL > **Run function (Legacy)**, **Run function**
- Window: **Activate**, **Close**, **Maximize**, **Minimize**, **Resize**

[Using Copy Desktop file action for file](#) | [Using the Capture action](#)

Support for overloaded functions in DLL package

The **DLL > Run function** action can now handle `.dll` files that contain multiple functions of the same name. The action calls the function based on the number of parameters passed.

[Using the Run function action](#)

New actions for SAP captured objects

Use new actions that are available for **Tree**, **Tab**, and **Label** controls to perform operations for the various objects captured from an SAP application.

[Recorder actions supported in various SAP versions](#)

New features

Enhancements to elements in the form builder

- **Image** element: Upload image files to the form using this element.
Using the Image element
- **Button** element: Validate all the fields in a form using the **Validate all form fields when this button is clicked** option.
Using the Button element
- **Password** element: Use one of the following formatting options:
 - **Standard**: set the character limit and choose additional security options.
 - **Custom**: add a custom password on the **Regular expression** page.
Using the Password element
- **Rich Text Editor** element: Use this element in the **Set** action when creating a bot in order to add or overwrite the value of a variable.
- **Table** element: Includes the following updates:
 - New data types for **Column settings**:
 - Date
 - Number
 - Dropdown
 - The following actions, which you can use during bot runtime:
 - **Set** action to add rows to the table.
 - Trigger events to add rows and delete rows.
 - Sort table columns.
- **Text Box** element: Choose one of the following formatting options:
 - **Standard**: set the character limit for this field.
 - **Custom**: add a custom password on the **Regular expression** page.
Using the Text Box element
- **Select file** or **Snapshot** element: When you click **Preview** during bot runtime, the system default application is used to display the selected file.
Using the Select File element | Using the Snapshot element

Enhancement to List view of bots

In the **List** view of the Bot editor, you now drag a selected action to the task logic.

New features

Import Enterprise 11 bots to Enterprise A2019 (Service Cloud case ID: 00512847)

- **Bot Lifecycle Management Import feature:** The Bot Lifecycle Management import feature enables you to import Enterprise 11 bots from multiple Enterprise 11 Control Room instances to a single Enterprise A2019 instance by using the `aapkg` file.

[Bot Lifecycle Management](#) | [Import bots](#)

- **Bot Lifecycle Management Import API:** You can also use this API to import Enterprise 11 bots to the Enterprise A2019 instance by uploading the `aapkg` file. However, you can import a password-protected `aapkg` package only by using the Import API.

[Bot Lifecycle Management API](#) | [Import files using API](#)

New endpoint in License API

Use the **List details of Control Room licenses** endpoint to retrieve metadata including the license type, number of available licenses, number of licenses used in a specific Control Room instance, and number of licenses used in all Control Room instances.

[License API](#) | [List Control Room licenses](#)

Programmatically manage device login credentials

Use the **Login setting** endpoint of the Credential Vault API to set or update the device login credentials to allow bots to run on the device.

[Set device login credentials API](#)

Store multiple lines of text in a string variable

You can use a string variable containing multiple lines of text in the following actions:

- **String > Assign**
- **String > Extract text**
- **String > Compare**
- **String > Lowercase**
- **String > Replace**
- **String > Reverse**
- **Log to file**
- **Message box**
- The string condition in the **If**, **Wait**, and **While** actions

Arabic, Japanese, and Russian characters supported in variable names

You can now create variables with names containing Arabic or Russian characters, or Japanese double-byte numbers.

[Unicode range supported in variables](#)

Changed features
<p>Configure granular security for Bot Agent (Service Cloud case ID: 00653807)</p> <p>Starting from this release, only registered Bot Agent device IP addresses that are added in the Allowed IP addresses list of the Network Settings can connect to the Control Room. In previous releases, devices from all subnets and IP addresses within the corporate network were allowed to connect to the Control Room URL.</p> <p>Add access IP addresses</p>
<p>Update to Excel advanced package</p> <p>The Open action in the Excel advanced package now opens a Microsoft Excel spreadsheet even when a file extension is not provided.</p>
<p>Disable clone and view content permissions for check-in (Service Cloud case ID: 00656157)</p> <p>When the Check in permission is selected, the Clone and View content permissions are also automatically selected. As a Control Room administrator, you can now disable the Clone and View content permissions when required.</p>
<p>Associate triggers with unattended Bot Runners</p> <p>Ensure that the default device is not in locked state if you are associating triggers with unattended Bot Runners.</p>
<p>Additional license support enhancements</p> <p>Control Room administrators are enabled to install a new GUID license before an existing license expires.</p>
<p>Change in edit device permission</p> <p>Starting from this release, the permission to edit devices is not available in the system-created AAE_Basic role by default in the Control Room. A user has to select the Edit the device(s) permission separately.</p> <p>Devices</p>

The following table lists the fixed features and the builds in which they were fixed (Build 7103 is the latest build, and Build 7096 is the previous build). The fixes are cumulatively available in the latest build.

Fixed features		
Build number	Service Cloud case ID	Description
7103	00684905, 00703481	A TaskBot now runs as scheduled and no longer shows the device status as Picked at runtime on the View task in progress (Activity) page when the TaskBot is running.
7103	00676476	An error is no longer encountered when you run a child bot that contains a Japanese full-width space character in the name.

Fixed features		
Build number	Service Cloud case ID	Description
7103	00689935, 00689381, 00690368, 00690217, 0069053	License server syncing error generated when control room licenses and licenses stored on a server are updated on different schedules. This issue has been fixed. Should an error message appear, click "Sync licenses from Server" for any new licenses in production to manually sync the licenses.
7096	00667396, 00670001, 00653771, 00671553	Bot Scanner no longer encounters an error when scanning bots with non-ASCII characters in their name.
7096	00659334	The Offset from match option in the Image Recognition package now works correctly in migrated bots.
7096	00669166	You can now migrate large bots (for example, with 30+ dependencies and 500+ lines) using the Bot migration package. The system no longer encounters an error when migrating a bot that contains a large number of nested IF/ELSE commands.
7096	00659349	You can now migrate bots with special characters in their names.
7096	00670985, 00674145	The system no longer encounters an error due to Bot Store credentials when you migrate from Version 11.3.3 or a later version to Enterprise A2019.
7096	00679817	An <code>unknown</code> error is no longer displayed when you are migrating a bot that the Bot Scanner listed as ready for migration.
7096	00457898, 00488494	You can now register a device with a username that contains non-ASCII characters such as Korean language characters. Note: Before upgrading the Bot Agent to the current version, ensure that the registered device is configured to use non-ASCII characters. Configuring post-installation settings

Fixed features		
Build number	Service Cloud case ID	Description
7096	00611887	You can now download an exported bot package using the Internet Explorer browser by opening the download link received in the email. You can also do this from the Activity > Historical page.
7096	00647932	When you create a bot using the Get method action in the REST Web Service package, the UTF-8 character set is now supported. Therefore, Korean characters are processed correctly in the REST API response. Previously, UTF-8 characters were not supported.
7096	00641126	You can now use the Get single cell action in the Excel basic package to extract the date correctly for the Japanese date format. Previously, the Japanese date was displayed in double quotation marks.
7096	00634102	You can now use the Simulate keystrokes package with the Alt+F4 key and set a longer delay value between each keystroke. Previously, the bots displayed an error when a longer delay value was set with the Alt+F4 key.
7096	00655739	In REST Web Service, the Rest API Get call now works properly even when the encoded URL string has special characters such as double quotation marks. Previously, the Rest API Get call failed when the URL string had double quotation marks.
7096	00653944	The String package now shows the correct output when you use the loop action to read a file name that does not have an extension. Previously, when the file did not have any extension, the filename extracted using the loop displayed an incorrect output.
7096	00677941	When an optional field (Mark field required is not selected) is now left blank, a form is validated without any error messages during bot runtime.

Fixed features		
Build number	Service Cloud case ID	Description
7096	00662011	When using the files and folders trigger, you can now use any available network drive to start a bot.
7096	00666441, 00673888	For a folder trigger, you can now select a folder name containing a space character and the bot runs successfully without encountering any issues. For example, you can select a folder called 'Sales chart'.
7096	00622100	When Simulate keystrokes is enabled for a hot key trigger, you can now start a bot multiple times using the associated hot keys without encountering any issues.
7096	--	If an element is marked as Read-only on the form builder screen, a validation error is no longer displayed for that field during bot runtime.
7096	00570660	You can now use Windows forms with the Run function action of the DLL package.
7096	00624644	The system no longer encounters an error when you upgrade from an earlier version of Enterprise A2019 to a later version when the settings are preserved and the installation path is not the default location.
7096	00670008	You can now pause or resume a task from the Activity > In progress page.
7096	00667210, 00672875	In the Excel advanced package, you can now use the Go to cell action even if the Excel sheet does not have any data or an active cell is out of the worksheet range. Previously, an issue was encountered when you used the Go to cell action and chose the cell option as Active cell with the Beginning of the row, End of the row, Beginning of the column, or End of the column option.

Fixed features		
Build number	Service Cloud case ID	Description
7096	00659098, 00669437	You can now edit the Start date of an existing schedule to today's date, provided the start time is set before the bot is scheduled to run.
7096	00671392	You can now stop a bot that is in progress using the Stop option from the In progress (Activity) page or the Stop option on the runtime window that appears when the bot is being executed.
7096	00647761	You can now define a list variable of subdata type Boolean or datetime within an action. Previously, the bot encountered an error in this scenario.
7096	00671478	Fixed an issue in the Task Bot > Run action where the value of an input variable disappeared when the user clicked Save . This issue only occurred when the Current Task Bot option was selected.
7096	00663719, 00635437	Fixed an issue where the OCR package was missing from Control Room instances hosted on Microsoft Azure. The connection with the Microsoft Azure database timed out before the OCR package .jar file could complete the upload.
7096	00631133, 00636174	In the Wait package, the Wait for condition action in the recorder object no longer waits indefinitely during bot execution. If the required window or its control does not exist, the bot waits for the required window or its control for the time specified in the Wait for control field. If the required window or its control is not found within this specified time, the bot continues to perform the next set of actions.

Fixed features		
Build number	Service Cloud case ID	Description
7096	00628863	Bot files or dependencies are no longer lost when you check in or check out a bot from the private or public workspace when the Elasticsearch service is running and not in index read-only mode. Previously, an error occurred when a bot was either checked in or checked out, and the bot files or dependencies were lost and could not be recovered.
7096	00673520	When a bot is deployed through RDP with a predefined screen resolution, the RDP resolution settings are now applied correctly during bot execution. Previously, the bot was executed with an interchanged resolution (the height and width pixels were interchanged).
7096	00670346	After you edit a bot schedule, the input value of a variable in the bot no longer has to be reinitialized and the bot does not show the default output value for the variable when it is executed.
7096	00653056, 00651853, 00647949, 00657465,00670024	The In progress activity is now displayed correctly for bots deployed on Bot Runners by any user.
7096	--	<p>When developing custom packages, you can now set your name in the vendor column. To set the name, update the <code>author</code> property of the <code>build.gradle</code> file, as shown below:</p> <pre>packageJson{ artifactName = project.name group = "\$groupName" author = "<entername>" }</pre> <p>Leaving the field empty shows the vendor name as unspecified.</p>
7096	--	Multiple users can now simultaneously run a bot associated with a form without encountering any issues on the same Bot Runner machine.

Fixed features		
Build number	Service Cloud case ID	Description
7096	--	You can now migrate Enterprise 11 bots that contain variables that are in a different letter case (uppercase or lowercase) than those in Enterprise A2019. Variables are case-sensitive in Enterprise A2019 but not in Enterprise 11, which previously resulted in an error.
7096	00592758	You can now create a variable with a name that starts with a numerical character.
7096	00670994	You can now register with the Control Room from a multiple-user device configured for Active Directory users.
7096	00677479	The deployment time of a priority queue no longer takes a long time (for example, more than 1 hour) to process Work Items required for workload automation.
7096	00667110	You no longer have to restart the Automation Anywhere Bot Agent service to resume queued Work Items that are stuck in in-progress state.
7096	00673043	When you specify a value in the numOfRunAsUsersToUse parameter of the Bot Deploy API, the weighted system algorithm now assigns tasks to the Bot Runners with the least number of tasks queued and currently running. Previously, the algorithm did not correctly calculate the weight of queued and running tasks, which resulted in an inefficient task allocation to the same one or two Bot Runners.

Known limitations
When a bot opens a website inside a loop, the Recorder Capture action fails after the execution of Launch Website.
Workaround: Add a delay of a few seconds in the loop between the Launch Website and Recorder Capture action.
The Recorder Capture action does not support object recapture for the AISense technology type.

Known limitations
The system does not display a value for a session variable when the variable is selected as Watched variables in Debug mode.
The session variable returns a blank value when it is used as output in a bot and the bot is deployed using the Bot Deploy API.
After an upgrade to the latest version of Enterprise A2019, the bot might encounter an error if you are using the Close action of the Window package version 2.1.0-20200813-181240 or earlier. Workaround: Add a delay of 50 milliseconds after the Close action in the bot.
The Recorder package takes a long time (for example, approximately 6 hours) to upload to a remote application repository path of an On-Premises Control Room deployed on Microsoft Azure. Workaround: <ol style="list-style-type: none"> 1. Before you install or upgrade to this version, configure the repository path in a local directory of the Control Room node to upload the package. 2. After installing or upgrading, verify that all packages are available in the Packages page of the Control Room. 3. Change the repository path to a remote file share.
The AISense Recorder fails if you manually upgrade the Recorder package version, such as by importing a bot that contains a Recorder package version from a more recent build than the destination Control Room. Always upgrade the Recorder package through the Control Room.

Automation Anywhere Robotic Interface (AARI)

New features
<p>Run a process in private workspace</p> <p>You can now run a process in your private workspace by using the Run option in the process editor. The bots in the process are then executed on the default device of the Bot Creator.</p> <p>Configure processes</p>
<p>Use the Data Privacy tag field</p> <p>The Data Privacy tag enables users to generate hidden custom output in their process tasks (Start panel, Human Task, and Bot Task). Users can enter the variables for this field during runtime with values. In the web portal, the AARI admin can use this tag to check for requests or tasks by using personal user data. The admin can also filter using this field.</p> <p>Create an AARI process Filter and search for a request Filter and search for a task</p>
<p>Use variables types</p> <p>You can now use new variables in the process editor such as createdOn and updatedOn (DateTime), id (Number), and title (String). These variables are part of a data flow (workflow engine) that moves data between each step of a process and requires variable input for the process to run properly.</p> <p>AARI variable types</p>

New features
<p>View previous selected tasks</p> <p>AARI users can now reference selected actions of their tasks. When they view a submitted task in request view, a check mark indicator is now displayed next to the buttons that are selected.</p>

Changed features
<p>Configure scheduler user to allocate device pool to AARI on the web interface</p> <p>In the AARI Settings page, the AARI administrator can now configure a scheduler user to allocate the Control Room resources (devices and unattended Bot Runners) to AARI on the web interface.</p> <p>The scheduler user must have View my bots and Run my bots permissions and have access to a device pool and Bot Runners. The AARI process can then use those resources for each bot deployment.</p> <p>Configure scheduler user for AARI on the web</p>
<p>End point display</p> <p>In the Completed panel, the End point has a new display option Update request title that enables the user to update the request title. When the user updates the Display message field, the update is now reflected in request view.</p> <p>Create an AARI process</p>
<p>Use F2 to insert variables</p> <p>You can now use the F2 keyboard shortcut to insert variables in the process editor.</p>

Fixed features	
Service Cloud case ID	Description
--	The Task display name option in the Start panel is now set to Request Creation by default. Any name changes by the user is now reflected in the request view.
--	The Feed data into form table in the process editor now works properly and users can now edit the field.
--	In a form that contains a Number field set to a 10-character limit, when you enter the maximum character limit (for example, 1234567890) in the number field in request view, the number values are now accepted.
--	When you create a process with a form that contains a Date element, the Condition option in the If/Else pair action now allows you to enter a variable. Previously, the option did not allow you to enter a variable.

Known limitations
<p>In the process editor, if a bot contains an incorrect input variable, the properties panel highlights the wrong element: Browse in the Select Task Bot field is highlighted instead of the incorrect variable.</p> <p>Workaround: Hover your mouse over the red icon next to the Bot Task in the process editor to see the error.</p>
<p>In the process editor, if you replace the Go to option with an End Process, the End Process icon does not display the status (Completed, Failed, Canceled) correctly.</p> <p>Workaround: Click the End Process icon and change the status.</p>
<p>A Bot Task cannot pass data to the next task (Human Task or Bot Task) if it contains Japanese characters in its output variable name.</p> <p>Workaround: Use English characters for the variable name in the Bot Task.</p>
<p>If a scheduler user has multiple sets of configurations (device pools and Bot Runners), due to a mismatch in the selection of the device pool and the Bot Runners, the bot deployment fails.</p> <p>Workaround: Set Bot Runners in the Run As section of the consumer role. Ensure the scheduler user has access to only one device pool and one consumer role that has run-as users.</p>
<p>When you access AARI through the web interface, the Request ID and Task ID consider the data as string type instead of numeric data type and sorts it accordingly.</p> <p>For example, if a Request ID or Task ID starts from 1 through 30, the IDs are sorted as string data type (1, 10, 11, 12, 13, ..., 2, 22, 23, ..., 30) instead of numeric data type (1, 2, 3, 4, ..., 30).</p>
<p>In some bot development failure scenarios, for example, files are not found or the scheduler user does not have access to the bot file, bot development fails by timing out after one hour instead of displaying an error.</p>
<p>If an AARI manager creates a team with the same name as a team created by any other manager, no error message is displayed and two teams are created with the same name.</p>
<p>When you access AARI through the web interface, the task and case list pages do not display the following words in the localized languages:</p> <ul style="list-style-type: none"> • Search task • Results • Request title
<p>In the process editor page, the following words are not displayed in the localized languages:</p> <ul style="list-style-type: none"> • Process entry • Run • Undo • Redo • Data privacy tag • Auto assign this task to • InitialData • Update request title (optional) • Update task name (optional) • Boolean condition

Discovery Bot

New features
<p>Column headers updated in Recordings page</p> <p>The Recordings page now displays labeled column headers when you review captured steps for recordings. The following headers are displayed for the associated text field:</p> <ul style="list-style-type: none"> • Screenshot • Application • Data • Step description <p><i>Record a Discovery Bot business process</i></p>
<p>Highlight where you click or enter data when recording processes</p> <p>The system now displays the area, component, or control where you click or enter data with a red highlighted box at the time of recording.</p> <hr/> <p>Note: The red highlight is only shown in the captured screenshot in the generated bot. The highlight is not shown on captured screenshots from the Recordings page for review and after submission to the analyst. The highlight is also not shown from the preview pane from the Aggregated and Opportunity tabs for the analyst review.</p> <hr/> <p><i>Supported applications and browsers for Discovery Bot</i></p>
<p>Condition and value displayed for each branch in Aggregated view</p> <p>For the System generated view, the condition and its value for each branch are automatically retrieved and displayed as part of the auto-generated Aggregated view.</p>
<p>System-generated aggregation</p> <p>You can now merge multiple recordings into a single aggregated view automatically by selecting the required set of recordings.</p> <p><i>Create a process view with branches and opportunities</i></p>
<p>Convert system-generated aggregated view to a manual view</p> <p>You can now convert a system-generated aggregated view to a manual view using the Save as [manual] option or the Convert to Manual option from the Views table. This option enables you to add more recordings or steps from other recordings to your process view.</p> <p><i>Create a process view with branches and opportunities</i></p>
<p>Create an opportunity, including all steps and branches</p> <p>You can now use the Select all steps option to create an opportunity that includes all steps, branches, and sub-branches.</p> <p><i>Create a process view with branches and opportunities</i></p>

New features
<p>Download a process definition document (PDD) (previously, Export to Word)</p> <p>The Export to Word option is now renamed as Download Process Definition Document (PDD). When an opportunity is created, the PDD begins processing in the background automatically. When the PDD is ready for download from the Control Room, an email notification is sent to the email address on file to the opportunity owner.</p> <hr/> <p>Note: You must be the owner of the opportunity to be able to download the PDD.</p> <hr/> <p>Review opportunities and convert to bot</p>
<p>Receive email notification when your bot is converted successfully</p> <p>You can now receive an email notification when your bot is successfully converted. Click the hyperlink in the email to take you to your folder in which the bot was generated.</p> <p>Review opportunities and convert to bot</p>

Changed features
<p>Zoomed-in view of captured steps is increased</p> <p>The zoomed-in view in the Screenshot field is now increased from x4 to x8 for better readability of captured steps.</p>
<p>Permissions layout</p> <p>The layout of the permissions for Discovery Bot is now changed to separate the individual and “all” permissions to easily manage access control.</p>

Fixed features	
Service Cloud case ID	Description
--	When you create a branch in a view, typically a single step from the current branch is moved into the left branch while a new branch with an empty box is added to the right branch. You can add steps from a different recording only into the empty box in the right branch. Typically, only one step from the original branch is included in the left branch. If the branch is created following the last step in the flow, then no steps will be included in the left branch. You can now add new steps to the left branch in case it was the last step. You can also move the endpoint of the newly created branch lower or higher in the process to include additional steps in the left branch.

Known limitations
In the Opportunities tab, the process and owner column does not allow you to sort in ascending or descending order, or when you sort for both process and owner.

Known limitations
In the Opportunities tab, the search field and the filter drop-down option do not work when you search for the Process or Owner columns.
The Download PDD option is disabled if you are not the owner of the opportunity.
The Delete icon is not properly visible in the edit recordings screen in Internet Explorer. Two-finger swipe on the track pad does not change the zoom level in any canvas of the Aggregated and Comparison tabs.
Discovery Bot is currently not supported on Linux.
The red highlight is only shown in the captured screenshot in the generated bot. The red highlight is not shown on captured screenshots from the Recordings page for review and after submission to the analyst. The highlight is also not shown from the preview pane from the Aggregated and Opportunity tabs for analyst review.

IQ Bot

New features
<p>Support for Arabic language</p> <p>When creating a learning instance, you can now choose the Arabic language from the Primary language of documents drop-down menu, with the following limitations:</p> <ul style="list-style-type: none"> • Advance table extraction is not available. • Search field on the <i>Validator</i> is not supported. • Arabic numerals are not supported. <p>For example, if the document has date or time in Arabic language, it is extracted as text and validations can fail.</p> <hr/> <p>Note: You can still use string-based validation checks (such as regular expressions) for Arabic numerals.</p> <hr/> <ul style="list-style-type: none"> • Arabic is only supported on ABBYY FineReader Engine 12.4. <p><i>Creating a learning instance</i></p>
<p>Default validations for a group</p> <p>When editing a learning instance, you can now use the Select the default validations group drop-down menu to select an available group. This allows all the new group documents in production to be extracted based on the custom logic and validations defined in this selected group, before it goes to the Validator.</p> <p><i>Edit a learning instance</i></p>

Changed features
<p>Automatically detect check box</p> <p>IQ Bot can now automatically detect check boxes and radio buttons in a document. You can enable this feature when creating a learning instance.</p> <p><i>Creating a learning instance</i></p> <ul style="list-style-type: none"> • With this feature enabled, during training, if you select check box from the data type drop-down list and then you select the field value, only the check box segments are displayed. • This feature does not work with the PDFBox option enabled. <p><i>Disable PDFBox option</i></p>
<p>Tegaki API OCR improvements</p> <p>IQ Bot now uses enhanced Tegaki API OCR segmentation to improve accuracy in the following scenarios:</p> <ul style="list-style-type: none"> • Multiple fields are merged into a single SIR • Segmentation on empty spaces • Overlapping SIRs • Incorrectly located SIRs • Partial or incorrectly captured values from SIRs <p><i>IQ Bot Tegaki API OCR engine</i></p>
<p>Updated versions of RabbitMQ v3.8.18 and Erlang/OTP</p> <p>The IQ Bot installation package now includes RabbitMQ v3.8.18 version 3.8.8 and Erlang/OTP version 23.0.4.</p> <p><i>RabbitMQ and Erlang/OTP upgrade</i></p>
<p>PyArabic removed from Python installation</p> <p>PyArabic is one of the Python libraries that was used in content extraction for Arabic language (right to left). Because Arabic language is now supported by default with IQ Bot installation, PyArabic is removed from Python installation.</p> <p><i>List of Pandas Libraries which are supported and not supported on Automation 360 IQ Bot (A-People login required)</i></p> <hr/> <p>Note: Ensure you update any bot that you have deployed using PyArabic.</p> <hr/>
<p>Performance improvement (Service Cloud case ID: 00629302)</p> <p>IQ Bot now takes significantly less time to create a bot for groups containing only production documents.</p>

Fixed features	
Service Cloud case ID	Description
00500914	<p>The TesseractLog.log file is now available in the following directory: C:\Users\Public\Public Documents\Automation Anywhere IQBot Platform\Logs\Engine\.</p> <p>The log level is set to <code>error</code> by default. You can change this setting in the <code>CognitiveServiceConfiguration.json</code> file.</p>
00430923, 00618234, 00636422, 00478986, 00414921	All uploaded documents are now rendered correctly, irrespective of their content orientation while uploading, which enables you to train them without encountering any issues. Previously, when you created a learning instance, documents that did not have the correct content orientation (they were upside down or tilted) could not be trained.
00653929	IQ Bot On-Premises: With segmentation improvements, you can now train documents in the Korean language using the Tegaki API OCR engine without any system-identified region (SIR) errors.
--	The system no longer creates any unnecessary folders for successfully classified documents that are uploaded using the IQ Bot [Local Device] package.
--	You can now use the designer page when creating a learning instance to test all the documents, without any error messages.
00590165	For a learning instance, you can now use the See extraction results option to browse all the documents in the selected group.
00672470	After validating the fields of production documents, you can now use the Save current document option to save all the validated document, without any error messages.
--	Check box fields are now extracted with better accuracy. You can use the Checkbox auto-detection feature so that IQ Bot automatically detects the check box fields and radio buttons.
00652269, 00619139	When you now run a bot and try to edit it while it is still running, the following correct message is displayed: <pre>Staging Documents for this Vision bot is in progress. Please try after some time.</pre> Previously, the following incorrect message was displayed: <pre>Learning instance not found.</pre>
00601401	When creating a learning instance, you can now use the Thai language for form and field names without encountering any issues.
00624416	When you migrate a learning instance, group descriptions are now migrated without any errors.

Fixed features	
Service Cloud case ID	Description
--	If you select any field on the Validator screen, the focus from that field is no longer lost when you now click or draw to select SIR.
00662968	Sometimes, when you click See Extraction Results and the preview fails, IQ Bot now correctly displays the following error message after a timeout of 2 minutes: <code>Error occurred while extracting the document. Please re-check the training/document. Previously, when the preview failed, the page kept loading indefinitely.</code>
00674110	Production documents are now moved to the <i>Validator</i> without any errors, irrespective of how the bot was trained (number pages, number of segments in each page, or number of tables and fields extracted).

Known limitations	
IQ Bot On-Premises and Cloud	In the table area of the Validator, if you add a new row, enter a value, and then delete this row, the value of the next row is replaced by the content you entered in the deleted row.
IQ Bot On-Premises and Cloud	In the Validator, when you click any validated field and then click any other cell, the value in the validated field is deleted.
IQ Bot On-Premises and Cloud	When you upload a document to production immediately after deleting a bot it was associated with, extraction results are not displayed. Workaround: Use one of the following options: <ul style="list-style-type: none"> • Select the Disable cache option in the Network tab. • Ensure you wait at least 3 minutes between deleting the bot and uploading the document. • Empty the cache and reload the page.
IQ Bot On-Premises and Cloud	You cannot use Express mode to install IQ Bot.
IQ Bot On-Premises and Cloud	Numerals in the Polish language are not accepted or validated in the Validator.
IQ Bot On-Premises and Cloud	If you create a user role with 2-byte non-English characters, services fail with an <code>invalid characters</code> message.
IQ Bot On-Premises and Cloud	If the name of a learning instance has both English and Arabic characters, the time stamp of the backup file is appended in between the filename.

Known limitations
<p data-bbox="289 205 649 235">IQ Bot On-Premises and Cloud</p> <p data-bbox="289 254 1446 315">You cannot use the draw functionality to generate an SIR when you zoom in on a document in the Validator.</p>
<p data-bbox="289 342 524 371">IQ Bot On-Premises</p> <p data-bbox="289 390 959 420">After installing IQ Bot, MLWeb services stops responding.</p> <p data-bbox="289 438 1019 468">Workaround: Manually stop and restart the MLWeb services.</p>
<p data-bbox="289 495 524 525">IQ Bot On-Premises</p> <p data-bbox="289 543 1438 604">If you add a new language after upgrading to IQ Bot A2019, the Learning Instance page is not displayed due to Language API cache issues.</p> <p data-bbox="289 623 1019 653">Workaround: Clear the cache and restart the IQ Bot service.</p>
<p data-bbox="289 682 649 711">IQ Bot On-Premises and Cloud</p> <p data-bbox="289 730 1446 791">If you try to process a PDF document with pdfboxOCR enabled, the SIRs are not placed correctly on the check boxes.</p> <p data-bbox="289 810 1192 840">Workaround: Disable the pdfbox OCR when you create a learning instance.</p>
<p data-bbox="289 865 649 894">IQ Bot On-Premises and Cloud</p> <p data-bbox="289 913 1458 974">If you create a learning instance with Auto Checkbox Detection enabled, check box SIRs cannot be selected.</p> <p data-bbox="289 993 1382 1022">Workaround: Draw on top of the check box SIR instead of selecting the identified SIR field.</p>
<p data-bbox="289 1050 649 1079">IQ Bot On-Premises and Cloud</p> <p data-bbox="289 1098 1463 1199">Starting with IQ Bot A2019.17, the default OCR engine is changed to ABBYY FineReader Engine 12.4 from the previous 12.2 version. Therefore, if you have migrated learning instances from earlier versions, you might have to retrain your bots because there could be a change in segmentation.</p>
<p data-bbox="289 1220 649 1249">IQ Bot On-Premises and Cloud</p> <p data-bbox="289 1268 1435 1329">The Default validations group is not overwritten on the imported learning instance even when the Overwrite option is used when you import that learning instance.</p> <p data-bbox="289 1348 1393 1409">Workaround: Edit the learning instance after importing the IQBA file and change the default group.</p>
<p data-bbox="289 1436 649 1465">IQ Bot On-Premises and Cloud</p> <p data-bbox="289 1484 1446 1585">A learning instance is exported as an IQBA file that contains <code>Projectdetails.csv</code>. When you extract this <code>.csv</code> file, the column header name for the Default validations group in the table is not available. However, the corresponding value in that column is available.</p>
<p data-bbox="289 1606 649 1635">IQ Bot On-Premises and Cloud</p> <p data-bbox="289 1654 1390 1715">If you re-import an IQBA file for a deleted learning instance, the Default validations group setting available in that IQBA file is not applied to the learning instance.</p> <p data-bbox="289 1734 1393 1795">Workaround: Edit the learning instance after importing the IQBA file and change the default group.</p>

Bot Insight

New features
<p>New AARI dashboard in Bot Insight</p> <p>Use the AARI dashboard to view various widgets that provide information about requests created from published processes in AARI. The dashboard also provides statistics on the status of created requests.</p> <p>AARI dashboard</p>

Security fixes	
Service Cloud case ID	Description
--	The Allow Header HTTP header is removed from Bot Insight.

Supported packages

Package	Version
Application	2.1.0-20200921-085720
App Integration	1.1.0-20201014-042506
Analyze	2.2.4-20200903-113949
Active Directory	2.1.0-20200921-085716
Boolean	2.1.0-20201014-042509
Bot Migration	2.5.0-20200902-045043
Browser	2.1.0-20201002-123733
Clipboard	2.1.0-20201014-042520
Comment	2.2.0-20201014-042520
CSV/TXT	2.3.0-20201014-082525
Database	2.2.0-20201013-052941
Data Table	2.3.0-20201030-143334
Datetime	2.2.0-20201014-042531
Delay	2.2.0-20201014-042532
Dictionary	3.2.0-20201014-042532
Run DLL	3.2.0-20201105-205159
Email	3.1.0-20201104-062204
Error handler	2.2.0-20201014-042541
Excel basic	2.3.0-20201027-160012
Excel advanced	5.1.0-20201027-155758

Package	Version
File	3.1.0-20201016-065515
File & folders	1.1.0-20201023-202725
Folder	3.0.0-20201016-065517
FTP / SFTP	2.1.0-20200921-085757
IF/ELSE	2.1.0-20200921-085758
Image Recognition	2.1.0-20201014-042552
Interactive forms	2.17.3-20201102-103733
IQ Bot	2.1.0-20201013-095304
JavaScript	2.3.0-20201104-062431
Simulate keystrokes	2.4.0-20201021-163833
Legacy Automation	3.2.0-20201104-062439 1.3.0-20201105-151906
List	2.2.0-20201014-042806
Log To File	2.2.0-20201014-042806
Loop	2.1.0-20201014-042808
Message Box	2.1.0-20201014-042808
Migration	2.7.0-20201106-072418
Mouse	2.1.0-20201014-042814
Number	2.1.0-20201014-042823
OCR	2.2.0-20201104-062503
Office 365 Excel	2.2.0-20201104-062559
Office 365 Calendar	2.1.0-20200921-085726
Office 365 OneDrive	2.1.0-20201014-042924
PDF	2.5.0-20201014-042929
PGP	2.2.0-20201014-042931
Ping	2.1.0-20201014-042932
Printer	2.1.0-20200921-090131
Play Sound	2.1.0-20200921-090123
Prompt	2.1.0-20200918-081201
Python Script	2.3.0-20201105-204912
Recorder	2.0.9-20201105-164103
REST Web Service	3.1.0-20200928-231420
SAP	2.2.0-20200921-090209
Screen	2.1.0-20201014-043037

Package	Version
SNMP	2.1.0-20201014-043041
Service	3.0.0-20200921-090214
SOAP Web Service	3.1.0-20200921-090219
String	3.1.0-20201014-043052
System	3.0.0-20200921-090225
Task	2.0.1-20201023-202703
Terminal Emulator	3.4.0-20201028-021451
Trigger Email	1.1.0-20201105-152220
VBScript	2.3.0-20201105-205228
Wait	3.1.0-20201014-043117
Window	2.2.0-20201022-121649
Workload	2.3.0-20201105-205233
XML	2.1.0-20201014-043121

Related reference

[Community Edition A2019.17 Release Notes](#)

Enterprise A2019.16 Release Notes

Release date: 28 September 2020

Review the new features, supported packages, changed features, fixed features, security fixes, and known limitations in the Enterprise A2019.16 (Build 6463) release. IQ Bot is on Build 6443.

Important: We have updated Enterprise A2019.16 to Build 6463 to include fixes for issues with checking in and checking out bots (Service Cloud case ID 00666880, 00670899, 00672441, 00670455, 00672346), and Universal Recorder (Service Cloud case ID 00664020). See the [Fixed features](#) section for more information.

- [Enterprise A2019](#)
- [Discovery Bot](#)
- [IQ Bot](#)
- [Bot Insight](#)
- [Automation Anywhere Robotic Interface \(AARI\)](#)

Enterprise A2019

Bot agent update: This release includes a required update to your . Ensure that you complete the update to continue with your automation activities when upgrading from a previous release to this release.

[Automatically update the Bot Agent](#) | [Manually update the Bot Agent](#)

To verify which version is compatible with this release, see [Compatibility with Automation 360 builds](#).

New features

Migration to Enterprise A2019 (currently available only to customers in the Migration Early Adopter Program)

Enterprise A2019

Migration to Enterprise A2019 is currently only available to select customers through our Migration Early Adopter Program. If you are interested in learning more about this program or a timeline for when migration will be available to all customers, contact your Automation Anywhere representative.

- **Enterprise 11 only**

- Migrate audit logs to Enterprise A2019.

[Migrate Enterprise 11 audit logs](#)

- Migrate bots that contain disabled commands that have validation errors.
- Migrate bots that contain **Delete**, **Delete All Messages**, and **Get All Messages** commands to automate an email-related task on Exchange Web Services (EWS).

- **Enterprise 10 only**

Migrate user credentials to the Enterprise A2019 Credential Vault.

[How Enterprise 10 data is copied to Automation 360](#)

- **Enterprise 11 and Enterprise 10**

- Migrate bots that contain the **Variable Operation** command, which re-initializes the row and column index of an array variable using a variable.
- Migrate bots that run MetaBot Logic and return the values to a dictionary variable.
- Migrate MetaBots that contain DLLs that use lists, values, arrays, and two-dimensional arrays as input and output.

[How MetaBots are migrated](#)

- Migrate bots that contain **Send Email** with **Attach Variable** option from the Error Handling command to the Enterprise A2019 Error handler package.

[Package mapping for migration](#)

- Migrate bots that contain the **Image** and **Coordinates** play modes from the Object Cloning command to the Recorder package in Enterprise A2019.

[Package mapping for migration](#)

- Migrate bots that contain credential variables in select commands such as Active Directory, Excel, REST Web Service, and Terminal Emulator to Enterprise A2019.

For the complete list of commands, see *[Variable mapping for migration](#)*.

Support for using CSV and TXT files as databases

Enterprise A2019 and Community Edition

Use the actions from the Database package to connect with and perform create, read, and update operations on the file.

[Using Connect action for database](#) | [Database package](#)

New features
<p>Universal Recorder support for standard Microsoft controls in Microsoft Silverlight</p> <p>Enterprise A2019 and Community Edition</p> <p>The Universal Recorder can now capture calendars, buttons, check boxes, combo boxes, date pickers, labels, links, list views, radio buttons, sliders, tabs, tables, text boxes, and trees from applications running Microsoft Silverlight version 5.</p>
<p>Use variable to specify a child bot to run</p> <p>Enterprise A2019</p> <p>Use the Control Room path in the Run action of the Task Bot package to use a string variable to specify the child bot you want to run.</p> <p>Task Bot package</p>
<p>Install Bot Agent in bulk using registration key (Service Cloud case ID: 00616591)</p> <p>Enterprise A2019</p> <p>As an Control Room administrator, you can generate a registration key from the Control Room settings to install Bot Agent in bulk on multiple devices. You can use the registration key in an installation script or as part of the Active Directory group policy for configuring the Control Room users.</p> <p>Generate registration key to install Bot Agent in bulk</p>
<p>Automatically detect proxy settings for Bot Agent installation to support NTLM authentication (Service Cloud case ID: 00446932, 00639773)</p> <p>Enterprise A2019 and Community Edition</p> <p>The proxy settings for a Bot Agent are automatically detected if the Automatically detect settings option is selected in the LAN settings for a System user and Current user on the machine where the Bot Agent is installed. This allows Control Room users to be authenticated using NTLM.</p>
<p>Restrict network access to Cloud Control Room URL</p> <p>Enterprise A2019</p> <p>System administrators can restrict access to the Cloud Control Room URL from only those IP addresses within the corporate network for more granular security. The Automation Anywhere Control Room provides the ability to specify a list of IP addresses or IP subnets that are allowed for Cloud Control Room URL and API access. Enterprise A2019 users with Control Room administrator privileges, such as to access Administration > Settings, can view, add, or edit this list.</p> <p>Add access IP addresses</p>
<p>Add Elasticsearch credentials for enhanced monitoring and alerting</p> <p>Enterprise A2019</p> <p>An option to provide Elasticsearch credentials is now available in the installer because the updated Elasticsearch version 7.8 configured for Control Room uses Open Distro version 1.9.0. This feature enables the server to deploy an enhanced monitoring and alerting system.</p> <p>Add Elasticsearch credentials</p>

New features
<p>Support for Chinese, Japanese, and Korean characters in variable names</p> <p>Enterprise A2019 and Community Edition</p> <p>You can now create variables with names containing Chinese, Japanese, or Korean characters. You can also migrate bots that contain variables named using these characters.</p> <p>Unicode range supported in variables</p>
<p>Support for Chinese language for Terminal Emulator (Service Cloud case ID: 00500324)</p> <p>Enterprise A2019</p> <p>You can now use the simplified and traditional Chinese language with 5250E terminal DBCS models such as IBM 5555-C01 and IBM 5555-B01.</p>
<p>New Services package available</p> <p>Enterprise A2019 and Community Edition</p> <p>Use the new Services package to automate operations and application services. You can start, stop, pause, resume, or to get the status of a Windows or application service.</p> <p>Service package</p>
<p>Enhancements to the Excel advanced package</p> <p>Enterprise A2019 and Community Edition</p> <p>In the Excel advanced package, you can now use Read value from a cell. You can choose the Read option to read either visible text or the value from the cell. The default option is set to Read visible text in cell.</p> <p>For example, if the cell has \$50 as the value, then the Read cell value option reads the value as 50, ignoring the currency format. The Read visible text option reads the content along with currency format as \$50.</p> <p>This option is available for the following actions:</p> <ul style="list-style-type: none"> • Get single cell • Get multiple cells • Read row • Read column • Get worksheet as datatable • Loop <p>Cell operations in Excel advanced Row and column operations in Excel advanced Loop package</p>
<p>Automate a task on a range of cells in an Excel worksheet (Service Cloud case ID: 00651299)</p> <p>Enterprise A2019 and Community Edition</p> <p>In the Excel advanced package, you can perform operations on the range of cells for Go to cell and Set Cell actions.</p> <p>Cell operations in Excel advanced</p>

New features
<p>New condition in the If and Loop packages</p> <p>Enterprise A2019 and Community Edition</p> <p>Use the Service is running or Service is not running condition to execute actions based on whether a particular service is running or not. For example, when you send a mail using this condition, the bot can verify if the SMTP service is running or not.</p> <p>If package Loop package</p>
<p>Capture hidden objects using AISense Recorder</p> <p>Enterprise A2019</p> <p>Use AISense Recorder to capture hidden image buttons on the application screen.</p> <p>Edit a task recorded using AISense</p>
<p>New operations on SAP captured objects</p> <p>Enterprise A2019</p> <p>Use new options that are available to perform operations such as Set Focus and Select item by key for the various objects captured from an SAP application.</p>
<p>Pass parameters of various types to a DLL function</p> <p>Enterprise A2019</p> <p>Use the new Run function action to pass parameters of various types to a DLL function. The Run function that was available in earlier versions is now renamed to Run function (Legacy) and enables you to pass only dictionary variable as parameter to a DLL function.</p> <p>Using the Run function action Using the Run function (Legacy) action</p>
<p>Form builder updates</p> <p>Enterprise A2019</p> <p>The form builder now includes the following new elements:</p> <ul style="list-style-type: none"> • Rich text editor- Enables you to add a customizable element to the form. • Table- Enables you to add tables to a form. <p>Create a form</p>
<p>Enhancements to the form preview</p> <p>Enterprise A2019</p> <p>When you click the Preview option in the form builder screen, you can drag the form. The corresponding X and Y coordinates are updated automatically.</p>
<p>Enhancement to the Snapshot element</p> <p>Enterprise A2019</p> <p>You can now create a folder if the filepath is not available or change the destination folder of the snapshot file during bot runtime.</p> <p>Using the Snapshot element</p>

New features
<p>Update to the Interactive forms package</p> <p>Enterprise A2019</p> <p>Use the Validate form action to validate all the elements of a selected form.</p> <p>Interactive forms package</p>
<p>New permission to view basic information about users and roles (Service Cloud case ID: 00491694)</p> <p>Enterprise A2019</p> <p>The View Users and Roles basic information permission enables you to view the names of users and roles when you are performing various tasks in the Control Room. For example, a user must have this permission to view the roles that can be assigned to a user when creating or editing that user. After you upgrade from an earlier version to this release, this permission is granted to all existing roles.</p>
<p>Securely pass values in header and parameters of calls to a REST or SOAP web service</p> <p>Enterprise A2019 and Community Edition</p> <p>Credential variables enable users to retrieve sensitive values from the Credential Vault and pass them to the web service. Use credential variables in the header or parameter fields of actions from the REST Web Service or SOAP Web Service package.</p> <p>Credentials and credential variables in the Bot editor REST Web Service package SOAP Web Service package</p>
<p>Return system parameters of the device on which a bot is running</p> <p>Enterprise A2019 and Community Edition</p> <p>Use the Get environment variable action from the System package to return the system parameters, including HomePath, ProgramData, ProgramFiles, SystemRoot, and UserDomain.</p> <p>Environment variables for System package</p>
<p>Remove Git integration configuration (Service Cloud case ID: 00633948)</p> <p>Enterprise A2019</p> <p>You can now remove or disable a Git integration configuration from your Control Room when the bot information stored in your Control Room does not have to be synchronized with the remote Git host.</p> <p>Remove Git integration configuration</p>
<p>Expanded data type support in DLL package</p> <p>Enterprise A2019 and Community Edition</p> <p>The DLL package now accepts table variables as input parameters or to hold action output.</p> <p>Using the Run function (Legacy) action</p>
<p>Create variable within Dictionary > Assign and List > Assign actions</p> <p>Enterprise A2019 and Community Edition</p> <p>The Assign action from the Dictionary and List packages now offers users the option to create a new variable within the Select source variable field. Previously, users could only select a variable from a list of existing variables.</p>

New features
<p>New API for license management</p> <p>Enterprise A2019</p> <p>The License API contains endpoints to retrieve Control Room license details (such as the expiration date and license mode) and to update the Control Room after license reallocation or renewals.</p> <p>License API</p>
<p>New expression in the Legacy Automation package</p> <p>Enterprise A2019</p> <p>The List to table expression supports migrated bots containing a variable that has to be converted from a list type to a table type.</p> <p>Legacy Automation package</p>
<p>Multi-user device sessions on terminal servers</p> <p>Enterprise A2019</p> <p>Multi-user device sessions are now supported on terminal servers. You can perform the following actions:</p> <ul style="list-style-type: none"> • Set screen resolution at either the device or Control Room level. • Set a multi-user device as the default device for Bot Creator users and attended and unattended Bot Runner users. • As a licensed user (with a default device), set another device as your default device using the Make default device option from the device menu. • View and edit the device settings on the device landing page. <p>The device landing page shows additional information about the user-provided device name (device nickname), device type, and the default user.</p> <ul style="list-style-type: none"> • Convert an existing device to a multi-user device in order to share the same device between Bot Runner and Bot Creator users who can then coexist in different sessions simultaneously. (Service Cloud case ID: 00624046) <p>About multi-user devices Convert an existing device to a multi-user device Configure RDP-based deployment for multi-user devices</p>

Supported packages	
Package	Version
Node Manager	14.1.7079
Application	2.1.0-20200819-064505
App Integration	1.1.0-20200825-070948
Analyze	2.2.4-20200903-113949
Active Directory	2.1.0-20200825-070945
Boolean	2.1.0-20200831-031000
Bot Migration	2.5.0-20200902-045043
Browser	2.1.0-20200825-071008
Clipboard	2.1.0-20200831-031014

Supported packages	
Package	Version
Comment	2.1.0-20200831-031015
CSV/TXT	2.3.0-20200825-071131
Database	2.1.0-20200913-060112
Data Table	2.1.0-20200831-031946
Datetime	2.2.0-20200831-031025
Delay	2.2.0-20200831-031026
Dictionary	3.2.0-20200831-031027
Run DLL	3.0.0-20200831-110441
Email	3.0.0-20200901-105426
Error handler	2.1.0-20200831-031055
Excel basic	2.1.0-20200831-031843
Excel advanced	5.0.0-20200909-124042
File	2.2.0-20200831-031057
File & folders	1.1.0-20200907-073046
Folder	2.2.0-20200831-031100
FTP / SFTP	2.1.0-20200825-071155
IF/ELSE	2.1.0-20200825-071156
Image Recognition	2.1.0-20200825-071159
Interactive forms	2.16.0-20200914-151814
IQ Bot	2.1.0-20200901-105449
JavaScript	2.1.0-20200831-031525
Simulate keystrokes	2.3.0-20200901-093759
Legacy Automation	3.1.0-20200831-031532 1.1.0-20200825-071342
List	2.2.0-20200831-031539
Log To File	2.2.0-20200831-031539
Loop	2.1.0-20200831-031540
Message Box	2.1.0-20200831-031541
Migration	2.5.0-20200902-045043
Mouse	2.1.0-20200831-031542
Number	2.1.0-20200831-031551
OCR	2.2.0-20200825-071359
Office 365 Excel	2.1.0-20200825-071452

Supported packages	
Package	Version
Office 365 Calendar	2.1.0-20200825-071013
Office 365 OneDrive	2.1.0-20200825-071459
PDF	2.5.0-20200831-031836
PGP	2.2.0-20200831-031838
Ping	2.1.0-20200831-031839
Printer	2.1.0-20200825-071516
Play Sound	2.1.0-20200825-071509
Prompt	2.1.0-20200824-092056
Python Script	2.1.0-20200831-031850
Recorder	2.0.8-20201009-015051
REST Web Service	3.1.0-20200824-092129
SAP	2.2.0-20200825-071614
Screen	2.1.0-20200825-071618
SNMP	2.1.0-20200825-071620
Service	3.0.0-20200821-060952
SOAP Web Service	3.1.0-20200827-210959
String	3.1.0-20200831-031943
System	3.0.0-20200831-031944
Task	2.0.1-20200907-072949
Terminal Emulator	3.3.0-20200831-031950
Trigger Email	1.1.0-20200903-114514
VBScript	2.1.0-20200831-031953
Wait	3.1.0-20200831-031955
Window	2.1.0-20200813-181240
Workload	2.1.0-20200825-071644
XML	2.1.0-20200831-031958

Changed features
<p>Enhanced Capture area action in OCR package</p> <p>The Capture area action now captures text from the visible area of the screen even if the target area is below the visible screen. Previously, the bot showed an error when the captured area was below the visible screen.</p> <p><i>Using Capture area action from OCR package</i></p>

Changed features
<p>Bot Scanner update</p> <p>The Bot Scanner now displays error messages for bots that cannot be migrated to Enterprise A2019 in the summary report.</p> <p>Analyze Bot Scanner report for migration</p>
<p>Flow view update</p> <p>A line number is now displayed for each action in the Flow view of the Bot editor.</p>
<p>CSV/TXT package update</p> <p>The CSV/TXT package processes a space as character. For example, if your CSV or text file includes <code>January, "March, April"</code>, then the output is displayed in the following format:</p> <p>January "March (space before the double quotation mark) April"</p> <p>If the CSV or text file contains the same information but without a space between January and March (for example, <code>January, "March, April"</code>), then the output is displayed in the following format:</p> <p>January March, April</p>
<p>Upgrade for resilient bot deployment</p> <p>After you upgrade the Control Room and Bot Agent to Enterprise A2019.16, scheduled and queued bots are not terminated. This is part of the resiliency improvements where the Control Room and Bot Agent are set in a consistent state. As a result, the device reconnects to the Control Room if there are any network disruptions, and scheduled and queued bots are deployed.</p> <hr/> <p>Important: During the upgrade to Enterprise A2019.16, all bots that are running will be terminated. After the upgrade, if the system is in an inconsistent state, restart the Bot Agent so that the system is in a consistent state.</p> <hr/>
<p>Internet Explorer waits for completion before initiating Recorder action</p> <p>When you use the Recorder package, the bot now waits for the Internet Explorer browser to finish loading the page before executing any action. This enhances the reliability of the bot by preventing it from failing while the page is loading. For example, the Recorder does not try to search the object before the web page is fully loaded.</p> <p>Using the Capture action</p>
<p>High availability enhancement</p> <p>Starting from this release, configure the required minimum three Control Room nodes in an Enterprise A2019 data center cluster for high availability deployment.</p> <p>High availability deployment</p>

The following table lists the fixed features and the builds in which they were fixed (Build 6463 is the latest build, and Build 6453, and Build 6448 are previous builds). The fixes are cumulatively available in the latest build.

Fixed features		
Build number	Service Cloud case ID	Description
6463	00644915	The Bot Agent now checks for additional SSL certificate from the Windows CERT_SYSTEM_STORE_LOCAL_MACHINE system stores in addition to the Java Credential Store. This allows the Bot Agent to be updated automatically from an earlier release to this release.
6463	00666880, 00670899, 00672441, 00670455, 00672346	Bot files or dependencies are no longer lost when you check in or check out a bot from the private or public workspace. Previously, an error occurred while either checking in or checking out a bot, and the bot files or dependencies were lost and could not be recovered.
6463	00664020	You can now successfully run a bot that contains the Capture action from the Recorder package with both the <code>HTML InnerText</code> and <code>InnerHTML</code> object properties selected.
6463	--	Fixed an issue where the Universal Recorder failed to perform a click, set text, or append text action on the correct control in Google Chrome when a debug window or download bar was open.
6453	00669040, 00669164, 00668923, 669332, 00669473, 00671509, 00669178	The Automation Anywhere Elastic Search Service now restarts during the certificate retrieval process when you upgrade from Enterprise A2019.15 to Enterprise A2019.16. However, if you encounter any issues with the Automation Anywhere Elastic Search Service during the restart, see Automation 360 v.16 upgrade error: Elasticsearch Service fail to start during certificate retrieval process (A-People login required) .
6448	00573048	You can now preview table variables in debug mode and validate the bot logic. Previously, watch variables containing Japanese and Chinese characters did not display values in the table variable.
6448	00656475	The Bot Deploy API call now consecutively executes all the runAs users that are set in the runAsUserIds parameter.
6448	00569832, 00628474, 00656267	The device registration issue due to Bot Agent version extraction is now fixed. The exception of "for input string null" no longer occurs.

Fixed features		
Build number	Service Cloud case ID	Description
6448	00609073	You can now successfully integrate your Control Room with your remote Git repository without any error. Previously, the Git integration failed because of a 404 error.
6448	00632444, 00626829, 00667531	When you import a main task containing subtasks using the overwrite option, the dependent subtask references are no longer deleted for other existing main tasks that use the same subtasks. As a result, the execution of other main tasks containing the same dependent subtasks does not fail.
6448	00501208, 00572346	For the Create user event name, the audit log now properly displays the username who created that user in the Event Started By column. Previously, the same column did not display any value.
6448	00616202, 00637626, 00653919, 00664039, 00664744	When the debug log is enabled in logs configuration and you use the For each row in a SQL query dataset option from the Loop action to iterate each row, the iteration now completes without any error. Previously, the iteration failed because of a change in the debug log configuration.
6448	00653064	After the caching service is restarted, the bot execution no longer fails. The caching client instances are reconnected and reinitialized after the restart.
6448	00577612	In a bot with dependencies, if you check out and edit a child bot in your private workspace and later check out the parent bot, you will no longer lose the changes made to the checked-out child bot. Previously, changes made to the child bot were overwritten.
6448	00623154	When a Bot Creator that does not have create folder permission tries to check in a bot to the public workspace, an appropriate error message is now recorded in the audit log, indicating the specific reason for the failure. Previously, the audit log recorded an <code>unexpected error occurred</code> message.
6448	00622977	In the Edit role page, file permissions are now correctly aligned in Internet Explorer. Previously, the Delete from Public option was displayed below the Select all option. As a result, the folder and permissions were not placed next to each other.

Fixed features		
Build number	Service Cloud case ID	Description
6448	00615437	You can now migrate MetaBots that contain input and output type variables with a description containing unsupported characters such as quotation marks (") and forward slash (/).
6448	00636169	The Control Room now disables a user account when the number of consecutive failed login attempts specified in the Control Room settings is reached or exceeded.
6448	00530550	A variable now returns the correct value when the regional setting of the device is set to the Brazilian metric system.
6448	00604893	A bot no longer encounters an error when the system cannot finish pre-processing the bot due to an ignite cache issue.
6448	00578277	An error is no longer encountered when the Connect and Disconnect actions of the SAP package are used in a loop and the iteration is set to more than 500 times.
6448	00635890	The Bot Scanner now scans all the bots in a repository and displays the correct count of child bots.
6448	00634238	You can now use the form builder in Internet Explorer (version 11 or later) to add more items to the Checkbox and Radio Button elements without encountering any issues.
6448	--	For the Select file element, you can now upload a file with a dot (.) in the filename. For example, <i>Sales.March.jpg</i> .
6448	--	Software version notification for Cloud was not always displayed in the UI. This issue is now fixed.
6448	00633793	You can run a bot when the operational parameter is used in the SOAP Web Service action. Previously, the bot encountered errors when the operational parameter was used in the action and the corresponding <code>wsdl</code> file did not have the <code>elementFormDefault</code> attribute.
6448	00630975	Captured images in a nested If action are now retained when you check in a bot to the public repository. Previously, when using any action that used an image in a nested If action, the image nested was missing after the check-in.

Fixed features		
Build number	Service Cloud case ID	Description
6448	00630004	When loop is used to read all Unread emails, the emails are now marked as Read only after emails are read. Previously, all unread emails were marked as read when a Loop Break action was used.
6448	00612913	In Excel Advanced > Remove blank rows , when you select the Specific row option and set A1 as the beginning cell, an error is no longer encountered when you run the bot.
6448	00608265	In the CSV/TXT package, when you use Japanese OS ANSI (Shift-JIS) as encoding to read text file content, the Japanese Shift-JIS characters are now displayed correctly.
6448	00568718	Japanese language supported pop-up messages no longer appear truncated when multiple bots are deleted.
6448	00598023, 00611480	In the DLL package, Run function now works properly and does not display an error or show broken characters when the parameter includes Japanese characters.
6448	00638120	When you upgrade from an earlier version of Enterprise A2019 to a later version and change the If package version to the latest one, multiple conditions now appear in If/Else If after the If package is upgraded. Previously, some of the conditions did not show in the logic.
6448	00632228, 00649606	You can now use the Send Email action when the package version is different in the task and subtask. Previously, the Send Email action in the Email package had issues when the task and subtask had a different package version.
6448	00544219, 00635206	The Get cell action in Excel Advanced can now be used without any error. You can use the Read option to read visible data or the exact value of the cell.
6448	00646254, 00650712, 00653137, 00658122, 00666883	You can now change the package version of the If package. Previously, if there were multiple conditions in the If action, the system did not allow you to change the package version.

Fixed features		
Build number	Service Cloud case ID	Description
6448	00613453	Version 11.3 bots that used the Object Cloning command to find interface objects using coordinates or image recognition are now migrated to Enterprise A2019 with the Mouse > Click action, Simulate keystrokes action, OCR > Capture area action, or Image recognition > Find window in window action.
6448	--	When you run migrated bots that perform mathematical operations on values containing decimals or commas, the output from Enterprise A2019 now matches the output from Version 11.3.5. Previously, an operation that resulted in an output of 0.999 in Version 11.3 resulted in an output of 0.9899999 in Enterprise A2019.
6448	00467664	Fixed an issue where the Universal Recorder entered characters in a text box incorrectly when the user configured the Keystrokes field using a Japanese keyboard.
6448	00630545, 00631418, 00621875	You can now assign input values from a parent bot in the Task Bot > Run action. Previously, an issue caused input values to disappear when a bot containing more than two input values was saved.
6448	--	The Workload In progress activity page now displays the Workload bot name instead of the automation name.
6448	00635306	Fixed an issue where a red error screen appeared if a bot attempted to pass a file variable to another bot.
6448	00635326	You can now run bots built using Recorder package versions from earlier builds.
6448	00616261	You can now pass credential values to the main bot when you deploy it from the Run bot now page.
6448	00647135, 00647652, 00647665, 00647144, 00648742, 00646535, 00648883, 00648980, 00654937, 00657039, 00664049, 00663797, 00664138, 00667384	When you upgrade to the latest version of Enterprise A2019, bots in queued state now run without any issues because a new token is automatically generated when an existing session expires.
6448	00611109	Fixed an issue where the <code>System:CPUUsage</code> system variable returned an inaccurate value.

Fixed features		
Build number	Service Cloud case ID	Description
6448	00647239	In the Data Table package, when you use the Merge action to merge two data tables, the data is now properly merged and the merged content stores the correct data in the result data table. Previously, the Merge action had issues when no header data in a table was extracted, resulting in incorrect data export to CSV file.
6448	00444907, 00556374, 00582469, 00628801, 00624681, 00632668	A bot launcher error for a user session is no longer displayed when you run a bot on a Bot Agent device registered to a user who is assigned developer privileges.

Security fixes	
Service Cloud case ID	Description
00552076	The vulnerabilities found in Elasticsearch in Enterprise A2019 are now addressed.
00631233	In the Database package, when you connect to the database, the username and password are no longer visible in the logs.

Known limitations
<p>When you are upgrading from an earlier version of Enterprise A2019 to the current version, the system displays the error message <i>Self Sign Certificate Failure</i>, and the installation process is rolled back if both the following conditions occur:</p> <ol style="list-style-type: none"> 1. The earlier version was installed on a non-default installation path instead of the default path (C:\Program Files\Automation Anywhere\Enterprise). For example, the previous version was installed on D:\Program Files\Automation Anywhere\Enterprise. 2. You also select Yes to retain the current installation parameters during upgrade in the message window that appears after the Welcome screen when the installation wizard detects an earlier version. <p>Workaround: Select No so that you can choose to enter the installation parameters during the upgrade.</p> <p><i>Control Room upgrade fails with self signed certificate failure error (A-People login required)</i></p>
<p>Service Cloud case ID: 00672719, 00673048</p> <p>When you are upgrading the Control Room to the current version, the installer uses an existing or creates a new Elasticsearch data folder in the default path (C:\ProgramData\AutomationAnywhere\elasticsearch\data) if the Elasticsearch data from the earlier version is saved to a non-default path. Therefore, the earlier Elasticsearch data and audit logs will not be available after the upgrade.</p> <p>Workaround: Before upgrading to the current version, copy the existing Elasticsearch data from the non-default path to the default path.</p>

Known limitations
When an Automation Anywhere package is manually uploaded using the Control Room interface, the Vendor column should show Automation Anywhere. Instead, the interface displays <i>Unspecified</i> . Automation Anywhere packages that are installed on a server as a part of an upgrade show the Vendor as Automation Anywhere, which is expected.
For existing device sessions, you cannot use the option to enforce the resolution set at either the device or Control Room level. The screen resolution set at these levels only work for new device sessions.
When attended and unattended Bot Runners are run concurrently, attended Bot Runner users are queued until the unattended Bot Runner session becomes available. This occurs even when the number of allowed concurrent sessions is not exceeded. For an attended Bot Runner user deployment, use a single user session to stop them from being queued.
When a user connects to a multi-user device and sets it as their default device, they are taken through the device registration wizard to enable the Google Chrome plug-in. During the registration process, users are allowed to select the device type and the concurrent sessions value. Users must ensure that they set the same value for the concurrent sessions as set by the administrator. If there is a difference in the value, other users will be impacted.
When a bot is deployed through RDP with a predefined screen resolution, the RDP resolution settings are not applied correctly during bot execution. The bot is executed with an interchanged resolution (the height and width pixels are interchanged). For example, if the resolution for bot deployment is set as 1366x768, the bot is deployed with the resolution 768x1366. Workaround: For information about how to resolve this issue, see Automation 360 v.16 - RDP based deployment does not run bot with pre-defined set screen resolution (A-People login required) .
The element label or text appears distorted during bot runtime when you add it in Japanese or any other non-English language, and the Font name is set to System default .
Service Cloud case ID: 00667210 In Excel advanced, you cannot use the Go to cell action if the Excel sheet does not have data or if an active cell is out of the worksheet range. This issue is encountered when you use the Go to cell action and choose the cell option as Active cell with the Beginning of the row, End of the row, Beginning of the column or End of the column option. Workaround: Use the earlier version of the Excel advanced package 4.0.0-20200723-234413 released with Enterprise A2019.15.
HTTP authenticated proxy is not supported for On-Premises users.

Discovery Bot

New features
Discovery Bot installer integrated with Enterprise A2019 installer Enterprise A2019 The Discovery Bot installer is now integrated with the Enterprise A2019 installer. No separate installation is required for Discovery Bot On-Premises users. Discovery Bot supports custom installation for Windows. Prerequisites for Discovery Bot

New features
<p>Create multi-role users</p> <p>Enterprise A2019</p> <p>Combine up to three Discovery Bot system-generated roles and two process discovery licenses to provide additional functionality for your users.</p> <p>Create multi-role users for Discovery Bot</p>
<p>Create custom role user</p> <p>Enterprise A2019</p> <p>Create a unique custom role using the permissions from the Discovery Bot standard user roles (Admin, Business user, or Analyst roles).</p> <p>Create a custom role for Discovery Bot</p>
<p>Manual aggregated view integrated with Dashboard tab</p> <p>Enterprise A2019</p> <p>The Manual aggregated view is now integrated with the Dashboard tab. You can now select and display recordings and views from the Dashboard, Aggregated, and Comparison tabs, enabling you to make a change in one tab that will persist across all tabs. This feature enables a synchronized representation of your metadata for views and recordings.</p>
<p>Internalization, localization, and language support for Discovery Bot</p> <p>Enterprise A2019</p> <p>Internalization and localization is now supported for Discovery Bot. For example, you can automate and translate the UI for your region in French, Spanish, and Italian, among other languages supported.</p> <p>Internationalization, localization, and language support</p>

Fixed features	
Service Cloud case ID	Description
--	You can now sort on the recording ID. The recent recording (ID) created now displays at the beginning of the list in the Recordings table.
--	When editing the aggregated view, you can now move the endpoint upward in the path flow to change the selection of the steps. You can also move the branch endpoint lower in the path flow to include more than one step.
--	You can now select partial steps in a branch, and create and save an opportunity from the Opportunities tab.
--	The copy field now displays the correct view information from the view (view ID) that it is copied from.
00673381	If you are using an instance in an AWS special region, you can now view recordings for users that are successfully completed (not canceled by the user).

Known limitations
When manually editing an aggregated view, if you create a branch in the process flow where a step was deleted, the step will be missing on the left side of the branch. To add a step on the left side, you can drag the branch endpoint (small circle) down (below the next step) in the process flow to add a step back in the branch. <i>Missing step observed in aggregated view while using A2019.16 Discovery Bot (A-People login required)</i>
When an opportunity is created with 300+ steps, exporting the opportunity to Microsoft Word will fail.
The Convert to Bot option fails when an opportunity contains 140 or more steps.

IQ Bot Community Edition

The IQ Bot Community Edition is available for this release and has feature parity with IQ Bot Version 11.3.4.2.

[Automation 360 IQ Bot feature comparison matrix](#)

[Automation 360 IQ Bot version compatibility](#)

Important: This new Community Edition includes a preview of IQ Bot with Auto-extraction.

Community Edition for IQ Bot is a special version of our product in the Cloud, available for all users who want to try RPA and IQ Bot at no cost. Users are not required to purchase a license, and there are no time limitations. However, there are some functionality constraints as follows:

- Users can create learning instances using pre-trained Invoices in English only.
- Users can create up to a maximum of 5 learning instances per user account.
- In the Learning Instance list, users can see and access only those learning instances and data created by them.
- Users can process up to a 100 pages per month for each user account.

Community Edition

New features (using auto-extraction)
<p>Create a learning instance</p> <p>Use a pre-trained invoice (document type) to process and validate your documents in English (only).</p> <p><i>Create a learning instance in Community Edition</i></p>
<p>Extract data from documents</p> <p>Create a bot to extract data from documents using the learning instance you created.</p>
<p>Validate documents</p> <p>Validate failed documents manually using the validator form.</p> <p><i>Process documents in Community Edition</i></p>
<p>Bot Insight integration</p> <p>View learning instance dashboard metrics that is integrated with Bot Insight.</p>

New features (using auto-extraction)**Use the IQ Bot (Preview) package**

Use the IQ Bot (Preview) package to process and validate documents using Enterprise A2019.

Changed features

For the Custom Logic feature, the identified list of Python libraries now includes an additional set of safe libraries for IQ Bot Community Edition. Go to Automation Anywhere support for a list of the safe libraries you can use.

List of Pandas Libraries which are supported and not supported on Automation 360 IQ Bot (A-People login required)

Fixed features (using Auto-extraction)**Service Cloud case ID****Description**

00628958

The Task Bot now successfully processes all documents without displaying any error messages.

Known limitations (using Auto-extraction)

PDF documents with raster format or JBIG2 encoding are not supported.

Workaround: Convert such documents to one of the supported formats before processing your documents for data extraction.

Note: Digital PDFs, JPEG, JPG, and PNG are supported formats.

Rotated documents are not supported.

Workaround: Pre-process such documents to correct their orientation before data extraction.

Only a predefined set of form and table fields are supported. The table header does not support multiple fields in a single column.

During the validation process, if a user deletes all rows from a table, the user is unable to add a new row.

Workaround: Perform these steps:

1. Cancel the validation user form and open the document again.
2. Create a new row before deleting the unwanted rows.

Documents that are pending review from Enterprise A2019.15 cannot be validated in Enterprise A2019.16 using the **Review documents** option.

Workaround: Create a Task Bot using the IQ Bot **Validation** action in the Enterprise A2019.15 package, and validate the review pending documents.

IQ Bot

New features
<p>Updates to IQ Bot Pre-processor package</p> <p>On-Premises and Cloud</p> <p>You can now perform the following tasks using the new actions in the IQ Bot package:</p> <ul style="list-style-type: none"> • Link or combine two images using Concatenate image • Adjust the size of the selected image file using Edit image • Enhance the image resolution and other aspects using Enhance image • Change the image orientation such as angle using Orient image <p>IQ Bot Pre-processor package</p>
<p>IQ Bot [Local Device] package enhancements</p> <p>The IQ Bot [Local Device] package now enables you to add custom logic (Python scripts) in the Designer to extend text extraction and validation capabilities.</p> <p>Add custom logic in IQ Bot to improve extraction</p>

Fixed features	
Service Cloud case ID	Description
00590165	You can now train the selected document because error messages are no longer displayed when you click Learning instances > See extractions for a group.
--	If you remove a bot (Delete a bot) associated with a document from the staging environment, you must create a group before uploading this document to the production environment. After deleting the bot from the staging environment, you can now create or edit the group when you upload the same document to the production environment.
00601840	You can now view a public bot without any errors when you click BOTS > My bots > PUBLIC in Enterprise A2019.
00672482	You can now validate documents with a large number of fields (more than 100) and navigate between multiple documents without any issues on the Validator .
00648013, 00670191	You can now migrate, export, import, or download IQ Bot learning instance backup (.iqba) files of up to 1.4 GB. The previous limit was 600 MB.

Known limitations
<p>Migration of learning instances does not get completed if the IQBA file size is more than 2 GB.</p> <p>Workaround: Migration of learning instance is not getting completed if the IQBA is more than 2GB (A-People login required)</p>

Known limitations
In the IQ Bot Designer, sometimes while training documents when the user clicks See extraction results , an error message appears and the user cannot proceed with the task.
You cannot access Cloud OCR through a proxy server in IQ Bot.
In IQ Bot Community Edition, when you click New instance to create a learning instance, the My learning instances page appears and then automatically reloads after a few seconds. Workaround: Wait until the page reloads before you start entering the details to create a learning instance.

Bot Insight

New features
<p>Power BI connector available as part of Microsoft Power BI desktop</p> <p>Enterprise A2019 and Community Edition</p> <p>The Automation Anywhere connector for Bot Insight is now certified and officially a part of the Microsoft Power BI Desktop August release.</p> <p>Data connector for Power BI</p>
<p>Business analytics support for attended Bot Runners</p> <p>Enterprise A2019 and Community Edition</p> <p>Business analytics data is now logged when bots are run with attended Bot Runners licenses. Also, a new attribute User Name is available in the Business Dashboard in Transaction Data. This attribute shows the user who is running the bot.</p>

Changed features
<p>Convert bot duration metric to percentage</p> <p>In the Device dashboard, when you select the metric as Bot Duration, you have an additional option to convert the bot duration to percentage. This option appears only if a selected group or subgroup is of date type variable.</p> <p>Operations dashboard</p>

Known limitations
<p>Due to security reasons, you cannot access the following Bot Insight APIs and a 403 forbidden error is displayed.</p> <pre>GET/v2/botinsight/data/api/gettasklogdata GET/v2/botinsight/data/api/gettaskvariableprofile DELETE/data/api/deletetasklogdata GET/data/api/getbotrundata GET/data/api/getaudittraildata</pre>

Automation Anywhere Robotic Interface (AARI)

Important: This AARI version is available for all users starting from Enterprise A2019.16.

New features
<p>Assign tasks</p> <p>Enterprise A2019</p> <p>AARI managers and users can now assign tasks. Managers can assign and reassign tasks to any users from teams with an assigned process. Users can assign tasks to other users of the same team.</p> <p>Assign or unassign a task</p>
<p>Filter and search tasks</p> <p>Enterprise A2019</p> <p>AARI users can now perform the following tasks:</p> <ul style="list-style-type: none"> • Filter, sort, and search tasks for quick results • Search task names using Search Title • Sort by completed, pending, and unassigned tasks using the Filter option • Configure results based on assignee or title using Advanced filter • Click a column to sort by ascending or descending orders <p>Filter and search for a task.</p>
<p>Summarized information of tasks</p> <p>Enterprise A2019</p> <p>The Tasks tab in the main page shows statistical insight for the numbers of completed, pending, and unassigned tasks.</p>
<p>Process package</p> <p>Enterprise A2019</p> <p>The Process package enables users to create a request inside a specified process from a bot.</p> <p>Process package</p>
<p>Preview bot</p> <p>Enterprise A2019</p> <p>Human Tasks and Bot Tasks now include the Preview bot option, which enables users to quickly preview relevant bot or forms information.</p>
<p>Process editor metadata</p> <p>Enterprise A2019</p> <p>Human Tasks and Bot Tasks now accept username and email metadata. Users can enter the name and email values to their process workflow such as <code>\$Task.assignedTo{username}\$</code> and <code>\$Task.assignedTo{email}\$</code>.</p>

New features
<p>Enhancements to roles</p> <p>Enterprise A2019</p> <p>The AARI admin can now assign a process to a team they created and become the manager assigned to that process. The admin can also assign a process to a team they did not create and the manager of that team is assigned to the process.</p>
<p>Administration permission</p> <p>Enterprise A2019</p> <p>The AARI admin and manager are now assigned a new Administration permission by default called View Users and Roles basic information. The admin can now view the process management page to assign or unassign managers.</p>

Changed features
<p>Process management page</p> <p>The process management page in AARI on the web is now removed for managers.</p>
<p>Password field in request view</p> <p>The Password element is now removed when viewed in the request tab.</p>

Fixed features	
Service Cloud case ID	Description
--	A team name is no longer limited to 20 characters.
--	When you open many request tabs, the navigation bar now functions properly and allows you to navigate to your tabs by using the arrow icon.
--	When you view tasks in the request view, the request and task now show the correct status.
--	The manager can now be removed in the process management page.
--	The bot status in the request view is now represented as a progress bar.
--	The Element name field in the process editor now shows the correct error message when the field contains spaces.
--	When you select the Make field uneditable option for the Checkbox, Date, Dropdown, Number, Password, Radio Button, Text Area, and Text Box elements, the values can no longer be edited.
--	The team management page now shows the Owner column.
--	When number values are entered in a number field, such as a phone number box, the values are now accepted.
--	In the device pool configuration page, the Bot Runner users check box is now selected.

Fixed features	
Service Cloud case ID	Description
--	The Checkbox and Radio Button elements now support horizontal format.
--	The Document element can now access the Open the doc in browser link.
--	The Number element values are no longer limited to 8 characters and can now be rendered properly when the values contain trailing zeroes, commas, and decimals.
--	When you select the Insert a variable option in the process editor, the Variable field now shows specific variable names.
--	The redo functions now works properly in the process editor.
--	The Text Box element now accepts number-only inputs.
--	The timestamp of the closing step now shows the timestamp of the last step in request view.
--	When you access a public process, the existing variable in the field can no longer be changed.
--	The Masked data option is now fully supported for all elements.
--	When you edit a checked-out process that contains conditional steps with variables, you can now edit and save these conditional steps.
--	When a process is configured with two forms that contain a Dropdown element, the process creation shares the Dropdown element data between the forms. The Dropdown element in the second form now receives data from the first form.
--	The manager can now access their team without encountering any errors.
--	You can now update values in a prepopulated text field in request view.
--	When you create a request and encounter a preprocessing error, the request creation ends and the request view now shows the failed status.
--	The Go To option in the process editor now shows the Human Task or Bot Task name.
--	Users with the AARI manager and user roles are now automatically redirected to the web interface when they access the Control Room URL.

Known limitations
When you provide your Bot Task and Human Task the same element name, an error occurs for the Go to element, but the process editor does not prompt an error. Workaround: Create unique element names for your Bot Task and Human Task .
When you create a form that contains a Document element and access your Human Task in the process editor, you cannot assign your variable because the Add element option is not available.
The Display message field in the If/Else pair action does not function correctly when displaying a message in request view.
The titles (Title field) of completed requests in AARI on the web are replaced by endpoint display names.
When you create a form that contains a Number field set to a 10-character limit and you enter 1234567890 in the number field in request view, the number values are not accepted.
When you create a process with a form that contains a Date element, the Condition option in the If/Else pair action does not allow you to enter a variable.

Previous Automation 360 Release Notes

Review the release notes for previous Automation 360 releases.

Enterprise A2019.15 Release Notes

Release date: 14 August 2020

Review the new features, supported packages, changed features, fixed features, security fixes, and known limitations in the Enterprise A2019.15 (Build 5933) release. IQ Bot and Discovery Bot are on Build 5931.

- [Enterprise A2019](#)
- [Discovery Bot](#)
- [IQ Bot](#)
- [Bot Insight](#)
- [Automation Anywhere Robotic Interface](#)

Enterprise A2019

To verify which version is compatible with this release, see [Compatibility with Automation 360 builds](#).

New features
Introducing Discovery Bot and Automation Anywhere Robotic Interface Enterprise A2019 Discovery Bot Automation Anywhere Robotic Interface

New features
<p>Migration from Enterprise 11 and Enterprise 10 to Enterprise A2019 (currently available only to those in the Migration Early Adopter Program)</p> <p>Enterprise A2019</p> <p>Migration to Enterprise A2019 is currently only available to select customers through our Migration Early Adopter Program. If you are interested in learning more about this program or a timeline for when migration will be available to all customers, contact your Automation Anywhere representative.</p>
<p>Perform an action on multiple objects of the same type</p> <p>Enterprise A2019</p> <p>The variable anchor in AISense Recorder enables you to perform an action on multiple objects of the same type.</p> <p><i>Use variable anchor</i></p>
<p>Run Enterprise 11 bots from Enterprise A2019</p> <p>Enterprise A2019</p> <p>The V11 TaskBot package enables you to run Enterprise 11 bots from Enterprise A2019 in the Enterprise 11 Control Room.</p> <p><i>V11 Task Bot package</i></p>
<p>Enhancements to the Interactive forms</p> <p>Enterprise A2019</p> <p>Interactive forms include the following updates:</p> <ul style="list-style-type: none"> • You can include the Dynamic element of the selected form in the Change label action. • In the Dynamic area actions: <ul style="list-style-type: none"> • You can add a maximum of four elements for the Add row in Dynamic area action. • In the Add element screen, use additional options from the Type drop-down menu such as Checkbox, Dropdown, File, Snapshot, RadioButton, Text Area, and TextBox. <p><i>Interactive forms package</i></p>
<p>Support for interactions with Oracle EBS tables</p> <p>Enterprise A2019 and Community Edition</p> <p>Use the Universal Recorder or the Recorder > Capture action to read data from an Oracle EBS table. The following actions are now supported:</p> <ul style="list-style-type: none"> • Get Total Row • Get Total Column • Get Cell text by Index • Get Cell index by text

New features
<p>Expanded data type support in DLL package</p> <p>Enterprise A2019 and Community Edition</p> <p>The DLL package now accepts dictionary and list variables as input parameters or to hold action output.</p> <p><i>Using the Run function (Legacy) action</i></p>
<p>Create device pools using API</p> <p>Enterprise A2019</p> <p>You can now create a device pool and add unattended Bot Runners to the device pool using an API. This API uses deviceIds, automationScheme, ownerIds, and consumerIds as parameters to create a device pool.</p> <p><i>Create device pool API</i></p>

Supported packages	
Package	Version
Node Manager	12.1.6000
Application	2.0.0-20200721-221935
App Integration	1.0.0-20200721-221933
Analyze	2.2.3-20200624-011702
Active Directory	2.0.1-20200721-221930
Boolean	2.0.0-20200721-221936
Bot Migration	2.4.0-20200604-174031
Browser	2.0.0-20200721-221938
Clipboard	2.0.0-20200721-221947
Comment	2.0.0-20200721-221948
CSV/TXT	2.0.0-20200726-052504
Database	2.0.0-20200723-022707
Data Table	2.0.0-20200721-222456
Datetime	3.0.1-20200721-222000
Delay	2.1.0-20200721-221959
Dictionary	2.0.0-20200624-041629
Run DLL	2.0.0-20200721-222437
Email	2.0.0-20200721-222003
Error handler	2.0.0-20200721-222009
Excel basic	2.0.0-20200721-222339
Excel advanced	4.0.0-20200723-234413

Supported packages	
Package	Version
File	2.1.0-20200624-041638
File & folders	2.1.0-20200721-222011
Folder	2.1.0-20200721-222013
FTP / SFTP	2.0.0-20200721-222017
IF/ELSE	2.0.0-20200721-222021
Image Recognition	2.0.0-20200721-222024
Interactive forms	2.15.0-20200729-084624
IQ Bot	2.0.0-20200415-125005
JavaScript	2.0.0-20200721-222202
Simulate keystrokes	2.1.0-20200721-222204
Legacy Automation	2.0.0-20200721-222207 1.0.0-20200515-133334
List	2.0.0-20200721-222211
Log To File	2.1.0-20200721-222212
Loop	2.0.0-20200721-222213
Message Box	2.0.0-20200721-222213
Migration	2.4.0-20200728-033126
Mouse	2.0.0-20200721-222218
Number	2.0.0-20200721-222224
OCR	2.1.0-20200721-222225s
Office 365 Excel	2.0.0-20200721-222319
Office 365 Calendar	2.0.0-20200721-221944
Office 365 OneDrive	2.0.0-20200721-222326
PDF	2.4.0-20200721-222331
PGP	2.1.0-20200721-222333
Ping	2.0.0-20200721-222334
Printer	2.0.0-20200721-222342
Play Sound	2.0.0-20200721-222335
Prompt	2.0.0-20200721-222344
Python Script	2.0.0-20200721-222345
Recorder	2.0.6-20200626-193519
REST Web Service	2.0.0-20200721-222436
SAP	2.1.0-20200723-234637

Supported packages	
Package	Version
Screen	2.0.0-20200721-222442
SNMP	2.0.0-20200721-222445
SOAP Web Service	3.0.0-20200721-222448
String	3.0.0-20200721-222454
System	2.0.0-20200721-222454
Task	2.0.0-20200624-103759
Terminal Emulator	3.2.0-20200721-222500
Trigger Email	1.1.0-20200721-222511
VBScript	2.0.0-20200721-222503
Wait	3.0.0-20200721-222505
Window	2.0.0-20200721-222507
Workload	2.0.1-20200721-222508
XML	2.0.0-20200721-222509

Changed features
<p>User validation for change in authentication type (Service Cloud case ID: 00602788)</p> <p>Enterprise A2019</p> <p>The username is now validated when an admin user updates the Control Room authentication configuration from Database to SAML (Administration > Settings > User Authentication). An error message appears if the username already exists.</p> <p>Set up SAML authentication</p>
<p>The Before and After fields in the String > Extract action are now optional (Service Cloud case ID: 00617151)</p> <p>Enterprise A2019 and Community Edition</p> <p>Users can now build and run bots that do not have a value in the Before or After fields. This ensures migrated bots that contain the String > Extract action can run without disruption.</p>
<p>Improved debugging for Image Recognition actions</p> <p>Enterprise A2019 and Community Edition</p> <p>When a bot fails while running one of the Image Recognition actions, the captured source and target images are stored in the log folder. Users can review the images to identify issues such as the application image not captured correctly or low quality of the image due to differences in the Bot Creator and Bot Runner devices.</p> <p>Image Recognition package</p>

Fixed features	
Service Cloud case ID	Description
00609293	The AATaskName system variable now uses a backslash (\) to support the migration of Enterprise 11 bots that use this variable to Enterprise A2019.
00600367, 00620149	When calling REST APIs for using the REST Web Service command, the API now returns the correct status and the response code.
--	When Work Items are processed for automation in the Bot Agent, you can now view the workload automation name in the Workload > Queue > View Activity in progress and Run bot with queue > View pages, even when the workload automation ID and schedule automation ID are the same in the Control Room database.
00606636	The migration of 11.3.x bots that read a date from a file to an Enterprise A2019 variable now results in the correct date format: dd/mm/yyyy. Previously, a series of numbers were displayed in Enterprise A2019.
00576004	Fixed an issue where some emails were retrieved with HTML tags, even when the user selected the Plain text option.
00585830	Fixed an issue where the Loop > For each meeting in calendar iterator only returned details for the first meeting of the day. Now, the output variable refreshes after each iteration and returns details for each meeting.
00505228, 00576757	When the browser language is set to Japanese, error messages from the Control Room > Administration > Settings > Email page are now displayed correctly. The distorted Japanese character issue is now fixed.
--	You can now check in any forms or bots in the Public folder that were created using any of the earlier versions of Enterprise A2019.
--	You can now use the Get action without any errors for an empty dynamic element of a form during bot runtime.
00575400, 00597633	You can now use Email trigger to start a bot even when Microsoft Office is set to a non-English language.
--	If you are using the Snapshot element, the form is no longer minimized even if you set an invalid file path to save the snapshot during bot runtime.
00566225	If you add a form with a Japanese name, error messages are not displayed during bot runtime.
00571773	If you have added element label or text in Japanese and set Font name > System default , the form elements are now displayed without any distortion during bot runtime. Create a form

Fixed features	
Service Cloud case ID	Description
00620911	For the Select file element in a form, the file path is now displayed correctly when you select a file with a Japanese name during bot runtime.
--	If a form has a Dynamic field, any errors within any of the available elements are now displayed immediately during bot runtime.
--	An error is now displayed if you use the Tab key to navigate out of the Dropdown element in a form during bot runtime.
00616251	If a Bot Runner (attended or unattended) user is running a bot and an event trigger that is associated with this user starts, the event trigger is now queued and deployed after the current bot has completed.
00557617	The Simulate keystrokes action now supports ASCII characters when the device language is set to Russian.
--	Installing cloud-based license files is now supported on Control Room deployments using Linux CentOS 7.
00615038	All packages and actions now work with the "Portuguese (Brazil)" browser language. Previously, some packages and actions caused an unresponsive Control Room when "Portuguese (Brazil)" was selected as the browser language.
--	You can now reset the password successfully when the service credential expires or is disabled. Previously, users intermittently experienced issues while resetting the password.
--	The default logging for Bot Agent is no longer in debug mode. Previously, debug mode was the default logging, which caused an increase in the number of logs and resulted in high storage space and decreased system performance.
00588077	If you create a copy or edit the content of an existing CSV file, the modified content that is uploaded in the Control Room will now display correctly and will not cause any run-time error when the bot is executed.
00541524,00531540	You can now run bots even when the path of the bot location is more than 255 characters. Previously, the bot failed with an error.
00615106	The Bot Scanner now analyzes large bots within a few minutes.
00610366	Keyboard shortcuts such as Ctrl+C, Ctrl+V, and Ctrl+X work as expected on Internet Explorer.
00577850, 00608065, 00597132, 00596397, 00619463	The Control Room now does not become unresponsive after a period of inactivity.
00608824	An error is no longer encountered when a bot opens the Excel application after it is forcefully terminated.

Fixed features	
Service Cloud case ID	Description
00542144	The wait option in various packages now works as expected for applications based on HTML technology. Previously, the wait option used to wait for a period in multiples of 15 seconds based on the value provided. For example, if the wait value was in the range of 1-14, the system waited for 15 seconds.
00508478, 00504802, 00569822	An error is no longer encountered when a bot is running and an application window is closed when the bot is performing the find window operation.
00494857	A user that does not have the Register device permission can no longer register a device by creating a custom Bot Creator role.
00501619, 00614130, 00620198	An error is no longer encountered when a user deletes a device after upgrading to a later version of Enterprise A2019.
00616786	Fixed an issue where periodic scheduled bot deployments failed with the following error message (even though the credentials provided by the bot is correct): <code>Either your username or your password is incorrect. This might be due to a misspelling, your Caps Lock might be on, the password might have expired, or the domain might be required. To continue, retype your username and password.</code>
00494893	Fixed an issue where the Error handling > Catch action was not handling a runtime error with the record variable. Previously, the Catch action did not capture an <code>index out of bounds</code> error when the record variable was entered in a Message box action with the index specified by name.
--	The Get Property datetime format within the Active Directory package now displays the information using the system datetime format.
--	When you edit a bot using a previous package version (for example, Enterprise A2019.13 version) and the Desktop session automatically starts, if you exit the Bot editor while the Desktop session is trying to launch, the current package version will now be displayed when you open a new Bot editor instance. Previously, the previous package version (for example, Enterprise A2019.13 version) was displayed.
00563346	Credentials with non-ASCII characters are now allowed to be stored in the Credential Vault in the Control Room. Therefore, when you run TaskBots to open files that are protected using passwords containing non-ASCII characters, the application does not respond with an HTTP 500 error.
00525552, 00470841	The Run task no longer fails when the child bot name contains allowed special characters. Previously, when the child bot name contained allowed special characters, the run task displayed an error message.

Fixed features	
Service Cloud case ID	Description
00501212	Fixed an issue in the SMTP settings where the Control Room was sending notification emails for all of the conditions, including the disabled conditions.
00607005	A security scan of Enterprise A2019 no longer reports the Recorder package as a malicious software. Previously, the security scan reported it as a malicious software because the <code>check.exe</code> file was missing the root identification certificate.
00564129	On an operating system configured for Japanese, the Roles pages in the Control Room now shows English text as expected when you select English in the Control Room language selection.
00629523	When you upgrade from an earlier version of Enterprise A2019 to a later version and change the If package version to the latest one, conditions combined with the AND or OR condition now appear in the logic. Previously, except for the first condition, the rest of the conditions with the AND or OR condition were not shown.
00631477	When Work Items from multiple queues are processed for Workload automation from one device pool with the round-robin method for a time slice of 5 minutes, the Workload automation does not run in a loop and thereby causing an increased CPU usage.
00633829	As system admin permissions for Workload automation are verified by the application when you run a bot with queue from a single device pool to process multiple Work Items concurrently, CPU usage does not increase drastically.
00615086	Fixed an issue where the Java Application Launcher continued to run after a user stopped the Bot Scanner, which caused device performance issues for some users.
--	Variables of the List type are now available for migration from Enterprise 10 and Enterprise 11 to Enterprise A2019.
00607949	Disabled packages will not be enabled when you upgrade from an earlier version of Enterprise A2019 to a later version. Previously, packages that were disabled were enabled after an upgrade.
--	You can now debug a bot with watch variables that contain Japanese characters. Previously, watch variables containing Japanese characters did not output a value.
00623186, 00624876, 00624060, 00627123, 00629873, 00639523, 00630880, 00634577, 00636166	The correct status of a deployed bot now appears instead of <code>Device yet to be determined</code> in the Control Room Activity page, and the user is allowed to delete the device that has completed running a bot. The following message no longer appears: <code>Device is part of active deployment</code> .
00573461	Fixed an issue where a bot was failing in preprocessing mode if the user had inserted and then disabled the Error Handler > Catch action without also disabling the Finally or Catch actions.

Fixed features	
Service Cloud case ID	Description
00629046	In the Database package, when you use Microsoft Excel as a database, the bot launcher now executes properly. Previously, the bot launcher stopped working when reading data from an Excel sheet that had some empty rows.

Security fixes	
Service Cloud case ID	Description
00491697	The Transport Layer Security (TLS) protocol using CBC mode of encryption for configuring the network security of the Control Room is now secured from man-in-the-middle or cyrstallographic timing attack.

Known limitations
When you add a form with the Dynamic element to a bot, click Add element , select Dropdown or Radio group as the Type , and leave the Default value/ Default path field blank, the elements appear as labels during bot runtime.
You can move a form around by dragging the title bar during bot runtime.
When you copy and paste the filepath for the Select file element of a form during bot runtime, invalid characters are displayed.
When the Set focus action is assigned to a disabled form element, an error icon is displayed when the focus is lost during bot runtime.
When you enable any of the disabled fields during bot runtime, error icons are not displayed.
Error messages during bot runtime are not displayed in the language selected in the Control Room.
If email trigger is used to start a bot, the status of the most recent email that you have viewed is changed to Unread every time any bot is triggered based on the trigger interval set in the Check every drop-down menu.
In an Control Room configured for Active Directory users, the following message appears after the first admin user is created: <code>Do you want to leave this page?</code> Workaround: Click Stay on page so that you can go to the Control Room login page.
If the device is already registered by a user other than the Bot Creator and the Bot Creator has the Register device permission, then when you run a bot from the Bot editor window, the deployment fails at the <code>Connecting your computer to Enterprise Control Room</code> step.
The migration process does not migrate manual dependency files added in the Enterprise 11 Control Room using the API. Bots associated with these dependencies will be migrated successfully but will fail during execution because the system cannot find these dynamically added dependency files at runtime in Enterprise A2019.
When a bot execution is in progress and the Control Room server refreshes, the progress status of the In-Progress activity will not be displayed even though the bot execution continues without interruption.

Discovery Bot

Introduction

Discovery Bot enables process automation by capturing document processes, identifying automation opportunities from business processes, and prioritizing opportunities based on ROI. Users can convert these opportunities into automated processes.

Process discovery by using Discovery Bot

Known limitations
<p>Discovery Bot is not supported in high availability (HA) mode. When two Control Room instances are used in a cluster configuration, the recording artifacts are split between the two Control Room instances and the recording might fail to process.</p> <p>Workaround: To enable Discovery Bot in HA mode, you must update the <code>processdiscovery.properties</code> file to point to the repository path specified in the Control Room:</p> <ol style="list-style-type: none"> 1. From the Control Room, go to Administration > Settings > General. 2. Select the Control Room Database and Software tab. 3. Scroll to the Control Room Repository section. 4. Copy the path specified in the Repository path field. 5. Go to <code>C:\Program Files\Automation Anywhere\Enterprise\config</code>. 6. Open the <code>processdiscovery.properties</code> file. 7. In the <code>processdiscovery.data.staging</code> path, paste the repository path in the <code><yournetworkshareddrive></code> here: <code>\\<yournetworkshareddrive>\Processdiscovery\staging\data</code> 8. Restart the Discovery Bot service.
<p>When HTTP proxy is installed in a cloud environment, you can use the Discovery Bot recorder to record processes.</p>
<p>Custom role setup for Discovery Bot is currently not supported.</p>
<p>The Discovery Bot recorder continues to record your steps even after you have logged out of the Control Room.</p>
<p>Recommendation: Manually stop the recorder to end the recording session.</p>
<p>The Discovery Bot recorder displays an internal error message when accessing Google Apps. Pause the recording and then resume the recording again to recapture the steps.</p>
<p>The recent recording (ID) created is displayed at the end of the list in the Recordings table. You cannot sort on the recording ID at this time.</p>
<p>The recording count for a process is incremented by one even if a user stops or cancels a recording session. The incremented number is displayed in the Recordings section in the tile for a process.</p>
<p>By default, you cannot move the endpoint in an upward direction in the path flow to change the selection of the steps. You can move the branch endpoint lower in the path flow to include more than one step.</p>
<p>You must add at least one step to a branch for you to select the branch and create an opportunity.</p>

Known limitations
You must select all steps in a branch to create an opportunity. Selecting partial steps in a branch will result in branch being dropped in the opportunity that is displayed from the Opportunities tab.
Currently, the copy of field does not display the correct view information from the view (view ID) that it is copied from.
If the Control Room is not installed in the C:\ drive (C:\Program Files\Automation \Enterprise), the Discovery Bot installer fails to install correctly. If the Control Room is not installed in the C:\ drive, then perform the instructions provided in this article: A2019.15 Discovery Bot installation issue with non-OS drive (A-People login required) .
The Export to Word option supports a maximum of 500 steps.
The Convert to Bot option supports a maximum of 500 steps.

Changed features
.

IQ Bot

Review the compatibility of the IQ Bot On-Premises version with the corresponding Control Room On-Premises version.

[Automation 360 IQ Bot version compatibility](#)

For feature information about IQ Bot, see [Automation 360 IQ Bot feature comparison matrix](#).

The IQ Bot Cloud version provides users with automatic provisioning for up to three environments such as Development, Test, and Production.

Note: IQ Bot Build 5931 is compatible with Enterprise A2019 Build 5933.

New features
<p>New IQ Bot Pre-processor package</p> <p>On-Premises and Cloud</p> <p>The following new actions are available as part of the IQ Bot package:</p> <ul style="list-style-type: none"> • Convert image to PDF • Get barcodes • Get document info • Get page content <p>IQ Bot Pre-processor package</p>

New features
<p>Search by filename in Validator</p> <p>On-Premises and Cloud (Service Cloud case ID: 00372981)</p> <p>Use the Search by filename field in the Validator screen to search a document in IQ Bot.</p> <p>IQ bot Validator enhancements</p>
<p>IQ Bot [Local Device] package (currently available on request only)</p> <p>On-Premises and Cloud</p> <hr/> <p>Important: Contact your Automation Anywhere representative to request the On-Premises package. For Cloud, it is available as a pre-installed package.</p> <hr/> <p>Use the IQ Bot [Local Device] > Process documents action to process documents using TaskBots created in the Control Room. You can scale by processing documents on multiple devices simultaneously without setting up a separate IQ Bot cluster. You can set this up using workload management in the Control Room.</p> <p>Workload management</p> <p>The validation is done using the current IQ Bot Validator and usage metrics on the dashboards, which is available with the installed IQ Bot server.</p> <hr/> <p>Note: You can create validators using interactive forms if they do not want to send data to the IQ Bot server.</p> <hr/> <p>IQ Bot [Local Device] package</p>
<p>IQ Bot Classifier package (currently available on request only)</p> <p>On-Premises and Cloud</p> <p>The IQ Bot Classifier package enables you to group documents into appropriate learning instances for content extraction.</p> <p>This package is not available as part of the standard IQ Bot installation.</p> <hr/> <p>Important: Contact your Automation Anywhere representative to request the package.</p> <hr/> <p>IQ Bot Classifier package</p>
<p>Migrate learning instances using Migration Utility</p> <p>On-Premises and Cloud</p> <p>Use the Migration Utility feature to migrate learning instances from one environment to another. Additionally, you can back up, restore, download, delete, and upload learning instances.</p> <p>Migrate learning instances</p>
<p>Control creation of groups</p> <p>On-Premises and Cloud</p> <p>Use the New groups creation setting section in the Learning Instance > Edit page to limit creating groups when uploading training documents to IQ Bot. Use the Threshold to create new groups value and Never create new groups check box to define the parameters.</p> <p>Bots</p>

Changed features
<p>For the Custom Logic feature, the identified list of Python libraries now includes an additional set of trusted libraries for IQ Bot On-Premises and Cloud. Go to Automation Anywhere support for a list of the safe libraries you can use.</p> <p><i>List of Pandas Libraries which are supported and not supported on Automation 360 IQ Bot (A-People login required)</i></p>

Fixed features	
Service Cloud case ID	Description
00376179	The Automation Anywhere Cognitive Project is now created without any errors even when you use the IQ Bot batch files to install or uninstall IQ Bot.
00560185	The Download Document in IQ Bot now runs without any errors, irrespective of the language in which the learning instances are saved.
00574815	You can now use the Google Vision API engine to classify the selected PDF files without creating any unclassified groups.
--	Documents are now classified correctly by the Google Vision API, irrespective of the display limitations set. Previously, an incorrect resolution limitation created unclassified documents.
--	You can now use Internet Explorer to save a document or mark it as invalid in the learning instances validator screen, without any error messages.
00620237, 00623175	After logging in to the Control Room as an IQ Bot administrator, the IQ Bot tab is no longer displayed in the navigation bar.
--	The <code>Output.csv</code> file generated for a validated document and validated data are now displayed without any error messages.
00605607	When you click Save current document in the validator screen, the document is saved without any errors and the corresponding <code>.csv</code> file is created in the output folder.
--	IQ Bot deletes learning instances from Community Edition if they have not had activity in 60 days.

Known limitations
<p>IQ Bot On-Premises and Cloud</p> <p>When you click the Save and go to next group option, the available groups or the learning instances are sometimes not displayed.</p>
<p>IQ Bot On-Premises and Cloud</p> <p>A validation error message along with the corrected field is displayed in the output (<code>.csv</code>) file for documents validated using ValidatorURL.</p>

Known limitations
<p>IQ Bot Cloud (Service Cloud Case ID: 00647700, 00657619, 00656643)</p> <p>The output (.CSV) files are not downloaded even when you click Download all documents button, and an error message is displayed.</p> <p>Contact Automation Anywhere support for more information.</p>

Bot Insight

New features
<p>Date Interval option</p> <p>Enterprise A2019</p> <p>When you create new widgets that support date fields for a group or subgroup, the Date Interval option is enabled with the default option set to Month.</p> <p>Configuring a Line Bar Chart query</p>
<p>New clustered line bar chart widget</p> <p>Enterprise A2019 and Community Edition</p> <p>The Clustered Line Bar Chart widget enables you to view and analyze information about your metrics and attributes. You can provide two metrics and two attributes in your clustered line bar chart. Now when two attributes are selected, a clustered graph grouped by primary and secondary attributes is displayed.</p> <p>Bot Insight visualizations</p>
<p>New Device dashboard in the Operations dashboard</p> <p>Enterprise A2019 and Community Edition</p> <p>The Bot Insight Device dashboard displays various widgets that provide information about the utilization of the machines on which the bots are executed. You can analyze the device utilization and activity history of different Bot Runner machines.</p> <p>Operations dashboard</p>

Fixed features	
Service Cloud case ID	Description
00540647	Dates are now displayed correctly on the dashboard after the data is grouped based on the date. Previously, incorrect dates were shown on the dashboard.

Deprecated feature
The Widget Event Distribution by workbench is removed and will no longer be displayed in the Audit Dashboard .

Automation Anywhere Robotic Interface

Introduction

Automation Anywhere Robotic Interface (AARI) enables users to design a process workflow to address their business requirements. The processes incorporate human and bot tasks using forms to define parameters and render supported UI elements on the web. When using AARI on the web, users create requests to use their created process workflow for process instances (case) and run their tasks.

AARI is available as a part of the Enterprise A2019 installer. You can view the AARI components in the **Administration** page.

[Configure roles for AARI on the web](#)

Important: This AARI version has limited availability and is available only to sales and internal users.

Known limitations
<p>When you edit a checked-out process that contains conditional steps with variables, you cannot edit and save these conditional steps. The steps will revert any new variables you add.</p> <p>Workaround: Delete and add a new condition.</p>
<p>The If, Else If, and Else actions cannot be placed before another bot logic in your workflow. You can only place these actions at the end of the bot logic.</p> <p>Workaround: Make a clear boundary on the conditional block.</p>
<p>In a process, when you use a date format such as 2020/07/04 in the input_date field in Bot Task, the bot does not accept the date input.</p> <p>Workaround: Create a separate date variable to use an input.</p>
<p>Form elements that are not supported and are deleted by the process editor include: Button, Dynamic, Select File, and Snapshot.</p> <p>Workaround: Instead of using the Button element, add a form action.</p>
<p>The Import bots and Export bots user interface labels do not match for a process but are still applicable to importing or exporting a process.</p>
<p>When you access a public process, the Request display name field in Process entry is not locked and can be edited. The existing variable in the field can be changed but not saved.</p>
<p>The Task display name option in Process entry has a field set to initialData that cannot be edited in the process editor.</p>
<p>The Feed data into form table in the process editor does not allow editing.</p>
<p>The Element name field in the Bot Task and Human Task cannot contain spaces.</p>
<p>When you create two forms and assign the data of the first form to the second form using <code>FormStep.input[]</code>, the second form data is not evaluated.</p>
<p>Redo functions are only available for canvas interactions. The redo functions are not available by default until your first canvas interaction. The functions are available again when you interact with your second canvas.</p>
<p>A team name that has a length of 20 characters or more is not accepted.</p>

Known limitations	
Limitations in AARI on the web	
Navigation bar	When you open too many request tabs, the tabs are hidden in the navigation bar.
Timestamp	The timestamp of the closing step shows a duplicate timestamp of the starting step in request view.
Imported process	<p>When you export a process from an Control Room and import that process as public to another Control Room, the imported process cannot be viewed.</p> <p>Workaround: You can check in and then check out the process, or import the process as private and then do a check-in.</p>
Configuration page	<p>In the device pool configuration page, the Bot Runner users check box cannot be deselected.</p> <p>Workaround: Double-click the check box in the header.</p>
Process management page	A check-in process that is deleted from the Control Room repository is still visible in the process management page.
Form rendering	<ul style="list-style-type: none"> • The Masked data option is not fully supported for all elements. When this option is added to hide data, the data is visible. • The Checkbox and Radio Button elements do not fully support horizontal format. When these elements are configured to display horizontally, the elements are displayed vertically instead. • The Document element is not fully supported. When this element is configured to a Default file path, the entire document is not rendered. • The Number element encounters issues with large numbers. When this element is configured to contain three number fields and number values with trailing zeroes, commas, and decimals, these values are not honored and are not rendered. When number values are entered in a number field, such as a phone number box, the number values are not accepted. • The Text Box element encounters issues with number-only input. When this element is configured in a form to submit data, the Submit option is not enabled when the field contains only numbers. • The Password element encounters issues with maximum character limits. The maximum limit is not enforced when a password is entered in the initial form. This element does not contain values when

Enterprise A2019.14 Release Notes

Release date: 9 July 2020

Review the new features, supported packages, changed features, fixed features, and known limitations in the Enterprise A2019.14 (Build 5322) release. There are no security fixes in this release.

- [Enterprise A2019](#)
- [IQ Bot A2019](#)
- [Bot Insight A2019](#)

Enterprise A2019

To verify which version is compatible with this release, see [Compatibility with Automation 360 builds](#).

New features
<p>Migration from Enterprise 11 and Enterprise 10 to Enterprise A2019 (currently available only to those in the Migration Early Adopter Program)</p> <p>Enterprise A2019</p> <p>Migration to Enterprise A2019 is currently only available to select customers through our Migration Early Adopter Program. If you are interested in learning more about this program or a timeline for when migration will be available to all customers, contact your Automation Anywhere representative.</p> <ul style="list-style-type: none"> • Workload management data is automatically migrated to Enterprise A2019 when you install Enterprise A2019 and point the Control Room to the restored Enterprise 11 database. <ul style="list-style-type: none"> • How workload management data is migrated • Version 11.3.1 and Version 11.3 are certified for migration to Enterprise A2019. <ul style="list-style-type: none"> • Migrate to Automation 360 • Additional support is provided for packages and variables. <ul style="list-style-type: none"> • Package mapping for migration Variable mapping for migration • Migrate TaskBots and MetaBots created in Enterprise 10 to Enterprise A2019 using APIs. <ul style="list-style-type: none"> • Enterprise 10 Migration APIs
<p>Bypass legal disclaimer</p> <p>Enterprise A2019</p> <p>When you allocate a device license to a user, the Bypass legal disclaimer option is automatically enabled to allow the user to run bots on the device without having to manually acknowledge a disclaimer.</p> <ul style="list-style-type: none"> • Create a user

New features
<p>Choose to automatically update Bot Agent (Service Cloud case ID: 00497873)</p> <p>Enterprise A2019 and Community Edition</p> <p>An Control Room administrator can now choose to automatically update the Bot Agent to a later version (Administration > Devices) using the auto-update capability. In the earlier version, each Bot Agent had to be updated manually after logging in to a device, resulting in more downtime.</p> <hr/> <p>Note: In this release, Bot Agent users have to update each Bot Agent manually. From subsequent releases, the auto-update setting will be applied and each Bot Agent will be updated automatically.</p> <hr/> <ul style="list-style-type: none"> • For Cloud and Community Edition, the auto-update option is enabled by default. • For On-Premises, the default update option is set to manual. <p>Automatically update the Bot Agent</p>
<p>Universal Recorder new features</p> <p>Enterprise A2019 and Community Edition</p> <ul style="list-style-type: none"> • The Universal Recorder can now capture objects in SAP versions 730, 740, and 760 patch 5. • You can build automations in an SAP application using multiple connections (user accounts) and several sessions per connection at one time. • You can now record and run bots to capture objects from a Google Chrome browser that does not have a zoom level setting of 100%.
<p>Capture active text, passive text, image button, and scroll in combo box in AISense Recorder</p> <p>Enterprise A2019</p> <p>You can now capture active text, passive text, image button, and scroll in a combo box from a remote application when recording a task with AISense Recorder.</p> <p>Record a task with AISense Recorder</p>
<p>New Database package features (Service Cloud case ID: 00537047)</p> <p>Enterprise A2019 and Community Edition</p> <ul style="list-style-type: none"> • The Connect action now enables you to connect to an Excel database. • Use the Export to data table action to retrieve records from the database and store the retrieved data in a table variable. • You can now store the output of the Run stored procedure action in a dictionary variable. <p>Using Connect action for database Using the Export to data table action Using the Run stored procedure action</p>
<p>New Active Directory package available</p> <p>Enterprise A2019 and Community Edition</p> <p>Use actions from the Active Directory package to manage users across a group or organization. You can perform operations such as create, modify, and delete users, groups, or organizational units with centralized control.</p> <p>Active Directory package</p>

New features
<p>Log in securely when connecting to Active Directory server</p> <p>Enterprise A2019 and Community Edition</p> <p>You can use the Connect action from the Active Directory to enter your credentials (username and password). You can either insert the credentials from the Credential Vault or insert a variable that holds a credential type value.</p> <p><i>Using Connect action for Active Directory Credentials and credential variables in the Bot editor Your variables (user-defined)</i></p>
<p>Support for Excel cell formats, including Number, Percentage, Currency, Scientific, and Date</p> <p>Enterprise A2019 and Community Edition</p> <p>Use the Get single cell and Get multiple cell actions from the Excel basic package and the For each row in worksheet Loop iterator to retrieve values in the format set in the Excel worksheet. For example, a value from a cell of Currency formatting retains the currency symbol when passed to a table or record variable.</p> <p><i>Excel basic package Loop package</i></p>
<p>Automate a task on a range of cells in an Excel worksheet</p> <p>Enterprise A2019 and Community Edition</p> <p>Specify a cell range in the Delete cells action to perform the operation on the cells in the range.</p> <p><i>Excel advanced cell operations</i></p>
<p>New PDF package action</p> <p>Enterprise A2019 and Community Edition</p> <p>Merge multiple PDF files into a single PDF file using the Merge documents action.</p> <p><i>Using the Merge documents action</i></p>
<p>Support for Czech and United States 2 code pages in Terminal Emulator package</p> <p>Enterprise A2019 and Community Edition</p> <p>The TN3270E and TN5250E terminal types support the Czech and United States 2 code pages. Use the Connect action to select the terminal type and code page.</p> <p><i>Using Connect action for Terminal Emulator</i></p>
<p>Proxy support for packages</p> <p>Enterprise A2019</p> <p>If a device is configured with a proxy, all outbound requests from the following packages are routed through the proxy server:</p> <ul style="list-style-type: none"> • Recorder • REST Web Service • SOAP Web Service

New features
<p>Form builder enhancements</p> <p>Enterprise A2019</p> <p>The form builder now includes the following new elements:</p> <ul style="list-style-type: none"> • Dynamic - Enables dynamic rendering of the selected area. • Snapshot - Enables you to take a snapshot of the form.
<p>Enhancements to actions in Interactive forms</p> <p>Enterprise A2019</p> <ul style="list-style-type: none"> • Enhanced highlight action <p>The Highlight action in the Interactive forms includes a Highlight type drop-down menu. You can use Warning or Error to highlight the selected form element during the bot runtime.</p> • New Change label action <p>Use this action to change the label or title of the selected element of a specific form.</p> • Dynamic area action <ul style="list-style-type: none"> • The Add row in Dynamic area action enables you to append or overwrite a dynamic element of a form. • The Clear action enables you to remove the dynamic elements. <p><i>Interactive forms package</i></p>
<p>Retrieve trigger event data</p> <p>Enterprise A2019</p> <p>You can now retrieve the trigger event data during bot runtime by defining a variable as the input type.</p> <p><i>Add a file and folder trigger</i></p>
<p>Record variable support for schema</p> <p>Enterprise A2019 and Community Edition</p> <p>You can create a new record variable with a schema to set the order of the fields and the type of data that can be entered into each field.</p> <p><i>Record variable</i></p>
<p>Product interface now available in Russian language</p> <p>Enterprise A2019</p> <p>Enterprise A2019 is now available in Russian.</p> <p><i>Internationalization, localization, and language support</i></p>

New features
<p>Clone and view content in Control Room</p> <p>Enterprise A2019</p> <p>The Control Room now includes the following new permissions:</p> <ul style="list-style-type: none"> • View content: This permission allows you to view the contents of a cloned bot. This permission applies to both public and private workspaces. • Clone: This permission allows you to create a read-only copy of the bot from the public workspace. The same bot can be cloned by multiple users. This permission applies only to the public workspace. <p>Bot permissions for a role</p>
<p>New condition in the If and Loop packages</p> <p>Enterprise A2019 and Community Edition</p> <p>Use the Dictionary > Check key condition to execute actions based on whether the value of the specified key is Equal to or Not equal to, or Contains or Does not contain the target value.</p> <p>If package Loop package</p>
<p>New encoding type in CSV/TXT and Log To File packages</p> <p>Enterprise A2019 and Community Edition</p> <p>The UTF-16LE encoding option provides support for files that contain the byte order mark (BOM) Unicode character. In the CSV/TEXT > Open action, selecting this option causes the BOM character to be ignored when data is retrieved from the file using a subsequent Read or Loop action. In the Log to file action, this option inserts a BOM character at the beginning of the file.</p> <p>Using the Open action for CSV/TXT file Using Log To File action</p>
<p>Retrieve a list of available users using Device API</p> <p>Enterprise A2019</p> <p>Use the Device API to identify all available users with unattended Bot Runner licenses, or to filter for users by name. This API returns details of each user, including the user ID, username, and device name.</p> <p>Device API</p>
<p>Manually configure time interval value of database connection retries property (Service Cloud case ID: 00573167)</p> <p>Enterprise A2019 and Community Edition</p> <p>You can manually configure the time interval value of the database connection retries in the <code>cluster.properties</code> file. If the database is reconnected within the time specified in the <code>cluster.properties</code> file, the Apache Ignite cache node in the cluster setup will not restart the Apache Ignite server, keeping the device and the Control Room user connected. The default value of the time property <code>ignite.max.duration.db.connection.retries</code> in the <code>cluster.properties</code> file is 10000. The recommended maximum time for this property is up to 5 minutes (300000 msec).</p> <hr/> <p>Note: Restart the Control Room services on each node for the manually configured value of the time property to work effectively. Also, set the time in milliseconds.</p> <hr/>

New features
<p>Run as user to default device mapping in Workload automation (Service Cloud case ID: 00563115)</p> <p>Enterprise A2019 and Community Edition</p> <p>Workload automation now allows one-to-one (1:1) mapping of the Run As user with default devices when these devices are part of a device pool. Therefore, you can select default devices that are mapped to a Bot Runner to avoid auto-login failures in environments where the security policy does not allow a user to log in to any other device or devices.</p> <p><i>Add queue, Bot Runner, and device pool</i></p>
<p>Authentication proxy support</p> <p>Support is now available for proxy authentication servers where any application going through the proxy is authenticated and authorized before accessing the internet.</p>

Supported packages	
Package	Version
Node Manager	12.1.6000
Application	2.0.0-20200624-041608
App Integration	1.0.0-20200624-041607
Analyze	2.2.3-20200624-011702
Active Directory	2.0.1-20200624-041605
Boolean	2.0.0-20200624-041610
Bot Migration	2.4.0-20200604-174031
Browser	2.0.0-20200624-041611
Clipboard	2.0.0-20200624-041619
Comment	2.0.0-20200624-041619
CSV/TXT	2.0.0-20200624-041620
Database	2.0.0-20200624-041623
Data Table	2.0.0-20200624-042148
Datetime	2.0.0-20200624-041628
Delay	2.1.0-20200624-041629
Dictionary	2.0.0-20200624-041629
Run DLL	2.0.0-20200630-062222
Email	2.0.0-20200624-041631
Error handler	2.0.0-20200624-041636
Excel basic	2.0.0-20200630-062144
Excel advanced	4.0.0-20200630-062063
File	2.1.0-20200624-041638

Supported packages	
Package	Version
File & folders	1.1.0-20200627-151822
Folder	2.1.0-20200624-041640
FTP / SFTP	2.0.0-20200624-041644
IF/ELSE	2.0.0-20200624-041646
Image Recognition	2.0.0-20200624-041747
Interactive forms	2.14.0-20200629-185534
IQ Bot	2.0.0-20200415-125005
JavaScript	2.0.0-20200630-062021
Simulate keystrokes	2.0.0-20200624-041915
Legacy Automation	2.0.0-20200624-041919 1.0.0-20200515-133334
List	2.0.0-20200624-041923
Log To File	2.0.0-20200624-041923
Loop	2.0.0-20200624-041924
Message Box	2.0.0-20200624-041925
Mouse	2.0.0-20200624-041929
Number	2.0.0-20200624-041934
OCR	2.1.0-20200630-062040
Office 365 Excel	2.0.0-20200630-062127
Office 365 Calendar	2.0.0-20200630-061819
Office 365 OneDrive	2.0.0-20200630-062133
PDF	2.1.0-20200624-042032
PGP	2.1.0-20200630-062139
Ping	2.0.0-20200624-042035
Printer	2.0.0-20200624-042042
Play Sound	2.0.0-20200624-042037
Prompt	2.0.0-20200624-042043
Python Script	2.0.0-20200624-042044
Recorder	2.0.6-20200626-193519
REST Web Service	2.0.0-20200624-042128
SAP	2.1.0-20200624-042131
Screen	2.0.0-20200624-042134
SNMP	2.0.0-20200624-042137

Supported packages	
Package	Version
SOAP Web Service	3.0.0-20200624-042140
String	3.0.0-20200624-042145
System	2.0.0-20200624-042146
Task	2.0.0-20200624-103759
Terminal Emulator	3.2.0-20200625-032209
Trigger Email	1.1.0-20200624-042201
VBScript	2.0.0-20200630-062305
Wait	3.0.0-20200624-042156
Window	2.0.0-20200624-042224
Workload	2.0.0-20200624-042158
XML	2.0.0-20200624-042200

Changed features
<p>Changes in the Database > Run stored procedure action</p> <ul style="list-style-type: none"> It is now optional to enter an input or output parameter name. You must specify the data type of an input parameter. Choose from Boolean, date, number, or string date type.
<p>The terminal screen for ANSI and VT100 terminals now displays 24 rows, instead of 25 rows as in earlier versions.</p>
<p>Email > Send action interface changes</p> <p>For the Use secure connection (SSL/TLS) and My server requires authentication fields, you must now select True or False, or insert a Boolean variable. Previously, the fields were activated by selecting a check box.</p>
<p>Import bots in public or private workspace</p> <p>Service Cloud case ID: 00456712</p> <p>Users can now import bots into the public workspace if they have the required permissions, regardless of their licenses. Additionally, users with a Bot Creator license can now import the bots either into the public or private workspace.</p> <p>Import bots</p>

Fixed features	
Service Cloud case ID	Description
00554068	In the Community Edition, when you upgrade your Bot Agent to a later compatible version, TaskBots created with system variables of numeric type now run successfully. The Control Room does not show a preprocessing error when you deploy the TaskBots.

Fixed features	
Service Cloud case ID	Description
00443421	The Run stored procedure action in the Database package runs as expected with Oracle Database when you use input and output parameters.
00557374	The Universal Recorder now consistently captures objects from an SAP application and identifies the technology for those objects as SAP when all prerequisites are met.
00611874	An error is no longer encountered when a variable containing Japanese characters is used in the Write to file action of the Data Table package.
00564534	A modified dependency file with the same name as the original file and a new size is now successfully checked in from the private to the public repository. The old file that was previously checked in is no longer referenced after the modified file is checked in to the public repository, thereby preventing a bot execution failure.
00570537	When you clone a bot with or without dependency files, the cloned bot now displays the actual file size for the bot and its dependency files.
00577247, 00587976	Fixed an issue where the Email > Move all action did not move emails when a bot ran the action on an OS configured with the Japanese language setting.
00552729	The PGP > Decrypt action now works for PDF files.
00487805	You can now access the TN3270 terminal without the terminal screen displaying all text with strike lines. Before using any type of terminal to execute terminal commands, install the latest VC ++ package. Latest supported Visual C++ downloads
00584051	Python 3 script now supports using Unicode characters in input variables. Bot error messages are no longer displayed when Python 3 is used to pass Japanese characters to a variable.
00540651, 00587963, 00593302	You can now use the Assign, Join, Merge, and Sort actions from the Data Table package when you change the default language from English to Simplified Chinese. You can also use the Assign action when you change the default language from English to Japanese, Korean, and other non-English languages.
00577284	The Split document action in the PDF package now executes correctly for a horizontal PDF file, and the large-width output file is not cut off from the sides.
00595357	You can now export and import two different bots (with the same name) in different folders from a staging environment into a production environment.
00569527	You can now perform a check-in and check-out of bots with dependencies.

Fixed features	
Service Cloud case ID	Description
00574309	You can now update or remove Cluster ip addresses from the Elastic search disaster recovery backup cluster setting from the Control Room Administration page.
00525854	When a file type variable is used to open an Excel, CSV, or Java script file, bots can now be executed successfully when the file variable is used as an input.
00609184	After the existing license expires, the admin user can now successfully install a new Control Room license for a Control Room hosted on Linux CentOS.
00576202	You can now insert a user-defined string variable in a message box display when the string variable is included in the expression for multi-line values.
00560706	You can now view the actions menu (vertical ellipsis) to edit or delete the variable string name when the character length is more than 35 characters.
-	For the Checkbox element, changes made to the check box names in the Checkbox content field are now updated when you enable Advance behaviors > Make default selections .
-	You can now set the default selection in Advance behaviors for the Radio button element in a form.
00557395	You can now check in bots that use the variable <code>\$prompt-assignment\$</code> without receiving an error message. Previously, when you opened the bot in List view, an error icon was displayed next to the actions that contain the variable.
00560356	Previously, when a task that consisted of one or more subtasks was run, the In Progress entry for the task was moved into a historical report with the completion of the first subtask, not the entire governing task. Now, the In Progress tasks are not moved to historical status until the completion of the entire task.
00556113	In Community Edition opened in Google Chrome, you can now select the device icon in a non-English language, and the <code>[link]</code> and <code>[icon]</code> tags are no longer displayed.
00559360	You can now re-import a bot that has failed previous imports. The <code>query did not return a unique result: 2</code> displayed during re-import attempts is now fixed.
00443590	Fixed an issue where after a bot is deployed on a Bot Runner device, that device is in a different state compared to the state before the bot deployment. For example, if a Bot Runner device is locked before bot deployment, after it is unlocked to deploy the bot, it will now be moved back to lock status.
00559507, 00594149	Support for scheduling bots with Internet Explorer version 11 is now improved. Users in the Control Room can scroll through multiple pages of scheduled bots without issues with scrolling through the interface.

Known limitations
<p>In Enterprise A2019 On-Premises, a security scan might report the Recorder package as malware because the <code>check.exe</code> file is missing the root identification certificate.</p> <p>You can contact Automation Anywhere Support to get an updated package with the signature fix and upload it to your Control Room.</p> <p>Add packages to the Control Room</p>
<p>Version Enterprise 10 or Enterprise 11 bots containing commands that have white space in the credential attributes cannot be migrated to Enterprise A2019. The migration process stores some credential attributes in global values in Enterprise A2019. Global values do not support white spaces.</p> <p>To migrate bots that use credential attributes, you can remove the white spaces or replace them with characters.</p>
<p>If you use the Get action for an empty dynamic element of a form, errors are displayed during bot runtime.</p>
<p>If you use Trigger loop: Handle within a bot, link it to a form with Select File element, and set the Select action trigger > Lost focus, the next event is not triggered when you click Browse.</p>
<p>The Set focus action in Interactive forms does not work when you use it to link the fields between two different forms.</p>
<p>In the form builder screen, text is displayed in English even when you change the display to non-English language.</p>
<p>You might see the schedule automation name instead of the Workload automation name in the Workload > Queue > View Activity in progress and Run bot with queue > View pages when Work Items are processed for automation in the Bot Agent. This occurs if the Workload automation ID and schedule automation ID are the same in the Control Room database.</p>
<p>The Task bot > Run action only supports files selected from the Control Room repository. Also, this action only supports file type variables with a set default value and the input option disabled. You cannot modify the file variable value using the File > Assign action.</p>
<p>When you edit a bot using a previous package version (for example, an Enterprise A2019.13 version) and the Desktop session automatically starts, if you exit the Bot editor while the Desktop session is trying to launch, the previous package version will be displayed when you open a new Bot editor instance. However, you should see the Enterprise A2019.14 package version associated with the new Bot editor instance. If you close and reopen the new Bot editor instance, the Enterprise A2019.14 package version will be displayed.</p>

Known limitations
<p>There is an issue for a specific, manually generated license key file supplied by Automation Anywhere to upgrade from Enterprise A2109.13 to Enterprise A2019.14.</p> <p>This issue applies only to customers who are in the following specific category (all must be true):</p> <ol style="list-style-type: none"> 1. Control Room is at the customer premises 2. Control Room is running Enterprise A2019.13 or earlier 3. Installed a license file that was provided to them in July 2020 (not self-generated through the customer self-service license portal) 4. User has upgraded the On-Premises Control Room to Enterprise A2019.14. <p>For this issue, contact Automation Anywhere for updated license files.</p> <hr/> <p>Important: Users who self-generated their license files through the A-People License portal are not affected by this issue. Cloud customers are also not affected by this issue.</p> <hr/> <p>A bot that contains the Capture action from the Recorder package fails when both the <code>HTML InnerText</code> and <code>InnerHTML</code> object properties are selected.</p> <p>Workaround: Select only one of the object properties.</p> <hr/> <p>The Universal Recorder fails to perform a click, set text, or append text action on the correct control when a debug window or download bar is open. This occurs only in the Google Chrome browser with the device display set to 100%.</p> <p>Workaround: Disable the Google Chrome download bar.</p> <hr/> <p>When you create, edit, or run a bot from the Bot editor window, close the Bot editor window when the socket connection has just been established, and then navigate to the My bots page, the Recorder window opens for a moment and then closes.</p>

Known limitation

IQ Bot

The IQ Bot A2019 On-Premises version supports all the features and functionality available in IQ Bot Version 11.3.4.2.

[Automation 360 IQ Bot feature comparison matrix](#)

Review the compatibility of the IQ Bot On-Premises version with the corresponding Control Room On-Premises version.

[Automation 360 IQ Bot version compatibility](#)

The IQ Bot A2019 Cloud version is available for this release and supports all features and functionality available in IQ Bot Version 11.3.4.2. This version provides users with automatic provisioning for up to three environments such as Development, Test, and Production. Users can migrate learning instances between environments using APIs.

New features
<p>Delete bot option in IQ Bot Designer (Service Cloud case ID: 00096258, 00595526)</p> <p>IQ Bot On-Premises and Cloud</p> <p>Users with Edit bot permission can view and use the Delete bot option in the Designer. After a bot is deleted from the system, it will not be displayed in the Learning Instance or Bots listing pages.</p> <p>IQ Bot removes all document details from staging, and all unprocessed production documents are moved to the Validator.</p> <hr/> <p>Note: The Migration Utility > Import/Export functionality is not affected in any way by the Delete bot feature.</p> <hr/> <p>Bots</p>
<p>Extract data from a table that spans across multiple pages (Service Cloud case ID: 00371795)</p> <p>IQ Bot On-Premises and Cloud</p> <p>IQ Bot can now extract data successfully from an entire table that spans across multiple pages and has a table header only on the first page.</p>
<p>Add fields and field alias to custom domain (Service Cloud case ID: 00471075)</p> <p>IQ Bot On-Premises and Cloud</p> <p>You can now add additional fields (form or table) and field aliases to a custom domain for an existing learning instance.</p>
<p>Alert for successful or pending document validations</p> <p>IQ Bot On-Premises and Cloud</p> <p>Document validation status is now displayed on the Learning instances page. A green icon is used for all successful document validations, and a red icon shows any pending validations.</p>

Changed features
<p>Import custom domains from the staging to the production server in any order (Service Cloud case ID 00472445)</p> <p>You can now edit and update an existing custom domain multiple times and import them to the production server multiple times, and in any order, before importing the learning instances. After importing the learning instances, the system classifies all documents in the production server correctly, allowing for successful processing of documents.</p> <p>Custom domains in IQ Bot</p>

Changed features
<p>Validator enhancements (Service Cloud case ID: 00470258)</p> <p>Some of the Validator enhancements are as follows:</p> <ul style="list-style-type: none"> You can now hide the Skip to next file and Mark as Invalid options using configuration settings. The options are currently enabled by default. <p>To enable the option to hide them, contact Automation Anywhere Support.</p> <ul style="list-style-type: none"> You can now hide the Hide successful fields and Hide optional fields options using configuration settings. The options are enabled by default. <p>To enable the option to hide them, contact Automation Anywhere Support.</p> <hr/> <p>Note: Selecting the Hide successful fields and Hide optional fields check boxes hides all the valid fields and reduces the display of a large number of fields, thus making correction easier. However, if there is an invalid field, it continues to be displayed because the invalid field requires correction.</p> <hr/> <ul style="list-style-type: none"> Clicking in any column field expands the column width to accommodate the text entry. The Validator shows the value of the field that is being validated, in the document. Draw an area around single or multiple values in the document image to automatically populate a field in the Validator. This function is similar to the Designer.

Fixed features	
Service Cloud case ID	Description
00552830	You can now use the unique validation link to access the documents without any errors.
-	When you use table extraction from a document with multiple tables, the data from the specified table is now extracted correctly.
00551886	Unicode issue with table validation for Asian languages is now resolved.
00538480	The Options method is now disabled for HTTP requests.
00538480	Cross origin resource sharing is now restricted in IQ Bot.
00421067	The activities time stamp is now captured correctly in the Control Room Audit Logs tab.
00522817	The TestRun output of a custom logic now displays the characters without any distortion, irrespective of the language you select.
00605420, 00605741, 00606561	After upgrading to IQ Bot Cloud if you restart the Control Room, you can now view or create learning instances immediately without restarting the IQ Bot service.

Known limitations
<p>IQ Bot On-Premises and Cloud</p> <p>If you create a learning instance and click Learning instances > Edit, a blank page is displayed.</p> <p>Workaround: Clear your browser cache and try to edit the learning instances.</p>
<p>IQ Bot On-Premises and Cloud</p> <p>If you log in to the Control Room as an IQ Bot administrator, a 502 system error is displayed when you click the IQ Bot tab in the navigation bar.</p>
<p>IQ Bot On-Premises and Cloud</p> <p>You can view the <code>ValidatorURL</code> error message for a validated document along with the corrected field in the <code>.csv</code> output file.</p>
<p>IQ Bot On-Premises and Cloud</p> <p>In Internet Explorer, you cannot save a document or mark it as invalid in the learning instances validator screen.</p> <p>Workaround: Use the Google Chrome browser to access the learning instances validator screen.</p>
<p>IQ Bot Community Edition</p> <p>If you remove a bot (Delete a bot) associated with the document from the staging environment, you must create a group before uploading this document to the production environment. However, after deleting the bot from the staging environment, you cannot create or edit the group when you upload the same document to the production environment.</p>

Bot Insight A2019

New features
<p>Line Bar Chart widget available</p> <p>Enterprise A2019</p> <p>The Line Bar Chart widget enables you to view and analyze information about your metrics and attributes. You can input two metrics and one attribute and display a bar graph when only one attribute is selected or display a clustered graph when two or more attributes are selected. You can use Date types as interval options, grouped by Day, Week, Month, and Year.</p> <p>Bot Insight visualizations</p>
<p>Advanced settings for a query</p> <p>Enterprise A2019</p> <p>You can use the Advanced Settings option to configure more of your queries when you create a new widget. You can now set limits to your attribute values as grouped by 10, 20, 50, and 100 values. You can also sort your data by ascending or descending order.</p> <p>Configuring a Line Bar Chart query</p>

Enterprise A2019.13 Release Notes

Release date: 15 June 2020

Review the new features, supported packages, changed features, fixed features, and known limitations in the Enterprise A2019.13 release. There are no security fixes in this release.

A2019.13 Build 4701 is available for Cloud customers, and Build 4705 is available for On-Premises customers. Community Edition remains on A2019.12 and will be upgraded to A2019.14 upon availability.

- [Enterprise A2019](#)
- [IQ Bot](#)
- [Bot Insight](#)

Enterprise A2019

To verify which version is compatible with this release, see [Compatibility with Automation 360 builds](#).

New features
<p>Migration from Enterprise 11 and Enterprise 10 to Enterprise A2019 (currently available only to those in the Migration Early Adopter Program)</p> <p>Migration to Enterprise A2019 is currently only available to select customers through our Migration Early Adopter Program. If you are interested in learning more about this program or a timeline for when migration will be available to all customers, contact your Automation Anywhere representative.</p> <ul style="list-style-type: none"> • The Insert work item command, workload management queues, and device pools are now migrated to Enterprise A2019. • Schedules are migrated when you copy Enterprise 10 data to Enterprise A2019 or update Enterprise 11 data to Enterprise A2019. You then have to remap some dependencies to enable the migrated schedules. <p>Enable schedules after migration</p> <ul style="list-style-type: none"> • Additional support is provided for packages and variables. <p>Package mapping for migration Variable mapping for migration</p>
<p>Record tasks with a device display setting of 125% or 150%</p> <p>You can now record tasks using Universal Recorder in Java, Microsoft Active Accessibility, and Microsoft UI automation applications on a computer that has a device display setting configured at 125% or 150%, in addition to the existing setting of 100%.</p>
<p>Export bots without enabling SMTP in Bot Lifecycle Management</p> <p>When you export a bot, you can now download the exported package even when SMTP is not enabled. The link to download the exported package is available in the ACTIVITY > Historical page.</p> <p>Export bots</p>

New features
<p>Export and import files using Bot Lifecycle Management APIs</p> <p>Use the Bot Lifecycle Management export and import APIs to move bots from one environment to another based on your organization's automation requirements.</p> <p>You can export bots with dependent files and command packages from the public workspace of one Control Room and import them to a private workspace in another Control Room, and check them into a public workspace. To export and import bots, you must have the Export bots, Import bots, View and Manage packages, and Check in and Check out permissions to the necessary folders and have the Bot Creator license.</p> <p>Bot Lifecycle Management API</p>
<p>Capture scroll action and table using AISense Recorder</p> <p>You can now capture the scroll action in an application window and table control from a remote application when recording a task with AISense Recorder.</p> <p>Record a task with AISense Recorder</p>
<p>Form builder enhancements for interactive forms</p> <p>The form builder includes the following elements:</p> <ul style="list-style-type: none"> • Select File: To enable file upload in the form. • Dropdown: To create a drop-down menu in the form. <p>Create a form</p>
<p>Extract text from a specific area in a window</p> <p>Use the App Integration > Capture area action to extract text from within the captured area of a window and save it to a string variable.</p> <p>App Integration package</p>
<p>Read string variable values from a text file</p> <p>Use the String > Import string from text file action to read values from a text file and save them to a string variable.</p> <p>String package</p>
<p>Automate in IBM-5555 terminals using the Terminal Emulator package</p> <p>The TN5250E terminal type now supports the IBM-5555-C01 and D01 terminal models.</p> <p>Terminal Emulator package</p>
<p>Specify events within email trigger</p> <p>For email triggers, specify an event within the server type (Outlook, Email, or EWS server) to trigger a bot.</p> <p>Add an email trigger</p>
<p>Use hot key for interface trigger</p> <p>For interface triggers, you can select hot key as one of the conditions to trigger the bot</p> <p>Add an interface trigger</p>

New features
<p>Assign action in interactive forms package</p> <p>The interactive forms package now includes an Assign action that you can use to assign values dynamically in the Dropdown element of a form.</p> <p>Interactive forms package</p>
<p>Create a shortcut of a file or folder</p> <p>Use the Folder > Create shortcut or File > Create shortcut action to create a shortcut in the specified destination file path. The shortcut is dependent on the source file or folder. If you make changes to the source file or folder, the changes will also apply to the shortcut.</p> <p>File package Folder package</p>
<p>New conditions in the If and Loop packages</p> <ul style="list-style-type: none"> Use the Data table > Data table is empty condition to execute actions based on whether the specified table contains values. Use the Data table > Number of columns and Data table > Number of rows conditions to execute actions based on whether the number of columns or rows is Equal to, Greater than, or Less than the specified value. <p>If package Loop package</p>
<p>Generate a random string of a user-specified number of characters and assign it to a string variable</p> <p>Use the String > Random action to generate a string of uppercase and lowercase alphanumeric characters. You can specify the number of characters that the generated string consists of, with a maximum of 300 characters.</p> <p>String package</p>
<p>Upgrading Enterprise A2019 enables pre-filling installation parameters</p> <p>If you are upgrading from one Enterprise A2019 version to another, you have the option to pre-fill the installation parameters with existing installation content. Existing installation parameters include, for example, the installation path, HTTPS ports, database names, IP addresses, and TLS configuration. The username and password have to be manually entered.</p> <p>Note that this is applicable only to a Windows-based installation.</p> <p>Run Control Room installer Installing Control Room on Linux</p>

Supported packages	
Package	Version
Node Manager	7.1.5207
Application	2.0.0-20200515-071407
App Integration	1.0.0-20200515-071406
Analyze	2.2.2-20200515-101604
Boolean	2.0.0-20200515-071408
Bot Migration	2.4.0-20200604-174031

Supported packages	
Package	Version
Browser	2.0.0-20200515-071410
Clipboard	2.0.0-20200515-071418
Comment	2.0.0-20200515-071418
CSV/TXT	2.0.0-20200515-071419
Database	2.0.0-20200515-071421
Data Table	2.0.0-20200515-071731
Datetime	2.0.0-20200515-071424
Delay	2.1.0-20200515-071425
Dictionary	2.0.0-20200418-005349
Run DLL	2.0.0-20200515-071713
Email	2.0.0-20200515-071427
Error handler	2.0.0-20200515-071432
Excel basic	2.0.0-20200515-071623
Excel advanced	4.0.0-20200604-173722
File	2.1.0-20200515-071434
File & folders	2.0.0-20200317-030352
Folder	2.1.0-20200515-071436
FTP / SFTP	2.0.0-20200515-071439
IF/ELSE	2.0.0-20200515-071441
Image Recognition	2.0.0-20200515-071454
Interactive forms	2.12.0-20200420-084203
IQ Bot	2.0.0-20191031-150538
JavaScript	2.0.0-20200515-071459
Simulate keystrokes	2.0.0-20200515-071502
Legacy Automation	2.0.0-20200515-133330 1.0.0-20200515-133334
List	2.0.0-20200515-071509
Log To File	2.0.0-20200515-071509
Loop	2.0.0-20200515-071511
Message Box	2.0.0-20200515-071511
Mouse	2.0.0-20200515-071517
Number	2.0.0-20200515-071522
OCR	2.1.0-20200516-083309

Supported packages	
Package	Version
Office 365 Excel	2.0.0-20200515-071608
Office 365 Calendar	2.0.0-20200515-071414
Office 365 OneDrive	2.0.0-20200515-071614
PDF	2.1.0-20200515-071618
PGP	2.1.0-20200515-071620
Ping	2.0.0-20200515-071621
Printer	2.0.0-20200515-071626
Play Sound	2.0.0-20200515-071622
Prompt	2.0.0-20200515-071627
Python Script	2.0.0-20200515-071628
Recorder	2.0.5-20200523-020302
REST Web Service	2.0.0-20200515-071712
SAP	2.1.0-20200515-071715
Screen	2.0.0-20200515-071718
SNMP	2.0.0-20200515-071720
SOAP Web Service	3.0.0-20200515-071723
String	3.0.0-20200515-071729
System	2.0.0-20200515-071729
Task	2.0.0-20200519-082744
Terminal Emulator	2.0.0-20200515-071735
Trigger Email	1.1.0-20200515-022805
VBScript	2.0.0-20200515-071737
Wait	3.0.0-20200515-071739
Window	2.0.0-20200515-071753
Workload	2.0.0-20200422-054201
XML	2.0.0-20200515-071743

Changed features
The Dictionary > Put action is now the Dictionary > Set value action. When you provide the key name, if the key does not already exist, this action creates a new key-value pair. In addition, you can now manually enter a value; previously, you had to select from a list of variables.
In the Excel advanced > Get worksheet as data table action, the Tick if the first row is the header option is now the Sheet contains header option. There is no change in functionality.

Changed features
The File > Rename and Folder > Rename actions now accept the full file path in the New file name and New folder name fields. Previously, these fields only accepted the new file or folder name.
When you select a file from the desktop for the JavaScript, Python Script, or VBScript packages, it is no longer necessary to isolate that file in a separate folder. Previously, when you selected a file with the Open action, all the files in that folder were selected too.
The Database > Run stored procedure action now has a different interface that enables you to configure input parameter values and output parameter data types. This action is not backward-compatible because the user interface controls and input data type have changed. You must modify the Run stored procedure action fields in the bots that contain previous versions of this action.
The Cloud License feature is now enabled by default in the Control Room.

Fixed features	
Service Cloud case ID	Description
00492377, 00511639	Bots using the Image Recognition action can now recreate the recorded activity and run successfully.
00599586, 00600149, 00601142, 00599483	The <code>Processing failure</code> error encountered when using the Wait for condition action is now fixed. Bots using this action now run successfully.
00583248	During Work Item consumption, a running task is no longer canceled when the next bot is deployed.
00548456	The Workload Management v3 APIs are now successfully executed in Swagger and do not fail because of a case-sensitive issue.
00601083	For Cloud deployment, users can now successfully export bot files and download them without any errors.
00568664	The Git integration option is now displayed for admin users when they navigate to ADMINISTRATION > Settings in the Control Room.
--	The minimum length value of a form element cannot be 0. If you set the value as 0 in Character limit > Min field, the Make field required is disabled.
00571125	When you check in a non-bot file by itself, the file is now checked in without any error. Older files that exist in Build 4111 are also unlocked and checked in after upgrading to Build 4705.
--	The form preview feature is now consistent across the Internet Explorer and Google Chrome browsers.
--	A blank page is no longer displayed when you paste content into any of the existing form elements on the form builder.
--	A form that is linked to a bot through the Display action of interactive forms is now displayed in front of all other windows when the Always display form window in front option is selected.

Fixed features	
Service Cloud case ID	Description
--	When a user login failed due to a Global Catalog (GC) availability issue, the response only indicated a communication error. The process now checks for errors and exceptions in the GC and processes the authentication with appropriate messages, so users can take appropriate action.
00520394	The VBScript package actions now support Unicode characters.
00536881	When you delete a bot, any trigger that is associated with it is also deleted and is not listed in the Activity list page.
00506169	You can now use the interface trigger to run a bot without any errors in the Japanese operating system.
00537640, 00538369	When you check out a bot from the Control Room and add a trigger, you can now use Run with triggers to run this bot without any errors.
00531912	JavaScript package actions can now be used to parse the values in a list.
00475183	Double-byte characters returned unreadable ANSI characters in the bot Log To File text. This issue is now fixed and ANSI encoding takes the system default charset.
00475129	You can now use double-byte characters in a variable name.
00511675	The Excel advanced > Find action now searches for values in merged cells when the By rows search option is used.
00468103, 00475142	Bot names using Unicode characters, such as German umlaut, Japanese characters, and others, display correctly in the pop-up window at runtime.
00552701, 00558919	You can now select multiple actions from the Bot editor and drag them into a Step, Loop, or If action.
00507240	Fixed an issue where a running parent bot could not be stopped after it ran a child bot. Now you can stop a bot at any time.
00482810	VBScript actions can now run scripts that contain Unicode characters.
00472684, 00541922, 00551632, 00534508, 00570602	The Email > Send action now supports a user-input port number for sending emails from an SMTP server, such as AWS Simple Email Service. Previously, the action only used port 25, even if the user entered a different port number.
00475230	Fixed an issue where the String > Replace action did not support an empty string in the Replace with field. You can now use the action to replace a specific string with an empty string.
00472665	When a child bot shows an error, the parent bot now handles the exception by running the Error Handler > Catch action. Previously, the parent bot was also showing an error, even when it contained Error handler actions.

Fixed features	
Service Cloud case ID	Description
00566476, 00560339	Fixed an issue where bots that contain the Capture action stopped working when running the action during deployment, or they could not be checked out after they were checked-in for editing.
00537139	A bot running the Capture action can now capture specific objects from a Google Chrome browser on a device running the Windows 10 operating system. In some cases, bots running the Capture action from Version A2019.11 On-Premises could only capture the entire browser window.
00421864	The Create a bot screen now displays properly in Internet Explorer. Previously, some display issues occurred where the screen was cut on the right side and the screen could not be moved.
00584341	Fixed an issue where some of the historical activity entries were incorrectly displayed. These entries are now displayed correctly when a user drills down for more information.

Known limitations
When you create a Dictionary/Table variable and use it in the <code>name</code> field of the PROPERTIES control, the bot does not deploy successfully. This issue occurs because Dictionary/Table variables are not supported for the <code>name</code> field in the PROPERTIES control. You can pull the <code>name</code> value into a String or Number variable before using it in the PROPEPTIES control, and then use that String or Number variable in it.
You can use Swagger to export bots but not to download exported bots. You have to use the REST Client to download exported bots.
When you run a bot, the runtime window is minimized after you preset the desktop.
The OSS Disclosure report provided in the A2019 installer is outdated. Starting from this release, you can log in to Automation Anywhere Support site and download the updated report: A-People Downloads page (Login required) .
When you capture a table control from an application using the AISense Recorder, you cannot set text using the Set text option from the Actions list. You can set text in the table by capturing a cell from the table as a text box and then using the Set text option from the Actions list.
When upgrading from one Enterprise A2019 version to another, you have the option to pre-fill the installation parameters with existing installation content, but only if you used the default installation path <code>C:\Program Files</code> .
Note: This is applicable only to a Windows-based installation.
Based on the permission assigned by an administrator, users can only view the Public tab that lists the available forms and bots. However, users can edit an available form or bot by replacing View with Edit in the Control Room URL.
When you create a bot and link a form to it, the bot is included only when you check in the form; it is not available on form check-out.

Known limitations
When you click multiple icons (Copy, Cut, and Paste) at the top of the form builder or bot creator page, the tooltips overlap.
<p>Issues in the form builder:</p> <ul style="list-style-type: none"> • If you drag any form element into a specific position on the form builder, it always appears at the bottom of the available elements. • If you drag form elements around in the form builder screen in Internet Explorer, the mouse pointer flickers continuously. • For the Radio button element, you cannot set the default selection in Advance behaviors. • For the Checkbox element, changes made to the check box names in the Checkbox content field are not updated when you enable Advance behaviors > Make default selections.
When a bot runs Terminal Emulator package actions in an IBM-5555 terminal, the terminal window does not display double-byte characters, including Chinese and Japanese characters.
If you used the Universal Recorder to capture a menu item from a Microsoft Active Accessibility application on a computer that has a display scale setting configured to 100%, at runtime the bot does not click the correct menu item on a computer that has a display scale setting configured to 125% or 150%.
During GUID provisioning, License Sync is called internally after a successful installation. If the internal License Sync fails but the installation is successful, users can log in and continue to work.
When a task that consists of one or more subtasks is run, the In Progress entry for the task is placed into a historical report upon completion of the first subtask, not the entire governing task.
An error occurs if the parent bot contains actions for objects captured using the AISense Recorder and the child bot contains actions for objects captured using the Universal Recorder, or vice versa.

IQ Bot

The IQ Bot On-Premises version supports all the features and functionality available in IQ Bot Version 11.3.4.2.

[Automation 360 IQ Bot feature comparison matrix](#)

Review the compatibility of the IQ Bot On-Premises version with the corresponding Control Room On-Premises version.

[Automation 360 IQ Bot version compatibility](#)

The IQ Bot Cloud version is available for this release and supports all features and functionality available in IQ Bot Version 11.3.4.2. This version provides users with automatic provisioning for up to three environments such as Development, Test, and Production. Users can migrate learning instances between environments using APIs.

For the Custom Logic feature, there is an identified list of Python libraries and packages that are safe to use for IQ Bot Cloud. Use only these packages to ensure security for your cloud infrastructure, file systems, databases, and network resources.

[List of Pandas Libraries which are supported and not supported on Automation 360 IQ Bot \(A-People login required\)](#)

New features
<p>Migrate data to a unified database</p> <p>IQ Bot On-Premises and Cloud</p> <p>The Database Migration Assistant enables you to migrate data from IQ Bot Version 6.5 or later databases to a unified database in IQ Bot A2019.</p> <p>Migrate earlier IQ Bot versions to Automation 360 IQ Bot On-Premises</p>
<p>Support for custom validation Python scripts</p> <p>IQ Bot Cloud</p> <p>You can use custom logic in Python to modify intermediate extracted data in IQ Bot.</p> <p>Add custom logic in IQ Bot to improve extraction</p>
<p>Select an OCR engine when creating a learning instance</p> <p>IQ Bot On-Premises and Cloud</p> <p>You can select different OCR engines directly from the UI based on your requirements for data extraction from specific document types, when creating a new learning instance. You do not have to stop and restart IQ Bot services for implementing the engine change.</p> <p>Select an OCR engine</p>
<p>Enable or disable PDFBox option</p> <p>IQ Bot On-Premises and Cloud</p> <p>You can enable or disable the My PDF documents do not have images check box directly in the UI when creating a learning instance.</p> <p>Disable PDFBox option</p>

Changed feature
<p>The draw box icon for document values is no longer available. However, you can still click and drag a box on the document to draw boxes for the labels along with the values.</p>

Fixed features	
Service Cloud case ID	Description
--	A new REST API is now available that contains the IQ Bot validator URLs of all the available documents that are not locked by any users. A validator URL retrieved from the REST API can be used in any browser to navigate directly to that specific document.
00343034	You are now redirected to a specific document using the validator URL after a successful login.
00471068, 00339407	The draw box functionality for field labels now ensures that the selected value is treated as an entire word rather than distinct characters. You can now select multiple system identified regions (SIRs) or a specific part of a single SIR from a field label, which enables accurate data extraction.

Fixed features	
Service Cloud case ID	Description
--	The PDF Box feature now enables you to generate an SIR for a PDF file that contains content in multiple formats.
00481720	The Service account user password can now include special characters. The service account will not be locked and all the IQ Bot services will start successfully after an installation, irrespective of whether the password has special characters.
00510286, 00548393	When the Automation Anywhere Cognitive Application service restarts after installing IQ Bot Build 4705, the user login information is now captured without any duplication. However, if you upgrade from any earlier version of IQ Bot to IQ Bot A2019.13 (Build 4705), you must deregister and register IQ Bot services.
00522978	When you now install IQ Bot, the user account is not locked even when the password has special characters, and all the IQ Bot services start without any issues.
00581425, 00581949, 00604394, 00602630	You can now register IQ Bot with child tenant using API, which enables you to view all the available domains and learning instances.
00575939, 00417631, 00423076	The <code>.csv</code> file is now displayed in the Output folder when you upload a document with a long filename (more than 60 characters) using IQ Bot Upload .

Known limitations
<p>IQ Bot On-Premises</p> <p>The OSS Disclosure report provided in the IQ Bot A2019 installer is outdated. Starting from this release, you can go to Automation Anywhere support site to download the updated report: A-People Downloads page (Login required).</p>
<p>IQ Bot On-Premises and Cloud</p> <p>Images on the Designer in IQ Bot appear distorted while scrolling in Internet Explorer.</p>
<p>IQ Bot On-Premises and Cloud</p> <p>Installation errors are displayed for the Database Migration Assistant.</p> <p>Workaround: Install the <code>MsSqlCmdLnUtils</code> utility and <code>Microsoft ODBC Driver 17 for SQL Server</code> before installing the Database Migration Assistant.</p>
<p>IQ Bot On-Premises and Cloud</p> <p>Logs are not captured if the Database Migration Assistant installation fails.</p>
<p>IQ Bot Cloud</p> <p>System suggestions are not updated when documents are validated by the user.</p> <p>Workaround: Users must update the correction manually in the validator for IQ Bot Cloud if the system suggestions are not displayed.</p>

Known limitations
<p>IQ Bot Community Edition</p> <p>The Create new learning instance page refreshes automatically, which causes the user to lose data from the General information fields.</p>
<p>(Service Cloud case ID: 00737991)</p> <p>When you are creating a learning instance and training your document, IQ Bot system cannot extract data from tables with the same Header Name and Column Value.</p> <p>Workaround: Try combining Header Name or Column Value with the adjacent column. Additionally, you can provide a Python postprocessing script to separate the values during extraction.</p>

Bot Insight

New features
<p>Compare mode widget filter</p> <p>The Bot Insight compare mode introduces widget filters that you can apply to your existing dashboards. A new Filter option shows a Filter window with the Attributes, Numeric, and Time widgets.</p> <p>Comparing dashboards</p>
<p>Hourly support for widgets</p> <p>The Bot Insight widgets include an Hour interval option in the Group By field for Date type. The analytics for this widget groups your data by hourly intervals and displays the chart accordingly.</p> <p>Using widgets</p>

Changed features
<p>Power BI connector</p> <p>You can access the AABotInsightV3.mez data connector file from C:\Program Files\Automation Anywhere\Enterprise\Connectors\PowerBI and copy it to C:\Users\<your bi="" connector.<="" connectors="" deploy="" desktop\custom="" p="" power="" the="" to="" user>\documents\powerbi=""> <p>Deploy Power BI connector</p> </your></p>
<p>Bot Insight APIs</p> <ul style="list-style-type: none"> • All of the parameters are now optional. • The <code>botname</code> parameter in the <code>Get task log data</code> API supports multiple bot names, separated with a comma. • There are no time period limitations now on the data retrieved. <p>Bot Insight API</p>

Enterprise A2019.12 Release Notes

Release date: 18 May 2020

Review the new features, supported packages, changed features, fixed features, and known limitations in the Enterprise A2019.12 (Build 4111) release. IQ Bot Build 4088 is compatible with Enterprise A2019.12 Build 4111. There are no security fixes in this release.

- [Enterprise A2019](#)
- [IQ Bot A2019](#)
- [Bot Insight A2019](#)

Enterprise A2019

Bot agent update: This release includes a required update to your . Ensure that you complete the update to continue with your automation activities when upgrading from a previous release to this release.

[Automatically update the Bot Agent](#) | [Manually update the Bot Agent](#)

To verify which version is compatible with this release, see [Compatibility with Automation 360 builds](#).

New features
<p>Migration from Enterprise 11 and Enterprise 10 TaskBots and MetaBots to Enterprise A2019 (currently available only to those in the Migration Early Adopter Program)</p> <p>Enterprise A2019</p> <p>Migration to Enterprise A2019 is currently only available to select customers through our Migration Early Adopter Program. If you are interested in learning more about this program and requirements, contact your Automation Anywhere representative.</p> <ul style="list-style-type: none"> • Migrate TaskBots and MetaBots created in Enterprise 10 to Enterprise A2019. <ul style="list-style-type: none"> • Migrate Enterprise bots • The summary report generated by the Bot Scanner now provides information about the number of bots that can or cannot be migrated to Enterprise A2019. <ul style="list-style-type: none"> • Analyze Bot Scanner report for migration • (Enterprise 11 only) Additional support is provided for packages and variables. <ul style="list-style-type: none"> • Package mapping for migration Variable mapping for migration • (Enterprise 11 only) Migration APIs enable you to migrate a single Enterprise 11 bot or entire folders of bots to Enterprise A2019. Use the Repository Management API to identify bots and folders for migration. <ul style="list-style-type: none"> • Migration APIs Repository Management APIs
<p>Integrate Control Room with a remote Git repository</p> <p>Enterprise A2019</p> <p>Integrate the Control Room with remote Git repositories to manage bot version controls, and back up and restore bots and the dependent files. The integration ensures one-to-one mapping of bots between the Control Room and the remote Git file structure. When you perform a bot check-in, a Git commit is performed at the remote Git host.</p> <p>Integrating Control Room with Git repositories</p>

<p>New features</p> <p>Additional actions in the Interactive forms package</p> <p>Enterprise A2019 and Community Edition</p> <p>The Interactive forms package includes the following actions:</p> <ul style="list-style-type: none"> • Set focus: Sets the focus on the selected form element. • Highlight: Highlights the selected element of a form. • Unhighlight: Removes the highlight from the selected element of a form. <p><i>Interactive forms package</i></p>
<p>Form builder enhancements for interactive forms</p> <p>Enterprise A2019 and Community Edition</p> <p>The form builder includes the following elements:</p> <ul style="list-style-type: none"> • Document: Use this element to render an image (.jpg) or PDF file along with the form. • Password: Use this element for a field that requires masking of the input data. <p><i>Create a form</i></p>
<p>Run Task Bot option for attended Bot Runner (Service Cloud case ID: 00453797)</p> <p>Enterprise A2019 and Community Edition</p> <p>If the default device is mapped to the Bot Agent, a user with an attended Bot Runner license in the Control Room can now use the Run Task Bot option from the bot context menu (vertical ellipsis) to run the bot.</p> <p><i>Considerations for running a bot</i></p>
<p>New features in Universal Recorder and actions that use the recorder feature</p> <p>Enterprise A2019 and Community Edition</p> <ul style="list-style-type: none"> • Secure recording mode ensures that sensitive data is not stored in the bots. When secure recording mode is enabled, the bots do not capture application images or values. <p>Actions in the Image Recognition, Mouse, OCR, Screen, and Recorder packages support this feature.</p> <ul style="list-style-type: none"> • JRE 6 is supported on both 32-bit and 64-bit systems. • After you capture an object, you are returned to the window containing the Bot editor. <p>Actions in the Image Recognition, Mouse, OCR, Screen, and Recorder packages support this feature.</p> <p><i>Recording tasks in applications that run on JRE Secure recording mode</i></p>
<p>Insert a work item action</p> <p>Enterprise A2019 and Community Edition</p> <p>The Insert work item action provides you the flexibility to insert a work item from an existing queue to another queue as part of the bot execution. You can orchestrate multiple bots, enabling optimal device utilization through the queueing mechanism of workload management.</p> <p><i>Workload package</i></p>

New features
<p>View error details of a work item</p> <p>Enterprise A2019 and Community Edition</p> <p>You can view the reason for a workload automation failure in the new Error section on the View work item details page.</p> <p>View work items</p>
<p>Extract text from windows</p> <p>Enterprise A2019 and Community Edition</p> <p>Use the Capture text of window action to extract text from a window and save it to a string variable. You can capture text from UNIX shells and Windows applications.</p> <p>App Integration package</p>
<p>Store string values securely in a credential variable</p> <p>Enterprise A2019 and Community Edition</p> <p>Configure a credential variable to hold a user-provided value or a credential from the Credential Vault. A credential variable cannot be converted to another data type, and the value cannot be displayed in a message box or written to a file.</p> <p>User-defined variables: Credential</p>
<p>Preload packages for improved bot performance</p> <p>Enterprise A2019 and Community Edition</p> <p>Preload packages on your local device to shorten the bot runtime. When you preload packages used in a bot, the system skips the package download process at bot runtime, thereby improving the bot performance.</p> <p>Preload packages</p>
<p>New features in the If and Loop packages</p> <p>Enterprise A2019 and Community Edition</p> <ul style="list-style-type: none"> Execute actions based on whether the value of the source datetime variable is Equal to or Not Equal to, or is Greater than or Equal to, or is Lesser than or Equal to the value of the target datetime variable. Execute actions on migrated bots based on whether Web control exists or is active. Configure a Loop action with multiple conditions. <ul style="list-style-type: none"> Specify whether all or either of the conditions must be met. <p>If package Loop package</p>
<p>Run a bot by inserting a file variable in the Run action</p> <p>Enterprise A2019 and Community Edition</p> <p>The Task Bot > Run action now supports a file variable input in the Task Bot to run field.</p>

New features
<p>Configure a table variable using the Assign action in Data Table package</p> <p>Enterprise A2019 and Community Edition</p> <p>You can use this action to manually enter values, assign column names, specify the column data type (string, number, datetime, or Boolean), and move columns and rows.</p> <p>Data Table package</p>
<p>Configure Wait package actions to terminate a running bot if a condition is unsatisfied</p> <p>Enterprise A2019 and Community Edition</p> <p>Select the Throw an exception option in the Wait for screen change and Wait for window actions to show an error message and terminate a bot if the screen does not change or the window does not open or close within the specified amount of time.</p> <p>Using Wait for screen change action Using Wait for window action</p>
<p>Email trigger for new emails</p> <p>Enterprise A2019 and Community Edition</p> <p>Use email triggers to start a bot when a new email message is received in the specified email service. Supported email services are:</p> <ul style="list-style-type: none"> • Microsoft Outlook • Email Server • EWS Server <p>Add an email trigger</p>
<p>Generate a random integer from a user-specified range and assign it to a number variable</p> <p>Enterprise A2019 and Community Edition</p> <p>Use the Random action from the Number package to generate an integer in the range of -9,223,372,036,854,775,808 through 9,223,372,036,854,775,807.</p> <p>Random number action</p>
<p>Enterprise A2019 Bot Agent OS support</p> <p>Enterprise A2019</p> <p>Enterprise A2019 Bot Agent is now supported for single users on Windows Server 2019, Windows Server 2016, Windows Server 2012, Windows 8, and Windows 7 SP1.</p> <p>Bot Agent compatibility</p>
<p>Return the Bot Agent installation path using the system variable AAInstallationPath</p> <p>Enterprise A2019 and Community Edition</p>
<p>Copy and paste actions and triggers between bots (Service Cloud case ID: 00455116)</p> <p>Enterprise A2019 and Community Edition</p> <p>Use the Copy to shared clipboard and Paste from shared clipboard icons at the top of the Bot editor to duplicate actions, triggers, and metadata at a time.</p>

New features
<p>GDPR self-reporting</p> <p>Enterprise A2019 and Community Edition</p> <p>General Data Protection Regulation self-reporting enables the Control Room administrator to run reports that include the following data elements (sensitive data will be masked in the output):</p> <ul style="list-style-type: none"> • User Bot Runner device access. • User data in associated credential vault. • Devices registered by the user. • All documents (artifacts) uploaded or updated to public or private repositories by the user. • All bots associated to the user. • Bot Insight dashboard report includes a list of all dashboards associated to this user ID.

Supported packages	
Package	Version
Node Manager	6.5.4738
Application	2.0.0-20200418-005328
App Integration	1.0.0-20200418-005326
Analyze	2.2.1-20200314-193039
Boolean	2.0.0-20200418-005329
Bot Migration	2.3.0-20200424-015945
Browser	2.0.0-20200418-005330
Clipboard	2.0.0-20200418-005342
Comment	2.0.0-20200418-005342
CSV/TXT	2.0.0-20200418-005342
Database	2.0.0-20200418-005345
Data Table	2.0.0-20200418-005637
Datetime	2.0.0-20200418-005348
Delay	2.1.0-20200418-005348
Dictionary	2.0.0-20200418-005349
Run DLL	2.0.0-20200418-005620
Email	2.0.0-20200418-005352
Error handler	2.0.0-20200418-005357
Excel basic	2.0.0-20200422-000204
Excel advanced	2.0.0-20200422-000103
File	2.0.0-20200418-005358
File & folders	2.0.0-20200317-030352
Folder	2.0.0-20200418-005400

Supported packages	
Package	Version
FTP / SFTP	2.0.0-20200418-005404
IF/ELSE	2.0.0-20200418-005406
Image Recognition	2.0.0-20200420-104210
Interactive forms	2.12.0-20200420-084203
IQ Bot	2.0.0-20191031-150538
JavaScript	2.0.0-20200418-005413
Simulate keystrokes	2.0.0-20200418-005415
Legacy Automation	1.0.0-20200422-075546 1.0.0-20200422-075549
List	2.0.0-20200418-005422
Log To File	2.0.0-20200418-005423
Loop	2.0.0-20200418-005424
Message Box	2.0.0-20200418-005424
Mouse	2.0.0-20200418-005428
Number	2.0.0-20200418-005433
OCR	2.1.0-20200418-005434
Office 365 Excel	2.0.0-20200418-005517
Office 365 Calendar	2.0.0-20200418-005338
Office 365 OneDrive	2.0.0-20200418-005523
PDF	2.1.0-20200418-005526
PGP	2.1.0-20200418-005528
Ping	2.0.0-20200418-005529
Printer	2.0.0-20200418-005535
Play Sound	2.0.0-20200418-005530
Prompt	2.0.0-20200418-005536
Python Script	2.0.0-20200418-005537
Recorder	2.0.0-20200318-020414
REST Web Service	2.0.0-20200418-005619
SAP	2.1.0-20200418-005622
Screen	2.0.0-20200418-005625
SNMP	2.0.0-20200418-005627
SOAP Web Service	3.0.0-20200418-005630
String	3.0.0-20200418-005635

Supported packages	
Package	Version
System	2.0.0-20200418-005636
Task	2.0.0-20200417.230104-1256
Terminal Emulator	2.0.0-20200418-005641
Trigger Email	1.1.0-20200418-005652
VBScript	2.0.0-20200418-005643
Wait	3.0.0-20200418-005645
Window	2.0.0-20200418-005700
Workload	2.0.0-20200422-054201
XML	2.0.0-20200418-005650

Changed features
<p>Build 4105 replaced with Build 4111</p> <p>Build 4105 has been deprecated and replaced with Build 4111. If you have installed Build 4105 on Windows, perform a regular upgrade to get the new build. If you have installed Build 4105 on Linux, you must uninstall it and reinstall Build 4111. After you are on Build 4111, an update to Bot Agent 7.0.4789 is also required.</p> <p>Update to latest Automation 360 version</p>
<p>User interface changes in Excel basic and Excel advanced packages</p> <p>The text field titled Cell name is now Cell address in the actions from the Excel basic and Excel advanced packages.</p>
<p>Specify the column title in the Get cell address action in the Excel advanced package</p> <p>The Specific cell option is now the Based on header option, which accepts the column title as either the column heading or the default column title.</p> <p>Using the Get cell address action</p>
<p>Edit a work item without changing its status</p> <p>You no longer have to change the status of a new work item for editing. You can now edit work items that are in New status. Previously, you were allowed to edit the work item attribute values after changing the state of the attributes so that the edits to the work item could be saved.</p> <p>Edit work items</p>
<p>Mark work items for reprocessing</p> <p>The Ready to run action is now updated to Re-process so that you can mark work items that are in Failed, Data error, or On hold state to New status for reprocessing.</p> <p>View work items Edit queues</p>

Fixed features	
Service Cloud case ID	Description
00560339	You can now do a second checkout of the same bot, make updates (for example delete a command) , and check it back in. The "File Not Found" error that prevented subsequent checkouts of the same bot and data deletion not actually getting deleted has been fixed.
--	Devices running an older version of the Bot Agent can now connect to A2019.12 Control Room.
--	Secure Data Store (SDS) installation on Enterprise A2019.12 is now working.
00530388	Multiple bot updates and check-ins succeed irrespective of the Enterprise A2019 version used to import the bot. Bot check-in on Cloud deployments used to fail when the bot was imported multiple times and overwritten. This issue is now fixed.
00521691	After Excel files are extracted from a .zip file, common tasks such as renaming and deleting the Excel files failed. This issue is now fixed.
00519528	Bot Scanner version 2.0.0 now works as expected. The crash issue is now fixed.
00517040	When the Email package is used in Exchange Web Services, the action loop exited after processing 10 emails. This early exit is fixed. Now all specified emails are processed before the loop exits.
00504163	When bots are run using the Open and Close actions from the DLL package in a loop, the Bot Agent window now functions correctly. The Bot Agent service does not require a manual restart after a bot is run.
00494267	Actions from the DLL package can now be run inside and outside a loop.
00494273	The Create worksheet action in the Excel advanced package now supports default sheet names for all the supported languages in Enterprise A2019.
00492554	The Sort table action in the Excel advanced package now supports OS setting for the Swedish region.
00446956	The Open action in the CSV/TXT package can now read values from files encoded with UTF-8.
00503230	The SOAP Web Service action now supports responses with non-English characters.
00522147	The \$StringVar.String:trim\$ shorthand now trims leading and trailing spaces in a string when used in the Message box package.

Fixed features	
Service Cloud case ID	Description
--	You can now deploy bots on selected Bot Runner devices with the Run as option from the My bots page in an Control Room configured on Microsoft Azure.
--	Scheduled bots now run as expected and do not get stuck in the queue in an Control Room configured on Microsoft Azure.
--	<p>After you capture an object in a browser or application window, the browser window containing the Bot editor is now reactivated. Previously, users had to manually return to the Bot editor.</p> <p>Actions in the Image Recognition, Mouse, OCR, Screen, and Recorder packages support this feature.</p>
00475070	Exporting a report to CSV from Activity > Historical now correctly outputs the data.
00516331	You can now build a bot that contains more than one Database > Read from action that is followed by a Loop action, within the same database session. Each time the bot runs the Read from action, the query results are refreshed, and the loop will only iterate on the current results.
00509735	Auto Login now works when you deploy a bot as an unattended Bot Runner on a Horizon Virtual Desktop Infrastructure (VDI) session.
00509831	Prompt package actions now support long inputs. The user interface displays up to 512 characters. If the input is longer than 512 characters, the rest appear as a tooltip when the user hovers over the prompt box.
00518566	You can now use the recorder feature within actions to select window titles and file paths on a device that has proxy authentication enabled. Previously, users had to manually enter this information because they could not access the device through actions while building a bot.
00475107	The Japanese language now supports column names when using CSV-related actions.
00532894 00532253 00539241	When you reimport a bot using exported files from a different Control Room of the same version (from version A2019.12 onward) and choose to overwrite the bot, you can now check-in that bot. The error generated when you choose the overwrite option that prevented check-in of the reimported bot is now fixed only for version A2019.12 onward. Reimporting bots on A2019.11 and older releases are not supported at this time.
00521222, 00525635, 00529274, 00526613, 00526489, 00530609, 00530787, 00533445, 00535366, 00530900, 00538070	The progress of a TaskBot is not stalled at line 0 and does not remain in queue to run when you deploy the bot on a Bot Runner. The status of the device reflects <i>Yet to Be Determined</i> until the device is available to process the items.

Fixed features	
Service Cloud case ID	Description
00421195	You can now create a work queue by providing details such as the queue name, queue owners, participants, consumers, and work item structure. This feature is available from Workload > Queues > Create Queue .
00533465	When you delete any action from an existing bot, the corresponding metadata for the deleted action is now removed from the bot.

Known limitations
If you are running A2019.12 Enterprise On-Premises with build 4105 on Linux and want to use Build 4111, then you must uninstall Build 4105 and do a fresh installation of Build 4111. You cannot perform an upgrade to get Build 4111. See Uninstall Automation 360 On-Premises from Linux server . A2019.12 Enterprise On-Premises on Windows can be upgraded as normal.
The Send reset password email functionality (from the Administration > User page) to help users reset their password is not working and returns a 401 error. Users should use the "Forgot password?" flow to reset their password.
Folders created using the Folder > Create action cannot have names that contain system actions or device references such as AUX, CON, LPT, NUL, and PRN.
Mouse click with key combo for preset triggers in SAP application is currently not supported.
The following are known limitations in the form builder: <ul style="list-style-type: none"> • If the character limit is set to 0 and the field is marked necessary for the Password element in a form, an error message is displayed when you run the bot. • An invalid file path associated with the Document element in a form displays an error message when the Get and Set actions of the interactive forms are used. • A blank page is displayed on the form builder when you paste content into any of the existing form elements. • A form that is linked to a bot through the Display action of interactive forms is displayed in front of all other windows, even when the Always display form window in front option is not selected.
Cloud-enabled deployments only support local authentication.
Linux is not supported for Cloud-enabled On-Premises installations.
<ul style="list-style-type: none"> • Work items might be queued on the View queues page as the number of devices in the device pool increase. This should not affect the bot execution because the queues are cleared when the work items are processed. • You cannot simultaneously insert work items from multiple devices in a queue. • You cannot create a draft queue. • When you insert a number value using the Insert work item to a queue, the system shows an incorrect value. For example, if you insert 023456789, the system shows 2.3456789E7. • When you add more devices to a device pool that is processing workload management automations, the newly added devices might not immediately pick up the pending work items. <p>Workaround: Pause and resume the workload management automation.</p>

Known limitations
If a device goes idle while processing workload management work items in a device pool, it will not process the work items. However, those work items can be processed by other devices in the pool.
When you create a form with using the Document element and provide an incomplete file path, your bot will not run successfully.
When you create a form and specify that a password is required, the password length can be set to 0.

IQ Bot (Build 4088)

Enterprise A2019.12 Build 4111 is compatible with IQ Bot A2019 (Build 4088).

The IQ Bot On-Premises version supports all the features and functionality available in IQ Bot Version 6.5.2.

[IQ Bot feature comparison matrix](#)

Review the compatibility of the IQ Bot On-Premises version with the corresponding Automation Anywhere Control Room On-Premises version.

[Automation 360 IQ Bot version compatibility](#)

The IQ Bot Cloud version is available for this release and supports all features and functionality available in IQ Bot Version 6.5.2. This version provides users with automatic provisioning for up to three environments such as Development, Test, and Production. Users can migrate learning instances between environments using APIs.

The IQ Bot Community Edition and the free trial version are available for this release. Both versions have feature parity and are based on IQ Bot Version 6.5.2.

Known limitations
IQ Bot On-Premises IQ Bot registration is not supported for Cloud-enabled On-Premises installations.

Bot Insight

New features
<p>View filtered data of the dashboard widgets</p> <p>Enterprise A2019 and Community Edition</p> <p>The Bot Insight dashboard widget filter enables you to apply filters across the widgets in the dashboard to display filtered data. While the dashboard filters enable you to view different combinations of information from a single dashboard, the widget filters enable you to drill down to information from the already filtered data. You can also save and publish the custom dashboards with the preset widget filters.</p> <p>Bot Insight dashboard filter</p>

New features
<p>Retrieve information from the Bot Insight API, and generate and visualize data analytics on Microsoft Power BI</p> <p>Enterprise A2019 and Community Edition</p> <p>The Automation Anywhere custom connector enables you to establish a secure connection to Microsoft Power BI, and generate and visualize data analytics. You can select the Bot Insight APIs in Microsoft Power BI and apply specific parameters for each of the APIs. The custom connector transforms the Bot Insight API responses to data model visualizations in Microsoft Power BI.</p> <p>Data connector for Power BI</p>
<p>Preview and analyze business information in the default business dashboard</p> <p>Enterprise A2019 and Community Edition</p> <p>The Data Preview menu in the Bot Insight default business dashboard displays information that is logged for multiple Analyze Open and Close commands used in the bot. The Preview Data menu does not appear when you perform a comparison between the default dashboards.</p>
<p>API enhancements</p> <p>Enterprise A2019</p> <p>The <code>deletetasklogdata</code> API is updated to include the <code>runId</code> parameter. The <code>getbotrundata</code> API retrieves information about the vital statistics of the bot. The <code>getaudittraildata</code> API retrieves information about the audit data that is logged for all users.</p> <p>Bot Insight API</p>

Related concepts

[Migrate to Automation 360](#)

Related tasks

[Update to latest Automation 360 version](#)

If you are already using Automation 360 On-Premises, you can update to the latest version of Automation 360.

[Updating Automation 360 IQ Bot](#)

Update Automation 360 IQ Bot On-Premises to the most recent version for all the latest features and enhancements.

Enterprise A2019.11 Release Notes

Review the new features, supported packages, changed features, fixed features, and known limitations in the Enterprise A2019.11 (Build 3337) release. There are no security fixes in this release.

- [Enterprise A2019](#)
- [IQ Bot](#)
- [Bot Insight](#)

Enterprise A2019

Bot agent update: This release includes a required update to your . Ensure that you complete the update to continue with your automation activities when upgrading from a previous release to this release.

[Automatically update the Bot Agent](#) | [Manually update the Bot Agent](#)

To verify which version is compatible with this release, see [Compatibility with Automation 360 builds](#).

New features
<p>Migrate 11.x TaskBots and MetaBots to Enterprise A2019</p> <p>Enterprise A2019</p> <ul style="list-style-type: none"> Additional support is provided for packages and variables. <ul style="list-style-type: none"> Package mapping for migration Variable mapping for migration You can now migrate MetaBots (with DLLs) and their components from Enterprise 11 to Enterprise A2019. You cannot migrate screen-based MetaBots. <ul style="list-style-type: none"> How MetaBots are migrated Use the Bot Scanner to analyze MetaBots to determine if they can be migrated. Verify the list of certified Enterprise 11 bot versions available for migration: Supported Control Room versions for migration
<p>Bot Store integration with the Control Room</p> <p>Enterprise A2019</p> <p>You can now access the Bot Store from within the Control Room. You can install, configure, and run the Bot Store bots within the Control Room.</p> <p>As a registered user, you can log in to the Bot Store from the Control Room and access all your downloads. You can install bots and packages from your downloads to the Control Room private repository. You can also submit your existing bots and packages from the Control Room to the Bot Store.</p> <p>Bot Store</p>
<p>Use interactive forms in a bot</p> <p>Enterprise A2019</p> <p>Interactive forms provide a form builder experience for users to build interfaces for submitting and regrouping data being used to send and receive data from various applications within their attended automation process. Users with Bot Creator and Bot Runner license can use the interactive forms package to control and manage the form flow within a bot during runtime. Actions performed by users on the interactive forms can be monitored to execute logic using subtasks.</p> <p>Interactive forms are first-class citizens within the bot repository and have the same workflows for moving forms between public and private workspaces, and for export or import actions. No additional licenses or permission are required to use interactive forms.</p> <p>Action items in the interactive forms can be used to manage various forms within a bot.</p> <p>Using interactive forms</p>

New features

Reuse an identical value between bots by configuring a global value in the Control Room

Enterprise A2019 and Community Edition

A global value enables users to reuse an identical value between bots instead of creating a new variable for each bot. Global values remain constant for all users and bots in an Control Room instance. A user with the `AAE_admin` role can configure a global value with a default value and enable non-admin users to overwrite the value to use in their bots.

[Global values](#) | [Create a global value](#) | [Overwrite the default value](#)

Workload enhancements

Enterprise A2019 and Community Edition

- Monitor the progress of ongoing workload automations. You can also pause, resume, or stop the automations as required.
- Configure and edit workload automations to ensure that the automations are deployed seamlessly to unattended Bot Runner devices. Execute the workload automations with priority or round-robin mode from the **Devices > Edit Device pool** page.
- Set the output status of the work item processed in the Control Room on the **Queues and Work item** details page using the `$workItemResult$` variable in a TaskBot.
- Edit work items that are in **Ready to run, On hold, Data error, or Failed** state.
- Set the individual work item status to **Mark complete, Defer, or Re-process** from the **Edit work item** page or in bulk from the **View queues** page.

[View automation of a queue](#) | [Edit device pools](#) | [Edit work items](#) | [Use Work Item variables](#)

Download a file from the Control Room to your device

Enterprise A2019 and Community Edition

Use the **Download CR file** action from the File package to download a file from the Control Room to your device.

Note: You cannot use this action to download a bot or a file from the `My Scripts` folder.

[File package](#)

Clone a bot or files

Enterprise A2019 and Community Edition

Create a read-only copy of a selected bot or file from the public repository to the private repository. The clone is a local copy for the same user and will not be updated with the public repository copy automatically. This provides a testing environment experience for Bot Creators to make and validate changes locally and take advantage of reusable TaskBots in concurrent developments by reusing an existing bot or file as a dependency.

- Cloned bots and files cannot be edited, renamed, or moved.
- Cloned bots and files can be deleted from a private repository.
- Users can create a copy of the cloned bot.
- A cloned bot can be used in Run Task action in another bot.
- Cloned bots and files can be added as a manual dependency for another bot.

New features**New features in the If package**

Enterprise A2019 and Community Edition

- Configure an **If** action with multiple conditions.
Specify whether all or either of the conditions must be met.
- Verify whether JavaScript, Task, or VBScript ran successfully or not.
- Verify whether a string variable is empty or not.
- Execute actions only if two strings have matching uppercase and lowercase letters.

[If package](#) | [Example of using a conditional statement](#)

Universal Recorder enhancements

Enterprise A2019 and Community Edition

Universal Recorder now enables you to:

- Automate in Java applications that run using Java Runtime Environment (JRE) 9, 10, and 11.
- Capture objects in tables in Oracle EBS applications.
- Automate interactions with user interface objects in the taskbar, desktop, or currently active window. This option is available in the window selection drop-down list in the following packages:
 - Image Recognition
 - Mouse
 - Recorder
 - Screen
 - Simulate keystrokes
 - Window

[Universal Recorder for object-based automation](#)

New features in the Excel advanced package

Enterprise A2019 and Community Edition

- In the **Replace** action, you can choose to replace cell values with an empty character.
- In the **Get cell address** action, you can choose to save the retrieved cell address to a string variable.

[Using the Replace action](#) | [Using the Get cell address action](#)

Add DLL dependencies

Enterprise A2019 and Community Edition

As a bot creator, you can use a DLL that refers to a child DLL.

[Bot dependencies](#)

Licensing server failover

Enterprise A2019

HA failover from a primary cluster to a secondary cluster applies to all the servers, including the licensing server, and is handled by the data center high availability tools.

[Distributed architecture with HA/DR support](#)

New features
<p>Automate locking, logging off, restarting, or shutting down the computer</p> <p>Enterprise A2019 and Community Edition</p> <p>Use actions from the System package at the end of tasks to automate locking, logging off, restarting, or shutting down the computer.</p>
<p>Manage running bots with the Pause and Stop actions from the Task Bot package</p> <p>Enterprise A2019 and Community Edition</p> <ul style="list-style-type: none"> • Insert a Pause action to temporarily pause the running bot. • Insert a Stop action to terminate the running bot. <p>Task Bot package</p>
<p>Automate printer settings</p> <p>Enterprise A2019 and Community Edition</p> <p>Use actions from the Printer package to automate retrieving and setting the default printer.</p>
<p>Return the path and name of the currently running TaskBot using the system variable AATaskName</p> <p>Enterprise A2019 and Community Edition</p> <p>Predefined variables</p>
<p>Run JavaScript, Python, or VBScript from a file selected from your desktop</p> <p>Enterprise A2019 and Community Edition</p> <p>You can select the file containing the script as part of configuring the action.</p> <hr/> <p>Note: The file and any dependencies must be in a standalone folder. When you select a file for upload, all files and folders at the same folder level are uploaded.</p> <hr/> <p>JavaScript package Python Script package VBScript package</p>
<p>Device optimization for bot deployment (Zendesk ID: 238675)</p> <p>Enterprise A2019 and Community Edition</p> <p>Bot Runner devices that are used for Workload automation are now available for deployment in the Scheduled Automations page. This ensures that idle devices during a workload cycle are available to the user with scheduling rights for Control Room deployment.</p> <p>Edit device pools</p>

Supported packages

Package	Version
Node Manager	6.0.4015
Application	2.0.0-20200302-135910
Analyze	2.2.1-20200314-193039

Package	Version
Boolean	2.0.0-20200302-135912
Browser	2.0.0-20200302-135913
Clipboard	2.0.0-20200302-135922
Comment	2.0.0-20200302-135922
CSV/TXT	2.0.0-20200312-122802
Database	2.0.0-20200302-135926
Data Table	2.0.0-20200302-140308
Datetime	2.0.0-20200302-135930
Delay	2.1.0-20200302-135931
Dictionary	2.0.0-20200302-135932
Run DLL	2.0.0-20200313-170350
Email	2.0.0-20200302-135934
Error handler	2.0.0-20200302-135940
Excel basic	2.0.0-20200302-140133
Excel advanced	2.0.0-20200302-140020
File	2.0.0-20200316-045955
File & folders	2.0.0-20200317-030352
Folder	2.0.0-20200302-135945
FTP / SFTP	2.0.0-20200302-135948
IF/ELSE	2.0.0-20200302-135950
Image Recognition	2.0.0-20200302-135953
IQ Bot	2.0.0-20191031-150538
JavaScript	2.0.0-20200313-170107
Simulate keystrokes	2.0.0-20200313-170111
Legacy Automation	1.0.0-20200317-220124 1.0.0-20200317-220128
List	2.0.0-20200302-140013
Log To File	2.0.0-20200302-140014
Loop	2.0.0-20200302-140015
Message Box	2.0.0-20200302-140016
Migration	2.0.0-20200317-220133
Mouse	2.0.0-20200302-140016
Number	2.0.0-20200302-140023
OCR	2.1.0-20200302-140025

Package	Version
Office 365 Excel	2.0.0-20200309-140138
Office 365 Calendar	2.0.0-20200305-124125
Office 365 OneDrive	2.0.0-20200309-110128
PDF	2.1.0-20200302-140126
PGP	2.1.0-20200309-110135
Ping	2.0.0-20200302-140130
Printer	2.0.0-20200311-100204
Play Sound	2.0.0-20200309-110137
Prompt	2.0.0-20200302-140148
Python Script	2.0.0-20200313-170254
Recorder	2.0.0-20200318-020414
REST Web Service	2.0.0-20200312-090358
SAP	2.1.0-20200302-140250
Screen	2.0.0-20200302-140254
SNMP	2.0.0-20200302-140257
SOAP Web Service	2.0.0-20200312-110311
String	2.0.0-20200302-140306
System	2.0.0-20200309-140321
Task	2.0.0-20200317-030340
Terminal Emulator	2.0.0-20200302-140313
VBScript	2.0.0-20200313-170417
Wait	2.0.0-20200302-140319
Window	2.0.0-20200302-140348
XML	2.0.0-20200302-140321

Changed features

Change in the Dictionary > Remove action

The **Dictionary > Remove** action offers the option to assign the removed value to a variable.

[Dictionary package](#)

The **Update migration status** permission name has been changed to **Allow a bot-runner user to run migrations**. All functionalities remain the same.

Changed features
<p>When multiple bots are scheduled to run on the same user or device, the bots are now queued and run whenever the previous bots completes its run.</p> <p>Service Cloud case ID: 00440072</p> <p>Scheduled activities Workload management</p>

Fixed features

Service Cloud case ID	Description
00483976	When the copy function is used, nested subfolders were not visible when users clicked browse to search through directories. This issue has been fixed.
00457550	When a user checks out a bot that uses the Run action to run child bots, the child bots are now cloned from the public repository to the private.
00492706	When a user exports a bot from another Control Room and imports that same bot to a new Control Room, the imported bot and enabled packages now show all required actions.
00482934	Bot deployments and website launches are now optimized for quicker process.
00421864	When a user is viewing historical activity details in Historical activity , the run option is no longer displayed.
00505120	When bots fail the check-in process, the contents are now restored in the Private repository.
00488504	Bots with more than 100 dependencies are now exported successfully without an error, even if the parent bots are in the list of those 100 dependencies.
00444902	When the Control Room is used in Internet Explorer 11, the Bot Agent is now compatible and the UI is rendered properly.
00454079	When the Capture action in the Recorder package is used, content in the browser is captured successfully.
00460530	In a developer Control Room, a user can now successfully import a bot with cyclic dependency.
00493605	In the Run action in the TaskBot package, the Assign the output to variable (optional) option now functions properly when an assigned variable is removed.
00486734	When the Set cell action in the Excel advanced or Excel basic package is used with multiple Microsoft Excel files, the values of the Active cell operation now activate and set the cells accordingly in the respective Microsoft Excel file.
00530915	Migration is not advisable for Enterprise 11 customers using Workload Management due to known issues.

Service Cloud case ID	Description
--	You can now add date variables in the Vertical Bar Graph widget in the Bot Insight Business dashboard.
00475173	All fields of the Recorder > Capture action have been translated to Enterprise A2019 supported languages.
00476820	When a Bot Runner machine is logged off, the device shows the state as Disconnected in the Control Room. Previously, the device showed the state as Connected in the Control Room.

Known limitations
MetaBot logic that uses a DLL function call with one or more parameters migrates successfully. However, when you run the migrated bot, an error is shown.
Global values of the Date time data type cannot be used in actions.
The Enterprise A2019 On-Premises Control Room installation does not support the semicolon (;) special character in the Windows user password. The installation fails if you use this special character.
When data is exported into a CSV file from User Management, Audit Logs, and Roles Management for all locales except English, the respective language is not displayed correctly. Workaround: Export to a CSV file and access a Microsoft Excel file. Import and save that CSV file as a CSV with UTF-8 encoding.
Users must explicitly enable the feature flag for the forms feature in the On-Premises build.
Note: Go to Automation Anywhere support site for more information: Interactive forms not available in Automation 360 v.11 On-Premises (A-People login required)
Forms with many radio buttons and check boxes in the same row are not rendered correctly.
Only the Form Events and UI Triggers event types are supported by event loop as the file or folder triggers and hot keys have issues.

IQ Bot

The IQ Bot On-Premises version is available for this release with additional features or updates since the last release. This IQ Bot version supports all the features and functionality available in IQ Bot Version 6.5.2.

[IQ Bot feature comparison matrix](#)

Review the compatibility of the IQ Bot On-Premises version with the corresponding Automation Anywhere Control Room On-Premises version.

[Automation 360 IQ Bot version compatibility](#)

The IQ Bot Cloud version is available for this release and supports all features and functionality available in IQ Bot Version 6.5.2. This version provides users with automatic provisioning for up to three environments such as Development, Test, and Production. Users can migrate learning instances between environments using APIs.

The IQ Bot Community Edition and the free trial version are available for this release. Both versions have feature parity and are based on IQ Bot Version 6.5.2 .

New features
<p>Upgrade from earlier versions of IQ Bot to the latest IQ Bot On-Premises</p> <p>IQ Bot On-Premises</p> <p>If you are using any of the earlier versions of IQ Bot (5.3.x or 6.5.x), you can upgrade to IQ Bot A2019 Build 3337 On-Premises.</p> <p>Updating Automation 360 IQ Bot</p>
<p>Use API to migrate learning instances between environments</p> <p>You can use an API to migrate learning instances in IQ Bot On-Premises.</p>
<p>Access IQ Bot from the Control Room dashboard</p> <p>Enterprise A2019 and Community Edition</p> <p>You can access IQ Bot from the Control Room through a link, provided you have registered IQ Bot in the Control Room. Otherwise, the IQ Bot section remains hidden.</p>

Known limitations
<p>IQ Bot On-Premises</p> <p>IQ Bot installation fails if the user password contains any of these special characters: single quotation mark ('), quotation mark ("), or semicolon (;).</p>
<p>IQ Bot Cloud</p> <ul style="list-style-type: none"> • ABBYY FineReader Engine is the default OCR for data extraction in IQ Bot Cloud. • Data validation using Python script is not supported. • IQ Bot extensions for custom extraction are not available.
<p>IQ Bot On-Premises and IQ Bot Cloud</p> <p>When you upload vector PDF documents to a new learning instance, a few documents are identified as unclassified. Alternatively, if you convert the documents from PDF to TIFF and upload them, the documents are processed successfully.</p>

Bot Insight

New features
<p>View filtered data of Bot Insight dashboards</p> <p>Enterprise A2019</p> <p>The Bot Insight dashboard filter enables you to apply filters across dashboards to display filtered data on the dashboard widgets. The filter enables you to view different combinations of information from a single dashboard, thereby eliminating the need to maintain separate dashboards for different sets of users.</p> <p>Bot Insight dashboard filter</p>

New features**View business analytics for multiple transactions simultaneously**

Enterprise A2019

The **Multiple Transaction Names** menu displays transactional information about bots with multiple **Analyze- Open** and **Close** commands. Each **Analyze- Open** and **Close** command is considered as a transaction, and each transaction is displayed as a unique block in the data preview section. The number of rows for each unique transaction block is limited to 100.

[Business dashboard](#)

Enterprise A2019.10 Release Notes

Review the new features, supported packages, changed features, fixed features, and known limitations in Enterprise A2019.10 (Build 2545). There are no security fixes in this release.

- [Enterprise A2019](#)
- [IQ Bot](#)
- [Bot Insight](#)

Enterprise A2019

To verify which version is compatible with this release, see [Compatibility with Automation 360 builds](#).

New features**Migrate 11.3.x TaskBots to Enterprise A2019**

Enterprise A2019

- Analyze whether you can migrate bots created in Enterprise Client version 10.x using the Bot Scanner.

[Analyze Bot Scanner report for migration](#)

- Additional support is provided for packages and variables.

[Package mapping for migration](#) | [Variable mapping for migration](#)

- Multiple Bot Runner users are supported for bot migration.

[Migrate Enterprise bots](#)**AI Sense Recorder to capture objects from remote applications**

This is a **Beta** release on Enterprise A2019 (Cloud deployment only) and Community Edition

Record a task and capture objects using the AI Sense Recorder from applications that are usually accessed remotely and with a complex user interface (UI).

[Record a task with AI Sense Recorder](#)

New features
<p>Manage your automation as Work Items for resource optimization and workload automation</p> <p>Enterprise A2019 and Community Edition</p> <p>Divide your automation into small, logical modules called Work Items using the new Workload Management feature. Process these Work Items simultaneously using queues to ensure that your organization's automation goals are achieved with optimum resource utilization.</p> <p>Use the workload module to create and manage workload queues and run bots on unattended Bot Runners through the workload queues. Also, pass the Work Item attributes or values to the bot from the Control Room when you Run bot with queue with the help of Work Item variables.</p> <p>Workload management</p>
<p>Install Control Room on Red Hat Enterprise Linux 7.7 and Linux CentOS 7.7</p> <p>Enterprise A2019</p> <p>Use the command line to install your Control Room on your Linux servers in the datacenter.</p> <p>Installing Control Room on Linux</p>
<p>Use wildcard characters in folder and file path fields in the Encrypt and Decrypt actions</p> <p>Enterprise A2019 and Community Edition</p> <p>Substitute an asterisk (*) for one or more unknown alphanumeric characters or symbols. This maximizes the search results by returning all folders and files that contain the string that you have specified.</p> <p>Encrypt Decrypt</p>
<p>Use system variables to return data from the computer that is connected to the running Bot Agent</p> <p>Enterprise A2019 and Community Edition</p> <p>You can use the following system variables:</p> <ul style="list-style-type: none">• AAControlRoom: Returns the URL of the Control Room.• CPUUsage: Returns the percentage utilization of the CPU.• RAMUsage: Returns the RAM usage in megabytes.• OSName: Returns the operating system.• TotalRAM: Returns the total amount of RAM available.

New features
<p>Automate tasks in Oracle EBS and Forms with the Universal Recorder</p> <p>Enterprise A2019 and Community Edition</p> <p>Open Oracle EBS applications in a browser as Java Web Start applications or as a thick client. The Universal Recorder can capture the following objects:</p> <ul style="list-style-type: none"> • Window/Tab • Button • Text box • Label (read-only) • Radio button • Check box • Table/Grid • Scroll bar • Menu • Combo-box/Drop-down list

Supported packages

Package	Version
Node Manager	2.0.2885
Application	2.0.0-20200131-085947
Analyze	2.1.0-20200204-154550
Boolean	2.0.0-20200131-085949
Browser	2.0.0-20200127-180439
Clipboard	2.0.0-20200131-085958
Comment	2.0.0-20200130-183435
CSV/TXT	2.0.0-20200205-175938
Database	2.0.0-20200205-175940
Data Table	2.0.0-20200131-200235
Datetime	2.0.0-20200131-090006
Delay	2.1.0-20200131-090007
Dictionary	2.0.0-20200205-175946
Run DLL	2.0.0-20200205-230300
Email	2.0.0-20200206-135926
Error handler	2.0.0-20200130-183452
Excel basic	2.0.0-20200205-110122
Excel advanced	2.0.0-20200205-110012
File	2.0.0-20200131-090018

Package	Version
Folder	2.0.0-20200131-090021
FTP / SFTP	2.0.0-20200206-110020
IF/ELSE	2.0.0-20200131-090025
Image Recognition	2.0.0-20200131-090028
IQ Bot	2.0.0-20191031-150538
JavaScript	2.0.0-20200205-180013
Simulate keystrokes	2.0.0-20200205-105955
List	2.0.0-20200131-090039
Log To File	2.0.0-20200131-090040
Loop	2.0.0-20200131-090041
Message Box	2.0.0-20200131-090041
Migration	1.1.0-20200206-180601
Mouse	2.0.0-20200131-090044
Number	2.0.0-20200205-110015
OCR	2.1.0-20200131-090053
Office 365 Excel	2.0.0-20200205-180122
Office 365 Calendar	2.0.0-20200206-105949
Office 365 OneDrive	2.0.0-20200127
PDF	2.1.0-20200131-090152
PGP	2.1.0-20200205-110117
Ping	2.0.0-20200131-090156
Play Sound	2.0.0-20200127-180654
Prompt	2.0.0-20200127-180707
Python Script	2.0.0-20200205-180148
Recorder	2.0.0-20200212
REST Web Service	2.0.0-20200206-110309
SAP	2.1.0-20200205-180245
Screen	2.0.0-20200131-090311
SNMP	2.0.0-20200207-090446
SOAP Web Service	2.0.0-20200127-180819
String	2.0.0-20200131-090323
System	2.0.0-20200205-110240
Terminal Emulator	2.0.0-20200131-090330
VBScript	2.0.0-20200205-180309

Package	Version
Wait	2.0.0-20200131-090335
Window	2.0.0-20200131-090337
XML	2.0.0-20200131-090339

Changed features
<p>Updated layout for the summary report generated by Bot Scanner</p> <p>The layout of the summary report is updated to provide information about the number of bots scanned, and the commands and variables used in the scanned bots that are supported in Enterprise A2019.</p> <p>Analyze Bot Scanner report for migration</p>
<p>Python script and VBScript packages return output without quotation marks</p> <p>The actions in the Python script and VBScript packages now return output without any quotation marks. For example, if the action previously returned "ABC" as the output, now the action returns only ABC.</p>
<p>Use Microsoft SQL Server address as alias for database</p> <p>Service Cloud case ID: 00401484</p> <p>The Control Room now supports using a Microsoft SQL Server address as alias for a database during installation.</p> <p>Automation 360: Steps to change database server post Control Room installation (A-People login required)</p>

Fixed features

Service Cloud case ID	Description
00463210	In a virtual machine using Remote Desktop Protocol, the Keystrokes action now functions properly without prompting a special characters error.
00455359, 00466407, 00475122	When the Control Room is used in Google Chrome, renaming a folder in the My bots section no longer causes the browser to crash.
00440659	In the Data Table package, the Create folders/files if it doesn't exist option in the Write to file action now functions properly and does not create a file when the option is not selected.
00377861, 00466104	When you install Enterprise A2019 On-Premises with Amazon Relation Database Service (RDS) and there is no internet connectivity, the installation now completes successfully.
00472738, 00496476	In the Control Room, the bot now runs successfully without prompting an interactive bot error message in any circumstance.

Service Cloud case ID	Description
00472655	In the Loop action, selecting the Cell range in the Loop through option now functions properly with the For each row in worksheet in the Iterator option.
00475040	When a bot is developed in Google Chrome, the pause and resume options now function correctly.
00445671	The time taken to connect to the Control Room is now less than 2 minutes after you restart the Control Room services.
00421864	You can now configure your Bot Agent using the Google Chrome browser. The following error message is no longer displayed: <code>Please use Chrome to configure your bot agent.</code>
00462095	Bot compilation time has decreased, so it takes less time for the bot to run. Previously, some bots took up to 40 seconds in pre-processing mode.

IQ Bot

The IQ Bot On-Premises version is available for this release with additional features or updates since the last release. This IQ Bot version supports all the features and functionality available in IQ Bot Version 6.5.2.

[IQ Bot feature comparison matrix](#)

Review the compatibility of the IQ Bot A2019 On-Premises version with the corresponding Automation Anywhere Control Room On-Premises version.

[Automation 360 IQ Bot version compatibility](#)

New features
<p>IQ Bot On-Premises unified database</p> <p>IQ Bot Build 2545 On-Premises now supports a unified database. You have to run a migration script to migrate the databases of Builds 1089, 1598, and 2079 to Build 2545.</p> <p>Run IQ Bot On-Premises database migration script</p>

Note: The version number in the IQ Bot installer is incorrect and will be fixed in the next release.

Bot Insight A2019

New features
<p>New Bot Insight homepage</p> <p>The new homepage displays all the available dashboards in a single page and enables you to directly access the dashboard of your choice. The smart search functionality enables you to search for dashboards in the Search text field. The homepage also enables you to bookmark your favorite dashboards and to sort the dashboards based on the following parameters:</p> <ul style="list-style-type: none"> • Dashboard Name • Type • Total Views • Last Refreshed <p><i>Bot Insight dashboards</i></p>
<p>Operations dashboard</p> <p>View information about the bots that are deployed on different Bot Runner machines and their statistics based on the performance from the Bot Insight Operations dashboard. You can use this information to enhance productivity and take measures based on real-time information for RPA deployments.</p> <p>You can directly access the Bots and Audit dashboards from the hyperlinks in the Operations dashboard.</p> <p><i>Operations dashboard</i></p>
<p>Transaction data</p> <p>View data that is aggregated and logged by the bots when they are deployed in the Bot Runner machines by using the Transaction data feature in the Profile menu. You can access this feature from the Business dashboard.</p> <p><i>Business dashboard</i></p>
<p>Exporting data from widgets</p> <p>Export data that is generated by the various smart widgets to comma-separated value (CSV) files on your local drive from the Custom Business dashboard. The export file for all the widgets, except the Data Table Chart and the US Map, contains the following headers:</p> <ul style="list-style-type: none"> • Group • Subgroup • Metric • Volume <p>The Data Table Chart export file contains all the headers that are present in the Data Table Chart. The US Map export file contains the state codes, metric values, and the volume headers.</p> <p><i>Exporting data from a dashboard widget</i></p>

New features**Visualization updates**

Customize the widgets on the Bot Insight dashboards to gain insights for specific scenarios. The following widgets are added to Bot Insight:

- **Heat Map**
- **Data Table Chart**

[Bot Insight visualizations](#)

Known limitations

Using the Universal Recorder in Oracle EBS applications:

- The **Select item by text** action does not retrieve the value of a selected **ListView** object.

Workaround: Manually enter the item value after capturing the object control or use the **Select item by index** action.

Note: Item index count starts at 1.

- At runtime, the **Select item by text** and **Select item by index** actions do not appear to select the item specified in a **PageTab** object, but the bot successfully executes the action.
- At runtime, the **Select item by text** and **Select item by index** actions do not appear to select the item specified in a **ComboBox** object, but the bot successfully executes the action.

In Enterprise A2019 On-Premises, the following activities are currently not logged in the workload logs:

- Create a queue
- Create a device pool
- Create a bot
- Run a bot with a queue

You can access the logs from the `C:\ProgramData\AutomationAnywhere\Logs` folder.

Related information

<https://www.automationanywhere.com/in/lp/rpa-editions-comparison>

Enterprise A2019 (Build 2094) Release Notes

These release notes describe new features, changed features, fixed features, security fixes, deprecated features, and known limitations in Enterprise A2019 (Build 2094).

To verify which version is compatible with this release, see [Compatibility with Automation 360 builds](#).

Enterprise A2019 Build 2094

Build 2094 contains updates for the following:

- [Enterprise Community Edition](#)
- [Bot Insight A2019](#)
- [IQ Bot A2019](#)

- *On-Premises* (Build 2079)

New features in Build 2094

Feature	Description
Migration	<p>Migrate Enterprise 11.3.x TaskBots to Enterprise A2019.</p> <ul style="list-style-type: none"> • Run the Bot Scanner (previously called the pre-migration utility) to analyze if your Enterprise 11.x bot (currently only 11.3.1, 11.3.2, and 11.3.2.x versions are supported) can be migrated to Enterprise A2019. The utility generates a summary report in HTML format and a separate report for each bot in XML format. <ul style="list-style-type: none"> Bot Scanner overview • Migrate multiple TaskBots with dependent TaskBots using a single Run-as user. <ul style="list-style-type: none"> Migrate Enterprise bots • As part of the bot migration process, you can identify previously migrated TaskBots on the bot selection page and preview a list of the dependent TaskBots before finalizing the migration. <ul style="list-style-type: none"> Migrate Enterprise bots • Analyze the status of individual bot migrations and identify any unsupported commands or attributes associated with the migrated bot and its dependencies. <ul style="list-style-type: none"> View migration reports • Additional support is provided for packages and variables. <ul style="list-style-type: none"> Package mapping for migration
SAML 2.0	<p>Switch an authenticated environment Control Room database to a SAML identity provider (IDP).</p> <p>Set up SAML authentication</p>

Feature	Description
Bot Deploy API	<p>The Bot Deploy API now includes / <code>automations/deploy</code> and is introduced to support the <code>runAs user</code> feature for Bot deployment.</p> <ul style="list-style-type: none"> The Bot Deploy API works only in Enterprise public accounts, and not in Community Edition. The API supports callback URL for environments that have both the Control Room and callback server on the same network.
Geo Presence	The Geo Presence feature is a multi-tenant, secure, scalable, Cloud Control Room enhancement to securely communicate with users and Bot Runners over a customer network.
Exchange Web Services support	<p>Actions in the Email package enable users to automate email-related operations using Exchange Web Services (EWS).</p> <p><i>Email package</i></p>
Variables in place of an index or key value	<p>Data table, dictionary, list, and record type variables can express index and key values as variables.</p> <p><i>Variable types</i></p>
Copy bot	<p>The copy bot functionality retains the metadata of the original bot, including captured images, recorded objects, called files, and child bots.</p> <p><i>Copy a bot</i></p>
Excel actions to retrieve cell, column, or row location	<p>The following actions enable users to retrieve location information from an Excel sheet and save it to a variable.</p> <ul style="list-style-type: none"> <i>Get cell address</i> <i>Get column</i> <i>Get row</i>
Recorder enhancements	Users can discard the most recently captured object while the Recorder is running.

Supported packages

Package	Version
Node Manager	1.0.1891
Application	2.0.0-20191223-210256

Package	Version
Boolean	2.0.0-20191223-210258
Browser	2.0.0-20191223-210259
Clipboard	2.0.0-20191223-210308
Comment	2.0.0-20191223-210309
CSV/TXT	2.0.0-20191223-210310
Database	2.0.0-20191223-210312
DataTable	2.0.0-20191223-210802
DateTime	2.0.0-20191223-210316
Delay	2.1.0-20191223-210318
Dictionary	2.0.0-20191223-210318
DLL	2.0.0-20191223-210742
Email	2.0.0-20200114-060001
Error Handler	2.0.0-20191223-210326
Excel	2.0.0-20200107-140225
Excel_MS	2.0.0-20200107-140116
File	2.0.0-20200114-060009
Folder	2.0.0-20200114-060012
FTP/SFTP	2.0.0-20191223-210334
If/Else	2.0.0-20191223-210336
IR	2.0.0-20191223-210339
IQ Bot	2.0.0-20191031-150538
JavaScript	2.0.0-20191223-210345
Keystrokes	2.0.0-20191223-210348
List	2.0.0-20191223-210350
LogToFile	2.0.0-20191223-210350
Loop	2.0.0-20191223-210352
MessageBox	2.0.0-20191223-210352
Migration	1.1.0-20200111-070201
Mouse	2.0.0-20191223-210355
Number	2.0.0-20191223-210402
OCR	2.1.0-20191223-210525
Office 365 Excel	2.0.0-20191231-170605
Office 365 Calendar	2.0.0-20191231-170422
Office 365 OneDrive	2.0.0-20191231-170612

Package	Version
PDF	2.1.0-20191223-210631
PGP	2.1.0-20191223-190649
Ping	2.0.0-20191223-210634
PlaySound	2.0.0-20191223-210636
Prompt	2.0.0-20191231-130717
Python	2.0.0-20191223-210644
Recorder	2.0.1-20200111-070529
Rest	2.0.0-20191231-120639
SAP	2.1.0-20191223-210745
Screen	2.0.0-20191223-210748
SNMP	2.0.0-20191223-210752
SOAP	2.0.0-20191210-081952
String	2.0.0-20200114-110316
System	2.0.0-20191223-210800
Terminal Emulator	2.0.0-20191223-210806
VBScript	2.0.0-20191223-210809
Wait	2.0.0-20191223-210812
Window	2.0.0-20191223-210814
XML	2.0.0-20191223-210815

Changed features

Feature	Description
Office 365 packages authorization	<p>Authorize each Office 365 package separately through the Connect package in each package.</p> <p><i>Using Connect action for Office 365 packages</i></p>

Fixed features

Feature	Description
Bot Agent	<p>In the Control Room, upgrading to the latest Bot Agent version now successfully executes the bot without any prompted error messages. See <i>Switch Bot Agent to a different Control Room.</i></p>

Feature	Description
Excel advanced package	In the Excel advanced package, the Close action now terminates only a specific open session as defined by the session name .
Keystrokes	The Keystrokes command now functions properly with the Japanese keyboard layout.

Security fixes

The security fixes in this release have not changed since the previous release. For a list of these fixes, see [Enterprise A2019 \(Builds 1598 and 1610\) Release Notes](#).

Deprecated features

The deprecated features in this release have not changed since the previous release. For a list of these deprecations, see [Enterprise A2019 \(Builds 1598 and 1610\) Release Notes](#).

Known limitations in Build 2094

Migration

- When selecting a bot for migration, values for the **Last Migrated** and **Migrated By** columns might differ for the same bot in the **Available Files** and **Selected** tables.
- The "System" value in the **Migrated By** column indicates that the bot has not been migrated previously.
- When viewing commands and variables associated with each migrated bot, you should only see the unsupported commands and variables. Currently, all commands and variables are shown.

IQ Bot Build 2079

IQ Bot On-Premises version is available for this release with no additional features or updates since the last release. This version is based on IQ Bot Version 6.5.2 feature and functionality.

[IQ Bot feature comparison matrix](#)

IQ Bot On-Premises version is compatible with the corresponding Automation Anywhere Control Room On-Premises version.

[Automation 360 IQ Bot version compatibility](#)

For a fresh Control Room installation, the user has to upload the IQ Bot package manually. See [Add packages to the Control Room](#) for details.

Go to Automation Anywhere support site to download the package:

[A-People Downloads page \(Login required\)](#).

IQ Bot fixed features

The fixed features in this release have not changed since the previous release.

IQ Bot security fixes

The security fixes in this release have not changed since the previous release.

IQ Bot deprecated features

The deprecated features in this release have not changed since the previous release.

IQ Bot known limitations

There are no new known limitations in this release.

Bot Insight new features in Build 2094

Feature	Description
Visualizations	<p>The Visualization widget in the Bot Insight dashboard provides a host of highly customizable widgets that you can use to gain insights on specific scenarios. Vertical and horizontal Clustered and Stacked bars are added.</p> <p><i>Adding a dashboard widget</i></p>

Bot Insight changed features

The changed features in this release have not changed since the previous release.

Bot Insight fixed features

The fixed features in this release have not changed since the previous release.

Bot Insight deprecated features

The deprecated features in this release have not changed since the previous release.

Bot Insight known limitations

The known limitations in this release have not changed since the previous release.

Enterprise A2019 (Builds 1598 and 1610) Release Notes

These release notes describe new features, changed features, fixed features, security fixes, deprecated features, and known limitations in Enterprise A2019 (Builds 1598 and 1610).

To verify which version is compatible with this release, see [Compatibility with Automation 360 builds](#).

Enterprise A2019 Builds 1598 and 1610

Build 1598 contains updates for the following:

- [Enterprise Community Edition](#)
- [Bot Insight](#)
- [IQ Bot](#)

Build 1610 contains updates for the following:

- [On-Premises](#)
- [Bot Insight](#)
- [IQ Bot](#)

New features in Builds 1598 and 1610

Feature	Description
Pre-migration utility for On-Premises	<p>The Automation Anywhere pre-migration utility evaluates your 11.x bots for migration to Enterprise A2019.</p> <p>Run the pre-migration utility to verify whether your existing 11.x bots can be migrated to Enterprise A2019. Use the summary report generated by the utility to identify the bots that can and cannot be migrated and decide if you want to start the migration.</p> <hr/> <p>Note: This is an initial version of the pre-migration utility. We plan to include updates to the utility in upcoming releases to help migrate most of your bots.</p>
On-Premises Windows installer	Enterprise A2019 On-Premises Windows installer is certified for Azure.
Bot Creator and Bot Runner on Azure Cloud	Users can create and execute bots for devices on Azure Cloud.
Action localization	Labels, buttons, and tooltips are localized to the supported language set.
Updated action packages	<ul style="list-style-type: none"> • Additional REST Web Service error codes for better troubleshooting of API calls • PGP package for encrypting and decrypting files • Improvements to SAP actions
Control Room to a SAML-based, SSO-authenticated Control Room	Enterprise A2019 integrates with SAML identity providers (IDPs). Post installation, administrators can switch the Control Room to a SAML-based, SSO-authenticated Control Room.
Move email messages to different folder	The Move message command enables the user to move all the filter-matched emails to a different folder.

Supported packages

Package	Version
Node Manager	1.0.2110
Application	2.0.0-20191128-060339
Boolean	2.0.0-20191128-060340
Browser	2.0.0-20191128-060342
Clipboard	2.0.0-20191128-060350
Comment	2.0.0-20191128-060351
CSV/TXT	2.0.0-20191128-060352
Database	2.0.0-20191128-060354
DataTable	2.0.0-20191128-060707
DateTime	2.0.0-20191128-060358
Delay	2.1.0-20191128-060359
Dictionary	2.0.0-20191128-060400
DLL	2.0.0-20191128-060648
Email	2.0.0-20191205-100336
Error Handler	2.0.0-20191128-060404
Excel	2.0.0-20191128-060547
Excel_MS	2.0.0-20191128-060434
File	2.0.0-20191128-060407
Folder	2.0.0-20191128-060409
FTP/SFTP	2.0.0-20191128-060412
If/Else	2.0.0-20191128-060414
IR	2.0.0-20191121-100240
IQ Bot	2.0.0-20191031-150538
JavaScript	2.0.0-20191128-060423
Keystrokes	2.0.0-20191128-060426
List	2.0.0-20191128-060427
LogToFile	2.0.0-20191128-060428
Loop	2.0.0-20191128-060429
MessageBox	2.0.0-20191128-060429
Mouse	2.0.0-20191128-060430
Number	2.0.0-20191128-060437
OCR	2.1.0-20191121-100301
PDF	2.1.0-20191128-060540

Package	Version
PGP	2.1.0-20191129-100500
Ping	2.0.0-20191128-060544
PlaySound	2.0.0-20191128-060545
Prompt	2.0.0-20191128-150505
Python	2.0.0-20191128-060553
Recorder	1.0.45-20190904-210340
Rest	2.0.0-20191128-060646
SAP	2.1.0-20191128.003143-259
Screen	2.0.0-20191121-100518
SNMP	2.0.0-20191128-060656
String	2.0.0-20191128-060704
System	2.0.0-20191128-150557
Terminal Emulator	2.0.0-20191128-060711
VBScript	2.0.0-20191121-110553
Wait	2.0.0-20191128-060716
Window	2.0.0-20191128-060718
XML	2.0.0-20191017-030831

Fixed features

The fixed features in this release have not changed since the previous release. For a list of these features, see [Enterprise A2019 \(Builds 1082 and 1089\) Release Notes](#).

Security fixes

The security fixes in this release have not changed since the previous release. For a list of these fixes, see [Enterprise A2019 \(Builds 1082 and 1089\) Release Notes](#).

Deprecated features

The deprecated features in this release have not changed since the previous release. For a list of these deprecations, see [Enterprise A2019 \(Builds 1082 and 1089\) Release Notes](#).

Known limitations in Builds 1598 and 1610

- IQ Bot is not supported in Automation Anywhere Cloud and users cannot register any IQ Bot instance with the Cloud Control Room.
- If a bot is deployed on a device, no other bots can be deployed on that device until the first bot has completed the deployed task.

- When deploying a bot using Unattended Bot Runner on a virtual machine with Windows 10 desktop, users have to enable remote access to the device (**Control Panel > System Properties > Allow Remote Access**).
- Deploying a bot with Bot Runner on a locked device will leave that device in an unlocked state.
- A Bot Creator is not able to view devices as assigned by the Control Room administrator. With this release, changes to the basic role has removed the **View and manage all devices** permission so that unless this permission is expressly granted by the Control Room administrator, the Bot Creator will no longer be able to see other devices in the Control Room. Bot Creators can register their devices directly; however, they will not be able to see the other devices in the Control Room.
- Unable to deploy bots from a private workspace using the wizard. Bot Creators can deploy bots from the editor.
- If users have set up Active Directory for Control Room authentication, changing to SAML or Control Room Database is not supported.
- Device pool administrators can delete a device pool after automation is scheduled and assigned to the pool.
- Users without SMTP can still import bots and packages.
- When users delete a bot from the Public workspace, the same bot is deleted from the Private workspace as well.
- Elastic Search Disaster Recovery backup is not supported.
- Using the Run Task action with the child task using triggers is not supported.
- User cannot export a bot with dependencies if that user does not have access to any of the related dependencies.
- Users cannot check out bots if they are linked through circular dependencies.
- Minimizing the window for some Microsoft Active Accessibility apps, such as Notepad, Calculator, or Remote Desktop Applications, can cause the operation to fail.
- UI Automation, such as Snagit Editor Window for example, will not work in the background unless expressly minimized.
- UI Triggers are not generating events with Snagit Editor or Inflow app.
- Applications such as calculator use different technologies on Windows 10 vs. Windows 2012 or other servers. In these cases, when a bot is created in one server configuration, the bot cannot be carried to another server. User triggers in these cases will not trigger bot deployment and there are no errors in the trigger listener or node manager logs.
- UI Triggers that are configured with multiple triggers are taking as much as 25 seconds to complete.
- UI Triggers with a single capture and a filter do not work with files larger than 2 MB.
- Button events where a user is switched from one window to a new window of an application fail to deploy a bot when listening for UI Triggers.
- For Automation Anywhere Elastic Search Service users, the `C:\ProgramData\AutomationAnywhere` folder has to be removed before installing Enterprise A2019.
- Users cannot enable SMTP with TLS for the On-Premises version of the Control Room (On-Premises only).
- User credentials are not editable (On-Premises only).
- Even when a newly added device is registered correctly, the indication icon does not turn green.
- **Activity - In Progress** table is not cleaning event records until the user performs a hard refresh (F5) of the browser.
- Domains are not shown for the **Device/Run as** tab when creating a role. This option is also missing when running a bot.
- Node manager is not able to establish a handshake SSL connection to the Control Room running on SSL certificate (On-Premises only).
- Repository Management API is incomplete; there is only one URL in the Swagger file.
- Device pools display completed automations, not scheduled automations.
- If a user is not the device pool administrator, the devices are not correctly displayed when editing a device pool.

- For an Unattended Bot Runner, with a device assigned and auto-login credentials set, and **Run as self** selected, the **Run now** option is disabled.
- When a user is running a bot from the Run Wizard and the Bot Agent requires an update, after the user has updated the agent from the pop-up box, the user cannot deploy the bot until the user navigates back to the previous page and returns to the workflow to run the wizard.
- Folder triggers do not deploy bots when a folder change event occurs.

IQ Bot Builds 1598 and 1610

IQ Bot On-Premises version is available for this release with no additional features or updates since the last release.

IQ Bot changed features

IQ Bot is compatible with A2019 Builds 1598 and 1610.

IQ Bot fixed features

The fixed features in this release have not changed since the previous release.

IQ Bot security fixes

The security fixes in this release have not changed since the previous release.

IQ Bot deprecated features

The deprecated features in this release have not changed since the previous release.

IQ Bot known limitations

There are no new known limitations in this release.

Bot Insight new features in Builds 1598 and 1610

Feature	Description
Operation dashboard	<p>The Operation dashboard in Bot Insight displays the Audit dashboard.</p> <p>You can search for the dashboards using the Search text box. You can also customize the dashboards based on your requirements. Role-based access control and permissions are applied to the dashboards so that the dashboard shows data only a specific user is authorized to view.</p> <p>See Operations dashboard .</p>

Feature	Description
Analytic visualization widgets	<p>The following new widgets are added:</p> <ul style="list-style-type: none"> • Stacked Bar Chart • Clustered Bar Chart <p>See Adding a dashboard widget.</p>

Bot Insight changed features

The changed features in this release have not changed since the previous release.

Bot Insight fixed features

The fixed features in this release have not changed since the previous release.

Bot Insight deprecated features

The deprecated features in this release have not changed since the previous release.

Bot Insight known limitations

The deprecated features in this release have not changed since the previous release.

Enterprise A2019 (Builds 1082 and 1089) Release Notes

These release notes describe new features, changed features, fixed features, security fixes, deprecated features, and known limitations in Enterprise A2019.

To verify which version is compatible with this release, see [Compatibility with Automation 360 builds](#).

Enterprise A2019 Builds 1082 and 1089

Build 1082 contains updates for the following:

- [Enterprise Community Edition](#)
- [Bot Insight](#)

Build 1089 contains updates for the following:

- [On-Premises](#)
- [IQ Bot](#)
- [Bot Insight](#)

New features in Builds 1082 and 1089

Feature	Description
Universal recorder support for SAP	The universal recorder now supports the SAP graphical interface for fast and accurate control and ease of editing generated scripts.
Citrix support	Citrix agent enables remote application recording for object cloning on Citrix servers and leverages ICA to create user sessions.
Enhanced code editing	Select multiple lines of code in editor to copy, move, disable, enable, as well as disable/enable a line of an action in a bot script. Users can run bots from a particular line of code or action inside the bot.
Bot import and export	Users can export bots with dependencies into a common zip file, including all actions. Users can manually exclude packages from the export process. All imported action packages will be automatically installed into the target Cloud Control Room and the bots placed inside the user private workspace.
Background processing	Background processing for Citrix Virtual Apps and Windows native applications. Excel packages inherently support background processes.
REST package	Support for GET, POST (text, XML, and HTML), PUT, and DELETE methods. Authentication types supported include Basic, Logged-in AD user, and NTLM.
OCR Action	Users can capture window and capture image by path.
Active Directory integration for On-Premises	Allowing auto-discovery of sites and domains, Enterprise A2019 On-Premises integrates Active Directory to support multi-domain as well as multi-forest deployments.

Supported packages

Package	Version
Node Manager	1.0.1745
Application	2.0.0-20191016.213334-22
Boolean	2.0.0-20191017-030403
Browser	2.0.0-20191017-030404
Clipboard	2.0.0-20191016.213334-16
Comment	2.0.0-20191017-030408
CSV/TXT	2.0.0-20191017-030409

Package	Version
Database	2.0.0-20191017-030411
DataTable	2.0.0-20191029.062940-3
DateTime	2.0.0-20191017-030416
Delay	2.1.0-20191017-030417
Dictionary	2.0.0-20191017-140648
DLL	2.0.0-20191031-100332
Email	2.0.0-20191024-120209
Error Handler	2.0.0-20191031-100110
Excel	2.0.0-20191024-160417
Excel_MS	2.0.0-20191101-120011
File	2.0.0-20191017-140654
Folder	2.0.0-20191017-140657
FTP/SFTP	2.0.0-20191023-181858
If/Else	2.0.0-20191017-030432
IR	1.0.0-20190923-115359
IQ Bot	2.0.0-20191031-150538
JavaScript	2.0.0-20191031-100128
Keystrokes	2.0.0-20191018-100419
List	2.0.0-20191017-030447
LogToFile	2.0.0-20191017-030447
Loop	2.0.0-20191017-030449
MessageBox	2.0.0-20191017-030449
Mouse	2.0.0-20191017-030450
Number	2.0.0-20191029-100152
OCR	2.1.0-20191017-030626
PDF	2.1.0-20191017-030713
Ping	2.0.0-20191017-030715
PlaySound	2.0.0-20191024-160415
Prompt	2.0.0-20191024-160423
Python	2.0.0-20191031-100238
Recorder	1.0.45-20190904-210340
Rest	2.0.0-20191024-090501
SAP	2.1.0-20191031-100334
Screen	2.0.0-20191017-030809

Package	Version
SNMP	2.0.0-20191023-181621
String	2.0.0-20191025-221016
Terminal Emulator	2.0.0-20191023-181907
VBScript	2.0.0-20191031-100352
Wait	2.0.0-20191017-030828
Window	2.0.0-20191017-030829
XML	2.0.0-20191017-030831

Changed features

Changed features	
TaskBot	All rich features of MetaBot, such as DLL and code protection using execute permission, are now part of a standard TaskBot. This also includes inline scripting using Python, VBScripts, and more to help reduce the learning curve for new users and provides a uniform bot development experience.

Fixed features

The fixed features in this release have not changed since the previous release. For a list of these features, see [Enterprise A2019 \(Build 550\) Release Notes](#).

Security fixes

The security fixes in this release have not changed since the previous release. For a list of these fixes, see [Enterprise A2019 \(Build 550\) Release Notes](#).

Deprecated features

The deprecated features in this release have not changed since the previous release. For a list of these deprecations, see [Enterprise A2019 \(Build 550\) Release Notes](#).

Known limitations in Builds 1082 and 1089

- IQ Bot is not supported in Automation Anywhere Cloud and users cannot register any IQ Bot instance with Cloud Control Room.
- To create database tables in Cloud Control Room where internet access is restricted and deploying Liquibase, users are required to unblock the Java process to connect to www.liquibase.org in order to download the schema and allow java.exe to have internet access.

- The Folder trigger has the following event options: **create**, **modify**, and **delete**. The File trigger only has the **modify** and **delete** event options.
- A bot cannot have duplicate Triggers that point to the same directory.
- Using the action Run Task with the child task using triggers is not supported.
- Activity - In Progress is not cleaning the event record until user does hard refresh (F5) of the browser.
- User cannot export a bot with dependencies if that user does not have access to any of the related dependencies.
- Users cannot checkout bots if they are linked via circular dependencies.
- Minimizing the window for some Microsoft Active Accessibility apps, such as Notepad, Calculator, or Remote Desktop Applications, can cause the operation to fail.
- UI Automation, such as Snagit Editor Window for example, will not work in the background unless expressly minimized.
- If the system Citrix plugin is not updated, the Recorder will not launch.
- If the user renames a previously saved recorder bot, a download error is generated and results in loss of images.
- For Elasticsearch users, remove the `C:\ProgramData\AutomationAnywhere` folder prior to installing Enterprise A2019.
- Users cannot enable SMTP with TLS for the on-premises version of the Control Room (On-Premises only).
- User credentials are not editable (On-Premises only).
- Installer fails to create credentials using Windows Authentication. Use SQL Authentication service credentials (On-Premises only).
- In an On-Premises environment, creating credentials with the Credential Vault is not supported in this release.
- When using the Recorder with Citrix in an On-Premises deployment, the Citrix Agent could generate an internal server error during the recording process.

IQ Bot Builds 1082 and 1089

IQ Bot Community Edition is available for this release. IQ Bot is not yet available on Automation Anywhere Cloud.

See [IQ Bot Community Edition quick start guide](#) .

IQ Bot changed features

IQ Bot is compatible with Enterprise A2019 Build 1089.

IQ Bot fixed features

The fixed features in this release have not changed since the previous release.

IQ Bot security fixes

The security fixes in this release have not changed since the previous release.

IQ Bot deprecated features

The deprecated features in this release have not changed since the previous release.

IQ Bot known limitations

For On-Premises, if IQ Bot and Control Room are installed on the same machine, on restarting the machine, IQ Bot does not work, and displays an error message.

Note: We recommend restarting Automation Anywhere Control Room Reverse Proxy service to resolve the issue.

Bot Insight new features in Builds 1082 and 1089

Feature	Description
Smart data profiling for country, state, and zip codes	Bot Insight analyzes information provided in the variables to automatically identify information based on the country, state, and zip or postal code. You can use this information to create the World and US Map widgets. See Editing a data profile .
Business data delete API	Use this API to delete logged data from either the production mode or the development mode for a particular Control Room instance. See Delete task log data .
Business data profile API	Use this API to extract the business data profile logged in Bot Insight. See Get bot variables data .
Business data API	Use this API to extract the business data logged in Bot Insight. See Get task log data .
Resize dashboard widgets	You can resize and save the widgets in the Bot Insight dashboard based on your requirements. When you resize a dashboard widget, other widgets in the dashboard are automatically adjusted to fill in the available layout. See Editing a dashboard widget .
US map widget	The US Map widget enables you to visualize and analyze information about Country, State, City, and Zip Code. See Adding a dashboard widget .

Feature	Description
World map widget	The World Map widget enables you to visualize and analyze information about Country, State, Zip Code, Latitude, and Longitude. See Adding a dashboard widget .
Parent child dashboard	When you create a new bot, Bot Insight automatically creates a default dashboard. If you have a parent bot and a child bot, Bot Insight creates a separate dashboard for each of the bots. See Bot Insight dashboards .
Notification of variable updates in the standard dashboard	Data profile updates are highlighted with a red dot in the standard dashboard. See Customizing a dashboard .
Data logging	When you deploy and run a bot on the Bot Runner machine, Bot Insight aggregates all the information about that bot. The published dashboard for that bot displays the aggregated bot information. See Bot Insight dashboards .
Bot Insight	The Analyze package provides the following functions to enable business analytics in the Bot Insight dashboard: <ul style="list-style-type: none"> • Analyze Open • Analyze Close

Bot Insight changed features

The changed features in this release have not changed since the previous release.

Bot Insight fixed features

The fixed features in this release have not changed since the previous release.

Bot Insight deprecated features

The deprecated features in this release have not changed since the previous release.

Bot Insight known limitations

The known limitations in this release have not changed since the previous release.

Enterprise A2019 (Build 550) Release Notes

These release notes describe new features, changed features, fixed features, security fixes, deprecated features, and known limitations in Enterprise A2019 (Build 550).

New features in A2019 Build 550

Feature	Description
On-premises installer	The on-premises installation application for Enterprise A2019.
IQ Bot supports IE11	IQ Bot (Build 550) supports Internet Explorer version 11 (IE11).
Download all documents action	Use the Download all documents action to download the extracted results from an IQ Bot server that was created by running a TaskBot, using the Upload Document action.

Supported packages in Build 550

The supported packages in this release have not changed since the previous release. For a list of these packages, see [Enterprise A2019 \(Build 543\) Release Notes](#).

Changed features

IQ Bot (Build 550) Changed Features	
Issue	Description
Language toggle UI redesigned	<p>On the IQ Bot landing page, user can click the language toggle at the top right corner, to select a language from the drop-down list. The UI displays in the selected language.</p> <p>User can select a language from either the Control Room or IQ Bot language toggle icon.</p> <hr/> <p>Note: After logging out of the system, the system performs a reset. This requires the user to select the language again at login.</p> <hr/>
Upload document action	The Upload document action lets you to upload documents for processing with IQ Bot, using a TaskBot.

Fixed features

IQ Bot (Build 550) fixed features:

- Japanese documents using Microsoft Azure Computer Vision OCR engine get classified correctly.
- In the Designer window, during document training, user is able to move from one page to the other successfully along with mapping of form and table fields.
- Download API can download successfully processed documents after moving the bot and learning instance to production.

Security fixes

No security features are introduced in this build.

Deprecated features

No deprecated features are introduced in this build.

Known limitations

IQ Bot (Build 550) known limitations:

- When using Internet Explorer (IE) 11, icons disappear after a page refresh. A hard refresh (Ctrl plus F5) helps fix the issue.
- When using Internet Explorer (IE) 11, if user imports a domain, the system shows an error message. However, the feature works as expected.
- User is unable to migrate IQBA files from other versions of IQ Bot.
- IQ Bot portal does not launch after a machine restart. User has to restart Automation Anywhere Control Room Reverse Proxy Service as well.

Enterprise A2019 (Build 543) Release Notes

These release notes describe new features, changed features, fixed features, security fixes, deprecated features, and known limitations in Enterprise A2019 (Build 543).

To verify which version is compatible with this release, see [Compatibility with Automation 360 builds](#).

New features in A2019 Build 543

Feature	Description
Next generation bot workbench	<p>Create bots from any device, from anywhere through a web browser. The intuitive new design for applying multiple personas with varying bot building skills and a redesigned work area for simple assembly and deployment. These include:</p> <ul style="list-style-type: none"> • A universal recorder to simplify capturing processes • List and Flow views for TaskBot creation • Powerful bot code management capabilities • Rich variable passing with no cross-language mapping required

Feature	Description
Bot Runner	Access and run bots from the cloud. When bots are deployed to Bot Runners, any dependent actions are also deployed. When updates to Actions are available, the updates are also automatically pushed.
Package manager	The package manager centralizes control over bundled actions to enable users to deploy and upgrade only those targeted actions being used.
Advanced variable types	Access expanded variables and array types for enhanced action implementation, including DateTime, numbers, list, Boolean, dictionary, multi-dimension arrays for reading Microsoft Excel documents, and file data column for .CSV files.
Inline scripting	Native support for Python and VBScript inline scripting languages enables simple data passing between scripts and bots.
New UX	The new user experience provides assistance for users who are getting started and includes step-by-step guidance for common tasks.
Excel automation	Configure Microsoft Excel TaskBot automation without installing Microsoft Office on the Bot Runner machine.
Recording of automation	Record automation, even from a remote device.
IQ Bot	Enterprise A2019 will fully support IQ Bot, the only AI-driven solution for users to automate processing of complex documents.
Bot Insight	The Analyze package provides the following functions to enable business analytics in the Bot Insight dashboard: <ul style="list-style-type: none"> • Analyze Open • Analyze Close

Table 1: Supported packages in Build 543

Package	Version
Node Manager	1.0.1221
Application	1.0.0-20190919.040305-1231
Boolean	1.0.0-20190919.040305-1435
Browser	1.0.0-20190919.040305-1287
Clipboard	1.1.0-20190919.040305-1492
Comment	1.0.0-20190919.040305-633
CSV/TXT	1.2.0-20190919.040305-1349
Database	1.1.0-20190919.040305-1287
DateTime	1.0.0-20190919.040305-1189

Package	Version
Delay	1.1.0-20190919.040305-1492
Dictionary	1.0.0-20190919.040305-1337
DLL	1.0.0-20190920.070246-677
Email	1.0.0-20190919.040305
Error Handler	1.0.0-20190919.040305-1333
Excel	1.1.0-20190921.042722-1353
Excel_MS	1.0.0-20190921.042722-1309
File	1.0.0-20190919.040305-1382
Folder	1.0.0-20190919.040305-1337
FTP/SFTP	1.0.0-20190919.040305-660
If/Else	1.0.0-20190919.040305-1375
IR	1.0.0-20190923.062209-1140
IQ Bot	2.0.0-20191031-150538
JavaScript	1.0.1-20190919.040305-989
Keystroke	1.1.0-20190919.040305-1492
List	1.0.0-20190919.040305-1466
Log to File	1.1.0-20190919.040305-1456
Loop	1.0.0-20190919.040305-1466
Message Box	1.1.0-20190919.040305-1492
Mouse	1.1.0-20190919.040305-1492
Number	1.0.0-20190919.040305-1148
PDF	1.1.0-20190919.040305-1492
Ping	1.0.0-20190919.040305-1319
PlaySound	1.0.0-20190919.054049-118
Prompt	1.1.0-20190919.040305-1180
Python	1.0.3-20190919.040305-1287
Recorder	1.0.45-20190904.153347-191
RunTask	1.1.0-20190701.181500-763
SAP	1.1.0-20190923.152217-493
Screen	1.0.0-20190919.040305-1105
SNMP	1.0.0-20190919.040305-359
Step	1.0.0-20190701.181442-695
String	1.1.0-20190919.040305-1469
Table	1.0.0-20190919.040305-719

Package	Version
VBScript	1.0.1-20190919.040305-1334
Wait	1.0.0-20190919.040305-1287
Window	1.0.0-20190919.040305-1333
XML	1.0.0-20190919.040305-717

Changed features

This build does not include any changed features.

Fixed features

No fixed features are introduced in this build.

Security fixes

No security fixes are introduced in this build.

Deprecated features

No deprecated features are introduced in this build.

Known limitations

Feature	Limitation description
Recorder	.NET Framework 4.6.1 is required for the Recorder package.
Bot agent	Users of build 543 are required to download and install the latest agent.
Bot Insight	<p>Bot Insight has the following limitations:</p> <ul style="list-style-type: none"> • Bot Insight dashboard does not support Drag and Drop to move and arrange the dashboard widgets within the dashboard. • The Date widget in the dashboard displays the Unix time stamp. • Bot Insight does not support the Aggregate By feature in the Table widget, if the table contains a Timestamp. • Once the bots run successfully, the default dashboard is generated after 5 to 10 seconds.

Community Edition Release Notes

Review the new capabilities in different Automation 360 Community Edition releases.

Important: Enterprise A2019 is now called Automation 360. Although the release notes for releases earlier than Automation 360 v.21 reference the old product name, the content in these releases notes is applicable and relevant to Automation 360.

Note: For information about Automation 360 v.24R2 patch for Community Edition, see [Automation 360 v.24R2 Release Notes for Internet Explorer 11 EOL](#).

Follow the links to view the release note updates for the respective release.

Related concepts

[Automation 360 Release Notes](#)

Review the new capabilities, changes, fixes (resolved issues), security fixes, deprecated features, and limitations in each release.

Related reference

[Automation 360 Sandbox Release Notes](#)

Automation 360 v.27 Community Edition Release Notes

Release date: 15 December 2022

Review what's new in the Community Edition of the Automation 360 v.27 (Build 16603) release.

Bot agent update: This release includes an **optional** Bot Agent update. You can continue to run your existing bots without updating the Bot Agent. However, if you want to use the new features in Automation 360 v.27, you must update the Bot Agent available with this release.

For more information on updating to this release, see these resources:

- [Automatically update the Bot Agent](#) | [Manually update the Bot Agent](#)
 - [Compatibility with Automation 360 builds](#)
-

RPA Workspace

What's new
<p>Windows 365 Cloud PC now supported as Bot Runner (Service Cloud case ID: 01792699)</p> <p>We support Windows 365 Cloud PC as a Bot Runner to create and run bots on Windows 365 Cloud PC.</p> <p>Automation 360 Bot Runner device requirements</p>
<p>View keyboard shortcuts in Bot editor</p> <p>In Bot editor, you can now open a menu to view the available keyboard shortcuts.</p> <p>Keyboard shortcuts</p>

What's new
<p>Enhanced Automation Anywhere Debugger tool</p> <p>The Automation Anywhere Debugger tool is available in the Bot Assistant utility to provide a better user experience. When you invoke the Debugger tool from the Bot editor, you can add, update, or delete actions and variables in a bot.</p> <p>By default, the Watched variables lists is empty. With a single click, you can add all the used variables in a bot. These variables display in a pop-up window where you can select or deselect, one or more variables, from the list.</p> <p>Debugger features</p>
<p>ServiceNow package</p> <p>You can use the ServiceNow package from Automation 360 to authenticate and perform several actions with records and attachments in ServiceNow tables.</p> <p>ServiceNow package</p>
<p>ServiceNow triggers</p> <p>You can use ServiceNow triggers to call an action when there is a new or updated record.</p> <p>ServiceNow New Record trigger</p>
<p>Quick assistance at hand for the developers in the Bot editor</p> <p>The accessibility and usability of the Bot editor, actions, and packages have been improved. As a citizen developer or an RPA developer, when you are creating bots, you can quickly look up information about the actions without navigating outside the Bot editor. Under the Actions pane, quick help is enabled with contextual information about actions. Additionally, an icon is configured with a link to the documentation. If you want more information about an action, you can click the link, which redirects you to the relevant page in the documentation portal. This feature is currently available in the following actions and packages.</p> <ul style="list-style-type: none"> • Database • Email
<p>Enhanced user experience through refreshed and intuitive icons</p> <p>With the new and intuitive icons for actions in the Bot editor, citizen developers and RPA developers can quickly locate the correct action while creating automation for a day-to-day task. These unique and renewed icons are developed according to brand and global standards.</p>
<p>New option in Read from action of Database package (Service Cloud case ID: 01263940)</p> <p>A new check box is available when you use the Read from action to retrieve records from the database and save the retrieved data in a CSV file. When you select this check box, no CSV file is created if the executed SQL query does not return any data.</p>
<p>64-bit ODBC driver now supported in Database package (Service Cloud case ID: 01256142, 01829360, 01849908)</p> <p>We now support connecting to databases by using the 64-bit ODBC driver. This option is available when the connection mode is the default. Organizations transitioning to Office 365 will benefit from leveraging this enhancement and can sustain automation build with 32-bit ODBC drivers.</p> <p>Using Connect action for database</p>

What's new

OAuth 2.0 support in Email and Email trigger packages (Service Cloud case ID: 01798311, 01803702, 01791859, 01828526)

Microsoft is deprecating the ability to use Basic authentication in Exchange Online for these specific protocols:

- IMAP
- POP3
- EWS

We support OAuth 2.0 authentication for these protocols in the Email and Email trigger packages. For enhanced security, you can maintain the business continuity of your email automations by switching the authentication type from Basic to OAuth 2.0, (as recommended by Microsoft).

[Using Connect action for Email](#)

Retry mechanism supported in credential variables (Service Cloud case ID: 01786319, 01887182)

The credential variables support the retry mechanism. When you create a bot that uses credential variables, if the bot fails during run time to retrieve those variables from the Credential Vault because the Control Room is disconnected or the Control Room services stop intermittently, then the bot tries three times to retrieve the credential variables from the Credential Vault.

Note: Ensure that the Bot Agent version installed on your system is the version that is released with Automation 360 v.27.

What's new**Support of other domain name in the Active Directory package** (Service Cloud case ID: 01807358, 01910765)

We now support Active Directory user operations by logon name with domain and can provide the domain name to extract user details. When you retrieve the user property or perform any user operation based on the logon name (userPrincipalName), and if the user domain name differs from the domain specified in the LDAP path, the user properties are now successfully retrieved with or without a domain name.

For example, LDAP Path: LDAP://ADServer/DC=automation, DC=net

User	Logon name
userPrincipalName: kim@aaengg.net	User can provide logon name as kim@aaengg.net.
userPrincipalName: shaun@aasales.net	User can provide logon name as shaun@aasales.net.
userPrincipalName:sarah@automation.net	user can provide a logon name as either sarah or sarah@automation.net.

The following list of actions supports logon name with domain.

- Update user details
- Rename user
- Delete user
- Enable user account
- Disable user account
- Set user property
- Get user property

[User account operations](#)

New action in Text file package

You can use the new **Read variables** action in the Text file package to read the values of variables from the text file.

Note: The **Import string from text file** action in the String package has been deprecated.

[Read variables action](#)

Call an existing JavaScript function in a webpage

You can use the new **Call a JavaScript function** action in the Browser package to call an existing JavaScript function directly in a webpage or in an iFrame within a webpage in Google Chrome and Chromium-based Microsoft Edge browsers. In the bot, you can also pass one or more input parameters to the JavaScript function and process the return value from the function.

[Call a JavaScript function action](#)

What's new
<p>Automate controls using Microsoft UI Automation (COM) technology</p> <p>You can use the Microsoft UI Automation (COM) technology to automate the following scenarios:</p> <ul style="list-style-type: none"> • Capture and automate client controls • Capture and automate password text controls • Capture and automate page tab controls <p>Actions performed on objects captured with Universal Recorder Capture using specific technology</p>
<p>Capture objects on applications running in administrator mode</p> <p>You can use the Recorder to capture objects on applications running in administrator mode. To capture the object, select the Capture and run with admin privileges option from the Bot editor.</p> <p>Recorder package</p>
<p>Enhanced bot performance when using global values across bots</p> <p>When you use global values across a parent bot and a child bot, the bot performance is enhanced by reducing the bot execution time. To enable enhanced bot performance, you must set the Bot compatibility version to 3 in the Advanced settings page of the Bot editor.</p> <hr/> <p>Note: Ensure that the Bot Agent version installed on your system is the version that is released with Automation 360 v.27.</p> <hr/> <p>Bot compatibility version</p>
<p>Enhanced user interface for Define functionality in AISense Recorder</p> <ul style="list-style-type: none"> • We have enhanced the user interface of Define window in the AISense Recorder that enables you to use anchors easily and automate UI objects that are not detected by AISense Recorder automatically. To improve functional clarity, the following object types are renamed: <ul style="list-style-type: none"> • Active text is renamed to Link • Passive text is renamed to Text value • If you unintentionally click the screen or click before the highlighter appears, the AISense Recorder provides visibility into it. You must confirm to capture the object again or use the Define functionality to define the object on the screen. • In the Define window, the AISense Recorder shows embedded help for each of the control types so you can select the correct control types for custom objects. <p>Use variable anchor Capture Textbox, Radio, Checkbox, and Combobox Capture text value through AISense Recorder Capture link button through AISense Recorder Capture Image button through AISense Recorder</p>
<p>New virtual key added to the Simulate keystrokes package</p> <p>In the Simulate Keystrokes > Keystrokes action, a new key named Return has been added to the virtual keyboard for Enter functionality and the Enter key in the Number pad has been renamed to Num Enter. As a result, the Return key is the main Enter key on the keyboard. This enhancement keeps the keyboard in sync with the physical keyboard. The nomenclature has been changed to avoid confusion between the Enter key on the keyboard and the Enter key on the Number pad.</p>

What's new
<p>Support for global variable for all Datetime actions</p> <p>In the Datetime package, you can use the Datetime global variable across all Datetime actions. You can select to use either String variable or a Global variable in the Source date and time variable option. This avoids creating multiple local variables and reduces the total number of actions used in a bot.</p> <p>Datetime package</p>
<p>Workato Integration</p> <p>You can integrate the Automation 360 platform and Workato by using the Automation Anywhere connector. You can establish a connection with the Automation Anywhere Control Room and perform various operations using the Control Room APIs.</p> <p>Workato integration</p>
<p>SnapLogic Integration</p> <p>You can now integrate the Automation 360 platform and SnapLogic. You can establish a connection with the Automation Anywhere Control Room and perform various operations by using the Control Room APIs.</p> <p>SnapLogic integration</p>

Automation Anywhere Robotic Interface (AARI)

What's new
<p>Build forms easily by dragging elements to form builder</p> <p>You can now build your forms by just dragging your elements to a blank form builder. As you add elements to the form builder, it automatically adjusts without your input, letting you focus on the form-building experience. You can also re-size the columns of your elements.</p> <p>Create a form</p>
<p>New actions in the Process Composer</p> <p>In the Process Composer, you can now use a set of actions when you build out your process. For example, you can double-click a task, such as Bot Task and Human Task, and the task will be updated in your process flow automatically. With this, you can save time because you do not need to task specific tasks to your process. In addition, you can now copy, cut, and paste using CTRL + C, CTRL + X and CTRL + V, respectively to retain, reuse, or replace data.</p> <p>Behaviors supported in the Process Composer Create an AARI process</p>
<p>Use a reference ID meta type in Process Composer</p> <p>You can now use a reference ID with a Meta variable type for your variables in the Process Composer. When you set a reference ID as a meta variable type, you can now use your reference ID data when you run your tasks in the web interface. This simplifies your references because you only need to rely on using the reference ID instead of relying on other variable types or references.</p> <p>Create an AARI process</p>

What's new
<p>Center your forms in preview</p> <p>You can now preview your forms in the new preview window and get an accurate assessment on how your form will look when it is rendered. You can select the Make form preview centered option to enable the preview window. You can also set the appropriate display resolution, x and y coordinates, and even center your form.</p> <p>Create a form</p>
<p>Upload images directly to the form composer</p> <p>You can now upload images directly to the form composer by using the Image element. This saves you time to view the images in the form without a file reference, rather than in the initial step, where the image requires a file reference to be viewed.</p> <p>Using the Image element</p>
<p>Change label action for Button element</p> <p>The change label action in the form rules now applies to the Button element. When you use the change label action in form rules and apply it to the buttons in your form, the changes will be automatically applied to the buttons where you set the rules. This keeps the flow consistent with the elements that you are using because all the buttons inherit the same rule.</p> <p>Add rules to form elements</p>
<p>Rules editor for Table element</p> <p>The rules editor is now applicable to the Table element. When you use the rules editor for your tables, the rules conditions are applied for each individual columns while any actions that you set are applied for each row in the row level. This makes things consistent for each new or existing row that you use because all the rows inherit the same rule.</p> <p>Add rules to form elements</p>

Document Automation

What's new
<p>Document Automation supports regular expression pattern-based extraction</p> <p>When configuring fields that the learning instance will extract, you can specify a regular expression (regex) pattern to help the extraction engine find the field. After entering the regex pattern you can test the expression using sample content within the Create Learning instance window. You can use regex pattern extraction for values that follow a specific pattern, such as a VAT number or a PO number.</p>
<p>Validation interface support for shortcut keys</p> <p>Zoom in and out on documents in the Validation interface by holding the Alt key and scrolling with your mouse wheel.</p>

Automation 360 v.26 Community Edition Release Notes

Release date: 22 September 2022

Review what's new in the Community Edition of the Automation 360 v.26 (Build 15450) release.

Note: The v.26 build supports Manifest V3 browser extensions for Google Chrome and Microsoft Edge browsers. For more information, see [Chrome and Edge Manifest V3 extensions](#).

Bot agent update: This release includes an **optional** Bot Agent update. You can continue to run your existing bots without updating the Bot Agent. However, if you want to use the new features in Automation 360 v.26, you must update the Bot Agent available with this release.

For more information on updating to this release, see these resources:

- [Automatically update the Bot Agent | Manually update the Bot Agent](#)
- [Compatibility with Automation 360 builds](#)

RPA Workspace

What's new
<p>Community Edition users provisioned to closest region</p> <p>Registered Community Edition users are now provisioned to a region that is closest to their country (either in the US or EU). Provisioning is based on the country of the users account.</p>
<p>Support for Manifest V3 extensions</p> <p>Automations that use Google Chrome Manifest V2 based extensions will stop working sometime after June 2023. The deprecation timelines of Manifest V2 based extensions are currently under review and subject to change by Google.</p> <ul style="list-style-type: none"> • For Google Chrome Manifest V2 extensions timelines, see Manifest V2 support timeline. • For Microsoft Edge Manifest V2 extensions timelines, see Overview and timelines for migrating to Manifest V3. <p>This might impact your existing automations that use Manifest V2 based extensions for Google Chrome and Microsoft Edge browsers. Automation 360 v.26 and later includes Manifest V3 extensions by default to support features that use Google Chrome and Microsoft Edge browsers.</p> <p>You can automatically enable Manifest V3 based extensions for Google Chrome and Microsoft Edge on all the Bot Runner devices by enabling the Browser extensions option from the Control Room. Enabling this option applies the browser extension settings on all the registered Bot Agent devices.</p> <p>Note: We will continue to support Manifest V2 based extensions for Google Chrome until June 2023. To know about Microsoft Edge Manifest V2 based extensions timelines, see Overview and timelines for migrating to Manifest V3.</p> <p>Note: Manifest V3 extension is supported on Google Chrome and Microsoft Edge browsers version 91 and later only.</p> <p>Customize browser extension settings Chrome and Edge Manifest V3 extensions</p>

<p>What's new</p>
<p>Microsoft Windows 11 Enterprise now supported (Service Cloud case ID: 01252605, 1252605, 1253745, 01255134, 01379865, 01801610, 01810148)</p> <p>We now support Microsoft Windows 11 Enterprise, so you can now install and update the Bot Agent and run bots on the Windows 11 Enterprise operating system.</p> <p>Bot Agent compatibility</p>
<p>Salesforce command package</p> <p>You can now authenticate from Automation 360 to access Salesforce and run several command actions by using the new Salesforce command package.</p> <p>Salesforce package</p>
<p>SAP GUI 770 version now supported (Service Cloud case ID: 01793132, 01792775, 1776805, 01792623, 787725, 01805482, 01805479, 01792623, 01810356, 01822839, 01851451, 01853577, 01860050)</p> <p>SAP GUI 770 (patch 6) is now certified and supported with Recorder and SAP package.</p> <p>Recorder actions supported in various SAP versions</p>
<p>Configure and use custom proxy configuration in REST Web Service package (Service Cloud case ID: 01271527, 01765084, 01839282)</p> <p>REST Web Service package is now enhanced to support custom proxy configuration for each Delete, Get, Patch, Post, and Put action. This provides you more flexibility in calling REST APIs with different proxy configuration and allow you to create hybrid API automation.</p> <p>REST Web Service package</p>
<p>Keyboard shortcuts to reduce scrolling</p> <p>When developing large bots, you can now use keyboard shortcuts to expand and collapse individual or all sections and move through the lines of code quickly instead of scrolling and minimizing sections individually.</p> <p>Keyboard shortcuts to expand or collapse elements in bot logic</p>
<p>Set value in any editable control field to be blank in SAP application (Service Cloud case ID: 00821861, 01807129)</p> <p>When you use the Set text action of the SAP package, you can now set the value in any editable control field in the SAP application to be blank. For example, you can set the value in the text field or the date field to be blank.</p>
<p>Loop through emails and move them one at a time (Service Cloud case ID: 00749763, 01807189, 01840743)</p> <p>You can now loop through all the emails in a mailbox and move one email at a time to a destination folder by using the Move action in the Email package.</p> <p>Move action</p>
<p>Configure p12 certificate for SOAP-based automations (Service Cloud case ID: 00757213)</p> <p>In the SOAP Web Service action, you can now select the p12 certificate file and provide a password for user authentication. With this enhancement, you can now access web services that use the p12 certificate-based authentication (a more secure type of SSL certificate).</p> <p>Example of using the SOAP web service action</p>

What's new
<p>Improved accessibility, usability of content on Terminal Emulator window (Service Cloud case ID: 01609467)</p> <p>You can now have improved accessibility and usability of the content displayed on the Terminal Emulator window. When you use the enhanced Get text action of the Terminal Emulator package, you can now view and extract all the lines and text present in the Terminal Emulator window and perform an operation based on your requirement.</p> <p><i>Using Get text action for Terminal Emulator</i></p>
<p>Run bots with or without window title matching in letter case</p> <p>You can now run bots even when the title of a captured window does not match the letter case. For a bot to identify a static window or browser titles and titles with a wildcard character, you can opt for a case-sensitive match if you want the letter case to be matched, or a case-insensitive match otherwise, by using the Case sensitive option.</p>
<p>Control image preview and storage in Control Room during secure recording</p> <p>You can now choose whether or not the object images are available for preview and stored in the Control Room during secure recording by enabling the Recorder preview image setting. When you enable the setting, the image is previewed in the Bot editor and stored in the Control Room for 60 minutes. If you choose not to preview, images are not captured.</p> <p><i>Secure recording Secure recording mode Settings</i></p>
<p>Automate Microsoft Excel spreadsheets from SharePoint</p> <p>You can now automate Microsoft Excel spreadsheets that are uploaded and shared on SharePoint. Use Excel advanced > Open action to open the Microsoft Excel spreadsheets from SharePoint location.</p> <p><i>Using the Open action for Excel advanced</i></p>
<p>Automate Citrix Virtual Apps in Edge with IE mode</p> <p>When using the Recorder, you can now automate Citrix Virtual Apps running on Microsoft Edge Chromium with IE mode.</p>
<p>Automate controls using Microsoft UI Automation (COM) technology</p> <p>For automation, you can now use the Microsoft UI Automation (COM) technology in the following scenarios:</p> <ul style="list-style-type: none">• Capturing controls with secure recording mode• Capturing and automating combo box and list view controls• Using Object exists and Object does not exist Recorder conditions in If, Loop, and Wait packages <p><i>Capture using specific technology Actions performed on objects captured with Universal Recorder</i></p>

What's new**Seamless automation of Citrix Virtual Apps and other Citrix applications**

With the new Automation 360 remote agent for Citrix, you can now seamlessly automate all types of Citrix Virtual Apps and other Citrix applications that are supported on desktop applications using the Recorder.

The new Automation 360 remote agent for Citrix supports the following browsers and technologies:

- Google Chrome
- Internet Explorer
- Microsoft Edge
- Microsoft Edge with IE mode
- Mozilla Firefox
- Java
- Electron apps
- Microsoft Active Accessibility (MSAA)
- Microsoft UI automation

[Installing Automation Anywhere remote agent on Citrix servers](#) | [Using the Recorder on Citrix Virtual Apps servers](#)

Implement coding standards with code analysis

You can now implement best coding practices by configuring coding rules in the Control Room. This feature helps you prevent potential errors, improve bot reliability, and makes the code more uniform, accessible, reliable, and efficient.

- As an administrator or a user with **View policies** and **Manage policies** permission, you can configure the code analysis policy for all users.
- As a Citizen Developer, you can run code analysis to analyze your bots against readability, maintenance, security, and compliance best practices.

[Code analysis](#)

Fetch execution details for specific execution IDs with new Control Room API

You can now fetch the execution details, such as `botOutVariables` and `CallbackInfo`, for a specific execution ID by using the new API endpoint, `v3/activity/execution/<id>` API.

Automation Anywhere Robotic Interface (AARI)

What's new
<p>Embedded automation with OAuth 2.0</p> <p>Embedded automation streamlines access to the automation experience.</p> <p><i>Embedded Automation</i></p> <ul style="list-style-type: none"> • AARI Integrations embeds in web applications as a widget, so if you are an end user, you can access automated processes and bots without leaving your environment. • AARI Extensions offers further adaptability through Chrome browser extensions, enabling automation directly in any web scenario. Business users can now access automations through a widget, available through an extension in their web browser. • With an OAuth 2.0 connection, existing access to automations in the Control Room are now shared with the Extensions to offer you a seamless user experience. <p><i>AARI Integrations and AARI Extensions</i></p>
<p>Delete files permanently from AARI cloud storage</p> <p>You can now delete files permanently from AARI cloud storage. When you delete a request, the associated file is also permanently deleted now and not just sent to the recycle bin.</p> <p><i>Cloud storage usage</i></p>
<p>Append or overwrite operations in your form</p> <p>Append or overwrite operations in your form by using the Assign form rules for the web, with the Checkbox and Radio Button elements, which now support form rules.</p>
<p>Assign dynamic values with support for new elements in your forms</p> <p>When you use the interactive forms package, you can now assign dynamic values with the Assign action, which now supports Checkbox and Radio Button elements in your form.</p> <p>You can also change the label of the selected form elements with the Change label action for the Button element.</p> <p><i>Interactive forms package</i></p>

IQ Bot

What's new
<p>Search for form or table fields</p> <p>When creating a learning instance, when you are configuring fields, you can now search for fields by field name, field label, or data type.</p>

Automation 360 v.25 Community Edition Release Notes

Release date: 21 June 2022

Review what's new in the Community Edition of the Automation 360 v.25 (Build 14304) release.

Bot agent update: This release includes an **optional** Bot Agent update. You can continue to run your existing bots without updating the Bot Agent. However, if you want to use the new features in Automation 360 v.25, you must update the Bot Agent available with this release.

For more information on updating to this release, see these resources:

- [Automatically update the Bot Agent](#) | [Manually update the Bot Agent](#)
- [Compatibility with Automation 360 builds](#)

RPA Workspace

What's new
<p>Support to automate applications supported on Citrix Workspace app (Service Cloud case ID: 01758063)</p> <p>The Citrix Workspace app is now supported on Automation 360. You can now automate applications that are accessed through the Citrix Workspace app by using the Recorder > Capture action or the Start recording option.</p>
<p>Install Bot Agent on devices that have Enterprise 11 Enterprise Client</p> <p>When you are creating a bot in Automation 360, you can now install the Bot Agent on a device with an existing Enterprise 11 Enterprise Client. You can create or run bots from both the Control Room instances.</p> <p>Install Bot Agent and register device</p>
<p>IE 11 EOL notification banner displayed in Control Room</p> <p>Starting from the Automation 360 v.25 release, if you use the Microsoft Internet Explorer browser to access the Control Room, you will be prompted to use an alternative supported browser, such as Google Chrome or Microsoft Edge (Chromium). When you log in to the Control Room, a notification banner is displayed indicating that support for Internet Explorer 11 is ending.</p> <p>Log in to Automation Anywhere Control Room</p>
<p>AI Sense Recorder: Support for Korean language and complex table operations</p> <ul style="list-style-type: none"> • You can now use AI Sense Recorder to automate applications that use Korean and a combination of Korean and English interfaces. <p>AI Sense for recording tasks from remote applications</p> <ul style="list-style-type: none"> • With AI Sense Recorder, you can now extract tabular data from complex tables. You can capture and automate tables with wider columns and tables that have columns with controls such as check boxes and options. You can also capture specific columns from tables. <hr/> <p>Note: If the table is not detected automatically, use the Define option to detect the table.</p> <hr/> <p>Table data extraction through AI Sense Recorder</p>

What's new
<p>Enhancements to Recorder</p> <ul style="list-style-type: none"> When you run a bot, you can now automate objects that appear behind the bot runtime window by using the Recorder > Capture action. (Service Cloud Case ID: 00684306, 00770636, 01146672) You can now use the Recorder to capture and automate objects with a specific technology. The Capture object tab now has the option to select a specific technology and capture using that technology. You can capture objects with the following technologies: <ul style="list-style-type: none"> Microsoft Active Accessibility (MSAA) UI automation Microsoft (MS) COM UI Automation <p><i>Capture using specific technology</i></p> <p>(Service Cloud Case ID: 01760871, 01865823)</p> <ul style="list-style-type: none"> You can now use the Recorder to automate third-party plug-in window objects on Google Chrome or Microsoft Edge browsers by using a specific technology.
<p>Reduce Data Loss option in PDF package</p> <p>In the PDF > Extract text action, for the Structured text type field, a new Reduce Data Loss option is now available. When you use this option, you can extract the complete text with minimal overlap of characters.</p> <p><i>Using Extract text action from PDF</i></p>
<p>Enhancement to the String package (Service Cloud case ID: 00770822)</p> <p>In the String > Extract text action, a new When extracting option is now available. You can use this option to specify whether the case of the text in the extracted substring must match that in the source string.</p> <p><i>Using Extract text action of String package</i></p>
<p>Download files from URLs that require NTLM authentication (Service Cloud case ID: 01189873)</p> <p>With the enhanced Browser package, you can now download files from URLs that require NTLM authentication by using the Browser > Download file action.</p>
<p>Enhancement to multiple attachments option in Send email action (Service Cloud case ID: 00800976, 00817136, 00821405, 00936080, 01256523, 01256320, 01262069, 01259369, 00936080, 01801928)</p> <p>When you send email from bots, you can now send multiple attachments as a list of files or a variable that contains the list of file objects. With this feature, you can attach files such as data files, spreadsheets, and word processor documents to your email. You can attach multiple filepaths from a local drive or a network drive, or you can use a variable that contains a filepath.</p> <p><i>Using the Send action</i></p>
<p>Enhancement to SOAP Web Service package</p> <p>When you build a SOAP response for an Xpath expression in the SOAP Web Service package, the result of the Xpath expression can be stored as a list of strings.</p> <p><i>Example of using the SOAP web service action</i></p>

What's new
<p>View version history of non-bot file dependencies (Service Cloud case ID: 01615105)</p> <p>You can now view the version history of your non-bot file dependencies. This helps to identify relevant changes made to your file by other users during a specific date and time along with the check-in messages.</p> <p>View version history of non-bot file dependencies</p>
<p>Edit non-empty folder names in private workspace (Service Cloud case ID: 00535388, 00730075, 00786633, 00791528, 01615295, 01820406)</p> <p>You can now edit your non-empty folder names in the private workspace. With this feature, you can now manage folders more easily. Ensure the following when you rename a folder:</p> <ul style="list-style-type: none"> • It does not contain checked-out or cloned bots even at subfolder levels. • It does not contain more than 100 items including subfolders and files. <p>Create and rename folders</p>
<p>View dependency maps for bots</p> <p>You can now view the dependency map for your bot in both the public and private workspaces. The dependency map shows the immediate parent and child bots for any selected bot. If you are an RPA developer, you can use the dependency map to better understand where a bot is invoked and which child bots are invoked by the bot. With this information, you can gauge the impact of the change in a bot, use the bot effectively, maintain better bot code and reusability, and prevent conflicts.</p> <p>View bot dependency map</p>

Automation Anywhere Robotic Interface (AARI)

What's new
<p>Create request in new tab</p> <p>You can now open and run your new requests in a separate tab when you select the Open request in New Tab option in the initial form. With this option, you can create requests concurrently without changing your current page navigation.</p> <p>Create a request and complete a task</p>
<p>Duplicate rows for Table element</p> <p>In the web interface, when you are adding rows to your form by using the Table element, you can now save time by duplicating a row in the table with the new Duplicate row option. The duplicated row will now be placed under the highlighted row that you had selected.</p>

What's new**Interface triggers support more technologies**

You can now use interface triggers with the following technologies:

- Windows native
- SAP Desktop
- Google Chrome and Edge Chromium browsers

[Add an interface trigger](#)

Enhancements to form rules

- **Use custom formatting**

When you are adding a rule, if you use the **If** menu to set the rule conditions on certain elements such as **Text Box** or **Text Area**, you can now select **Is** from the drop-down menu to enable additional options. Select the **Custom** option and click **Add regular expression** to apply custom formatting requirements on the selected element.

Consider a scenario where the user IDs of all your employees have AV as prefix. For example, for an employee whose name is Adam, the user ID is AVAdam. Use the **Add regular expression** option to set the value in the **Regular expression** field as ^AV. If a user enters Adam in the user ID field, an alert is displayed.

- **Set custom value or append element value**

When you are adding a rule, use the **Then** menu to select a form element. For this form element, you can set one of the corresponding actions using **Set Value** or **Append value**:

- **Value:** Data entered in the **Enter value** field is applied to the selected element.
- **Form element:** Data from the form element selected in the **Select element** drop-down menu is appended.

Consider a scenario where a user registration form has 'First name' and 'Employee ID' fields. You can set one of the following rules for the value in the Employee ID field:

- Select **Value** and enter *Emp1013* as preset value.

This value is displayed in the 'Employee ID' field when the bot runs.

- Select **Form element** and set 'First name' element in the **Select element** drop-down menu.

The value from the 'First name' field is appended to the 'Employee ID' field when the bot runs.

You can use elements in the same way that variables are used in the Bot editor. You can enter **\$** to view a list of elements.

[Add rules to form elements](#)

Document Automation

IQ Bot Extraction360 (Preview) is now Document Automation. Community Edition enables users to try features from Document Automation, including creating up to five learning instances, connecting to learning instances in Automation 360 IQ Bot, uploading documents for processing, and validating documents using AARI task manager.

Community Edition

What's changed
The Document Workspace folder now holds learning instance assets (bots, process, and form). Previously, these assets were located in the IQ Bot Processes folder.
The actions which support document processing are now located in the Document Extraction package. Previously, these actions were located in the IQ Bot Extraction360 (Preview) package.
Learning instances from prior releases have been deleted to enable the upgrade to Build 14304.

Limitations
Document Automation supports a device username of 21 characters or fewer.
The value beside the Validate documents link, which indicates the number of documents awaiting validation for a learning instance, sometimes does not appear.
When you are validating a document, if you draw a box, zoom in, and then click Fit to screen , the box appears at a different location from where you clicked.
If you connect to a learning instance from Automation 360 IQ Bot with an optional field that has a set default value and some fields that are unmapped, when you process documents in that learning instance in Document Automation, the default value appears in the unmapped fields.
When a bot runs an action from the Document Extraction package, the Activity > In progress page shows the item name as <code>IQBotAutoExtract</code> .
Although the Learning instances page states that users can not delete learning instances, a user can delete a learning instance by mousing over the actions menu to the right of the learning instance and clicking the Delete icon.

Automation 360 v.24 Community Edition Release Notes

Release date: 22 March 2022

Review what's new in the Community Edition of the Automation 360 v.24 (Build 12350) release.

Note: For information about Automation 360 v.24R2 patch for Community Edition, see [Automation 360 v.24R2 Release Notes for Internet Explorer 11 EOL](#).

RPA Workspace

Bot agent update: This release includes an **optional** Bot Agent update. To use the new features in v.24 (including updates to Bot Migration, Browser, DLL, Process Discovery, and Recorder packages), update the Bot Agent available with this release. However, note that if you want to run your existing bots, you do not have to update your Bot Agent to this release.

For more information on updating to this release, see these resources:

- [Automatically update the Bot Agent](#) | [Manually update the Bot Agent](#)
- [Compatibility with Automation 360 builds](#)

<p>What's new</p>
<p>Do more with Microsoft Edge Chromium</p> <p>You can now use the Microsoft Edge Chromium browser extension for the following:</p> <ul style="list-style-type: none"> • Bot Agent proxy configuration • Automatic population of device credentials <p><i>Browser requirements for RPA Workspace</i></p>
<p>Reduce turnaround time</p> <p>You can now reduce the turnaround time for collecting information on issues by capturing log files from the Bot Runner device. You can save the log files by using the new <code>-collectlogs</code> command with the Bot Agent diagnostic utility.</p> <p><i>Perform Bot Agent diagnostic checks</i></p>
<p>Enhancement to AISense Recorder</p> <p>You can now use AISense Recorder to automate applications that use Japanese and a combination of Japanese and English interfaces.</p> <p><i>AISense for recording tasks from remote applications</i></p>
<p>Support for copying metadata from one bot to another</p> <p>You can now copy image and metadata files from one bot to another by using the Copy to shared clipboard option.</p>
<p>Wait time option in SOAP Web Service and REST Web Service packages (Service Cloud case ID: 00756730, 00792793, 01255869, 01753287)</p> <p>When you create a bot, you can now set a time-out value for actions in REST and SOAP requests. To indicate how long a bot should wait for a response from the server before timing out, you can set a wait time (in milliseconds) in the Wait for actions to complete field. You can enter a number or a variable or provide a global value.</p>
<p>Format text with new HTML editor in Email package</p> <p>In the Email package, when you use the Send, Reply, and Forward actions, you can now create and customize your email layout and body by using the new HTML design editor. Use the editor toolbar to make various changes to your text, such as applying bold, italic, and other formatting effects, inserting links, and changing the font and size of the text. You can copy the content from the design editor and paste it to other windows.</p>
<p>Task Bot package now supports passing Window variable to child bot (Service Cloud case ID: 00691890, 00804359, 01258948, 01764292)</p> <p>In the Run action of the Task Bot package, when you select Input values fields and enter the values or variables to pass to the child bot, you can now choose the <code>window</code> type variable and pass it from parent bot to child bot.</p>
<p>New option in Content type field of REST Web Service package (Service Cloud case ID: 00666852, 00789910, 00771194, 00785116, 00825945, 01762199)</p> <p>You can now use the multipart/form-data option to upload files and data through REST Web Service. The content type multipart/form-data can be used to submit form elements containing files, non-ASCII data, and binary data. This option is available for actions such as POST, PUT, and PATCH.</p>

What's new
<p>Custom delimiter option in SOAP Web Service package</p> <p>For responses specific to XPath, you can now use the custom delimiter option to delimit the return content from the SOAP response. In the Custom Delimiter field, you can provide a character or a variable, and the output of the delimited response will be a complete string.</p>
<p>New option in Run function action of DLL package (Service Cloud case ID: 00830568, 01063654, 01259336, 01767965)</p> <p>In the Run function action of the DLL package, when the C# DLL interacts with the Windows API to perform system-related operations, such as keystroke, mouse click, or window switching, an intermediate window (AAZeroSizeForm) is displayed occasionally and interrupts the user's operation when the bot is running. In some cases, the DLL function does not interact with the Windows API to perform actions, such as keystroke, mouse click, or window switching, on the operating system UI through the DLL function. In such cases, you can now select the Run function in background check box to bypass the intermediate window (AAZeroSizeForm) and run the C# DLL in the console application without the form. This feature also helps to improve the performance of the DLL execution if the Run function in background check box is selected.</p>
<p>Autoscroll supported in Bot editor (Service Cloud case ID: 00730747)</p> <p>When you are creating or editing bots with a large number of lines of code and when you drag actions up or down the page, the page now automatically scrolls up or down accordingly. This feature is supported in both Flow and List views.</p>
<p>New JSON package</p> <p>Use the JSON package to automate JSON data. You can now extract the required information from JSON text or file and directly use the values in the bot.</p> <p><i>Json package</i></p>
<p>New option in Catch action of Error handler package (Service Cloud case ID: 00766117)</p> <p>In the Error handler package, you can now ignore errors from actions inside the Catch block by using the Catch > On error, continue with next action option. When you select the On error, continue with next action check box, even if there is an error from an action in the Catch block, no exception is thrown and the bot ignores the error and continues to the next action.</p> <hr/> <p>Note: This enhancement applies to all nested actions in the Catch block. For example, if you have a Try/Catch action inside a main Catch action, if the check box is selected on the main Catch action, any error from actions within the nested block will also be ignored.</p> <hr/>
<p>Enhancement to String package</p> <p>In the Extract text action of the String package, when you use the After or Before and/or after option, you can now extract a substring from a specified source string that occurs in the range of 1 through 999999 times in a file.</p>

What's new**Search for files by specific date**

You can now search for files created or modified on a specific date by using the new **On a date** option available in the **File Date** condition of various packages.

You can use this feature with the following packages and actions:

- File package
 - **Copy Desktop files** action
 - **Delete** action
 - **Print** action
 - **Print multiple files** action
 - **Rename** action
- Folder package
 - **Copy** action
 - **Delete** action
 - **Rename** action
- If > File date condition
- Loop > While > File date condition

New action in Excel advanced package (Service Cloud Case ID: 01263892, 01782290)

When you perform actions in a Microsoft Excel worksheet, you can now disable or enable real-time screen update by using the new **Disable or enable real-time screen update** action of the Excel advanced package. This action is useful to improve the performance of Excel-based automations at run time when dealing with large data sets.

[Worksheet operations in Excel advanced](#)

Use Recorder conditions in Chromium-based Microsoft Edge with Internet Explorer (IE) mode

You can now use the **Object exists** and **Object does not exist** Recorder conditions in Chromium-based Microsoft Edge with IE mode for the following packages:

- Loop > While condition
- Wait > Wait for condition
- If package

Internet Explorer browser support for Browser package and window variables

The following actions of the Browser package now support the Internet Explorer browser:

- Open
 - Close
 - Go back
 - Get source code
- In the **Browser** option, you can now select the Internet Explorer tabs from the list of active tabs.

[Browser package](#)

What's new
<p>Enhancement to Datetime package</p> <p>The Variable option in the Datetime > Assign action is now enhanced and divided into two options:</p> <ul style="list-style-type: none"> • Datetime: Enables you to select the date and time along with the time zone manually and assign it to a Datetime variable. • Variable: Enables you to select the Datetime variable or other variables that can have Datetime as a subtype, such as the Dictionary, Record, and list variables. <p><i>Using the Assign action</i></p>
<p>Enhancement to Recorder package</p> <p>You can now capture and automate objects inside a cross-domain iFrame that has multiple iFrames with the same frame source and iFrames that are loaded at run time in Google Chrome and Microsoft Edge Chromium browsers. You can do this by using the Recorder > Capture or the Start recording option. This support is also available for offline Google Chrome extensions.</p> <p><i>Recorder package</i></p>
<p>Support for pop-up windows and dialog boxes in Google Chrome, Microsoft Edge Chromium, and Mozilla Firefox browsers (Service Cloud Case ID: 00762207, 00769773, 00781196, 00786646, 00777907, 00795677, 00785995, 00808600, 00811044, 00767486, 01282172, 01286665, 01256750, 01762040)</p> <p>When you are automating a web page on the supported browsers, you can now capture the pop-up windows, alert dialog boxes, confirmation dialog boxes, and prompt dialog boxes that appear. You can do this by using the Recorder > Capture or Start recording option.</p> <p><i>Recorder package</i></p>
<p>Retrieve source code of an iFrame in Google Chrome browser</p> <p>You can now retrieve the source code of an iFrame in the Google Chrome browser by using the Browser > Get source code action. You can use the new Capture object option to capture these iFrames.</p> <hr/> <p>Note: The Capture object feature is optional and is only used to retrieve the source code of an iFrame.</p>
<p>Run JavaScript inside an iFrame in Google Chrome browser</p> <p>You can now run JavaScript in a page that contains iFrames in the Google Chrome browser by using the Browser > Run JavaScript action. You can use the new Capture object option to capture iFrames on which you want to run JavaScript.</p> <hr/> <p>Note: The Capture object feature is optional and is only used to run JavaScript inside an iFrame.</p>
<p>Global session support for Excel basic package</p> <ul style="list-style-type: none"> • The Global session option is now supported for the Excel basic package. Use the Global session option to share a Microsoft Excel session across multiple bots so that you can use the same Excel worksheet across these bots. • The Session name field is now renamed Create Excel session. <p><i>Using the Open action for Excel basic</i></p>

What's new
<p>Default variable to hold number type data</p> <p>When you are building or testing a bot, you can now use the default number variable <code>SampleNumber</code>, which is included in the Variables palette.</p> <hr/> <p>Note: The default number variable is only available in new bots.</p>
<p>Export and import password-protected files</p> <p>To improve security by providing protection against unauthorized access and malicious editing and also to protect privacy, the export and import features are now enhanced to include the password option. With this feature you can now perform the following:</p> <ul style="list-style-type: none"> • Set a password for the files that you want to export from your Control Room. • Import the password-protected exported file into your Control Room. <p>Export bots Import bots</p>
<p>New options in Git configuration (Service Cloud case ID: 00782957, 00837059, 00687394, 00783715, 00714059, 00659476, 00749755, 00786233, 00748166, 00776417)</p> <p>You can now perform the following actions for Git configuration:</p> <ul style="list-style-type: none"> • Choose either the HTTPS or SSH authentication method to set up the Git configuration. The SSH authentication method is more secure as the authentication is based on a public and private key pair. • Specify the branch to which you want to push your Git commits. This helps with team coordination and workflow management. • Connect to your Git repository by using a proxy server. <p>Configure a remote Git repository in Control Room Restore bots from Git repository</p>

Automation Anywhere Robotic Interface (AARI)

What's new
<p>Microsoft Edge Chromium and Safari supported for AARI</p> <p>You can now create forms and processes in the RPA Workspace and run your requests, tasks, and bots in the web interface on Microsoft Edge Chromium and Safari browsers.</p> <p>Browser requirements for RPA Workspace</p>
<p>Create password fields and hide sensitive information (Service Cloud case ID: 00714159, 01063512)</p> <p>In the RPA Workspace, you can now create password fields by using the Password element in your form builder. You can use the Password element in the web interface to add masked text to your password fields in the initial forms to hide sensitive information.</p> <p>Configure processes Password element properties</p>

What's new**Reference ID enhancement to requests**

You can now view the reference ID associated with your process in the **Reference** column of the **Requests** page. The reference ID is a combination of a prefix and a number that is created from a **Process Key** that you can enter when you edit your process for the first time. This reference ID is incremented whenever a request is created from the corresponding process.

[Reference ID properties](#) | [Configure an AARI process](#)

Cancelled status for tasks

You can now filter tasks by the **Cancelled** status in the **Tasks** page. This status will show a **Cancelled** label next to the filtered results to inform you of the tasks that were cancelled by a user. You can filter by this status from the drop-down menu in the status bar.

[Filter and search for a task](#)

Fill initial form elements by URL parameters

When you create a request, you can now fill initial form elements by creating query scripts that enter specific parameters in the initial form URL. These parameters are applicable only for **Date**, **Number**, **Text Box**, and **Time** elements.

[URL parameters](#)

Customize text in forms using updates to Label element

You can now customize the text in your forms in various ways, such as applying bold, italic, underline, and other formatting effects, changing the font size and color, and so on, by using the **Label** element. With these options, you can highlight specific messages or texts, such as next steps, warnings, or errors, when they are rendered in the initial form in the web interface.

The **Label** element now provides the following formatting options:

- **Emphasis**
- **Font color**
- **Font size**
- **Text alignment**

[Using the Label element](#)

Search and filter columns in a table

On the form builder screen, if you select the **Enable column filtering** check box for the **Table** element, users can search and filter the content for all the available columns when the bot is running.

When you use the **Table** element to render a table in your initial forms, you now have the enhanced ability to search each column of your table by value.

[Using the Table element](#)

Discovery Bot

What's new	
<p>Save the recording with a name</p> <p>After recording a process, you can now save the recording with a name. The name of the recording is displayed on the Recordings page for that process.</p> <p>Record a Discovery Bot business process</p>	
<p>Share a description of the recording</p> <p>You can now provide a description for a recording of a process by using the Recordings page for that process. In the Recordings page, use the Description field to share the context and the purpose of the recording with the analyst. The description provided is also displayed in the PDD.</p> <p>Record a Discovery Bot business process</p>	
<p>Delete a recording</p> <p>After you record a process, if you do not want to submit the recording data to an analyst for review, you can delete the recording by using the Recordings page for that process. In the Recordings page, use the Delete option to delete the recording.</p> <p>Record a Discovery Bot business process</p>	
<p>Record business processes using AARI Assistant</p> <p>You can now use AARI Assistant to record business processes without signing in to the Control Room. To record a business process, start AARI Assistant by double-clicking the AARI icon on your desktop.</p> <p>Record a Discovery Bot process using AARI Assistant</p>	
<p>Enhancements to custom opportunities</p> <p>You can now update the potential cost and savings for custom opportunities and save your changes to the process diagram. The potential cost and potential savings can be updated at any time as you review the steps from various recordings and make changes within the process diagram.</p> <p>Review opportunities, convert to bot, and generate PDD</p>	
<p>Enhancement to PDD</p> <p>You can now view the entire process diagram from within Discovery Bot by clicking the URL link provided in the PDD. The PDD does not display the process diagram if more than 100 steps are selected.</p> <p>Review opportunities, convert to bot, and generate PDD</p>	

Fixes	
Service Cloud case ID	Description
--	In the Community Edition and Free Trial version, you can now create and delete five or more processes, and the autogeneration opportunity does not fail. You can create up to five opportunities.

Automation 360 v.23 Community Edition Release Notes

Release date: 30 December 2021

Review what's new in the Community Edition of the Automation 360 v.23 (Build 11524) release. Build 11524 replaces Build 11513.

Important: Build 11524 includes a fix for the issue of frequent device disconnections caused by either high load or the database being locked.

RPA Workspace

Bot agent update: This release includes a required update to your . Ensure that you complete the update to continue with your automation activities when upgrading from a previous release to this release.

[Automatically update the Bot Agent](#) | [Manually update the Bot Agent](#)

To verify which version is compatible with this release, see [Compatibility with Automation 360 builds](#).

What's new
<p>Microsoft Edge (Chromium) supported for Control Room and Bot Agent</p> <p>You can now perform Control Room operations, and install and register your Bot Agent device using the Microsoft Edge based on Chromium browser.</p> <p>Browser requirements for RPA Workspace</p>
<p>Support to automate Microsoft Edge Chromium with Internet Explorer compatibility mode (Service Cloud case ID: 00767502, 00787186)</p> <p>You can now automate web applications running on Microsoft Edge Chromium, by enabling the Internet Explorer compatibility mode, using the Universal Recorder where the objects are captured using HTML technology.</p> <p>Record a task with the Universal Recorder</p>
<p>Support for cross-domain IFrames in Google Chrome and Microsoft Edge Chromium browsers (Service Cloud case ID: 00825656)</p> <p>You can now capture and automate objects inside a cross-domain IFrame in Google Chrome and Microsoft Edge Chromium browsers by using Recorder > Capture or the Start recording option. After you capture an object inside a cross-domain IFrame, the path to the frame is stored in the FrameDOMXPath property, by default.</p> <p>The new FrameDOMXPath property identifies the path to the frame in which the object is located. You must select this property to run the bot successfully to capture objects on a cross-domain IFrame.</p> <hr/> <p>Note: This feature is available for the bots you create using the 2.4.0-20211016-070100 version of the Recorder package starting from this release.</p> <hr/> <p>Recorder package</p>

What's new
<p>Support for Capture anchor in AISense Recorder</p> <p>The AISense Recorder now supports the Capture Anchor option. When you run a bot to search for an object in an application in which the anchor changes frequently, you can use Capture anchor to override the default anchor and manually select an anchor to detect the object.</p> <p>Edit a task recorded using AISense</p>
<p>Enhanced support when selecting Object property in Recorder package</p> <p>After you capture an object using the Recorder > Capture action, you can now select a particular object property name from the list of available properties in order to retrieve the value of the object property using the Get property action. The list includes suggested property names from the search criteria in the Object Properties table.</p> <p>Recorder package</p>
<p>File ID supported in Check permission action of Google Drive package (Service Cloud case ID: 00777716)</p> <p>The Check permission action of the Google Drive package now supports the File ID option to refer to files available in the <i>Shared with me</i> folder of Google Drive. By providing the File ID, you can now verify the Read, Write, or Delete access granted to you in the <i>Shared with me</i> folder of the Google Drive files.</p> <p>Google Drive package</p>
<p>New Credential package</p> <p>You can now use the Assign action in the Credential package to assign an insecure string or a variable directly to the credential variable.</p> <p>Credential package</p>
<p>Web Services security supported in SOAP Web Service package (Service Cloud case ID: 00481836)</p> <p>As a Bot Creator, you can now provide credential variables in the raw data of the SOAP Web service action. You can create a credential variable, map the credential with a reference name in the credential mapper, and use the reference name in the raw data. Because this ensures that all security-related data can be defined in the Credential Vault and the credentials can be used in bots, you can safely deploy tasks without compromising security.</p> <p>Example of using the SOAP web service action</p>
<p>New option in SOAP Web Service package</p> <p>Use the Build Xpath option in the SOAP Web Service package to extract values from the SOAP response. You can now specify the Xpath expression or select the appropriate node from the response body and store the output in a variable.</p>
<p>Read email from shared mailbox in Microsoft Outlook (Service Cloud case ID: 00728579, 00831622)</p> <p>To automate email-related tasks, you can now select a shared account in Microsoft Outlook so that email messages can be read from the shared mailbox.</p>

What's new**New encoding types supported in the Write to file action of Data Table package** (Service Cloud case ID: 00767158)

When you use the **Write to file** action to write data from a Table type variable to a CSV or TXT file, you can now use the following encoding types from the encoding list:

- UTF-8: Works as UTF-8 without BOM
- UTF-8 with BOM (called UTF-8 previously)
- UTF-16LE
- Shift-JIS (Japanese encoding)

Auto-save functionality in Bot editor

In the Bot editor, when you use actions to build an automation, when a bot is not manually saved, an auto-save is performed and the bot now automatically saves the changes for specific events.

Note: The auto-save functionality is currently available only for specific events.

Some of the events that support auto-save functionality are as follows:

- Recorder: When you create a bot with certain actions and click **Recorder**, the event is saved, and when the recording is complete, the event is automatically saved.
- Variable manager: When you create or edit a variable to insert it in an action, the changes are saved.

Note: The auto-save functionality is not supported when you delete a variable or insert it by pressing F2 to open the variable list.

- Actions menu (vertical ellipsis): When you select any action from this menu, for example **Packages**, the event is saved automatically. When you make any change to the **Packages** page and return to the Bot editor, the event is saved.
- Find a file: When you click the **Find a file** icon, the bot is saved if it is not manually saved. Also, after you click the **Add** option, the bot is automatically saved.
- Dialog boxes: When a dialog box is opened, it is automatically saved if any changes are made.

Note: Auto-save is triggered only for top-level dialog boxes and not for nested dialog boxes.

- Deleting variables: When you delete unused variables, the event is saved.
- Bot name change: If you edit the name of a bot, the event is saved.

New option in FTP / SFTP package (Service Cloud case ID: 00792346)

Use the **Credential** option when you connect with the **Secure FTP** server type to automate a task. You can now use username and password for authentication.

[Using Connect action for FTP/SFTP](#)

Enhancement to AISense Recorder

AISense Recorder now supports automation of applications that use Brazilian-Portuguese and a combination of Brazilian-Portuguese and English interfaces.

[AISense for recording tasks from remote applications](#)

What's new
<p>Enhancements to Number package</p> <ul style="list-style-type: none"> In the Random action of the Number package, you can now specify and limit the number of decimal digits required in the random number generated in the output. The existing Save the outcome to a number variable field is now renamed as Save the outcome to a variable. <p><i>Number package</i></p>
<p>Enhancements to Wait package</p> <p>Use the new Capture region feature in the Wait for screen change action of the Wait package to capture a specific region on an application by drawing a rectangle around it so that the bot automatically captures the coordinates of this region. You can perform the following actions:</p> <ul style="list-style-type: none"> Capture a specific region on a Windows application. Preview the captured image in the Preview window. Recapture a region if the image in the Preview window is not per user requirement. <p>The coordinates are renamed as follows:</p> <ul style="list-style-type: none"> Left is now X Top is now Y Right is now Width Bottom is now Height <p><i>Using Wait for screen change action</i></p>
<p>Enhancement to String package</p> <p>In the Extract text action of the String package, you can now extract a substring from a specified source string that occurs more than 1000 times in a file and up to a maximum limit of 999999.</p>
<p>Enhancement to File conditions in If package</p> <p>You can now use the new File extension condition from the Condition list in the If package to check the extensions of files and then execute actions based on the results.</p>
<p>Enhancement to Excel advanced package (Service Cloud case ID: 00799071)</p> <p>Use the Open action of the Excel advanced package to open files with <code>.ods</code>, <code>.htm</code>, <code>.html</code>, <code>.mht</code>, <code>.mhtml</code>, <code>.slk</code>, and <code>.pdf</code> extensions.</p> <p><i>Excel advanced package</i></p>
<p>Global session support for loop iterator based on Excel advanced</p> <p>You can now use the Global session option when you loop through each row in an Excel advanced worksheet. Use the Global session option to share a Microsoft Excel session across multiple bots so that you can use the same Excel worksheet across these bots.</p> <p><i>Using the Open action for Excel advanced</i></p>

What's new**New APIs for devices**

You can now allocate default devices by using the new APIs introduced in the `v1/Devices` section. Choose to set or not set a specific device as the default deployment device for a specified user by using the following APIs respectively:

- `/runasusers/default`
- `/runasusers/default/unset`

Automation Anywhere Robotic Interface (AARI)

What's new**New query filter in Query Requests and Query Tasks actions**

Use the new filter now available in the **Query Requests** and **Query Tasks** actions of the **AARI Web** package to filter query requests and tasks by team name in the AARI web interface.

Team name filter

You can filter your tasks and requests by team name in the **Task** and **Request** pages in the web interface, respectively. Select the **Team** label from the filter and search by team name to view the teams assigned to a task or request.

[Filter and search for a request](#) | [Filter and search for a task](#)

Support for audit logs (Service Cloud case ID: 00801166)

You can now view the audit logs and refer to events relating to requests, teams, scheduler, process setups, bot setups, human tasks, and bot tasks that you have created, deleted, updated, submitted, or recovered.

[Audit log](#)

Enhancement to user task assignment in Human Task

In the process editor, the **Auto-assign this task** option in **Human Task** provides the following alternatives:

- **The user who created the request:** The task is automatically assigned to the user creating the request in the web interface.
- **The user who opens this task:** The task is automatically assigned to the user who opens the task in the web interface.

This feature helps to reduce conflicts in assigning a task to oneself, particularly in case of specialized users such as Validator for whom the action of opening a task is equivalent to assigning the task to oneself.

What's new**Enhancement to team setup**

You can now simultaneously add multiple users with similar roles (custom role) to the AARI team in the web interface. The custom role in the Control Room is now aligned with a team in the AARI web interface, and the enhanced team setup works as follows:

- The users added with the role are assigned a **Member** role in the team. The role cannot be changed to **Owner** or **Admin**.
- You cannot view these users in the **Users** tab of the **Team** page.
- If a user is both part of a role and added manually to the team, their role in the team will be the same as the role assigned to them manually. For example, if a user is a member, they will continue to have the **Member** role whereas if the user is an owner, they will be assigned the **Owner** role in the team.
- If the user is no longer part of a role, the user will also not be a part of the team.

Also, the **Team** page is now enhanced with navigation options at the top so that you can navigate through the various tabs (**General**, **Users**, **Roles**, **Processes**, and **Bots**). Use the **General**, **Users**, and **Roles** tabs to create teams and add users to them. The **Processes** and **Bots** tabs display the processes and bots assigned to teams, respectively.

[Team management](#) | [Create an AARI team and assign team roles to members](#)

Bot setup support

The AARI Admin can use the **Bot Setup** page to view the bots that are assigned to a team, assign teams to a bot, and edit bots to remove or reassign teams. Attended Bot Runners who can view all the bots that are checked in to the **Public** workspace can now view the bots that are assigned to teams in AARI Assistant.

[Bot setup](#)

Enhancement to the form logo

You can now use the **Logos in footer** field to select up to two separate logos that are displayed in the footer of the form during bot runtime.

What's new**Add rules to various form elements**

When you are creating or editing a form in the form builder, you can now add rules to the following form elements by using the **Form rules** tab:

- **Checkbox**
- **Date**
- **Document**
- **Dropdown**
- **Label**
- **Number**
- **Password**
- **Radio Button**
- **Rich Text Editor**
- **Text Area**
- **Text Box**
- **Time**

For the **Checkbox** and **Radio Button** elements, the rules are triggered only if the corresponding presets are selected. For example, if a form has two mutually exclusive options, such as **Yes** and **No**, the rules associated with these options are triggered only when you select one of the two options.

[Add rules to form elements](#)

What's new
<p>Updates to triggers</p> <p>The following triggers are now available to run a bot:</p> <ul style="list-style-type: none"> • Process trigger: Starts a bot when the status of the specified process in Microsoft Windows meets one of the following preset conditions: <ul style="list-style-type: none"> • Starts • Stops <p><i>Add a process trigger</i></p> • Service trigger: Starts a bot when the status of the specified service in Microsoft Windows meets one of the following preset conditions: <ul style="list-style-type: none"> • Starts • Stops • Resumes • Pauses • Is running • Has stopped • Is paused <p><i>Add a service trigger</i></p> • Window trigger: Starts a bot when the specified application window meets one of the following preset conditions: <ul style="list-style-type: none"> • Opens • Closes <p><i>Add a window trigger</i></p>

Discovery Bot

What's new
<p>Install Bot Agent seamlessly</p> <p>If you have not already installed the Bot Agent, you are now prompted to install the Bot Agent from the Processes tab. Follow the screen instructions to install the Bot Agent. After the installation, you are prompted to enable a Chrome plug-in in order to proceed with your recording tasks.</p> <p><i>Prerequisites for Discovery Bot</i></p>
<p>Enhancement to auto-generated opportunities</p> <p>You can now begin reviewing an auto-generated opportunity from the Opportunities tab when at least one process recording is submitted for review. Review the auto-generated opportunity and choose to create a custom opportunity from an auto-generated opportunity, as required.</p> <p><i>Review opportunities, convert to bot, and generate PDD</i></p>

What's new
<p>New recordings for review for custom opportunity</p> <p>You can now review new recordings submitted by a Discovery Bot user for a custom opportunity. You can choose to accept or dismiss the recording updates as part of the custom opportunity work flow. This option allows you to quickly and easily review new recordings in real time as the recordings are submitted by the user for that process.</p> <p>Review opportunities, convert to bot, and generate PDD</p>
<p>Enhancements to Opportunities page</p> <p>The opportunities page is now updated to include an opportunities evolution map, along with other graphs, to help you review and analyze data for a potential opportunity for automation. Use the opportunities evolution map to help guide you on which opportunities to automate first.</p> <p>Analyzing opportunities for automation</p>
<p>Download PDD document from the Recordings page</p> <p>You can now download and export a PDD document from the Recordings page. After you submit a recording for an analyst to review, the PDD begins processing in the background automatically. When the PDD is generated, the field changes from Processing PDD to Download. You can now choose to download the document in Word format, PDF, or both. An email notification to the business user is also sent to the email address on file. The Download PDD for Word or PDF document is also available for a custom opportunity from the Opportunities list table.</p> <p>Review opportunities, convert to bot, and generate PDD</p>

Limitations
<p>In the Community Edition and Free Trial version, if five processes are created by the user and then deleted, the auto-generated opportunity will fail when the recording is submitted for the sixth process.</p> <p>Workaround: Create a new Community Edition and Free Trial user to create new processes and opportunities.</p>

IQ Bot

What's new
<p>Document Automation released in Community Edition</p> <p>Community Edition now offers limited features from the Document Automation version. This version is integrated with the Community Control Room. When you create a learning instance, IQ Bot automatically creates RPA bots to extract and download the data and an AARI process to manage the end-to-end process. Validation now takes place in AARI tasks.</p> <p>Use IQ Bot Community Edition to extract data from invoices in English.</p> <p>Community Edition</p>

What's new**Classifier enhancements**

You can now create custom document groups in a learning instance. This reduces the possibility of an OCR failing to detect fields in a document, which will cause the Classifier to create a document group unnecessarily or send the document to a wrong group.

[About the Classifier](#)

Automation 360 v.22 Community Edition Release Notes

Release date: 15 September 2021

Review the new features in the Community Edition of the Automation 360 v.22 (Build 10535) release.

RPA Workspace

What's new**Introducing Text file package**

A new Text file package is now available and includes the **Get text** action. Use this action to extract text from files that have Japanese characters with Shift-JIS encoding and then save the content in the files to a string variable.

[Text file package](#)

Share session across bots

Share a DLL, Excel, and Terminal Emulator session across multiple bots using the **Global session** option. You can also share a session with specific child bots using the **Variable** option and share a session with only the current bot using the **Local session** option.

[Sharing sessions across bots](#)

Enhancement to AISense Recorder

AISense Recorder now enables automation of applications that use Russian and a combination of Russian and English interfaces.

[AISense for recording tasks from remote applications](#)

Enhancements to recorder conditions for packages

- Use the new **Object does not exist** condition from the Condition list of any package to verify whether a specific object in a window exists and then execute actions based on the result.

This condition works with SAP technology as well.

- The existing **Object** condition is now renamed as **Object exists**.

[Loop package](#)

What's new
<p>Enhancements to Excel advanced package</p> <ul style="list-style-type: none"> • Open files with <code>.xml</code> and <code>.txt</code> extensions using the Open action. • Use the wildcard character (*) in the Open action for file names to search based on the wildcard pattern. • When you use the Run macro action and specify an argument that has a blank value, this blank value can now be passed to the macro.
<p>New option in Database: Disconnect action</p> <p>In the Database: Disconnect action, you can now use the Keep database schema in cache until bot finishes running option to enable the Loop action to iterate the dataset by using cached schema after disconnecting from the database.</p>
<p>Use regular expressions in File > Open action (Service Cloud case ID: 00737614)</p> <p>Use regular expressions (regex) in the Open action of the File package to support pattern-based search.</p>
<p>Specify timeout for bots (Service Cloud case ID: 00667049, 00690892, 00699158, 00706491, 00739420, 00739415, 00741590, 00769795)</p> <p>You can now specify the amount of time by which the execution of a bot must be completed. The system stops the bot execution if it is not completed within the time you specified.</p> <p>Configure timeout for bot execution</p>
<p>New Exchange version supported in Email package</p> <p>In the Email package, when you choose an EWS server to establish a connection, you can now use the Exchange2013 option in the Exchange Version field.</p>
<p>New actions in Window package</p> <ul style="list-style-type: none"> • Use the Close all action to close all windows or programs running on the system, except the windows added in the Add window field. • Use the Restore action to restore the size of a maximized or a minimized window or application running on the system. <p>Window package</p>
<p>New option to search text within bot content in Bot editor (Service Cloud case ID: 00735685, 00736201, 00739122, 00740481, 00733885, 00748970, 00746459, 00738181, 00756441, 00759037, 00761453, 00764478)</p> <p>In the Bot editor, use the search box in the Flow, List, or Dual view to search for text, variables, or actions in the entire bot content such as package name, action name, string name, or variable name. This feature helps you to view or edit a bot with long code lines to determine where the searched text, such as variables, strings, or actions, is used and in which line.</p> <p>Actions palette for bot creation</p>
<p>Enhanced support for SOAP Web Service URI (Service Cloud case ID: 00759811)</p> <p>In the SOAP Web Service package, if the input to the Address location field is empty, the bot now retrieves the address location from the WSDL file.</p>

What's new
<p>New option in SOAP Web Service package</p> <p>Use the Build SOAP request option in the SOAP Web Service package to retrieve SOAP request details from the SOAP URI or the WSDL file. You can now select any operations from the list of services and ports available in the SOAP Request to automatically populate data in the fields of the SOAP Web Service action.</p> <p><i>Example of using the SOAP web service action</i></p>
<p>TNS name supported for Oracle Database connection</p> <p>TNS (Transparent Network Substrate) name is now supported in the Oracle Database. You can connect to the Oracle Database by specifying the TNS name and path of the <code>tnsnames.ora</code> configuration file.</p>
<p>Wait time option in Google Sheets package (Service Cloud case ID: 00738249, 00817449, 00814775)</p> <p>When you use the Connect in the action in the Google Sheets package to establish a connection with the Google server, you can now set a wait time in the Wait for actions to complete field when performing actions such as Get, Set, or Delete. For example, if you have a large file that takes a long time to open, you can now set the wait time for the file to open before the system executes the next set of actions.</p>
<p>New option for Put action in Dictionary package</p> <p>You can now assign a static value to a key for a dictionary variable by using the Static value option in the Put action in the Dictionary package.</p> <p><i>Dictionary package</i></p>
<p>Relative click and occurrence supported in packages (Service Cloud case ID: 0055643,00754173)</p> <p>When you capture a target image using the Image Recognition package, you can now use the Preview option to select a specific captured occurrence and position your click location relative to the image.</p> <p>The feature is supported in the following packages and actions:</p> <ul style="list-style-type: none"> • Image Recognition > Find image in window • Image Recognition > Find window in window • If > Image Recognition condition • Loop > While > Image Recognition condition • Wait for condition action > Image Recognition condition <p><i>Using Find image in window action Using the Find window in window action</i></p>
<p>Enhancements to execution type key in AATaskExecutor variable</p> <ul style="list-style-type: none"> • When you schedule a bot to run, the <code>Execution_Type</code> key in the <code>AATaskExecutor</code> variable now returns information about the execution type with schedule type (frequency) such as <code>Run as schedule Daily</code>, <code>Run as schedule Weekly</code>, or <code>Run as schedule Monthly</code>. • When you use a trigger in a bot, the <code>Execution_Type</code> key can be accessed through the trigger data. The <code>Execution_Type</code> key returns the <code>Run through Trigger</code> as a string for triggers.

What's new
<p>Language support for variable names</p> <p>Variable names now support Greek and Japanese languages. You can now create variable names using the following characters:</p> <ul style="list-style-type: none"> • Greek uppercase and lowercase characters • Japanese Katakana full-width and half-width characters.
<p>New option in REST Web Service (Service Cloud case ID: 00764198, 00800287)</p> <p>In the REST Web Service package, you can now use the Allow insecure connection when using https option to skip SSL certificate validation and to allow non-secure connections.</p>
<p>Work item ID and time filters for workload automations</p> <p>Combine the work item ID and start time of a queue to search for specific work items and monitor the progress of these work items. The start time filters the list of all work items that start between specified start date and start time.</p> <p><i>Actions allowed on view queue page</i></p>
<p>Enhancements to the bot structure</p> <p>We have enhanced the overall readability of the bot structure and updated the node labels of the bot to show selected properties and parameters of each action in detail in the Flow, List, and Dual views. You no longer have to expand each action to view these details.</p> <p>The Flow, List, and Dual views display the following properties of actions:</p> <ul style="list-style-type: none"> • The value you enter for actions such as Set text for all supported technologies • Names of objects on which actions such as Set text, Click, Left click, Get property, and Select item by index are performed • Name of the object property mentioned in the action • Name of the return variable if some value is assigned to a variable • List of properties for the Get property action
<p>Java applications supported in App integration package</p> <p>The App integration package now supports Java applications that are based on the Standard Widget Toolkit and Abstract Window Toolkit, which can draw text using Windows text-drawing APIs.</p>
<p>Direct download support in Bot Store</p> <p>Users who cannot connect their Control Room to the internet can now directly download Automation 360 bots and packages locally from Bot Store and then import them to their Control Room.</p> <p><i>Download locally and import bots and packages from Bot Store to Control Room</i></p>

AARI (Automation Anywhere Robotic Interface)

What's new
<p>Select File element input supported for Create a Request action</p> <p>The Create a Request action in the AARI Web package now supports passing input in the request creation forms for the Select File element. You can now use bots to create a request and upload or download files as input with the Select File element. These input files are uploaded to the storage service to be available for further processing in the request.</p>
<p>Output variables support in Process Editor</p> <p>The Output variables section in the process editor enables you to create a user-defined variable that can be set as an output to any process. This helps you pass the output from the child (sub) process, which was called in the Process Task, to the parent (main) process.</p> <p><i>Use an Output variable</i></p>
<p>Detail view in Tasks page</p> <p>The new Detail view option in the Tasks page provides better insight into individual tasks for better task management. The detail view previews each task in its respective request view page without opening another page, which helps organize and correspond your tasks with the available requests. Users can interact with their tasks as well.</p>

Discovery Bot

What's new
<p>View Groups of steps</p> <p>When reviewing a process view, you can now use the group option or icon to display groups of steps that belong to the primary level action and secondary level action (and subgroup level actions) used during the recording session.</p> <p>Use the group icon to help you decide what groups of steps to select for a task you want to automate. For example, a primary level action displays Microsoft Outlook, a secondary level action displays Outlook mail notification, and subgroup level actions display terms such as Email -Add To, Email – Add Subject.</p> <p><i>Create a process view with branches and opportunities</i></p>
<p>Use Dynamic option for system-generated views</p> <p>You can now use the Dynamic option from the Model options to view recordings where groups of steps display a set of repeating patterns that belong to the same application or same primary level action used during the recording session.</p> <p>Use this option to decide the context of the process or the task you want to automate. Groups of steps that are labeled belong to supported applications such as Microsoft (Excel, Outlook, and Notepad), Notepad++, text editors, most windows use cases, and Chrome browser functionality.</p> <p><i>Create a process view with branches and opportunities</i></p>

What's new**Enhancements to PDD Word document**

The PDD Word document now includes a process recording flow chart and the time on each individual step in hours, minutes, and seconds.

[Review opportunities and convert to bot](#)

Previous Community Edition Release Notes

Review the release notes for previous Community Edition releases.

Automation 360 v.21 Community Edition Release Notes

Release date: 02 June 2021

Review the new features in the Community Edition of the Automation 360 v.21 (Build 9664) release.

- [RPA Workspace](#)
- [AARI](#)
- [Discovery Bot](#)

RPA Workspace

Bot agent update: This release includes a required update to your . Ensure that you complete the update to continue with your automation activities when upgrading from a previous release to this release.

[Automatically update the Bot Agent](#) | [Manually update the Bot Agent](#)

To verify which version is compatible with this release, see [Compatibility with Automation 360 builds](#).

New features**Automation 360 navigation enhancements**

We have enhanced the overall readability and accessibility of the Automation 360 interface. To make navigation easier, menus and views are organized based on frequently used features and related tasks.

The interface includes the following updates:

- The Device, Profile, and Help icons are now located at the bottom of the navigation menu, consolidating all controls on the left for easy access.
When you click these icons, flyout panels of content and actions are shown.
- The side navigation menu can be collapsed to a slim bar to maximize the main workspace area.
You can continue to use the side navigation in collapsed mode, with flyouts for each section.

[Automation 360 navigation updates](#)

New features
<p>Deploy workload automation on a multi-user Windows terminal server</p> <p>To optimize workload automation and multi-user devices, you can deploy workload automations on a multi-user Windows terminal server so that a single device can process multiple work items concurrently.</p> <p>About multi-user devices About device pools</p>
<p>New actions in the SAP BAPI package</p> <p>Use the following new actions:</p> <ul style="list-style-type: none"> • Run standard workflow: Runs a standard workflow in SAP BAPI. • Run custom workflow: Runs a custom workflow in SAP BAPI. <p>SAP BAPI package</p>
<p>New actions in File package</p> <p>Use the following new actions:</p> <ul style="list-style-type: none"> • Get name: Reads a file name and stores it to a string. • Get path: Reads the path of the file and stores it to a string. <p>File package</p>
<p>Common table expression supported in Database package</p> <p>You can now use common table expression (CTE) in the Read from action using the <code>WITH</code> keyword in SQL-compliant databases such as Oracle and MySQL. Use CTE statements within a SQL query to simplify complex joins and subqueries.</p> <p>Using the Read from action</p>
<p>Support for large numbers in Number package (Service Cloud case ID:00557619)</p> <p>You can now perform mathematical operations for large numbers with more precision in the Number package.</p> <p>Number package</p>
<p>Snowflake database support using ODBC driver (Service Cloud case ID:00761695)</p> <p>Snowflake ODBC driver is now supported in the Database package. You can connect to the Snowflake database using ODBC-based client applications.</p> <p>The following actions support this feature:</p> <ul style="list-style-type: none"> • Connect • Disconnect • Read from • Export to data table • Insert/Update/Delete
<p>Variables: new features and enhancements (Service Cloud Case ID:00740585)</p> <ul style="list-style-type: none"> • Edit the variable name after the variable is created. • Delete all or a specific selection of unused variables from a bot.

New features
<p>Universal Recorder new features and enhancements</p> <ul style="list-style-type: none"> Record object interactions in applications built on the Electron framework. Perform double-click in all supported applications and browsers.
<p>Limit credential attribute use to password fields only (Service Cloud Case ID:00740585)</p> <p>When you create or edit a credential attribute, ensure that bots input the attribute value only in fields that are identified as password fields by selecting the Set this attribute as a password option.</p>
<p>Default names for output variables</p> <p>When you configure an output variable for the actions in the Error handler and Python Script packages, the Control Room automatically generates a descriptive default variable name. If you create more than one output variable for an action, the subsequent variable names are appended with a <i>-1</i>, <i>-2</i>, <i>-3</i>, and so on to avoid a variable name conflict.</p>
<p>New string action to support nested variables</p> <p>Use the String > Evaluate value action to compare a user-specified string variable with the string variables in the bot. If a match is found, the action returns the value of the matching variable.</p> <p><i>String package</i></p>
<p>Delete Global values</p> <p>A user with the AAE_Admin role can delete a global value from the All global values page.</p> <p><i>Global values</i></p>
<p>ODBC driver support for all connection strings (Service Cloud Case ID: 00748887, 00777676)</p> <p>An Open Database Connectivity (ODBC) driver is now available to support all the ODBC connection strings in the same way it was used in the Enterprise 11 version. Using SQL as a standard for accessing and managing data, you can connect to MySQL, Google BigQuery, Snowflake, and other databases using the ODBC driver.</p>
<p>Share a DLL session</p> <p>You can now share a DLL session between bots.</p>

Automation Anywhere Robotic Interface (AARI)

New features
<p>Download, delete, or view files in browser in initial forms or tasks</p> <p>Users can now use the Select File element to download files that are uploaded to the initial forms or tasks, and they can also delete files or access the hyperlink file to view the file in within the browser. The uploaded file can be accessed as a hyperlink, and new icons are available for download and delete.</p>

New features
<p>Enhancement to team roles</p> <p>The AARI team consists of three roles:</p> <ul style="list-style-type: none"> • Member: Can create, view, and delete their own requests. All the tasks are automatically assigned to the member when they create the request in a private team. In a shared team, the member can assign tasks to other members. • Owner: Can create, view, delete, and assign all the requests from the members in the team. • Admin: Can create, view delete, and assign all the requests from the members in the team. The admin can also modify the team. <p>An AARI admin or manager can edit their teams and update their team members' roles. They also have the option to add or remove team members. The AARI manager is the team admin by default when they create a team.</p>
<p>Assign to me feature in tasks</p> <p>When a task is unassigned and users access the tasks, use the Assign to me option to allow the tasks to be assigned to the current user so that they can immediately access the form.</p> <p>Assign or unassign a task</p>
<p>New Bot page</p> <p>When AARI team members with attended Bot Runner licenses access the web interface, they are automatically redirected to AARI Assistant. Users can view all the bots created by them on this page. They can also pin, search, and sort their assigned bots.</p>
<p>New team reference in Request and Process pages</p> <p>The user can now reference the team from which a request is created by referring to the new Team column in the Request page or the team name added in the process tile in the Process page, to help guide their team assignment.</p>
<p>New Request Visibility field (Service Cloud case ID: 00718119)</p> <p>Request visibility enables users to allow or restrict access to a request they created to other team members. When the Request Visibility field is set to Shared, all the requests are accessible by all members, owners, and team admins. If the field is set to Private, the requests are available only to the user who has created the request, owner, and the team admin.</p>
<p>Enhancement to the Processes page</p> <p>The following enhancements are available on the Processes page:</p> <ul style="list-style-type: none"> • Sort the processes by name, in ascending or descending order. • Toggle the pinning of a process. • Use the responsive view to adjust the display to the screen size.
<p>AARI Assistant for attended Bot Runners</p> <p>The AARI Assistant application enables users with the attended Bot Runner license to access their bots without logging in to the Control Room. AARI web users can use the AARI Assistant when the attended Bot Runner license is enabled along with their AARI User license without impacting their existing functionality.</p> <p>About AARI Assistant</p>

New features**Add rows from header row context menu**

Only the header row is displayed when a form that has a table is launched during bot runtime. Use one of the following methods to add new rows to the table:

- Header row context menu of the table

[Using the Table element](#)

- The **Set** action in a bot

[Using Set action](#)

Discovery Bot

New features**Sort for a process tile from the Processes page**

You can now use the sort field to help you locate a process tile quickly. From the **Processes** page, use the drop-down menu to sort on a process tile based on the process name in alphabetical order. Alternatively, you can sort in the order of the newest process created to the oldest process and vice versa.

[Create a Discovery Bot process](#)

Enhancements to opportunities

You can now review and analyze automatically generated (or system-generated) opportunities immediately from the **Opportunities** page. Auto-generated opportunities are created when at least two recordings are approved by the user. You can create a custom opportunity from an auto-generated opportunity and apply the **Model** and **Filter** options to target a specific opportunity for automation.

You can now prioritize opportunities based on a simple formula for all recordings in a process. From the Opportunities table, you can view the cost without automation and savings for an opportunity. The system automatically calculates the cost and potential savings for each opportunity generated. You can customize these metrics based on your organization's model for cost and savings.

[Review opportunities and convert to bot](#)

Generated PDD files are available on your local server

The generated PDD file for an opportunity is now stored locally on your server for On-Premises deployments. The existing PDD files are automatically moved to the new location and are not deleted when a re-installation or upgrade is performed in the Control Room.

[Prerequisites for Discovery Bot](#)

Community Edition A2019.20 Release Notes

Release date: 14 April 2021

Review the new features in the Community Edition A2019.20 release (Build 8846).

- *[Community Edition](#)*
- *[AARI](#)*

- [Discovery Bot](#)
- [Bot Insight](#)

Community Edition

Bot agent update: This release includes a required update to your . Ensure that you complete the update to continue with your automation activities when upgrading from a previous release to this release.

[Automatically update the Bot Agent](#) | [Manually update the Bot Agent](#)

To verify which version is compatible with this release, see [Compatibility with Automation 360 builds](#).

What's new
<p>Automate SAP-related tasks using SAP BAPI</p> <p>Use the actions available in the SAP BAPI package to automate SAP-related tasks using SAP BAPI.</p> <p>SAP BAPI package</p>
<p>Default names for output variables</p> <p>When you configure an output variable for the following packages, the Control Room shows a descriptive default variable name. If you create several output variables, subsequent variable names are appended with a -1, -2, -3, and so on to avoid duplication.</p> <ul style="list-style-type: none"> • Browser • CSV/TXT • Email • Excel advanced • JavaScript • Loop • Recorder • VBScript • Window
<p>PDF split with blank pages supports scanned image documents (Service Cloud case ID: 00683923)</p> <p>Use the PDF Split action to separate a blank page from pages with scanned images. With pixel-based split, you can now use Split document to split a PDF with blank page separators for scanned (image-based) documents.</p>
<p>SMTP port range expanded to include ports 1 through 65535</p> <p>The Email package now supports ports in the range of 1 through 65535 for the SMTP server. You can use the Send email action by configuring the SMTP port in this range.</p>
<p>New actions in the Active Directory package</p> <ul style="list-style-type: none"> • Update account options: Sets account attributes for the user. • Change user password: Use this option to change a user's password. <p>User account operations</p>

What's new
<p>Enhancement to Create user action in Active Directory package</p> <p>You can now use the Create user action to create an Active Directory user with password.</p> <p><i>Using the Create user action</i></p>
<p>Universal Recorder expanded support and new features</p> <p>Use the Universal Recorder to perform the following:</p> <ul style="list-style-type: none"> Automate clicks and data retrieval in drop-down lists and combo boxes in Oracle EBS applications such as Compass. Link an object that the bot cannot reliably identify to a nearby object (such as a link or button) that is easier for the bot to find. Use this feature in MSAA, UI Automation, or Java applications.
<p>Support for new languages in variable names</p> <p>You can now use Czech, Danish, Dutch, Finnish, French, German, Hungarian, Italian, Norwegian, Polish, Portuguese, Romanian, Spanish, and Swedish characters in variable names.</p> <p><i>Unicode range supported in variables</i></p>
<p>Search and add child bot in the parent bot</p> <p>Search for a child bot in the public and private workspaces so that you can add it in the parent bot. You can search for the child bot from the Bot editor and the Run action of the Task Bot package.</p> <p><i>Using the Run action Bot editor for creating bots</i></p>
<p>Obtain information about user that deployed the bot</p> <p>Use the <i>AATaskInvoker</i> system variable to return the username, first name, last name, and email of the user that ran or scheduled the bot. If the bot is deployed to an attended Bot Runner, this variable returns information about the logged-in user. If the bot is deployed by a trigger, this variable returns information about the user who set the trigger.</p> <p><i>System settings and parameters</i></p>
<p>New condition in If package (Service Cloud case ID: 00536088, 00690073,00717514, 00737243, 00702383)</p> <p>Use the new Window with same title does not exist or Window with same title exist condition available in the If package to verify whether a window with the same title exists or whether the window title has changed.</p> <p><i>If package</i></p>
<p>Google packages are now generally available</p> <p>Google Calendar, Google Drive, and Google Sheets packages are now generally available in Automation 360, and contain these new actions:</p> <ul style="list-style-type: none"> Write from data table and Insert row/column actions in the Google Sheets package. Each Google package contains a Connect action to authenticate your account before adding other actions from that package to your automation. This action replaces the deprecated OAuth action from the G-Apps package. Each Google package contains a Disconnect action to terminate the connection. <p><i>Using the Connect action for Google packages</i></p>

Automation Anywhere Robotic Interface (AARI)

What's new
<p>Get Storage file action</p> <p>The new Get Storage file action in the AARI Web package enables you to download storage files to a bot device.</p> <p>AARI Web package</p>
<p>Upload files in initial forms or tasks</p> <p>Add the Select File element to forms to enable users to select and upload files in the initial forms or tasks in the web interface. Users can browse to upload a new file or replace an existing file. The uploaded file is shown as a hyperlink and redirects users to a new tab when opened.</p> <p>Configure processes</p>
<p>Hyperlinks support for initial forms or tasks</p> <p>Use the new Hyperlink element to add links to forms and access them in initial forms and tasks.</p> <p>Configure processes</p>
<p>Configure a scheduler user for each process (Service Cloud case ID: 00713786)</p> <p>As an AARI administrator, you can now configure a scheduler user for each process to allocate the Control Room resources (devices and unattended Bot Runners) on the web interface. By default, the Global scheduler user is selected if a scheduler user is not configured for individual processes.</p> <p>Configure scheduler user for AARI on the web</p>
<p>Update to properties panel for human task (Service Cloud case ID: 00718109)</p> <p>As a Bot Creator, you can choose to not configure any actions in the human task by selecting the Make the form read-only check box in the Properties panel. The human task does not require any input and it is executed automatically to the next task.</p>
<p>Bookmark any page as landing page for AARI on the web</p> <p>The web interface is now enhanced to a new multiple page system so that you can directly bookmark any page (Requests, Tasks, or Recycle Bin) as your landing page. Also, the tabs in the web interface have been removed so that the requests are opened one at a time and not simultaneously. To perform multiple tasks, you can open the requests pages in different browser tabs.</p>
<p>Navigation enhancement in AARI on the web</p> <p>The web interface is now enhanced with a side navigation pane so that you can easily navigate to various pages (Processes, Requests, Recycle Bin, and Tasks).</p>
<p>New processes page (Service Cloud case ID: 00694786)</p> <p>As an AARI user, navigate to your assigned processes and create new requests by using the new Processes page in the web interface. Use the navigation bar to quickly access the page.</p>

What's new
<p>Enhancements to the Button element</p> <ul style="list-style-type: none"> • Use the Disallow button click when this form is first loaded option to disable the Button element in a form when it is displayed for the first time during bot runtime. • Use the Subtle option in the Button type drop-down menu if you want the button element to appear as a link during bot runtime. <p>Using the Button element</p>
<p>Enhancement to the form logo</p> <p>You can now use the Logos in footer field option to select up to two separate logos that are displayed in the footer of the form during bot runtime.</p> <p>Create a form</p>

Discovery Bot

What's new
<p>Search for a business process from the Processes page</p> <p>You can now use the search field to help you locate a specific process by name. The field is not case-sensitive. The search field is available from the Processes page.</p> <p>Create a Discovery Bot process</p>
<p>View all captured images from the screenshot modal window</p> <p>You can now navigate across all captured screenshots when you click an image in full size from the modal window. Click the pagination located below the image to select a step number or use the right or left arrows to quickly display all captured images.</p> <p>Record a Discovery Bot business process</p>
<p>Process Discovery package is included in default packages</p> <p>The Process Discovery package is now included in the default packages. You can preload the default package when you connect to your device. Preloading the package helps to speed the start time of the recorder the first time you begin recording a process</p> <p>Prerequisites for Discovery Bot</p>
<p>Recorder enhancements</p> <p>You can now perform actions such as double-click, drag-drop, click and hold, and text select when recording a business process. Actions performed using keyboard strokes are displayed in the Data field. Double-click is captured by the recorder and displayed in the screenshot from the Recordings page.</p> <hr/> <p>Note: The Discovery Bot recorder does not capture the drag-drop and click and hold actions from the Recordings page. To include these actions performed during the recording, you can document the individual steps in the Step description text field for the analyst.</p> <hr/> <p>Record a Discovery Bot business process</p>

IQ Bot

Known limitations

IPv6 addresses are not supported for IQ Bot, so ensure that you use only IPv4 addresses.

Bot Insight

What's new

AAE_Admin role access to operations API from Power BI connector

The Power BI connector now provides the **AAE_Admin** user role access to the botrundata operational API. With this role, you can connect to the botrundata API and extract operational metrics to be analyzed and visualized within Power BI.

Enhancements to the publish (production) dashboard

Users with the **AAE_Bot Insight Admin** and **AAE_Bot Insight Expert** role can now edit the published dashboard. You can use the save as option to save the production dashboard as a custom production dashboard and add widgets to your custom dashboard. You can also delete a default production dashboard and a custom production dashboard.

[Save a published dashboard](#) | [Delete a published dashboard](#)

Important: The supported packages information is moved to this topic: [View package versions available in the Control Room.](#)

Community Edition A2019.19 Release Notes

Release date: 05 February 2021

Review the new features in the Community Edition A2019.19 release (Build 8145).

- [Community Edition](#)
- [AARI](#)
- [Discovery Bot](#)

Community Edition

Bot agent update: This release includes a required update to your . Ensure that you complete the update to continue with your automation activities when upgrading from a previous release to this release.

[Automatically update the Bot Agent](#) | [Manually update the Bot Agent](#)

To verify which version is compatible with this release, see [Compatibility with Automation 360 builds.](#)

New features
<p>New features in Data Table package (Service Cloud case ID: 00656843, 00707635)</p> <ul style="list-style-type: none"> • Use the Change column type action in the Data Table package to perform operations on the column of a data table. Use this action to change the column data type to Boolean, Datetime, Number, or String. • Sort the data in the data table in Number, Datetime, Boolean, or String format. <p><i>Data Table package</i></p>
<p>New action in App Integration package</p> <p>Use the Capture scrollable text action to extract text from the selected window or any control within the selected window and save it to a variable. If you click any control within the window, then text from that specific control is extracted. If you click outside the window, then all the text from that window is extracted.</p> <p><i>App Integration package</i></p>
<p>New encoding combo box option in Terminal Emulator for VT Series</p> <p>To send and receive Japanese text, you can now use the Encoding and CodePage combo boxes when you connect to the Terminal Emulator for the VT series terminal type.</p> <p><i>Using Connect action for Terminal Emulator</i></p>
<p>New actions in Active Directory package</p> <p>Use the following actions in the Active Directory to automate a task:</p> <ul style="list-style-type: none"> • Move a computer <i>Using the Move computer action</i> • Move an organizational unit <i>Using the Move organizational unit action</i> • Add users to a group <i>Using the Add users to group action</i> • Remove users from a group <i>Using the Remove users from group action</i>
<p>New system variable for new line character (Service Cloud case ID: 00669232, 00672775, 00673578)</p> <p>Use the <code>\$String:Newline\$</code> system variable to add a new line character. This variable adds a new line character in various applications regardless of the operating system of the device.</p>
<p>Zero-size form for Enterprise A2019 (Service Cloud case ID: 00677611)</p> <p>The Run action uses the zero-size form with name <code>AAZeroSizeForm</code> that can be used by DLLs to identify zero-size forms created by Enterprise A2019.</p>
<p>Enhancement to define parent path in Active Directory</p> <p>When you establish a connection with an LDAP server, you can now select the LDAP path by connecting to the server.</p> <p><i>Using Connect action for Active Directory</i></p>

New features
<p>Obtain information about Run-As user after bot deployment</p> <p>Use the <i>AATaskExecutor</i> system variable to return the username, first name, last name, and email of the user that ran the bot. If the bot is deployed on an attended Bot Runner, this variable returns information about the logged-in user. If the bot is deployed by a trigger, this variable returns information about the user associated with that Bot Runner license.</p> <p><i>System settings and parameters</i></p>
<p>Enhancements to the Recorder</p> <ul style="list-style-type: none"> • Universal Recorder now supports object capture in Mozilla Firefox. You must install the A2019 extension from Mozilla Firefox browser add-ons. • Capture table, grid view, and main window objects from SAP applications. <p><i>Universal Recorder supported applications and browsers Actions performed on objects captured with Universal Recorder</i></p>

Automation Anywhere Robotic Interface (AARI)

New features
<p>New filter task in the process editor</p> <p>In the process editor, the Filter Task enables users to filter variables such as human or bot task output with a specific filter criterion.</p> <p><i>Create an AARI process</i></p>
<p>New process task in the process editor</p> <p>Use the new Process Task option in the process editor to call a subprocess within the main process. This feature enables you to separate tasks into different processes instead of including all the tasks in a single process. Multiple teams can now work at the same time on different tasks within the main process and remain segregated, without any conflicts.</p> <p><i>Create an AARI process</i></p>
<p>Hide a task or view a hidden task</p> <p>With a Bot Creator license, you can now perform the following:</p> <ul style="list-style-type: none"> • Hide the display of human and bot tasks by selecting the Hide this task after completion option in the process editor. • View a hidden human or bot tasks by selecting the View hidden tasks option in the tasks view page. <p><i>Create an AARI process</i></p>
<p>Edit title in process editor</p> <p>Users can now edit the title in the process editor.</p>
<p>Rich-text editor updates (web interface)</p> <p>In the web interface, you can use rich-text editor features such as bold text, italics, underline, alignment, formatting, color, and size in tasks.</p>

New features
<p>Table element updates (web interface)</p> <p>In the web interface, the Table element now supports the use of date, number, drop-down, and text values in tasks.</p>
<p>Updates to elements in form builder</p> <p>The form builder now includes the following new elements:</p> <ul style="list-style-type: none"> • Select Folder element: Add an upload folder option in the form. <i>Using the Select Folder element</i> • Hyperlink element: Assign a URL in the form. <i>Using the Hyperlink element</i>
<p>Enhancement to the Checkbox action trigger</p> <p>If a form with a Checkbox element is used within a trigger loop package, you can now use the Value selected and Value unselected trigger actions. <i>Trigger loop package</i></p>

Discovery Bot

New features
<p>View the duration of each recorded step</p> <p>A recorded step is now displayed in minutes and seconds for the business user and analyst. Use this information to understand which steps are a bottleneck in the current process and will provide most benefit from automation. The step duration is displayed from the Recordings page (below the screenshot image), and from the View process and View opportunities page from the Preview pane window. <i>Record a Discovery Bot business process</i></p>

Important: The supported packages information is moved to this topic: [View package versions available in the Control Room.](#)

Community Edition A2019.18 Release Notes

Release date: 05 January 2021

Review the new features and supported packages in the Community Edition A2019.18 release (Build 7560).

- [Community Edition A2019](#)
- [AARI](#)
- [Discovery Bot](#)
- [Bot Insight](#)
- [Supported packages](#)

Community Edition A2019

Bot agent update: This release includes a required update to your . Ensure that you complete the update to continue with your automation activities when upgrading from a previous release to this release.

[Automatically update the Bot Agent](#) | [Manually update the Bot Agent](#)

Build 7560 (Community Edition) is compatible with Bot Agent 16.19.8232.

New features
<p>Configure timeout in Bot Migration package</p> <p>When migrating bots, you can now set a timeout value in the range of 3 through 90 minutes (default value is 90 minutes). If the migration of any specific bot is not completed within the set time, a timeout message is displayed and the migration process moves to the next bot.</p>
<p>Use regular expressions in variables (Service Cloud case ID: 00628227)</p> <p>Use regular expressions (regex) in value type variables to specify the entity on which you want to perform an operation. For example, actions in the File, Folder, String, and Window packages allow use of regular expression in variables.</p> <p>When Enterprise 11 or Enterprise 10 bots with commands that use regular expressions in variables are migrated, if their equivalent actions in Enterprise A2019 do not support regular expressions, the regular expression is converted to string in the migrated bots.</p>
<p>Recorder enhancements</p> <ul style="list-style-type: none"> Use the AISense Recorder Define option to record an interaction, such as click active text, with an object that is only visible when you hover the mouse over the object. If you record a click and keystrokes in a text box with a Control Type of <code>PASSWORD_TEXT</code>, the Recorder does not capture the keystrokes entered into the field. Instead, the action selects the Set text option and offers users the option to select a credential from the Credential Vault, enter a credential variable, or enter an insecure string.
<p>Efficiently map input and output variables between parent and child bots (Service Cloud case ID: 00537090, 00698697)</p> <p>For input variables, use the Quick map option to select the variables and set the values for the parent bot to pass. For output variables, use the Multiple variables tab to associate each dictionary key with a variable. This feature eliminates the need to use actions to extract the output dictionary values.</p> <p>Task Bot package Using the Run action</p>
<p>Support for PowerBuilder application in App Integration package (Service Cloud case ID: 00680703)</p> <p>The App Integration package now supports PowerBuilder to capture and extract text from a window application. The Capture text of window action enables you to open a PowerBuilder screen to capture all the data and verify the captured text.</p>
<p>New action in Terminal Emulator package</p> <p>Use the Search Field action in the Terminal Emulator package to search for a field based on the text it contains. This action returns the name or index of the field based on the option selected.</p> <p>Terminal Emulator package</p>

New features
<p>New action in PDF package</p> <p>Use the Get Property action in the PDF package to retrieve the properties of a PDF file and assigns the properties to a dictionary variable.</p> <p><i>Using the Get property action</i></p>
<p>New actions in Browser package</p> <p>Use the following actions in the Browser package:</p> <ul style="list-style-type: none"> • Close: Closes a Google Chrome browser window or tab. • Get source code: Retrieves the source code of a web page and saves it to a string variable. • Go back: Returns to a web page that you previously visited in the current tab. • Open: Opens the browser to a specific web page in an existing tab, new tab, or window. • Run JavaScript: Executes JavaScript in a web page. <p><i>Browser package</i></p>
<p>Specify application window dimensions</p> <p>Use the Resize windows option to set the window height and width to specific dimensions or to the dimensions at which it was captured. This feature enhances the bot's ability to identify the target object.</p> <p>The following packages support this feature:</p> <ul style="list-style-type: none"> • App Integration • If Image recognition condition • If Legacy Automation > Window Control condition • Image Recognition • Simulate keystrokes • Legacy Automation Desktop > Manage windows controls action • Loop While > Image recognition condition • Loop While > Legacy Automation > Window Control condition • Mouse • OCR • Screen
<p>Support for function keys in Terminal Emulator package</p> <p>Function keys (F1 through F24) are now supported to automate processes using ANSI and VT100 terminals in the Terminal Emulator package.</p>

New features
<p>Use regex case insensitive flag for Window title</p> <p>Enable the regex Case insensitive flag to identify a Window title field as not case-sensitive. This feature enables you to successfully run the bots even if the letter case does not match the captured window title.</p> <p>The following packages and actions support this feature:</p> <ul style="list-style-type: none"> • Wait • Image Recognition • Simulate keystrokes • Mouse > Click action • Legacy Automation Desktop > Manage windows controls • OCR > Capture window, Capture area • Screen > Capture window, Capture area • Recorder > Capture • Window: Activate, Close, Maximize, Minimize, Resize

Automation Anywhere Robotic Interface (AARI)

New features
<p>New AARI on the web package</p> <p>Use the AARI on the web package to perform actions such as assign, query, and cancel tasks; create and query requests; and retrieve a list of team members.</p> <p>AARI Web package</p>
<p>Filter by time</p> <p>You can now filter your requests and tasks by time:</p> <ul style="list-style-type: none"> • Requests tab: Use the Created and Updated options in the Filter window to select any dates. • Tasks tab: Use the Task created and Task updated options in the Filter window to select any dates. <p>Filter and search for a request Filter and search for a task</p>
<p>View updated dates</p> <ul style="list-style-type: none"> • Use the new Updated column in the Requests tab to view the dates and time of a request that was last updated. • Use the new Task Updated column in the Tasks tab to view the date and time of a task that was last updated.
<p>Variable options</p> <p>In the Insert a variable window, the Variable field now shows child elements of available references, which include Dictionary, List, Record, and Table variable types.</p>

New features
<p>Delete a request</p> <p>AARI administrators, managers, and users can now delete requests created by the AARI process. The AARI administrator can delete any requests. AARI managers can delete requests of the team for which they are the owner. AARI users can delete only the requests they have created.</p> <p>Delete a request</p>
<p>Automatically assign managers and users</p> <p>Users can now select the Auto assign this task option in the Human Task to assign managers or users to the task. Users can also select the Auto assign the target task to option in the Go to element to assign managers to the task.</p> <p>Create an AARI process</p>

Discovery Bot

New features
<p>Access Discovery Bot capabilities in Community Edition</p> <p>Discovery Bot is now available in the Community Edition and the free trial version. Log in to the Control Room and click the Discovery Bot tab on the left panel to get started.</p> <p>The available limits to create processes, recordings, views, and opportunities are displayed on the respective page. Create any number of bots and download a PDD for your personal use as required.</p> <p>A single Community Edition user is a multi-role user with Admin plus Business user plus Analyst permissions.</p> <p>Get started with Discovery Bot</p>
<p>Use Model option for system-generated views</p> <p>You can now use the Model option to compare and find the best aggregated view for your recordings. Use this option to save as many views with different combinations as required.</p> <p>You can also save the view as a manual view to further customize your view and compare side-by-side. Select either an Easy or Strict model so that you can view recordings where the steps are the same versus recordings with different results with more branches in the process path.</p> <p>Create a process view with branches and opportunities</p>
<p>Use Filter option for system-generated views</p> <p>You can now use the Filter option to use a set of values to compare different sections of a process across various recordings by selecting a specific path and step filter. Used along with the Model option, the path and step filter options for a system-generated or manual view can help you to determine and decide on a good candidate for automation.</p> <p>Create a process view with branches and opportunities</p>
<p>Use toggle frequency counter option for system-generated views</p> <p>You can now use the toggle frequency counter to display the number of recordings that a particular path takes in the flow in a system-generated view. Use this option to help you understand the frequency of the path compared to other recordings or views.</p> <p>Create a process view with branches and opportunities</p>

New features
<p>Remove recording screenshot for data privacy</p> <p>Use the Screen option (icon) to display or hide the recording screenshot before submitting the recording for the analyst to review. Use this option when you do not want to share personal image details with the analyst.</p> <p>Record a Discovery Bot business process</p>
<p>Download PDD from the Opportunities table</p> <p>You can now download a process definition document (PDD) for an opportunity directly from the Opportunities table listed on the Opportunities page. The PDD is automatically generated when the opportunity is created. After the PDD is generated, the field changes from generating PDD to Download PDD. You can then download and save the document.</p> <p>Review opportunities and convert to bot</p>

Bot Insight

New features
<p>Access Bot Insight data from Tableau</p> <p>Use the Tableau connector in Bot Insight to access business and operational information. The Tableau connector connects to the Bot Insight APIs to create various business and operational metrics that you can analyze and visualize within Tableau.</p> <p>Configure Tableau web data connector in Bot Insight</p>

Supported packages

Package	Version
Application	2.1.0-20201112-22332
App Integration	2.3.0-20201210-171315
Active Directory	2.1.0-20201112-223323
Boolean	2.1.0-20201126-165109
Browser	2.3.0-20201211-222811
Clipboard	2.1.0-20201126-165124
Comment	2.3.0-20201126-165125
CSV/TXT	2.3.0-20201126-165126
Database	2.2.0-20201112-223343
Data Table	2.5.0-20201201-130615
Datetime	2.2.0-20201126-165136
Delay	2.2.0-20201126-165137
Dictionary	3.2.0-20201126-165138

Package	Version
Run DLL	3.3.0-20201126-165850
Email	3.2.0-20201120-062604
Error handler	2.3.0-20201126-165148
Excel basic	2.4.0-20201126-165604
Excel advanced	5.3.0-20201208-090251
File	3.2.0-20201126-165151
Folder	3.1.0-20201126-165154
FTP / SFTP	2.2.0-20201115-072759
Image Recognition	2.2.0-20201117-081754
JavaScript	2.4.0-20201126-165412
Simulate keystrokes	2.5.0-20201112-223902
Legacy Automation	3.2.0-20201124-064544 1.5.0-20201125-004358
List	2.2.0-20201126-165427
Log To File	2.2.0-20201126-165428
Loop	2.1.0-20201126-165429
Message Box	2.1.0-20201126-165430
Mouse	2.2.0-20201112-223917
Number	2.1.0-20201126-165444
OCR	2.3.0-20201126-081210
Office 365 Excel	2.2.0-20201104-062559
Office 365 Calendar	2.1.0-20201111-162101
Office 365 OneDrive	2.2.0-20201126-165550
PDF	2.6.0-20201126-165555
PGP	2.2.0-20201126-165557
Ping	2.1.0-20201126-165559
Play Sound	2.1.0-20201127-115706
Prompt	2.2.0-20201109-192507
Python Script	2.4.0-20201208-064944
Recorder	2.10-20201215-211402
REST Web Service	3.2.0-20201112-224735
SAP	2.2.0-20201126-165852
Screen	2.2.0-20201126-165855
SNMP	2.1.0-20201126-165859

Package	Version
SOAP Web Service	3.2.0-20201123-093411
String	3.1.0-20201126-165909
System	3.0.0-20200921-090225
Terminal Emulator	3.6.0-20201213-084139
VBScript	2.4.0-20201208-065526
Wait	3.1.0-20201126-165922
Window	2.3.0-20201123-093430
Workload	2.1.0-20200825-071644
XML	2.1.0-20201126-165927

Community Edition A2019.17 Release Notes

Release date: 13 November 2020

Review the new features and supported packages in the Community Edition A2019.17 (Build 7103) release. IQ Bot is on Build 7082.

- [Community Edition A2019](#)
- [AARI](#)
- [IQ Bot](#)
- [Bot Insight](#)
- [Supported packages](#)

Community Edition A2019

Bot agent update: This release includes a required update to your . Ensure that you complete the update to continue with your automation activities when upgrading from a previous release to this release.

[Automatically update the Bot Agent](#) | [Manually update the Bot Agent](#)

New features
<p>Connect to EWS server with OAuth authentication</p> <p>A new authentication is available for the Exchange Web Services (EWS) protocol with OAuth. You can use the OAuth authentication and enable your EWS-managed API applications to access Exchange online in Office 365.</p> <p>Using Connect action for Email</p>
<p>VT220 terminal type supported in Terminal Emulator</p> <p>To establish a connection and communicate with another machine, you can now use the VT220 terminal for sending and receiving text.</p> <p>Using Connect action for Terminal Emulator</p>

New features
<p>Enhancements to the Recorder</p> <ul style="list-style-type: none"> Record a task using the Universal Recorder or AISense Recorder from a single point of entry. Both recorders are now managed through a single package, which enables faster and more efficient updates. You can now record tasks in a Microsoft Edge browser that runs on Chromium (versions 79 and later). Use the AISense Recorder Define option to capture an object that is only visible when you hover the mouse over the object. Use the Resize window option in the Recorder > Capture action to set the window width and height. <p>This option delivers a more reliable bot. It resizes the window to the dimensions at which the task was recorded, thus increasing the likelihood that the bot identifies the target object.</p> <p>Get started with recorders Universal Recorder supported applications and browsers Using the Capture action</p>
<p>Use shared session in Terminal Emulator</p> <p>Use the new Shared session option to pass the exact state of an application to a concurrently occurring TaskBot or MetaBot logic. For example, instead of connecting to the same application multiple times for different tasks, you can use the option to connect to the application using a single task, thus optimizing your automation logic in the long run.</p> <p>Share session between TaskBot logic</p>
<p>Share an Excel session between bots</p> <p>Use the Set session action from the Excel basic or Excel advanced package to assign an Excel session to a variable, and then pass that variable from a parent to a child bot. This enables the child bot to access the worksheet opened in the parent bot.</p> <p>Excel basic package Excel advanced workbook operations Example of sharing an Excel session between bots</p>
<p>New option for Run Task</p> <p>In the Task Bot package, you can now use the Run action with an option to repeat the selected task until you choose to stop it.</p>
<p>New search for roles in User Management API</p> <p>Use the new <code>Search for roles</code> API in the User Management APIs in Swagger to obtain a list of all the roles or details for a specific role.</p> <p>List roles</p>
<p>Capture response status of REST API</p> <p>In the REST Web Service package, you can capture the response status of the REST API in the dictionary variable. The dictionary variable now shows the response key with its value.</p>
<p>New option for REST Web Service (Service Cloud case ID: 00489741, 00646436)</p> <p>Use the Capture failure response action in the REST Web Service package to capture response details in the response body.</p>

New features

Use regular expressions in packages

You can use regular expressions (regex) in certain actions to support pattern-based search in a file, folder, or Windows title. Regular expressions are supported in the actions of the File and File and Folder packages such as **Copy**, **Delete**, **Rename**, **Print Multiple files**, and **Zip**.

You can also use regular expressions in some packages that support the wildcard character in their window titles.

The following packages and actions support regular expressions:

- Wait
- Image Recognition
- Simulate keystrokes
- Mouse > **Click** action
- Legacy Automation > **Manage windows control**
- OCR
- Screen
- Recorder > **Capture**
- Run DLL > **Run function (Legacy)**, **Run function**
- Window: **Activate**, **Close**, **Maximize**, **Minimize**, **Resize**

[Using Copy Desktop file action for file](#) | [Using the Capture action](#)

Support for overloaded functions in DLL package

The **DLL > Run function** action can now handle `.dll` files that contain multiple functions of the same name. The action calls the function based on the number of parameters passed.

[Using the Run function action](#)

New actions for SAP captured objects

Use new actions that are available for **Tree**, **Tab**, and **Label** controls to perform operations for the various objects captured from an SAP application.

[Recorder actions supported in various SAP versions](#)

Store multiple lines of text in a string variable

You can use a string variable containing multiple lines of text in the following actions:

- **String > Assign**
- **String > Extract text**
- **String > Compare**
- **String > Lowercase**
- **String > Replace**
- **String > Reverse**
- **Log to file**
- **Message box**
- The string condition in the **If**, **Wait**, and **While** actions

New features**Arabic, Japanese, and Russian characters supported in variable names**

You can now create variables with names containing Arabic or Russian characters, or Japanese double-byte numbers.

[Unicode range supported in variables](#)

Automation Anywhere Robotic Interface (AARI)

New features**View previous selected tasks**

AARI users can now reference selected actions of their tasks. When they view a submitted task in request view, a check mark indicator is now displayed next to the buttons that are selected.

Run a process in private workspace

You can now run a process in your private workspace by using the **Run** option in the process editor. The bots in the process are then executed on the default device of the Bot Creator.

[Configure processes](#)

Use variables types

You can now use new variables in the process editor such as **createdOn** and **updatedOn** (DateTime), **id** (Number), and **title** (String). These variables are part of a data flow (workflow engine) that moves data between each step of a process and requires variable input for the process to run properly.

[AARI variable types](#)

Use the Data Privacy tag field

The **Data Privacy tag** enables users to generate hidden custom output in their process tasks (**Start** panel, **Human Task**, and **Bot Task**). Users can enter the variables for this field during runtime with values. In the web portal, the AARI admin can use this tag to check for requests or tasks by using personal user data. The admin can also filter using this field.

[Create an AARI process](#) | [Filter and search for a request](#) | [Filter and search for a task](#)

IQ Bot

New features	
<p>Support for Arabic language</p> <p>When creating a learning instance, you can now choose the Arabic language from the Primary language of documents drop-down menu, with the following limitations:</p> <ul style="list-style-type: none"> • Advance table extraction is not available. • Search field on the <i>Validator</i> is not supported. • Arabic numerals are not supported. <p>For example, if the document has date or time in Arabic language, it is extracted as text and validations can fail.</p> <hr/> <p>Note: You can still use string-based validation checks (such as regular expressions) for Arabic numerals.</p> <hr/> <ul style="list-style-type: none"> • Arabic is only supported on ABBYY FineReader Engine 12.4. <p><i>Creating a learning instance</i></p>	
<p>Default validations for a group</p> <p>When editing a learning instance, you can now use the Select the default validations group drop-down menu to select an available group. This allows all the new group documents in production to be extracted based on the custom logic and validations defined in this selected group, before it goes to the Validator.</p> <p><i>Edit a learning instance</i></p>	

Fixed features	
Service Cloud case ID	Description
-	You can now create and edit a bot even if a document associated with a deleted bot appears in production. Previously, if a bot was deleted and a document associated with it appeared in production, you could not create a new bot.

Bot Insight

New features
<p>New AARI dashboard in Bot Insight</p> <p>Use the AARI dashboard to view various widgets that provide information about requests created from published processes in AARI. The dashboard also provides statistics on the status of created requests.</p> <p><i>AARI dashboard</i></p>

Supported packages

Package	Version
Application	2.1.0-20200921-085720
App Integration	1.1.0-20201014-042506
Analyze	2.2.4-20200903-113949
Active Directory	2.1.0-20200921-085716
Boolean	2.1.0-20201014-042509
Bot Migration	2.5.0-20200902-045043
Browser	2.1.0-20201002-123733
Clipboard	2.1.0-20201014-042520
Comment	2.2.0-20201014-042520
CSV/TXT	2.3.0-20201014-082525
Database	2.2.0-20201013-052941
Data Table	2.3.0-20201030-143334
Datetime	2.2.0-20201014-042531
Delay	2.2.0-20201014-042532
Dictionary	3.2.0-20201014-042532
Run DLL	3.2.0-20201105-205159
Email	3.1.0-20201104-062204
Error handler	2.2.0-20201014-042541
Excel basic	2.3.0-20201027-160012
Excel advanced	5.1.0-20201027-155758
File	3.1.0-20201016-065515
File & folders	1.1.0-20201023-202725
Folder	3.0.0-20201016-065517
FTP / SFTP	2.1.0-20200921-085757
IF/ELSE	2.1.0-20200921-085758
Image Recognition	2.1.0-20201014-042552
Interactive forms	2.17.3-20201102-103733
IQ Bot	2.1.0-20201013-095304
JavaScript	2.3.0-20201104-062431
Simulate keystrokes	2.4.0-20201021-163833
Legacy Automation	3.2.0-20201104-062439 1.3.0-20201105-151906

Package	Version
List	2.2.0-20201014-042806
Log To File	2.2.0-20201014-042806
Loop	2.1.0-20201014-042808
Message Box	2.1.0-20201014-042808
Migration	2.7.0-20201106-072418
Mouse	2.1.0-20201014-042814
Number	2.1.0-20201014-042823
OCR	2.2.0-20201104-062503
Office 365 Excel	2.2.0-20201104-062559
Office 365 Calendar	2.1.0-20200921-085726
Office 365 OneDrive	2.1.0-20201014-042924
PDF	2.5.0-20201014-042929
PGP	2.2.0-20201014-042931
Ping	2.1.0-20201014-042932
Printer	2.1.0-20200921-090131
Play Sound	2.1.0-20200921-090123
Prompt	2.1.0-20200918-081201
Python Script	2.3.0-20201105-204912
Recorder	2.0.9-20201105-164103
REST Web Service	3.1.0-20200928-231420
SAP	2.2.0-20200921-090209
Screen	2.1.0-20201014-043037
SNMP	2.1.0-20201014-043041
Service	3.0.0-20200921-090214
SOAP Web Service	3.1.0-20200921-090219
String	3.1.0-20201014-043052
System	3.0.0-20200921-090225
Task	2.0.1-20201023-202703
Terminal Emulator	3.4.0-20201028-021451
Trigger Email	1.1.0-20201105-152220
VBScript	2.3.0-20201105-205228
Wait	3.1.0-20201014-043117
Window	2.2.0-20201022-121649
Workload	2.3.0-20201105-205233

Package	Version
XML	2.1.0-20201014-043121

Automation 360 Sandbox Release Notes

Important: We have moved the contents for Automation 360 v.26 release for the sandbox environment to this page: [Automation 360 v.26 Release Notes](#).

Related concepts

[Automation 360 Release Notes](#)

Review the new capabilities, changes, fixes (resolved issues), security fixes, deprecated features, and limitations in each release.

[Community Edition Release Notes](#)

Review the new capabilities in different Automation 360 Community Edition releases.

Sandbox environment

The sandbox environment for Automation 360 Cloud enables you to test your production bots to ensure that these bots work seamlessly in your production environment. Use the sandbox environment to help plan and test new features for upcoming Automation 360 releases.

The sandbox environment is the same as any Automation 360 Cloud instance but includes updates from the upcoming new release at least 3 weeks before Automation Anywhere Cloud is updated.

Note: The sandbox environment should not be used as your production environment.

IQ Bot is not included in the sandbox environment.

The following image shows how a new build is tested in the sandbox environment before it is pushed to the production environment.

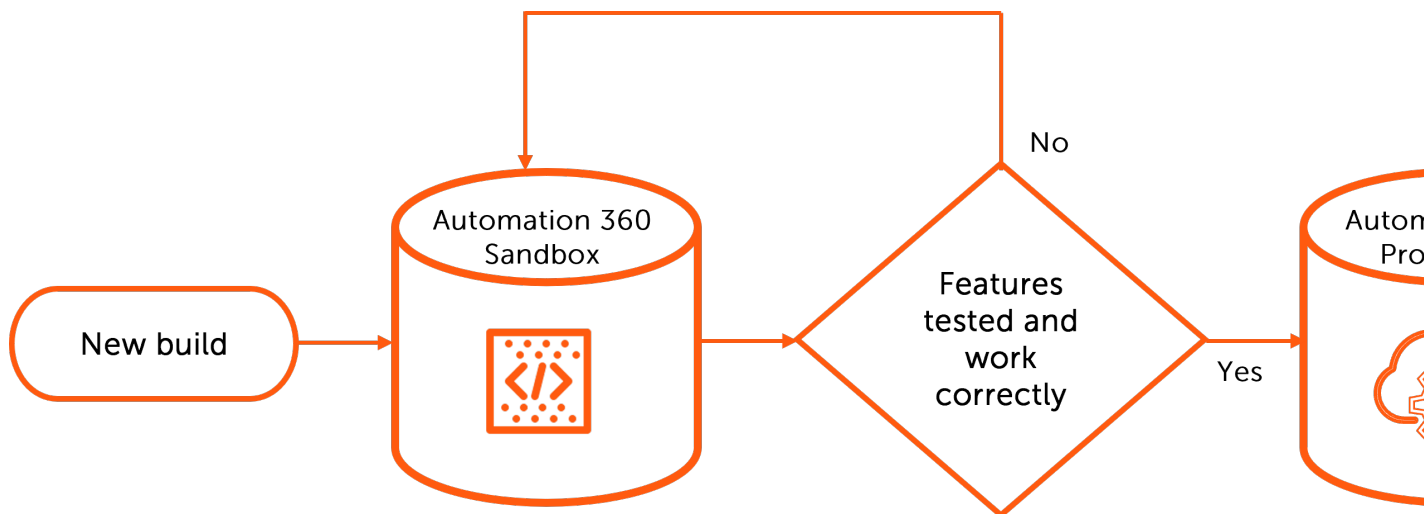

Benefits

The environment provides the following benefits to the Automation 360 Cloud customers:

- Test new features and identify any changes that might be required in your current bots.
- Preview upcoming features and enhancements.
- Better plan and manage changes for the upcoming update to your environment.

The sandbox environment is available only for Automation 360 cloud and cloud-enabled deployments. The environment is not supported for a Control Room in a data center that is hosted by you or a third-party vendor. The environment includes upcoming updates for Automation 360, Discovery Bot, AARI, and Bot Insight.

Prerequisites

- You must have a valid Automation 360 Cloud license to use the sandbox environment.
- You must purchase an orderable sandbox SKU.

Contact your Customer Success Manager (CSM) or Partner Enablement Manager (PEM) for more details.

Configure the environment

Perform the following tasks before you start using the environment:

1. De-allocate some of the licenses from your existing Automation 360 instances and allocate these licenses to the sandbox environment.
2. *Switch Bot Agent to the sandbox environment.*
3. Create the required users, roles, and other Automation 360 Cloud entities in the environment:
 - *Create a user*
 - *Create a role*
 - *Credentials and lockers in the Credential Vault*
4. *Export bots from your existing Automation 360 Cloud.*
5. *Import the exported bots to the sandbox environment using Bot Lifecycle Management.*

Automation 360 Package SDK Release Notes

Review the new, changed, fixed, and deprecated features, and security fixes, known issues, and limitations for the Automation 360 (formerly Enterprise A2019) Package SDK.

Enhancements to Automation 360 v.27

Feature	Description
Added new annotations	<p>Added documentation_url and tutorial_url in CommandPkg.</p> <ol style="list-style-type: none"> documentation_url - Use this to add a documentation link to an action. tutorial_url - Use this to add a video tutorial link to an action. <p>For example:</p> <pre>@CommandPkg (node_label = "[[CMtoINCH.node_label]]", label = "[[CMtoINCH.label]]", description = "[[CMtoINCH.description]]", name = "CMtoInch", icon = "ruler_icon.svg", documentation_url = "https://example.com/doc/ CMtoINCH.html", tutorial_url = "https://example.com/ tutorial/CMtoINCH.html", minimum_controlroom_version = "13980", minimum_botagent_version = "21.210")</pre>

[A360-package-sdk-2.6.1.zip](#)

Enhancements to Automation 360 v.25

Feature	Description
Added default session_value	Added default_session_value in CommandPkg to set up the default value for global session.

[A360-package-sdk-2.5.0.zip](#)

Enhancements to Automation 360 v.23

Feature	Description
Log4j version	Log4j version upgrade to 2.17.1.

[A360-package-sdk-2.4.1.zip](#)

Enhancements to Automation 360 v.22

Feature	Description
Rebranded the package name	The package name is rebranded from A2019 to A360 .
Added return settings	Added return settings for CommandPkg to decide the setting or configurations related to the return type of the command.
Added a new annotation	Added a new annotation for SessionObject to indicate that the session object is passed to the command.
Added a new annotation	Added a new annotation for SessionAllowNonExistent to indicate that a non-existing session can be passed to the command.
Added a new attribute type	Added a new attribute type BAPIOBJECT that works with the control type named BAPIWORKFLOW with the following three tables. <ul style="list-style-type: none"> • Import • Export • Table
Added multiple return settings	Added multiple return settings in CommandPkg to return multiple values from the command.
Runtime library updates	Bundled the latest bot runtime libraries.

[A360-package-sdk-2.3.0.zip](#)

Enhancements to Automation 360 v.21

Feature	Description
Added a new annotation	Added the new annotation for the Control Room and the Bot Agent.

Feature	Description
Added a new annotation	Added the new annotation for the credential password (@CredentialAllowPassword).
Added a new example	Added the new example at: <code>botcommand/samples/commands/basic/types</code> , called CredentialTypeDemo.java file.
Added a new annotation	Added the new annotation to support the Trigger3 interface.
Updated trigger examples	Updated trigger examples to support the Trigger3 interface.
Runtime library updates	Bundled latest bot runtime libraries.

[A2019-package-sdk-2.1.0](#)

Enhancements A2019.20

Feature	Description
Runtime library updates	Bundled latest bot runtime libraries.

[A2019-package-sdk-2.0.9](#)

Enhancements to Enterprise A2019.19

Feature	Description
Runtime library updates	Bundled latest bot runtime libraries.
Added annotation rule	Added the <code>MultipleRecordPicker</code> annotation rule.
Added annotations	Added annotations for desktop operation stages.

[A2019-package-sdk-2.0.8](#)

Enhancements to Enterprise A2019.18

Feature	Description
Runtime library updates	Bundled latest bot runtime libraries.
Added shared session	Added support for shared sessions.
Enhanced property creation	Now properties can accept one parameter.
Added rule for WindowResize and WindowBrowser	Added a new rule for WindowResize and WindowBrowser.

Feature	Description
Non-essential dependencies in the <code>build.gradle</code> are commented out	Non-essential dependencies in the <code>build.gradle</code> are now commented out. Enable it to compile the Package SDK samples.

[A2019-package-sdk-2.0.7](#)

Enhancements to Enterprise A2019.17

Feature	Description
Runtime library updates	Bundled latest bot runtime libraries.
Added author name in custom packages	Added support to add the author name in the vendor column of custom packages.
Added File2 attribute	Added the new attribute type File2.
Added File Type rule	Added the new rule File Type.

[A2019-package-sdk-2.0.6](#)

Enhancements to Enterprise A2019.16

Feature	Description
Runtime library updates	Bundled latest bot runtime libraries.
Added NoLogging	Added NoLogging support.

[A2019-package-sdk-2.0.5](#)

Enhancements to Enterprise A2019.15

Feature	Description
Runtime library updates	Bundled latest bot runtime libraries.

[A2019-package-sdk-2.0.4](#)

Enhancements to Enterprise A2019.14

Feature	Description
Desktop operations	Added desktop operations support.
Samples for actions in the download file	Added additional samples for actions in the Package SDK download file.

Feature	Description
Runtime library updates	Bundled latest bot run-time libraries.

[A2019-package-sdk-2.0.3](#)

Enhancements to Enterprise A2019.13

Feature	Description
Time validation for locales	Added compile time validation for locales JSON file.
Entry list	Added support for ENTRYLIST
Runtime library updates	Bundled latest bot runtime libraries.

[A2019-package-sdk-2.0.2](#)

Enhancements A2019.12.1

Feature	Description
Trigger samples	Added trigger samples in the Package SDK download file. Download the latest Package SDK to access the sample files.

[A2019-package-sdk-2.0.1.zip](#)

Enhancements to Enterprise A2019.12

Feature	Description
Runtime libraries	Added the latest runtime libraries.
Custom trigger	Creating custom triggers is supported in this release.
Sample	We added more code samples.
HierarchyDemo.java code example added to package documentation. (Service Cloud case ID: 00469066)	Create a simple action with multiple choices. The UI differs based on the options selected.

[A2019-package-sdk-2.0.0.zip](#)

Enhancements A2019.11

Feature	Description
Runtime libraries	This package contains the latest runtime libraries.

[A2019-package-sdk-1.0.11.zip](#)

Enhancements to Enterprise A2019.10

Feature	Description
Updated annotation support	Added new attributes annotation support.
Improved bundling of SDK	Bundled java doc inside package SDK zip. You only need to download one zip file now.
Runtime libraries	Bundled latest bot runtime libraries.
More examples	Added new examples inside zip.
Datatypes	Added new datatypes.

[A2019.10-package-sdk-1.0.0.zip](#)

Note: All the components for the Package SDK are included in a single zip file starting with the A2019.10 release.

Enhancements to Enterprise A2019.09

Feature	Description
Bot runtime libraries	Bundled latest bot runtime libraries for A2019.09 Package SDK.

- SDK Demo Package: [A2019.09-packageSDK-1.0.0.zip](#)
- Documentation: [A2019.09-package-annotations-javadoc.zip](#)

Enhancements to Enterprise A2019.08

Feature	Description
Bot runtime libraries	Bundled latest bot runtime libraries for A2019.08 Package SDK.
Properties support	Extended support for properties.
Comments expanded and improved	Added more comments to sample commands to help use SDK.

Feature	Description
Comment field formatting	Added text color and background color to comment fields.

- SDK Demo Package: [A2019.08-packageSDK-1.0.0.zip](#)
- Documentation: [A2019.08-package-annotqations-javadoc.zip](#)

Enhancements A2019.07

Feature	Description
Bot runtime libraries	The A2019.07 bot runtime libraries are bundled in the SDK package.
CREDENTIAL attribute	We provide support for credential attributes that require input from action screens.
Localized error messages and actions UI text	Enables developing packages with i18n error messages and localized (l10n) actions UI with localized text.
Java Development Kit 11	The A2019.07 Package Development Kit supports JDK 11.

- SDK Demo Package: [A2019.07-Package-Sdk-1.0.0.zip](#)
- Documentation: [A2019.07-package-annotations-javadoc.zip](#)

Process Discovery Release Notes

Review the new features and improvements in each release.

Use the links to view the release notes updates for each release.

Process Discovery Version 1.60.0 Release Notes

Review the new features and fixes available in this release.

Release Date: [10-January-2023](#)

For information related to features and fixes in previous Process Discovery releases, see the PDFs for these releases: [Process Discovery documentation \(release versions\)](#).

Features

For Kibana and Process Discovery users, the observer activity log data is automatically generated and synchronized across all environments in the Canada, United Kingdom, and Australia regions.

From the **Mining Runs** page, you can select users that have created mining runs using the **Created By** field. The **Created By** field is available from the **Filters** button. You can select multiple users from the drop-down, and the filter displays a list of all applicable users by first and last name.

Fixes

From the **Events** page, you can use the Filter option to apply the **Observed At** rule for any date in the date field without errors. Previously, when you selected the **Observed At** rule, the pre-filled date would not apply to the filter if the date picker was not open, and a date was not selected.

When you access the platform to log in, you are redirected to the Process Discovery platform. When attempting to redirect to a personal website, we added the URL to a list of domains that are allowed for safeguarding.

From the **Application Strategy** page, you can rename merged signatures. Previously, if you edited a provisional signature, renamed the signature, and then selected merge signatures to have the name be the same, it would not use the new name.

From the **Instances Viewer** page, you can export the selected instance with the correct data. Previously, if you selected a path from the **Paths** button, any path was selected at random and exported.

From the **Observers** page, you can enable and then disable an observer's recording from the Actions menu by selecting, **Automatically Record New Observers For This User**, and the disabled state is displays correctly with a red dot. Previously, when you selected **Automatically Record New Observers For This User**, and then disabled the recording by selecting **Do Not Automatically Record New Observers For This User**, the enabled state (green dot) did not update correctly to the disabled state (red dot).

From the **Signature Service Jobs** page, the sorting of signature service jobs using the TYPE column is no longer supported.

Neo Sensor Version 2.4.1

Review the new feature and fixed issues available in this release.

Release Date: 18-November-2022

Feature and Fixed issues

Contact your Customer Success Manager (CSM) or Partner Enablement Manager (PEM) for the latest version. For information related to features and fixes in the previous Neo Sensor release, see the PDFs for these releases: [Process Discovery documentation \(release versions\)](#). Neo Sensor Version 2.4.1 includes the following updates:

Feature

You can now adjust the Neo Sensor debug level, and the log will contain more details regarding the screenshots taken by the application. For example, the **Area of Interest** screenshot size and actions is detailed in the log. To adjust the debug level, set the debug value to one of the following in the NeoConfig json configuration file:

- Set DEBUG to 1 in the installer.
- Set Debug to 1 in the registry.
- Set debug to 1 in the NeoConfig json configuration file if running in portable mode.

Fixed issues

For Observer Users that have a multi-monitor setup and the **ScreenFullCapture** setting is disabled, you can now view the screenshot taken on the correct monitor. Previously, only the Primary monitor was used in making the comparison between the screenshot taken and the desktop size.

You can now use two different methods to determine where an application's screen is located. You can adjust the SCREEN_FETCH_METHOD in the installer, ScreenFetchMethod in the registry, or screenFetchMethod in the NeoConfig json configuration file if running in portable mode with one of these values:

- 1 (default value) will use the center of the active window to determine the position.

- 2 will use the active windows reported handle from Microsoft Windows.

CoE Manager Release Notes

Review the CoE Manager feature available in Automation 360 v.26 release.

Introduction

Use CoE Manager - powered by Shibumi to scale your automation programs more quickly and efficiently. CoE Manager provides visibility into your end-to-end automation lifecycle and accelerates pipeline generation. It provides a consistent way of assessing automation opportunities which helps in minimizing the variations and maximizing the ROI.

CoE Manager is available out of the box and requires minimal configuration for first-time use.

Automation Anywhere Enterprise compatibility

Automation 360: The Control Room can be a Cloud or On-Premises deployment.

CoE Manager.

Automation 360 feature comparison matrix

Use the feature comparison matrix to compare the Automation 360 features with the features in Automation Anywhere Enterprise 11.3.x and Enterprise 10 versions.

For details on latest features and enhancements, see Automation 360 release notes.

Core components

	Automation 360	Enterprise 11.3.x	Enterprise 10.x
Target user	Citizen Developer Specialist/RPA Developer IT	RPA Developer IT	RPA Developer IT
Delivery model	On-Premises Cloud Cloud-enabled	On-Premises	On-Premises BotFarm (for Bot Runners)
Operating system	Microsoft Windows Linux (Linux CentOS 7.7, 7.9, and 8.3) and (Red Hat Enterprise Linux 7.7, 7.9, and 8.3) (Operating system not applicable for Cloud)	Microsoft Windows	Microsoft Windows

	Automation 360	Enterprise 11.3.x	Enterprise 10.x
Microsoft Active Directory support	Available	Available	Available
SAML 2.0	Available	Available	Not available
Authenticated proxy support	Available	Not available	Not available
Localized user interface (UI)	15 plus languages	3 languages	Not available
Bot Insight support	Available	Available	Available (Basic)
IQ Bot support	Available	Available	Available (Basic)
Interactive forms (attended automation) support	Available	Not available	Not available
Bot Creator platform	On premises thin client	Thick client	Thick client
Bot Runner platform	Web-deployed	Thick client	Thick client
Attended bots	Available	Available	Not available
Unattended bots	Available	Available	Available
Upgrade to use new actions or commands	No upgrade required for Cloud Upgrade required for On-Premises and Cloud-enabled	Upgrade required	Upgrade required
Automated queuing for job	Available	Available	Not available
Centralized licensing	Available	Available	Available
High availability	Available	Available	Available
Load balancing	Available	Available	Available
Disaster recovery	Available	Available	Available
Multi-domain support	Available	Available	Available
Hosting technology	Java	<ul style="list-style-type: none"> Java (Control Room) Microsoft .NET Framework (Enterprise Client) 	Microsoft IIS
Role-based access	Available	Available	Available
Power BI	Available	Not available	Not available
Tableau connector for Bot Insight	Available	Not available	Not available

	Automation 360	Enterprise 11.3.x	Enterprise 10.x
Version Control	Available through Git integration (Subversion is deprecated)	Available through Subversion integration	Available through Subversion integration
SysLog integration	Available	Available	Not available

Control Room server capabilities

Feature	Automation 360	Enterprise 11.3.x	Enterprise 10.x
Version control - Set production version	Available	Available	Available
Version control - Compare two versions of a bot	Available	Available	Available
Version control - Check version history	Available	Available	Available
Version control - Roll back to previous version	Available	Available	Available
Multi or two factor authentication	Available (through SSO)	Available (Native and through SSO)	Not available
Banner text on Control Room login	Available	Available	Not available
Install Control Room on Oracle Database	Available	Available	Not available
Audit log	Available	Available	Available
Open web page in a new or existing tab of Internet Explorer	Available	Available	Available
Open web page in a new or existing tab of Google Chrome	Available	Not available	Not available
Setting for new login session in Control Room	Deprecated	Available	Not available
Configure API keys duration	Available	Not available	Not available
Configure email verification on user creation	Available	Available	Not available
Enable debug logging	Available	Available	Not available

Bot development

Feature	Automation 360	Enterprise 11.3.x	Enterprise 10.x
In-product learning	Available	Not available	Not available
Bot Creator Flow view	Available	Not available	Not available
Bot Creator Dual view	Available	Not available	Not available
Bot Creator Code view	Available	Available	Available
Bot Creator Visualize view	Not available	Available	Available
Actions search	Available	Not available	Not available
Text search	Available	Available	Available
Advanced expressions	Available	Limited availability	Limited availability
Regular expressions	Available	Available	Available
Remote device testing	Available (Develop on one device and test on another device)	Not available	Not available
Localized actions	Available	Not available	Not available
Collaborative development	Available	Not available	Not available
Bot Store integration	Available	Available (Version 11.3.3 and later)	Not available
Email triggers	Available	Available	Available
File and folder triggers	Available	Available	Available
Hot-key triggers	Available	Available	Available
User Interface triggers	Available	Not available	Not available
Performance triggers	Not available	Available	Available
Process triggers	Available	Available	Available
Service triggers	Available	Available	Available
Windows triggers	Available	Available	Available
MetaBot Logic	Available through TaskBot	Available	Available
MetaBot DLL	Available through DLL: Run function action	Available	Available
MetaBot Screen recalibration	Not available	Available	Available
Bot Lifecycle Management - Import and export bots	Available	Available	Not available

Feature	Automation 360	Enterprise 11.3.x	Enterprise 10.x
Global values	Available	Not available	Not available
Bot cloning	Available	Not available	Not available
API deployment	Available	Available	Not available
Bot Runner sessions in Control Room	Available	Available	Available
Packaging Bot dependencies	Available	Available	Available
Bypass legal disclaimer	Available	Available	Available
Edit variable name	Available	Available	Available
Copy commands from one bot to another	Available Triggers option is not available.	Available	Available
Save bot as XML/TXT	Not available	Available	Available
Disable mouse and keyboard for the bot	Not available	Available	Available
Run bot in stealth mode	Not available	Available	Available
Show or hide errors while running a bot.	Not available (Deprecated for Automation 360)	Available	Available
Copy variables from one bot to another	Available	Available	Available
Cross domain iFrame support in browsers.	Available Supported in Google Chrome and Microsoft Edge.	Available Supported in Internet Explorer.	Available Supported in Internet Explorer.

Bot extensibility and code reuse

Feature	Automation 360	Enterprise 11.3.x	Enterprise 10.x
Custom actions in palette	Available (build using Package Development Kit)	Not available	Not available
Inline scripting	Available in Python, VBScript, and JavaScript	Available in VBScript	Not available
Code reuse	Available for TaskBots, custom actions, and DLLs	Limited availability for MetaBots and DLLs	Limited availability for MetaBots and DLLs
Quick map for variables	Available	Available	Available

Feature	Automation 360	Enterprise 11.3.x	Enterprise 10.x
Bot timeout	Available	Available	Available
Bot priority	Available	Available	Available
Share DLL session	Available	Not available	Not available
Run bot reusing the configuration of the past run from Historical page	Available	Available	Not available

Integration capabilities

Feature	Automation 360	Enterprise 11.3.x	Enterprise 10.x
Callouts using inline scripting	Available for Python, VBScript, and JavaScript	Not available	Not available
Control Room APIs	Available	Available	Not available
REST Web Service	Available	Available	Available
SOAP Web Service	Available	Available	Available

Device utilization capabilities

Feature	Automation 360	Enterprise 11.3.x	Enterprise 10.x
Workload management	Available	Available	Not available
Device pools	Available for scheduling and workload management	Available in workload management only	Not available
Run-as users pool for automations	Available Set up multiple run-as users for device pools to provide effective license and device utilization	Not available	Not available
Background processing	Available	Not available	Not available
Non-persistent virtual desktop infrastructure (VDI)	Available	Available	Available

Recorder capabilities

Feature	Automation 360	Enterprise 11.3.x	Enterprise 10.x
AI Sense Recorder	Available	Available	Not available
Unified Recorder	Available (includes support for Microsoft Edge Chromium) <ul style="list-style-type: none"> Pattern-based data extraction is not available Legacy Microsoft Edge and Flash/Flex are deprecated 	Not available (Recording capabilities through Web Recorder, Smart Recorder, and Standard or Screen Recorder)	Not available (Recording capabilities through Web Recorder, Smart Recorder, and Standard or Screen Recorder)
Recorder for Web/Windows	Available	Available	Available
Recorder for SAP	Available	Available	Not available
Recorder for Citrix	Available	Available	Not available
Recorder for Oracle	Available	Available	Not available
Secure recording	Available	Available	Available
Microsoft Silverlight 5 desktop and web applications	Available (Third-party controls are not available)	Available	Available
Selection of capture technology in recorder	Available	Available	Available

Bot packages

Feature	Automation 360 packages	Enterprise 11.3.x commands	Enterprise 10.x commands
AARI on the web	Available	Not available	Not available
Active Directory	Available	Available	Available
Analyze	Available	Not available	Not available
Application	Available	Available	Available
App Integration	Available	Available	Available
Boolean	Available	Not available	Not available
Bot migration	Available	Not available	Not available

Feature	Automation 360 packages	Enterprise 11.3.x commands	Enterprise 10.x commands
Browser	Available The following actions are only available for the Google Chrome browser: <ul style="list-style-type: none"> • Close • Get source code • Go back • Run JavaScript 	Available (through Web Recorder) The Web Recorder commands are only available for the Internet Explorer browser.	Available (through Web Recorder) The Web Recorder commands are only available for the Internet Explorer browser.
Citrix Automation	Not available (Deprecated and replaced with Unified Recorder)	Available	Available
Clipboard	Available	Available	Available
Comment	Available	Available	Available
Credential Vault	Available	Available	Available
CSV/TXT	Available	Available	Available
Data Table	Available	Available using Array type variable	Available using Array type variable
Database	Available	Available	Available
Datetime	Available	Not available	Not available
Delay	Available	Available	Available
Dictionary	Available	Not available	Not available
DLL	Available	Limited availability through MetaBots	Limited availability through MetaBots
Email	Available (SMTP, EWS, and Outlook) The following options are not available: <ul style="list-style-type: none"> • Send email with template • Add picture inside the Email 	Available (SMTP, EWS)	Available (SMTP)
Error handler	Available (Advanced - Try, Catch, Finally, Throw)	Available (Basic)	Available (Basic)
Excel advanced	Available	Limited availability	Limited availability
Excel basic (without Excel)	Available	Not available	Not available

Feature	Automation 360 packages	Enterprise 11.3.x commands	Enterprise 10.x commands
File operations	Available	Available	Available
Folder operations	Available	Available	Available
FTP / SFTP	Available	Available	Available
If	Available	Available	Available
Image Recognition	Available	Available	Available
Interactive form operations	Available	Not available	Not available
Internet Connection	Not available (Deprecated for Automation 360)	Available	Available
IQ Bot	Available	Available	Available
IQ Bot Pre-processor	Available	Not available	Not available
IQ Bot (Local Device)	Deprecated	Not available	Not available
JavaScript	Available	Available through Run Script	Available through Run Script
Legacy Automation (for migrated bots)	Available (for migration)	Not available	Not applicable
List operations	Available	Not available	Not available
Log To File	Available	Available	Available
Loop	Available	Available	Available
Message Box	Available	Available	Available
MetaBot screens	Not available (Replaced with Universal Recorder)	Available	Available
Mouse	Available	Available	Available
Number	Available	Not available	Not available
OCR	Available	Available	Available
Office 365 Calendar	Available	Not available	Not available
Office 365 Excel	Available	Available (Desktop)	Not available
Office 365 OneDrive	Available	Not available	Not available
One Drive	Available	Not available	Not available
PDF	Available	Available	Available
PGP	Available	Available	Available
Play Sound	Available	Available	Available
Printer	Available	Available	Available

Feature	Automation 360 packages	Enterprise 11.3.x commands	Enterprise 10.x commands
Prompt	Available	Available	Available
Python Script (Inline)	Available	Not available	Not available
Record	Available	Not available	Not available
Recorder	Available	Available	Available
REST Web Service	Available	Available	Available
SAP support	Available (Native)	Limited availability through MetaBots	Limited availability through MetaBots
SAP BAPI	Available Custom developed SAP BAPI is not supported.	Available	Available
Screen	Available	Available	Available
Services	Available	Available	Available
Simulate keystrokes	Available	Available	Available
SNMP	Available	Available	Available
SOAP Web Service	Available	Available	Available
Step	Available	Not available	Not available
String	Available	Available	Available
System	Available	Available	Available
TaskBot	Available	Available	Available
Terminal Emulator	Available	Available	Available
Text file	Available	Not available	Not available
Trigger Loop	Available	Not available	Not available
VBScript (Inline)	Available	Available as Run Script	Not available
Wait	Available	Available	Available
Window	Available	Available	Available
Workload	Available	Available	Not available
XML	Available	Available	Available

Variables support

Important: When you migrate from Enterprise versions 11.3.x or Enterprise 10 to Automation 360, some variables are mapped directly while some contain a different configuration.

Variable	Automation 360	Enterprise 11.3.x	Enterprise 10.x
Application variables			

Variable	Automation 360	Enterprise 11.3.x	Enterprise 10.x
<i>Analytics</i>	Available	Available	Not available
<i>ArrayRows</i>	Available through Recursive expressions	Available	Available
<i>ArrayColumns</i>	Available through Recursive expressions	Available	Available
<i>Clipboard</i>	Available	Available	Available
<i>Credential</i>	Available	Available	Not available
<i>Dictionary</i>	Available through Dictionary package	Available	Not available
<i>Enter</i> (String variable)	Available	Available	Available
<i>Prompt Assignment</i> (user-defined)	Available	Available	Available
<i>Read from Excel/CSV</i>	Available through Excel advanced package	Available through Array type user-defined variable	Available through Array type user-defined variable
<i>Read from database</i>	Available through Database package	Available through Array type user-defined variable	Available through Array type user-defined variable
<i>Read from text file</i>	Available through CSV/TXT package	Available through Array, List, and Value type user-defined variables	Available through Array, List, and Value type user-defined variables
<i>Separator</i> (String variable)	Available	Available	Available
<i>Tab</i> (String variable)	Available	Available	Available
<i>Work Item</i>	Available	Available	Not available
System variables			
<i>AAApplicationPath</i>	Available through global values	Available	Available
<i>AADefaultDateFormat</i>	Available through global values	Not available	Not available
<i>AAInstallationPath</i>	Available	Available	Available
<i>AATaskExecutor</i>	Available	Available	Not available
<i>AATaskName</i>	Available	Available	Not available
<i>AAControlRoom</i>	Available	Available	Not available
<i>Counter</i>	Available through Number and Loop packages	Available	Available
<i>CPUUsage</i>	Available	Available	Available
<i>CurrentDirectory</i>	Available through Loop package	Available	Available

Variable	Automation 360	Enterprise 11.3.x	Enterprise 10.x
<i>DatasetColumn</i>	Available through Loop package	Available	Available
<i>Date</i>	Available	Available	Available
<i>Day</i>	Available	Available	Available
<i>Email</i> (includes <i>EmailFrom</i> , <i>EmailMessages</i> , <i>EmailReceivedDate</i> , <i>EmailReceivedTime</i> , <i>EmailSubject</i> , <i>EmailTo</i> , <i>EmailSentDate</i> , and <i>EmailSentTime</i>)	Available through Email, Dictionary, and Loop packages	Available	Available
<i>ErrorLineNumber</i>	Available through Error handler package	Available	Available
<i>ErrorDescription</i>	Available through Error handler package	Available	Available
<i>Excel</i> (includes <i>ExcelColumn</i> , <i>ExcelCell</i> , <i>ExcelCellColumn</i> , and <i>ExcelCellRow</i>)	Available through Excel advanced package	Available	Available
<i>Extension</i>	Available through GetProperty action of PDF package	Available	Available
<i>FileDataColumn</i>	Available as record type variable through Loop package	Available	Available
<i>FileName</i>	Available through File package	Available	Available
<i>FolderName</i>	Available through Folder package	Available	Available
<i>Hour</i>	Available	Available	Available
<i>Machine</i>	Available	Available	Available
<i>Millisecond</i>	Available	Not available	Not available
<i>Minute</i>	Available	Available	Available
<i>Month</i>	Available	Available	Available
<i>OSName</i>	Available	Available	Available
<i>PDF</i> (includes <i>PDFFileName</i> , <i>PDFTitle</i> , <i>PDFAuthor</i> , and <i>PDFSubject</i>)	Available through GetProperty action of PDF package	Available	Available
<i>RAMUsage</i>	Available	Available	Available
<i>Second</i>	Available	Available	Available

Variable	Automation 360	Enterprise 11.3.x	Enterprise 10.x
<i>TableColumn</i>	Not available	Available	Available
<i>TotalRAM</i>	Available	Available	Available
<i>Trigger</i>	Available through Interface trigger	Available	Available
<i>Year</i>	Available	Available	Available
<i>XMLDataNode</i>	Available as string type variable through Loop package	Available	Available

Related concepts

[Automation 360 Release Notes](#)

Review the new capabilities, changes, fixes (resolved issues), security fixes, deprecated features, and limitations in each release.

[Package SDK](#)

Package SDK enables you in creating and uploading action packages to your Control Room.

Related reference

[Operating system, environment, and platform supported for Control Room](#)

Automation 360 can be hosted on AWS, Microsoft Azure, Google Cloud Platform, IBM, and any public, private, or hybrid cloud service that meets the Control Room and Bot Agent hardware and software requirements.

[Automation 360 FAQ](#)

For details and questions on the latest Automation Anywhere platform, Automation 360, review this FAQ.

[Comparing Automation 360 and Enterprise 11 APIs](#)

Compare Automation 360 and Enterprise 11 APIs to understand the contract changes when you migrate from Enterprise 11 to Automation 360.

[Variable mapping for migration](#)

In migration, some variables map directly from previous product versions to Automation 360 while others behave differently or contain configuration changes.

[Global values](#)

Global values enable users to reuse identical values between bots instead of creating new variables for each bot. A user with the `AAE_admin` role configures a global value with a default value and can enable non-admin users to overwrite the value to use in their bots.

[Recursive expressions](#)

Use a recursive expression to insert a variable in the place of an index or key of a dictionary, list, record, or table variable.

Automation 360 IQ Bot feature comparison matrix

Compare the key features of Automation 360 IQ Bot deployment models and review the feature parity with the latest IQ Bot 11.3.x release.

IQ Bot basic features	Automation 360 IQ Bot			IQ Bot 11.3.x
	On-Premises	Cloud	Community Edition	
Prebuilt domains	Yes	Yes	Yes Supported domains include: <ul style="list-style-type: none"> • Invoices • Purchase orders • Bank statements • Credit memo • Utility bills 	Yes
User confidence threshold in Validator	Yes	No	No	Yes
Learning instance creation/editing/renaming	Yes	Yes	Yes	Yes
Document image preprocessing	Yes	Yes	Yes	Yes
Document image classification	Yes	Yes	Yes	Yes
Document image OCR	Yes	Yes	Yes	Yes
Google Vision OCR	Yes	Yes	Yes	Yes
Tegaki API OCR engine	Yes	No	No	Yes
MICR (magnetic ink character recognition) extraction	Yes	Yes	Yes	Yes
PDFBox Toggle	Yes	Yes	Yes	Yes
Caching (enhanced performance)	Yes	Yes	Yes	Yes
Bot limiting	Yes	Yes	No	Yes
Bot creation/editing/deletion	Yes	Yes	Yes	Yes
Designer/Preview/Test	Yes	Yes	Yes	Yes
Production toggle	Yes	Yes	Yes	Yes

IQ Bot basic features	Automation 360 IQ Bot			IQ Bot 11.3.x
	On-Premises	Cloud	Community Edition	
Validator	Yes	Yes	Yes	Yes
CSV output files	Yes	Yes	Yes	Yes
Learning instance import/export	Yes	Yes	No	Yes
Default validations for a group	Yes	Yes	No	Yes
Adding groups manually	Yes	Yes	No	No
CyberArk support	Yes	No	No	No
CyberArk support with key rotation	Yes	No	No	No

Domain/training features	Automation 360 IQ Bot			IQ Bot 11.3.x
	On-Premises	Cloud	Community Edition	
Web-based UI	Yes	Yes	Yes	Yes
Domain import/export	Yes	Yes	No	Yes
Hover over text segment to view OCR	Yes	Yes	Yes	Yes
Resize mapped box in Designer	Yes	Yes	Yes	Yes
Delete mapped box in Designer	Yes	Yes	Yes	Yes
Populate text in End of table/section indicator	Yes	Yes	Yes	Yes
Single click to extract text in the Validator	Yes	Yes	Yes	Yes
Document group description	Yes	Yes	Yes	Yes
See extraction results action displays list of all training documents in an alphanumeric sequence	Yes	Yes	Yes	Yes
InstallShield patch installer with simplified upgrade/downgrade for IQ Bot	Yes	No	No	Yes
OCR Pre-processing Settings configuration	Yes	No	No	No

Extraction/validation features	Automation 360 IQ Bot			IQ Bot 11.3.x
	On-Premises	Cloud	Community Edition	
Original IQ Bot text segmentation/document classifier from IQ Bot Version 5.3.0/6.0	Yes	No	No	Yes
New IQ Bot text segmentation/ document classifier from IQ Bot Version 5.3.1/6.5	Yes	Yes	Yes	Yes
Option to select classifier version of existing learning instances during IQ Bot upgrade: <ul style="list-style-type: none"> Version 1 (IQ Bot 5.3.0 or before 6.0) Version 2 (IQ Bot 5.3.1/ Version 6.5 Beta) 	Yes	No	No	Yes
Enhanced compatibility with ABBYY FineReader Engine 12.2 Plugin	Yes	Yes	Yes	Yes
Automated installation of ABBYY FineReader Engine 12.2 Plugin	Yes	Yes	Yes	Yes
Validator auto-correction	Yes	Yes	Yes	Yes
Check box extraction	Yes	Yes	Yes	Yes
Check box auto-detection	Yes	Yes	Yes	Yes
Advanced extraction: Repeated tables/sections; linking tables/sections; map some header-less columns	Yes	Yes	Yes	Yes
Alternative to stop extraction at End of table/section indicator	Yes	Yes	Yes	Yes
Select text segments that enclose or are enclosed by other text segments	Yes	Yes	Yes	Yes
Option to select default training document	Yes	Yes	Yes	Yes
Formula validation	Yes	Yes	Yes	Yes
List validation in UI	Yes	Yes	Yes	Yes
List validation through external file	No	No	No	No

Extraction/validation features	Automation 360 IQ Bot			IQ Bot 11.3.x
	On-Premises	Cloud	Community Edition	
File/folder search validator	Yes	Yes	Yes	Yes
Microsoft Azure Computer Vision API (OCR)	Yes	Yes	Yes	Yes
Add user logic in the Designer	Yes	Yes	Yes	Yes
View and test all documents in the Designer > See extraction results	Yes	Yes	Yes	Yes
IQ Bot extensions	Yes	No	No	Yes
Import standard form domains	Yes	Yes	No	Yes
(Beta) Enabled data capture and OCR using Google Vision API for Asian languages	Yes	Yes	Yes	Yes
Magnetic ink character recognition (MICR) extraction	Yes	Yes	Yes	Yes
Option to turn off PDFBox as OCR engine	Yes	Yes	Yes	Yes
Using variables in IQ Bot package	Yes	Yes	Yes	No
Extraction results opening in a new browser tab	Yes	Yes	Yes	No
IQ Bot standard forms	Yes	Yes	No	No

Enterprise features	Automation 360 IQ Bot			IQ Bot 11.3.x
	On-Premises	Cloud	Community Edition	
Access IQ Bot without device license (without Bot Creator or Bot Runner license)	Yes	Yes	Yes	Yes
Access IQ Bot as Validator users without Bot Creator or Bot Runner license	Yes	Yes	Yes	Yes
Database encryption	Yes	Yes	Yes	Yes
Roles-based access (RBAC) for new learning instances	Yes	Yes	No	Yes
Audit logs	Yes	Yes	No	Yes
Windows authentication	Yes	Yes	No	Yes
Azure PaaS Database Service	Yes	No	No	Yes
Counter for number of uploaded pages in production	Yes	Yes	No	Yes

Enterprise features	Automation 360 IQ Bot			IQ Bot 11.3.x
	On-Premises	Cloud	Community Edition	
API access	Yes	Yes	Yes	Yes
Access IQ Bot without <i>sysadmin</i> role that includes support for Amazon Relational Database Service (RDS) out of the box	Yes	No	No	Yes
Migrate learning instances as other learning instances are being edited	Yes	Yes	No	Yes
Migration Utility UI	Yes	Yes	No	Yes
Internationalization	Yes	Yes	Yes	Yes
UI Localization: <ul style="list-style-type: none"> • Chinese Simplified • Chinese Traditional • French • German • Japanese • Korean • Spanish • Italian • Portuguese 	Yes	Yes	Yes	Yes

Automation 360 packages	Automation 360 IQ Bot		
	On-Premises	Cloud	Community Edition
IQ Bot Classifier package	Yes	Yes	No
IQ Bot [Local Device] package	Yes	Yes	Yes
IQ Bot Pre-processor package	Yes	Yes	Yes
IQ Bot Extractionpackage	Yes	Yes	Yes

Related reference

[Comparing Automation 360 and Enterprise 11 APIs](#)

Compare Automation 360 and Enterprise 11 APIs to understand the contract changes when you migrate from Enterprise 11 to Automation 360.

Related information

[IQ Bot 11.x feature comparison matrix](#)

Automation 360 IQ Bot version compatibility

Review the version compatibility information before you upgrade from an earlier version of Automation 360 IQ Bot to the latest Automation 360 IQ Bot version, or from earlier versions of IQ Bot to Automation 360 IQ Bot.

Compatibility with Automation 360 Control Room

Automation 360 IQ Bot On-Premises version compatibility with Automation 360 Control Room:

Important: The following table lists the latest build of each Control Room release that is compatible with the IQ Bot build. Note that, IQ Bot is compatible with all Automation 360 builds in a release. For example, Automation 360 v.21, IQ Bot build 9642 is compatible with Control Room build 9664 and builds released after that such as 9595, and 9642 **for the same release version**. We recommend that you update to the latest Control Room build for the latest fixes.

IQ Bot On-Premises	Control Room
Build 16667	Build 16667 (Automation 360 v.27)
Build 15450	Build 15450 (Automation 360 v.26)
Build 15112	Build 15112 (Automation 360 v.25)
Build 13343	Build 13343 (Automation 360 v.24R2)
Build 12350	Build 12350 (Automation 360 v.24)
Build 11513	Build 11513 (Automation 360 v.23)
Build 10520	Build 10526 (Automation 360 v.22)
Build 9642	Build 9664 (Automation 360 v.21)
Build 8815	Build 8815 (A2019.20)
Build 8098	Build 8147 (A2019.19)
Build 7554	Build 7560 (A2019.18)
Build 7082	Build 7103 (A2019.17)
Build 6443	Build 6463 (A2019.16)
Build 5931	Build 5933 (A2019.15)
Build 5322	Build 5322 (A2019.14)
Build 4695	Build 4705 (A2019.13)
Build 4088	Build 4105 (A2019.12)
Build 3337	Build 3337 (A2019.11)
Build 2545	Build 2545 (A2019.10)
Build 2079	Build 2079
Build 1610	Build 1610
Build 1089	Build 1089

IQ Bot On-Premises	Control Room
Build 550	Build 550

Automation 360 IQ Bot Cloud version compatibility with Automation 360 Control Room:

IQ Bot Cloud	Control Room
Build 15436	Build 15450 (Automation 360 v.26)
Build 14288	Build 14298 (Automation 360 v.25)
Build 12342	Build 12342 (Automation 360 v.24)

Migration compatibility with earlier IQ Bot versions

Review the following version compatibility table to understand the available upgrade options for Automation 360 IQ Bot:

IQ Bot version	Automation 360 IQ Bot (On-Premises)
Version 11.3.5.x	Yes
Version 11.3.4.x	Yes

To migrate to Automation 360 IQ Bot On-Premises from a version earlier than 11.3.4.x, first upgrade to IQ Bot Version 11.3.4.x or later.

[Migrate to Automation 360 IQ Bot](#)

Importing learning instances between different IQ Bot versions is not supported. If you want to retain the associated data for a learning instance, ensure you update or migrate to the correct IQ Bot version before importing the corresponding learning instance. For example, if you export a learning instance in IQ Bot On-Premises (Build 8815), you can only import it within an equivalent IQ Bot On-Premises or Cloud build.

[Migrate learning instances](#)

Automation 360 software lifecycle policy

Automation Anywhere software lifecycle policy aims to make innovations and enhancements available to you quickly. Through this policy, we provide you predictability, quality, and importantly nondisruptive access to the latest innovations and enhancements so that you can control when and how you want to adopt these enhancements.

Note: The policies mentioned on this page apply to both Automation 360 Cloud and On-Premises deployments unless where the differences are called out explicitly.

Overview

The software lifecycle policy helps you with change management while providing you the latest software updates with enhancements in the Control Room, Bot Agent, and packages.

Our policy aims to provide faster access to features, bug fixes, and other enhancements for a better customer experience:

- **Predictability:** With frequent, regular deployment cycles, you can get access to new and enhanced packages sooner than before with predictable release cadence.
- **Deploy new features:** With control over introducing changes to your bots, you can test new features and deploy them at your own pace.
- **Quality:** With automated deployments from Automation 360 Cloud, you can use new packages that include critical bug and security fixes.
- **Nondisruptive access:** You can update packages without disrupting your existing configurations.
- **Backward compatibility:** You now have the option to safely update bots while still having the option to change back to a previous version of a package.

The following image shows the advantages of this lifecycle policy:



Bot Agent updates

When a new version of Bot Agent is available, by default, the Bot Agent is deployed automatically across a customer's pool of devices without impacting existing bot functionality. However, Control Room administrators can disable this default update capability and choose to update the Bot Agent manually. In case of manual updates and in the event of a mandatory update, users will be notified that the Bot Agent must be updated and all bot execution on these devices will stop until the Bot Agent is updated.

For larger deployments where device pools are deployed using standard device Amazon Machine Images (AMI) on separate schedules, these updates will require coordination, change management processes, and approvals in the customer environment. Therefore, Automation 360 will support backward-compatible Bot Agent for a release every 6 months.

Starting with Automation 360 v.24 release, **4** Bot Agent updates will be released each year with **2 optional** and **2** updates that might be declared mandatory. You can skip the optional update and update to the next mandatory Bot Agent update.

Our Q2 and Q4 releases will have optional Bot Agent updates and you can choose to skip the Bot Agent update. However, the Q1 and Q3 updates might have mandatory Bot Agent updates. We will notify customers 3 months in advance if a mandatory Bot Agent update is required with a Control Room release.

Package updates

Starting with Automation 360 v.24 release, delivery of packages is developed to be separate from the main platform updates. This will help us respond quickly to changes and fixes required and provide the flexibility to deliver updates in packages, going forward.

With this capability, new packages and new package versions can now be automatically downloaded from Automation Anywhere Cloud when they are predictably released on a quarterly release cadence. These downloaded packages become the default package so that customers can start using these package versions on an ongoing basis as they become available.

This capability is enabled differently for Cloud and On-Premises Control Room instances, as listed in the following table:

Seamless package update capability	Cloud Control Room	On-Premises Control Room
Download packages from Automation Anywhere Cloud	Enabled by default and cannot be disabled.	Disabled by default and can be enabled.
Set downloaded package to default version	Enabled by default and can be disabled.	Enabled by default and can be disabled.

- **Cloud users:** Automatic package download capability is now enabled across all Control Room instances in all regions at the same time.

You can start using the latest packages on your current Control Room version before the Control Room update is made available in your region.

- **On-Premises users:** This capability is disabled by default but it can be enabled by package administrators.

We recommend that bot developers always use the latest version of the packages because that version provides the latest innovations and all the code and security fixes from previous versions. However, administrators can change this default behavior at any time and roll out the packages to developers after verifying them. These new package versions are also backward-compatible with the existing platform version.

Note that this capability has no impact on existing bots, which continue to run unchanged. Bots that are developed with a particular package version will always continue to do so unless explicitly changed by the bot developer. This provides bot developers the flexibility to adopt new package versions when they are ready for it. Bot developers must explicitly edit the bots in the Bot editor view and use the new package version.

Support and deprecation policy for packages

Support and deprecation policy for packages aims to provide bot longevity and reduce overall maintenance efforts to keep bots updated. The design consideration is to minimize the bot changes required to keep the bot functioning.

Note: This policy is in effect from Control Room release v.23.

Package versions supported for a minimum of 2 years

Package versions that are released will continue to be supported for a minimum of 2 years after the release. Even after 2 years, a package version will continue to be supported unless it is deprecated.

Typically, a new version of the package will be made available if a package is deprecated. All issues and security fixes reported for the package will be fixed in the latest version, with no backporting.

You will be notified 3 months in advance when a package version is planned for deprecation. If there

Packages version compatibility with Bot Agent and Control Room

is a critical security vulnerability, we will make the best effort to send an advanced notification.

Package versions and bots that use these versions will be compatible with all the Control Room and Bot Agent versions released within the 2 years after the package version release. Bots that use these supported package versions do not have to be configured to be compatible with the Control Room and Bot Agent versions.

Deprecation policy on package version

Package versions will not be depreciated within the 2 years after their release unless there is a critical security vulnerability that has to fixed. In such a case, a new package version will be made available with the fix.

Minimal bot changes

The package version support policy aim is to minimize the effort required to change existing bots and to keep them functioning.

Bots using a specific package version do not have to be updated to use the package versions if the existing package version is supported. However, we recommend that you use the latest version of the package when developing the bot to increase the longevity of the bot. The package versions used in a bot will have to be updated before they are depreciated for the bot to remain supported.

Bot lifecycle

The design assumption for bots is that the version of the package used in the bots is present in the Control Room that is used to run the bots. Before developers promote bots, we recommend that the developers verify that the package version used in the bots matches the package version in the higher environments.

When promoting bots to higher environments (for example, testing and production) that are on a lower software version, ensure that you include the dependent packages for bots. This will ensure that the target environment has all the package versions required by the bot.

Note: Some package versions will not be backward compatible with an earlier version of the Control Room or Bot Agent. Therefore, refrain from using such incompatible package versions during the Control Room environment update phase.

See also: [Automatic package updates for On-Premises Control Room.](#)

Related concepts

[Feature deprecations affecting Automation Anywhere products](#)

Review the features and capabilities (from Automation Anywhere or third party) that are deprecated or nearing deprecation to understand how they affect your automation and what action is required.

Related reference

[Automation 360 Cloud FAQ](#)

Answers to frequently asked questions (FAQ) and related information provide insight into various aspects related to Automation 360 Cloud.

[Automation 360 Cloud updates](#)

Automation 360 Cloud is a multitenant cloud service that leverages the latest best practices in delivering web-scale SaaS to rolling out incremental updates globally using a continuous deployment pipeline.

Automation 360 Cloud Service Status site

The Automation 360 Cloud Service Status site displays real-time operational status, historical operational status, maintenance information, and incident history for all Automation 360 Cloud services worldwide, across all hosting regions.

[Automation 360 Cloud Service Status site](#)

How you can use the site

You can use the Automation 360 Cloud Service Status site to view various updates:

Note: In addition to viewing updates, you can also receive updates regarding ongoing incidents and upcoming scheduled maintenance by email or RSS feed by using the **Subscribe** option on the top-right corner.

- Use the **Component Summary** section to view the real-time operational status of all the Cloud services hosted from all regions worldwide.
 - Use the **Component Status History** section to view the historical operational status of all Automation 360 Cloud services hosted across all regions worldwide.
-

Note: This historical information can be traced back for a maximum of three months.

- Use the **Upcoming Maintenance - Next 14 days** section to view maintenance information about ongoing and upcoming incidents for the next 14 days.
 - Use the **Incident History** section to view information about incidents that are resolved and scheduled maintenance events that are completed .
-

Note: In the Automation 360 Cloud Service Status site and in this documentation, the term "component" refers to the Automation Anywhere service within a hosting region.

Real-time operational status

Automation Anywhere frequently monitors the accessibility and health of components from various geographical regions across the world to report on the operational statuses of components in real time. The **Component Summary** section provides a real-time view of the operational status of various components.

The following table provides a list of operational statuses along with definitions and examples:

Component statuses along with definitions and examples

Component status	Definition	Example
Operational	All the services in the region are operational and available.	All the Control Room URLs are accessible, and customers can log in to their Control Room instances.

Component status	Definition	Example
Informational	All the services in the region are operational but have an incident that does not affect customers.	
Under Maintenance	The services in the region are currently unavailable.	The service is undergoing a planned maintenance event.
Degraded Performance	There is an incident that affects performance significantly.	<ul style="list-style-type: none"> • The service is available, but one or more capabilities of the service are not performing optimally. • Services in the region are occasionally inaccessible or interrupted. • Bots in the region occasionally fail for some customers.
Partial Outage	There is a major incident that affects a few customers significantly.	<ul style="list-style-type: none"> • Services in the region are inaccessible, or some customers (more than 25 percent of customers in the region) cannot log in to their Control Room instances. • Bots in the region fail for some customers. • A security or data breach has occurred for some customers in the region.
Major Outage	There is a critical incident with very high impact across the region.	<ul style="list-style-type: none"> • Services in the region are inaccessible, and customers cannot log in to their Control Room instances. • Bots fail to run successfully on the Control Room instances in the region. • A security or data breach has occurred for all the customers in the region. • A Cloud region has completely failed, triggering a disaster recovery event.

Historical operational status

The **Component Status History** section provides a historical view of the availability status of all the components over the preceding seven days. You can use the **Search Components** option at the top-left corner of the section to search for the historical operational status of a specific component. You can use

the arrows on the top-right corner of the section to view the historical operational status of components, one week at a time, for the preceding three months.

This section also provides an aggregated incident status for all the incidents for any given day. Click the days with incidents to view a summary of uptime details along with a list of incidents reported for that day.

Note: Planned maintenance windows are reported as incidents.

Maintenance information

Two types of incidents are monitored for and reported on the Automation 360 Cloud Service Status site:

- **Planned incidents:** Incidents that are primarily related to planned maintenance windows for software updates, such as patch updates, security updates, and infrastructure updates.
- **Unplanned incidents:** Unplanned interruptions that result in reduced or degraded service performance or total interruption to service availability for some or all customers.

Planned maintenance events

The planned maintenance window is published well in advance of scheduled events and is conducted to improve multiple aspects of a service. A planned maintenance event is scheduled to deploy a software update, a patch to fix an existing issue, a security patch to resolve a security vulnerability, or an infrastructure component update to improve the reliability, resiliency, and availability of the service. Users who are subscribed to incident notifications receive an email notification about the details of maintenance windows.

Planned maintenance events typically last for four to six hours per geographical region when updates are rolled out. Although the actual downtime during the update varies, completion is typically within 10 to 15 minutes. If IQ Bot is in use, completion time is typically 20 to 30 minutes.

The Automation 360 Cloud Service Status site provides information about the following types of planned maintenance events:

Planned maintenance event for deploying Automation 360 release update

This planned maintenance event deploys new Automation 360 software release update to the Automation 360 Cloud. Here are the notification fields for this software release update:

Title Planned upgrade for Automation 360 Cloud for a region

Description Planned upgrade for Automation 360 to the Automation 360 Cloud, which results in minor interruptions to the service during this period.

Note: We recommend that you do not run bots during this period.

Advance Notice The notification announcing this maintenance window is

Planned maintenance event for deploying patch (non-security) release for Control Room

published at least two weeks in advance on the Automation 360 Service Status site. The release notes are published in advance of the update.

This planned maintenance event deploys Automation 360 software patches to Automation 360 Cloud to fix existing or unknown issues. Here are the notification fields for this patch release update:

Title Emergency patch for Automation 360 Cloud for a region

Description This is a critical, non-security patch upgrade for Automation 360 to the Automation 360 Cloud, which results in minor interruptions to the service during this period.

Note: We recommend that you do not run bots during this period.

Advance Notice The notification announcing this maintenance window is published with best effort, in advance, on the Automation 360 Service Status site. The release notes are published in advance of the update.

Planned maintenance event for deploying patch (security) release for Control Room

This planned maintenance event deploys Automation 360 security fixes to Automation 360 Cloud to fix existing vulnerabilities, known security issues, and Cloud component updates to resolve vulnerabilities. Here are the notification fields for this update:

Title Emergency security patch for a region

Description This is a critical security patch upgrade for Automation 360 to the Automation 360 Cloud, which results in minor interruptions to

the service during this period.

Note: We recommend that you do not run bots during this period.

Advance Notice

The notification announcing this maintenance window is published with best effort, in advance, on the Automation 360 Service Status site depending on how critical the security issue is. The release notes are published in advance of the update.

Planned maintenance event for Automation 360 infrastructure updates

This planned maintenance event deploys updates related to the Automation 360 Cloud infrastructure. Here are the notification fields for this update:

Title

Planned infrastructure upgrade for Automation 360Cloud for a region

Description

This is a planned infrastructure upgrade for Automation 360 Cloud, which results in minor interruptions to the service during this period.

Note: We recommend that you do not run bots during this period.

Advance Notice

The notification announcing this maintenance window is published at least two weeks in advance on the Automation 360 Service Status site. The release notes are published in advance of the update.

Planned maintenance event for patch (security) release for IQ Bot Hybrid

Title

Planned upgrade for Automation 360 Cloud for IQ Bot Cloud servers for a region

Description

This is a critical patch update for IQ Bot on

the Automation 360 Cloud, which results in interruptions to the IQ Bot service during this period. Access to the main Automation 360 Cloud Control Room and other services are not affected.

Note: We recommend that you do not schedule bots that use IQ Bot capabilities to start during this period.

Advance Notice

The notification announcing this maintenance window is published at least two weeks in advance on the Automation 360 Service Status site. The release notes are published in advance of the update.

Incident history

The **Incident History** section shows a detailed list of resolved incidents and completed scheduled maintenance events for the preceding seven days.

The list includes the following details about each incident:

- Incident description
- Incident duration (start time, end time, and duration of the outage)
- Affected components
- Incident status updates
- Information in cases of unplanned service outages

Automation 360 Cloud updates

Automation 360 Cloud is a multitenant cloud service that leverages the latest best practices in delivering web-scale SaaS to rolling out incremental updates globally using a continuous deployment pipeline.

Automation 360 Cloud provides updates to the Bot Agent instances running on your infrastructure. The Bot Agent is a lightweight, Java-based, modular application that handles particular bots and their packages when they are scheduled to run.

Bot Agent updates are transparent to active Bot Creator users. For operations, the Bot Agent updates are carried out automatically, by default, without requiring administrative privileges (much like browser updates).

Note: This is regardless of whether the Bot Agent was installed as a system user or local user.

With each update, products such as RPA Workspace, Control Room, IQ Bot, Bot Insight, Discovery Bot, and AARI have improved security and enhanced features. Application command packages can also be enhanced and made available for inclusion into bots on your release cycle.

Updates are rolled out over a 3-hour maintenance window per geographical region. These maintenance windows are posted on the Automation 360 Cloud Service Status site. Although the actual downtime during the update varies, completion is typically within 10-15 minutes. If IQ Bot is in use, completion time is typically 20 - 30 minutes. In general, bots run to completion during updates, with the following scenarios being exceptions:

- The bot tags data for Bot Insight.
- Parent/child bots run to completion as the child bots are downloaded at the start of running the parent bot. Unless the child bots are referenced using a variable parameter, calling those child bots need the Control Room to be available during parent bot runs.
- Bots that run WLM.

After the Bot Agent has reconnected to the Control Room, the bot status is updated in the bot run activity logs.

Automated Bot Agent update takes place after an agent completes any current bot run and the Bot Agent reconnects to the Control Room.

During this short downtime, any bots scheduled to run will not be run. It is therefore recommended that bots are not scheduled to start to run during the planned maintenance window.

The following table provides a list of regions and the day and time of their maintenance windows.

Important:

Times mentioned below are in UTC (Coordinated Universal Time). To convert to your local time, refer to a universally recognized online resource such as <https://www.worldtimezone.com/>.

Region	Day and time in UTC
AP-AUS	Wednesday, 12:00 to 15:00
AP-Sing	Wednesday, 16:00 to 19:00
EU-West1	Tuesday, 20:00 to 23:00
EU-West4	Tuesday, 20:00 to 23:00
LATAM	Thursday, 02:00 to 05:00
ME	Thursday, 20:00 to 23:00
S. Africa	Thursday, 20:00 to 23:00
US-East	Friday, 02:00 to 05:00
US-Central	Friday, 02:00 to 05:00
India	Friday, 20:00 to 23:00
US-West	Monday, 02:00 to 05:00
Canada	Monday, 02:00 to 05:00
Japan	Monday, 16:00 to 19:00

Note: A small interim update might be planned to address urgent, priority updates mid-cycle between the primary quarterly updates. These will occur on the same day of the week and time as the schedule mentioned previously.

Regular updates

Regular updates are planned approximately every 3 months and are scheduled to occur during non-business hours and not close to the beginning or end of a month. Notifications are posted to the Service Status site 2 weeks in advance of the update. A notification message is also pushed to administrators in the Control Room in advance.

You can review changes in the release notes that are made available 3 weeks before each update.

Note: As a customer, you can use a sandbox Control Room environment to try out the next update at least 3 weeks before the main Dev/UAT/Prod environments are updated.

Command packages might be updated and made the default for creating new bots. Existing bots continue to use their existing package versions. New bots use the new default package version. However, as a user, you can also choose to revert to the previous version.

Cloud infrastructure updates

Cloud infrastructure updates are carried out typically once every 3-month period. If these infrastructure updates involve planned downtime for Automation 360 Cloud, notifications are posted on the Service Status site at least 1 week in advance.

Critical patch updates

Patch updates might be required for either critical security updates or where serious issues with an update affect the majority of Cloud customers.

Patches require a maintenance window although they typically do not require a Bot Agent update. For patch updates, advance notice will be provided on the Service Status site.

Planned maintenance windows

Automation Anywhere offers planned update maintenance windows to enable customer operations to support Bot Lifecycle Management. Outside of planned maintenance windows for the updates mentioned previously, the Automation 360 Cloud availability SLA is 99.9 percent per month.

Note: For more information, see [Cloud Automation Agreement](#).

The following table provides information such as frequency, time expectation, and client action for different types of updates:

Type of update	Frequency	Time expectation	Client action
Regular Automation 360 Control Room and Bot Agent	3 - 4 months	3-hour window Around 10 minutes of downtime	Bots can run to completion. Do not schedule bots to start during this 3-hour window.

Type of update	Frequency	Time expectation	Client action
Sandbox	At least 3 weeks prior to regular Cloud updates		Try new features out after the window. Sanity-test production bots.
Cloud infrastructure	Once every 3-month period	Varies. Scheduled on weekends.	Bots can run to completion. Do not schedule bots to start during the window.
Critical patch	As needed	Critical notice given	

Subscribing to notifications

In the Automation 360 Cloud Service Status site, subscribe to email notifications about planned maintenance events and unplanned incidents that affect service availability.

To subscribe to email notifications from the Automation 360 Cloud Service Status site about planned maintenance events and unplanned incidents that affect service availability, click **Subscribe** on the top-right corner of the Service Status site.

Provide your name and email address when subscribing to notifications.

You can manage your subscription by clicking **Manage Existing Subscription**. The system sends you a link, by email, with which you can manage your incident notification subscription. You can select the service and the region for which you want to receive status notifications.

To subscribe to incident notifications for the Cloud region where your services are hosted, open an Automation Anywhere support ticket.

Personalizing the Service Status site

You can personalize the Automation 360 Cloud Service Status site by selecting the language and time zone of your choice for showing incidents. To select language and time zone, click the gear icon on the top-right corner.

Language

You can select a language from among seven supported languages.

Time zone

When you select a time zone, the incidents from the selected time zone will be shown.

Feature deprecations affecting Automation Anywhere products

Review the features and capabilities (from Automation Anywhere or third party) that are deprecated or nearing deprecation to understand how they affect your automation and what action is required.

Definition: *Deprecation* refers to features or capabilities available in the current (latest) release that are planned to be removed or unsupported in a future release.

You can use the specified alternatives or updated versions when they are made available.

Third-party feature deprecations

Upcoming: The following table lists third-party features that will be deprecated by the date mentioned:

Feature or capability	Deprecation date	Customer impact and recommendation	Resources
Transport Layer Security (TLS) 1.0 and TLS 1.1	April 2023	<p>Automation 360 Cloud deployments currently support the following TLS protocol versions:</p> <ul style="list-style-type: none"> • TLS 1.0 • TLS 1.1 • TLS 1.2 • TLS 1.3 <p>However, the TLS 1.0 and TLS 1.1 protocol versions have security vulnerabilities as per the industry security standards. Therefore, Automation 360 Cloud deployments for Amazon Web Services and Google Cloud Project will support only the TLS 1.2 and TLS 1.3 protocol versions.</p> <hr/> <p>Note: For Automation 360 Cloud deployments, the changes will be effective as part of the Cloud deployment configurations, not as part of the Automation 360 release.</p> <hr/>	Deprecating TLS 1.0 and TLS 1.1

Feature or capability	Deprecation date	Customer impact and recommendation	Resources
Manifest V2 based extensions by Google See also: Overview and timelines for migrating to Manifest V3	January 2023	Automations that use Google Chrome Manifest V2 based extensions will stop working sometime after June 2023. The deprecation timelines of Manifest V2 based extensions are currently under review and subject to change by Google. <ul style="list-style-type: none"> For Google Chrome Manifest V2 extensions timelines, see Manifest V2 support timeline. For Microsoft Edge Manifest V2 extensions timelines, see Overview and timelines for migrating to Manifest V3. <p>This might impact customer bots that automate web applications over Google Chrome and Microsoft Edge.</p> <p>Recommended: Switch to Manifest V3 based extensions for Google Chrome and Microsoft Edge.</p> <p>Releases:</p> <ul style="list-style-type: none"> Automation 360 v.26 Version 11.3.5.8 (Client patch planned for December 2022) 	<ul style="list-style-type: none"> Chrome and Edge Manifest V3 extensions Enterprise 11: Deprecation of Basic authentication and MV2 extensions

Completed: The following table lists third-party features that are already deprecated:

Feature or capability	Deprecation date	Customer impact and recommendation	Resources
Basic authentication in Exchange Online	October 2022	Bots for email automations (Email package and trigger) that connect to Exchange Online by using IMAP, POP3, or EWS protocols with Basic authentication will be impacted. <p>Recommended: Update the impacted bots by replacing each email-related action with OAuth 2.0.</p> <p>Released:</p> <ul style="list-style-type: none"> A package only release for Automation 360 v.25 Version 11.3.5.7 client patch 	<ul style="list-style-type: none"> Deprecation of Basic authentication in Exchange Online Enterprise 11: Deprecation of Basic authentication and MV2 extensions

Feature or capability	Deprecation date	Customer impact and recommendation	Resources
Internet Explorer EOL	June 2022	<p>Customers who are running IE-based bots on Windows 10 Semi-Annual Channel are impacted.</p> <p>Releases with tools to convert IE-based bots to Microsoft Edge with IE mode:</p> <ul style="list-style-type: none"> Automation 360 v.24R2 Version 11.3.5.6 	<p>Microsoft Internet Explorer EOL overview</p> <p>Microsoft Internet Explorer 11 EOL FAQ</p>

Automation Anywhere feature deprecations

Completed: The following table lists Automation Anywhere features that are already deprecated:

Feature or capability	Deprecation date	Customer impact and recommendation	Resources
IQ Bot Extraction package	October 2022	<p>From Automation 360 v.25, the IQ Bot Extraction package no longer supports pretrained machine learning model for invoice data extraction but will continue to support learning instance group based-training extraction.</p> <p>Recommended: Use the new command package called Document Extraction, released in v.25 as part of Document Automation.</p> <p>Released:</p> <ul style="list-style-type: none"> Automation 360 v.25 	<p>Move from IQ Bot Extraction package to Document Automation</p>
IQ Bot - Tesseract OCR v3	October 2022	<p>For all existing learning instances trained using Tesseract OCR v3, we recommend that you plan to train them with alternative OCRs (including Tesseract4 OCR) before you update to v.26. Note that Automation 360 IQ Bot Cloud customers will receive the v.26 release by default from October 2022.</p> <p>Released:</p> <ul style="list-style-type: none"> Automation 360 v.26 	--

Feature or capability	Deprecation date	Customer impact and recommendation	Resources
G-Suite Apps	September 2022	<p>From Automation 360 v.26, the GSuite Apps package no longer supports using the Connect and Disconnect actions to establish a connection with the Google server and automate tasks.</p> <p>Recommended:For specific G-Suite applications, the functionality of the G-Suite Apps package is available in the following G-Suite packages:</p> <ul style="list-style-type: none"> • Google Drive • Google Calendar • Google Sheets <p>To automate tasks, in the appropriate G-suite package, use the corresponding Connect and Disconnect actions.</p>	Using the Connect action for Google packages
Human-Bot Collaboration 11.3.x	August 2020	<p>Human-Bot Collaboration (HBC) 11.3.x was deprecated from August 2020 with the release of Enterprise A2019.15.</p> <p>Recommended: Migrate to Automation 360 to use the Automation Anywhere Robotic Interface (AARI) that includes Desktop and Web.</p> <hr/> <p>Note: For this migration, there is no automated migration path between HBC 11.3.x and AARI because of an absence of parity between the two products (including sets of features).</p> <hr/>	<p>New: Automation Anywhere Robotic Interface (AARI)</p> <p>Deprecated: Enterprise 11: Human-Bot Collaboration</p>
Automation Anywhere Mobile app	July 2022	The Automation Anywhere Mobile app is deprecated and will not be updated to subsequent versions of iOS and Android. The mobile app is no longer available and no further support will be offered. A replacement product is currently not available.	Archived Documentation (PDF): EN-US

Feature or capability	Deprecation date	Customer impact and recommendation	Resources
V2 Activity List API	June 2022	<p>From Automation 360 v.25, the Activity List API (<code>v2/activity/list</code>) is deprecated.</p> <p>Recommended: With the newly implemented Activity List API (<code>v3/activity/list</code>), you can return the job executions without call back and bot output information.</p> <hr/> <p>Note: If you want to get the <code>botOutVariables</code> or <code>callbackInfo</code>, use Activity job execution.</p>	<p>New API: Activity list</p> <p>Deprecated API: Activity list (deprecated)</p>
RPA Bots for Excel	January 2022	<p>RPA Bots for Excel has been deprecated. The plug-in is no longer available to download as a product. However, support will be offered to current customers already using the product.</p> <p>A replacement product as a plug-in for Microsoft Excel is not available. However, as an alternative, new customers can develop bots for Excel within the Automation 360 RPA Workspace and use input variables to allow specifying file names, worksheets, and ranges for bots to operate on. In RPA Bots for Excel, this action was triggered from within the Excel application, whereas now, this action is taken from the Automation Anywhere Control Room.</p>	<p>Documentation: Archived docs for RPA Bots for Excel v2.0</p>

See also: [Automation 360 software lifecycle policy](#)

Related concepts

[Automation 360 software lifecycle policy](#)

Automation Anywhere software lifecycle policy aims to make innovations and enhancements available to you quickly. Through this policy, we provide you predictability, quality, and importantly nondisruptive access to the latest innovations and enhancements so that you can control when and how you want to adopt these enhancements.

[Deprecation of Basic authentication in Exchange Online](#)

Microsoft will permanently disable Basic authentication for specific protocols in Exchange Online starting from October 1, 2022. This impacts customers running bot for email automation that connect to Exchange Online using IMAP, POP3, or EWS protocols with Basic authentication.

[Chrome and Edge Manifest V3 extensions](#)

As Google will deprecate Manifest V2 extensions, this might impact your existing automations that use the current Manifest V2 extensions for Google Chrome and Microsoft Edge browsers. We have published

Manifest V3 extensions with the Automation 360 v.26 release to help you start switching to Manifest V3 extensions.

[Microsoft Internet Explorer EOL overview](#)

Microsoft has announced retiring Internet Explorer (IE) for certain versions of Windows operating systems and recommends impacted users to move their apps or websites running on IE to Microsoft Edge with IE mode.

Microsoft Internet Explorer EOL overview

Microsoft has announced retiring Internet Explorer (IE) for certain versions of Windows operating systems and recommends impacted users to move their apps or websites running on IE to Microsoft Edge with IE mode.

While support for the Control Room (Automation 360 v.25) on IE will end, new and advanced features will be added to Automation 360 v.24R2 patch that will be supported on alternative browsers.

To ensure your existing IE bots are supported on Microsoft recommended browsers, such as Microsoft Edge with IE mode, based on the release you have installed, we recommend that you update to Automation 360 v.24R2 patch. To support conversion of IE bots to Microsoft Edge with IE mode, the following tools are available in this patch:

- Bot Scanner to scan Enterprise 11 bots for IE usage. This helps you to plan your efforts in the IE bot conversion process whether you continue on Enterprise 11 or migrate to Automation 360.

[Bot Scanner overview](#) | [Scan Enterprise 11 or 10 bots using Bot Scanner](#)

- Bot Migration Wizard to support conversion of IE bots to Microsoft Edge with IE mode. This will help Enterprise 10 or Enterprise 11 users to migrate bots to Automation 360 and convert the IE bots at the same time.

[Bot Migration Wizard](#)

- Update Bot wizard to help Automation 360 new users as users who have migrated from Enterprise 10 or Enterprise 11 and want to convert their IE bots to Microsoft Edge with IE mode.

[Update Bot wizard for converting IE bots](#)

See the following video on preparing your automations for IE EOL: <https://fast.wistia.net/embed/iframe/mn3zdcwfff>

Update scenarios

- If you are using **Enterprise 10**, to update your IE bots to Microsoft Edge with IE mode, you can choose one of the following methods:
 - Upgrade to Automation Anywhere Enterprise Version 11.3.5.6 that supports IE bot conversion to Microsoft Edgewith IE mode, convert your IE bots to Microsoft Edge with IE mode, and later migrate to the latest Automation 360 release.
 - Upgrade to Automation 360 v.24R2 patch, migrate your IE bots and update the IE bots to Microsoft Edge with IE mode.
- If you are using Enterprise 11 and are **yet to migrate** to Automation 360, update to Automation Anywhere Enterprise Version 11.3.5.6, which supports Microsoft Edge with IE mode. You can then migrate to Automation 360.

[Supported Control Room versions for migration](#)

- If you are using Enterprise 11 and plan to complete migration to Automation 360 **before** IE EOL, you can migrate to the latest Automation 360 v.24R2 patch, which supports Microsoft Edge with IE mode.

- If you are using Enterprise 11 and plan to complete migration to Automation 360 **after** IE EOL, you can use one of the following methods:
 - Update to the latest Automation 360 release, convert the migrated bots created in IE to Microsoft Edge with IE mode.
 - Update to the latest Enterprise Client version that supports Microsoft Edge with IE mode and convert the pending bots created in IE to Microsoft Edge with IE mode in Enterprise 11, and later migrate these bots to the latest Automation 360 release.
- If you are using Automation 360 v.24 On-Premises or earlier and have created IE bots, you can update to Automation 360 v.24R2 patch to convert your IE bots to Microsoft Edge with IE mode.

Note: To ensure that your bots continue to run on Internet Explorer after EOL, Microsoft recommends that you register your site or application running on Internet Explorer to the Microsoft Site List manager. See [Enterprise Mode and the Enterprise Mode Site List](#).

For additional information on different upgrade scenarios, see [Enterprise 11 and upcoming Internet Explorer 11 EOL FAQ](#) | [Microsoft Internet Explorer 11 EOL FAQ](#)

IE bot update workflow

Update from Automation 360 to Automation 360 On-Premises

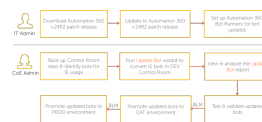

1. Update to the latest Automation 360 release.
Update to latest Automation 360 version
2. Set up Automation 360 Bot Runners for bot updates.
Install Bot Agent and register device
3. Back up the Control Room repository.
Restore bots from Git repository
4. Identify bots created in Internet Explorer using the Bot Scanner.
Scan Enterprise 11 or 10 bots using Bot Scanner
5. Convert the bots created in IE to Microsoft Edge with IE mode using the Update Bot wizard.
Update Bot wizard for converting IE bots
6. Analyze the updated bots report using the Update Bot wizard.
Viewing conversion details for Internet Explorer bots

7. Verify that the updated bots can run or be deployed.

[Schedule a bot](#) | [Run a bot](#)

Important: Before you deploy your bots, register your site or application running on Internet Explorer to the Microsoft Site List manager. For details, see [Enterprise Mode and the Enterprise Mode Site List](#).

Note that you can convert your IE bots to Microsoft Edge with IE mode in one environment (for example, DEV) and then move these bots to another environment (for example, UAT and PROD) without updating the bots in each environment.

Upgrade from Enterprise 11 to latest Automation 360 On-Premises

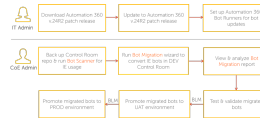

1. Upgrade from Enterprise 11 to the latest Automation 360 release that supports Microsoft Edge with IE mode.

[Prepare for Enterprise 11 to Automation 360 On-Premises migration](#)

2. Set up Automation 360 Bot Runners for bot updates.

[Install Bot Agent and register device](#)

3. Back up the Control Room repository.

[Restore bots from Git repository](#)

4. Identify the bots created in Internet Explorer using the Bot Scanner.

[Scan Enterprise 11 or 10 bots using Bot Scanner](#)

5. Migrate Bot Runners and IE bots from Enterprise 11 to Automation 360.

[Bot Migration Wizard](#)

6. View the bot migration report.

[View migration reports](#)

7. Verify that the migrated bots can run or be deployed.

[Schedule a bot](#) | [Run a bot](#)

Related concepts

[Microsoft Internet Explorer 11 EOL FAQ](#)

Microsoft has announced end-of-life (EOL) for Internet Explorer beginning June 2022 and recommends using Microsoft Edge or Microsoft Edge in Internet Explorer (IE) mode. This will impact automations (bots) based on the operating system currently in use where the bots are run.

[Microsoft Internet Explorer 11 EOL FAQ](#)

Microsoft has announced end-of-life (EOL) for Internet Explorer beginning June 2022 and recommends using Microsoft Edge or Microsoft Edge in Internet Explorer (IE) mode. This will impact automations (bots) based on the operating system currently in use where the bots are run.

Related reference

[Automation 360 v.24R2 Release Notes for Internet Explorer 11 EOL](#)

Related information

[Enterprise 11 and upcoming Internet Explorer 11 EOL FAQ](#)

Microsoft Internet Explorer 11 EOL FAQ

Microsoft has announced end-of-life (EOL) for Internet Explorer beginning June 2022 and recommends using Microsoft Edge or Microsoft Edge in Internet Explorer (IE) mode. This will impact automations (bots) based on the operating system currently in use where the bots are run.

For details, see the following table:

Microsoft operating system	Automation 360 and Enterprise 11 bots
Windows 10 Semi-Annual Channel	Update bots to use a compatible browser. For a list of supported browsers, see Browser requirements for RPA Workspace .
All other supported operating systems	No immediate impact

Starting from the Automation 360 v.25 release, you will be prompted to access the Control Room through an alternative supported browser, such as Google Chrome or Microsoft Edge (Chromium) instead of Internet Explorer. Your Control Room will no longer be accessible on Internet Explorer. By aligning with the Microsoft strategy for browser support, we can provide you with enhanced functionality that latest browsers such as Google Chrome and Microsoft Edge make technologically possible.

General FAQ

How do I know if I am going to be impacted by the Internet Explorer EOL?

To assess whether you are actually impacted by the Internet Explorer EOL, you need to do the following:

- Check whether the underlying legacy application or website can run only on Internet Explorer and is not moved to any other browser.
- Check whether the device on which the bot is running has Windows 10 version using Semi-Annual Channel (SAC) license.

If the answer to both of the above is Yes, you are impacted by the Internet Explorer EOL.

Why this change?

Microsoft recently announced that Internet Explorer will be retired on June 15, 2022 for certain versions of Windows operating systems.

When will the support end?

While we will end support for the Control Room on Internet Explorer, we will continue to add new and advanced features that will be supported on alternative browsers.

[Browser requirements for RPA Workspace | Internet Explorer EOL](#)

Can I connect to Enterprise 11 or Enterprise 10 Control Room?

Starting from the upcoming Automation 360 v.25 release, any user trying to access the Control Room through Internet Explorer will be prompted to use alternative browsers such as Google Chrome or Microsoft Edge (Chromium).

What about the automations that I have already built using Internet Explorer?

You can continue to use Internet Explorer to connect to the Enterprise 11 Control Room.

Microsoft is planning to discontinue support for Internet Explorer from June 2022 on certain operating systems. If this change impacts you, you should start planning to update your automations to use other browsers, such as Microsoft Edge (Chromium).

See [Internet Explorer EOL](#) for list of Windows operating systems supporting Internet Explorer.

For information about scenario-based automation updates, see [Migration FAQ](#).

Does the EOL impact my running automations if they are running on OS versions other than Windows 10 Professional or Enterprise licensed through the Semi-Annual Channel (SAC)?

No, your automations will not be impacted if they are running on OS versions other than Windows 10 Professional or Enterprise licensed through SAC. For more information, see the FAQ available from Microsoft.

[Internet Explorer EOL](#)

My organization has legacy apps and websites based on Internet Explorer 11 that are automated using Automation 360. We plan to move our legacy apps to Microsoft Edge with Internet Explorer mode before the EOL date. What will happen to my existing automations built on Internet Explorer 11?

After you move your legacy apps to Microsoft Edge with Internet Explorer mode, the automations that you previously built on Internet Explorer 11 will run only after you edit them and make them work for Microsoft Edge with Internet Explorer mode.

You might have to capture the objects again and update the corresponding actions on these objects so that the automations can run successfully on Microsoft Edge with Internet Explorer mode.

My application is running on Microsoft Edge with Internet Explorer mode. Can I create and run object-based automations on Microsoft Edge with Internet Explorer mode using Automation 360?

Yes, starting from Automation 360 v.23, object-based automations are supported for Microsoft Edge with Internet Explorer mode. You can record objects and perform various actions by using Universal Recorder to automate your applications that run on Microsoft Edge with Internet Explorer mode.

Note: A separate plug-in extension is not required. You can use the Microsoft Edge plug-in extension

Will Automation Anywhere provide any tool to convert automations that use Internet Explorer to Microsoft Edge?

for your Microsoft Edge browser with Internet Explorer mode as well.

Microsoft recommends users to use Microsoft Edge in Internet Explorer Compatibility mode. We will be providing a utility to convert automations that use Internet Explorer to use Microsoft Edge in Internet Explorer Compatibility mode.

Migration FAQ

What is the guidance for Automation 360 users on the general availability of a conversion tool?

For Automation 360 users, we are planning a patch release on Automation 360 v.24 for On-Premises and Cloud users. You must apply this patch to take advantage of the support for Microsoft Edge with Internet Explorer mode. This patch contains packages that are certified on Microsoft Edge in Internet Explorer mode and a bot update wizard. You can either manually update your bots or use the bot update wizard to update your bots in bulk so that they work with Microsoft Edge in Internet Explorer mode.

Note: On-Premises users can get early access to this patch to test it in the dev environment.

What is the guidance for Enterprise 11 users on the general availability of a conversion tool?

For Enterprise 11 users, we are planning to release a patch on the Version 11.3.5.x trail to support Microsoft Edge in Internet Explorer mode. You must update to the latest version to take advantage of this patch. Along with this patch, a conversion utility and an enhanced Bot Scanner will also be released. With the enhanced Bot Scanner, you can get statistics on the usage of Internet Explorer in your bots so that you can plan and devise an overall conversion strategy. You can either manually update your bots or use the conversion utility to convert your bots in bulk to work with Microsoft Edge in Internet Explorer mode.

Note: You can get early access to this patch to test it in the development (dev) environment.

If you are migrating from Enterprise 11 to Automation 360, you can combine the migration and conversion of your bots to use Microsoft Edge in Internet Explorer mode in a single operation after updating to the Automation 360 v.24 patch.

What options are available for users to maintain business continuity if their automations are being affected by the Internet Explorer EOL?

You can maintain business continuity by choosing one of the following options:

1. Change the license of your Windows version from Semi-Annual Channel (SAC) to Long-Term Servicing Channel (LTSC).

For details, see [Internet Explorer EOL](#).

2. Upgrade the Windows operating system version for your device that is running automations to a version other than Windows 10 SAC.

For details, see [Internet Explorer EOL](#).

3. Manually edit the affected bots by recapturing the application objects by using supported browsers (other than Internet Explorer) and change the window titles, variables, or any of the corresponding actions that are browser-specific. Validate your automation and run the updated bots on target applications in the selected browser.

Note: This is not applicable to migrated Enterprise 11 or Enterprise 10 bots that use the Web Recorder command.

4. Recreate the bots, replacing the old ones by using any of the supported browsers, such as Microsoft Edge or Google Chrome.

5. Use the conversion tool provided by Automation Anywhere to convert your bots based on Internet Explorer to Microsoft Edge with Internet Explorer mode.

Note: The tool cannot be used to convert bots built in Internet Explorer to other supported browsers, such as Google Chrome, Microsoft Edge (Standard mode), or Mozilla Firefox.

After the Windows update, Internet Explorer requests are redirected to Microsoft Edge. Will the IE mode be set automatically or need to be set manually?

- The approach recommended by Microsoft is to register your site or application running on Internet Explorer to the Microsoft Site List manager.

For details, see [Enterprise Mode and the Enterprise Mode Site List](#).

- Alternatively, you can list certain websites to open only in IE mode by using the Microsoft Edge IE mode compatibility settings in Microsoft Edge. Note that these settings need to be updated every 30 days.

Migration scenario A: If you are new to Automation 360 and have bots built using Internet Explorer, or if you have migrated from Enterprise 11 or Enterprise 10 to Automation 360 and have bots built using Internet Explorer, review the following information.

What do I need to do to ensure that my automations built on Internet Explorer continue to run after Internet Explorer reaches EOL?

To ensure that your automations continue to run on Internet Explorer after EOL, you need to do the following:

- Register your site or application running on Internet Explorer to the Microsoft Site List manager. For details, see [Enterprise Mode and the Enterprise Mode Site List](#).
- Update Automation 360 to the latest patch on Automation 360 v.24 release with support for Microsoft Edge with Internet Explorer mode.
- Use the Update bot wizard to convert each bot running on Internet Explorer to Microsoft Edge with Internet Explorer mode.
 - Bots that do not use commands related to Internet Explorer will not be converted.
 - If the bot update is completed without any errors, a new version of the bot will be created in the Control Room public repository.
- Check the update bot report to see whether you need to review the updated bot or take any action.
- Run the updated bot to validate that the bot runs fine in Microsoft Edge with Internet Explorer mode.

I am using an earlier version of Automation 360 On-Premises. Can I directly update to Automation 360 v.24 patch release or should I manually uninstall the previous version and install the new patch version?

Yes, you can directly update your existing Automation 360 version to the latest Automation 360 v.24 patch release.

Note that we support directly updating from $n-3$ releases (where n is the latest release). For updating from a version of Automation 360 earlier than that, you must perform a multistep update. For example, if you are on Automation 360 v.19, you must first update to Automation 360 v.22 and then to Automation 360 v.24.

Do I need to update my Automation 360 Bot Agent?

Yes, the Bot Agent needs to be updated.

Starting from the Automation 360 v.24 release, Bot Agent update is optional with some releases.

Migration scenario B: If you are currently on Enterprise 11 or Enterprise 10 and plan to migrate to Automation 360, review the following information.

I have not started the migration to Automation 360 yet. What is your recommendation for planning the migration?

Migration to Automation 360 involves the conversion of the Enterprise 11 or Enterprise 10 bots to Automation 360 compatible format so that the converted bot runs successfully in Automation 360.

If these bots are automated using Internet Explorer 11, then you will have to include the efforts involved in further converting these bots to Microsoft Edge with Internet Explorer mode and validate the bots in the new browser.

If you are on Enterprise 11 and are impacted by Internet Explorer EOL, our recommendation is that you continue on Enterprise 11 and convert the bots related to Internet Explorer to Microsoft Edge with Internet Explorer mode so that you can test and validate the bots before the EOL date.

For details on the conversion tool, see [Enterprise 11 and upcoming Internet Explorer 11 EOL FAQ](#). Migration to Automation 360 can be planned at a later date according to your convenience.

If you are on Enterprise 10 and are impacted by Internet Explorer EOL, we recommend that you migrate to Enterprise 11 first and convert the bots related to Internet Explorer to Microsoft Edge with Internet Explorer mode so that you can test and validate the bots before the EOL date.

For details on the conversion tool, see [Enterprise 11 and upcoming Internet Explorer 11 EOL FAQ](#). Migration to Automation 360 can be planned at a later date according to your convenience.

For any new bots that you plan to build in Enterprise 11 or Enterprise 10, we recommend that you build them in Automation 360 by using any of the supported browsers to minimize the impact of the Internet Explorer EOL.

Migration scenario C: If you are currently on Enterprise 11 or Enterprise 10 and are in the middle of migration to Automation 360, review the following information.

I have migrated a few bots to Automation 360, which use Internet Explorer, and have a few bots that are pending migration in Enterprise 11, which use Internet Explorer. What is your recommendation regarding maintaining two parallel environments?

If you are in the middle of your migration journey, maintaining two parallel environments where there are bots based on Internet Explorer on both Enterprise 11 and Automation 360 versions, then you need to ensure that these bots are converted to Microsoft Edge in Internet Explorer mode in their respective environments in case you cannot complete migration of your pending Enterprise 11 bots to Automation 360 before the Internet Explorer EOL.

For Enterprise 11 bots based on Internet Explorer, upgrade your Enterprise 11 to the latest Version 11.3.5.x patch release, which supports Microsoft Edge with Internet Explorer mode. After the upgrade, use the Enterprise 11 conversion utility to convert these bots in Microsoft Edge with Internet Explorer mode so that these bots continue to run in Enterprise 11 even after the Internet Explorer EOL.

Similarly, for Automation 360 bots based on Internet Explorer, update to the latest Automation 360 v.24 patch release, which supports Microsoft Edge with Internet Explorer mode. After the update, use the Automation 360 bot update wizard to convert these bots in Microsoft Edge with Internet Explorer mode so that these bots continue to run in Automation 360 even after Internet Explorer EOL.

You can later decide when to migrate the Enterprise 11 bots converted to Microsoft Edge with Internet Explorer mode to Automation 360. When you decide to do so, note that you can use the Automation 360 Bot migration wizard without the **Convert bots built using IE to Edge with IE mode** option.

For details, see [Bot Migration Wizard](#).

Note: For Enterprise 10 bots based on Internet Explorer, we do not plan to release a patch on Enterprise 10 that supports Microsoft Edge with Internet Explorer mode. Hence, Enterprise 10 users must ensure that their bots based on Internet Explorer are migrated to Automation 360 v.24 patch release.

How can I determine which bots use commands or actions related to Internet Explorer and hence require conversion to Microsoft Edge with Internet Explorer mode?

For Enterprise 11 bots, you can run the Bot Scanner utility with an option to scan bots for Internet Explorer usage. This utility generates a report that lists all the bots that use commands related to Internet Explorer.

For Automation 360 bots, the tool to scan bots and generate Internet Explorer usage report is currently not available.

Do I need to manually change the bot after it is migrated to Automation 360 using the Bot Migration Wizard along with the Convert bots built using IE to Edge with IE mode option?

Yes, only for bots that are migrated to Automation 360 with **Action Required** or **Review Required** messages. Review the messages in the Migration Report that suggest that the user edit the bot, for example, if the bot uses a reference of Internet Explorer in the window title through a variable, file, and so on.

Contact your assigned CSM or Support for any further questions about this change.

Known behavior and limitations

The following table lists known behavior and limitations that apply to bots migrated from Enterprise 11 to Automation 360 and to Automation 360 bots that run on Microsoft Internet Explorer and are converted to Microsoft Edge with IE mode.

Description	Applies to Enterprise 11 to Automation 360 (migration)	Applies to Automation 360 to Automation 360 (updating)
The bot conversion utility updates only bots that use Internet Explorer for automations and does not update bots that use other browsers.	Yes	Yes
For web pages or URLs to open in Microsoft Edge with Internet Explorer mode, you must register your site or application running on Internet Explorer to Microsoft Site List Manager or Group Policy within your organization. <i>Enterprise Mode and the Enterprise Mode Site List</i>	Yes	Yes
The Open Program/File command that contains a variable to store the location of the program or file property is not migrated or converted to use Microsoft Edge with Internet Explorer mode. If the variable is pointing to Internet Explorer, update it to point to Microsoft Edge browser instead.	Yes	Yes
The following commands are not migrated or converted because browser components such as the menu bar, status bar, favorites bar, command bar, and other non-web page components differ in each browser. This can potentially impact captured screens or properties of the actions. We recommend that you review and recapture the screen or update the properties if required. <ul style="list-style-type: none"> • Image Recognition • OCR • Mouse • Wait> Wait for screen (Menu/Non-HTML objects) • Screen • Recorder • App Integration > Capture area 	Yes	Yes
Keystroke action that is based on the menu bar of a browser is not migrated or converted.	Yes	Yes
For Mouse commands such as Click, Move or Scroll , due to the difference in header bar height in Internet Explorer and Microsoft Edge with Internet Explorer mode, there might be an incorrect Y-axis after the migration or conversion. Note: This difference applies only to the Y-axis and not X-axis.	Yes	Yes

Description	Applies to Enterprise 11 to Automation 360 (migration)	Applies to Automation 360 to Automation 360 (updating)
<p>In the Image Recognition command, when the target image is on the lower and upper boundaries of the source image, the command is not migrated or converted because of the difference in the height of the header bar in Internet Explorer and Microsoft Edge browsers. The following target actions are impacted: Right click, Left click, and Double click.</p>	Yes	Yes
<p>Review and recapture all commands, except Image Recognition that captures window coordinates with negative values, after migration or conversion.</p> <hr/> <p>Note: In Enterprise 11, the coordinates are captured the top-left of the screen at 0, 0. In Automation 360, the coordinates are captured as negative values.</p> <hr/>	Yes	Yes
<p>Due to differences in the height of the header bar in Internet Explorer and Microsoft Edge with Internet Explorer mode, the output of the actions might not be as expected. The following commands are impacted:</p> <ul style="list-style-type: none"> • OCR> Capture area • Mouse <ul style="list-style-type: none"> • Button: Left button, Middle button, Right button • Event: Click, Double click, Button down, Button up • Screen> Capture area 	Yes	Yes
<p>Window titles with regular expression variables containing partial text from Internet Explorer might be converted to the corresponding title in Microsoft Edge. However, sometimes the conversion might not happen. For example:</p> <ul style="list-style-type: none"> • Internet • .Int, • Int • Expl* • .Expl • Internet Exp 	Yes	Yes
<p>Using the Microsoft registry setting, if you have changed the default text of the Internet Explorer window title bar to your preferred text, the changes applied on the title bar are not available after conversion.</p>	Yes	Yes

Description	Applies to Enterprise 11 to Automation 360 (migration)	Applies to Automation 360 to Automation 360 (updating)
<p>In the Open Program/File, if you have used the <code>taskkill /F /IM iexplore.exe</code> command to terminate Internet Explorer, then after conversion, when you run the bot, it will forcefully terminate <code>msedge.exe</code>. But when you run the bot for the second time, it will display a <code>Microsoft Edge Closed Unexpectedly</code> error message. We recommend that you avoid the use of <code>/F</code> so that the bots run seamlessly.</p>	Yes	Yes
<p>Local HTML files are not supported for loading in Microsoft Edge with Internet Explorer mode through Enterprise Site List Manager.</p> <p>Workaround: You can deploy the local HTML file in localhost.</p> <p>Example: The <code>file:///C:/SampleHTML/sample.html</code> URL will be replaced with <code>https://localhost/SampleHTML/sample.html</code></p>	Yes	Yes
<p>The wait for the browser does not work for Microsoft Edge with Internet Explorer mode for commands such as Mouse, Insert Keystrokes, or Recorder. After conversion, the User32 API does not return the child window list. As a result, it cannot find the page Microsoft Edge with Internet Explorer mode.</p>	Yes	Yes
<p>Object Cloning commands developed on a Citrix environment with Xen App Remote Agent and Microsoft Edge with Internet Explorer mode are not supported.</p> <p>Object Cloning commands developed on Silverlight and Flash technologies and Microsoft Edge with Internet Explorer mode are not supported.</p>	Yes	Not applicable

Description	Applies to Enterprise 11 to Automation 360 (migration)	Applies to Automation 360 to Automation 360 (updating)
<ul style="list-style-type: none"> Object Cloning commands (with coordinates play mode) where Internet Explorer based toolbar is enabled and locked are not migrated or converted. Object Cloning commands (with coordinates play mode) are not migrated or converted because browser components such as menu bar, status bar, favorites bar, command bar, and other non-web page components differ in each browser. This can potentially impact the captured screens or the properties of the actions. We recommend that you review and recapture the screen or update the properties if required. Due to the difference in the height of the header bar in Internet Explorer and Microsoft Edge with Internet Explorer mode, an incorrect Y-axis might occur after the migration or conversion. This difference can be seen in Get text, Set text, Left click, Right click, Middle click, Double click of the coordinates play mode. <hr/> <p>Note: This difference applies only to the Y-axis and not X-axis.</p> <hr/>	Yes	No
Migrated bots with Mouse Click command might not work as expected when the Relative to property is Screen. This is because of the difference in the offset of the address bar between Internet Explorer and Microsoft Edge.	Yes	Yes
Objects captured on Internet Explorer using Standard or Legacy technology in the Object Cloning command will not work after migration or conversion.	Yes	No
The commands that store window titles with wildcard characters such as *Applet* are based on the Internet Explorer browser window with Web Java technology. If you have selected the None of the above option for such commands, note that the commands will not work in Microsoft Edge with IE mode as these are not migrated to Edge.	Yes	No
Bot Scanner does not count the commands that use variables to store the window title as part of the statistics. However, these commands are displayed in the Review Required tab so you can review these commands manually to verify if the window title is based on the Internet Explorer browser window.	No	Yes
User Interface (UI) based and window triggers with Internet Explorer based window title are not migrated or converted.	No	Yes

Description	Applies to Enterprise 11 to Automation 360 (migration)	Applies to Automation 360 to Automation 360 (updating)
<p>Recorder developed on a Citrix environment with Xen App Remote Agent, and Microsoft Edge with Internet Explorer mode is not supported.</p> <p>Recorder actions developed on Silverlight and Flash technologies and Microsoft Edge with Internet Explorer mode is not supported.</p>	Not applicable	Yes
<p>For the Bot Migration Wizard and Update Bot wizard, when you select the Bot Assistant screen to view the migration review and action messages, the review message is not displayed based on the version. In the Update Bot Assistance menu, the review message is overridden by the migration review message.</p>	No	Yes
<p>When you use the Update Bot wizard to convert Automation 360 bots that run on Microsoft Internet Explorer to Microsoft Edge, the In progress status will be shown indefinitely for the following scenarios:</p> <ul style="list-style-type: none"> • When the bot fails to compile • When the bot fails to deploy • When the Bot Agent service stops or fails • When the Bot Runner user is not assigned the Allow a Bot user to update bots permission 	Not applicable	Yes

Related concepts

[Microsoft Internet Explorer EOL overview](#)

Microsoft has announced retiring Internet Explorer (IE) for certain versions of Windows operating systems and recommends impacted users to move their apps or websites running on IE to Microsoft Edge with IE mode.

[Microsoft Internet Explorer EOL overview](#)

Microsoft has announced retiring Internet Explorer (IE) for certain versions of Windows operating systems and recommends impacted users to move their apps or websites running on IE to Microsoft Edge with IE mode.

Related reference

[Automation 360 v.24R2 Release Notes for Internet Explorer 11 EOL](#)

Related information

[Enterprise 11 and upcoming Internet Explorer 11 EOL FAQ](#)

Scan Automation 360 bots for Internet Explorer usage

Microsoft Internet Explorer end of life (EOL) is in June 2022, and Microsoft recommends that you to move your legacy applications and websites running on Internet Explorer to Microsoft Edge with IE mode. Use the Automation 360 Bot Scanner for IE utility to scan your Automation 360 bots for Internet Explorer usage.

- Ensure that your Control Room user has the **View content** permission on the `Bots` folder.

- Ensure that you meet the following system requirements for using the Bot Scanner:

- **Hardware requirements**

Processor	2.66 GHz or higher (64-bit)
RAM	2 GB or higher
Disc space	200 MB

- **Software requirements**

Operating systems: Windows 7 or later (32-bit or 64-bit)

1. Navigate to [A-People Downloads page \(Login required\)](#).
2. Download `automation-360-bot-scanner-for-ie-1.0.zip` from **Automation 360 v.24 R2 (13343) > Installation Setup**.
3. Extract the files from the zip file you have downloaded and double-click the executable file to run the utility.
4. Click **Get started**.
5. Enter the Control Room URL of Automation 360 (On-Premises or Cloud) that you want to connect to, and access the `Bots` repository that contains the Internet Explorer bots that you want to scan.

Note: The Bot Scanner for IE utility does not support a proxy server. If you use a proxy to provide the Control Room URL, you will not be able to establish the connection.

6. Based on the authentication type configured in your Control Room, choose one of the following authentication methods in the **Authentication Type** field:

Authentication type	Steps
Database	<ol style="list-style-type: none"> a. Enter the Username (Control Room database username). b. Enter the Password (Control Room database user password).
Active Directory (default)	<ol style="list-style-type: none"> a. Enter the Username (Domain\\username). b. Enter the Password (domain user password).
Single Sign-On	<ol style="list-style-type: none"> a. Enter the Username. b. Enter the API Key.

7. Click **Test connection**.
A connection success or failure message is displayed. Recheck your credentials if the connection fails.
8. In the **Select destination path** field, enter the location where you want to save the generated report.
9. Click **Scan bots**.
The scanner scans all the bots in the Control Room repository for Internet Explorer usage. After the scan is complete, a report is generated (.CSV file) containing all the details. If a .CSV file already exists in the output folder, you are prompted with a message indicating that the old .CSV file will be deleted, and after you click **Continue**, a new .CSV file is generated. If the old .CSV file is in use, a message is displayed indicating that the file cannot be deleted. Close the file and try again.

10. Click **Open report** to analyze the report generated by the scanner to get usage statistics about Internet Explorer in your bots.

The report contains the following details:

- TaskBot name: Name of the TaskBot
- Line number: The line number of the bot where the Internet Explorer browser is used
- Package and action name: The package and action name where the Internet Explorer browser is used
- Searched text: Provides the window or browser title
- Action and review message: Contains the reviews or action required by the user after conversion
- TaskBot path: The path to the repository where the bot resides

Note: Based on the report generated by the scanner, you can plan and implement a strategy to convert bots that use Internet Explorer to Microsoft Edge with IE mode. Using the report you can identify the following:

- Unique TaskBot names that use Internet Explorer
 - The action in each bot that uses Internet Explorer
 - Whether an action can be converted or not
 - Whether an action needs review after conversion
-

See the following video on how to scan Automation 360 bots for Internet Explorer usage:

<https://fast.wistia.net/embed/iframe/kvjnkstc8x>

The Bot Scanner does not convert your bots from Internet Explorer to Microsoft Edge with IE mode. For conversion, you must use the Update Bot wizard. See [Update Bot wizard for converting IE bots](#).

Analyze report for Internet Explorer bots

You can analyze the report generated by the Bot Scanner to get usage statistics about Internet Explorer used in your bots.

Based on the report that Bot Scanner generates, you can plan and implement a strategy to convert bots that use Internet Explorer to Microsoft Edge with IE mode.

Bot Scanner provides the following information about these bots:

- Number of bots analyzed
- Number of bots scanned for Internet Explorer usage and those that were not scanned
- Internet Explorer usage statistics on the percentage and number of bots using Internet Explorer
- Reasons for bots that were not scanned
- Reviews required by users after conversion

The Bot Scanner is designed to scan bots (TaskBots and MetaBots) created using both Enterprise 10 and Enterprise 11 versions of Enterprise Client. The total file count includes the number of files that were skipped and not scanned.

Folder location and reports

The reports are available at the output location you specified in the **Select destination folder** field in the **Automation Anywhere Bot Scanner** dialog box. The Bot Scanner generates a summary report and

a separate report for each bot that it scanned. It creates a separate report for each logic available in a MetaBot.

A `raw-data` folder is created that contains the reports (in XML format) for each bot scanned. It helps our developers to further analyze the scanning process and take corrective actions, if required. No personally identifiable information (PII) is included in the summary report or the individual reports of the scanned bots.

If you choose to share the reports with us to help improve the product, compress the files in the `rawdata` folder and coordinate with your Customer Success Manager (CSM) or Partner Enablement Manager (PEM). No data is automatically shared with Automation Anywhere.

The system creates three folders within the `raw-data` folder that contain various reports:

- `Migratable_Bots`: Contains reports of bots that are possibly using Internet Explorer.
- `Failed_to_Analyze`: Contains reports of bots that Bot Scanner failed to analyze.
- `MetaBots`: Contains reports of MetaBots that can and cannot be migrated to Automation 360 and the ones that the Bot Scanner failed to analyze.

Summary report for all bots

The summary report provides information about the total number of bots scanned, the number of bots scanned for Internet Explorer usage, the number bots that could not be scanned. It also provides Internet Explorer usage statistics about the percentage and number of bots using Internet Explorer.

For example, consider the Bot Scanner has scanned 31 bots. Of the 31 bots, consider 26 bots are scanned for Internet Explorer usage, and 0 bots could not be scanned. The percentage of bots using Internet Explorer is 84%.

Reviewing the Bot Scanner report

Consider a scenario where you have scanned a total of 72 bots, of which 22 bots are scanned for Internet Explorer usage and 3 bots could not be scanned. In such a scenario, the report enables you to perform the following actions:

- Identify bots (8) that require review after conversion and take action if required.
- Identify bots (14) that do not require any review after conversion.
- Identify the reason why the bots (3) cannot be currently scanned for Internet Explorer usage. The reason might be that the bot is built using a version earlier to Enterprise 10 such as Enterprise 8.

The following image is a sample report from the Bot Scanner:

Automation 360 Bot Scanner Report For IE Usage Generated by Automation 360 Bot Scanner v.24 [How to read this report](#)

Internet Explorer Usage Statistics:

- 31% of bots are using Internet Explorer (22 Bots)
- 20 distinct command(s) use Internet Explorer

Each metabot is counted as the number of logics that it holds, in the Bot Scanner report.

22 Bots scanned for IE usage | 3 Bots that can't be scanned now | 72 Bots scanned total

1 Review required | 2 No review required | 4 Download .csv

Bot name	Path
1 AppInt IE Regexp Variable Review	C:\Work\Scanner\Source\Scanner test data\Test data\action\IE\All IE Cases\Applint Regexp\
2 Elseif All Conditions	C:\Work\Scanner\Source\Scanner test data\Test data\action\IE\All IE Cases\Elseif\
3 If Condition all	C:\Work\Scanner\Source\Scanner test data\Test data\action\IE\All IE Cases\If\
4 IR Review Positive Coord	C:\Work\Scanner\Source\Scanner test data\Test data\action\IE\All IE Cases\IR, OCR, Mouse,Screen, Wait\
5 Wait Review	C:\Work\Scanner\Source\Scanner test data\Test data\action\IE\All IE Cases\IR, OCR, Mouse,Screen, Wait\
6 Loop Conditions	C:\Work\Scanner\Source\Scanner test data\Test data\action\IE\All IE Cases\Loop\
7 OPF Review IE Var	C:\Work\Scanner\Source\Scanner test data\Test data\action\IE\All IE Cases\OpenPrgFile\
8 OPF Review Non IE Var	C:\Work\Scanner\Source\Scanner test data\Test data\action\IE\All IE Cases\OpenPrgFile\

The following table describes the various fields in the sample Bot Scanner report (as numbered in the previous image):

Field/option	Description
1	<ul style="list-style-type: none"> Bots scanned for IE usage > Review required > Bots: Go to this view for a list of bots (8 in this scenario) that should be reviewed after conversion. To view the review required message for a specific bot, click the bot name. The message provides information about changes if any are required in the bot after conversion.
2	<p>Bots scanned for IE usage > No review required > Bots: Go to this view for a list of bots (14 in this scenario) that do not require any review after conversion. Click any bot name in this list to view the XML report offline.</p>
3	<ul style="list-style-type: none"> Bots that can't be scanned now > Bots: Go to this view for a list of bots (3 in this scenario) that cannot be currently scanned. To view the error message for a specific bot, click the bot name. An XML report opens in a new tab where you can view the error due to which the bot cannot be scanned.
4	<p>Download (as a CSV file) the list of bots or commands that can or cannot be scanned so that you can review the file offline or share the file with others.</p>

Report validity

The report is valid until the next version of Bot Scanner is available. When the next version is available, a report expiry message is displayed. You must download the latest version of Bot Scanner and use that version to scan the bots again.

Update Bot wizard for converting IE bots

Use the Update Bot wizard to convert Internet Explorer bots created in Automation 360 to Microsoft Edge with IE mode.

- Ensure you are logged in as an administrator or have given the following permissions to the user performing the bot update and to the Bot Runners you have selected:
 - Users performing the bot update:
 - **View bot update**
 - **Manage bot update**
 - **View Users and Roles basic information**
 - **View everyone's audit log actions**
 - **View packages**
 - **View my bots**
 - **Run my bots**
 - You must have the below-mentioned permissions for `Bots`, `Sample bots`, and the folders containing the bots you want to update:
 - **Run**
 - **Check in**
 - **Check out**
 - **View content**
 - A role that has access to Bot Runners that you want to select for running the update (on the **Administration > Bot update > Bot Runners** page)
 - Bot Runners:
 - An unattended Bot Runner license
 - **Autologin Set** status
 - **Allow a bot-runner user to update bots**
 - **Create folders**
 - **View packages**
 - **Register device**
 - **View my bots**
 - **Run my bots**
 - Below permissions for the folders containing the bots you want to update,
 - **Check in**
 - **Check out**
 - **Default device** settings

For more information on creating users and roles, see [Create a user](#) and [Create a role](#).

- The Internet Explorer bots should already be identified for conversion.
- The bots must be **Checked in** and available in the **Public** workspace.

Note: You cannot use the Update Bot wizard to convert Enterprise 10 and Enterprise 11 bots created using Internet Explorer. For details, see [Bot Migration Wizard](#).

See the following video for an overview of the Bot update wizard:<https://fast.wistia.net/embed/iframe/3weby2x1rm>

1. Navigate to **Administration > Bot update** in the Control Room.
If you have **not** performed any bot updates previously, the **Bot update list** on the **Bot update** page will not display bot updates.
2. Click **Update bots** to open the Update Bot wizard.
3. In the **Settings** tab, add details such as the name and description to update bots.
4. Click **Next**.
5. On the **Bots** tab, navigate to the Bots folder that contains the Internet Explorer bots.
6. Select bots from the list of available files and add the bots to the list of selected files.
You can choose from the latest or production version bots.

Note: You do not have to select the dependent bots because the dependent bots are selected automatically.

7. Click **Next**.
8. Select Bot Runner devices from the list of Bot Runners to run the bot update.
9. Click **Next**.
10. Verify details such as the bot type, name, version, and folder path on the Bot and Dependent Bots tab.
11. Click **Update bots**.

The selected bots and dependent bots are deployed on the selected Bot Runners for conversion from IE to Microsoft Edge with IE mode. The bots are converted one at a time and a new version of the bots is uploaded to the Control Room public repository. A new entry for updated bots is created during the bot conversion process on the **Bot update list** page.

The page shows the status and summary of the bots updated for conversion. You can refresh the page to view the current bot conversion status.

Status	Name	Start time	End time	Duration	Completed	Failed	Skipped	Total	Last modified	Modified by
In progress	updatebots-admin-22-04-22-10-34	9 minutes ago	N/A	0 sec	0	0	0	1	9 minutes ago	admin
Completed	updatebots	22-04-21-18-50:59	18 hours ago	18 hours ago	42 sec	1	0	30	31	18 hours ago
Completed	updatebots	22-04-21-17:00:40	20 hours ago	20 hours ago	28 sec	9	0	0	9	20 hours ago
Completed	updatebots	22-04-21-11:53:18	1 day ago	1 day ago	38 sec	13	0	0	13	1 day ago
Completed	updatebots	22-04-20-22:50:20	1 day ago	1 day ago	24 sec	2	0	1	3	1 day ago
Completed	updatebots	22-04-20-20:46:27	1 day ago	1 day ago	30 sec	0	0	1	1	1 day ago
Completed	updatebots	22-04-20-20:33:50	1 day ago	1 day ago	35 sec	2	0	0	2	1 day ago
Completed	updatebots	22-04-20-15:24:20	1 day ago	1 day ago	33 sec	2	0	0	2	1 day ago
Completed	updatebots	22-04-20-15:02:42	1 day ago	1 day ago	32 sec	2	0	0	2	1 day ago

A list of the different bot conversion status during the conversion process is as follows:

- **In progress:** Indicates that the bot conversion has started.
- **Completed:** Indicates that the bot conversion process is completed.
- **Failed:** Indicates that the conversion of one or more bots has failed.

12. Select **View update bots details** from the actions menu (⋮) to view the bot conversion details of each bot.

See [Conversion report for IE bots](#).

See the following video on how to run the Bot update wizard:

<https://fast.wistia.net/embed/iframe/85dzj6yczf>

Related concepts

[Bot permissions for a role](#)

Assign bot permissions when creating a role with the **View my bots** feature permission.

Related reference

[Feature permissions for a role](#)

A user with the **AAE_Admin** role or a custom role with the **Manage roles** permission can create and assign roles to users to provide them with access to features and operations.

Viewing conversion details for Internet Explorer bots

For each update bot action, you can view details about the overall summary and status of individual bot conversion that is converted from Internet Explorer to Microsoft Edge with IE mode.

Viewing bot details

1. In the Control Room, go to **Administration > Bot update**.
2. Select an instance of the bot conversion from the list and click **View update bot details** action from the action menu for that instance.

The **Update details** page opens with detailed information about the name of the instance and the overall status of the bot conversion (at the top of the page). For more information, you can navigate to different tabs on this page: Summary, Settings, Bot Runners, and Results.

Summary details

You can view the following details in the **Summary** tab:

- Start time: Indicates the time when the bot conversion started
- End time: Indicates the time when the bot conversion completed
- Duration: Total duration taken for bot conversion to complete
- Completed items: Total list of items that are converted with completed status
- Failed items: Total list of items that failed to convert
- Skipped items: Total list of skipped items during conversion based on appropriate reasons
- Details of the selected bots and dependencies, listed in a table

The data is listed by file name by default. You can search for specific bots and dependencies by file name.

Settings

The **Settings** tab displays the following fields:

- Description: Displays any description you might have added before running the Update Bot wizard
- Update the bots built using Internet Explorer to Microsoft Edge Internet Explorer mode. By default, this field is set to **Yes**

Bot Runners

This tab displays the list of Bot Runners on which the bot conversion is done.

Results

View the status of individual bot conversion on this tab:

- Status: Status of the individual bot conversion (completed, skipped, failed)
- Type: Type of the bot, for example TaskBot
- File name: Name of the bot
- Folder path: Path where the bot resides in the public workspace
- Bot Runner: The Bot Runner machine used to perform the bot conversion
- Reason: Reason why the bot conversion is in either failed, skipped, completed with review required, or completed with action required status

When you click the **View Bot update** for an individual bot status entry in this tab, the following reason and action values for the bots are shown.

Status	Reason	Action
Pending	-	-

Status	Reason	Action
Completed	-	-
Skipped	The bot is not updated as it does not use actions based on Internet Explorer	-
Completed with Review Required	The bot has some actions updated that requires your review	View bot update issues
Completed with Action Required	The bot has some actions updated that requires your action	View bot update issues
Failed	The bot uses some actions that are not supported for update to Microsoft Edge with IE mode	View bot update issues

The view bot update page displays the following columns:

- Line number
- Action name
- Reason for Recommendation

You can view the information listed in the reason column for the line number and open the corresponding bot, go to the line number and review based on the information provided in the window or take action as required.

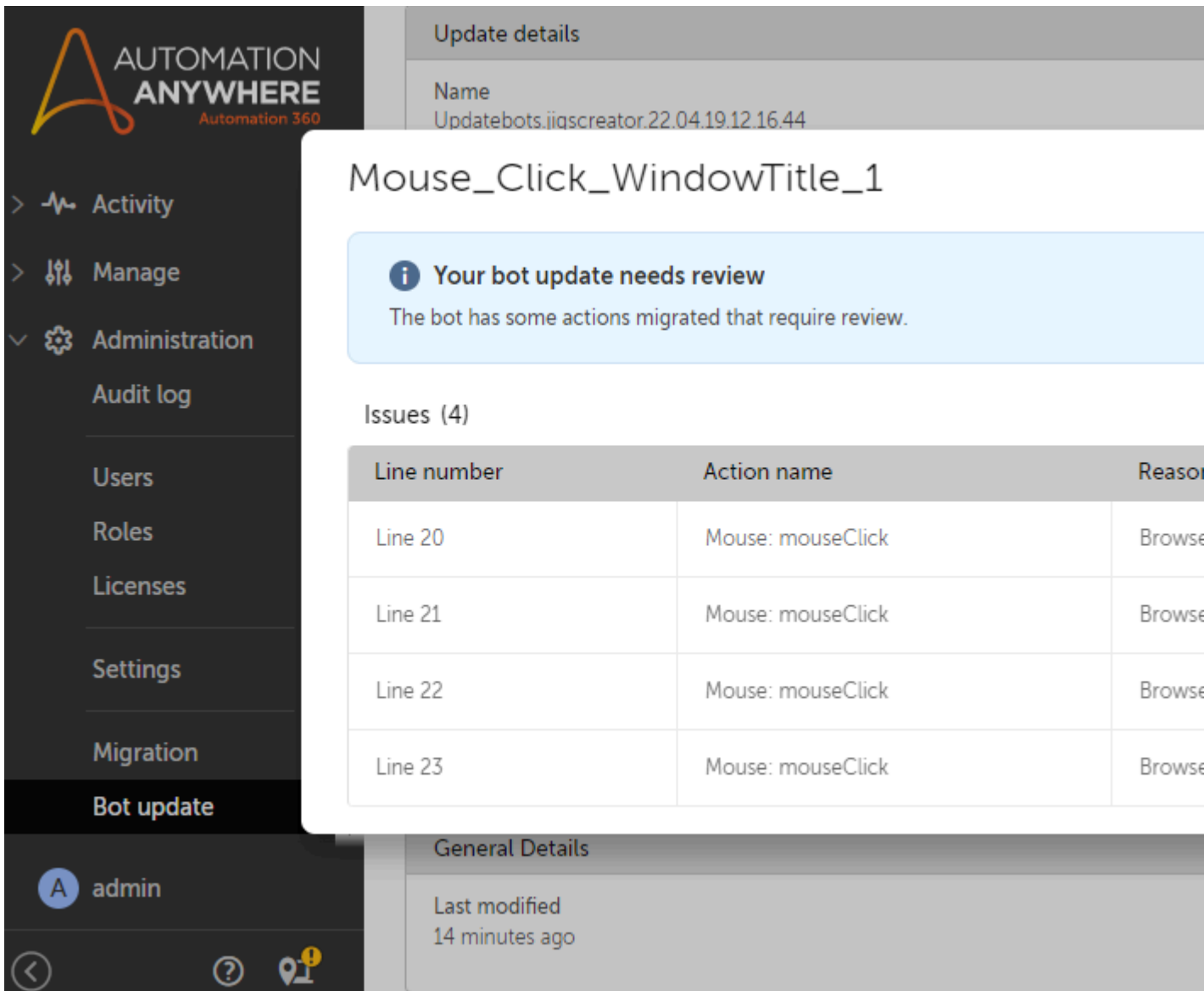

Deprecation of Basic authentication in Exchange Online

Microsoft will permanently disable Basic authentication for specific protocols in Exchange Online starting from October 1, 2022. This impacts customers running bot for email automation that connect to Exchange Online using IMAP, POP3, or EWS protocols with Basic authentication.

Important: We have updated the Email package and Email trigger with newer versions as mentioned below:

Package or trigger	New version	Old version
Email package	<ul style="list-style-type: none"> Version: 3.14.3-20220923-220748 Filename: bot-command-email-3.14.3.jar 	<ul style="list-style-type: none"> Version: 3.14.1-20220831-084727 Filename: bot-command-email-3.14.1.jar

Package or trigger	New version	Old version
Email trigger	<ul style="list-style-type: none"> Version: 2.8.3-20220923-171042 Filename: bot-trigger-email-2.8.3.jar 	<ul style="list-style-type: none"> Version: 2.8.1-20220831-123116 Filename: bot-trigger-email-2.8.1.jar

We recommend that you update your impacted bots with the new versions as they are compatible with the upcoming Automation 360 v.27 release. If you continue to use the old versions and update to Automation 360 v.27 release, you might encounter issues when importing or exporting of bots or when uploading the old versions of the Email package or trigger to Automation 360 v.27. To resolve this issue, see the workaround provided in [Everything about Basic Authentication deprecation in Microsoft Exchange online \(A-People login required\)](#).

We will provide a new version of the Email package with OAuth 2.0 support in an upcoming Automation 360 **package-only** release by the week of August 29, 2022.

To ensure that your existing bots that are using Basic authentication in Exchange Online are supported after Basic authentication is deprecated, we recommend that you update the bots to use OAuth 2.0. To identify the Automation 360 bots that are using Basic authentication in the Email package or Email trigger, use the Bot Scanner to scan bots. This helps you to plan your efforts to update your existing bots to OAuth 2.0 in Automation 360.

- [Bot Scanner overview](#)
- [Scan Automation 360 bots for Email action with Basic authentication usage](#)

Update Automation 360 bots to use OAuth 2.0

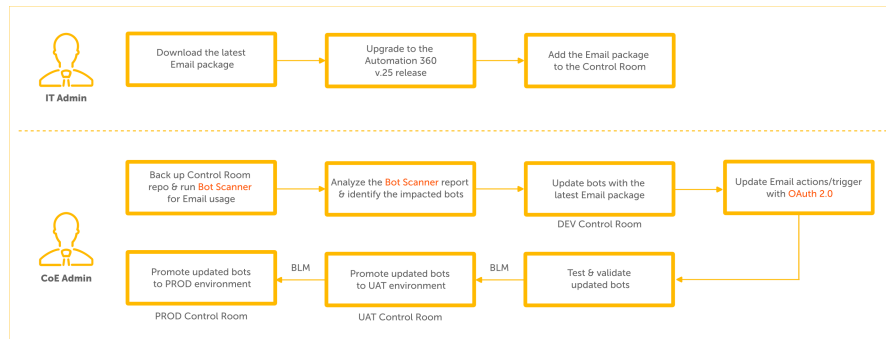

1. Update to the latest Automation 360 release.
 - [Update to latest Automation 360 version](#)
2. Back up the Control Room repository.
 - [Integrating Control Room with Git repositories](#)
3. Identify bots that are using Basic authentication using the Bot Scanner.
 - [Scan Automation 360 bots for Email action with Basic authentication usage](#)
4. Download the latest version of the Email package and add it to your Control Room.
 - [Add packages to the Control Room](#)

5. Update the bots that are using Basic authentication in the **Connect, Send, Forward, or Reply** actions or Email trigger to use OAuth 2.0.

Update bots using Basic authentication to OAuth 2.0

6. Verify that the updated bots can be deployed.

Run a bot

Note: You can update your bots to use OAuth 2.0 in one environment (for example, development or DEV) and then move these bots to another environment (for example, UAT and production or PROD) without updating the bots in each environment.

Protocols impacted for Basic authentication deprecation

Microsoft is removing the capability to use basic authentication in Exchange Online for these specific protocols: MAPI, RPC, Offline Address Book (OAB), Exchange Web Services (EWS), POP, IMAP, Exchange ActiveSync (EAS), and Remote PowerShell.

Note: SMTP AUTH is excluded from this deprecation.

Any client (for example, user app, script, or integration) using Basic authentication for one of the affected protocols will not be able to connect to Exchange server starting October 1, 2022. An HTTP 401 error (`bad username or password`) will be displayed.

Note: Any app using OAuth 2.0 for these same protocols will not be impacted.

For more information, see [Basic authentication deprecation in Exchange Online – Updates](#).

Update bots using Basic authentication to OAuth 2.0

You should update your bots that are using Basic authentication to OAuth 2.0 in the **Connect, Forward, Reply, and Send** actions of the Email package and Email trigger before Basic authentication is deprecated.

Note: This procedure is applicable to both Automation 360 Cloud and On-Premises customers.

Prerequisites

- The **Installation Setup folder** in the Automation 360 v.25 Basic Authentication MS Online - Deprecation downloads folder contains the following JAR files:
 - **Email package** (bot-command-email-3.14.1.jar)
 - Ensure that you download this package and add it to your Control Room in Automation 360.
 - **Email trigger** (bot-trigger-email-2.8.1.jar)
 - Ensure that you download this package and add it to your Control Room in Automation 360
 - **Trigger listener** (triggerlistener.jar)
 - If you are on Automation 360 v.25 release, ensure that you download and install the trigger listener file. See [Install the trigger listener file](#).

For information on adding packages to the Control Room, see [Add packages to the Control Room](#).

To download these JAR files, see [Everything about Basic Authentication deprecation in Microsoft Exchange online \(A-People login required\)](#).

- Ensure that you have run the Bot Scanner utility for the deprecated features to identify the bots that are using Basic authentication in your Control Room repository.
 - See [Scan Automation 360 bots for Email action with Basic authentication usage](#).
- Ensure that you have registered your application on the [Azure portal](#) and performed the following configurations for Client credentials flow:
 - IMAP/POP3
 1. [Register an application](#)
 2. [Authenticate an IMAP, POP or SMTP connection using OAuth](#)
 - EWS
 1. [Register an application](#)
 2. [EWS OAuth authentication](#)
 3. [Configure application access policy](#)

Procedure

1. Log in to your Control Room as Bot Creator.
2. Select the bot that was identified in the Bot Scanner report for updating.
3. Check out the bot to edit it.
4. In the Bot editor, click the vertical ellipsis in the top right-corner and click **Packages**.
5. Expand the row for the Email package.
6. From the drop-down list of package versions, select the **Default** version.

Note: For Email package, ensure that the package version is **3.14.1-20220831-084727** or later. For Email trigger, ensure that the package version is **2.8.1-20220831-123116** or later.

7. Click **Change Version** and **Save**.
8. Click **Return to editor**.
9. Click the Email action or Email trigger that is using the **Basic** authentication mode.
10. Click the **Email server** or **EWS server** option.

11. In the **Authentication mode** drop-down list, choose the required OAuth 2.0 mode.

Note: For unattended Email automation, use Client credentials or ROPC flows, and for attended Email automation, use Implicit or PKCE flows. Microsoft does not recommend the use of ROPC and Implicit legacy flows. Therefore, we recommend that you either use the Client credentials or PKCE flow.

The following table provides information about the OAuth 2.0 authentication modes that are available for Email action in the Email server and EWS server options:

Email actions	Email server	EWS server
Connect	<ul style="list-style-type: none"> OAuth2 – Authorization code with PKCE OAuth2 – Client credentials 	<ul style="list-style-type: none"> OAuth2 – ROPC OAuth2 – Implicit OAuth2 – Authorization code with PKCE OAuth2 – Client credentials
Send	OAuth2 – Authorization code with PKCE	<ul style="list-style-type: none"> OAuth2 – ROPC OAuth2 – Implicit OAuth2 – Authorization code with PKCE OAuth2 – Client credentials
Forward	OAuth2 – Authorization code with PKCE	--
Reply	OAuth2 – Authorization code with PKCE	--

The following table provides information about the OAuth 2.0 authentication modes that are available for Email trigger in the Email server and EWS server options:

Triggers	Email server	EWS server
Email trigger	OAuth2 – Client credentials	OAuth2 – Client credentials

- **OAuth2 – ROPC:** Uses Resource Owner Password flow (*Microsoft identity platform and OAuth 2.0 Resource Owner Password Credentials*)

Note: The existing Silent flow has been renamed to ROPC.

- **OAuth2 – Implicit:** Uses implicit grant flow (*Microsoft identity platform and implicit grant flow*)

Note: The existing Interactive flow has been renamed to Implicit.

- **OAuth2 – Authorization code with PKCE:** Uses authorization code with PKCE grant flow (*Microsoft identity platform and OAuth 2.0 authorization code flow*)
- **OAuth2 – Client credentials:** Uses client credentials flow (*Microsoft identity platform and the OAuth 2.0 client credentials flow*)

12. Depending on the authentication mode that you selected, you might have to update some of the following fields:

- **Username:** Enter the username that you want to use to access the mail server.
For example, john.smith@myCompanyName.com
- **Password:** Enter the password for the username you provided.
- **Email provider:** Select the email provider from the drop-down list.

Note: For **Client ID**, **Tenant ID**, **Redirect URI**, and **Client secret** options, use the information that is provided for your account on your [Azure portal](#).

See [Email package](#) and [Add an email trigger](#).

13. For **EWS server**, click **Test connection** to sign in to your account, accept the permissions requested to authenticate, and establish a connection with the server.

Note: In the Microsoft Azure app registrations portal, in **Manage > Authentication**, ensure that the URI you have added is either <https://outlook.office365.com> or <https://outlook.office365.us> for the connection to work properly.

14. Click **Save**.

Repeat these steps for all the impacted bots and run the bots to ensure that they can connect to Exchange Online using OAuth 2.0 successfully.

Install the trigger listener file

To use the Email trigger with OAuth 2.0, you have to update the `triggerlistener.jar` in the Bot Agent.

- 1.** In the Windows Task Manager, stop the **Automation Anywhere Bot Agent** service.
- 2.** Go to the folder where the Bot Agent is installed (C:\Program Files\Automation Anywhere\Bot Agent).
- 3.** Locate the `triggerlistener.jar` file and rename the file to `triggerlistener.jar_old`.
- 4.** Copy the downloaded `triggerlistener.jar`.
- 5.** In the Windows Task Manager, start the **Automation Anywhere Bot Agent** service.

Other resources

- [Automation 360 and Basic authentication deprecation FAQ](#)
- [Scan Automation 360 bots for Email action with Basic authentication usage](#)
- [Everything about Basic Authentication deprecation in Microsoft Exchange online \(A-People login required\)](#)

Automation 360 and Basic authentication deprecation FAQ

Microsoft has announced EOL for Basic authentication that is used to connect to Exchange Online. This will impact automations (bots) using Email package or Email trigger that uses Basic authentication. Review the FAQ for details about the deprecation of Basic authentication.

What is Basic authentication deprecation?

Microsoft has announced that starting October 1, 2022, Basic authentication will be permanently turned off (disabled) for specific protocols in Exchange Online for MAPI, RPC, Offline Address Book (OAB), Exchange Web Services (EWS), POP, IMAP, Exchange ActiveSync (EAS), and Remote PowerShell.

Exclusion: SMTP AUTH is excluded from this deprecation for tenants which are already using it. Any client (user app, script, integration, and so on) using Basic authentication for one of the affected protocols will be unable to connect after that specified date. The app will display an HTTP 401 error: `bad username or password`. Any app using OAuth 2.0 for these protocols will be unaffected.

[Basic authentication in Exchange Online](#)

What is Microsoft's recommendation to mitigate Basic authentication deprecation?

Per Microsoft's recommendation, you are requested to switch from Basic authentication to OAuth 2.0 if your clients or apps are using Basic authentication with any of the affected protocols to connect to Exchange server via Exchange Online.

Note: The Basic authentication deprecation applies to Exchange Online only and not to Exchange on-premises version.

Why this change?

Basic authentication is an outdated industry standard, less secure, and poses high risks to accessing customers' sensitive data. The latest industry standard is OAuth 2.0 which is more secure and less vulnerable to cyber attacks.

What if I am not ready for this change?

If you are not ready to switch to OAuth 2.0 by **October 1, 2022**, Microsoft has provided a one-time re-enablement option that will allow you to continue to use Basic authentication for specific protocols until **end of December 2022**. Per the Microsoft announcement, customers will be able to use the self-service diagnostic to re-enable Basic authentication for any protocols they need, *once per protocol*. After the diagnostic is run, Basic authentication will be re-enabled for the specified protocols and will stay enabled until the end of December 2022.

Where is Basic authentication used in Automation 360 product?

Note: During the first week of calendar year 2023, the specified protocols will be disabled for Basic authentication use permanently.

[Basic Authentication Deprecation in Exchange Online – September 2022 Update](#)

In Automation 360, the Basic authentication feature is available in the **Connect, Send, Forward,** and **Reply** actions of the Email package and in Email trigger where you configure connection parameters using any of the IMAP, POP3, SMTP, or EWS protocols.

How do I know if I am going to be impacted by Basic authentication deprecation?

Basic authentication deprecation will impact you for the following cases:

- If you are automating email using Email package or Email trigger
- If you are using Basic authentication to connect to Exchange Online
- If you are using the IMAP, POP3, or EWS protocol

When Basic authentication will be disabled by Microsoft starting October 1, 2022, then all the Automation 360 bots for Email automation that meets the previously mentioned criteria will fail because the bot cannot connect to the Email server.

When will the support end?

Basic authentication will be disabled by Microsoft starting October 1, 2022.

How can I identify Automation 360 bots in my repository that are using Basic authentication with Email package or Email trigger?

For Automation 360 bots, you can run the Bot Scanner utility for EOL features.

[Scan Automation 360 bots for Email action with Basic authentication usage](#)

- The scanner will scan all the bots that are using Basic authentication with Email package or Email trigger and having IMAP, POP3, or EWS protocols.
- The scanner will then generate a CSV output listing all the impacted bots, including the specific line numbers and the specific actions to be performed.

Which feature will be provided in Automation 360 to mitigate the risk of Basic authentication deprecation?

The OAuth 2.0 feature will be available in Automation 360 in the Email package for the **Connect, Send, Forward,** and **Reply** actions and Email trigger for IMAP, POP3, and EWS protocols so that you can use this feature to switch from Basic authentication to OAuth 2.0.

What is the schedule and release version for introducing the OAuth 2.0 feature in Automation 360?

The OAuth 2.0 feature will be delivered as a package only release in the week of August 29, 2022. This release will include the following:

- Bot Scanner utility
- Updated versions of Email package, Email trigger, and trigger listener

Where can I download the Email package?

You can download the Email package from the link in the following article: [Everything about Basic Authentication deprecation in Microsoft Exchange online \(A-People login required\)](#).

Is the OAuth 2.0 feature backward-compatible with any of the previous releases of Automation 360?

No. The OAuth 2.0 feature is not backward-compatible with previous Automation 360 releases. Therefore, you are requested to manually update the package released with Automation 360 v.25.

What are the steps involved to update my impacted bots to switch to OAuth 2.0?

See to the following documentation page for the steps to update your impacted bots and switching from Basic authentication to OAuth 2.0: [Deprecation of Basic authentication in Exchange Online](#).

What are the different grant types or flows supported for OAuth 2.0 in Automation 360?

In Automation 360, there are two primary grant types that are supported for OAuth 2.0 across Email package and Email trigger:

- Client credentials: Email package and Email trigger
- Authorization code with PKCE: Email package

Within Email package, the individual **Connect**, **Send**, **Forward**, and **Reply** actions support each of these grant types as listed in the following table:

Action name	Email Server option	EWS option
Email > Connect	Client credentials	Client credentials
	Authorization code with PKCE	Authorization code with PKCE
	—	ROPC or Silent
	—	Implicit or Interactive
Email > Send	—	Client credentials
	Authorization code with PKCE	Authorization code with PKCE
	—	ROPC or Silent
	—	Implicit or Interactive

Action name	Email Server option	EWS option
Email > Forward	Authorization code with PKCE	—
Email > Reply	Authorization code with PKCE	—
Email Trigger	Client credentials	Client credentials

Note:

- The existing Silent flow has been renamed as ROPC (Resource Owner Password Credentials) and the existing Interactive flow has been renamed to Implicit.
- Both ROPC and Implicit grant flows are legacy flows, less secure, and are not recommended by Microsoft.
- The Client credentials flow for SMTP protocol is currently not supported by Microsoft to access Exchange Online.

- [OAuth grant types](#)
- [Authentication flow support in MSAL](#)
- [OAuth 2.0 Client Credentials Flow support for POP and IMAP protocols in Exchange Online](#)

What will happen to my existing bots that use email automation when I update to the Automation 360 v.25 to update the default version of the Email package or Email trigger to the latest version?

When you update to the latest version of the Email package or Email trigger, the existing bots that use email automation will include the following changes:

- If your bots are using the **Email server** option with IMAP or POP3 protocol, the **Authentication mode** option will be set to **Basic** by default to indicate that the action uses Basic authentication.

If the **Host** field in the **Email server** option uses a variable, the **Authentication mode** option will be set to **Basic**.

- If your bots are using the **EWS server** option with the **Authentication mode** option set to **Basic**, there is no change in the bots.

Note: This is the default scenario when you update the Email package.

- If your bots are using the **EWS server** option with the **Authentication mode** option set to **OAuth2-Silent**, the **Authentication mode**

Why is the Send Email action marked as Deprecated in my existing bots?

option will be set to **OAuth2 - ROPC** to indicate that the action uses the ROPC grant flow.

- If your bots are using the **EWS server** option with the **Authentication mode** option set to **OAuth2-Interactive**, the **Authentication mode** option will be set to **OAuth2 - Implicit** to indicate that the action uses the implicit grant flow.

When you update your bots with the latest version of the Email package, you will notice that the Send Email action used in your bots are marked as **Deprecated** due to the following reasons:

- We have created a new version of the Send Email action which provides support for OAuth 2.0 mode of authentication.
- The new Send Email action is available in the Email package version 3.14.1-20220831-084727 or later.
- The **Deprecated** message will help you differentiate the old Send Email action from the new Send Email action.

Note: The Send Email action that is marked as **Deprecated** will continue to work the same way as earlier without any changes. However, if you want to switch from Basic authentication to OAuth 2.0, you must replace the deprecated Send Email action with the new Send Email action and configure the required OAuth 2.0 parameters.

Will Automation Anywhere provide any tool for Automation 360 customers to update their bots from Basic authentication to OAuth 2.0?

No. You will have to manually update your impacted bots to switch to OAuth 2.0.

What is the guidance for Enterprise 11 customers if their bots are impacted by Basic authentication deprecation?

Enterprise 11 customers are recommended to migrate their Email automation bots to Automation 360 and leverage the OAuth 2.0 support. After migration, you can perform the following:

- Upload the new version of the Email package or Email trigger to Automation 360.
- Edit the impacted bots and set the latest version of Email package or Email trigger as default.
- Manually update your bots by switching from Basic authentication to OAuth 2.0.

Note: This guidance is applicable to both Cloud and On-Premises customers who are migrating to Automation 360.

Are there any limitations when you update the Email package?

We recommend that you do not perform a bulk update of bots to change Basic authentication to

OAuth 2.0. You must manually edit the bots and update to OAuth 2.0.

Deprecation of Basic authentication in Exchange Online

Scan Automation 360 bots for Email action with Basic authentication usage

Automatically identify Automation 360 bots that are using Basic authentication mode in the Connect, Send, Forward, and Reply actions in the Email package and Email trigger, which are using IMAP, POP3, or EWS protocols.

- Ensure that the user credentials used to connect to the Control Room has the **View content** permission on the `Bots` folder.

The Bot Scanner utility connects to your Control Room using these credentials.

- Ensure that you meet the software and hardware requirements for using the Bot Scanner.

See *Scan Enterprise 11 or 10 bots using Bot Scanner* .

1. Download the Bot Scanner utility using the link provided in the following article: *Everything about Basic Authentication deprecation in Microsoft Exchange online (A-People login required)*.
2. Extract the files from the zip file that you have downloaded and double-click the `Automation_360_Bot_Scanner_For_EOL_Features.exe` executable file to run the utility.
3. In the **Bot Scanner** page, ensure that the **Bots using Email action with Basic authentication** option is selected from the drop-down list, and then click **Continue**.

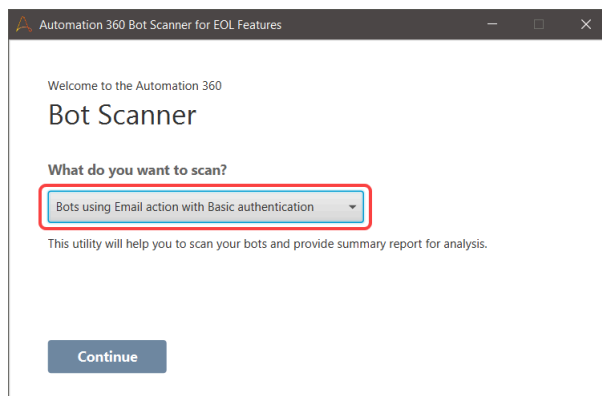

4. In the **Automation 360 Bot Scanner EOL features page**, perform these steps:
 - a) Enter the Control Room URL that you want to connect to
 - b) Based on the authentication type configured in your Control Room, choose one of the following authentication methods in the **Authentication Type** field:

Authentication type	Steps
Active Directory	<ol style="list-style-type: none"> 1. Enter the Username (Domain\\username). 2. Enter the Password (domain user password).
Database	<ol style="list-style-type: none"> 1. Enter the Username (Control Room database username). 2. Enter the Password (Control Room database user password).

Authentication type	Steps
Single Sign-On	<ol style="list-style-type: none"> 1. Enter the Username. 2. Enter the API Key.

- Click **Test connection**.
A connection success or failure message is displayed. Validate your credentials if the connection fails.
- In the **Select destination path** field, enter the location where you want to save the generated report.
- Click **Scan bots**.

Automation 360 Bot Scanner for EOL Features

Control Room URL

 e.g. https://Automation Anywhere/acmehealth.com/CR23CN

Authentication Type
 Database

Username

Password

Test connection

Select destination path
 Browse...

Choose where to save report

Scan bots Cancel

The scanner scans all the bots in your Control Room repository for Basic authentication mode usage in the **Connect**, **Send**, **Forward**, and **Reply** actions in the Email package and Email trigger. After the scan is complete, a report (.CSV file) is available in the destination path you selected for your review.

- If a .CSV file already exists in the output folder, a message is displayed that the previous .CSV file will be deleted. When you click **Continue**, a new .CSV file is generated.
- If the previous .CSV file is in use, a message is displayed that the file cannot be deleted. Close the file and click **Scan bots**.

5. Click **Open report** to analyze the report.

The report contains the following details:

- **TaskBot name:** Name of the TaskBot.
- **Line number:** The line number of the **Connect, Send, Forward, or Reply** actions that are using Basic authentication.

For **Email trigger**, the line number will be empty.

- **Package and action name:** The Email package and action that is using Basic authentication.
- **Searched text:** The hostname of the Email server or the domain name of the EWS server for the respective action.
- **Action and review message:** Use this information to understand the action that you have to perform or the information that you have to review for the corresponding action containing Basic authentication.

See [Basic authentication scanning messages](#).

- **TaskBot path:** The path to the repository where the bot resides.

After you identify the bots that are impacted due to Basic authentication, you can plan to update these bots in the Control Room repository to switch to OAuth 2.0 authentication. For more information on how to switch to OAuth 2.0, see [Deprecation of Basic authentication in Exchange Online](#).

Basic authentication scanning messages

The Bot Scanner report might display some messages for your review or action for updating bots that are using Basic authentication to OAuth 2.0 in the Email package or Email trigger. Messages provide detailed information about the action, error, or review required to update the bots.

Code	A1001
Message	<p>The Basic authentication mode that is used to connect to the email server is deprecated by Microsoft.</p> <p>For the bot to run, update the authentication mode by selecting OAuth 2.0 and configuring the required parameters. Otherwise, a connection error will occur.</p>

Code	A1002
Message	<p>The Basic authentication mode that is used to connect to the EWS server is deprecated by Microsoft.</p> <p>For the bot to run, update the authentication mode by selecting OAuth 2.0 and configuring the required parameters. Otherwise, a connection error will occur.</p>

Code	R1004
-------------	-------

Message

A variable is used in the 'Host' property of this bot. If the variable is pointing to 'office365.com', this can potentially have an impact on the action since the Basic authentication mode that is used to connect to the email server is deprecated by Microsoft.

You are advised to review the variable and update the authentication mode by selecting OAuth 2.0 and configuring the required parameters.

Chrome and Edge Manifest V3 extensions

As Google will deprecate Manifest V2 extensions, this might impact your existing automations that use the current Manifest V2 extensions for Google Chrome and Microsoft Edge browsers. We have published Manifest V3 extensions with the Automation 360 v.26 release to help you start switching to Manifest V3 extensions.

Manifest V2 based deprecation

A **manifest** is a specification that is used to build browser extensions. As Google is deprecating Manifest V2 based extensions, we recommend that you update to Manifest V3 based extensions, which provides an enhanced security, privacy, and performance.

Impact to our customers: Automations that use Google Chrome Manifest V2 based extensions will stop working sometime after June 2023. The deprecation timelines of Manifest V2 based extensions are currently under review and subject to change by Google.

- For Google Chrome Manifest V2 extensions timelines, see [Manifest V2 support timeline](#).
- For Microsoft Edge Manifest V2 extensions timelines, see [Overview and timelines for migrating to Manifest V3](#).

Post the given date, you must switch to Manifest V3 extensions for your automations to work. You can choose to use the enterprise group policy for both Google Chrome and Microsoft Edge to continue to use Manifest V2 based extensions. For more information on Manifest extensions support and timelines, see, [Manifest V3 transition timeline](#).

Automation 360 features that use browser extensions

The following Automation 360 features use the Google Chrome or Microsoft Edge browser extension for web applications running on Google Chrome or Microsoft Edge:

- Bot Agent device registration with the Control Room (uses Chrome extension only)
- Automation of web applications through Universal Recorder or Browser package
- User interface based triggers
- Packages that use window titles, for example, OCR and Mouse Click

Plan the switch to Manifest V3 extensions

Note: Manifest V3 extension is supported on Google Chrome and Microsoft Edge browsers version 91 and later only.

Automation 360 customers:

We have published new Google Chrome and Microsoft Edge Manifest V3 extensions with the Automation 360 v.26 release. We will also continue to support Manifest V2 extensions until June 2023 to provide you time to switch to Manifest V3 extensions before Jan 2024 for Google Chrome. To know about Microsoft Edge Manifest V2 extensions timelines, see [Overview and timelines for migrating to Manifest V3](#).

You have the following options to switch to Manifest V3 extensions:

- **New customers:** Users starting with Automation 360 v.26 will directly use Manifest V3 extensions. You will not be impacted by the deprecation of Manifest V2 extensions.
- **Cloud customers:** Our Cloud deployments is updated to Automation 360 v.26 in October, and customers can switch to Manifest V3 extensions when they update their Bot Agent.
- **On-Premises customers:**
 - **Updating to v.26:** Customers updating from an earlier version to Automation 360 v.26 will switch to Manifest V3 extensions when they update their Bot Agent.
 - **v.25:** We have provided a Control Room patch with Automation 360 v.25. After installing the patch, the V2 extensions is switched to Manifest V3 extensions when you update the Bot Agent.
 - **v.24, v.23, and v.22:** For customers on Automation 360 v.24 or earlier, we strongly recommend that you update to Automation 360 v.26 or later releases. If you choose not to update, we will provide a set of steps to perform on all Bot Agent and Bot Runner devices to switch to Manifest V3 extensions. See [Manifest extension manual upgrade](#).
 - **v.21 and earlier:** We strongly recommend that you update to the latest version of Automation 360.

Note: You can choose to delay switching to MV3 extensions by using a Chrome group policy that extends support for Manifest V2 extensions until Jan 2024 for Google Chrome, see [Manifest V3 transition timeline](#). To know about Microsoft Edge Manifest

V2 extensions timelines, see [Overview and timelines for migrating to Manifest V3](#).

Customers migrating to Automation 360

We recommend that you migrate to Automation 360 v.26, which uses Manifest V3 extensions by default. If you are migrating to Automation 360 v.25, install the Control Room patch, that we released in October.

Enterprise 11 customers

For details, see [Enterprise 11: Deprecation of Basic authentication and MV2 extensions](#).

Extend Manifest V2 extensions usage through group policy

You can choose to use the enterprise group policy for both Google Chrome and Microsoft Edge to continue to use Manifest V2 extensions till **Jan 2024**.

For information about Manifest V2 extension timelines for Google Chrome, see [Manifest V3 transition timeline](#). For Microsoft Edge, see [Overview and timelines for migrating to Manifest V3](#).

You can extend the Manifest V2 deprecation only using the group policy. This extension provides you adequate time to plan upgrading to Manifest V3 extensions. You can use any extension group policy to extend the use of Manifest V2 extensions.

To update the policy, perform these steps:

1. Copy the following entries to a `.txt` file and save the file as a `.reg` file.

- **Chrome:**

```
Windows Registry Editor Version 5.00
[HKEY_LOCAL_MACHINE\SOFTWARE\Policies\Google\Chrome
\ExtensionInstallForcelist]
"ExtensionSettings"="{\"kammdlphdfejlpopponbapggpbgakimokm\":
{\"installation_mode\": \"normal_installed\", \"update_url\": \"http://
clients2.google.com/service/update2/crx\"}}"
```

- **Edge:**

```
Windows Registry Editor Version 5.00
[HKEY_LOCAL_MACHINE\SOFTWARE\Policies\Microsoft\Edge
\ExtensionInstallForcelist]
"ExtensionSettings"="{\"dbmodiepejcgjljbmeebdkmegndokbk\":
{\"installation_mode\": \"normal_installed\", \"update_url\": \"https://
edge.microsoft.com/extensionwebstorebase/v1/crx\"}}"
```

2. Run the `.reg` file.
3. Restart the browser for the changes to take effect.

Related concepts

[Manifest V3 extensions FAQ](#)

As Google will deprecate Manifest V2 extensions by June 2023, this might impact your existing automation that use the current Manifest V2 extensions for Google Chrome and Microsoft Edge browsers.

[Manually upgrade from Manifest V2 to V3 extensions for Chrome and Edge](#)

[Feature deprecations affecting Automation Anywhere products](#)

Review the features and capabilities (from Automation Anywhere or third party) that are deprecated or nearing deprecation to understand how they affect your automation and what action is required.

Related tasks

[Switch Manifest V3 to Manifest V2 extension manually](#)

If you want to switch from Manifest V3 extension to Manifest V2 extension while remaining on Automation 360 v.26, you can manually switch to v2 extension.

[Manage multiple browser profiles for Manifest V3 extension](#)

Automation 360 v.26 automatically includes Manifest V3 extensions to support browser-based automation. However, these V3 extensions in v.26 are by default for a **single** browser profile only.

Manifest V3 extensions FAQ

As Google will deprecate Manifest V2 extensions by June 2023, this might impact your existing automation that use the current Manifest V2 extensions for Google Chrome and Microsoft Edge browsers.

We have published Manifest V3 extensions with the Automation 360 v.26 release to help you start switching to Manifest V3 extensions.

What is Manifest V2 extension deprecation?

A **manifest** is a specification using which browser extensions are built. Google is deprecating Manifest V2 extensions by **June 2023** for Google Chrome. To know about Microsoft Edge Manifest V2 extensions timelines, see [Overview and timelines for migrating to Manifest V3](#). The deprecation might impact your existing automations that use Manifest V2 extensions for Google Chrome and Microsoft Edge browsers. So, we recommend that you plan to switch to Manifest V3 extensions, which provide enhanced security, privacy, and performance.

See the following resources for information on Manifest V2 extensions deprecation timelines: :

- Google Chrome: [Manifest V2 support timeline](#)
- Microsoft Edge: [Overview and timelines for migrating to Manifest V3](#)

When will the Manifest V2 support end?

In **June 2023**, Manifest V2 extensions for Google Chrome will stop functioning. You can update the group policy for both Google Chrome and Microsoft Edge to extend the use of Manifest V2 extensions until **Jan 2024** . For Microsoft Edge Manifest V2 extension timelines, see [Overview and timelines for migrating to Manifest V3](#) for more information.

Support for Manifest V2 for Google Chrome ends in **Jan 2024** (see [Manifest V3 transition timeline](#)). To know about Microsoft Edge Manifest V2 extensions timelines, see [Overview and timelines for migrating to Manifest V3](#). You must switch to Manifest V3 based Google Chrome and Microsoft Edge browser extensions by then.

To extend support for Manifest V2, see [Extend Manifest V2 extensions usage through group policy](#).

How do I know if I am going to be impacted by the deprecation?

If you are using any or all of the following features on Google Chrome or Microsoft Edge browsers, you will be impacted by the Manifest V2 deprecation.

- Automation of web applications through Universal Recorder or Browser package
- User interface based triggers
- Bot Agent device registration with the Control Room
- Packages that use Browser variables, for example, Recorder, OCR and Mouse Click

Do I have to do anything in advance of the deprecation?

To avoid being affected by the deprecation, you can choose one of the following options:

- Upgrade to Automation 360 v.26, which includes the latest Manifest V3 extensions.
- Switch to Manifest V3 extensions before **June 2023** if you are using Google Chrome. For Microsoft Edge Manifest V2 extensions timelines, see [Overview and timelines for migrating to Manifest V3](#).
- Update the group policy to extend support for Manifest V2 extensions.

See [Extend Manifest V2 extensions usage through group policy](#).

What should I do to extend the group policy to continue using Manifest V2 extensions?

You can use the group policy for both Google Chrome and Microsoft Edge browsers to extend support for Manifest V2 extensions. For more information, see the following articles:

- [Extend Manifest V2 extensions usage through group policy](#)
- [Manifest V3 transition timeline](#)
- [Overview and timelines for migrating to Manifest V3](#)

Will the Manifest v2 extensions be automatically updated to V3 or do I have to manually add V3 extensions to the browser?

- If you are on Automation 360 v.26 or later, and if you have updated to Bot Agent 21.222 or later, you will be automatically updated to Manifest V3.
- If you are on Automation 360 v.25 and earlier, you must manually upgrade the Manifest V2 to V3. See [Manifest extension manual upgrade](#).

Which Automation 360 versions are certified for upgrading from Manifest V2 to V3 extensions?

The following versions are certified for the upgrade:

- v.25
- v.24
- v.23
- v.22

I plan to continue with Automation 360 v.25, so what should I do to continue using MV2 extensions?

You can continue to use Manifest V2 extension only till **Jan 2024** for Google Chrome (see [Manifest V3 transition timeline](#)). To know about Microsoft Edge Manifest V2 extensions timelines, see [Overview and timelines for migrating to Manifest V3](#). You will have to perform manual steps to extend the support.

For more information, see [Extend Manifest V2 extensions usage through group policy](#).

What about the automations that I have already built using Chrome or Edge?

If your automations are dependent on browser extensions, you must either upgrade to Manifest V3 extensions or extend support for Manifest V2 extensions for your automations to continue working after the deprecation.

Do I need to update the Recorder package in the bots or will they continue to work with the earlier versions?

The Recorder package will work as intended, so there is no need to update the package.

I am using Automation 360 Cloud, so will my automations be impacted by the deprecation?

Cloud deployments are automatically updated to the Automation 360 v.26 release, which includes Manifest V3 extensions. The Bot Agent in v.26 refers to Manifest V3 extensions.

Note: If the **Automatically update all bot agents** option in your Control Room settings is disabled on your device, you will not be automatically updated to Manifest V3 extensions. So ensure that this option is enabled to receive automatic updates. Alternatively, you have to install the Bot Agent manually on all the Bot Runner devices.

How does the deprecation impact my migration?

We recommend that you migrate to Automation 360 v.26, which uses Manifest V3 extensions by default.

If you are using Automation 360 v.25 or earlier, you must either upgrade to Manifest V3 extensions or extend Manifest V2 extensions before you migrate browser-based automations.

Will the URL for the extensions change? Will the URLs that I have added in the trusted list for proxy settings be impacted?

Yes, the URLs for the extensions are different for Manifest V2 and V3. Use the following URLs for Manifest V3:

- **Chrome:** [Google Chrome extension for Automation 360](#)
- **Edge:** [Microsoft Edge extension for Automation 360](#)

Will Manifest V2 extensions be retained after I upgrade to Manifest V3?

Until **Jan 2024**, you can continue to use the extensions for Google Chrome. To know about Microsoft Edge Manifest V2 extensions timelines, see [Overview and timelines for migrating to Manifest V3](#). However, these extensions cannot be modified after **December 2022**, so Automation Anywhere will not be able to make any updates to these

extensions after December 2023. Also see, [Manifest V3 transition timeline](#).

Note: If you are on Automation 360 v.26 release and using Bot Agent 21.222, you will see both Manifest V2 and Manifest V3 registry entries in the Windows Registry.

- You can remove the Manifest V2 entry from Windows Registry by uninstalling the existing Bot Agent 21.222 and installing the Bot Agent 21.222 again.
- You can remove the Manifest V2 extension from the **Extensions** page.

Uninstalling the Bot Agent will remove both Manifest V2 and Manifest V3 extensions.

[Uninstall or remove apps and programs in Windows](#)

If Enterprise 11 and Automation 360 are running on the same device , will there be any conflicts due to the Manifest V2 deprecation?

As I am currently on Cloud deployment, I'd prefer to continue using Manifest V2 extensions. Can I continue to use Manifest V2?

Do I have an option to upgrade my devices in a phased or staggered manner?

Can I continue to use Manifest V2 extensions with the latest version of Automation 360?

There will be no impact in such scenarios because the Manifest V3 extensions IDs are different for Enterprise 11 and Automation 360.

We recommend that you upgrade to the latest Automation 360 version to get the benefits of Manifest V3 extensions. However, if you still want to continue using Manifest V2 based extensions, ensure that you disable the **Automatically update all bot agents** option (in the Control Room settings) for all devices and ensure that users do not install the latest Bot Agent. This is required because the Automation 360 v.26 Bot Agent supports only Manifest V3 extensions.

Yes, you can upgrade your devices in a staggered manner to Manifest V3. You can disable the **Automatically update all bot agents** option for all devices and then select the devices individually for which you want to upgrade the Bot Agent.

Manifest V2 extensions are updated to Manifest V3 extensions when you update Bot Agent to the corresponding version of Automation 360 v.27. Any existing configurations in the Manifest V2 extensions are overwritten.

Starting from Automation 360 v.26, Manifest V3 extensions are bundled with the Bot Agent installation. Therefore, Manifest V3 extensions are installed when you update the Bot Agent. To continue using the Manifest V2 extensions:

- Ensure that you do not update the Bot Agent.
- Select **Disable auto updates** option in Control Room before updating your existing Automation 360 version.

Can I revert the upgrade from Manifest V3 to V2?

See [Automatically update the Bot Agent](#).

Yes, you can switch from Manifest V3 to V2. Update the JSON file with following Manifest V2 extension IDs:

- Chrome V2 Extension ID:
kammdlphdfejlopponbapggpbgakimokm
- Edge V2 Extension ID:
dbmodiepejcgjljbmeebdkmegndokbk

For more information, see [Switch Manifest V3 to Manifest V2 extension manually](#).

I had switched from Manifest V3 to V2 extensions for Automation 360 v.26. Can I now update to Manifest V3 extensions when I update Automation 360 to v.27?

When you update to Automation 360 v.27, the corresponding Bot Agent is also updated. Manifest V3 extensions are installed with the latest version of Bot Agent.

Additionally, ensure that you select **Enable Automation 360 extension for this browser profile** option on Google Chrome and Microsoft Edge browsers. See [Manage multiple browser profiles for Manifest V3 extension](#).

Note: If you are currently using Manifest V2 extensions or earlier versions, we recommend that you update and use the Manifest V3 extension.

My bot uses a Recorder package from an earlier Automation 360 version and has a hard-coded Manifest V2 extension ID in it. How do I change the extension ID?

When you update to Automation 360 v.26, the extension ID for Manifest V3 is updated automatically.

My application has IFrame with Content Security Policy enabled. Will the Run JavaScript action run the JavaScript inside the IFrame?

With Manifest V3, Google has restricted access to IFrame where Content Security Policy (CSP) is enabled in target page. If your business application does not have CSP enabled, you will be able to run JavaScript inside the IFrame. If your business application has CSP enabled, you will not be able to run JavaScript inside the IFrame and the **Run JavaScript** action will timeout or fail.

What version of the browsers are supported for Manifest V3?

Manifest V3 is supported on Google Chrome and Microsoft Edge Version 91 and later.

I am currently on Automation 360 v.26. Can I switch to Manifest V2 extension?

Yes, you can switch to Manifest V2 extension while being on Automation 360 v.26. For more information, see [Switch Manifest V3 to Manifest V2 extension manually](#).

I am currently on Automation 360 v.26. Are there any settings that I have to configure to continue to avail the latest browser extension versions?

If you have an internet connection, you will continue to receive the updates through automatic updates.

Can I use MV3 extension offline or without internet connection?

MV3 extensions are automatically installed when you update the Bot Agent to the latest version. MV3 based offline extensions are available for:

- Google Chrome from Automation 360 v.26.
See [Install Chrome Plugin offline or without internet access in Automation 360](#).
- Microsoft Edge from Automation 360 v.27.

For additional help, contact Automation Anywhere support.

Will there be any impact to the remote agent that I have been using?

The remote agent installed with Automation 360 v.25 or earlier is not compatible with the Manifest V3 extension. You must install the latest Automation Anywhere remote agent and use the latest Recorder package.

See [Install remote agent: Recorder package version 2.8.6](#).

What are the prerequisites to configure the browser extension settings?

Following are the prerequisites to configure the browser extension settings:

- Bot Agent version 21.222 or later.
- You must have installed the Bot Agent with installation type as system-wide.

How to remove the Manifest V3 group policy?

For Google Chrome: Navigate to [HKEY_LOCAL_MACHINE\SOFTWARE\Policies\Google\Chrome\ExtensionInstallForcelist] and remove the entries that contain bbocnojhhoegfffpcllbeigipedjedf as the extension ID.

For Microsoft Edge: Navigate to [HKEY_LOCAL_MACHINE\SOFTWARE\Policies\Microsoft\Edge\ExtensionInstallForcelist] and remove the entries that contain fnmjcdajlonpigpcfnemeikipmolbfii as the extension ID.

Restart the browser for the changes to take effect.

After upgrade to Automation 360 v.26, do I have to disable Manifest V2 extensions?

When you upgrade to Automation 360 v.26, Manifest V3 extensions is installed automatically, without impacting the already installed Manifest V2 extensions. Both Manifest V2 and V3 extensions can co-exist. The Manifest V2 extension does not interfere with Manifest V2 extensions. You can remove the Manifest V2-based extensions as needed.

How to remove the MV2 extension?

For Google Chrome: Navigate to HKEY_LOCAL_MACHINE\SOFTWARE\WOW6432Node\Google\Chrome\. Expand Extensions folder and remove the folder by name kammdlphdfejlopponbapggpbgakimokm.

For Microsoft Edge: Navigate to HKEY_LOCAL_MACHINE\SOFTWARE

How to remove the MV3 extension?

\WOW6432Node\Microsoft\Edge. Expand **Extensions** folder and remove the folder by name dbmodiepejcgijlbmeebedkmegn dokbk.

Alternatively, go to the **Extensions** page of your respective browser and remove the entry related to Manifest V2.

For Google Chrome: Navigate to

HKEY_LOCAL_MACHINE\SOFTWARE
\WOW6432Node\Google\Chrome\. Expand **Extensions** folder and remove the folder by name bbocnojhhoegfffpcllbeigipedjedf.

For Microsoft Edge: Navigate to

HKEY_LOCAL_MACHINE\SOFTWARE
\WOW6432Node\Microsoft\Edge. Expand **Extensions** folder and remove the folder by name bbocnojhhoegfffpcllbeigipedjedf.

Alternatively, go to the **Extensions** page of your respective browser and remove the entry related to Manifest V3.

How to force enable Chrome/Edge extension for user-specific Bot agents?

You can force enable the Manifest V3 extension on Google Chrome or Microsoft Edge by running the .reg files for Manifest V3. See [Manifest extension manual upgrade](#).

How to add an extension force group policy if another extension policy has already been added by my IT team?

If a key by name **1** is already present, create a key name with the subsequent number, in this case, **2**. See the following articles:

- [ExtensionInstallForcelist](#) for Google Chrome
- [ExtensionInstallForcelist](#) for Microsoft Edge.

I have installed the latest Bot Agent and am currently on Automation 360. However, I ignored the browser extension pop-up dialog box. What do I do?

If you updated the Bot Agent when you launched a browser, you will be prompted to add or remove the Manifest V3 extension with a pop-up dialog box. To enable the Manifest V3 extension, you must select the **Add Extension** option. If you ignore the pop-up dialog box, the Manifest V3 extension is disabled. To enable the extension and apply the group policy, you must restart your browser.

How do I continue to use Manifest V2 extensions with Automation 360 v.26 and later versions?

We recommend that you upgrade to the latest Automation 360 version to get the benefits of Manifest V3 extensions. However, if you still want to continue using Manifest V2 based extensions, ensure that you disable the **Automatically update all bot agents** option (in the Control Room settings) for all devices and ensure that users do not install the latest Bot Agent. This is required because the Automation 360 v.26 Bot Agent supports only Manifest V3 extensions.

You can continue using Manifest V2 extensions until for Google Chrome until **Jan 2024** (see [Manifest V3 transition timeline](#)). To know about Microsoft Edge

Manifest V2 extensions timelines, see [Overview and timelines for migrating to Manifest V3](#).

Related concepts

[Chrome and Edge Manifest V3 extensions](#)

As Google will deprecate Manifest V2 extensions, this might impact your existing automations that use the current Manifest V2 extensions for Google Chrome and Microsoft Edge browsers. We have published Manifest V3 extensions with the Automation 360 v.26 release to help you start switching to Manifest V3 extensions.

[Manually upgrade from Manifest V2 to V3 extensions for Chrome and Edge](#)

[Feature deprecations affecting Automation Anywhere products](#)

Review the features and capabilities (from Automation Anywhere or third party) that are deprecated or nearing deprecation to understand how they affect your automation and what action is required.

Manage multiple browser profiles for Manifest V3 extension

Automation 360 v.26 automatically includes Manifest V3 extensions to support browser-based automation. However, these V3 extensions in v.26 are by default for a **single** browser profile only.

You can enable browser extension for only one browser profile at a time. If you have multiple browser profiles, you must enable browser extension only from the profile that is used to run the bots. You must disable the Automation 360 browser extension from all other browser profiles. You also have the option to debug logging, for troubleshooting purposes.

Note: This procedure is applicable only if your browser is using Manifest V3 extension.

To enable or disable the browser extension individually for each browser profile, perform these steps:

1. Open the Google Chrome or Microsoft Edge browser:
 - On Microsoft Edge, navigate to **Extensions > Automation 360 > Extension Options**.
 - On Google Chrome, navigate to `chrome://extensions/` and select **Details** in Automation 360 and select **Extension options**.

The following page is displayed:

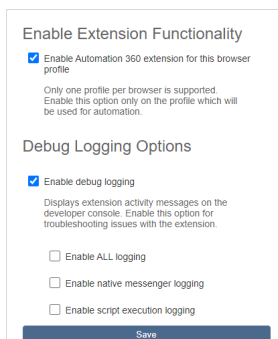

2. Select or deselect the **Enable Automation 360 extension for this browser profile** option.

Note: When you enable this option, only the current active profile is used for communication with the Bot Agent.

3. Select the **Enable debug logging** option to troubleshoot any browser extension issues.
4. Click **Save** and then restart the browser for the changes to take effect.

5. Verify that the debugging option is enabled for this browser profile by performing these steps:

- a) Press **F12** key or **Ctrl+Shft+I** keys on an active browser window.
- b) In the **Developer** console, select the **Application** tab and then select **Service Workers**.
- c) Click **See all registrations**.

In the **Service Workers** window, the extension ID in `chrome://extensions` and the ID in the **ServiceWorker** window will be the same. Also, the **Log** field displays the logs continuously.

Related concepts

[Manifest V3 extensions FAQ](#)

As Google will deprecate Manifest V2 extensions by June 2023, this might impact your existing automation that use the current Manifest V2 extensions for Google Chrome and Microsoft Edge browsers.

[Manually upgrade from Manifest V2 to V3 extensions for Chrome and Edge](#)

Related tasks

[Switch Manifest V3 to Manifest V2 extension manually](#)

If you want to switch from Manifest V3 extension to Manifest V2 extension while remaining on Automation 360 v.26, you can manually switch to v2 extension.

Switch Manifest V3 to Manifest V2 extension manually

If you want to switch from Manifest V3 extension to Manifest V2 extension while remaining on Automation 360 v.26, you can manually switch to v2 extension.

To switch Manifest V3 extension to Manifest V2 extension manually, perform these steps:

1. Disable the Manifest V3 extension from the browser extension options.

See [Manage multiple browser profiles for Manifest V3 extension](#).

2. Edit the browser agent JSON file to replace the browser extension ID.

- **Chrome**

- Navigate to `C:\Program Files\Automation Anywhere\Bot Agent\AABrowserAgent\`.
- Open the `AAChromeAgentManifest.json` file.
- Replace the browser extension ID `bboccnjhhogfffpcllbeigipedjedf` to `kammdlphdfejlopbonbapppbgakimokm`.
- Restart the browser for the changes to take effect.

- **Edge**

- Navigate to `C:\Program Files\Automation Anywhere\Bot Agent\AABrowserAgent\`.
- Open the `AAEdgeAgentManifest.json` file.
- Replace the browser extension ID from `fnmjcdajlonpigpcfnemeikipmolbfii` to `dbmodiepejcgjljbmeebedkmegndokbk`.
- Restart the browser for the changes to take effect.

Alternatively, download the JSON files from the link given below, and replace the files at the Bot Agent installation location (typically located at `C:\Program Files\Automation Anywhere\Bot Agent\AABrowserAgent`) on your Bot Agentmachines.

- **For Chrome:** Download the `AAChromeAgentManifest.json` from [Google Chrome JSON file download for Manifest V2](#).
- **For Edge:** Download the `AAEdgeAgentManifest.json` file from [Microsoft Edge JSON file download for Manifest V2](#).

If you have uninstalled the Manifest V2 extension manually, you must reinstall it from the [Chrome web store](#). Otherwise, your web-based automation might not continue to work.

If you are facing any issues, see [Google Chrome extension troubleshooting](#).

Related concepts

[Manifest V3 extensions FAQ](#)

As Google will deprecate Manifest V2 extensions by June 2023, this might impact your existing automation that use the current Manifest V2 extensions for Google Chrome and Microsoft Edge browsers.

[Chrome and Edge Manifest V3 extensions](#)

As Google will deprecate Manifest V2 extensions , this might impact your existing automations that use the current Manifest V2 extensions for Google Chrome and Microsoft Edge browsers. We have published Manifest V3 extensions with the Automation 360 v.26 release to help you start switching to Manifest V3 extensions.

[Manually upgrade from Manifest V2 to V3 extensions for Chrome and Edge](#)

Deprecation of Tesseract OCR v3

IQ Bot will permanently discontinue Tesseract OCR v3 starting from Automation 360 v.26. This affects customers who have created learning instances using Tesseract OCR v3. We recommend that you plan to train your learning instances with alternative OCRs (including Tesseract OCR) before you update to Automation 360 v.26.

Removal of Tesseract OCR will affect the following product areas:

- **My Learning Instances page:**

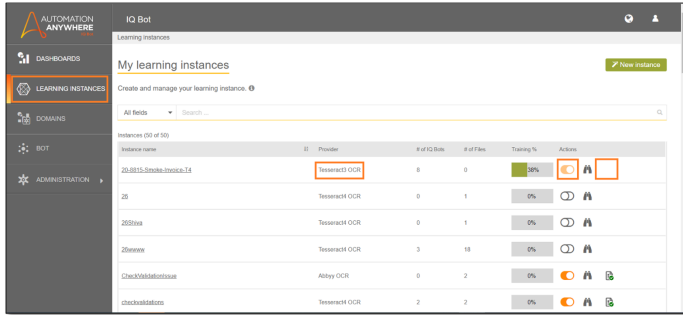

For all **Tesseract3 OCR** learning instances, the **Set the instance to Production** button and **Launch Validator** button are unavailable.

- **My Learning Instance details page:**

- Select the Tesseract OCR v3 learning instance and go to the **Learning Instance details** page.
- The **Set to staging**, **Add group**, **Validate**, **Edit**, and **Train** buttons are unavailable.

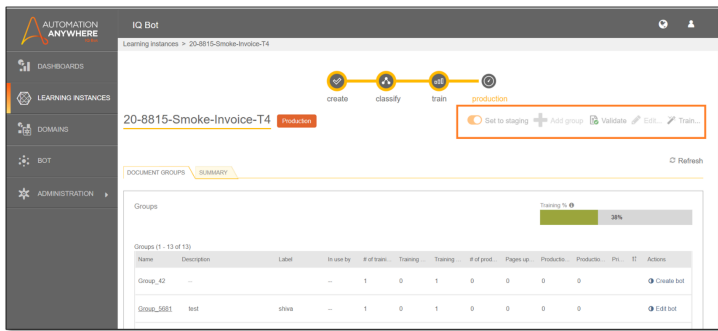

- **Edit Bot page:**
 - In the **My Learning Instance** page, click the **Edit bot** button of any existing bot.

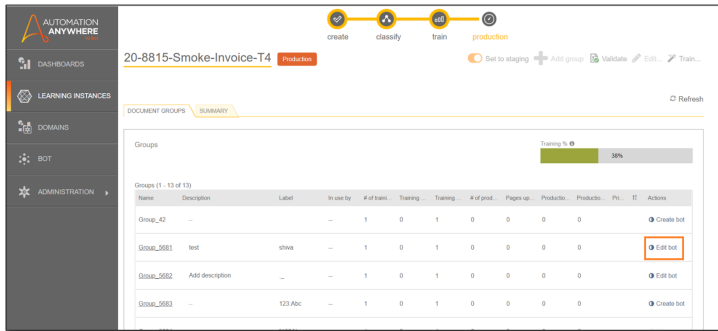

- The **See extraction result**, **Save and close**, **Save and go to next group**, and **Delete Bot** buttons are unavailable.

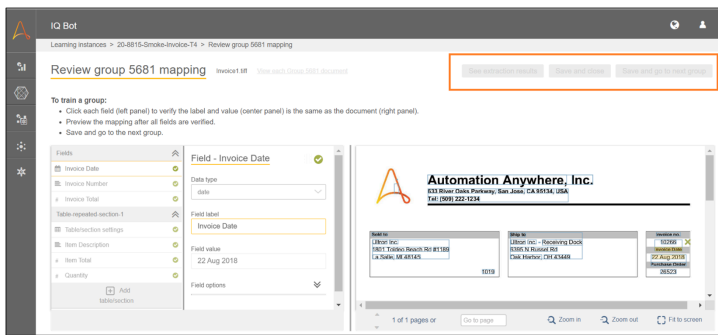

- **Bot page:**
- Go to **Bot** page.

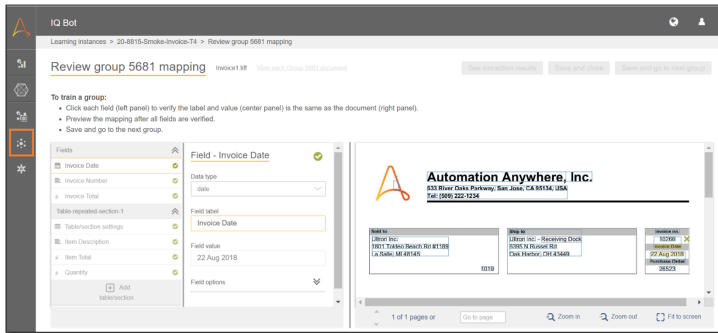

- Click **Test**.

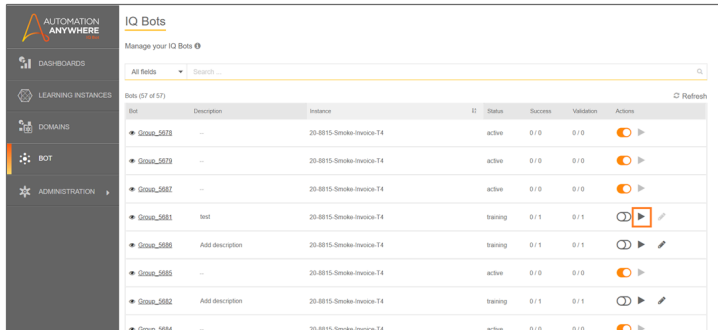

- The following error message is displayed:

The learning instance references OCR version which is not available - Tesseract 3

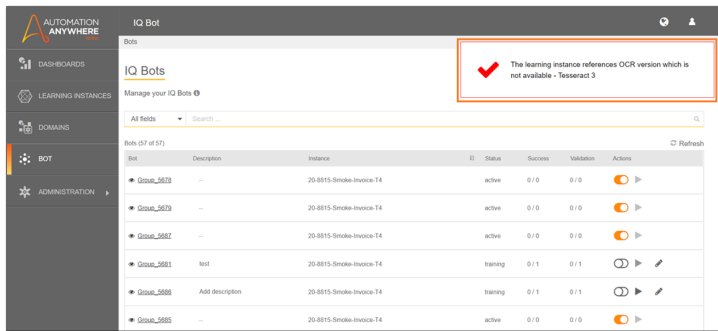

- There is no change in the **Dashboard** page, and it continues to show Tesseract 3 metrics.

Install and update Automation 360

Automation 360 provides a web-based, cloud-native RPA platform for users of all types. Review the tasks involved in setting up Automation 360.

Legal disclaimer: The information provided in this workflow might vary depending on which offering you use. Administrator steps might not be applicable to Cloud or Community Edition.

1. Choose your Automation 360 deployment model.

Deployment models

2. Verify the system prerequisites based on your deployment model:

- **Cloud:** *Automation 360 Cloud prerequisites*
- **On-Premises:** *Automation 360 On-Premises prerequisites*
- **Community Edition:** *Get started with Community Edition*

3. **Administrators:** Set up bot users.

Bot users, skip this step and proceed to Step 4.

- a. Receive your administrator credentials.

- **Cloud administrators:** Receive your login credentials with administrator privileges and your Automation 360 dedicated URL from Automation Anywhere.
- **On-Premises administrators:** Receive your licensing information from Automation Anywhere and install Automation 360.

The installation user is assigned administrator privileges.

Installation type	Go here
Windows	<p><i>Installing Control Room On-Premises</i></p> <hr/> <p>Workflow map: To view this installation task in an interactive visual format, see <i>Install Control Room On-Premises (custom mode)</i>.</p> <hr/>
Linux	<i>Installing Control Room on Linux</i>
Amazon Web Services	<i>Installing Control Room on Amazon Web Services</i>
Microsoft Azure	<i>Installing Control Room on Microsoft Azure</i>

Installation type	Go here
Google Cloud Platform	Installing Control Room on Google Cloud Platform

- b. Log in to a supported device, open a supported web browser, and log in to your Control Room using the dedicated URL.
 - [Automation 360 Bot Runner device requirements](#)
 - [Log in to Automation Anywhere Control Room](#)
 - c. Create your bot users by assigning a role and device license.
 - [Create a user](#)
 - [Create an Active Directory user](#)
 - d. Set up email notifications to Control Room users when events affect them, such as changes to passwords or user information, and account activation or deactivation.
- 4. Bot users:** Perform these steps to get started with Automation 360.
- a. Receive your user login credentials and the Control Room dedicated URL.
 Credentials are sent to you from your company's Automation Anywhere administrator or from Automation Anywhere.
 Community Edition users: If you do not have an Automation 360 account, register for a free Community Edition account by visiting [Automation Anywhere Community Edition](#).
 - b. Log in to your Automation 360 account.
 Log in to a supported device, open a supported web browser, and log in to your Control Room.
 - [Automation 360 Bot Runner device requirements](#)
 - [Log in to Automation Anywhere Control Room](#)
 - c. [Install Bot Agent and register device](#).

Note: The Bot Agent is installed only on devices running supported Windows operating systems. See [Automation 360 Bot Runner device requirements](#). You can create bots using the Bot editor in the Control Room, but to run the bots you must install the Bot Agent on your device.

 - d. Start creating bots:
 - [Create your first bot](#)
 - [Build a Go be Great bot](#)

Update Automation 360: See [Update to latest Automation 360 version](#).

Cloud and the Community Edition are updated automatically.

Related tasks

[Log in to Automation Anywhere Control Room](#)

To log in to Automation 360, open the Control Room URL in your browser, enter your credentials in the login screen, and click **Log in**.

[Get started with Community Edition](#)

Use these tasks to register for, and start creating and using bots with the Community Edition of Automation 360.

Related reference

[Automation 360 Bot Runner device requirements](#)

Review the machine hardware specifications, operating system versions, and browser types supported by Automation 360 Cloud for creating and running bots on a device. The same requirements are also valid for Automation 360 Community Edition.

[Browser requirements for RPA Workspace](#)

Access the RPA Workspace interface from a browser. After you have installed and enabled extensions in the browser, perform several tasks through the RPA Workspace interface based on your user role and automation requirements.

Get started with Automation 360 Cloud

Use these tasks to start creating and using bots with Automation 360 Cloud.

1. Complete the prerequisites for Cloud.

[Automation 360 Cloud prerequisites](#)

Use the checklist to determine whether your device fulfills the requirements for registering with Automation 360 Cloud.

2. [Provision Cloud Control Room instances.](#)

Use the Licenses and Cloud Services portal to provision Cloud Control Room and Cloud sandbox Control Room instances on demand.

3. Receive your Control Room URL and login credentials. The URL points to your Automation 360 instance.

If you are your company's principal administrator and ordered cloud-deployed Automation 360, you receive an email from Automation Anywhere with your URL and credentials.

4. [Log in to Automation Anywhere Control Room.](#)

To log in to Automation 360, open the Control Room URL in your browser, enter your credentials in the login screen, and click **Log in**.

5. Install Bot Agent, register your device, and set user device credentials.

[Install Bot Agent and register device](#) | [Set user device credentials](#)

The Bot Agent is a lightweight application that enables you to run bots on your device by connecting the device to the Control Room. To run bots on a local machine, install the Bot Agent and add the local device to the list of enabled host devices.

To enable a device for running bots, set the local device credentials.

If you are using an operating system other than Windows, you will not be able to install the Bot Agent at this time. See [system requirements](#). However, you can still build bots using the [Bot editor](#).

6. [Create your first bot.](#)

Follow these steps to create your first bot that prints the message, `Go be great!`, the Automation Anywhere version of `Hello World!`

7. *Run your first bot.*

Run a bot from the same device that you used to create the bot.

Video resources

- Introduction to Automation 360
- Installing the Bot Agent in Automation 360:
- Building your first bot:
- Running your first bot in the Community Edition:

Related information

[Cloud RPA](#)

Automation 360 Cloud prerequisites

Use the checklist to determine whether your device fulfills the requirements for registering with Automation 360 Cloud.

- Verify the device software and hardware requirements.
Automation 360 Bot Runner device requirements
- Access the Control Room URL from your browser.
Log in to Automation Anywhere Control Room
- Add the Automation Anywhere Domain Name System (DNS) to the safe recipients or allowed list to ensure secure access to Automation 360 cloud services.
Add Automation 360 Cloud DNS to trusted list
- Allow Automation Anywhere communications ports and protocols.
Allow Automation Anywhere communications ports
- Add devices to the allowed list within the corporate network for granular security.
Add access IP addresses
- Add or update the authenticating proxy credentials to connect your device.
Connect Bot Agent to a device with a proxy
- Set up SAML authentication identity provider if you are using single sign-on (SSO).
Set up SAML authentication
- Configure your network firewall to add the outbound NAT Gateway IP addresses to the allowed list.
Automation 360 IP addresses for external integrations
- When configuring your domain and subdomain Control Room URLs, you must follow the Domain Name System (DNS) guidelines.
Naming guidelines for Control Room URLs
- To ensure seamless connectivity of your IQ Bot cloud servers with the Cloud Control Room, specify a list or range of IP addresses that are allowed to access the Cloud Control Room URL.

Add IQ Bot cloud server IP addresses to allowed list

Automation 360 Bot Runner device requirements

Review the machine hardware specifications, operating system versions, and browser types supported by Automation 360 Cloud for creating and running bots on a device. The same requirements are also valid for Automation 360 Community Edition.

Hardware requirements for registered devices

You communicate with the Control Room, through a registered local machine (device). Bot Creators and Bot Runners use the registered devices to create and run bots. Part of registering a device with Automation 360 is installing a Bot Agent.

Note: You cannot install a Bot Agent on a device with an existing Enterprise 10 or Enterprise 11 Enterprise Client.

The Bot Agent can be installed on devices that meet or are equivalent to the following hardware requirements:

Device	Processor	RAM	Storage (free disk space)	Network
Machine	Intel Core i3 2.6 GHz with 4 multi-cores or higher 64-bit	<ul style="list-style-type: none"> 4 GB (Minimum) 8 GB (Recommended) 	32 GB Add 100 through 150 KB per Automation Anywhere script Add 40 through 50 GB per long-term project	<ul style="list-style-type: none"> 5Mbps (Minimum) 20Mbps or higher (Recommended)
Additional users on a multi-user device	2 CPU per additional user	4 GB per additional user	No additional storage required	No additional network needed

Additional RAM requirements for the registered devices

Add additional RAM to account for applications and services running on the registered devices, for example:

- Microsoft Office applications (example: Excel)
- Browsers (example: Google Chrome)
- Enterprise applications (example: CRM, Oracle EBS, and SAP)
- VDI infrastructure applications
- Anti-virus software
- AISense Recorder

Additional disk space on registered devices

- Automation 360 scripts average approximately 100-150 KB. Additional free disk space is required to develop automation projects because temporary files such as screenshots, server logs, and audit files are created during the execution of the automation scripts.

- Free space required increases with the project size. Recommendation: Have at least 40-50 GB of free disk space for each long-term project.
- Increase storage space configuration after installation, as needed, depending on product usage. For example, depending upon the complexity of your bot, generating log files and logic creation require additional disk space later.

Additional CPU or processor on registered devices

AISense Recorder: Additional CPU or processor is required on a device if the existing CPUs are utilized by customer applications. It is also required in case of a VDI infrastructure where CPU or processors are shared across the infrastructure.

Platform compatibility for registered devices

A device used to connect to the Control Room and perform bot tasks must meet the platform requirements.

Note: Platform requirements are different for Control Room and Bot Agent.

Registered devices

Physical machines that you want to use for creating bots or deploying bots and running any of the supported operating systems.

Terminal servers

Using remote desktop (RDP), running any of the supported operating systems is supported on Automation 360 Version A2019.11 or later.

Virtual machines

Bot Agent is supported on all VMs where the supported Windows OS has been hosted on Version A2019.09 or later. For example, Virtual Desktop Infrastructure (VDI) are supported on Amazon Web Services, Microsoft Azure, Google Cloud Platform, VMware virtual machines, and Oracle Virtual Box.

Supported operating systems for registered devices

A device used to run the Bot Agent, connect to the Control Room, and perform bot tasks as a Bot Creator and Bot Runner must meet the operating system requirements.

Note:

- Only 64-bit operating system version supported.
 - Bot Creator tasks are supported with all the listed operating systems.
 - You cannot register a device that is running on a Linux system. The Bot Agent cannot be installed on Linux systems. However, you can use a registered device running on a Windows system to access a Control Room that is installed on a Linux system.
-

Windows version	Windows edition	Attended Bot Runner	Unattended Bot Runner	Bot Creator
Windows 365 Cloud PC	Enterprise	Supported	Supported	Supported
Windows Server 2019	Datacenter and Standard	Supported	Supported ¹	Supported
Windows Server 2016	Datacenter and Standard	Supported	Supported ¹	Supported
Windows Server 2012	Datacenter and Standard	Supported	Supported ¹	Supported
Windows 11	Enterprise	Supported	Supported ¹	Supported
Windows 10	Professional and Enterprise	Supported	Supported ¹	Supported
Windows 8 ²	Professional and Enterprise	Supported	Supported	Supported
Windows 7 ²	Professional and Enterprise	Supported	Supported	Supported

(1) Auto-login

- Auto-login is only supported on 64-bit systems.
- If the Auto-login fails, configure the **Local Security Policy** settings. For example, in Windows, select **Security Settings > Local Policies > Security Options**. Enable the **Interactive logon > Do not require CTRL+ALT+DEL** option.

Recommendation: Enable the **Interactive logon > Do not require CTRL+ALT+DEL** option to ensure your device is able to bypass the screen to create a user session.

When you deploy a bot from the Control Room on a device, Bot Agent receives the deployment and creates an interactive user session for deployment. If the option is disabled, the Bot Agent will not be able to bypass the screen to create a user session. Therefore, we recommend you enable this option.

For more information, see [Why does the policy \(Interactive logon: Do not require CTRL+ALT+DEL\) need to be enabled for Auto Login to work? \(A-People login required\)](#).

(2) Supported OS

Windows 8 (64-bit) supported on Enterprise A2019 Builds 1598 and 1610 or earlier.

Windows 7 (64-bit) supported on Enterprise A2019.12 or later.

Add Automation 360 Cloud DNS to trusted list

To ensure secure access to Automation 360 cloud services, add specific Automation Anywhere Domain Name System (DNS) to the safe recipients or trusted list.

DNS list

Automation 360 cloud service hosting uses dynamic IP addresses and therefore we recommend that you add to the safe recipients list the complete DNS instead of an IP address for the Automation Anywhere cloud services.

Service	DNS	Port	Device
Automation Anywhere	www.automationanywhere.com	TCP 443 (HTTPS)	All devices
Automation Anywhere Cloud customer tenant Includes Automation Anywhere Control Room and IQ Bot	crdomainname-X.my.automationanywhere.digital Note: <ul style="list-style-type: none"> crdomainname-X refers to your specific tenant name. The tenant name does not support the underscore (_) character. So an underscore is used in the tenant name, the specified URL will not be created. 	TCP 443 (HTTPS)	All devices that access Automation 360
Automation Anywhere Bot Agent download link	aai-artifacts.my.automationanywhere.digital	TCP 443 (HTTPS)	All devices that access Automation 360
Automation Anywhere community (A-People)	apeople.automationanywhere.com	TCP 443 (HTTPS)	All devices
Automation Anywhere documentation	docs.automationanywhere.com	TCP 443 (HTTPS)	All devices
Bot Store	botstore.automationanywhere.com	TCP 443 (HTTPS)	All devices
Content delivery network (CDN) Enables your platform to perform faster as it geographically distributes common static content for cloud tenants.	aai-artifacts.my.automationanywhere.digital	TCP 443 (HTTPS)	All devices that access Automation 360

Service	DNS	Port	Device
<p>Telemetry</p> <p>Allows performance and usage information to be gathered anonymously in order to improve product quality.</p>	<ul style="list-style-type: none"> cdn.pendo.io/ app.pendo.io/ data.pendo.io/ https://pendo-static-5673999629942784.storage.googleapis.com/ 	TCP 443 (HTTPS)	All devices
<p>Automation Anywhere Google Chrome extension</p> <p>Enables you to automate using the Google Chrome browser.</p>	<p>MV3 extension</p> <p>https://chrome.google.com/webstore/detail/automation-360/bboccnjhhoeqfffpcllbeigipedjedf</p> <p>MV2 extension</p> <p>https://chrome.google.com/webstore/detail/automation-360/kammdlphdfejllopponbapgbgkimokm</p>	TCP 443 (HTTPS)	Bot Creator and Bot Runner devices
<p>Automation Anywhere Microsoft Edge extension</p> <p>Enables you to automate using the Microsoft Edge browser.</p>	<p>MV3 extension</p> <p>https://microsoftedge.microsoft.com/addons/detail/automation-360-beta/fnmjcdajlonpigpcfnemeikipmolbfii</p> <p>MV2 extension</p> <p>https://microsoftedge.microsoft.com/addons/detail/automation-360/dbmodiepejcgiljbmeebdkmegndokbk</p>	TCP 443 (HTTPS)	Bot Creator and Bot Runner devices
<p>Automation Anywhere Mozilla Firefox extension</p> <p>Enables you to automate using Mozilla Firefox browser.</p>	<p>https://addons.mozilla.org/en-US/firefox/addon/automation-360</p>	TCP 443 (HTTPS)	Bot Creator and Bot Runner devices

Files and folders

For information on files and folders to add to the safe list and to the antivirus exception list, see these articles:

- [Files and URLs to add to safe list for Automation 360 \(A-People login required\)](#)
- [List of files to add to antivirus exception list for Automation 360 \(A-People login required\)](#)

Related tasks[Add access IP addresses](#)

Use this setting to limit user login access to the Control Room URL based on IP addresses or subnets that you specify in a list. You add IP address ranges using the Classless Inter-Domain Routing (CIDR) format, and you can add multiple CIDR ranges.

Related reference[Ports, protocols, and firewall requirements](#)

View the default and configurable firewall, port, and protocol requirements for Automation Anywhere deployment. View the default ports and protocols that are required to be allowed on customer's firewall for Automation Anywhere deployment. The default ports that are used for HTTP/HTTPS are configurable.

[Add Automation 360 On-Premises DNS to trusted list](#)

To ensure secure access to Automation 360 online services for On-Premises deployment, add specific Automation Anywhere Domain Name System (DNS) to the safe recipients or trusted list on each user device.

[Add IQ Bot cloud server IP addresses to allowed list](#)

To ensure seamless connectivity of your IQ Bot cloud servers with the Cloud Control Room, specify a list or range of IP addresses that are allowed to access the Cloud Control Room URL.

[Automation 360 IP addresses for external integrations](#)

To ensure seamless connectivity of your Git instance, on premises key vault, or SIEM with the Cloud Control Room, configure your network firewall to include Automation Anywhere outbound Automation 360 IP addresses to the allowed list.

Allow Automation Anywhere communications ports

As part of the Automation 360 Cloud prerequisites, you must allow Automation Anywhere communications ports and protocols.

Cloud communications ports

The following table describes the required Cloud communications ports:

Automation 360 Cloud communications ports			
From	To	Port	Protocol
Bot Agent (customer hosted)	Control Room (Automation Anywhere hosted)	443	HTTPS
Bot Agent (customer hosted)	Control Room (Automation Anywhere hosted)	443	WebSocket
Control Room (Automation Anywhere hosted) where Control Room connects from these Automation 360 IP addresses for external integrations	Third-party Keystore (customer hosted and optional)	443	HTTPS

Automation 360 Cloud communications ports			
From	To	Port	Protocol
Control Room (Automation Anywhere hosted) where Control Room connects from these <i>Automation 360 IP addresses for external integrations</i>	Git Repository (customer hosted and optional)	443	HTTPS
Control Room (Automation Anywhere hosted) where Control Room connects from these <i>Automation 360 IP addresses for external integrations</i>	SIEM server (customer hosted and optional)	443	HTTPS
Admin (user)	Control Room (Automation Anywhere hosted)	443	HTTPS

Add IQ Bot cloud server IP addresses to allowed list

To ensure seamless connectivity of your IQ Bot cloud servers with the Cloud Control Room, specify a list or range of IP addresses that are allowed to access the Cloud Control Room URL.

Based on your region, add the following outbound NAT IP addresses to the allowed list in the Cloud Control Room network settings:

Region	IP addresses
- Africa	<ul style="list-style-type: none"> • 13.244.57.44 • 13.244.197.159 • 13.244.185.72 • 54.228.5.1 • 54.228.48.30 • 54.217.103.248
- Australia	<ul style="list-style-type: none"> • 54.153.153.175 • 52.65.8.56 • 3.106.147.142
- Canada	<ul style="list-style-type: none"> • 35.203.94.19 • 34.152.28.44

Region	IP addresses
- EU West 1	<ul style="list-style-type: none"> • 108.128.188.103 • 63.34.200.237 • 52.30.160.238 • 18.197.15.181 • 18.195.27.35 • 3.123.208.13
- EU West 4	<ul style="list-style-type: none"> • 35.204.101.230 • 34.141.232.185 • 34.141.55.27 • 34.141.57.227
India	<ul style="list-style-type: none"> • 3.7.60.137 • 3.6.235.61 • 13.232.116.48 • 18.136.73.65 • 52.77.203.34 • 18.136.8.15
- Japan	<ul style="list-style-type: none"> • 18.177.157.130 • 18.176.174.19 • 3.114.196.205 • 54.169.202.27 • 52.221.25.42 • 18.140.96.19
- LATAM	<ul style="list-style-type: none"> • 54.94.241.48 • 18.229.39.93 • 52.67.153.170 • 34.195.218.48 • 3.211.67.78 • 3.228.163.41
- Middle East	<ul style="list-style-type: none"> • 15.185.153.52 • 15.185.181.122 • 157.175.32.98 • 52.213.112.204 • 54.154.112.221 • 34.242.58.85
- Sandbox Australia	<ul style="list-style-type: none"> • 34.151.71.179 • 35.189.24.10

Region	IP addresses
- Sandbox EU West	<ul style="list-style-type: none"> • 54.228.82.108 • 54.73.17.42 • 54.228.85.241 • 3.122.33.207 • 35.156.216.8 • 18.159.235.149
- Sandbox US West	<ul style="list-style-type: none"> • 35.164.189.142 • 35.166.154.241 • 35.160.254.91 • 35.168.234.8 • 34.204.215.165 • 54.92.237.118
- Singapore	<ul style="list-style-type: none"> • 18.141.71.43 • 54.251.139.55 • 18.136.253.184 • 18.176.165.62 • 52.68.115.49 • 54.168.135.182
- US Central	<ul style="list-style-type: none"> • 34.85.131.101 • 35.245.151.203 • 34.68.252.217 • 34.123.71.95
- US East	<ul style="list-style-type: none"> • 50.16.245.134 • 35.174.84.76 • 3.210.114.16 • 54.244.136.23 • 54.185.77.190 • 44.234.224.213
- US West	<ul style="list-style-type: none"> • 54.213.119.159 • 34.218.159.79 • 52.33.16.117 • 3.225.222.13 • 34.197.160.162 • 3.213.188.29
- Sandbox US Central	<ul style="list-style-type: none"> • 35.223.219.53 • 34.133.80.165 • 34.150.165.212 • 35.245.150.192

Region	IP addresses
- Sandbox Singapore	<ul style="list-style-type: none"> • 13.251.176.239 • 54.169.33.175 • 46.137.201.87

Related tasks

[Add access IP addresses](#)

Use this setting to limit user login access to the Control Room URL based on IP addresses or subnets that you specify in a list. You add IP address ranges using the Classless Inter-Domain Routing (CIDR) format, and you can add multiple CIDR ranges.

Related reference

[Add Automation 360 Cloud DNS to trusted list](#)

To ensure secure access to Automation 360 cloud services, add specific Automation Anywhere Domain Name System (DNS) to the safe recipients or trusted list.

Installing Control Room On-Premises

Review the installation core tasks and topics for installing the Automation 360 Control Room in a data center on an On-Premises server or a cloud service provider server instance.

The Control Room provides centralized management for a digital workforce and an interface for Bot Insight. It is deployed on a server in a data center.

Linux users: See [Installing Control Room on Linux](#).

Note: Linux is not supported for Cloud-enabled On-Premises installations.

Control Room installation core tasks

Prerequisites

Before you begin, download the appropriate installer for your operating system and version from [A-People Downloads page \(Login required\)](#).

Step 1: Pre-installation

[Automation 360 On-Premises prerequisites](#)

Determine whether the system has the required hardware and software to install Control Room for On-Premises.

Step 2: Installation

The Control Room installer allows you to select installation modes (Express or Custom), and during the installation process, it also installs missing software dependencies.

Use Custom mode to install on a cloud-based platform such as Amazon Web Services.

[Installing Control Room using Express mode](#)

Log in to the servers as an Administrator

and install Automation Anywhere Control Room in Express Mode using the default settings.

Installing Control Room using Custom mode

Log in to the server as an administrator and install Automation Anywhere Control Room in Custom mode to select installation and configuration options, including installing non-default requirements. Select this mode for a data center deployment.

Workflow map: To view this installation task in an interactive visual format, see [Install Control Room On-Premises \(custom mode\)](#).

Installing Control Room on Microsoft Windows Server using scripts

Silent Control Room installation, also known as unattended installation, uses a customized script for a full setup or the command line for a hot fix patch. Silent install runs the entire installation process in the background without requiring user interaction or displaying messages.

Step 3: Post-installation

Configuring post-installation settings

The options for launching the Control Room for the first time and the authentication method depend on the installation mode and deployment type.

Verifying Automation Anywhere services

Automation Anywhere specific services are installed on the Control Room server.

Step 4: Validation

Configure Control Room authentication options

The options for launching the Control Room for the first time and the authentication

method depend on the installation mode and deployment type.

Automation 360 On-Premises prerequisites

Determine whether the system has the required hardware and software to install Control Room for Automation 360 On-Premises.

Hardware requirements

Control Room server requirements

The Control Room is deployed on servers in data centers. The minimum Automation Anywhere hardware requirements include: server type, machine type, processor, RAM, disk storage, and network requirements.

Operating system, environment, and platform supported for Control Room

Automation 360 can be hosted on AWS, Microsoft Azure, Google Cloud Platform, IBM, and any public, private, or hybrid cloud service that meets the Control Room and Bot Agent hardware and software requirements.

Bot Agent compatibility

Bot Agent is the Automation 360 plug-in that enables you to create and run bots. The agent is installed on devices used to access the Control Room. Installing the Bot Agent is part of registering a device.

Credential requirements

Login credentials are required at different stages of Automation Anywhere deployment and use. Credentials are required for installation and data center servers, access to Automation Anywhere components, and to run tools in bots.

Supported cloud platforms

Review the supported cloud platforms for various Automation 360 features.

Data center requirements

Database requirements

Working with SQL Servers

Configure Microsoft SQL Servers before setting up the Control Room database.

Working with Azure SQL PaaS

Using PaaS SQL database with Azure requires configuration from the Azure instance.

Load balancer requirements

View the load balancer requirements for Automation Anywhere installation. This includes load balancer

<i>Ports, protocols, and firewall requirements</i>	minimum requirements, and both TCP and HTTPS layer load balancing requirements.						
<i>Browser requirements for RPA Workspace</i>	View the default and configurable firewall, port, and protocol requirements for Automation Anywhere deployment.						
<i>HA and DR deployment models</i>	The user interface for Automation 360 (On-Premises or Cloud deployed) and for Community Edition is accessible through a browser.						
	<table> <tr> <td><i>High availability deployment</i></td> <td>The high availability (HA) deployment model provides failure tolerance for the Control Room servers, services, and databases using a distributed load balancer.</td> </tr> <tr> <td><i>Disaster recovery deployment</i></td> <td>The disaster recovery (DR) deployment model uses high availability (HA) clusters distributed across separate geographic areas.</td> </tr> <tr> <td><i>Single-node deployment</i></td> <td>A single-node deployment hosts the Control Room only on one server or machine.</td> </tr> </table>	<i>High availability deployment</i>	The high availability (HA) deployment model provides failure tolerance for the Control Room servers, services, and databases using a distributed load balancer.	<i>Disaster recovery deployment</i>	The disaster recovery (DR) deployment model uses high availability (HA) clusters distributed across separate geographic areas.	<i>Single-node deployment</i>	A single-node deployment hosts the Control Room only on one server or machine.
<i>High availability deployment</i>	The high availability (HA) deployment model provides failure tolerance for the Control Room servers, services, and databases using a distributed load balancer.						
<i>Disaster recovery deployment</i>	The disaster recovery (DR) deployment model uses high availability (HA) clusters distributed across separate geographic areas.						
<i>Single-node deployment</i>	A single-node deployment hosts the Control Room only on one server or machine.						

Additional requirements

<i>Configure application Transport Layer Security</i>	Use the Transport Layer Security (TLS) configuration wizard page from the Automation 360 installer to generate a self-signed certificate or import a security certificate to set up a highly secure Control Room instance.
<i>Naming guidelines for Control Room URLs</i>	When configuring your domain and subdomain Control Room URLs, you must follow the Domain Name System (DNS) guidelines.

See also this article on the Automation Anywhere support site: [Automation 360 On-Premises prerequisites \(A-People login required\)](#).

Related concepts

[Installing Control Room on Microsoft Azure](#)

Installing Control Room on Microsoft Azure begins in the Azure environment and ends with configurations in the Control Room.

[Installing Control Room on Amazon Web Services](#)

Log in to an Amazon Web Services (AWS) server instance as Administrator. Then, download and start the Control Room installer and select **Custom** mode.

[Installing Control Room using Custom mode](#)

Log in to the server as an administrator and install Automation Anywhere Control Room in Custom mode to select installation and configuration options, including installing non-default requirements. Select this mode for a data center deployment.

Related tasks

[Installing Control Room using Express mode](#)

[Installing Control Room on Microsoft Windows Server using scripts](#)

Silent Control Room installation, also known as unattended installation, uses a customized script for a full setup or an update setup. Silent installation runs the entire installation process in the background, without requiring user interaction or displaying messages.

Capacity and performance planning

To plan your deployment capacity and performance for Control Room On-Premises, understand the requirements, limits, and defaults that determine the number of simultaneous bots, user sessions, and processing rates.

The following topics provide information to help you calculate a deployment scenario that meets your requirements.

[Concurrent bot deployments and executions](#)

To plan your deployment capacity and performance for Control Room On-Premises, understand the requirements, limits, and defaults that determine the number of simultaneous bots, user sessions, and processing rates.

Concurrent bot deployments and executions

Review the information on the maximum number of concurrent bot deployments and executions for On-Premises deployment.

Overview

The entity count in the following list provides information about the maximum number of entities that the Control Room can support. Deploying additional Control Room or machine resources does not affect the entity count.

Control Room supports either of the following, for maximum number of concurrent bot deployments and executions:

- 1000 concurrent bot deployments and executions on Bot Runner sessions (typically in a production Control Room)
- 700 concurrent bot deployments and executions on Bot Creator sessions (typically in a development Control Room)

Entity Type	Count
Users	10,000*
Roles	5000*
Schedules	1500
Audit entries	10,000,000*
Lockers	100
Credentials	5000

Entity Type	Count
Repository files (Including all file types in the Control Room Public workspace)	25,000*
Note: Repository files include dependent files that you check in to the Public workspace (visible on the UI) and related files from the database (not visible on the UI). For example, .png files generated after an automation is recorded are stored in the database and are included in the repository files.	
Repository folders	9000*
Queues	10
Device pools	10
Work Items	1,000,000

* Applicable from Automation 360 v.21 and later.

Concurrent deployment and executions

Control Room supports up to 1000 concurrent bot deployments and executions across the Control Room cluster. These 1000 bots can be a combination of the same or different bots.

Note: If you use different bots, because of the load, the compiler slows down the execution for the first-time deployment. For subsequent deployments, bot execution process might accelerate.

Control Room edition and configuration	Number of Run as users
One instance of On-Premises	Maximum 1000
Three instances of On-Premises with High Availability (HA) configuration	Maximum 1000

The bot deployment depends on the network quality and the size of data that needs to be transferred from Control Room to Bot Agent.

Therefore, in the above scenario when the network connectivity speed is increased for the three Control Room instances, the network throughput improves, so the completion time will become shorter but the maximum accepted concurrent bot deployments will remain the same.

Bot concurrent schedules

Scheduling considerations when running bots repeatedly.

When configuring bots to run repeatedly on a schedule it is important to make sure that the time between runs does not drop below the total time for deployment and execution of the bot. Otherwise, sequential executions of the bot might overlap leading to unexpected behavior.

For example if it takes two (2) minutes to run a bot, do not schedule the bot to run every one (1) minute. The previous run cannot complete before the next run begins.

With the reference specification, it is possible to successfully configure concurrent schedules.

Activity	Schedule data
Concurrent schedules	100
Run as user per schedule	10
Total concurrent bots	1000

Control Room server requirements

The Control Room is deployed on servers in data centers. The minimum Automation Anywhere hardware requirements include server type, machine type, processor, RAM, disk storage, and network requirements.

Note: Automation Anywhere does not provide any monitoring functions for repository, such as disk space usage, memory, or other alert mechanisms related to repository. There are commercial tools available from other third-party independent software vendors (ISV) who provide such tools.

The installation wizard requires the following:

- **IP addresses:** Identify all the nodes (servers) IP addresses in the data center cluster before installation. You provide these IP addresses during Control Room installation.
- **Access hardware:** To enable viewing the Automation Anywhere interface, provide:
 - keyboard
 - mouse or other pointing device
 - monitor with 1366 x 768 or higher resolution

Note: For IQ Bot server requirements, see [IQ Bot hardware and software requirements](#).

Control Room must be installed on a 64-bit, server-level machine, and there can only be one instance of it on the machine. All previous Control Room versions must first be removed from the server machine before you begin the installation.

The following are server requirements for Windows and Linux.

Component server	Processor	RAM	Storage (free disk space)	Network
Control Room Servers	8 core Intel Xeon Processor or equivalent 64-bit Processor with 2.5 GHz plus speed	16 GB	500 GB	1 GbE <ul style="list-style-type: none"> • IPv4 • IPv6

Memory utilization: A Control Room configured with the recommended 16 GB RAM utilizes 80 to 90 percent memory in idle condition and up to 95 percent memory under load, for example, concurrent bot deployments.

Tip: We recommend that you configure the Control Room network bandwidth to be above 1 GbE for all inter-cluster communication between or among the following:

- Control Room and database
- All Control Room nodes
- Control Room and Elasticsearch nodes
- Control Room and storage systems
- Database nodes for high availability (HA) and disaster recovery (DR) configuration

Database requirements

View the list of supported databases, database server type, version, hardware, and operating system requirements, and database backup and recovery requirements.

Automation Anywhere installation creates a database to store bot data and metadata for the analytics dashboards.

Note: Automation Anywhere does not provide any monitoring functions for database activities, such as disk space usage, memory, or other alert mechanisms related to databases. There are commercial tools available from database vendors and other third-party independent software vendors (ISV) who provide such tools.

For latest updates, see [Microsoft SQL Server Hardware and Software requirements](#).

Database server hardware requirements

Component server	Processor	RAM	Storage	Network
Microsoft SQL Server database	4-core Intel Xeon Processor with 2.5 GHz plus speed	8 GB	500 GB	1 GbE

Note: If you are hosting the Control Room databases along with other application databases, ensure that the hardware resources are increased proportionately.

Database server version and operating system requirements

Microsoft SQL Server database is required.

Database type	Database version	Database edition	Installed OS	Supported platforms	Configuration requirement
Microsoft SQL Server database	2019 2017 2016 2014	Enterprise Express Standard Developer (for 2019)	Windows Server 2008 R2 Standard or later Linux CentOS 7.7, 7.9, and 8.3 Red Hat Enterprise Linux 7.7, 7.9, and 8.3	Amazon Web Services Relational Database Service (RDS)	Installed and configured. Only option for Express installations. Enable protocols for Named Pipes and TCP/IP.
Oracle Server database	Oracle 19c	<ul style="list-style-type: none"> Standard Enterprise 	Windows Server 2012 R2 or later Linux CentOS 7.7 and 7.9 Red Hat Enterprise Linux 7.7 and 7.9	Amazon Web Services Relational Database Service (RDS)	Installed and configured with <code>max_string_size</code> parameter set to EXTENDED. Supported only on non-container Database. Available only through an On-Premises custom installation.

- All database versions support all certified operating systems.
- We have certified Amazon RDS for SQL Server and Azure SQL single database for PaaS deployment.

Note that for Azure SQL, CPU or memory requirements are not applicable because it is a scalable and high performance Cloud database built on similar lines with SQL Server and certified for PaaS deployment in Automation 360.

- We recommend hosting the databases on separate hosts to take into account failover scenarios.
- We recommend Enterprise or Standard editions of Microsoft SQL Server database for production use and to ensure business continuity with HA and DR deployments.

You can configure the Express edition of Microsoft SQL Server for Automation 360 testing and proof of concept (POC) purposes based on considerations such as limit on data size, SQL agent unavailability, and DR capabilities.

For more information about scale limits, see [Microsoft SQL Server Express edition scale limits](#).

Required database information for Automation Anywhere installation

When you install Automation Anywhere, you are prompted to provide information specific to the database type you are using. The following table summarizes the required information.

Microsoft SQL Server database	
Required information	Description
Database (SQL Server) authentication <hr/> Note: Linux installations use this authentication method	Provide credentials for a Microsoft SQL Server user who has permission to connect to the database. Use only supported characters for the authentication user name and password. See Supported special characters . Do not use semicolons (;) in the database password. Linux example: SQL Database server Login ID: sa SQL Database password: Automation123 sa user authentication is mandatory.
Database names	Database names cannot be blank, have spaces, or include a percent (%). Restrict the names to alphanumeric, period (.), hyphen (-), and underscore (_). Default name: Automation360-Database
Database port	Default: 1433 Connection to this port is mandatory.
Secure connection (optional) and certificate	Provide a CA certificate. Ensure the certificate host name and database connection are the same.
Service credentials	Provide the user with db_datareader, db_datawriter, and db_ddladmin permissions to create databases during installation. The preferred method is to use the Domain user account.
Windows authentication	The Windows credentials of the user logged in to the device to connect to the database server.
Database collation	Use the default database collation: SQL_Latin1_General_CP1_CI_AS

Before installing Automation 360, ensure that you have configured additional firewall settings, verified the connection to the default port and an SQL query with SA user works as expected.

Related concepts

[Installing Control Room on Amazon Web Services](#)

Log in to an Amazon Web Services (AWS) server instance as Administrator. Then, download and start the Control Room installer and select **Custom** mode.

[Installing Control Room on Microsoft Azure](#)

Installing Control Room on Microsoft Azure begins in the Azure environment and ends with configurations in the Control Room.

Related tasks

[Installing Control Room on Linux](#)

You start installing the Automation Anywhere Control Room in the Linux environment and complete the installation in the Control Room.

[Configure default database port](#)

Configure and enable the TCP/IP in the SQL database server to use the default port 1433 when you install the Control Room.

Related reference

[Ports, protocols, and firewall requirements](#)

View the default and configurable firewall, port, and protocol requirements for Automation Anywhere deployment. View the default ports and protocols that are required to be allowed on customer's firewall for Automation Anywhere deployment. The default ports that are used for HTTP/HTTPS are configurable.

Working with SQL Servers

Configure Microsoft SQL Servers before setting up the Control Room database.

Configuring SQL Server Settings

SQL Server settings can be configured in the SQL Server Configuration Manager.

1. Enable protocols for Named Pipes and TCP/IP in **SQL Server Network Configuration > Protocols for MSSQLSERVER**.
2. Double-click TCP/IP to open the properties window.
3. Input the default or custom port number for `IPAll` in the IP Addresses tab of the TCP/IP Properties window.
The default port number is 1433.
4. Click **OK**.
5. Restart the MSSQLSERVICE for the updates to take effect.

Note: Ensure the Control Room database uses `SQL_Latin1_General_CP1_CI_AS` as the default database collation.

Database and Services Matrix

See [Database requirements](#) for a list of supported Microsoft SQL Server versions.

Service Credentials	Windows Authentication	SQL Authentication
Local System Account	<ul style="list-style-type: none"> Current logged in user account is used to create: <ul style="list-style-type: none"> Database Tables Installer gives <code>db_owner</code> permission to NT AUTHORITY\SYSTEM account. 	SQL User account is used to create: <ul style="list-style-type: none"> Databases Tables
Domain User Account	<ul style="list-style-type: none"> Current logged in user account is used to create database. Domain user account is used to create tables. Installer gives <code>db_owner</code> permission to domain user account. 	SQL User account is used to create: <ul style="list-style-type: none"> Databases Tables
Service User Account		For Microsoft Azure installations, the service account user needs to have read/write access to the remote Microsoft Azure repository share path.

Related reference

[Ports, protocols, and firewall requirements](#)

View the default and configurable firewall, port, and protocol requirements for Automation Anywhere deployment. View the default ports and protocols that are required to be allowed on customer's firewall for Automation Anywhere deployment. The default ports that are used for HTTP/HTTPS are configurable.

Working with Azure SQL PaaS

Using PaaS SQL database with Azure requires configuration from the Azure instance.

Configure the Azure instance before you install Automation 360.

1. Log in to your Azure account.
2. Navigate to the **Azure SQL** option.
3. Create a database based on your custom requirements.
4. Enable the firewall option.
5. Add the IP address to safe recipients list for accessing the database.

Install Automation 360 and point the database server to this instance of the SQL database. See [Customize Control Room installation on Microsoft Azure](#).

Operating system, environment, and platform supported for Control Room

Automation 360 can be hosted on AWS, Microsoft Azure, Google Cloud Platform, IBM, and any public, private, or hybrid cloud service that meets the Control Room and Bot Agent hardware and software requirements.

Automation 360 is currently certified on AWS, Google Cloud Platform, and Microsoft Azure. For Bot Agent operating system and platform compatibility, see the Bot Agent compatibility matrices in [Bot Agent compatibility](#).

Automation 360 supports the 64-bit version of the Microsoft operating system.

Recommendation: Enable Desktop Experience when using the server or client operating system.

Note: When you install the Control Room on Microsoft Windows Server 2012 and 2012 R2 Datacenter, a warning message indicating installation prerequisites is displayed. However, you can still proceed with the installation without any issues.

Note: Before you install the Control Room for On-Premises, ensure that you have installed the Visual C++ Redistributable for Visual Studio 2015 package on the Control Room host machine. For more information about the package, see [Visual C++ Redistributable for Visual Studio 2015](#).

The following sections list the environment and deployment types with the release or build number applicable to each supported operating system:

Microsoft Windows Server 2012 and 2012 R2 Datacenter

Environment	Automation 360 build (version)
<ul style="list-style-type: none"> Amazon Web Services Elastic Compute Cloud (EC2) 	<ul style="list-style-type: none"> On-Premises: Build 4105 (A2019.12) or later Cloud: Build 4111 (A2019.12) or later
<ul style="list-style-type: none"> Microsoft Azure VM 	<ul style="list-style-type: none"> On-Premises: Build 4105 (A2019.12) or later Cloud: Build 4111 (A2019.12) or later
<ul style="list-style-type: none"> Google Compute Engine 	<ul style="list-style-type: none"> On-Premises: Build 7103 (A2019.17) or later

Microsoft Windows Server 2016 Standard and Datacenter

Microsoft Windows Server 2016 is the minimum recommended operating system.

Environment	Deployment type with release and build
<ul style="list-style-type: none"> Microsoft Azure VM 	<ul style="list-style-type: none"> On-Premises: Build 2079 or later Cloud: Build 2079 or later
<ul style="list-style-type: none"> Google Compute Engine 	<ul style="list-style-type: none"> On-Premises: Build 7103 (A2019.17) or later

Environment	Deployment type with release and build
<ul style="list-style-type: none"> VMware VMs on ESXi 6.x 	<ul style="list-style-type: none"> On-Premises: Build 7103 (A2019.17) or later Cloud: Build 2079 or later

Microsoft Windows Server 2019 Standard and Datacenter

Environment	Deployment type with release and build
<ul style="list-style-type: none"> Amazon Web Services Elastic Compute Cloud (EC2) 	<ul style="list-style-type: none"> On-Premises: Build 1089 or later Cloud: Build 1082 or later
<ul style="list-style-type: none"> Google Compute Engine 	<ul style="list-style-type: none"> On-Premises: Build 7103 (A2019.17) or later
<ul style="list-style-type: none"> Microsoft Azure VM 	<ul style="list-style-type: none"> On-Premises: Build 2079 or later Cloud: Build 2079 or later

Microsoft Windows 10

Environment	Deployment type with release and build
<ul style="list-style-type: none"> VMware VMs on ESXi 6.x 	<ul style="list-style-type: none"> On-Premises: Build 7103 (A2019.17) or later Cloud: Build 2079 or later

Linux CentOS

Environment	Deployment type with release and build
<ul style="list-style-type: none"> Amazon Web Services Elastic Compute Cloud (EC2) 	<p>For Linux CentOS 7.7:</p> <ul style="list-style-type: none"> On-Premises: From Build 2545 or later Cloud: From Build 2545 or later <p>For Linux CentOS 7.9 and 8.3:</p> <ul style="list-style-type: none"> On-Premises: From Build 9664 or later Cloud: From Build 9664 or later

Red Hat Enterprise Linux

Environment	Deployment type with release and build
<ul style="list-style-type: none"> Amazon Web Services Elastic Compute Cloud (EC2) 	For Red Hat Enterprise Linux 7.7: <ul style="list-style-type: none"> On-Premises: From Build 2545 or later Cloud: From Build 2545 or later For Red Hat Enterprise Linux 7.9: <ul style="list-style-type: none"> On-Premises: From Build 9664 or later Cloud: From Build 9664 or later

Amazon Linux 2

Environment	Deployment type with release and build
<ul style="list-style-type: none"> Amazon Web Services Elastic Compute Cloud (EC2) 	Amazon Linux 2

Related reference

[Bot Agent compatibility](#)

Before you install the Bot Agent, ensure that it is compatible with the hardware and software in your environment.

[Control Room server requirements](#)

The Control Room is deployed on servers in data centers. The minimum Automation Anywhere hardware requirements include server type, machine type, processor, RAM, disk storage, and network requirements.

Supported cloud platforms

Review the supported cloud platforms for various Automation 360 features.

Automation 360 feature	Google Cloud Platform	AWS	Microsoft Azure
Control Room	Yes	Yes	Yes
Bot Agent	Yes	Yes	Yes
Bot Insight	Yes	Yes	Yes
IQ Bot	Yes	Yes	Yes
Discovery Bot	Yes	Yes	Yes
AI Sense Recorder	Yes	Yes	Yes

Credential requirements

Login credentials are required at different stages of Automation 360 deployment and use. Credentials are required for installation and data center servers, access to Automation 360 components, and to run tools in bots.

Access point	Task	Type
Data center servers	Install Control Room.	User on the hosting server: <ul style="list-style-type: none"> Windows - system administrator Linux - superuser sudo, root
Data center servers	Manage (run, stop, restart) Control Room.	Administrator and Logon as Service permission for Windows services and the Domain or the VM technical user account.
Bot Agent devices	Install, setup, or update Bot Agent.	Administrator permission on the device.
Bot Agent devices	Start or stop Bot Agent service.	Administrator permission on the device. Write permission on Bot Agent device system paths: C:\ProgramData C:\Windows\System32\config\systemprofile C:\Users\<loggedInUser>\AppData\Local\AutomationAnywhere
Local devices	Register device.	Windows login to open a browser and login into the Control Room and register the local device. Administrator permission not required.
Local devices	Download bots to local device. Run new bots or existing (downloaded) bots.	Windows login. Administrator permission not required.
Automation 360 login	Perform specific tasks, such as create a bot or run a bot.	License and role based permissions. Bot Creator and Bot Runner users do not require administrator privileges.

Access point	Task	Type
Bot task	Used by bots to perform bot tasks.	Credential Vault stores securely created credentials. Read permission on bot machine system path: C:\Windows \System32\config \systemprofile \AppData\Local \AutomationAnywhere
Automation Anywhere Service	Run all Windows services created by Automation 360.	Local system account user or Domain user account The Interactive logon rights should be enabled for the service account.
Remote Desktop Protocol (RDP) to a Windows machine	Run bots on Bot Creators and unattended Bot Runners if RDP connection exists for the deployed user.	Administrator permission is not required. RDP access for the bot is not required. View the Control Room Activity page.
Remote Desktop Protocol (RDP) to a server OS or a hosted VM	Run bots on Bot Creators and unattended Bot Runners if RDP connection exists for the deployed user.	Administrator permission required. RDP access for the bot is required. For confirmation, view the Control Room Activity page.

Data center server credentials

Data center server credentials for Automation Anywhere hosting servers and integrated product servers are required to deploy Automation 360.

To install and deploy Automation 360 requires that users log in to the hosting servers. These users must have permissions to install and run Automation 360 components on the servers. Permissions levels need to be assigned to the user on selected data center applications and servers.

Automation 360 login

Log in toAutomation 360 requires a username and password. These credentials are linked to the machine you use to access the Automation 360 components. Your credentials are assigned roles that give you permission to perform specific tasks, such as create a bot or run a bot.

Bot task

As an automation expert, Credential Vault provisions you to securely create and store your

Windows services

credentials. This ensures that your credentials can be used in bots without compromising security with safe deployment of tasks. Any authorized user can create credentials.

The Windows service credentials include a user name and password. The user specified needs to be:

- A member of the local system administrator group.
- Have permission to manage services, including Automation Anywhere services.
- If you use Windows authentication to connect to the SQL database, ensure you grant the `db_owner` permission to the service credential user.

The service credentials are used to create database tables and allow the Control Room processes to access the database and repository.

The service credential choices are:

User role	Bot program folder	Bot data folder	Log folders or files	User type
Install user	<ul style="list-style-type: none"> • Read • Write • Delete 	<ul style="list-style-type: none"> • Read • Write • Delete 	<ul style="list-style-type: none"> • Read • Write • Delete 	<ul style="list-style-type: none"> • Admin • Non-Admin
Service run user				<ul style="list-style-type: none"> • Local system account • Domain user account
Bot deployment user				<ul style="list-style-type: none"> • Local system account • Domain user account

The following are the different user types:

- Admin** A user who has administrator privileges.
- Non-Admin** A user who does not have administrator privileges.

- Local system account** The logged-on user performing the installation (default).
- Domain user account** A user that is not the local system account user.
- Reasons and requirements for using a domain account user include:
- **Use the Windows domain credentials**
Enter credentials valid for running Automation Anywhere services.
 - **PowerShell script restrictions**
Specify a user with permissions to launch PowerShell scripts, who is not a Windows domain user, or database table creation can fail.

Install Bot Agent and register device

Load balancer requirements

View the load balancer requirements for Automation 360 installation. This includes load balancer minimum requirements, and both TCP and HTTPS layer load balancing requirements.

Load balancer minimum requirements

As a best practice, ensure the load balancer:

- (Required) Adheres to the Domain Name System (DNS) guidelines when configuring the domain and subdomain URLs in load balancer.

Naming guidelines for Control Room URLs

- (Required) Supports WebSocket protocol (RFC 6455)
- (Preferred) Uses round-robin host selection and is not configured to use persistent (sticky) sessions.
- (Preferred) Uses the appropriate TLS security layer:
 - TCP (layer 4) load balancing
 - HTTPS (layer 7) load balancing

With a Nginx load balancer, set HTTPS termination at nodes by changing `http://Backend` to `https://Backend`.

- (Preferred) Has idle timeout set to 120 seconds.

The timeout value depends on the process time of various actions in the Control Room such as the time required to check in and check out bots, import bots, and download bot dependencies.

If the idle timeout is less than the Control Room processing time, a browser request can time out. For example, if the configured idle timeout is not sufficient to complete a bot check-in action, you will have to refresh your browser to validate whether the bot check-in action is successful or not.

Load balancer health check parameters

The load balancer health check parameters depend on various factors such as the type of load balancer used, network latency, and user interface responsiveness within and outside the load balancer.

TCP (Layer 4) Load Balancing

When TCP is applied at layer 4 with the load balancer, the certificate is installed on every Control Room corresponding to the load balancer URL.

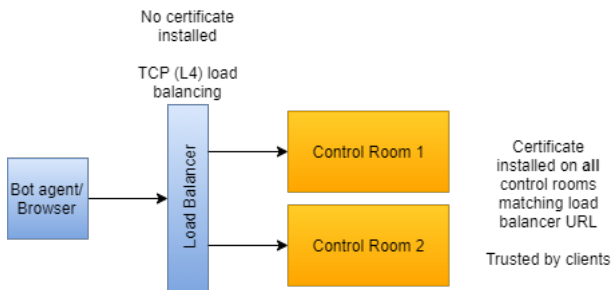

In the image, Control Room components are shown in orange and other components are shown in blue.

Pros

End-to-end encryption without the possibility of intercept at the load balancer.

Single certificate required.

Cons

If audit logging is required, the load balancer cannot report the requests from clients.

Does not use TLS hardware offloading, even if the load balancer supports it.

HTTPS (Layer 7) Load balancing

When HTTPS is applied at layer 7 with the load balancer, the certificate corresponding to the load balancer URL is applied through the load balancer. The Control Room trusts the certificates received from the load balancer.

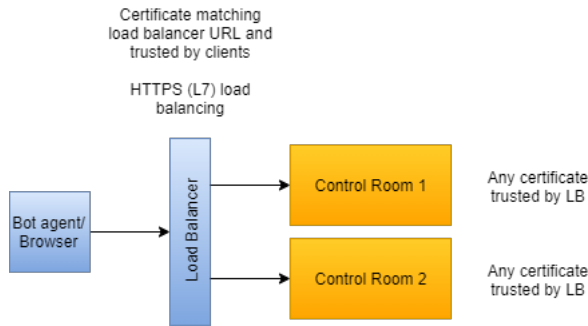
**Pros**

Allows request logging, when supported by the load balancer.

Reduces load from TLS handshake through hardware offloading, when supported by the load balancer.

Cons

Certificates must be managed both on the load balancer and on the control room nodes

Possible interception of data at the load balancer hardware level, because TLS session is not end-to-end.

For Automation 360 users on release Build 7560 and later, if SSL offloading is applied at load balancer level for communication between load balancer and application nodes, the `traefik.toml` file in application server needs to be re-configured.

See [SSL offloading for Automation 360 v.18 and later \(A-people login required\)](#) | [A360 / Device shows disconnected after registration with Load Balancer URL \(A-People login required\)](#)

Ports, protocols, and firewall requirements

View the default and configurable firewall, port, and protocol requirements for Automation Anywhere deployment. View the default ports and protocols that are required to be allowed on customer's firewall for Automation Anywhere deployment. The default ports that are used for HTTP/HTTPS are configurable.

- Add Automation Anywhere to the Windows Firewall exception list. Follow the steps as directed by Microsoft for your Windows version.
- Allow communication from Automation Anywhere by adding it to the allowed list in firewall. Follow the steps in the firewall documentation of the operating system.
- Configure the firewall rules and add the Control Room URLs to safe recipients list.
- Configure the firewall rules to allow communication on the server or the firewall appliances that are configured in between, or add the Control Room URLs to the safe recipients list in firewall or end device browsers.

Refer to the following tables for lists of required ports and their use.

Control Room



Warning: It is critical that communication between the Control Room servers is properly protected. The communication between Control Room servers contain security sensitive information. Therefore, in addition to allowing all the required communication directly between the Control Room cluster servers, you should block all the inbound traffic from hosts except for HTTP/HTTPS ports to communicate with the Control Room servers.

Protocol	Port	Usage	Clients
HTTP	80	HTTP	Web browsers
HTTPS	443	HTTPS and Web Socket	Web browsers
TCP/UDP	1234	ActiveMQ	Automation 360 Services
TCP	5672	Cluster Messaging	Automation 360 Services
TCP	47100 - 47200	Cluster Messaging and Caching	Automation 360 Services
TCP	47500 - 47598	Cluster Messaging and Caching	Automation 360 Services
HTTP	47599	Elasticsearch	Automation 360 Services
TCP	47600	Elasticsearch	Automation 360 Services
HTTP	4567	Control Room	Automation 360 Services
HTTP	4569 - 4571	Automation Anywhere Robotic Interface	Automation 360 Services
TCP	5800 - 5900	Automation Anywhere Robotic Interface	Automation 360 Services

Internal ports for localhost services

Note that the following internal ports are used for Automation 360 localhost services:

Port	Protocol
4567 - 4571	HTTPS REST
5678 - 5707	gRPC

Data center ports and protocols for Automation 360

Configure each of the data center components that are required for Control Room integration. In the image below, Control Room components are shown in orange and data center components provided by your organization are shown in blue.

Note: The arrows in the image indicates the combination of communicating hosts and does not indicate the direction of the establishing the connection.

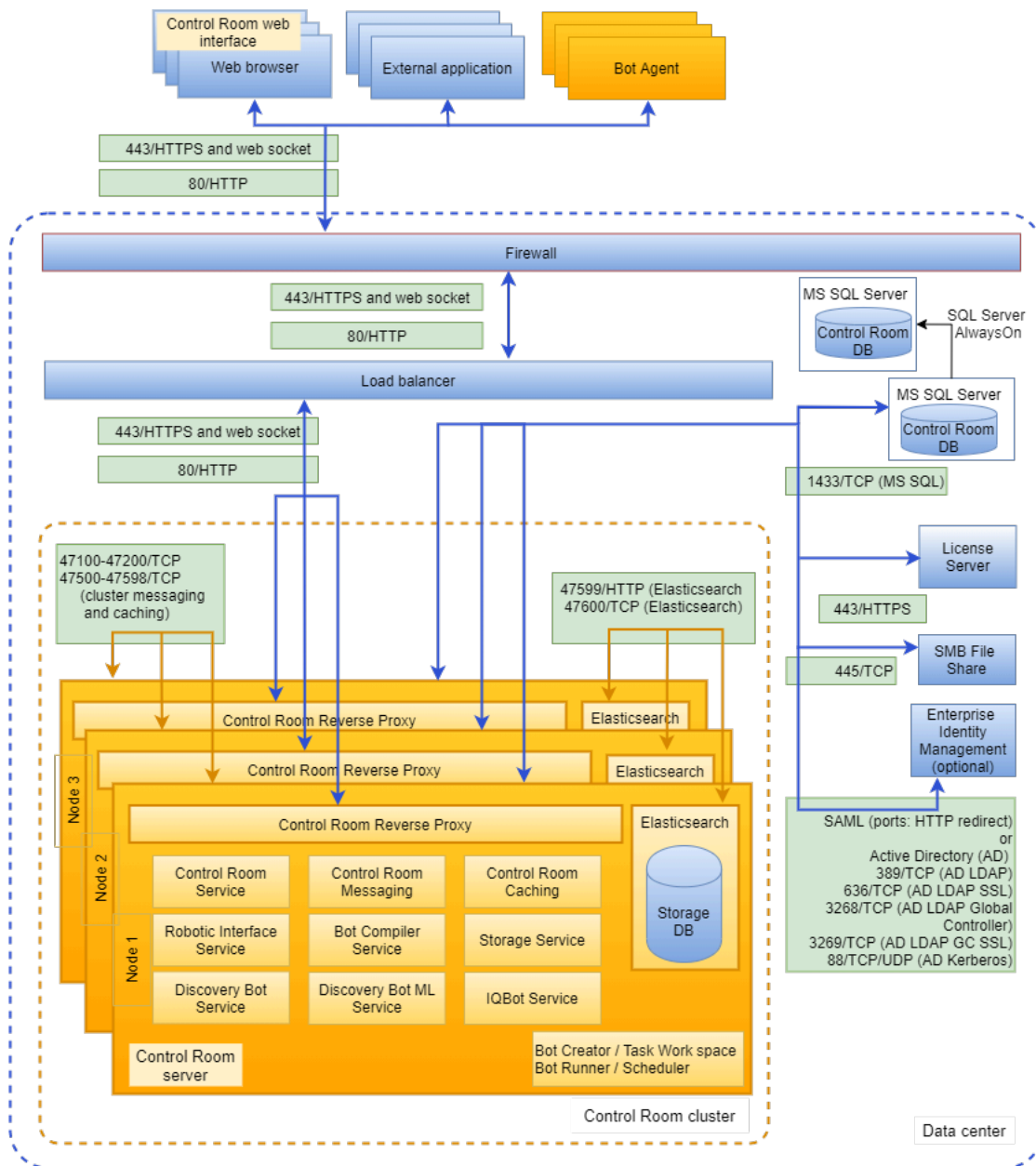

Default ports are listed for illustration purposes. Some ports can have alternative port numbers specified during Control Room installation. Some port numbers can be modified after Control Room installation. Active Directory ports are listed as an example of an enterprise identity management.

After the HTTP/HTTPS connection is established between the Control Room and Bot Agent, the communication will be bidirectional (inbound and outbound) using the WebSocket .

All three objects, the web browser, Bot Agent, and external applications communicate directly with the Control Room. A user logs into the Control Room through a browser, to do tasks, such as creating users, or bot related tasks, such as creating, deploying, and scheduling bots. Bot Agent establishes a connection with the Control Room on registration and keeps it alive in order to receive bot deployments from the Control Room. External applications talk to the Control Room directly through the Control Room APIs to perform tasks such as creating users or running bots.

Connection from	Connection to	Protocol	Port	Usage
Bot Agent	Load balancer and/or firewall	HTTP and WebSocket	80 (TCP) Default	HTTP and WebSocket

Connection from	Connection to	Protocol	Port	Usage
Bot Agent	Load balancer and/or firewall	HTTP and WebSocket	443 (TCP)	HTTP and WebSocket
Web Browser	Load balancer and/or firewall	HTTP and WebSocket	80 (TCP)	HTTP and WebSocket
Web Browser	Load balancer and/or firewall	HTTP and WebSocket	443 (TCP)	HTTP and WebSocket
Control Room services	Enterprise identity management (for example, Active Directory)	LDAP	389 (TCP)	User authentication
		LDAP SSL	636 (TCP)	User authentication
		LDAP global controller	3268 (TCP)	User authentication
		LDAP global controller SSL	3269 (TCP)	User authentication
		Kerberos	88 (TCP)	User authentication
Control Room services	File share with Microsoft Server Message Block (SMB)	SMB 2.0 or SMB 3.0	445 (TCP)	Repository file share access
Control Room services	Microsoft SQL database server	SQL	1433 (TCP) Configurable	Database access

Microsoft Azure supported data center elements

Data center object	Supported version	Configuration
Control Room operating system	<ul style="list-style-type: none"> Microsoft Windows Server 2012 and 2012 R2 Datacenter Microsoft Windows Server 2016 Standard and Datacenter Microsoft Windows Server 2019 Standard and Datacenter 	IaaS
Identity management: Azure <i>Active Directory</i>	Azure Active Directory	<ul style="list-style-type: none"> IDaaS Windows 2016 for IaaS
<i>SMB File Share</i>	Azure File Share with Server Message Block 2.0 and 3.0 (SMB) protocol	PaaS

Data center object	Supported version	Configuration
<i>Load Balancer</i>	Azure Load Balancer (Not Application Gateway)	PaaS
<i>Microsoft SQL Server</i>	Azure SQL Database with single database (Microsoft SQL Azure (RTM) - 12.0.2000.8)	PaaS

Microsoft Azure security policy recommended ports

Data center object	Port	Protocol
Control Room	<ul style="list-style-type: none"> • 80 • 443 	HTTP/HTTPS
LDAP	<ul style="list-style-type: none"> • 3268 • 3269 	TCP (LDAPS - Secure TCP)
email SMTP	587	SMTP
SSH	22	TCP
RDP	3389	TCP

Google Cloud Platform security policy recommended ports

Data center object	Port	Protocol
Load balancer	<ul style="list-style-type: none"> • 80 • 443 	<ul style="list-style-type: none"> • HTTP • HTTPS
Firewall	<ul style="list-style-type: none"> • 80 • 443 • 1433 	<ul style="list-style-type: none"> • HTTP • HTTPS • TCP
Microsoft SQL Server database	1433	TCP

Related tasks

[Prepare for installation on Amazon Web Services](#)

Use these steps to prepare the Amazon Web Services (AWS) instances for the Control Room installation.

[Verify readiness for installation on Microsoft Azure](#)

Use these steps to configure third-party products for the Control Room installation.

Related reference

[Automation 360 On-Premises prerequisites](#)

Determine whether the system has the required hardware and software to install Control Room for Automation 360 On-Premises.

[Add Automation 360 Cloud DNS to trusted list](#)

To ensure secure access to Automation 360 cloud services, add specific Automation Anywhere Domain Name System (DNS) to the safe recipients or trusted list.

Control Room repository requirements

The repository location is configured in the Control Room after installation. All your automations are stored in this repository.

Before you configure the Control Room server repository, review the repository requirements for deploying Automation 360 On-Premises.

- For a single node Control Room deployment, the repository can be a local folder.
For example, `C:\Automation360\Automation Anywhere Server Files`.
- For a multiple-node Control Room deployment, the repository should be accessible from all Control Room nodes in the cluster over the network.

You can create a file share and access the repository from a local machine. For example, `\<fileserver>\<folder>\Automation Anywhere Server Files`.

The Control Room repository contains server files, such as packages and resource files.

Microsoft Windows: Control Room repository requirements

Review the following requirements for configuring the repository location of cluster nodes:

- The Control Room uses its service account to connect to the repository, you must have read/write permission to the repository location.
- The repository path must meet the Universal Naming Convention (UNC) requirements.

For details, see [UNC Path](#).

- The repository size depends on the user data.

For details about storage requirements, see [Control Room server requirements](#). For supported file and folder size, see [Concurrent bot deployments and executions](#).

For repository migration requirements, contact your Automation Anywhere representative.

- You can configure the repository using Network File System (NFS) protocols, such as Microsoft Windows, Microsoft Azure Files, and Amazon Elastic File System (EFS).
- Network-attached storage (NAS) uses Server Message Block version 3 (SMBv3) for supported platforms: Microsoft Windows, Amazon Web Services, Microsoft Azure, Google Cloud Platform, and Linux.

Linux: Control Room configuration using the default repository path

- Ensure that the default path exists in the system and use this default path during the Linux installation.
After the installation, you can modify the repository path or copy files from one directory to another. Verify that all copied files and folders have the same permissions as before the installation.
- Ensure that permission for the path is `crkernel:controlroom`.
- If there is no permission, add the following permission.

```
sudo chmod -R 775 /opt/automationanywhere/enterprise/appdata
```

- Run the following command to allow users access to the `crkernel:controlroom` path:

```
sudo chown -R crkernel:controlroom /opt/automationanywhere/enterprise/appdata
```

Linux: Control Room configuration with a user-defined repository path

- Ensure that the default path exists in the system.
- Ensure that permission for the path is `crkernel:controlroom`.
- If there is no permission, add the following permission.

```
sudo chmod -R 775 /CRRepo/AutomationAnywhere
```

- Run the command to allow users access the `crkernel:controlroom` path:

```
sudo chown -R crkernel:controlroom /CRRepo/AutomationAnywhere
```

The `crkernel:controlroom` user is created after the Control Room installation, so set the user permission to a specified repository before performing the final Control Room configuration.

Browser requirements for RPA Workspace

Access the RPA Workspace interface from a browser. After you have installed and enabled extensions in the browser, perform several tasks through the RPA Workspace interface based on your user role and automation requirements.

Announcement: As Microsoft Internet Explorer 11 is reaching end-of-life (EOL) in June 2022, Control Room will not be supported on Microsoft Internet Explorer 11 browser from the upcoming Automation 360 v.25 release planned for later this year (June 2022).

The impact on your automation depends on the operating system that is currently used for your bot deployments. See the following table for details.

Microsoft operating system	Automation 360
Windows 10 Semi-Annual Channel	Upgrade bots to use one of the other compatible browsers. <i>Supported browsers</i>
All other supported operating systems <i>Bot Agent compatibility</i>	No action required.

For more information, see [Microsoft Internet Explorer 11 EOL FAQ](#).

Supported browsers

You can use a browser to perform a range of tasks from automation creation to automation management, such as the following:

- Control Room activities, such as creating users and roles, managing devices, configuring settings, creating and deploying bots, and maintaining audit logs.

- User activities, such as Bot Agent installation and device registration.
- Automation Anywhere Robotic Interface activities, such as creating users and roles and creating a human and bot tasks in the process editor.

Browser support for Control Room and Bot Agent and Automation Anywhere Robotic Interface

The following table shows supported browsers for Control Room activities, Bot Agent installation, Automation Anywhere Robotic Interface, and device registration:

Activity	Google Chrome (version 57 or later)	Internet Explorer (version 11)	Microsoft Edge based on Chromium (version 93.0.96 or later)	Mozilla Firefox (version 80 or later)	Safari (version 15.3 or later)
Control Room activities	Yes	No	Yes	No	No
Bot Agent installation and device registration ¹	Yes	No	Yes ³	Yes	No
Automation Anywhere remote agent for Citrix	Yes ²	Yes	No	No	No
Automation Anywhere Robotic Interface	Yes	No	Yes	No	Yes
Bot Insight	Yes	No	Yes	Yes	No

1. If you have trouble registering your device from a browser, run the Bot Agent diagnostic utility.

For details, see [Perform Bot Agent diagnostic checks](#)

2. Automation Anywhere remote agent for Citrix supports Google Chrome (XenApp) automation with Automation Anywhere extension (version 11.2.0.0).

[Chrome web store](#)

- If you are using Microsoft Edge based on Chromium to register your Bot Agent and your device is unable to connect to the Control Room due to proxy settings, add the authentication details.

Browser support for recording automation

The following table shows supported browsers for recording automation:

Activity	Google Chrome (version 57 or later)	Internet Explorer (version 11)	Microsoft Edge based on Chromium (version 79 or later)	Mozilla Firefox (version 80 or later)	Microsoft Edge (Chromium) with Internet Explorer compatibility (version 93.0.961.52 or later)
Record automation ¹	Yes ¹	Yes	Yes	Yes	Yes ²
	<ul style="list-style-type: none"> • Extension must be enabled for recording. • Supported from A2019 v.10. 	<ul style="list-style-type: none"> • Extension must be required for recording. • Supported from A2019.06. 	<ul style="list-style-type: none"> • Extension must be enabled for recording. • Supported from A2019 v.17. 	<ul style="list-style-type: none"> • Extension must be enabled for recording. • Supported from A2019 v.19. 	<ul style="list-style-type: none"> • Internet Explorer with compatibility mode must be enabled for recording. • Supported from Automation 360 v.23.

- Record automation refers to opening a target application for recording in a supported browser, and recording actions or capturing objects using the Automation Anywhere recorders.
 - For details on automation using Universal Recorder and Recorder capture action, see [Universal Recorder for object-based automation | Edit a task recorded with the Universal Recorder](#)
 - If you have trouble recording automation using Google Chrome, see [Google Chrome extension troubleshooting](#)

2. Microsoft Edge (Chromium) with Internet Explorer compatibility mode is supported for capturing objects from web applications based on HTML technology.

Extensions for automation

When you install the Bot Agent from a browser, extensions for Automation 360 are installed. Extensions are required to record automation using a supported browser.

You can enable extensions on a device from supported browsers. For example, after you install a Bot Agent from a Google Chrome browser, click the enable extension option from the browser task bar. The Google Chrome extension will allow you to record automation using the Google Chrome browser.

When you connect your Bot Agent device to the Control Room, you can enable the following extensions from your browser to record automation:

Extension name	Link to extension
Google Chrome	Automation 360 extension for Chrome
Microsoft Edge based on Chromium	Automation 360 extension for Microsoft Edge
Mozilla Firefox	Automation 360 extension for Mozilla Firefox

For updates to latest extension version, see [Enhancements to browser extensions](#)

Related tasks

[Perform Bot Agent diagnostic checks](#)

Use the Bot Agent diagnostic utility for connectivity-related issues between the Bot Runner device and Control Room. The utility helps to diagnose issues either by providing solutions or suggestions to help resolve the issues.

Related reference

[Universal Recorder supported applications and browsers](#)

Use the Universal Recorder to record interactions with objects from the supported technologies.

[Bot Agent compatibility](#)

Before you install the Bot Agent, ensure that it is compatible with the hardware and software in your environment.

[Google Chrome extension troubleshooting](#)

If you encounter an error when recording or running a bot that automates tasks in a Google Chrome browser and you have installed Google Chrome, you must perform additional steps to configure your system.

[Enhancements to browser extensions](#)

Create automation from supported browsers by using browser extensions. Extensions are periodically updated to support feature enhancements and fixes. Therefore, ensure that you have the latest versions of extensions for the Google Chrome, Microsoft Edge, and Mozilla Firefox browsers.

Internationalization, localization, and language support

Automation 360 provides internationalization and localization support for its user interface (UI), automation, and documentation.

Internationalization means that you can automate using supported languages. Localization means the user interfaces are translated to languages supported by Automation Anywhere. Also, these supported languages have been tested and certified to work in that language.

Internationalization

Perform automation in various languages to work with localized operating systems and keyboards.

Encoding format

UTF-8 is the default encoding format for Automation 360.

Product documentation

View the Automation Anywhere documentation in the supported language at <https://docs.automationanywhere.com/>. To view information in one of the supported languages, select the language from the drop-down menu at the top-right of the website. The default language is English for any topic that is not available in another language.

Interface

View the user interface for Automation 360 components, including Control Room and IQ Bot, in the supported language.

- Automate applications (web and desktop) with the language UI, text, and controls values (for example, push-button with a language name and combo-box items in language text).
- Provide the language name to a bot, workflow, and report in Control Room.
- Provide the language name to bot schedules, automation name and description, role name and description, a user's first and last names, workload pools, and queues.
- Deploy bots with the language name on Bot Runners.
- View the language entities (names, description, and so on) across all the pages in Control Room.

Select a language in the user interface

From the Control Room interface, next to the user ID, click the language icon (globe icon) and select a language from the list.

Parts of the Control Room interfaces that are translated do not include the applications or tools that are used within the bots. For example, Microsoft Excel is not translated through the Control Room.

Automation 360

Note: The language setting of the Control Room does not translate language in Bot Insight, due to the difference in applications. For alternative languages in Bot Insight, users should seek translation from either browser language options or an operating system, configured to their language of choice.

Language	Internationalization (operating system and character set)	Localization (user interface)	Product documentation
Arabic	Available	Not available	Not available
Chinese (Simplified)	Available	Available	Available
Chinese (Traditional)	Available	Available	Available
Danish	Available	Not available	Not available
Dutch (Netherlands)	Available	Not available	Not available
French	Available	Available	Available
German	Available	Available	Available
Hebrew	Available	Not available	Not available
Hungarian	Available	Not available	Not available
Italian	Available	Available	Available
Japanese	Available	Available	Available
Korean	Available	Available	Available
Polish	Available	Not available	Not available
Portuguese (Brazil)	Available	Available	Available
Russian	Available	Available	Available
Spanish	Available	Available	Available
Swedish	Available	Not available	Not available
Turkish	Available	Not available	Not available

Automation 360 IQ Bot

Language	Internationalization (operating system and character set)	Localization (user interface)	Product documentation
Arabic	Available	Not available	Not available
Chinese (Simplified and Traditional)	Available	Available	Available
French	Available	Available	Available
German	Available	Available	Available

Language	Internationalization (operating system and character set)	Localization (user interface)	Product documentation
Italian	Available	Available	Available
Japanese	Available	Available	Available
Korean	Available	Available	Available
Portuguese (Brazil)	Available	Available	Available
Russian	Available	Available	Available
Spanish	Available	Available	Available

Components for Control Room and bot actions

Control Room and bots have additional requirements depending upon the Automation 360 deployment model you choose. Some third party applications are installed with Automation 360.

Control Room supported platforms

View the listed supported platforms and components for Control Room.

Component	Supported Control Room option
Amazon Web Services Elastic Compute Cloud (EC2)	Required to install Control Room platform.
HTML	Required for Microsoft Azure: Use Load Balancer, not Application Gateway.
Java Database Connectivity (JDBC) driver	Required for Oracle Database.
Linux CentOS or Red Hat Enterprise Linux	Python 3.6 required for Build 6463 and later. Install Control Room platform.
Microsoft Active Directory	Required to configure as either IDaaS or IaaS. For IaaS use Windows 2016.
Microsoft Azure	Required to install Control Room platform.

Third-party components for bot actions

View the listed third party components for the bot actions.

Component	Automation 360 Plug-in	Supported Bot action
ABBYY FineReader Engine version 12.2.27.12		Required for capturing images in the OCR, AISense, and IQ Bot packages.

Component	Automation 360 Plug-in	Supported Bot action
Citrix Receiver Version 4.4 LTSR or later <hr/> Note: You can also use the Citrix Workspace app. All major releases of the Citrix Workspace app version .22 are certified.	Automation 360 Citrix remote agent	Prerequisite for bot actions on the Bot Agent installed on Citrix resident apps.
Citrix Virtual Apps version 6.5 or later	Automation 360 Citrix remote agent	Prerequisite for bot actions on business applications hosted on Citrix server resident apps. Supported with Universal Recorder.
IBM WebSEAL		For reverse proxy for Bot Runner.
Microsoft .NET Framework version 4.6.1 or later		For the Recorder package.

Supported special characters

Use only supported special characters when creating user names and passwords. Supported characters vary depending upon where they are used.

In all of the below listed cases, the standard alphanumeric characters, **a-z, A-Z, 0-9** are supported. The special characters allowed or specifically excluded from particular use are typical to standard English keyboards. See the table below to verify the special characters that can be used in names or passwords.

TLS certificate	Do not use at sign (@) in passwords
Wildcards	The asterisk (*) is supported.
Windows	Do not use the pipe () or semicolon (;) in user names or passwords.
Worksheet	Do not use the asterisk (*), question mark (?), or bracket left or right ([]) in the worksheet name.
Database	Do not use percent (%) or space () in the database name. Do not use semicolon (;) in the database username or password.

Supported characters

Characters supported for authentication are acceptable for both user names and passwords. In the table:

- **Supported** means the character is explicitly supported for that use.
- **Do not use** means the character is explicitly not supported for that use.
- **Double dash (--)** means results with using the character for that use are unknown.

Character	Windows authentication	Control Room authentication	Database name, username, or password	JSON Web Token authentication
ampersand (&)	Supported	Supported	--	Supported
angle bracket, left or right (< >)	Supported	--	--	--
apostrophe, straight single (')	Supported	--	--	--
asterisk (*)	Supported	--	--	--
at sign (@)	Supported	Supported	--	Supported
braces left or right ({ })	Supported	--	--	--
bracket left or right ([])	Supported	--	--	--
caret (^)	Supported	--	--	--
colon (:)	Supported	--	--	--
dollar sign (\$)	Supported	Supported	--	Supported
equal sign (=)	Supported	--	--	--
exclamation point (!)	Supported	Supported	--	Supported
hyphen (-)	Supported	Supported	Supported	Supported
parenthesis, left or right (())	Supported	--	--	--
percent (%)	Supported	Supported	Do not use	Supported
period (.)	Supported	Supported	Supported	Supported
pipe ()	Do not use	--	--	--
plus sign (+)	Supported	--	--	--
number sign (#)	Supported	Supported	--	Supported
question mark (?)	Supported	--	--	--
semicolon (;)	Do not use	--	Do not use	--
slash, forward or backward (/ \)	Supported	--	--	--
space	Supported	--	Do not use	--
underscore (_)	Supported	Supported	Supported	Supported

Citrix integration on Cloud

Automation 360 integration with Citrix enables you to create bots that run tasks on remote Citrix Virtual Apps servers.

Process overview

Ensure the following tasks are completed before you begin automating tasks in a Citrix environment:

Verify the Citrix component version

Following are the various Citrix components and its related versions that are supported for the Automation 360 integration with Citrix.

Citrix component version	Automation Anywhere Plug-in	Automation 360 client or Bot option
Citrix Receiver Version 4.4 LTSR or later	Automation Anywhere Citrix plug-in	For using Citrix server resident apps or installing Automation 360 client.
Note: You can also use the Citrix Workspace app. All major releases of the Citrix Workspace app version .22 are certified.	Automation Anywhere Citrix remote agent	
Citrix Virtual Apps version 6.5 or later		For using Citrix server resident apps.
Citrix XenDesktop Version 7.15 LTSR		For using Citrix server resident apps or installing Automation 360 client.

Verify credentials and licensing

- Ensure you have the credentials to access the Citrix server.

Note: We recommend you have different Citrix login credentials for each Bot Runner user.

- Ensure the appropriate Citrix license is available for the Automation Anywhere Enterprise system.

Install components

Specific Citrix and Automation Anywhere components are required on both the local user machine and the Citrix Virtual Apps server.

Local machine

1. Install Citrix Receiver.
2. Install the Bot Agent. This is automatically installed when you register the local machine with the Control Room.

The Bot Agent and Automation Anywhere plug-in for Citrix are installed at the same time if the Citrix Receiver is installed on the local machine.

3. Install the Automation Anywhere plug-in for Citrix.

If the Bot Agent is already installed, the Automation Anywhere plug-in for Citrix is automatically installed when the Universal Recorder is initiated.

Citrix server

1. Install the Automation Anywhere remote agent for Citrix.
2. Register the Automation Anywhere remote agent for Citrix as a Virtual App in the Citrix StoreFront.

Create a bot

1. From the Citrix StoreFront, run the **AARemoteAgent** and the target application.
2. From the Control Room, create the bot, start the **Recorder**, select the target application,

and record your actions on the Citrix server to build your bot.

Using Citrix architecture with bots

To create and run bots using applications that reside on a Citrix server, see the following resources:

[Using the Recorder on Citrix Virtual Apps servers](#)

The **Record: Capture** cloning action requires specific configurations to capture objects from applications available through the Citrix StoreFront on a remote Citrix Virtual Apps server. Ensure the required components are installed on the local machine and the remote Citrix Virtual Apps server.

Related concepts

[Installing Automation Anywhere remote agent on Citrix servers](#)

Install the Automation Anywhere remote agent on the Citrix Virtual Apps server where the virtualized applications are installed.

Related tasks

[Using the Recorder on Citrix Virtual Apps servers](#)

The **Record: Capture** cloning action requires specific configurations to capture objects from applications available through the Citrix StoreFront on a remote Citrix Virtual Apps server. Ensure the required components are installed on the local machine and the remote Citrix Virtual Apps server.

[Installing the Citrix required components on local machines](#)

Install the Automation Anywhere components to enable you to use bots on Citrix Virtual Apps servers. Two components are installed: Bot Agent and Automation Anywhere plug-in for Citrix.

Related reference

[Browser requirements for RPA Workspace](#)

Access the RPA Workspace interface from a browser. After you have installed and enabled extensions in the browser, perform several tasks through the RPA Workspace interface based on your user role and automation requirements.

Using the Recorder on Citrix Virtual Apps servers

The **Record: Capture** cloning action requires specific configurations to capture objects from applications available through the Citrix StoreFront on a remote Citrix Virtual Apps server. Ensure the required components are installed on the local machine and the remote Citrix Virtual Apps server.

Complete the steps listed in the following tasks:

- [Installing the Citrix required components on local machines](#)
- [Installing Automation Anywhere remote agent on Citrix servers](#)

If you are using Google Chrome for automation, ensure the Automation Anywhere extension (version 11.2.0.0) for Automation Anywhere remote agent for Citrix is installed and enabled. For Automation 360 remote agent, ensure that the Automation Anywhere extension (version 3.0.0.0 or later) is installed and enabled.

[Chrome web store](#)

Create bots with applications running on a remote Citrix Virtual Apps server using the Automation Anywhere remote agent for Citrix.

1. Log in to the Citrix Virtual Apps server StoreFront.

Note: You can also use the Citrix Workspace app. All major releases of the Citrix Workspace app version .22 are certified.

2. Depending on the Automation 360 release, select and run one of the following remote agents from the **Citrix StoreFront**.

- Select **Citrix server > Citrix StoreFront > AARemoteAgent**.

Note: **AARemoteAgent** is the Citrix name for the Automation Anywhere remote agent for Citrix.

- Select **Citrix server > Citrix StoreFront > A360 Remote agent**.

Note: **A360 Remote agent** is the Citrix name for the Automation 360 remote agent.

3. Run the target application from the Citrix StoreFront.
4. Log in to your registered local machine with the Bot Agent and Citrix Receiver installed.
5. Log in to the Control Room from your registered local machine.
6. Create a new bot or edit an existing bot.
7. Select the auto login feature to log in to a Citrix environment when it is locked or logged off.

Note: To ensure the auto login works, always log off the Citrix Receiver associated with the Citrix Virtual Apps server before you disconnect.

8. Start the **Recorder**.
9. From the **Automation Anywhere Record Application** selection window, select the target application from the drop-down list in the **Window or URL** field, and click **Start recording**.

Note: The remote application has `\\Remote` label at the end of the application name.

10. When the steps to record are completed, click **End recording**.

Related concepts

[Citrix integration on Cloud](#)

Automation 360 integration with Citrix enables you to create bots that run tasks on remote Citrix Virtual Apps servers.

[Installing Automation Anywhere remote agent on Citrix servers](#)

Install the Automation Anywhere remote agent on the Citrix Virtual Apps server where the virtualized applications are installed.

Related tasks

[Installing the Citrix required components on local machines](#)

Install the Automation Anywhere components to enable you to use bots on Citrix Virtual Apps servers. Two components are installed: Bot Agent and Automation Anywhere plug-in for Citrix.

Related reference

[Browser requirements for RPA Workspace](#)

Access the RPA Workspace interface from a browser. After you have installed and enabled extensions in the browser, perform several tasks through the RPA Workspace interface based on your user role and automation requirements.

Using Citrix XenDesktop on Cloud

Install the Bot Agent on a Citrix XenDesktop virtual machine to create or run bots using applications that reside on that Citrix XenDesktop virtual machine.

Ensure the required components are installed on the local Bot Agent machine and the remote Citrix server. The required components are:

On the local machine

Citrix Receiver: Install this on every machine you use to connect to a Citrix server.

Note: You can also use the Citrix Workspace app. All major releases of the Citrix Workspace app version .22 are certified.

On the Citrix XenDesktop

Bot Agent: Install this on the Citrix XenDesktop virtual desktop.

Log in to the Control Room and launch the recorder. This triggers the Bot Agent installer.

The Citrix XenDesktop is a virtual machine sitting on a remote Citrix server. It contains the applications to be used for the bots.

The following figure shows the process flow when the Bot Agent is installed on a Citrix XenDesktop with the applications on the virtual desktop.

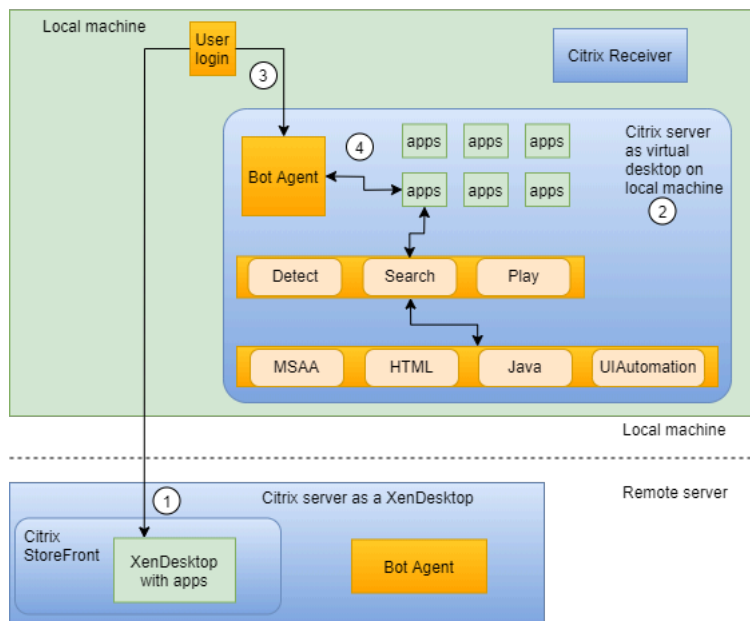

The Bot Agent can be installed on multiple platforms, which includes a Citrix XenDesktop virtual machine. Ensure the virtual desktop meets the requirements for any Bot Agent installation.

Create bots with Citrix XenDesktop.

1. Prepare for bot activities.
 - a) Install the Citrix Receiver on your local machine.

- b) Install the Bot Agent on Citrix XenDesktop.
2. From your local machine with Citrix Receiver installed, log in and open **Citrix server > Citrix StoreFront**.
3. Select the Citrix XenDesktop virtual desktop with the Bot Agent.
The whole Citrix XenDesktop is presented as a local virtual desktop on your local machine. This is automatic when you start the Citrix XenDesktop.
4. From the virtual desktop, launch the Enterprise Client that is installed on the Citrix XenDesktop, or launch a browser and log in to the Control Room.
5. From your Control Room, create the bot.

Installing the Citrix required components on local machines

Install the Automation Anywhere components to enable you to use bots on Citrix Virtual Apps servers. Two components are installed: Bot Agent and Automation Anywhere plug-in for Citrix.

1. Log in to your local machine.
2. Install Citrix Receiver.

Note: You can also use the Citrix Workspace app. All major releases of the Citrix Workspace app version .22 are certified.

This Citrix component is required to communicate from a local machine to a Citrix virtual application server.

To install the Citrix Receiver, see the Citrix documentation.

3. Register your local machine with the Control Room. This installs the Bot Agent.
The Bot Agent enables local machine communication with the Control Room.

To install the Bot Agent:

- a) Log in to the Control Room through your Automation Anywhere URL.
- b) Navigate to **Devices** in the **Manage** tab.
- c) From the action icons, click **Add local bot agent**.
- d) Click **Connect to my computer**.
- e) Follow the steps outlined in the wizard.
- f) Refresh the **Devices** page and verify that the local device is added.

4. Install Automation Anywhere plug-in for Citrix on your local machine.

The Automation Anywhere plug-in for Citrix provides the Citrix driver. This driver communicates with the Citrix server.

To install the Automation Anywhere plug-in for Citrix:

- a) Log in to the Control Room.
- b) Launch one of the designated events.
Designated events include: launch **Recorder**, use the **Devices** tab or **Device Status** tab, or run a bot from **Editor**.
- c) Optional: Verify that the Automation Anywhere plug-in for Citrix is installed.
Check for the file `C:\Program Files (x86)\Citrix\ICA Client\Automation.CitrixDriver.dll`.

Related concepts

[Citrix integration on Cloud](#)

Automation 360 integration with Citrix enables you to create bots that run tasks on remote Citrix Virtual Apps servers.

[Installing Automation Anywhere remote agent on Citrix servers](#)

Install the Automation Anywhere remote agent on the Citrix Virtual Apps server where the virtualized applications are installed.

Related tasks

[Using the Recorder on Citrix Virtual Apps servers](#)

The **Record: Capture** cloning action requires specific configurations to capture objects from applications available through the Citrix StoreFront on a remote Citrix Virtual Apps server. Ensure the required components are installed on the local machine and the remote Citrix Virtual Apps server.

Installing Automation Anywhere remote agent on Citrix servers

Install the Automation Anywhere remote agent on the Citrix Virtual Apps server where the virtualized applications are installed.

Based on the version of the Recorder package that you are using, choose the appropriate remote agent for your environment:

- For bots that use 2.8.6-20220823-160834 version of the Recorder package, install the new Automation 360 remote agent available with Build v 2.0.0.7. For details on installing the Automation 360 remote agent, see [Install remote agent: Recorder package version 2.8.6](#)
- For bots that use 2.7.3-20220527-004608 or earlier version of the Recorder package, install the Automation Anywhere remote agent for Citrix 1.0 available with Build v 1.0.0.0. For details on installing the Automation Anywhere remote agent for Citrix, see [Install remote agent: Recorder package version 2.7.3 and earlier](#)

Related concepts

[Citrix integration on Cloud](#)

Automation 360 integration with Citrix enables you to create bots that run tasks on remote Citrix Virtual Apps servers.

Related tasks

[Using the Recorder on Citrix Virtual Apps servers](#)

The **Record: Capture** cloning action requires specific configurations to capture objects from applications available through the Citrix StoreFront on a remote Citrix Virtual Apps server. Ensure the required components are installed on the local machine and the remote Citrix Virtual Apps server.

[Installing the Citrix required components on local machines](#)

Install the Automation Anywhere components to enable you to use bots on Citrix Virtual Apps servers. Two components are installed: Bot Agent and Automation Anywhere plug-in for Citrix.

Related reference

[Components for Control Room and bot actions](#)

Control Room and bots have additional requirements depending upon the Automation 360 deployment model you choose. Some third party applications are installed with Automation 360.

Install remote agent: Recorder package version 2.8.6

Install the Automation 360 remote agent available with Build v 2.0.0.7 on the Citrix Virtual Apps server where the virtualized applications are installed.

Keep the following considerations in mind when automating a task in the Citrix environment using the new Automation 360 remote agent for Citrix:

- If you are using Google Chrome for automation, ensure that the Automation Anywhere extension (version 3.0.0.0 or later) for Automation 360 remote agent is installed and enabled.

[Google Chrome extension for Automation 360](#)

- Both Automation Anywhere remote agent for Citrix and Automation 360 remote agent can run on Citrix environment at the same time.
- When you use the 2.8.6-20220823-160834 or later version of the Recorder package in your bots, we strongly recommend that you use the new Automation 360 remote agent. If you have not installed the new Automation 360 remote agent, then we have support for an automatic fallback where the existing Automation Anywhere remote agent for Citrix will be used.

Note: During fallback, the older Automation Anywhere remote agent for Citrix will work only with technologies and browsers that it supports.

-
- For Citrix automation, bots created using the 2.8.6-20220823-160834 or later version of the Recorder package will not work with the new Automation 360 remote agent if you downgrade the package to version 2.7.3-20220527-004608 of the Recorder.
 - We strongly recommend that you avoid using both the new Automation 360 remote agent and the Bot Agent installed over same Citrix environment because doing so can cause issues with browser automation with either of the approaches.
 - If you have bots that use 2.7.3-20220527-004608 or earlier version of the Recorder package, then the bots will use the existing Automation Anywhere remote agent for Citrix.
 - Automation 360 remote agent will not work if Citrix XenDesktop is also connected.
 - Technology selection drop-down option for Recorder is not supported.
 - Microsoft UI automation (COM) is not supported.
 - SAP automation is not supported.

The following technologies and browsers are supported with Automation 360 remote agent for Citrix:

- Google Chrome
- Internet Explorer
- Microsoft Edge
- Microsoft Edge with IE mode
- Mozilla Firefox
- Java
- Electron apps
- Microsoft Active Accessibility (MSAA)
- Microsoft UI automation

1. Log in to the Citrix Virtual Apps server.

2. Download the latest version of the Automation 360 remote agent installer file to the Citrix Virtual Apps server. The Automation 360 remote agent running on the Citrix server interprets data received from Automation 360 and responds appropriately.
 - a. Go to [A-People Downloads page \(Login required\)](#).
 - b. Select and download the Automation 360 remote agent.
3. Run the Automation 360 remote agent installer.
 - a. Extract the `A360.RemoteAgent.zip` file and double-click the `A360.RemoteAgent.exe` file.
 - b. On the **Automation 360 Remote agent Setup** screen, click **Next**.
 - c. On the **Select Destination Folder** screen, click **Browse** to specify a non-default location for installing the remote agent. Click **Next**.
The default location for installation is set to `C:\Program Files (x86)\Automation Anywhere\A360 Remote Agent`.
 - d. On the **Setup Status** screen, track the status of the installation process.
 - e. On the **Setup Wizard Complete** screen, click **Finish** to complete the setup.
4. From the Citrix interface, add the Automation 360 remote agent application to the Citrix **Delivery Controller**.
This registers the Automation 360 remote agent as a Virtual App in the Citrix StoreFront.
5. Verify that the Automation 360 remote agent is available from the Citrix StoreFront.
The Citrix StoreFront name for the Automation 360 remote agent is **A360 Remote agent**.

Install remote agent: Recorder package version 2.7.3 and earlier

Install the Automation Anywhere remote agent for Citrix available with Build v 1.0.0.0 on the Citrix Virtual Apps server where the virtualized applications are installed.

Keep the following considerations in mind when automating a task in the Citrix environment using the Automation Anywhere remote agent for Citrix:

- If an application hosted on the Citrix environment runs in elevated mode, the Automation Anywhere remote agent for Citrix must also run in elevated mode.
- If some applications hosted on the Citrix environment run in elevated mode and some on non-elevated mode, you can install two instances of the Automation Anywhere remote agent for Citrix: One instance of the agent will run in elevated mode and the other instance in non-elevated mode.
- If you are using Google Chrome for automation, ensure the Automation Anywhere extension (version 11.2.0.0) for Automation Anywhere remote agent for Citrix is installed and enabled.

Chrome web store

1. Log in to the Citrix Virtual Apps server.
2. Download the latest version of the Automation Anywhere remote agent for Citrix installer file to the Citrix Virtual Apps server. The Automation Anywhere remote agent for Citrix running on the Citrix server interprets data received from Automation 360 and responds appropriately.
 - a. Go to [A-People Downloads page \(Login required\)](#).
 - b. Select and download the Automation Anywhere remote agent for Citrix.

3. Run the Automation Anywhere remote agent for Citrix installer.
 - a. Extract the `AARemoteAgent.zip` file and double-click the `AAE_Remote_Agent_1.0.0.exe` file.
 - b. On the **Automation Anywhere Remote Agent Setup** screen, click **Next**.
 - c. On the **License Agreement** screen, accept the license agreement, and click **Next**.
 - d. On the **Select Destination Folder** screen, click **Browse** to specify a non-default location for installing the remote agent. Click **Next**.
 The default location for installation is set to: `C:\Program Files (X86)\Automation Anywhere\AARemoteAgent`
 - e. On the **Setup Status** screen, track the status of the installation process.
 - f. On the **Setup Wizard Complete** screen, click **Finish** to complete the setup.
4. From the Citrix interface, add the Automation Anywhere remote agent for Citrix application to the Citrix **Delivery Controller**.
 This registers the Automation Anywhere remote agent for Citrix as a Virtual App in the Citrix StoreFront.
5. Verify that the Automation Anywhere remote agent for Citrix is available from the Citrix StoreFront.
 The Citrix StoreFront name for the Automation Anywhere remote agent for Citrix is **AARemoteAgent**.

HA and DR deployment models

Automation 360 provides several deployment options to meet various levels of enterprise cost/price performance and resiliency requirements. The options include installation on single nodes and on multiple nodes. Multi-node deployments can be configured for highly available (HA) clusters and disaster recovery (DR) sites.

The deployment services are set up using the Automation 360 installer. A typical Automation 360 server node runs the following services:

- Automation Anywhere Automation Services
- Automation Anywhere Messaging Services
- Automation Anywhere Caching Services
- Automation Anywhere Search Services
- Repository storage
- (Optional) IQ Bot VM

The Automation 360 installer also supports the multi-node deployment configuration.

Planning

Identify your requirements before selecting a deployment model. For best results, deploy the same operating systems across the RPA Workspace development, testing, and production environments. At minimum, have the same OS on both test and production environments.

Deployment models

At a high level, there are two ways to deploy or install Automation 360 - single-node and multi-node. Choose the option that meets your business continuity requirements.

Single-node deployment

As the name suggests, there is a single physical server node, on which all the services related to Automation 360 are run. By design, this configuration does not provide any redundancy and hence the availability depends on the services on this single node.

Database

In single-node deployment, the database can be anywhere if the Control Room server is able to connect to the database server. This can involve network configurations.

Note: You cannot host the database server on the same server as the Control Room server as it requires higher processing/memory configuration on the server.

Characteristics

- No disaster recovery (single point of failure): If the single node fails, RPA operation will be adversely affected.
- No high availability: If the server is taken offline for upgrade or maintenance, RPA operations will be affected.
- No RPA up-scaling: When RPA deployments scale up and users increase, the single node will have to manage the increased load. This might adversely affect the RPA performance.

Usage Recommendations

Single-node deployments are typically recommended for small-scale usage in proof of concepts, demos, testing, and trials, to name a few.

Single-node deployments are NOT RECOMMENDED for production usage because any downtime will impair RPA operation and business continuity.

Advantages

- Quick and easy installation and setup
- Additional servers not required
- Load balancers and clustering configuration not required

The following image shows the Automation Anywhere and data center components for a single node. The Automation Anywhere components are shown in orange and components provided by your organization are shown in blue. Components that are centrally hosted on cloud and managed by Automation Anywhere such as license server are shown in light orange.

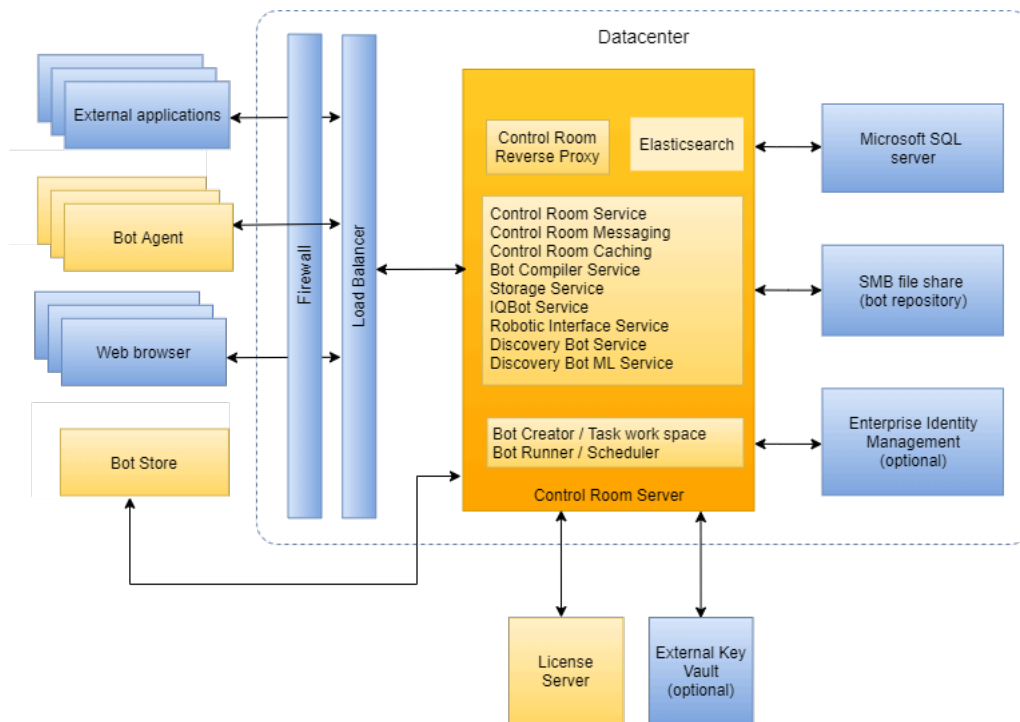

Multi-node deployment

To achieve higher processing scale, higher availability in production setups, Automation 360 services are deployed across multiple server nodes. Installer enables you to setup multi-mode configuration. This involves additional configuration steps such as linking services to same database and so on.

Distributed approach

The Control Room provides the flexibility to process large number of requests in given time window.

Deploy multiple instances of Control Room on multiple physical or virtual servers as required. This also means configuring the cluster setup for the caching, search, and messaging services.

Load balancing

Performed by a load balancer, this is the process of distributing application or network traffic across multiple servers to protect service activities, allowing workloads to be distributed among multiple servers. This ensures automation activity is continued on clustered servers.

Load balancer requirements

Databases

In multi-node deployments, databases use their own built-in failover to protect the data. This ensures database data recovery.

If you use cloud-based database services likes of AWS-RDS, the High Availability and Disaster Recovery as part of their service offerings, in which case no further database configurations are necessary.

For pure on-premises database scenarios, configure synchronous replication between the primary (active) and secondary (passive) clustered Microsoft SQL Server in the data center. This ensures consistency in the event of a database node failure.

For synchronous replication, configure the database using publisher and subscriber model in Microsoft SQL Server from the primary disaster recovery site to the secondary disaster recovery site that is at a geographically separated location from the primary site.

Replicate data between primary and secondary sites

The following image shows the Automation Anywhere and data center components for three nodes in a data center cluster. The Automation Anywhere components are shown in orange and components provided by your organization are shown in blue. Components that are centrally hosted on cloud and managed by Automation Anywhere such as license server are shown in light orange.

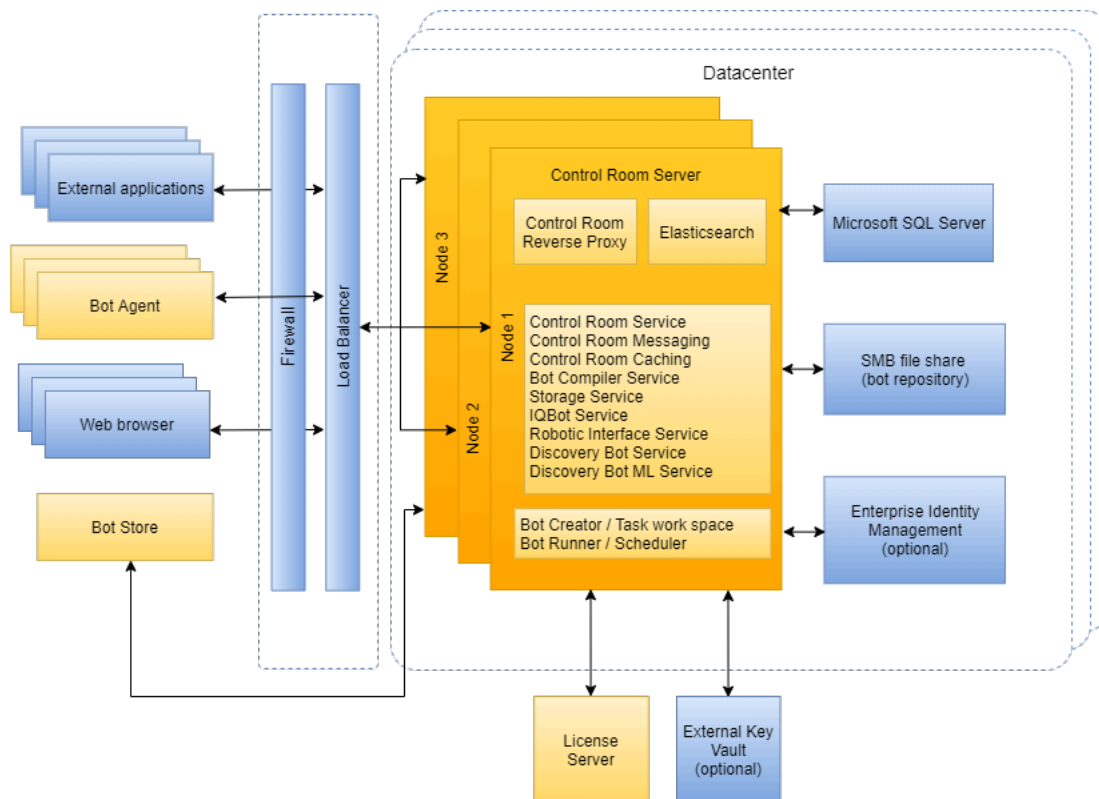

Important: Stretch clusters are not supported.

- Ensure that all the HA cluster nodes are configured in the same location. Do not configure the nodes in a single HA cluster that is located across various sites. Ensure that you configure one HA cluster at the primary site and the other HA cluster at the secondary site.
- The Control Room and IQ Bot must be configured in the same data center to ensure communication between both the applications.

Related concepts

[High availability deployment](#)

To support Automation 360 in your data center, configure an high availability (HA) cluster. Follow your company methods and procedures for implementing your data center cluster.

Convert single-node deployment to multi-node deployment

You can convert your single-node deployment into a multi-node deployment by editing the configuration files and restoring the data in the repository for the single-node setup.

The single-node deployment can run on one of several infrastructures, local machines, private data centers, and cloud providers.

To convert a single-node deployment running on AWS or other supported environment into a multi node-deployment, perform the following steps.

1. In the Task Manager, stop all Automation Anywhere services.
2. Stop the Control Room instance.
3. Create an Amazon Machine Images (AMI) instance using the Control Room instance.
For information about how to create AMI in AWS, see [Create an AMI from an Amazon EC2 Instance](#).
4. Create a new instance using the AMI created in the previous step.
5. Edit the configuration files related to the database server, Ignite cluster, and Elasticsearch to form the clusters in the configuration directory on a standard installation.

The files are located in `C:\Program Files\Automation Anywhere\Enterprise\config`

- a) Edit the database server URL to point to the intended database server in `boot.db.properties`.
Do not change the URL if the original server already refers to a non-localhost address.
- b) Edit the following property in the `cluster.properties` file:
Append the list with a new server IP in `ignite.discovery.static.ips=<existing list of ips>, <current server ip>`
- c) Edit the following properties in the `elasticsearch.yaml` file:
 - Add the current server address in `node.name: "<local-ip>"`
 - Add the current server address in `network.host: "local-ip"`
 - Leave the existing values intact and append the IP of the current server in `discovery.zen.ping.unicast.hosts: ["ip1", "<local-ip>"]`
 - Leave the existing values intact in `cluster.initial_master_nodes: ["<master-ip>"]`
6. Restore and mount the repository to the respective path from the same timed snapshot as the selected Control Room snapshot.
7. Update the configuration tables to ensure TCP visibility between the nodes.
8. Start the services on the replicated node and wait for a couple of minutes for the clustering to establish.
9. Log in to the Control Room to verify whether the bots are available and the repository structure is intact.
10. Check Git integration for standard installations.
If the installation has external Git configured, check the validity by exercising test check-in and confirm audit logs.

High availability deployment

To support Automation 360 in your data center, configure an high availability (HA) cluster. Follow your company methods and procedures for implementing your data center cluster.

Why only odd number of nodes are supported A cluster comprising even number of nodes can merge inconsistencies but can result in a split-brain condition where the cluster has no majority and cannot resolve transactions, which might result in data inconsistencies. Split-brain condition is a known limitation of clustering systems that can be caused by network issues including latency.

Deployment configurations with odd numbered nodes can help avoid split-brain issues and are recommended for Automation 360 deployments.

Quorum

The nodes determine which transaction can be processed through voting on each transaction. The number of votes constituting a majority of the nodes in the cluster is referred to as a quorum and determines how many nodes have to vote for or confirm a transaction before it can be processed.

Fault Tolerance

Fault tolerance in terms of node failure is determined by how many nodes can fail before a quorum or majority of nodes is not available to vote on the validity of any transaction. Fault tolerance is optimized with an odd number of nodes in the cluster because a majority in odd-numbered clusters is a lower number than in even-numbered clusters

Supported Configurations

A cluster with three or higher odd number of nodes prevents the split-brain condition or inconsistencies due to network issues, while giving the higher scale and availability.

Number of nodes in cluster	Majority (quorum)	Fault tolerance (node failures)	Support
3	2	1	Certified
5	3	2	Contact Automation Anywhere support
7 and so on	4 and so on	3 and so on	Contact Automation Anywhere support

Multi-availability Zone/Multi-datacenter Configurations

When going for a multi-zone deployment in further enhance the availability, say with 3 nodes deployment, we recommend that you have each

Control Room in separate availability zones. Deployments with more than 3 nodes, spread these deployments across at least 3 availability zones. One thing we need to be concerned about in these setups is the latency between the zones/providers. The nodes in a high availability cluster must be deployed in the same region.

In terms of the cloud providers, we currently support 3 major cloud providers - Amazon Web Services, Google Cloud Platform, and Microsoft Azure.

Note: In a multi-node environment, if a node goes down, operations such as bot deployments and schedules, triggers, and work items in queues on that node will be adversely affected.

Tip: For information on how to backup and restore files to recover a Control Room High Availability cluster in case of failure, see [Backing up and restoring a Control Room High Availability Cluster \(A-People login required\)](#).

Related concepts

[Disaster recovery deployment](#)

The disaster recovery (DR) deployment model uses high availability (HA) clusters distributed across separate geographic areas.

Related tasks

[Configure IP cluster](#)

Continue from the Control Room installer to the **Cluster Configuration** wizard page to configure resiliency requirements for the Control Room. Provide only one IP address to configure the Control Room on a single node. Provide multiple (three or more) IP addresses to configure the Control Room for high availability cluster.

[Configure disaster recovery site for Elasticsearch IP addresses](#)

If you have configured the Control Room for high availability (HA) and disaster recovery (DR) and installed the Control Room on both the primary and secondary sites, configure Elasticsearch IP addresses for the secondary site.

Related information

[Cluster coordination in ElasticSearch](#)

Disaster recovery deployment

The disaster recovery (DR) deployment model uses high availability (HA) clusters distributed across separate geographic areas.

Disaster recovery (DR) is a method where the two high availability (HA) data center configurations are separated geographically. In the event of a localized disaster at the primary site, the physically removed data center on the secondary site can resume functions with minimum downtime.

If there were external systems used in the setup, it is essential to restore the network level connectivity. Some examples for these external systems include any external key vaults, Git, and so on. All the firewall rules, IP white-listings, host-names referred in configurations are still intact and available to the restored services.

Recommendation: The Control Room clusters in the primary and secondary disaster recovery sites are recommended to use a minimum of three nodes each because a three-node configuration can help avoid split-brain issues with two-node clusters and increase security by using node authentication and transport layer security (TLS) features.

The following image shows the Automation Anywhere and data center cluster components for three nodes in primary and secondary sites configured for disaster recovery. The Automation Anywhere components are shown in orange and components provided by your organization are shown in blue. Components that are centrally hosted on cloud and managed by Automation Anywhere such as license server are shown in white.

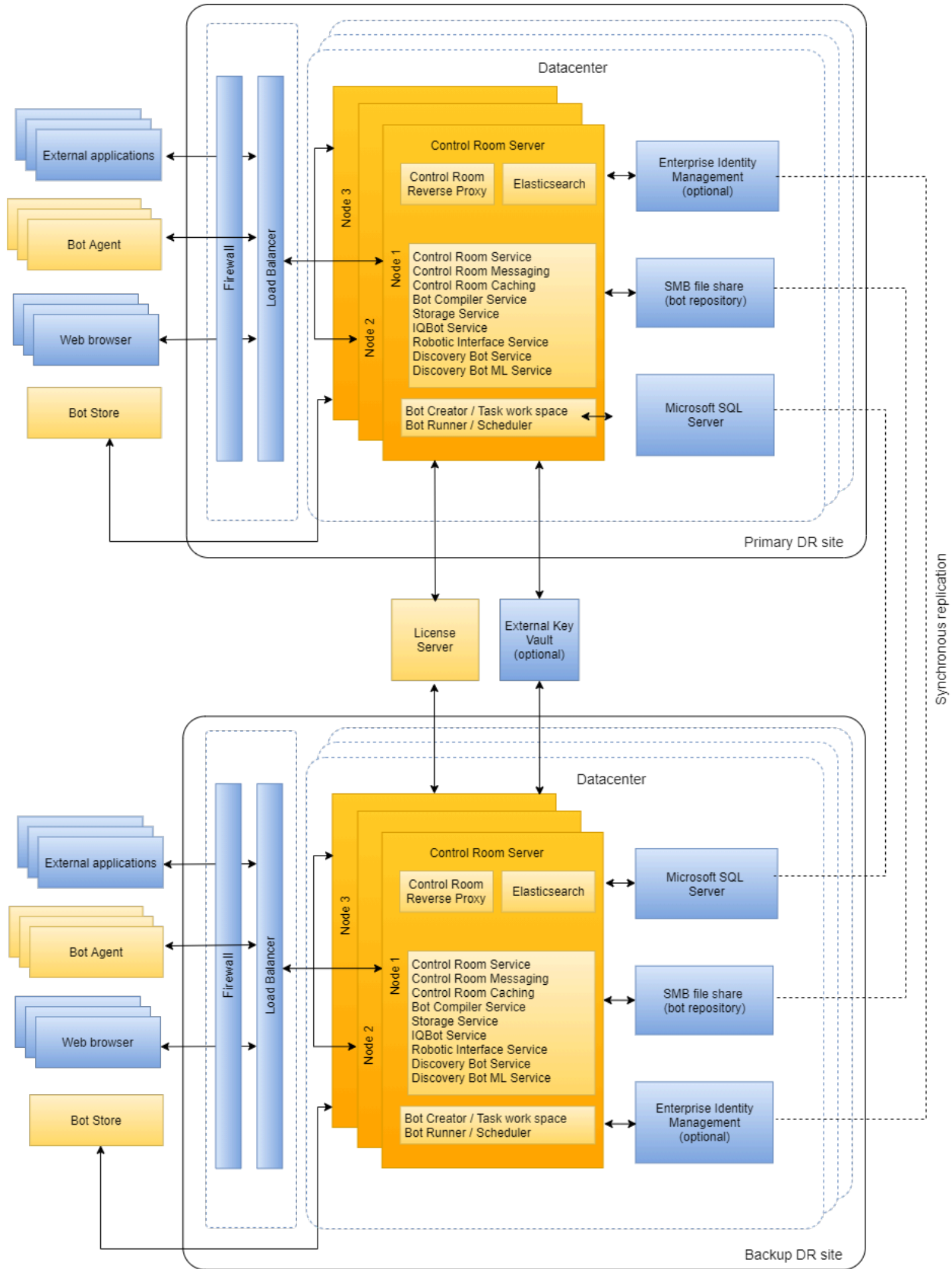

Disaster recovery methods

There are two ways to perform disaster recovery - Image based replication and Warm standby. Choose the option that meets your business continuity requirements.

Related tasks

[Image based replication](#)

The replication process is similar across environments and cloud providers. A scheduled way is used for creating and storing the snapshots. The snapshot interval is based on the tolerance of the customer for potential data loss.

[Replicate data between primary and secondary sites](#)

The process of replicating the data between the primary and the secondary site involves database replication using publisher and subscriber models in Microsoft SQL Server Management Studio, server repository replication using Windows Distributed File System (DFS), and backing up Elasticsearch (audit log) data.

Related information

[Cluster coordination in ElasticSearch](#)

Image based replication

The replication process is similar across environments and cloud providers. A scheduled way is used for creating and storing the snapshots. The snapshot interval is based on the tolerance of the customer for potential data loss.

We recommend that the replication schedule should be at least 1 day (one snapshot daily).

The following describes the procedure for AWS as an example cloud provider.

As a first step in any image-based DR setup, create snapshots at fixed intervals. In case of the disaster, the setup would revert to the latest good image/snapshot and system would be back, up and fully functional in a short time, however with a data loss and short down time.

1. Decide on the snapshot interval based on potential data loss.
2. Stop the Automation Anywhere services on the server being imaged.
3. If on AWS, create AMI using standard image creation steps.

[Create an AMI from an Amazon EC2 Instance](#)

4. After the image is created, start the Automation Anywhere services.
5. Run the repository backup mechanism on the same schedule.

The subsequent steps describe restoring data from an image.

6. Spin a new instance using the previously created AMI.

Depending on the original setup, if the setup is spread across availability zones, you must do the same in all relevant availability zones.

The following steps are applicable to each instance being recovered.

7. Edit the configuration files related to the database server, Ignite cluster, and Elasticsearch to form the clusters in the configuration directory.
On a standard installation, the files are located in: `C:\Program Files\Automation Anywhere\Enterprise\config`
 - a) Edit the database server URL to point to the intended database server in: `boot.db.properties`.
Do not change the URL if the original server already refers to a non-localhost address.
 - b) Edit the following property in the `cluster.properties` file:
Append the list with a new server IP in: `ignite.discovery.static.ips=<existing list of ips>, <current server ip>`
 - c) Edit the following properties in the `elasticsearch.yaml` file:
 - Add the current server address in: `node.name: "<local-ip>"`
 - Add the current server address in: `network.host: "local-ip"`
 - Leave the existing values intact and append the IP of the current server in: `discovery.zen.ping.unicast.hosts: ["ip1", "<local-ip>"]`
 - Leave the existing values intact in: `cluster.initial_master_nodes: ["<master-ip>"]`
8. Optional: If mounted, restore the repository from the same timed snapshot as the selected Control Room snapshot and mount to the respective path.
9. Update configuration tables.
10. Ensure Transmission Control Protocol (TCP) visibility between the nodes.
11. Start the services on the replicated node and wait for couple of minutes the clustering to establish.
12. Verify the following:
 - Login and check the bots are listed and visible.
 - If the installation has external Git configured, check the validity using functions such as check-in.
 - Verify the audit logs.
13. Update the load balancer tier or DNS as needed if any host names/IPs change with corresponding current values.

Related tasks

[Replicate data between primary and secondary sites](#)

The process of replicating the data between the primary and the secondary site involves database replication using publisher and subscriber models in Microsoft SQL Server Management Studio, server repository replication using Windows Distributed File System (DFS), and backing up Elasticsearch (audit log) data.

[Warm stand-by](#)

Host two setups or sites - primary and backup for the warm stand-by DR procedure.

Warm stand-by

Host two setups or sites - primary and backup for the warm stand-by DR procedure.

Each setup would have following recommended configurations:

1. Automation 360 hosted in clustered mode (three nodes)
2. SQL instance
3. Repository storage (shared network drive)
4. Git repository

Synchronous replication of the data onto the backup node should be configured. The backup node should have the exact same configuration as Primary node; except for Control Room.

- To sync Git repository, back up Git repository path from primary to backup path.
- To sync SQL database, setup replication from primary to backup database.

Replicate data between primary and secondary sites

Once configured the setup scheme would look like this:

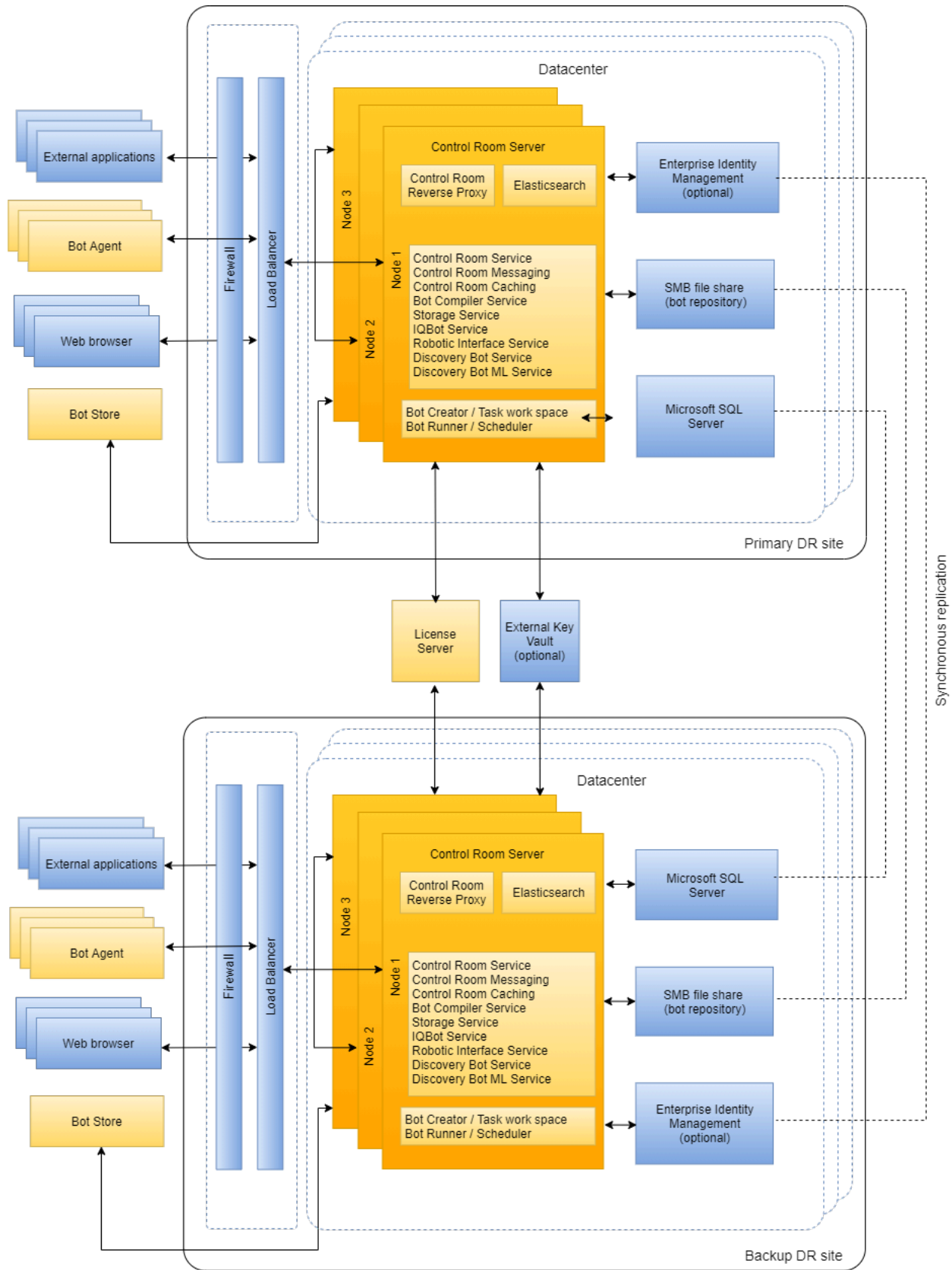

Complete the disaster recovery deployment on the two geographically separated sites, where one site is the primary (active) site and the other is the secondary (passive) site used for backup. If the primary site cluster fails, perform recovery on the secondary site.

Recommendation: The secondary site should be set up as a passive configuration so that the failover procedure can be performed without delay.

The procedure is identical regardless of whether you are switching over from primary to secondary, or from the secondary to primary sites. Connect the Control Room to the replicated database and shared the repository on the secondary site.

These steps apply to all the servers in the Automation 360 cluster, including the Control Room servers, SQL server, and Elasticsearch server.

1. Install Automation 360 on the secondary site.
Follow the steps for installation up to the database configuration.
Installing Control Room using Custom mode
2. In the **Database Configuration** window, add database details for the secondary site such as the database server IP address and default port number.
Configure Microsoft database type and server
3. Verify the Elasticsearch details in the **Provide Elasticsearch Credentials** window.
Because the Elasticsearch data is already replicated from the primary database, you do not have to provide the Elasticsearch password.
4. After the installation is complete, verify that the Control Room URL and repository path is available in the Control Room **Welcome** page.
You can change the Control Room URL and repository path after you log in to the Control Room as the next step.
5. Log in to the Control Room using your administrator credentials to change the **Configuration Settings** in **Administration > Settings**:
 - a) To allow users to access the Control Room using a public IP address, change the **Control Room Access URL** settings to point to the secondary site access URL in **General Settings > General**.
 - b) Change the **Repository path** to the secondary site repository path in **Control Room database and software > Control Room repository**.
6. Verify the data for the following:
 - Users, roles, schedule, triggers, credential information, and workload settings
 - Elasticsearch certificate and connectivity
 - Automation Anywhere Robotic Interface, Bot Insight, Discovery Bot, and IQ Bot

Recommendation: Perform a byte-by-byte measurement of the recovered data and compare the primary and secondary site data. If you see any difference, verify the subscriber logs for any intermittent failure due to any network issue.

After the recovery site is operating as the primary site, configure a replacement secondary site. Using the database tools, set up replication from the recovery primary site to the replacement secondary site.

Replicate data between primary and secondary sites

The process of replicating the data between the primary and the secondary site involves database replication using publisher and subscriber models in Microsoft SQL Server Management Studio, server

repository replication using Windows Distributed File System (DFS), and backing up Elasticsearch (audit log) data.

Before installing Automation 360, ensure that you have set up your secondary site.

Configure the database and shared repository in the secondary site that is used for disaster recovery. Back up your Elasticsearch data by setting up the backup cluster.

- 1. Replicate the database** from the primary site to the secondary site using the publisher and subscriber models in Microsoft SQL Server Management Studio.

Recommendations:

- Use the Microsoft SQL Server Developer or Enterprise edition for database replication.
The publisher and subscriber versions must be the same, or the gap between the two versions must not be more than two releases. For example, do not use Microsoft SQL Server 2012 publisher with Microsoft SQL Server 2019 subscriber.
- Configure the publisher and distributor on the same system to avoid latency in data sharing.
Use different systems only for load distribution, for example, for data larger than 200 GB.

-
- a) Connect to the primary database to create a snapshot publication for your local publications.
 - b) Add the tables and views as articles.
 - c) Use the snapshot agent option to create a snapshot and keep the snapshot available to initialize subscriptions.
 - d) Schedule the snapshot agent to back up the data at regular intervals (for example, every 10 seconds from 12 AM to 11:59:59 PM).
 - e) To select the account to run the snapshot agent, configure the security and agent settings.
 - f) Add a publication option.
 - g) Run all agent and distributors after ensuring that the publisher and database names are correct.
 - h) To add subscribers to the local subscriptions, connect to the database server and provide connection details for the database at the secondary site.

For detailed steps, see [Database Mirroring and Replication \(SQL Server\)](#).

- 2. Replicate the repository** (bots and data files) using the Windows DFS from the primary site to the secondary site.

- a) Open the DFS on the machine where the shared repository is saved.
- b) Create a new multipurpose replication group to add replication group members.
The group members include the source machine in the primary site and the destination machine in the secondary site to store the shared repository.
- c) Use the full mesh option for DFS replication groups composed of less than 10 servers.
- d) Use the full bandwidth option to replicate the data continuously.
- e) Add the machine where you are configuring the repository as a primary member.
- f) Add a backup folder for the shared repository from the destination machine.
- g) Verify that the data is replicated in the backup folder on the destination machine.

For detailed steps, see [Distributed File System Replication](#).

- 3. Back up the Elasticsearch (audit log) data** by adding the secondary site cluster IP address in the Control Room on the primary site.

For detailed steps, see [Configure disaster recovery site for Elasticsearch IP addresses](#).

Related tasks

[Warm stand-by](#)

Host two setups or sites - primary and backup for the warm stand-by DR procedure.

Installing Control Room using custom mode for Oracle installation

Install the Automation Anywhere Control Room using Oracle Database for On-Premises and complete the installation in the Control Room.

Ensure the following:

- Oracle Database is preconfigured in your environment before you complete the Control Room installation.
- Oracle 19c On-Premises or over AWS RDS Oracle is supported. Ensure that the following settings are enabled with version 19c:
 - The value of the Oracle instance `max_string_size` parameter is set to EXTENDED.
 - If you want to use the SSL/TLS connection for the database, it is required that you configure TLS on the Oracle Server.
 - Oracle credentials are created. Database credentials must be created and the following grants must be provided: CONNECT, RESOURCE, CREATE TABLE, CREATE VIEW.

Note: The QUOTA on tablespace USERS is UNLIMITED.

Note: External vault integration is not supported on Oracle-based Windows Control Room installation.

Procedure

1. Prepare for installation

- Verify [Automation 360 On-Premises prerequisites](#).
- Ensure that you have the following:
 - Automation Anywhere Control Room installation file
 - TLS certificate
 - License file

2. [Run Control Room installer](#).

Run the installer to verify the operating system and hardware requirements, select the deployment option, accept the licensing agreement, and select the installation file path.

Note: Ensure that you select Oracle for **Database type**.

3. [Configure application Transport Layer Security](#).

Use the **Transport Layer Security (TLS) configuration** page to generate a self-signed certificate or import a security certificate to set up a highly secure Control Room instance.

4. *Configure service credentials.*

Use the **Service Credentials** page to specify the account that will be used to run all Windows services that are created by the installer.

5. *Configure Oracle database type and server*

Use the **Database type** page to configure the Oracle Database for use with the Control Room.

6. *Add Elasticsearch credentials.*

Add Elasticsearch credentials for enhanced monitoring and alerting in the Control Room.

7. *Configure IP cluster.*

Use the **Cluster Configuration** page to configure resiliency requirements. Provide only one IP address to configure the Control Room on a single node. Provide multiple (three or more) IP addresses to configure the Control Room for high availability cluster.

8. *Review the installation summary.*

Use the **Ready to Install the Program** page to complete the installation wizard and monitor the installation progress.

9. Complete Control Room configuration and validation.

Complete Control Room post-installation configuration

After installing the Control Room, complete the configuration settings to ensure that timely Automation Anywhere communications are specified and confirm that Automation Anywhere services are running.

Post-installation user management

After completing the post-installation tasks, validate the setup by logging in to the Control Room and installing a license. First-time access to the Control Room walks you through the configuration for your authentication method.

10. *Prepare for users.*

As an administrator, you can create, view, edit, delete, and enable or disable a user. The steps for creating users can vary depending on whether the user is a non-Active Directory, Active Directory, or single sign-on (SSO) user from an IdP server.

Installing Control Room using Custom mode

Log in to the server as an administrator and install Automation Anywhere Control Room in Custom mode to select installation and configuration options, including installing non-default requirements. Select this mode for a data center deployment.

Linux users: See *Installing Control Room on Linux*.

Procedure

1. Prepare for installation

- Verify [Automation 360 On-Premises prerequisites](#).
- Ensure that you have the following:
 - Automation Anywhere Control Room installation file
 - TLS certificate
 - License file

2. [Run Control Room installer](#)

Run the installer to verify the operating system and hardware requirements, select the deployment option, accept the licensing agreement, and select the installation file path.

3. Select the database type that you want to use

- Microsoft SQL Server
- Oracle

4. Use the **External key vault integration** page to configure a connection to an external key vault such as CyberArk or AWS Secrets Manager, that is optionally used for retrieving credentials for either installation or runtime purposes. Configuring the key vault connection enables retrieval options for credentials during installation. Ensure that you have the follow information:

- All necessary database and user credentials.
- Any necessary credential requirements for the external key vault such as secret keys, application IDs. See the specific requirements for your external key vault on the External Key Vault integration configure page.

5. [Configure application Transport Layer Security](#)

Use the **Transport Layer Security (TLS) configuration** page to generate a self-signed certificate or import a security certificate to set up a highly secure Control Room instance.

6. [Configure service credentials](#)

Use the **Service Credentials** page to specify the account that will be used to run all Windows services that are created by the installer.

7. Configure database type and server

Use the **Database type** page to configure the Microsoft SQL Server database, or Oracle Database for use with the Control Room.

- [Configure Microsoft database type and server](#)
- [Configure Oracle database type and server](#)

8. [Add Elasticsearch credentials](#)

Add Elasticsearch credentials for enhanced monitoring and alerting in the Control Room.

9. [Configure IP cluster](#)

Use the **Cluster Configuration** page to configure resiliency requirements. Provide only one IP address to configure the Control Room on a single node. Provide multiple (three or more) IP addresses to configure the Control Room for high availability cluster.

10. Review the installation summary

Use the **Ready to Install the Program** page to complete the installation wizard and monitor the installation progress.

11. Complete Control Room configuration and validation*Complete Control Room post-installation configuration*

After installing the Control Room, complete the configuration settings to ensure timely Automation Anywhere communications are specified and confirm Automation Anywhere services are running.

Post-installation user management

After completing the post-installation tasks, validate the setup by logging in to the Control Room and installing a license. First-time access to the Control Room walks you through the configuration for your authentication method.

12. Prepare for users

As an administrator, you can create, view, edit, delete, and enable or disable a user. Creating users steps vary depending on whether the user is a non-Active Directory, Active Directory, or single sign-on (SSO) user from an IdP server.

Related concepts

[Migrate to Automation 360](#)

Run Control Room installer

Run the installer to verify the operating system and hardware requirements, select the deployment option, accept the licensing agreement, and select the installation file path.

To install Automation Anywhere Control Room in Custom Mode, follow these steps:

1. Start the installer wizard.
 - a) Extract all files from the Automation360_Build_<build-number>.zip file.
 - b) Right-click the Automation360.exe file and select **Run as administrator**.

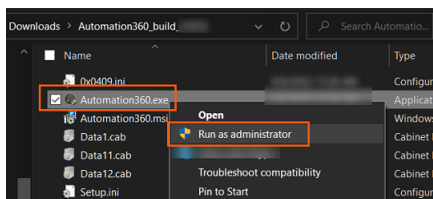

The installation process will create a Control Room database with the name Automation360-Database on your SQL database server instance.

However, if you are migrating from Enterprise 11 to Automation 360, the restored Enterprise 11 database will be used instead of the Automation 360 database.

Note: Ensure the SQL database server is installed on a different server than that of the Control Room.

The installation process checks for supported operating system and recommended hardware requirements. The following message appears if the requirements are not met:

This system does not meet all the installation prerequisites for Automation Anywhere Enterprise.

Some features might not work as expected after installation. For details, verify the Control Room Installation Prerequisite.

For more information, see [Automation 360 On-Premises prerequisites](#).

2. Select the **On-Premises** deployment type and click **Next**.

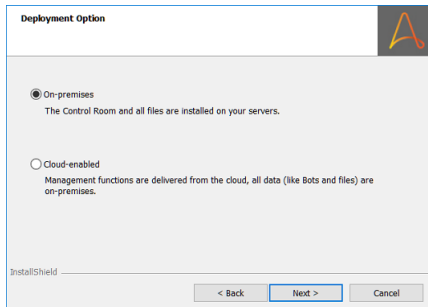

In On-Premises deployment type, the Control Room, Bots and files are installed on your servers.

In **Cloud-enabled** deployment type, all data such as bots and files are installed on your servers. The management functions of the Control Room are delivered through Cloud.

3. Accept the licensing agreement and click **Next**.
4. Select the **Custom** option and click **Next**.

The **Destination Folder** page appears. By default, the destination folder is C:\Program Files

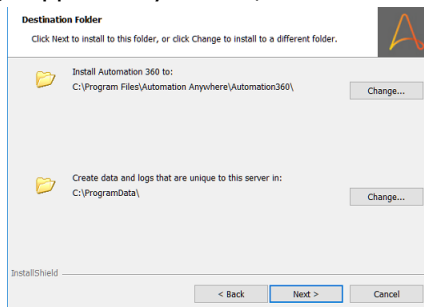

\Automation Anywhere\.

5. If you are upgrading from one Automation 360 version to another, confirm the upgrade and choose whether to use the existing installation parameters.

Existing installation parameters include, for example: the installation path, HTTPS ports, database names, IP addresses, and TLS configuration. The username and password have to be manually entered.

- **Yes**—all the installation parameters are pre-filled and disabled. You cannot change pre-filled fields.
- **No**—enter the same or different installation parameters through the installation prompts.

Note: Choose **No** if the previous installation did not use the default installation path C:\Program Files.

6. To make changes to the destination folder, click **Change**, enter a new destination folder name, and click **OK**.

Recommendation: **Do not** install the application directly in the root directory (C:\). You should create a folder, for example, C:\Program Files\Automation Anywhere\Automation360\.

7. Click **Next**.

Integrate external key vaults

You can integrate external key vaults to the Automation 360 On-Premises Control Room.

As part of your external key vault integration planning strategy, if you determined that you are using an Automation 360 On-Premises Control Room deployment (where the Control Room and external key vault are hosted at the customer's site and environment), then select from the following list of external key vaults to configure:

- CyberArk Password Vault – Customer On-Premises environment

[On-Premises integration using CyberArk Password Vault](#)

- Azure Key Vault – Customer Azure environment

[On-Premises integration using Azure Key Vault](#)

- AWS Secrets Manager – Customer AWS environment

[On-Premises integration using AWS Secrets Manager](#)

Configure application Transport Layer Security

Use the **Transport Layer Security (TLS) configuration** wizard page from the Automation 360 installer to generate a self-signed certificate or import a security certificate to set up a highly secure Control Room instance.

All Automation Anywhere components should be secured with TLS 1.2 encryption. Automation Anywhere leverages TLS 1.2 encryption for HTTPS and TCP communications between our components. The TLS certificates are installed on the Automation Anywhere Control Room and IQ Bot servers. The certificates are installed in .PFX format and leveraged for communications.

Note: If your load balancer uses HTTP to forward traffic to the Control Room, do not use the **Enable Force HTTP traffic to HTTPS** option. We recommend that you use HTTPS to forward the load balancer traffic for enhanced security instead.

1. In the **TLS Configuration** page, configure the following:

- **Generate a Self-Signed Certificate**

Enabling the **Self-Signed Certificate** option allows the installer to generate a unique private key and a self-signed certificate for the Control Room.

- **Import a Certificate**

To import a custom certificate, clear the **Self Signed Certificate** check box. This setting allows you to import a certificate using the **Certificate Path** field.

Note: The certificate file must be a PKCS12 format.

Provide the following information:

- **Certificate Path:** Click **Browse** to import the certificate.
 - **Private Key Password:** Enter the password for the private key.
-

Password limitation: Do not use the at sign (@) in passwords. Using the special character @ in the password causes the certificate file import to fail.

- **Webserver Port:** Enter the web server port – either HTTP or HTTPS. If the port is already assigned, an error message is displayed.
-



Attention: The port validation message is also displayed when you add 8080 for the web server and if that port is already in use for a Control Room license service. Use a different unassigned port in these cases.

- **Enable Force HTTP traffic to HTTPS:** This option redirects all HTTP port requests to HTTPS. To access to the Control Room through HTTPS using the generated self-signed certificate, ensure the port numbers are different for HTTP and HTTPS.

To generate a custom certificate for HTTPS, ensure your custom certificate meets the following:

- Create a `.pfx` certificate with a pass code from a CA trusted authority.
- Combine Root, Intermediate, and Machine level certificates into a single certificate.
- Use the format `[WS Machine Host Name].[DomainName].com` for the private key.
- Include the host name as a fully qualified domain name (FQDN) in the certificate.

You provide the host name during Control Room installation.

- In multi-node HA clusters, issue certificates to the load balancer DNS name.
- Add individual URLs, which require access to all nodes, to the `Subject Alternative Name` field in the certificate.

For more information, see Automation Anywhere support site: [Automation 360 On-Premises prerequisites \(A-People login required\)](#).

The following sample illustration shows options for importing a custom certificate:

TLS Configuration
Configuring the control room transport layer security configuration

Self Signed Certificate

Certificate Path:
C:\Users\elle.brown\Documents\certificates

Private Key Password:

HTTP Port: HTTPS Port:

Force HTTP Traffic To HTTPS

InstallShield

2. Click **Next** to configure service credentials.

Configure service credentials

Related tasks

[Configure Control Room for HTTPS certificate](#)

Configure Control Room for HTTPS mode using a self-signed or CA certificate either before or after performing a custom Control Room configuration.

[Import HTTPS and CA certificates](#)

After installing the Control Room, import a certificate for HTTPS, Certificate Authority (CA), or both using the Windows or Linux command prompt.

Configure service credentials

Continue from the Control Room installer to the **Service Credentials** wizard page. Use this page to specify the account that will be used to run all Windows services that are created by the Automation Anywhere installer.

1. In the **Service Credentials** screen, choose from the listed options.

The Windows Service credentials include a user name and password. The user specified must meet these requirements:

- Have permission to manage services, including Automation Anywhere services.
- If you use Windows authentication to connect to the SQL database, ensure you grant the `db_owner` permission to the service credential user.

These service credentials allow the Control Room processes to run the required services.

- **Local System Account**—(default) The logged-on user performing the installation.
 - **Use a Group Managed Service Account**—Specify to manage Automation 360 services.
 - a. Clear the **Local System Account** check box.
 - b. Select the **Use a Group Managed Service Account** option.
 - c. Enter the user name only. No password is required to use this option.

Group Managed Service Accounts Overview

Note: A gMSA user will be unable to run the Control Room services although this option works when the same gMSA user installs the Control Room using the gMSA account.

- **Domain Account**—Specify a user that is not the local system account user
 - a. Clear the **Local System Account** check box.
 - b. Enter the user name and password for the domain account.

Use only supported characters for the user name and password. See [Supported special characters](#).
 - **Do not use the Windows domain credentials**

Enter credentials valid for running Automation Anywhere services. Without the valid credentials, the Control Room will fail to launch.
 - **PowerShell script restrictions**

Specify a user with permissions to launch PowerShell scripts who is not a Windows domain user. Without the relevant permissions, database table creation can fail.
- **Service Account (manually enter credential)**
 - a. Enter username.
 - b. Enter password.
- **Service Account (optionally retrieve service account credential from the previously configured external key vault)**
 - a. If using CyberArk, enter the safe name and object name for the credential.

- b. If using AWS Secrets Manager, enter the secret name.
- c. If using Azure, enter the vault URL.

The following example shows selection of a domain account:

2. Click **Next**.

Configure Microsoft database type and server

Continue from the Control Room installer to the **Database type** wizard page. Use this page to configure the Microsoft SQL Server database for use with the Control Room.

This procedure applies only to Microsoft Windows Server based installations.

Linux users: See [Installing Enterprise Control Room on Linux - Database configuration](#).

If you are installing Automation 360 as part of migration, this task includes the step to select the Enterprise 11 (cloned) database.

1. Select the **Microsoft SQL Server** database.
An instance of the SQL Server should be already configured.
2. Click **Next**.
The **Database Server** page is displayed (if you selected **SQL Server** for configuring your database).

3. Set the connection and authentication for the database server.

To configure the **Database Server** for the Control Room instance, use the default **Database Server** port 1433. If multiple instances are running on the same database host on different ports, you can use the corresponding custom port for that instance (for example, 1435 or 1437).

Note: The instance name is not supported in the **Database Server** field.

Note:

- If possible, do not set the value for **Database Server** as **localhost**. If you must use **localhost**, note that the **Secure Connection** to the database will not work.
-
- Click **Browse** to select the SQL Server instance where the Control Room database will be created. Alternatively, enter a database server name or select one from the list.

Migration task: If you are migrating from Enterprise 11 to Automation 360, browse to the restored Enterprise 11 database.

Provide the following details:

- a) **Database Port:** Use the default port (1433) or specify a custom value.

Configure default database port

- b) **Use Secure Connection:** Select to use a CA certificate as specified.

Note: Use the same host name for certificate and database connections.

- c) **Certificate:** This option is enabled when you select **Use Secure Connection**. Browse to select a CA certificate.

Import HTTPS and CA certificates

- d) Select one of the following for database authentication:

- **Windows authentication:** This option is selected by default and allows connection to the SQL Server using Windows authentication.

Note: If you select Windows authentication, then the user running the installer is used to test that the database exists, create it if required, and grant `db_owner` to the service account user (NT Authority/System).

- **SQL Server authentication:** (manually enter credential) Select this option to use SQL Server authentication to connect to the database. Provide the correct user name and password for SQL authentication.

1. Enter username.
2. Enter password.

- **SQL Server authentication:** (retrieve credential from external key vault) Select this option to use SQL Server authentication to connect to the database.

Note: SQL Server Authentication is required if you will retrieve the credentials for the database from an external key vault.

1. If using CyberArk, enter the safe name and object name.
2. If using AWS Secrets Manager, enter the secret name.

- **AD Azure authentication:** Select this option to use Microsoft Azure Active Directory credentials to connect to the database when you install the Control Room on Microsoft Azure.

Use only supported characters for the user name and password. See [Supported special characters](#). Do not use semicolons (;) in the database password.

- e) **Name of Control Room database:** Enter the name of the Control Room database.

Migration task: If you are migrating from Enterprise 11 to Automation 360, enter the name of the restored database in the database field as shown in the following image:

The screenshot shows the 'Database Server' configuration window. The 'Database Server' dropdown is set to '(local)\SQLEXPRESS' and the 'Database Port' is 1433. The 'Use Secure Connection' checkbox is checked. Under 'Certificate (Optional)', there is a 'Browse...' button. The 'Authentication' section has three radio buttons: 'Windows authentication' (selected), 'Sql Server authentication', and 'AD Azure authentication'. Below these are fields for 'Login ID:' and 'Password:'. The 'Name of Control Room database:' field contains the text 'Restored-11.x-Database', which is highlighted with a red box. At the bottom, there are '< Back', 'Next >', and 'Cancel' buttons.

The following sample illustration shows SQL Server authentication for database

The screenshot shows the 'Database Server' configuration window. The 'Database Server' dropdown is set to '(local)\SQLEXPRESS' and the 'Database Port' is 1433. The 'Use Secure Connection' checkbox is checked. Under 'Certificate (Optional)', there is a 'Browse...' button. The 'Authentication' section has three radio buttons: 'Windows authentication', 'Sql Server authentication' (selected), and 'AD Azure authentication'. Below these are fields for 'Login ID:' (containing 'jsa') and 'Password:' (containing masked characters). The 'Name of Control Room database:' field contains the text 'Automation360-Database'. At the bottom, there are '< Back', 'Next >', and 'Cancel' buttons.

connection:

4. Click **Next** to provide the Elasticsearch credentials.

[Add Elasticsearch credentials](#)

Configure default database port

Configure and enable the TCP/IP in the SQL database server to use the default port 1433 when you install the Control Room.

Enable TCP/IP from the Microsoft SQL Server Configuration Manager.

1. Ensure the SQL Server Browser service is running in the Task Manager.
2. To set the default port for the SQL database server, launch the Microsoft SQL Server Configuration Manager.
3. Select **SQL Server Network Configuration > Protocols for <SQL server instance>**.
4. Right-click **Protocols for <SQL server instance>** and select **Open** to show the available protocols.
5. Ensure **TCP/IP** is enabled.
6. Right-click **TCP/IP** and select **Properties**.
You can configure the default port for the SQL database from the **TCP/IP Properties** window that is displayed.
7. Select the **IP Addresses** tab to update the default **TCP Port** to **1433** in the **IPAll** node.
If provided, clear the value shown in the **TCP Dynamic Ports** field.
8. Click **OK** to confirm and exit the window.
9. Select the **SQL Server Services** option to **Restart** the **SQL Server <instance name>**.

The SQL database server is now configured and enabled to use the default port in the Control Room.

Configure Oracle database type and server

Configure the Oracle Database Server for use with the Control Room by using the Database type wizard page.

This procedure applies only to installations based on Microsoft Windows Server.

Oracle must be installed on a machine that is accessible from the Automation 360 Control Room.

Create users for Automation Anywhere to access the Database.

This is supported only on non-container Database. Oracle installation is supported only for first-time setup of Automation Anywhere. Oracle installation does not support updates.

Note: Oracle database for Control Room installation is supported only in Custom mode and not in Express mode.

1. Select **Oracle** database.

An instance of the Oracle Server must be configured already. For more information, see [Installing Control Room using custom mode for Oracle installation](#).

2. Click **Next**.

The Oracle Database server page is displayed (if you selected Oracle for configuring your database).

The following sample illustration shows Oracle Database Server authentication for database connection:

3. Set the connection and authentication for the database server. Provide the following details:

- Database Server:** Enter the server name or IP address of the Oracle Database server. The **localhost** IP address can be used.
- Database Port:** Enter your database server port number. The default port is 1521.
- For the connection, select one of the following options and enter the name of your Oracle instance in the text field:

Option	Action in text field (example)
SID	ORCL
Service name	ORCLPDB

Note: The SID and service name entered in the text field provided is unique to your Oracle database. The Oracle instance name entered in the text field is not case-sensitive.

4. In the **Username** field, enter your Oracle database user or schema name.
5. In the **Password** field, enter the password for the user or schema name.
6. **Use Secure Connection:** Select to use a CA certificate as specified.

Note: Use the same host name for certificate and database connections.

7. **Certificate:** This option is enabled when you select **Use Secure Connection**. Browse to select a CA certificate.

Import HTTPS and CA certificates

8. Click **Next**.

The database connection begins validating for the database server and the elastic search.

9. Enter the Elasticsearch credentials in the fields provided.

Add Elasticsearch credentials

Add Elasticsearch credentials

When installing Automation 360, add Elasticsearch credentials for enhanced security.

Based on whether you are performing a new installation, running the setup for the first time to upgrade to a later version, or a subsequent re-installation, the options to add the Elasticsearch credentials or select a backup Elasticsearch server are enabled.

1. In the **Provide Elasticsearch Credentials** window, enter the credentials for Elasticsearch in the **Elasticsearch password** field.

Important: Ensure the following for your Elasticsearch authentication password:

- The password cannot include a space, semicolon (;), percent (%), or backslash (\).
 - The first character cannot be a minus sign (-) or forward slash (/).
 - Include at least one alphabetical character.
-

This option is enabled only for the primary node of the cluster when you run the setup for the first time for an upgrade or a new installation of the Control Room. When you enter the password, self-signed certificates are generated for encrypting the data traffic for inter-node and client communication.

The option is disabled for subsequent installations because the password and certificates are retrieved and reused from the second node onwards.

2. Repeat the credentials in the **Confirm Elasticsearch password** field.

3. Select the **Check only if installing on the first node of the backup Elasticsearch cluster** check box when you want to install the Control Room on the primary node that will be used as a backup for the Elasticsearch cluster.

This option is available only if you have provided the Elasticsearch credentials for the primary node during a previous installation. The option enables you to use the database backup that is created from the Elasticsearch settings table after the primary node of the cluster is installed.

The option is disabled for subsequent installations.

4. Click **Next** to configure the IP cluster.

If you encounter errors when performing this task, see these resources:

- Error on storing Elasticsearch certificate to database, see [Installation error storing Elasticsearch certificate to database \(A-People login required\)](#).
- Error restarting the Automation Anywhere Elastic Search Service, see [Automation 360 v.16 upgrade error: Elasticsearch Service fail to start during certificate retrieval process \(A-People login required\)](#).

Configure IP cluster.

Configure IP cluster

Continue from the Control Room installer to the **Cluster Configuration** wizard page to configure resiliency requirements for the Control Room. Provide only one IP address to configure the Control Room on a single node. Provide multiple (three or more) IP addresses to configure the Control Room for high availability cluster.

To install the Control Room in cluster mode:

- Ensure you have configured the default/custom and configurable firewall, port, and protocol requirements for Automation 360 deployment.
- Ensure the network location (UNC) path is configured to access the repository files from all Control Room nodes in the cluster.

You can configure Network Attached Storage (NAS) file sharing using Server Message Block (SMB) protocol.

- Ensure that all nodes that will be configured for the IP cluster are available for configuration before the installation. Also, provide the same list of IP addresses in the same order in all the nodes that are of the cluster when you install Control Room in these nodes.
- Ensure the existing cluster is in yellow or green state and all ports on the new node are open before adding a new node.

- Ensure to sign all the PowerShell files if the machine on which you are installing Automation 360 has MachinePolicy as AllSigned or UnRestricted. To view the MachinePolicy on your machine, run the following command in PowerShell:

```
Get-ExecutionPolicy -List
```

You can find the following PowerShell files in the temp folder:

- servicecredsvalidate
- getsysip
- getfileprodversion
- ecertprocess
- createstoragetables
- createpddtables
- createiqbottables
- createcrdbtables
- createaaridbtables

Example of a temp folder path C:\Users\ADMINI~1\FD\AppData\Local\Temp\<GUID>. Note that the GUID is generated dynamically for each installer session.

Remember: Before you upgrade from a previous version, shut down the nodes gradually, and not at the same time, to ensure that the cluster does not fail.

1. Select the **Enable Cluster Setup** check box.

- To install the Control Room on a single node and not a cluster, clear the **Enable Cluster Setup** check box.
- The check box is enabled by default if the machine on which the setup is being run has local IP addresses configured.
- The check box is not available for selection if your MachinePolicy is set to AllSigned or UnRestricted and the PowerShell files are not signed.

2. If the nodes in your network use IPv6 address, select the **IPv6** check box.

3. Enter the IP addresses of the nodes in the cluster.

- a) Use a comma (,) to specify more than one IP address.
For example, to specify three IP addresses in the cluster, enter:
192.0.2.1,192.0.2.2,192.0.2.3

Important: The first IP address in the list is used as the master node. Ensure that you enter the IP addresses in the same order on all node configurations in subsequent installations. An incorrect order causes the application to configure the IP addresses as separate clusters, which will result in data loss when the issue is fixed after installation.

You can install multiple nodes at the same time after the master node is initially installed.

After installation, you can add a new IP address to the cluster at the end of the list. However, you cannot change the IP address version (for example from IPv4 to IPv6).

- b) After you enter the cluster IP addresses correctly, select a valid address IP at the message prompt to provide network access to the machine.

4. Select a private IP address from the **Local IP Address** drop-down list.

If multiple local IP addresses are configured on the machine, select the IP address on which the Control Room is installed because it will be used by other nodes to access the Control

The screenshot shows a 'Cluster Configuration' window with the following details:

- Cluster Configuration**: Provide system IP addresses for the cluster.
- Enable Cluster Setup. A local IP address is required to complete cluster setup.
- IPv6
- Cluster IP addresses:** 192.0.2.1,192.0.2.2,192.0.2.3
- Separate list of IP(s) with comma. Nodes must be installed in the order listed. The same list must be entered exactly on the other nodes. Not following this will result in installation failure.
- Local IP address:** A dropdown menu with '192.0.2.1' selected. A red box highlights this dropdown.
- Please open the Local IP dropdown menu to select an IP address configured on this machine that other Control Room installers should use when connecting to this Control Room.
- Buttons: < Back, Next >, Cancel

Room.

5. Click **Next** to complete the Control Room installation process.

Optionally see the [Setup installation summary](#) page.

Related concepts

[High availability deployment](#)

To support Automation 360 in your data center, configure an high availability (HA) cluster. Follow your company methods and procedures for implementing your data center cluster.

Related tasks

[Configure application Transport Layer Security](#)

Use the **Transport Layer Security (TLS) configuration** wizard page from the Automation 360 installer to generate a self-signed certificate or import a security certificate to set up a highly secure Control Room instance.

Related reference

[Control Room repository requirements](#)

The repository location is configured in the Control Room after installation. All your automations are stored in this repository.

[Ports, protocols, and firewall requirements](#)

View the default and configurable firewall, port, and protocol requirements for Automation Anywhere deployment. View the default ports and protocols that are required to be allowed on customer's firewall for Automation Anywhere deployment. The default ports that are used for HTTP/HTTPS are configurable.

Add nodes to a cluster setup

As an RPA platform administrator, you can add nodes to a cluster for better performance and better load distribution.

Ensure the following:

- Verify whether the prerequisites for on-premises installation are met.
 - [Automation 360 On-Premises prerequisites](#)
- Verify that all the primary nodes and databases have backups.
- You must have the IP addresses of all the cluster members for the Control Room server network interfaces used for Elasticsearch communications.

Note: The Control Room servers can have multiple network interfaces. The server IP addresses must be statically assigned and cannot use the Dynamic Host Configuration Protocol (DHCP).

- If any external load balancers are used in the environment, update them with IP addresses from the new server nodes.
- Ensure that you have administrator or root privileges on the Control Room servers. You must be familiar with installing Control Room in custom mode and also with the related configuration settings.

Adding nodes to a cluster helps you to upgrade the configuration of the nodes in a cluster. You can add nodes to a Control Room cluster setup, change the IP addresses of nodes in the cluster, and monitor the health of the underlying cluster services.

Note: The minimal number of nodes supported within a Control Room cluster is three. The nodes in a cluster synchronize with each other over a local network. All the nodes in a cluster connect to the same database.

Perform the following steps to add three nodes (N4, N5, and N6) to a cluster that has three nodes (N1, N2, and N3).

1. On node N4, log in to the operating system as an administrator and run the Control Room installer.
2. Proceed through the installer to the cluster configuration.
 - a) Select **Enable Cluster Setup**.
 - b) In the **Cluster IP addresses** box, enter the IP addresses of all the nodes that you need to configure in the cluster.

172.31.30.120, 172.31.21.216, 172.31.17.110, 172.31.20.242, 172.31.17.149,
172.31.18.37

Note: The IP addresses must be entered in the same sequence on every node.

3. Restart the nodes, one at a time.
After you restart the nodes, each node will have six IP addresses.
4. Complete the remaining steps to install Control Room.
Installing Control Room On-Premises
5. Repeat the steps 1 through 4 for nodes N5 and N6.
6. To verify the health of the cluster, use the Elasticsearch API through a browser or API tool.
 - a) From a browser, navigate to the IP address of any node in the cluster by using the Elasticsearch port 47599 and use the `_cat/nodes` API.
`https://172.31.30.120:47599/_cat/nodes`
The master node is indicated by an asterisk character (*).
 - b) Verify that the IP address of the master node is the same as the one mentioned in the **elasticsearch.yml** file for all the nodes.
 - c) From a browser, navigate to the IP address of any node in the cluster by using the Elasticsearch port 47599 and use the `_cat/health?pretty` API.
`https://172.31.30.120:47599/_cat/health?pretty`

You must wait until the replication status turns **green**. The replication time varies depending on the data load in the clusters. The replication status turns green when the cluster is fully synchronized.

Remove nodes from a cluster setup

As an RPA platform administrator, you can remove nodes from a Control Room cluster setup to replace them or upgrade them for enhanced performance.

Ensure the following:

- Verify that all the primary nodes and databases have backups.
- Ensure that you have administrator or root privileges on the Control Room servers.

Perform the following steps to remove three nodes (N1, N2, and N3) from a cluster that has six nodes (N1, N2, N3, N4, N5, and N6).

1. Verify the master node. Use the following Elasticsearch API through a browser or API tool to identify the master node:

```
https://172.31.18.37/_cat/nodes
```

2. Log in to the server as an administrator and stop all the Control Room services by running the following command:

```
services.msc
```

Log in to any of the original nodes N2 or N3 and not the master node N1.

3. Similarly, stop all the Control Room services for the master node N1.
4. Before removing the nodes, verify the health of the cluster by using the following Elasticsearch API through a browser or API tool:

From a browser, navigate to the IP address of any node in the cluster by using the Elasticsearch port 47599 and use the `_cat/nodes` API.

```
https://172.31.18.37/_cat/nodes
```

Note: The master node is indicated by an asterisk character (*).

5. Edit the `cluster.properties` file located at `C:\Program Files\Automation Anywhere\Automation 360\config`.
6. Remove the IP addresses for the original three nodes from the **cluster.properties** attribute.

Note: Perform this action for all the nodes in the cluster. When you remove the IP addresses of the original three nodes, do not change their sequence.

7. Edit the `elasticsearch.yml` file at `C:\Program Files\Automation Anywhere\Automation 360\elasticsearch\config`.
8. Remove the IP addresses for the original three nodes from the **discovery.zen.ping.unicast.hosts** attribute.

Note: The `discovery.zen.ping.unicast.hosts` attribute must contain the IP addresses only for the new nodes and in the same sequence within the file on each node.

9. To verify the new master node, use the following Elasticsearch API through a browser or API tool:

```
https://172.31.18.37/_cat/nodes
```

10. Update the IP address of the new master node in the **cluster.initial_master_nodes** attribute.
11. Run the following command to start the services on each node:

```
services.msc
```

You must start the services on the master node at the end.

12. To verify the health of the cluster, use the Elasticsearch API through a browser or API tool.

- a) From a browser, navigate to the IP address of any node in the cluster by using the Elasticsearch port 47599 and use the `_cat/nodes` API.
`https://172.31.30.120:47599/_cat/nodes`

Note: The master node is indicated by the asterisk character (*).

- b) From a browser, navigate to the IP address of any node in the cluster by using the Elasticsearch port 47599 and use the `_cat/health?pretty` API.
`https://172.31.30.120:47599/_cat/health?pretty`

You must wait until the replication status turns **green**. The replication time varies depending on the amount of data in the clusters. The replication status turns green when the cluster is fully synchronized.

Setup installation summary

Continue from the Control Room installer to the **Ready to Install the Program** wizard page. From this stage of the installation wizard, you finish the installation wizard and monitor the installation progress.

1. Click **Next**.

The **Ready to Install the Program** screen appears.

2. Click **Install** and allow the installation process to complete.

The **InstallShield Wizard Completed** screen appears.

3. Click **Finish**.

Launch Automation Anywhere is enabled by default.

Enable **Show installer settings** to open the `aae-installsummary.html` file. By default, this is located at `C:\Program Files\Automation Anywhere\Enterprise\`. Use this file to view a summary of the installation.

Complete the Control Room configuration and validation.

- [Complete Control Room post-installation configuration](#)

After installing the Control Room, complete the configuration settings to ensure timely Automation Anywhere communications are specified and confirm Automation Anywhere services are running.

- [Post-installation user management](#)

After completing the post-installation tasks, validate the setup by logging in to the Control Room and installing a license. First time access to the Control Room walks you through the configuration for your authentication method.

- [Users](#)

As a Cloud user with administrator permissions, you can create, view, edit, delete, and enable or disable a user. Creating users steps vary depending on whether the user is a non-Active Directory, Active Directory, or single sign-on (SSO) user from an IdP server.

Related tasks

[Installing Control Room using Express mode](#)

Installing Control Room using Express mode

Log in to the servers as an Administrator and install Automation Anywhere Control Room in Express Mode using the default settings.

Linux users: See [Installing Control Room on Linux](#).

- Verify [Automation 360 On-Premises prerequisites](#).
- Ensure that you have the following:
 - Automation Anywhere Control Room installation file
 - TLS certificate
 - License file



Attention: This installation mode is ideal for demo and training purposes. This installation mode is **not recommended** for the production environment.

The Express Mode installation quickly sets up the Control Room with default parameters for the various components.

Default parameters

Microsoft SQL Server is the default database for Control Room.

The following parameters are installed by default:

Parameter	Default value
SQL database instance	SQLEXPRESS
Authentication type	Windows authentication
Control Room database	Automation360-Database
Port	1433

To install Automation Anywhere Control Room in Express Mode, follow these steps:

1. Log in to the installation server.
2. Start the installer wizard.
 - a) Extract all files from the `Automation360_Build_<build-number>.zip` file.
 - b) Right-click the `Automation360.exe` file and select **Run as administrator**.

The installation process creates the Control Room database with the name Automation360-Database on your SQL database server instance.

Note: Ensure the SQL database server is installed on a different server than that of the Control Room.

The installation process checks for supported operating system and recommended hardware requirements. The following message appears if the requirements are not met:

```
This system does not meet all the installation prerequisites for Automation
Anywhere Enterprise.
Some features might not work as expected after installation. For details,
verify the Control Room Installation Prerequisite.
```

For more information, see [Automation 360 On-Premises prerequisites](#).

3. Click **Next** on the **Welcome to the Setup Wizard** page.
4. Select one of the following deployment types and click **Next**:

Deployment type	Description
On-Premises	The Control Room, Bots and files are installed on your servers.
Cloud-enabled	All data such as bots and files are installed on your servers. The management functions of the Control Room are delivered through Cloud.

5. Accept the licensing agreement and click **Next**.
6. On the **Installation Type** page, select the **Express** option and click **Next**.

The **Database Server** configuration page appears.

- a) Enter the port you want to use to connect to the database server in the **Port** field.
The default port is 1433. The installer uses the first available port and checks the availability of each consecutive port.
- b) Select any one of the following options to connect to the database server.

Option	Action
Use Windows Authentication	The system uses your Windows credentials. The Login ID and Password fields are disabled in the installer.
Sql Server authentication	Enter the Login ID and Password used for connecting to the database server.
AD Azure authentication	Enter the Login ID and Password used for connecting to the database server. Select this option to use Microsoft Azure Active Directory credentials to connect to the database when you install the Control Room on Microsoft Azure.

Note: The user who connects to the database server must have database creator privileges.

- c) Enter the name of the database that you want to use for Control Room in the **Name of Control Room** database field.
7. Click **Next** on **Provide Elasticsearch credentials** page to configure Elasticsearch for enhanced monitoring and alerting in the Control Room.

Important: Ensure the following for your Elasticsearch authentication password:

- The password cannot include a space, semicolon (;), percent (%), or backslash (\).
 - The first character cannot be a minus sign (-) or forward slash (/).
 - Include at least one alphabetical character.
-

This option is enabled only for the primary node of the cluster when you run the setup for the first time for a new installation or an upgrade of the Control Room. When you enter the password,

self-signed certificates are generated for encrypting the data traffic for inter-node and client communication.

The option is disabled for subsequent installations because the password and certificates are retrieved and reused from the second node onwards.

8. Optional: When you want to install the Control Room on the primary node that will be used as a backup for the Elasticsearch cluster, select the **Check only if installing on the first node of the backup Elasticsearch cluster** check box.

This option is available only if you have provided the Elasticsearch credentials for the primary node during a previous installation. The option enables you to use the database backup that is created from the Elasticsearch settings table after the primary node of the cluster is installed.

The option is disabled for subsequent installations.

9. Click **Next**.

10. On the **Ready to Install the Program**, click **Install** and allow the installation process to complete. During this process, the Automation 360 services are started automatically.

11. On the **InstallShield Wizard Completed** page, click **Finish**.

Launch Automation 360 is enabled by default.

Enable **Show installer settings** to open the `aae-installsummary.html` file. By default, this is located at `C:\Program Files\Automation Anywhere`. Use this file to view a summary of the installation.

The Control Room launches in your default browser with the **Configure Control Room settings** page displayed. Proceed to [Complete Control Room post-installation configuration](#).

Related concepts

[Installing Control Room using Custom mode](#)

Log in to the server as an administrator and install Automation Anywhere Control Room in Custom mode to select installation and configuration options, including installing non-default requirements. Select this mode for a data center deployment.

Installing Control Room on Amazon Web Services

Log in to an Amazon Web Services (AWS) server instance as Administrator. Then, download and start the Control Room installer and select **Custom** mode.

Note:

- Many possible system configurations and requirements exist. These installation steps do not account for all those possibilities, so your specific setup and installation steps will vary, and Automation Anywhere does not make any warranties that these steps conform to your specific configurations.
- For Automation 360 to work properly on Amazon Workspace, update the registry on all Workspace machines. For details, see [Device compatibility](#).

Step 1: Prepare for installation

- Verify [Automation 360 On-Premises prerequisites](#).
- Ensure that you have the following:
 - Automation Anywhere Control Room installation file
 - TLS certificate
 - License file

Step 2: *Prepare for installation on Amazon Web Services*

Use these steps to prepare the Amazon Web Services (AWS) instances for the Control Room installation.

Step 3: *Customize Control Room installation on Amazon Web Services*

Install and apply the customized configuration required for the Control Room cluster on Amazon Web Services (AWS) after completing initial preparations.

Step 4: Complete Control Room configuration and validation.*Complete Control Room post-installation configuration*

After installing the Control Room, complete the configuration settings to ensure timely Automation Anywhere communications are specified and confirm Automation Anywhere services are running.

Post-installation user management

After completing the post-installation tasks, validate the setup by logging in to the Control Room and installing a license. First time access to the Control Room walks you through the configuration for your authentication method.

Step 5: Prepare for users.*Users*

As a Cloud user with administrator permissions, you can create, view, edit, delete, and enable or disable a user. Creating users steps vary depending on whether the user is a non-Active Directory, Active Directory, or single sign-on (SSO) user from an IdP server.

Prepare for installation on Amazon Web Services

Use these steps to prepare the Amazon Web Services (AWS) instances for the Control Room installation.

If you have not done so already, prepare your AWS Identity and Access Management (IAM) user account to login to the AWS Console.

Do the following:

1. Create AWS Elastic Compute Cloud (EC2) Instances for the Control Room Servers.
2. If you use RDS, create Relational Database Service (RDS) Instances for the SQL Server Enterprise 2014 Database server.

3. Configure the AWS Load Balancer.

Note: There are many possible system configurations and requirements. These installation steps do not account for all those possibilities so your specific setup and installation steps will vary and Automation Anywhere does not make any warranties that these steps conform with your specific configurations.

To prepare AWS instances, do the following:

1. Set up the *Microsoft SQL Server* on Amazon Web Services Elastic Compute Cloud (AWS EC2) or Relational Database Service (RDS).
AAE supports both. For a comparison of the two, see *Microsoft SQL Server on AWS*.
2. Test the database connection with the Microsoft SQL Server.
 - a) Install Microsoft SQL Management Studio on one of the AWS EC2 instances inside the Virtual Private Cloud (VPC).
For more information, see *Download SQL Server Management Studio*.
 - b) Connect to the Microsoft SQL Server.
For configuration information, see *Working with SQL Servers*.
 - c) (Skip this step if the master database user installs the Control Room). Create the following empty database and assign `db_owner` privileges to the master database user for the Automation360-Database.
3. Set up the shared repository.
 - a) Create an AWS EC2 instance as a Windows File Server with an additional volume of 100 GB.
 - b) Join the Active Directory domain.
 - c) Create a folder and set up the permissions for the repository.
Assign the Control Room admin full access to this folder.



Attention: Only the Control Room admin is to have full access to this folder because this is the account from which all Control Room services run.

4. Launch three AWS instances, one for each Control Room server.
 - a) Establish three AWS instances, each with the following configuration:
 - Type: c5.2xlarge or similar instance type (8 CPU, 16 GB RAM)
 - Storage: Root Device: 100 GB
 - Storage: Additional Device: D:\ 200 GB (For Automation Anywhere Install files)
 - Accidental Deletion Prevention: Enabled
 - b) Access the three instances through Remote Desktop Protocol.
 - c) Add the instances to the Active Directory domain.
 - d) For each instance, add the Control Room system admin as a local administrator on the computer and reboot the system.
5. Configure the firewall and port.
See *Ports, protocols, and firewall requirements*.

6. Set up the AWS Application Load Balancer.
See [Details for Elastic Load Balancing Products](#).
 - Disable the stickiness attribute.
 - Set the idle time-out to 120 seconds.
7. Upload the SSL certificate to the Load Balancer.

Continue with [Customize Control Room installation on Amazon Web Services](#).

Customize Control Room installation on Amazon Web Services

Install and apply the customized configuration required for the Control Room cluster on Amazon Web Services (AWS) after completing initial preparations.

If you have not done so already, complete the initial installation steps in [Prepare for installation on Amazon Web Services](#).

Note: There are many possible system configurations and requirements. These installation steps do not account for all those possibilities so your specific setup and installation steps will vary and Automation Anywhere does not make any warranties that these steps conform with your specific configurations.

To install the Control Room in a cluster setup, do the following steps:

1. Login to the first AWS instance as an Administrator.
2. Download `Automation Anywhere_<version>.exe`.
3. Click **Next** on the **Welcome to the Setup Wizard** page.
4. Accept the licensing agreement and click **Next**.
5. Select the **Custom** option and click **Next**.
The **Destination Folder** page appears. By default, the destination folder is `C:\Program Files\Automation Anywhere\Enterprise\`.
6. To make changes to the destination folder, click **Change**, enter a new destination folder name, and click **OK**.

Recommendation: Do not install the application directly in the root directory (`C:\`). You should create a folder, for example, `C:\Program Files\Automation Anywhere\Enterprise\`.

7. Click **Next** to configure the IP cluster.
8. Select the **Enable Cluster Setup** check box.
The check box is enabled by default if the machine on which the setup is being run has local IP addresses configured.
To install the Control Room on a single node and not a cluster, clear the **Enable Cluster Setup** check box.
9. Enter the IP addresses of the nodes in the cluster.
 - Enter IPv6 addresses if all the nodes in the network are using IPv6.
 - Enter IPv4 addresses if some nodes in the network are using a combination of IPv4 and IPv6 addresses.

- a) Use a comma (,) to specify more than one IP address.
For example, to specify three IP addresses in the cluster, enter:
`192.0.2.1,192.0.2.2,192.0.2.3`

Important: The first IP address in the list is used as the master node. Ensure that you enter the IP addresses in the same order on all node configurations in subsequent installations. An incorrect

order causes the application to configure the IP addresses as separate clusters, which will result in data loss when the issue is fixed after installation.

You can install multiple nodes at the same time after the master node is initially installed.

After installation, you can add a new IP address to the cluster at the end of the list.

- b) After you enter the cluster IP addresses correctly, select a valid address IP at the message prompt to provide network access to the machine.

10. Click **Next** to configure the application Transport Layer Security (TLS).

11. In the **TLS Configuration** page, configure the following:

- **Generate a Self-Signed Certificate**

Enabling the **Self-Signed Certificate** option allows the installer to generate a unique private key and a self-signed certificate for the Control Room.

- **Import a Certificate**

To import a custom certificate, clear the **Self Signed Certificate** check box. This setting allows you to import a certificate using the **Certificate Path** field.

Note: The certificate file must be a PKCS12 format.

Provide the following information:

- **Certificate Path:** Click **Browse** to import the certificate.
- **Private Key Password:** Enter the password for the private key.

Password limitation: Do not use the at sign (@) in passwords. Using the special character @ in the password causes the certificate file import to fail.

- **Webserver Port:** Enter the web server port – either HTTP or HTTPS. If the port is already assigned, an error message is displayed.



Attention: The port validation message is also displayed when you add 8080 for the web server and if that port is already in use for a Control Room license service. Use a different unassigned port in these cases.

- **Enable Force HTTP traffic to HTTPS:** This option redirects all HTTP port requests to HTTPS. To access to the Control Room through HTTPS using the generated self-signed certificate, ensure the port numbers are different for HTTP and HTTPS.

To generate a custom certificate for HTTPS, ensure your custom certificate meets the following:

- Create a `.pfx` certificate with a pass code from a CA trusted authority.
- Combine Root, Intermediate, and Machine level certificates into a single certificate.
- Use the format `[WS Machine Host Name].[DomainName].com` for the private key.
- Include the host name as a fully qualified domain name (FQDN) in the certificate.

You provide the host name during Control Room installation.

- In multi-node HA clusters, issue certificates to the load balancer DNS name.
- Add individual URLs, which require access to all nodes, to the `Subject Alternative Name` field in the certificate.

For more information, see Automation Anywhere support site: [Automation 360 On-Premises prerequisites \(A-People login required\)](#).

12. Click **Next** to configure the service credentials.

13. In the **Service Credentials** screen, choose from the listed options.

The Windows Service credentials include a user name and password. The user specified must meet these requirements:

- A member of the local system administrator group.
- Have permission to manage services, including Automation Anywhere services.
- If you use Windows authentication to connect to the SQL database, ensure you grant the `db_owner` permission to the service credential user.

These service credentials allow the Control Room processes to run the required services.

- **Local System Account**—(default) The logged-on user performing the installation
- **Domain Account**—Specify a user that is not the local system account user
 - a. Clear the **Local System Account** check box.
 - b. Enter the user name and password for the domain account.

Use only supported characters for the user name and password. See [Supported special characters](#).
- **Do not use the Windows domain credentials**

Enter credentials valid for running Automation Anywhere services. Without the valid credentials, the Control Room will fail to launch.
- **PowerShell script restrictions**

Specify a user with permissions to launch PowerShell scripts who is not a Windows domain user. Without the relevant permissions, database table creation can fail.

14. Add the SQL Server and click **Next**.

Select **Microsoft SQL Server**, type the **Name**, and click **Next**.

15. On the **InstallShield Wizard Completed** page, click **Finish**.

Launch Automation Anywhere is enabled by default.

Enable **Show installer settings** to open the `aae-installsummary.html` file. By default, this is located at `C:\Program Files\Automation Anywhere\Enterprise\`. Use this file to view a summary of the installation.

The Control Room launches in your default browser with the Configure Control Room settings page shown. Continue with [Configure settings post-installation on Amazon Web Services](#).

Configure settings post-installation on Amazon Web Services

After installation is complete, configure Control Room settings on Amazon Web Services.

If you have not done so already, complete the installation steps in [Customize Control Room installation on Amazon Web Services](#).

Note: There are many possible system configurations and requirements. These installation steps do not account for all those possibilities so your specific setup and installation steps will vary and Automation Anywhere does not make any warranties that these steps conform with your specific configurations.

To install Automation Anywhere on Amazon Web Services (AWS), do the following steps:

1. Configure the following Control Room settings:
 - a) Specify the host name URL by providing the AWS Load Balancer URL.
This is the URL that users use to access your installation of Control Room.
 - b) Select the Active Directory authentication type. For more information, see [Configure Control Room for Active Directory: manual mode](#).
2. After you configure the Control Room, install product licenses.
3. Test Control Room access using the AWS Load Balancer URL.
This completes the Control Room installation on AWS.

Complete the Control Room configuration and validation.

- [Complete Control Room post-installation configuration](#)
After installing the Control Room, complete the configuration settings to ensure timely Automation Anywhere communications are specified and confirm Automation Anywhere services are running.
- [Post-installation user management](#)
After completing the post-installation tasks, validate the setup by logging in to the Control Room and installing a license. First time access to the Control Room walks you through the configuration for your authentication method.
- [Users](#)
As a Cloud user with administrator permissions, you can create, view, edit, delete, and enable or disable a user. Creating users steps vary depending on whether the user is a non-Active Directory, Active Directory, or single sign-on (SSO) user from an IdP server.

Installing Control Room on Microsoft Azure

Installing Control Room on Microsoft Azure begins in the Azure environment and ends with configurations in the Control Room.

Note: There are many possible system configurations and requirements. These installation steps do not account for all those possibilities so your specific setup and installation steps will vary and Automation Anywhere does not make any warranties that these steps conform with your specific configurations.

Step 1: Prepare for installation.

- Verify [Automation 360 On-Premises prerequisites](#).
- Ensure that you have the following:
 - Automation Anywhere Control Room installation file
 - TLS certificate
 - License file

Step 2: [Verify readiness for installation on Microsoft Azure](#)

Use these steps to configure third-party products for the Control Room installation.

Step 3: [Begin Control Room installation on Microsoft Azure](#)

Initial steps for Control Room installation on Microsoft Azure.

Step 4: *Customize Control Room installation on Microsoft Azure*

Install and apply the customized configuration required for the Control Room cluster on Microsoft Azure.

Step 5: Complete Control Room configuration and validation.*Complete Control Room post-installation configuration*

After installing the Control Room, complete the configuration settings to ensure timely Automation Anywhere communications are specified and confirm Automation Anywhere services are running.

Post-installation user management

After completing the post-installation tasks, validate the setup by logging in to the Control Room and installing a license. First time access to the Control Room walks you through the configuration for your authentication method.

Step 6: Prepare for users.*Users*

As a Cloud user with administrator permissions, you can create, view, edit, delete, and enable or disable a user. Creating users steps vary depending on whether the user is a non-Active Directory, Active Directory, or single sign-on (SSO) user from an IdP server.

Verify readiness for installation on Microsoft Azure

Use these steps to configure third-party products for the Control Room installation.

Note: There are many possible system configurations and requirements. These installation steps do not account for all those possibilities so your specific setup and installation steps will vary and Automation Anywhere does not make any warranties that these steps conform with your specific configurations.

To configure third-party products prior to installation, do the following steps:

1. Ensure the installation environment meets the data center requirements and collect the necessary information about the following components:

- Load balancer - IP address
- Microsoft SQL Server - port credentials
- Azure SMB file share - address credentials
- Enterprise identity management system (optional)

If you have Active Directory (AD) - AD server domain credentials

- SMTP - host port HTTP/S ports for TLS (optional)
- Control Room servers - Have Windows credential manager installed

Refer to [Supported data center component versions on Microsoft Azure](#) for configuration and version information.

2. Configure the Network Security Group as per the recommended security policies for Inbound Port rules:

Data center object	Port	Protocol
Control Room	<ul style="list-style-type: none"> • 80 • 443 	Any
LDAP	<ul style="list-style-type: none"> • 3268 • 3269 	Any
email SMTP	587	Any
SSH	22	Any
RDP	3389	TCP

3. Configure the AD server.

Ensure all users are part of the AD domain and the AD server is setup in IaaS mode for Azure cluster environment installations. To add user, navigate to **Active Directory Users and Computers > <domain> > Users** and add the necessary user.

To configure the AD server on Azure with IDaaS, refer to the [Microsoft Azure documentation](#).

4. Ensure the Control Room servers in the cluster can ping each other.

If the ping is not successful:

- a) In **Windows Defender Firewall with Advanced Security>Inbound rules**, set the following values for the file and printer sharing firewall rule:
 - **Name:** File and Printer Sharing (Echo Request - ICMPv4-In)
 - **Group:** File and Printer Sharing
 - **Profile:**All
 - **Enabled:** Yes
 - **Action:** Allow
 - **Override:** No
 - **Program:** Any
 - **Local address:** Any
 - **Remote address:** Any
 - **Protocol:** ICMPv4
- b) Ping the Control Room after enabling the firewall rule change.

When you have completed the pre-installation configurations, [Begin Control Room installation on Microsoft Azure](#).

Supported data center component versions on Microsoft Azure

For installing Automation Anywhere on the Microsoft Azure cluster environment, the versions of data center components that are supported are identified for each component.

Data center object	Supported version	Configuration
Control Room operating system	<ul style="list-style-type: none"> • Microsoft Windows Server 2012 and 2012 R2 Datacenter • Microsoft Windows Server 2016 Standard and Datacenter • Microsoft Windows Server 2019 Standard and Datacenter 	IaaS
Identity management: Azure Active Directory	Azure Active Directory	<ul style="list-style-type: none"> • IDaaS • Windows 2016 for IaaS
SMB File Share	Azure File Share with Server Message Block 2.0 and 3.0 (SMB) protocol	PaaS
Load Balancer	Azure Load Balancer	PaaS
	Azure Application Gateway	
Microsoft SQL Server	Azure SQL Database with single database (Microsoft SQL Azure (RTM) - 12.0.2000.8)	PaaS

Begin Control Room installation on Microsoft Azure

Initial steps for Control Room installation on Microsoft Azure.

If you have not done so already, complete the pre-installation configuration in [Verify readiness for installation on Microsoft Azure](#).

Note: There are many possible system configurations and requirements. These installation steps do not account for all those possibilities so your specific setup and installation steps will vary and Automation Anywhere does not make any warranties that these steps conform with your specific configurations.

To begin the installation:

1. Use Remote Desktop Connection (RDC) to connect to the Control Room server, as an Administrator, and run the Control Room installer.
2. Click **Yes** to start the installer.
3. Click **Next** on the **Welcome to the Setup Wizard** page.
4. Accept the licensing agreement and click **Next**.
5. Select the **Custom** option and click **Next**.
6. Click **Next** to setup the system IPs.
The **Cluster Configuration** window displays.

Continue with [Customize Control Room installation on Microsoft Azure](#).

Customize Control Room installation on Microsoft Azure

Install and apply the customized configuration required for the Control Room cluster on Microsoft Azure.

If you have not done so already, complete the initial installation steps in [Begin Control Room installation on Microsoft Azure](#). This task requires the configuration information you gathered in the prerequisites stage. This includes IP addresses, certificates, and credentials for the the Control Room servers, datacenter servers, and databases.

Note: There are many possible system configurations and requirements. These installation steps do not account for all those possibilities so your specific setup and installation steps will vary and Automation Anywhere does not make any warranties that these steps conform with your specific configurations.

To install the Control Room in a cluster setup, do the following steps:

1. Select the **Enable Cluster Setup** check box.
The check box is enabled by default if the machine on which the setup is being run has local IP addresses configured.
To install the Control Room on a single node and not a cluster, clear the **Enable Cluster Setup** check box.
2. Enter the IP addresses of the nodes in the cluster.
 - a) Use a comma (,) to specify more than one IP address.
For example, to specify three IP addresses in the cluster, enter:
`192.0.2.1,192.0.2.2,192.0.2.3`

Important: The first IP address in the list is used as the master node. Ensure that you enter the IP addresses in the same order on all node configurations in subsequent installations. An incorrect

order causes the application to configure the IP addresses as separate clusters, which will result in data loss when the issue is fixed after installation.

You can install multiple nodes at the same time after the master node is initially installed.

After installation, you can add a new IP address to the cluster at the end of the list.

- b) After you enter the cluster IP addresses correctly, select a valid address IP at the message prompt to provide network access to the machine.

3. Click **Next** to configure the application Transport Layer Security (TLS).

4. In the **TLS Configuration** page, configure the following:

- **Generate a Self-Signed Certificate**

Enabling the **Self-Signed Certificate** option allows the installer to generate a unique private key and a self-signed certificate for the Control Room.

- **Import a Certificate**

To import a custom certificate, clear the **Self Signed Certificate** check box. This setting allows you to import a certificate using the **Certificate Path** field.

Note: The certificate file must be a PKCS12 format.

Provide the following information:

- **Certificate Path:** Click **Browse** to import the certificate.
- **Private Key Password:** Enter the password for the private key.

Password limitation: Do not use the at sign (@) in passwords. Using the special character @ in the password causes the certificate file import to fail.

- **Webserver Port:** Enter the web server port – either HTTP or HTTPS. If the port is already assigned, an error message is displayed.



Attention: The port validation message is also displayed when you add 8080 for the web server and if that port is already in use for a Control Room license service. Use a different unassigned port in these cases.

- **Enable Force HTTP traffic to HTTPS:** This option redirects all HTTP port requests to HTTPS. To access to the Control Room through HTTPS using the generated self-signed certificate, ensure the port numbers are different for HTTP and HTTPS.

To generate a custom certificate for HTTPS, ensure your custom certificate meets the following:

- Create a `.pfx` certificate with a pass code from a CA trusted authority.
- Combine Root, Intermediate, and Machine level certificates into a single certificate.
- Use the format `[WS Machine Host Name].[DomainName].com` for the private key.
- Include the host name as a fully qualified domain name (FQDN) in the certificate.

You provide the host name during Control Room installation.

- In multi-node HA clusters, issue certificates to the load balancer DNS name.
- Add individual URLs, which require access to all nodes, to the `Subject Alternative Name` field in the certificate.

For more information, see Automation Anywhere support site: [Automation 360 On-Premises prerequisites \(A-People login required\)](#).

5. Click **Next** to configure the service credentials.

6. In the **Service Credentials** screen, choose from the listed options.

The Windows Service credentials include a user name and password. The user specified must meet these requirements:

- A member of the local system administrator group.
- Have permission to manage services, including Automation Anywhere services.
- If you use Windows authentication to connect to the SQL database, ensure you grant the `db_owner` permission to the service credential user.

These service credentials allow the Control Room processes to run the required services.

- **Local System Account**—(default) The logged-on user performing the installation
- **Domain Account**—Specify a user that is not the local system account user
 - a. Clear the **Local System Account** check box.
 - b. Enter the user name and password for the domain account.

Use only supported characters for the user name and password. See [Supported special characters](#).
- **Do not use the Windows domain credentials**

Enter credentials valid for running Automation Anywhere services. Without the valid credentials, the Control Room will fail to launch.
- **PowerShell script restrictions**

Specify a user with permissions to launch PowerShell scripts who is not a Windows domain user. Without the relevant permissions, database table creation can fail.

7. Click **Next** to configure database type and server.

8. Set the connection and authentication for the database server.

Note:

- If possible, do not set the value for **Database Server** as **localhost**. If you must use **localhost**, note that the **Secure Connection** to the database will not work.
- Click **Browse** to select the SQL Server instance where the Control Room database will be created. Alternatively, enter a database server name or select one from the list.

Migration task: If you are migrating from Enterprise 11 to Automation 360, browse to the restored Enterprise 11 database.

Provide the following details:

- a) **Database Port:** Use the default port (1433) or specify a custom value.

[Configure default database port](#)

- b) **Use Secure Connection:** Select to use a CA certificate as specified.

Note: Use the same host name for certificate and database connections.

- c) **Certificate:** This option is enabled when you select **Use Secure Connection**. Browse to select a CA certificate.

[Import HTTPS and CA certificates](#)

- d) **Windows authentication:** This option is selected by default and allows connection to the SQL Server using Windows authentication.

Note: If you select Windows authentication, then the user running the installer is used to test that the database exists, create it if required, and grant `db_owner` to the service account user (NT Authority/System).

- e) **SQL Server authentication:** Select this option to use SQL Server authentication to connect to the database. Provide the correct user name and password for SQL authentication.

Use only supported characters for the user name and password. See [Supported special characters](#). Do not use semicolons (;) in the database password.

- f) **Name of Control Room database:** Enter the name of the Control Room database.

Migration task: If you are migrating from Enterprise 11 to Automation 360, enter the name of the restored database in the database field as shown in the following image:

The screenshot shows a 'Database Server' configuration window. It has a title bar with the Automation Anywhere logo. Below the title bar is a subtitle 'Select authentication method and provide database names'. The main area contains several sections: 'Database Server' with a dropdown menu set to 'SQL EXPRESS' and a 'Browse...' button; 'Database Port' with a text box containing '1433'; a checked checkbox for 'Use Secure Connection' with a 'Browse...' button; a 'Certificate (Optional):' section with a text box and 'Browse...' button; a radio button for 'Windows authentication' which is selected, and a radio button for 'SQL Server authentication'; 'Login ID:' and 'Password:' text boxes; a 'Name of Control Room database:' text box containing 'Restored-11*Database' which is highlighted with a red rectangle; and an 'InstallShield' label at the bottom left. At the bottom are '< Back', 'Next >', and 'Cancel' buttons.

9. Click **Next**.

10. On the **Ready to Install the Program**, click **Install** and allow the installation process to complete.

11. On the **InstallShield Wizard Completed** page, click **Finish**.

Launch Automation Anywhere is enabled by default.

Enable **Show installer settings** to open the `aae-installsummary.html` file. By default, this is located at `C:\Program Files\Automation Anywhere\Enterprise\`. Use this file to view a summary of the installation.

The Control Room launches in your default browser with the Configure Control Room settings page shown. Continue with [Configure settings post-installation on Microsoft Azure](#).

Configure settings post-installation on Microsoft Azure

After Control Room installation is complete, use the Microsoft Azure Portal to configure the clusters. Use the Azure Portal to configure Windows credentials, Control Room settings for repository and URL, master key for Credential Vault, Active Directory authentication, and optionally SMTP settings.

- If you have not done so already, complete the installation steps in [Customize Control Room installation on Microsoft Azure](#).
- The service account user must have read and write access for the Azure data drive (SMB).

Note: There are many possible system configurations and requirements. These installation steps do not account for all those possibilities so your specific setup and installation steps will vary and Automation Anywhere does not make any warranties that these steps conform with your specific configurations.

1. From the Azure Portal where [SMB File Share](#) is setup, get the Connection String to retrieve following parameters:
 - Internet or network address
 - User name
 - Password
2. Locate the Window Credential Manager on the control room server and click **Add a Windows Credential**.
3. Enter the credential information.

Note: Adding a user under Windows Credential Manager needs to be repeated on all the servers used for testing in the cluster environment (Control Room, Clients/Devices).

4. Enter information and click **Save and Continue**.

Repository path is extracted from SMB File Share and Control Room access URL in is a load balancer Public IP.
5. **Copy** the Master Key and save it (it will be needed to restart the services).
6. Select Express mode and click **Save and Continue**.
7. Enter the Active Directory authentication configuration information, including URL, Domain username, and password, then click **Check Connection**. If settings are correct, click **Next**.
8. Enter the AD user created previously and click **Check name in Active Directory**. Upon validation, click **Save and Log in**.

Create additional users as needed and create corresponding users in the Control Room.
9. Optional: Continue with installing other control room nodes in the cluster.

10. Perform the SMTP registration.

Note: A real SSL certificate is recommended for use with deployments.

This completes the Control Room installation on Microsoft Azure.

If you see a `Bad Gateway` error message after you install the Control Room in a three-node cluster setup with S0 Azure SQL Database, see the following article for troubleshooting steps.

[Automation A360 - Bad Gateway error in a three node cluster setup \(A-people login required\)](#)

Complete the Control Room configuration and validation.

- [Complete Control Room post-installation configuration](#)

After installing the Control Room, complete the configuration settings to ensure timely Automation Anywhere communications are specified and confirm Automation Anywhere services are running.

- [Post-installation user management](#)

After completing the post-installation tasks, validate the setup by logging in to the Control Room and installing a license. First time access to the Control Room walks you through the configuration for your authentication method.

- [Users](#)

As a Cloud user with administrator permissions, you can create, view, edit, delete, and enable or disable a user. Creating users steps vary depending on whether the user is a non-Active Directory, Active Directory, or single sign-on (SSO) user from an IdP server.

Installing Control Room on Google Cloud Platform

Log in to a Google Cloud Platform (GCP) server instance as administrator. Then download and start the Control Room installer and install in Custom mode.

Note: There are many possible system configurations and requirements. These installation steps do not account for all those possibilities so your specific setup and installation steps will vary and Automation Anywhere does not make any warranties that these steps conform with your specific configurations.

1. Complete the prerequisites for installation:

- Verify [Automation 360 On-Premises prerequisites](#).
- Ensure that you have the following:
 - Automation Anywhere Control Room installation file
 - TLS certificate
 - License file

2. [Prepare to install Control Room on Google Cloud Platform](#)

Ensure that you complete the required steps to prepare the Google Cloud Platform instances for installing the Control Room.

3. [Perform custom installation of Control Room on Google Cloud Platform](#)

Install and apply the customized configuration required for the Control Room cluster on Google Cloud Platform after completing initial preparations.

4. [Configure Google Cloud Platform settings after installation](#)

After installing the Control Room, configure the required settings on Google Cloud Platform.

5. Complete the Control Room configuration and validation.a) *Complete Control Room post-installation configuration*

After installing the Control Room, complete the configuration settings to ensure timely Automation Anywhere communications are specified and confirm Automation Anywhere services are running.

b) *Post-installation user management*

After completing the post-installation tasks, validate the setup by logging in to the Control Room and installing a license. First time access to the Control Room walks you through the configuration for your authentication method.

6. *Manage your users*

As a Cloud user with administrator permissions, you can create, view, edit, delete, and enable or disable a user. Creating users steps vary depending on whether the user is a non-Active Directory, Active Directory, or single sign-on (SSO) user from an IdP server.

Tip: To ensure that the bots run properly in GCP, we recommend that you create a whitelist for the following APIs:

- `/v2/repository/files/:id/content`
 - `/v2/repository/files/public/:id/content`
 - `/v2/blm/import`
-

Prepare to install Control Room on Google Cloud Platform

Ensure that you complete the required steps to prepare the Google Cloud Platform instances for installing the Control Room.

1. Configure the Network Security Group of all the servers as specified in the following list:

- Name: aarestrictedsecuritygroup
 - Type: Ingress
 - Targets: aarestrictedsecuritygroup
 - Filters: IP ranges: List of IP addresses provided by the IT security team
 - Protocols and ports: all
 - Action: Allow
 - Priority: 1000
 - Network: default
-

Note: In the IP address ranges field, enter all the IP addresses of all the virtual machines (VMs) in the cluster environment.

2. Set up the F5 load balancer with the following configurations:
 - Select standard as the type option.
 - Enter 0.0.0.0/0 as the Source address in Host.
 - Enter F5-LB-Private IP as the Destination Address/Mask in Host.
 - Enter 80 as the Port and select **HTTP** as the Service Port.
 - Select the **Notify Status to Virtual Address** check box.
 - Enable the load balancer state.

To use SSL offload with the F5 load balancer, provide the SSL certificate at the load balancer level, and configure your Control Room application servers to use HTTP mode only.

Recommendation: Your IT team should configure the F5 load balancer with the Control Room.

3. Set up pools and nodes with the following configurations:
 - a) Update the pool properties:
 - Choose a basic configuration.
 - Select ICMP as your gateway to monitor health.
 - b) Update the pool member options:
 - Choose the round-robin method for load balancing.
 - Disable the priority group activation.
 - c) Update the node properties:
 - Change the state to enabled.
 - Select node-specific health monitors.
 - Select ICMP as your gateway to monitor health.
4. Configure the Active Directory server.
Verify that all the VMs in the cluster can ping each other using private IP addresses.
5. Connect using RDP to one of the Control Room nodes or servers and run the Control Room installer.
The Installation Prerequisite Check verifies that your system has the basic configurations required for Automation Anywhere. See [Automation 360 On-Premises prerequisites](#).

Perform custom installation of Control Room on Google Cloud Platform

Perform custom installation of Control Room on Google Cloud Platform

Install and apply the customized configuration required for the Control Room cluster on Google Cloud Platform after completing initial preparations.

If you have not done so already, complete the initial installation steps: [Prepare to install Control Room on Google Cloud Platform](#).

1. Log in to the first Google Cloud Platform instance as an administrator.
2. Download the Automation Anywhere__<version>.exe file.
[A-People Downloads page \(Login required\)](#)
3. Run the installer file.
4. Click **Next** on the **Welcome to the Setup Wizard** page.
5. Accept the licensing agreement and click **Next**.

- 6.** Select the **Custom** option and click **Next**.

The **Destination Folder** page appears. By default, the destination folder is `C:\Program Files\Automation Anywhere\Enterprise\`.

- 7.** To make changes to the destination folder, click **Change**, enter a new destination folder name, and click **OK**.

Recommendation: **Do not** install the application directly in the root directory (`C:\`). You should create a folder, for example, `C:\Program Files\Automation Anywhere\Enterprise\`.

- 8.** Click **Next** to configure the IP cluster.

- 9.** Select the **Enable Cluster Setup** check box.

The check box is enabled by default if the machine on which the setup is being run has local IP addresses configured.

To install the Control Room on a single node and not a cluster, clear the **Enable Cluster Setup** check box.

- 10.** Enter the IP addresses of the nodes in the cluster.

- Enter IPv6 addresses if all the nodes in the network are using IPv6.
- Enter IPv4 addresses if some nodes in the network are using a combination of IPv4 and IPv6 addresses.

- a) Use a comma (,) to specify more than one IP address.

For example, to specify three IP addresses in the cluster, enter:

`192.0.2.1,192.0.2.2,192.0.2.3`

Important: The first IP address in the list is used as the master node. Ensure that you enter the IP addresses in the same order on all node configurations in subsequent installations. An incorrect order causes the application to configure the IP addresses as separate clusters, which will result in data loss when the issue is fixed after installation.

You can install multiple nodes at the same time after the master node is initially installed.

After installation, you can add a new IP address to the cluster at the end of the list.

- b) After you enter the cluster IP addresses correctly, select a valid address IP at the message prompt to provide network access to the machine.

- 11.** Click **Next** to configure the application Transport Layer Security (TLS).

12. In the **TLS Configuration** page, configure the following:

- **Generate a Self-Signed Certificate**

Enabling the **Self-Signed Certificate** option allows the installer to generate a unique private key and a self-signed certificate for the Control Room.

- **Import a Certificate**

To import a custom certificate, clear the **Self Signed Certificate** check box. This setting allows you to import a certificate using the **Certificate Path** field.

Note: The certificate file must be a PKCS12 format.

Provide the following information:

- **Certificate Path:** Click **Browse** to import the certificate.
- **Private Key Password:** Enter the password for the private key.

Password limitation: Do not use the at sign (@) in passwords. Using the special character @ in the password causes the certificate file import to fail.

- **Webserver Port:** Enter the web server port – either HTTP or HTTPS. If the port is already assigned, an error message is displayed.



Attention: The port validation message is also displayed when you add 8080 for the web server and if that port is already in use for a Control Room license service. Use a different unassigned port in these cases.

- **Enable Force HTTP traffic to HTTPS:** This option redirects all HTTP port requests to HTTPS. To access to the Control Room through HTTPS using the generated self-signed certificate, ensure the port numbers are different for HTTP and HTTPS.

To generate a custom certificate for HTTPS, ensure your custom certificate meets the following:

- Create a `.pfx` certificate with a pass code from a CA trusted authority.
- Combine Root, Intermediate, and Machine level certificates into a single certificate.
- Use the format `[WS Machine Host Name].[DomainName].com` for the private key.
- Include the host name as a fully qualified domain name (FQDN) in the certificate.

You provide the host name during Control Room installation.

- In multi-node HA clusters, issue certificates to the load balancer DNS name.
- Add individual URLs, which require access to all nodes, to the `Subject Alternative Name` field in the certificate.

For more information, see Automation Anywhere support site: [Automation 360 On-Premises prerequisites \(A-People login required\)](#).

13. Click **Next** to configure the service credentials.

14. In the **Service Credentials** screen, choose from the listed options.

The Windows Service credentials include a user name and password. The user specified must meet these requirements:

- A member of the local system administrator group.
- Have permission to manage services, including Automation Anywhere services.
- If you use Windows authentication to connect to the SQL database, ensure you grant the `db_owner` permission to the service credential user.

These service credentials allow the Control Room processes to run the required services.

- **Local System Account**—(default) The logged-on user performing the installation
- **Domain Account**—Specify a user that is not the local system account user
 - a. Clear the **Local System Account** check box.
 - b. Enter the user name and password for the domain account.

Use only supported characters for the user name and password. See [Supported special characters](#).
- **Do not use the Windows domain credentials**

Enter credentials valid for running Automation Anywhere services. Without the valid credentials, the Control Room will fail to launch.
- **PowerShell script restrictions**

Specify a user with permissions to launch PowerShell scripts who is not a Windows domain user. Without the relevant permissions, database table creation can fail.

15. Add the SQL Server and click **Next**.

Select **Microsoft SQL Server**, enter the name, and click **Next**.

16. On the **InstallShield Wizard Completed** page, click **Finish**.

Launch Automation Anywhere is enabled by default.

Enable **Show installer settings** to open the `aae-installsummary.html` file. By default, this is located at `C:\Program Files\Automation Anywhere\Enterprise\`. Use this file to view a summary of the installation.

The Control Room is opened in your default browser and displays the Configure Control Room settings page.

[Configure Google Cloud Platform settings after installation](#)

Configure Google Cloud Platform settings after installation

After installing the Control Room, configure the required settings on Google Cloud Platform.

If you have not done so already, complete the installation steps: [Perform custom installation of Control Room on Google Cloud Platform](#).

1. Configure the following Control Room settings:
 - a) Specify the host name URL by providing the Google Cloud Platform load balancer URL. This is the URL that users use to access the Control Room.
 - b) Select the Active Directory authentication type. See [Configure Control Room for Active Directory: manual mode](#).

2. After you configure the Control Room, install product licenses.
3. Test access to the Control Room using the Google Cloud Platform load balancer URL.

Complete the Control Room configuration and validation.

- *Complete Control Room post-installation configuration*

After installing the Control Room, complete the configuration settings to ensure timely Automation Anywhere communications are specified and confirm Automation Anywhere services are running.

- *Post-installation user management*

After completing the post-installation tasks, validate the setup by logging in to the Control Room and installing a license. First time access to the Control Room walks you through the configuration for your authentication method.

- *Users*

As a Cloud user with administrator permissions, you can create, view, edit, delete, and enable or disable a user. Creating users steps vary depending on whether the user is a non-Active Directory, Active Directory, or single sign-on (SSO) user from an IdP server.

Installing Control Room on Linux

You start installing the Automation Anywhere Control Room in the Linux environment and complete the installation in the Control Room.

Note: The installation steps do not list any specific configurations or requirements and therefore your setup might be different. Automation Anywhere does not provide any warranties that the installation steps conform with your system configurations or requirements.

This task applies to first-time installation and updates of Automation 360 On-Premises.

Ensure the following:

- The Microsoft SQL Server or Oracle Server database is installed and running.
- The Automation 360 installation server is connected to the Microsoft SQL Server or Oracle Server database.
- For Oracle Server, ensure that you have installed the appropriate JDBC driver for the Oracle version that is connected to the Control Room.
- Starting in Automation 360 Build 6463, ensure that Python 3.6 is installed.

- For Oracle Server, only non-container database is supported.

1. Verify the installation prerequisites.

a) Verify the [Automation 360 On-Premises prerequisites](#).

b) Depending on the server you want to use, verify that the Microsoft SQL Server or Oracle Server is running, and execute the command:

```
$ sudo systemctl status mssql-server
```

If Microsoft SQL Server is not running, install it.

Note: The Microsoft SQL Server or Oracle Server installation instructions refer to Red Hat Enterprise Linux version 8. For version 7, change the paths to `/rhel/7` instead of `/rhel/8`.

See [Quickstart: Install SQL Server](#).

c) Ensure the following files are available:

- SSL certificate
- License file

d) Download the `Automation360_e17_Build_<build_number>.bin` installation file to the Linux server from [A-People Downloads page \(Login required\)](#)

Note: We do not support the patch upgrades (upgrading between builds in the same release) in Linux. When you are performing a patch upgrade, we recommended that you always uninstall and do a fresh install for the patch upgrades.

e) Verify that the installation server has internet access in order to update Linux kernel files and OS libraries using Yum updates.

Alternatively, configure `/etc/yum.conf` on the installation server to use a Yum repository local to its network. The Yum repository should be up to date before starting the installation.

f) Starting in Automation 360 Build 6463, Python 3.6 is required.

2. Log in to the installation server.

3. Run the installer command as a superuser from the Linux shell:

a) `$ sudo chmod +x Automation360_e17_Build_<build_number>.bin`

b) `$ sudo ./Automation360_e17_Build_<build_number>.bin`

The installation wizard verifies the installation requirements and proceeds with the installation.

Tip:

- Enter the `back` command to return to a previous command step.
 - Press the **return key** to accept default values, or enter an alternate value and then press the **return key**.
-

4. To accept the license agreement, enter `Y`.

5. In the **Transport Layer Security (TLS)** screen, configure the following:
 - a) Control Room HTTP Port (Default: 80)
 - b) Control Room HTTPS Port (Default: 443)
 - c) To enable the Self Signed Certificate, enter 1 or enter 2 to disable it.
 - d) To Force HTTP Traffic to HTTPS, enter 1 to disable it or enter 2 to enable it.

Configure application Transport Layer Security

6. In the **Cluster Configuration** screen, enter 1 to disable it or enter 2 to enable it.
 - If you choose to enable cluster configuration, enter the IP addresses of the cluster nodes. Use a comma (,) to specify more than one IP address. Do not add space between IP addresses. For example: 192.168.0.1,192.168.0.2,192.168.0.3
 - The repository location should be a shared location accessible from all Control Room nodes in the cluster.
 - If multiple local IP addresses are configured on the machine, select the IP address to which the Control Room is connected to.

Configure IP cluster

7. In the **Database Type** screen, select one of the following servers:
 - Microsoft SQL Server
 - Oracle
8. In the **Service Startup Options** screen, select one of the following options:
 - **Default (Start All Services):** Enables all Control Room services to automatically run at startup.
 - **Custom (Choose Startup Options):** Enables you to select the Control Room services that you want to automatically run at startup. All the services will be installed on the device. However, only the selected services will automatically run at startup. If required, you can manually start the services that were set to **Manual**.

For each service, select one of the following options:

 - **Automatic:** Enables to automatically run the selected service at startup.
 - **Manual:** Enables to manually enable the selected service when required.

Note: Depending on the database type you selected, some services might not be available for selection as some of the services might not yet be supported for the selected database type.

9. Depending on the database server you chose, configure the following settings the server:

Microsoft Database Configuration	Oracle Database Configuration
Database Server address (default: localhost)	Database Server (default: localhost)
Database port (default: 1433)	Database port (default: 1521)
Control Room Database (default: Automation360-Database) or enter a name.	Connect with SID or Service Name Note: The SID and Service Name entered in the text field provided is unique to your Oracle database.

Microsoft Database Configuration	Oracle Database Configuration
SQL Server Login credentials: provide the login ID and SQL Server password.	Database User/Schema Password: provide the password.
Password prompt for elasticsearch: Enter or define any password.	(Optional) Use Secure Connection: Enable to use a CA certificate as specified and select a CA certificate. Note: Use the same host name for certificate and database connections. <i>Import HTTPS and CA certificates</i>

10. In the **Database Configuration** screen, configure the following:

- a) Database Server address (default: localhost)
- b) Database port (default: 1433)
- c) Control Room Database (default: Automation360-Database) or enter a name.
- d) SQL Server Login credentials: provide the login ID and SQL Server password.
- e) Password prompt for elasticsearch: Enter or define any password.

11. Review the pre-installation summary.

12. Press Enter to install Automation 360 in the default directory.

Linux installer	Version	Default directory path
Installation file path	Version .22 and earlier versions	/opt/automationanywhere/enterprise
	Updating from earlier versions to version .22	
	New installation of version .22 and later	/opt/automationanywhere/automation360

A message appears stating the installation is successfully completed. See [Installed Control Room directories and files](#) for the location of control room assets.

13. Configure the post-installation settings.

[Configuring post-installation settings](#)

Post-installation, a Control Room group `controlroom` is automatically created. Following users are a part of this group which run the respective Control Room services:

`crkernel, traefik, ignite, activemq, crelasticsearch, criqbot, crbotinsight, craari, crdiscoverybot, crstorage, crdiscoverybotml.`

14. Verify Automation 360 services started successfully.

[Stop and start Control Room services on Linux](#)

15. Set up Control Room access.

[Configure Control Room database](#)

16. Set up licenses.

[Installing additional licenses](#)

17. The log files for the Control Room installation are available at:

Linux installer	Version	Log file path
Log path	Version .22 and earlier versions	/var/log/automationanywhere/enterprise
	Updating from earlier versions to version .22	
	New installation of version .22 and later	/var/log/automationanywhere/automation360

After the Control Room installation and configuration is complete, users can register their devices to create and run bots.

[Install Bot Agent and register device](#)

If you are using Out of Memory Management (OOM Killer), please refer to this article for more information, *[Linux Automation 360 Control Room service stopped \(A-People login required\)](#)*.

Related tasks

[Performing silent installation of Control Room on Linux](#)

Silent Control Room installation, also known as unattended installation, uses a customized script with parameters specific to your business requirements. The entire installation process runs in the background without requiring user interaction or displaying messages.

[Uninstall Automation 360 On-Premises from Linux server](#)

Uninstall the On-Premises Control Room from your Linux server.

Related reference

[Installing Control Room On-Premises](#)

Review the installation core tasks and topics for installing the Automation 360 Control Room in a data center on an On-Premises server or a cloud service provider server instance.

[Control Room repository requirements](#)

The repository location is configured in the Control Room after installation. All your automations are stored in this repository.

Performing silent installation of Control Room on Linux

Silent Control Room installation, also known as unattended installation, uses a customized script with parameters specific to your business requirements. The entire installation process runs in the background without requiring user interaction or displaying messages.

- Verify you have completed the [Automation 360 On-Premises prerequisites](#).
- Ensure that you have the following:
 - Automation Anywhere Control Room installation file
 - SSL certificate
 - License file
- Verify the installation server has internet access in order to update Linux kernel files and OS libraries using Yum updates. Alternatively, configure `/etc/yum.conf` on the installation server to use a repository local to its network. The repository should be up to date before starting the installation.

Two scripts run the Linux silent installation:

- `LinuxInstaller.sh`: This script contains the installation parameters you want to apply during installation.
- `CallLinuxScript.sh`: This script executes the first script.

See the installation parameters and sample scripts.

Run the script in Linux shell.

1. Review the parameters and identify the settings you require.

Control Room installation parameters		
Installation parameter	Description	Script response options
Proceed with Installation	The installer analyzes your system and notifies you if it does not meet the prerequisites. In silent mode, set the value to 1.	1 = Continue 2 = Cancel
Continue setup wizard	The installer displays an introduction and offers options of <code>back</code> to return to a previous step and <code>quit</code> to cancel the installation. Default is <code>Enter</code> .	\n
Advance to end of License Agreement	In console mode, you have the option to page through the license agreement. In silent mode, you advance to the end by selecting 0.	0
Accept License Agreement	Accept the license agreement to continue with the installation. In silent mode, set the value to Y.	Y = Yes N = No
Control Room HTTP Port	The web server port you will use to access the Control Room with HTTP. The default value is 80. Replace the number 80 in the sample script to use a different port.	80 = Default port yy = your port number yy
Control Room HTTPS Port	The web server port you will use to access the Control Room with HTTPS. The default value is 443. Replace the number 443 in the sample script to use a different port.	443 = Default port zzz = your port number zzz
TLS configuration: Self-Signed Certificate	Choose to enable or disable the self-signed certificate. The default is Enable, or 1.	1 = Default (Enable) 2 = Disable

Control Room installation parameters		
Installation parameter	Description	Script response options
TLS Configuration: Force HTTP traffic to HTTPS	Choose to disable or enable forcing traffic from HTTP to HTTPS. The default is Disable.	1 = Default (Disable) 2 = Enable
Cluster setup	Choose to disable or enable clustering. The default is Disable.	1 = Default (Disable) 2 = Enable
Database server URL	server1.yourcompany.com	Enter the URL of the server where the database resides.
Database server port	Default is 1433	1433
Database name	Default is localhost	Default is localhost. If database is on a separate server, enter the host name.
Database SA user name	Database system administrator login ID	Default is sa.
Database SA user password	Database system administrator login ID	The password to log in to your database as system administrator user.
Database Secure Connection	Choose to disable or enable the connection. Default is Disable (1).	1 = Default (Disable) 2 = Enable
Pre-Installation summary	If the output is directed to a console, the installer will show a summary of features selected and whether the prerequisites are met. Default is <code>Enter</code>	\n
Proceed	Confirm to proceed with the installation. Default is <code>Enter</code> .	\n

2. Create the script `LinuxInstaller.sh`, substituting values for your own environment.



Warning: Be sure to test the connection to the SQL Server and enter verified values for database name, database administrator login ID, database administrator password. Invalid values cause the script to stall and fail.

Example script:

```
echo "Starting Installation"
#Change the next two lines to match the install filename you downloaded
sudo chmod a+x AutomationAnywhereEnterprise_A2019_e17_4799.bin
sudo ./AutomationAnywhereEnterprise_A2019_e17_4799.bin << EOF
1
\n
0
Y
80
```



```

443
1
1
1
#Change the next line to your Automation Anywhere install server
mybotserver.mycompany.com
1433
#Replace next line with your database name
AAE-Database
#Change the next two lines to your SQL Server admin ID and password
admin
youradminpasswordhere
1
\n
\n
\n
EOF

```

3. Create the script `CallLinuxscript.sh` to execute `Linuxinstaller.sh`.

This script writes the installation results to `/home/Installlog`. Change the path to the install log file, if required.

```

echo "Starting Linux installation"
sudo ./LinuxInstaller.sh >> /home/Installlog
echo "Installation Completed Successfully"

```

4. On the installation server, logged in as an Administrator, execute the scripts.

- a) `$ sudo chmod a+x LinuxInstaller.sh`
- b) `$ sudo chmod a+x CallLinuxscript.sh`
- c) `$ sudo ./CallLinuxscript.sh`

5. Review the installation log to confirm there were no errors.

Note: The Control Room installation folder on Linux is located by default at `/opt/automationanywhere/enterprise`.

Continue from the step **Configure the post-installation settings** in

[Installing Control Room on Linux](#).

Uninstall Automation 360 On-Premises from Linux server

Uninstall the On-Premises Control Room from your Linux server.

Ensure that the Automation 360 installation server is disconnected from the Microsoft SQL Server database.

1. Log in to the installation server.

2. Run the uninstaller command as a superuser:

```
$ sudo /opt/automationanywhere/enterprise/_Automation\ Anywhere\
Enterprise_installation/Change\ Automation\ Anywhere\ Enterprise\
Installation
```

The installation wizard verifies the installation and proceeds with the uninstallation.

Tip:

- Enter the `back` command to return to a previous command step.
- Press the **return key** to accept default values, or enter an alternate value then press the **return key**.

3. Confirm the uninstallation by entering `Y`.

The Automation 360 components are removed from the Linux system.

The databases with associated Automation 360 information about users and bots remains stored in the database and remain connected to any other Control Room in your cluster.

Performing silent uninstallation of Control Room on Linux

Use the sample script to perform an unattended uninstallation of Control Room.

Ensure that the Automation 360 installation server is disconnected from the Microsoft SQL Server database.

1. Log in to the installation server.
2. Create a shell script named `LinuxUninstall.sh` that will run the uninstallation process and automatically respond to prompts:

```
sudo /opt/automationanywhere/enterprise/_Automation\ Anywhere\
Enterprise_installation/Change\ Automation\ Anywhere\ Enterprise\
Installation << EOF
\n
1
\n
EOF
```

3. Mark the script as executable and run the uninstallation process.

a) `$ sudo chmod a+x LinuxUninstall.sh`

b) `$ sudo ./LinuxUninstall.sh`

The script is executed:

```
=====
Automation Anywhere Enterprise                (created with
  InstallAnywhere)
-----
Preparing CONSOLE Mode Uninstallation...

=====
Uninstall Automation Anywhere Enterprise
-----

About to uninstall...
```

4. When the uninstallation is complete, manually remove any remaining files.

Configure Control Room in cluster setup with shared repository for Linux

As an RPA platform administrator, you can configure the Control Room in a cluster setup across a shared repository to achieve high availability, load balancing, and disaster recovery.

- Verify whether the prerequisites for on-premises installation are met.

Automation 360 On-Premises prerequisites

- Ensure that you have the following:
 - Three Linux VMs with RHEL 7.9
 - One Linux VM with MS SQL 2019 connected to a database
 - One load balancer with access to all the nodes
 - One AWS NFS

If one of the Control Room nodes is down, the other nodes maintain continuity of service and manage the load on the server. If a specific node fails, data can be recovered from the other shared nodes on the server.

Perform the following steps to configure the Control Room in a cluster that has three nodes (N1, N2, and N3) using a shared repository.

1. Set up the NFS in AWS.
2. Create a directory in the nodes N1, N2, and N3.
`/CRRepo/AutomationAnywhere`
3. Run the following commands to grant the read and write permissions to the new directory across all the nodes:
 - a) `sudo chown -R crkernel:controlroom /CRRepo/AutomationAnywhere`
 - b) `sudo chmod -R 775 /CRRepo/AutomationAnywhere`
4. Run the following command in all the three nodes to edit the `fstab` file to mount and map the new directory with NFS.
`fs-eec88e3f.efs.ap-south-1.amazonaws.com:/ /CRRepo/AutomationAnywhere nfs rw,hard,intr,rsize=1048576,wsiz=1048576,timeo=14 0 0`
5. To verify that the remote NFS volume is successfully mounted, reboot nodes N1, N2, and N3, and run the `df -h` command.
After the share is mounted, the mount point becomes the root directory of the mounted file system.
6. To verify that the NFS is working across the shared repository, create a text file in the `/CRRepo/AutomationAnywhere` directory of node N1.
You can view the same file in the nodes N2 and N3 directory.
7. Install Control Room in the nodes N1, N2, and N3.

Installing Control Room on Linux

After Control Room is configured across the shared repository, perform the following steps:

1. Access Control Room through the load balancer URL.
2. Continue with the following steps after the Control Room configuration steps.
 - a. In the Control Room repository path, enter `/CRRepo/AutomationAnywhere`.
 - b. In the URL field, enter the load balancer server URL.
 - c. Complete steps required to create an admin user.

3. Verify the Control Room on all the three nodes by navigating to the **Administration > Settings > General tab**.

Add nodes to a cluster setup for Linux

As an RPA platform administrator, you can add nodes to a cluster for better performance and better load distribution.

Ensure the following:

- Verify whether the prerequisites for on-premises installation are met.
Automation 360 On-Premises prerequisites
- Verify that all the primary nodes and databases have backups.
- You must have the IP addresses of all the cluster members for the Control Room server network interfaces used for Elasticsearch communications.

Note: The Control Room servers can have multiple network interfaces. The server IP addresses must be statically assigned and cannot use the Dynamic Host Configuration Protocol (DHCP).

- If any external load balancers are used in the environment, update them with IP addresses from the new server nodes.
- Ensure that you have administrator or root privileges on the Control Room servers. You must be familiar with installing Control Room in custom mode and also with the related configuration settings.

Adding nodes to a cluster helps you to upgrade the configuration of the nodes in a cluster. You can add nodes to a Control Room cluster setup, change the IP addresses of nodes in the cluster, and monitor the health of the underlying cluster services.

Note: The minimal number of nodes supported within a Control Room cluster is three. The nodes in a cluster synchronize with each other over a local network. All the nodes in a cluster connect to the same database.

Perform the following steps to add three nodes (N4, N5, and N6) to a cluster that has three nodes (N1, N2, and N3).

1. On node N4, run the installer command as a superuser from the Linux shell:

```
$ sudo ./Automation360_e17_Build_<build_number>.bin
```
2. Proceed through the installer to the cluster configuration.
 - a) Select **Enable Cluster Setup**.
 - b) In the **Cluster IP addresses** box, enter the IP addresses of all the nodes that you need to configure in the cluster.

```
172.31.30.120, 172.31.21.216, 172.31.17.110, 172.31.20.242, 172.31.17.149,  
172.31.18.37
```

Note: The IP addresses must be entered in the same sequence on every node.

3. Complete the remaining steps to install Control Room.
Installing Control Room on Linux
4. Repeat the steps 1 through 3 for nodes N5 and N6.
5. Add the complete set of IP addresses for all the nodes in the older nodes N1, N2, and N3. Restart the nodes, one at a time.

6. To verify the health of the cluster, run the following commands in the command line:

- a) `curl -k --user es_client:<es password> https://172.31.30.120:47599/_cat/nodes`
The master node is indicated by an asterisk character (*).
- b) Verify that the IP address of the master node is the same as the one mentioned in the **elasticsearch.yml** file for all the nodes.
- c) `curl -k --user es_client:<es password> https://172.31.30.120:47599/_cat/health?pretty`

You must wait until the replication status turns **green**. The replication time varies depending on the data load in the clusters. The replication status turns green when the cluster is fully synchronized.

Remove nodes from a cluster setup for Linux

As an RPA platform administrator, you can remove nodes from a Control Room cluster setup to replace them or upgrade them for enhanced performance.

Ensure the following:

- Verify that all the primary nodes and databases have backups.
- Ensure that you have administrator or root privileges on the Control Room servers.

Perform the following steps to remove three nodes (N1, N2, and N3) from a cluster that has six nodes (N1, N2, N3, N4, N5, and N6).

1. Run the following command in the Linux shell to identify the master node.

```
curl -k --user es_client:Automation123 https://172.31.46.2:47599/_cat/nodes
```

2. Remove the non-master nodes N2 and N3 from the cluster.

- a) Log in to the server as an administrator and run the following command to stop all the Control Room services.

```
sudo systemctl stop controlroom*
```

- b) Log in to any of the non-master nodes.
- c) Edit the `cluster.properties` file located at `/opt/automationanywhere/automation360/config`.
- d) Remove the IP addresses for the original three nodes.

Note: Perform this action for all the nodes in the cluster. When you remove the IP addresses of the original three nodes, do not change their sequence.

- e) Edit the `elasticsearch.yml` file at `/opt/automationanywhere/automation360/elasticsearch/config`.
- f) Remove the old IP addresses from the list in the **discovery.zen.ping.unicast.hosts** attribute.
- g) Restart the non-master nodes, one at a time.

3. Remove the master node N1 from the cluster.

- a) Log in to the server as an administrator and run the following command to stop all the Control Room services.

```
sudo systemctl stop controlroom*
```

- b) Log in to any of the non-master nodes.
- c) Edit the `cluster.properties` file and remove the IP address of the old master node.

- d) Run the following command in any of the other nodes to identify the new master node.

```
curl -k --user es_client:<es password>https://172.31.18.37/_cat/nodes
```
- e) Edit the elasticsearch.yml file at /opt/automationanywhere/automation360/elasticsearch/config.
- f) Update the IP address of the new master node in the **cluster.initial_master_nodes** attribute.
- g) Remove the IP address of the old master node from the list in the **discovery.zen.ping.unicast.hosts** attribute.
- h) Run the following command to start the services on each node:

```
sudo systemctl start controlroom*
```

4. To verify the health of the cluster, run the following command in the command line:

```
curl -k --user es_client:<es password>https://172.31.18.37/_cat/nodes
```

You must wait until the replication status turns **green**. The replication status turns green when the cluster is fully synchronized.

Installing Control Room on Microsoft Windows Server using scripts

Silent Control Room installation, also known as unattended installation, uses a customized script for a full setup or an update setup. Silent installation runs the entire installation process in the background, without requiring user interaction or displaying messages.

To perform this task, you must be a administrator and have the required rights and permissions.

- Disable the User Access Control (UAC) on host VM for Control Room.
- Verify [Automation 360 On-Premises prerequisites](#).
- Ensure that you have the following:
 - Automation Anywhere Control Room installation file
 - TLS certificate
 - License file
- Create a Powershell script.
See the installation parameters and sample scripts.
- Run the script in Powershell.

1. Review the parameters and identify the settings you require.

- **Control Room installation parameters**

Variable name	Description
AA_CRCLUSTERCONFIG	if AA_SETCLUSTERMODE=1 then cluster IP comma separated
AA_CRDBPORT	Control Room database port. Default value is 1433
AA_CRDBSSLMODE	Secure SQL connection
AA_CRFORCEHTTPSCONFIG=" "	--

Variable name	Description
AA_CRFORCETOHTTPS="1"	Force traffic from HTTP to HTTPS
AA_CRHTTPPORT	Control Room HTTP port. Default is 5432
AA_CRHTTPSPORT	Control Room HTTPS port
AA_CRLISTENPORT	Web server port. Default value is 80
AA_CRSERVICECONFIRMPASSWD	If AA_CRSETLOCALSERVICECRED= 0, then confirm password
AA_CRSERVICEPASSWD	If AA_CRSETLOCALSERVICECRED= 0, then confirm password
AA_CRSERVICEUSERNAME	if AA_CRSETLOCALSERVICECRED= 0, then add domain\user name
AA_CRSETLOCALSERVICECRED	<ul style="list-style-type: none"> • 1 if service logon as System • 0 if service logon as specific user
AA_CRWCCERTPASSWD	Certificate password
AA_CRSELFSIGNCERT	1 for self-signed certificate
AA_CRWCCERTPATH	Certificate path
AA_SDSFEATURE	<ul style="list-style-type: none"> • true=Cloud deployment type • false=On-Premises deployment type
AA_SETCLUSTERMODE	For cluster set 1, otherwise 0
AA_SETUPTYPE	Setup type Custom or Express
INSTALLDIR	Installation Directory
IS_SQLSERVER_AUTHENTICATION	<ul style="list-style-type: none"> • 0 for Windows authentication • 1 for SQL authentication • 2 for Azure AD authentication
IS_SQLSERVER_DATABASE	SQL database name

Variable name	Description
IS_SQLSERVER_SERVER	SQL server name (host name)

- **Elasticsearch related parameters**

Parameter	Description
AA_ELASTICSEARCH_BACKUP	Used only if installing on the first node of a backup server. Enter 1 if yes. Note: The AA_ELASTICSEARCH_BACKUP parameter is used when you install an Control Room as backup server for audit.
AA_ELASTICSEARCHSYSIP	Valid IP address
AA_ESPASSWD	Password for Elasticsearch Note: An additional parameter for confirming the password is not available. The password must have a minimum of 6 characters.

- **Key-vault related parameters**

Parameter	Description
AA_KEYVAULTTYPE	Enter any of the following: <ul style="list-style-type: none"> • NONE if you do not want to define a key vault • AWSS for AWS Secrets Manager • CARK for CyberArk
IS_SQLSERVER_AUTHENTICATION	Enter any of the following: <ul style="list-style-type: none"> • 0 if SQL server authentication is not set • 1 if SQL server authentication is set
IS_SQLSERVER_EKVAUTHENTICATION	Use this if the SQL server authentication is configured for an external key vault. Enter any of the following: <ul style="list-style-type: none"> • 0 if SQL server authentication does not use an external key vault • 1 if SQL server authentication for a key vault is configured for CyberArk • 2 if SQL server authentication for a key vault is configured for AWS Secrets Manager

Parameter	Description
AA_CRSERVICECREDTYPE	Enter any of the following: <ul style="list-style-type: none"> • LOCAL if the Control Room database uses local authentication. • SERVICE if the Control Room database uses custom authentication. • SERVICEEKV if the Control Room database uses external key vault for authentication.
AWS Secrets Manager key vault parameters	
AA_AWSSREGION	AWS region
AA_DBAUTHAWSSECRET	AWS sqllogin secret
AA_CRSERVAWSSECRET	AWS service secret
CyberArk key vault parameters	
AA_CARKAPPID	CyberArk app ID
AA_CARKCERTIFICATE	Full certificate filename with path
AA_CARKOPTIONALCERT	Optional certificate filename with path
AA_CARKCERTPASSPHRASE	Certificate passphrase
AA_CARKVAULTURL	CyberArk URL
AA_DBAUTHCARKOBJECTNAME	CyberArk sqllogin object name
AA_DBAUTHCARKSAFENAME	CyberArk sqllogin safe name
AA_CRSEVVCARKOBJECTNAME	CyberArk service credential
AA_CRSEVVCARKSAFENAME	CyberArk service locker

- **IPv6-related parameters**

Parameter	Description
AA_IPV6ENABLED	Enter 1 to enable IPv6 addresses To disable IPv6 addresses, do not enter the parameter.

2. Optional: Edit the sample script to use a Microsoft SQL Server database.

Use the script to install the Control Room with the configuration options available in the installer.

- Correct values for variables such as `$service_username`, `$service_pwd`, `$db_server`, `$scr_port`.
- Run the script with Credentials in Service logon, and a non-secure connection using Microsoft SQL Server authentication with a new database.

Sample script:

```
$scr_port=80
```

```

$service_username= "domain\username" #e.g."aaspl-brd\ellie.brown"
$service_pwd="password"

#%certpath = "C:\SilentInstall\test256.pfx"
#%certpass = "changeit"

$db_server="localhost"
$cr_db_name="CRDB-NEW-SI-3"
$db_user="sa"
$db_pwd="Admin@123"

$elastic_password="Test@123"

$installation_path="C:\Program Files\Automation Anywhere"

#Install latest setup
$static_installation_path="\Enterprise\\""
$silent_details=" /s ", "v" -join "/"
$installpath_details=" /qn INSTALLDIR=\\"

$deployment_details=" /AA_SDSFEATURE=true"

$custom_details=" /vAA_SETUPTYPE=Custom
                 /vAA_CUSTOMMODETYPE=1"

$port_cluster_details=" /vAA_SETCLUSTERMODE=0
                       /vAA_CRLISTENPORT=$cr_port"

#$service_details=" /vAA_CRSETLOCALSERVICECRED=0
                  /vAA_CRSERVICEUSERNAME=$service_username
                  /vAA_CRSERVICEPASSWD=$service_pwd
                  /vAA_CRSERVICECONFIRMPASSWD=$service_pwd"

$service_details=" /vAA_CRSETLOCALSERVICECRED=1"

#$db_details=" /vAA_BIMETADATADBTYPE=AA_BIMETADATADBTYPE
              /vIS_SQLSERVER_SERVER=$db_server
              /vIS_SQLSERVER_DATABASE=$cr_db_name
              /vIS_SQLSERVER_DATABASE1=$bi_db_name"

$db_details=" /vIS_SQLSERVER_SERVER=$db_server
             /vIS_SQLSERVER_USERNAME=$db_user
             /vIS_SQLSERVER_PASSWORD=$db_pwd
             /vIS_SQLSERVER_DATABASE=$cr_db_name
             /vIS_SQLSERVER_AUTHENTICATION=1"

$other=" /vAA_ESPASSWD=$elastic_password
        /vAA_CRWCHTTPPORT=80
        /vAA_CRWCHTTPSPORT=443
        /vAA_CRSELFSIGNCERT=1
        /vAA_OPTIONALCACERT=0
        /vAA_CRWCCERTPATH=$certpath
        /vAA_CRWCCERTPASSWD=$certpass
        /vLAUNCHPROGRAM=1
        /v"
        /LIweamoruc! log.txt"

$final_commandline = -join($silent_details,
    $installpath_details,$installation_path,
    $static_installation_path,$custom_details,
    $port_cluster_details,$service_details,
    $db_details,$pg_details,$other)

Write-Host $final_commandline

```

```

$a=Get-ChildItem $PSScriptRoot\* -Include *.exe
#$a = "C:\Silent\AutomationAnywhereEnterprise_A2019_<build>.exe"

Write-Host $a
Write-Host "Starting the installation wait for sometime..."

$processdetail=(Start-Process -FilePath
  $a -ArgumentList $final_commandline
  -Wait -PassThru).ExitCode

Write-Host $a.Name execution is done.
If installation is not proper check msi logs in the temp folder.
pause

```

Note: When using Windows authentication for connecting to Microsoft SQL Server database, ensure that the following settings are configured:

- The *IS_SQLSERVER_AUTHENTICATION* installation parameter should be set to 0
- The user assigned to the *\$service_username* parameter should be an active user in Microsoft SQL Server with permissions set as: **db_datareader**, **db_datawriter**, and **db_ddladmin**
- The *\$db_user* and *\$db_pwd* parameter values should be disabled or commented out

3. Save the script you edit to the server for installation.
4. On the installation server, log on as an administrator, open Powershell in admin mode, and execute the following: `Set-ExecutionPolicy Unrestricted -Scope CurrentUser -Force`
5. Start Powershell in admin mode and execute: `.\install.ps1`

Note: The silent installation logs are stored in the folder from which the installation script is executed. For example, if you run the script from `C:\Silent Install`, the logs are stored in `C:\Silent Install` folder.

Complete the Control Room configuration and validation.

- After installing the Control Room, complete the configuration settings to ensure timely Automation Anywhere communications are specified and confirm Automation Anywhere services are running.
- After completing the post-installation tasks, validate the setup by logging in to the Control Room and installing a license. First time access to the Control Room walks you through the configuration for your authentication method.
- As a Cloud user with administrator permissions, you can create, view, edit, delete, and enable or disable a user. Creating users steps vary depending on whether the user is a non-Active Directory, Active Directory, or single sign-on (SSO) user from an IdP server.

Related concepts

[Post-installation user management](#)

After completing the post-installation tasks, validate the setup by logging in to the Control Room and installing a license. First time access to the Control Room walks you through the configuration for your authentication method.

Related tasks

[Complete Control Room post-installation configuration](#)

After installing the Control Room, complete the configuration settings to ensure timely Automation Anywhere communications are specified and confirm Automation Anywhere services are running.

[Performing silent installation of Control Room on Linux](#)

Silent Control Room installation, also known as unattended installation, uses a customized script with parameters specific to your business requirements. The entire installation process runs in the background without requiring user interaction or displaying messages.

Related reference

Users

As an administrator, you can create, view, edit, delete, and enable or disable a user. Creating users steps vary depending on whether the user is a non-Active Directory, Active Directory, or single sign-on (SSO) user from an IdP server.

Complete Control Room post-installation configuration

After installing the Control Room, complete the configuration settings to ensure timely Automation Anywhere communications are specified and confirm Automation Anywhere services are running.

1. *Configure post-installation settings*

After installing the Control Room, complete the configuration settings to ensure timely Automation Anywhere communications are specified and confirm Automation Anywhere services are running.

2. *Verify Automation Anywhere services*

Automation Anywhere specific services are installed on the Control Room server.

3. *Configure Control Room for HTTPS certificate*

Configure Control Room for HTTPS mode using a self-signed or CA certificate either before or after performing a custom Control Room configuration.

4. *Import HTTPS and CA certificates*

After installing the Control Room, import a certificate for HTTPS, Certificate Authority (CA), or both using the Windows or Linux command prompt.

5. *Configure disaster recovery site for Elasticsearch IP addresses*

If you have configured the Control Room for high availability (HA) and disaster recovery (DR) and installed the Control Room on both the primary and secondary sites, configure Elasticsearch IP addresses for the secondary site.

6. *Add primary IP address for cluster*

If your Control Room server has dual IP addresses or network interface cards (NICs) and you configure the second NIC as your backup IP address, you must manually update the `cluster.properties` file to include the backup IP address.

7. *Configure additional IP address for a new cluster node*

After installing the Control Room in the cluster node, when you add new nodes in the cluster, you must configure additional static IP addresses for all the nodes in the property file on each node in the cluster.

Configuring post-installation settings

After you finish installing the Control Room, configure specific items to ensure timely Automation Anywhere communications.

Post-installation tasks and settings

Exclude anti-virus

Exclude anti-virus scans from running in the Automation Anywhere local repository because they interfere with running bots.

Set the language locale

By default, the repository path is C :

\ProgramData\AutomationAnywhere\Server Files. If you have modified the repository path after installation, you can verify the path from **Administration > Settings > Control Room database & software**.

Select your language as the region setting.

The following example uses English (United States) as the region setting.

- **Windows:** Select **Control Panel > Region > Administrative > Change system locale**.

For usernames that contain non-ASCII characters, update the following settings:

1. From **Control Panel > Clock and Region > Administrative > Change system locale**, select the required language from the **Current system locale** list.
2. If available, clear the **Beta: Use Unicode UTF-8 for worldwide language support** check box.
3. To change the code page identifier, enter `chcp <identifier-code>` at the command prompt. For example, enter `chcp 949` to use ANSI or OEM Korean (Unified Hangul Code).

Code Page Identifiers

4. Restart your machine.

- **Linux**

1. Verify the current locale:

```
$ locale
```

2. Display a list of all available locales on the server:

```
$ locale -a
```

3. Depending on your operating system, use one of these options to set the locale for the whole server with the LANG variable.

Substitute language `en_US.UTF-8` with your own:

Ubuntu: `sudo update-locale
LANG=en_US.UTF-8 LANGUAGE`

Red Hat Enterprise Linux: `sudo
localectl set-locale
LANG=en_US.UTF-8`

4. Update either the global locale settings file `etc/locale.conf` or `settings /`

```
~/ .bash_profile for the user that owns  
Automation 360:
```

```
LANG="en_US.utf8"
```

```
export LANG
```

Set the region

Select your language as the region format.

Windows: Select **Control Panel > Region > Format**.

Set time synchronization

Enable Network Time Protocol (NTP) on the Control Room.

For additional information about setting the NTP, contact your system administrator.

For Microsoft Azure platform installation, set configuration

Use the Microsoft Azure Portal to configure:

- Windows credentials
- Control Room settings for repository, URL, and master key for Credential Vault
- Microsoft Active Directory authentication
- Optionally, SMTP settings

Related tasks

[Complete Control Room post-installation configuration](#)

After installing the Control Room, complete the configuration settings to ensure timely Automation Anywhere communications are specified and confirm Automation Anywhere services are running.

Related reference

[Verifying Automation Anywhere services](#)

Automation Anywhere specific services are installed on the Control Room server.

[Working with SQL Servers](#)

Configure Microsoft SQL Servers before setting up the Control Room database.

Verifying Automation Anywhere services

Automation Anywhere specific services are installed on the Control Room server.

Linux users: See [Stop and start Control Room services on Linux](#).

Verify installed Windows services

From your Windows device:

1. Select **Control Panel > Administrator Tools > Services**.

The specific path to **Services** can vary, depending on your specific Windows version.

2. Scroll through the list to find the listed service name. Note the **Status** should show as running.

Control Room installed services

Verify that the following Windows services are installed by the Automation Anywhere Control Room installer.

Service name	Description
Automation Anywhere Bot Compiler Service	Stores all details about the bot compile service. Receives and processes Bot compilation requests for the Control Room.
Automation Anywhere Control Room Caching	Used for distributed cache storage.
Automation Anywhere Control Room IQ Bot Service	Used for Automation 360 IQ Bot.
Automation Anywhere Control Room Messaging	Allows Control Room services to communicate asynchronously.
Automation Anywhere Control Room Reverse Proxy	Receives all incoming HTTP and HTTPS requests for Automation Anywhere products and forwards to the correct service.
Automation Anywhere Control Room Robotic Interface Service	Is the Automation Anywhere Robotic Interface (AARI) service used to create and orchestrate workflows between forms and bots.
Automation Anywhere Control Room Service	Receives and processes API requests for the Control Room.
Automation Anywhere Elastic Search Service	Stores all logs and related activities for search functionality. For details about Elasticsearch, see Elastic Stack and Product Documentation .
Automation Anywhere Control Room Discovery Bot Service	Used for Discovery Bot.
Automation Anywhere Control Room Discovery Bot ML Service	Used to launch Discovery Bot from Control Room.
Automation Anywhere Control Room Storage Service	Used as a storage solution to leverage automation projects.

- All the services can be configured either in the Local System or Domain account when the Control Room is installed in Custom mode. For a Control Room installed in Express mode, all the services are run in the Local System account.
- By default, the Automation Anywhere Control Room services restart automatically after a system reboot. You do not need a windows service start-up script to restart the services.
- We recommend you wait for two (2) minutes for the Automation Anywhere Control Room services to restart after a system reboot. If the services do not start automatically, you will see the `Bad gateway` error. You can restart the services manually in any sequence.
- Running RPA Workspace services is mandatory for using the RPA Workspace platform. However, running the AARI, Discovery Bot, and IQ Bot services is optional for RPA Workspace platform.

Related concepts

[Installing Control Room using Custom mode](#)

Log in to the server as an administrator and install Automation Anywhere Control Room in Custom mode to select installation and configuration options, including installing non-default requirements. Select this mode for a data center deployment.

Related tasks

[Installing Control Room using Express mode](#)

[Installing Control Room on Linux](#)

You start installing the Automation Anywhere Control Room in the Linux environment and complete the installation in the Control Room.

Configure Control Room for HTTPS certificate

Configure Control Room for HTTPS mode using a self-signed or CA certificate either before or after performing a custom Control Room configuration.

Transportation Layer Security is configured as part of the Control Room installation. If that step was skipped or the certificate expires, configure the TLS certificate with this post-installation configuration.

Important: It is not recommended to use self-signed certificates. However, if you use a self-signed certificate, ensure you install the certificate on each device manually and accept the certificate to enable communication between the device and the Control Room after configuring the self-signed certificate.

1. Log in to the Control Room.
The Control Room instance launches in your default browser.
2. Change the Control Room URL setting and port to `HTTPS` and port number to `443`.
The **Website Security Warning** page is displayed.
3. Continue to the Control Room website to access the Control Room.

[Configure Control Room authentication options](#)

If you have already configured it, then log in to the Control Room.

Related tasks

[Import HTTPS and CA certificates](#)

After installing the Control Room, import a certificate for HTTPS, Certificate Authority (CA), or both using the Windows or Linux command prompt.

[Configure application Transport Layer Security](#)

Use the **Transport Layer Security (TLS) configuration** wizard page from the Automation 360 installer to generate a self-signed certificate or import a security certificate to set up a highly secure Control Room instance.

Import HTTPS and CA certificates

After installing the Control Room, import a certificate for HTTPS, Certificate Authority (CA), or both using the Windows or Linux command prompt.

You can import HTTPS and CA certificates in the following scenarios:

- When you switch the Control Room from HTTP to HTTPS after Automation 360 is installed.
- The certificates expire or need modification, for example, when you add a new server.

These instructions apply to both Windows and Linux installations.

To import a CA or HTTPS certificate for configuring the Control Room for secure connection using the command prompt, perform the following steps:

1. Run the command prompt in administrator mode.

2. Navigate to the Automation Anywhere installation path.

The default installation path for Windows is `C:\Program Files\Automation Anywhere\Automation360`.

The default installation path for Linux is `/opt/automationanywhere/enterprise`

3. Enter or paste the following at the command prompt:

- For Windows HTTPS certificate, enter the command:

```
jdk11\bin\java -jar certmgr.jar -appDir "C:\Program Files\Automation Anywhere\Automation360" -setServerCert "C:\Users\cradmin\Desktop\test_automationanywhere_com.pfx" -privateKeyPass <PFX Password>
```

- For Linux CentOS HTTPS certificate, enter the command:

```
jdk11/bin/java -jar certmgr.jar -appDir "/opt/automationanywhere/enterprise" -setServerCert "/home/<user>/test_automationanywhere_com.pfx" -privateKeyPass <PFX Password>
```

- For Windows CA certificate, enter the command:

```
jdk11\bin\java -jar certmgr.jar -appDir "C:\Program Files\Automation Anywhere\Automation360" -importTrustCert "D:\<user name>\My Downloads\CA31.cer"
```

- For Linux CentOS CA certificate, enter the command:

```
jdk11/bin/java -jar certmgr.jar -appDir "/opt/automationanywhere/enterprise" -importTrustCert "CA31.cer"
```

4. Restart the Control Room Reverse Proxy Service to view the imported certificates.**5. During the installation, if you did not accept the default and indicated you want to upload your own (self-signed) certificate, add the following parameters to the `boot.db.properties` file that is located in the `config` folder, in the Automation Anywhere installation path.**

- Windows file location:

```
root:\Program Files\Automation Anywhere\config\boot.db.properties
```

- Linux file location:

```
/opt/automationanywhere/enterprise/config/boot.db.properties
```

Parameter:

```
trustServerCertificate=false
```

Editing SQL user information

Edit MS-SQL configuration related settings, including username, password, database server name, database server IP and port numbers.

To perform this task, you must be a administrator and have the required rights and permissions.

Download the latest Control Room utility and make certain this utility installed on every sever where Automation 360 is running.

Note:

Users are required to make changes to the running configuration via the command line interface.

Note: Please stop all Automation 360 services on all nodes where a Control Room is installed before performing this task.

1. Open the command line prompt and navigate to the Automation 360 application.
For example, `C:\Program Files\Automation Anywhere\jdk11\bin`.
2. Follow the prompts from the utility to select the SQL database and enter the required credentials.

Note: The password will not be displayed on the console

3. Restart the Automation 360 services on the nodes.
The SQL user information has been successfully updated.

Configure disaster recovery site for Elasticsearch IP addresses

If you have configured the Control Room for high availability (HA) and disaster recovery (DR) and installed the Control Room on both the primary and secondary sites, configure Elasticsearch IP addresses for the secondary site.

Ensure that you are logged in to the as the administrator.

Complete the Control Room installation on both the primary and secondary DR sites.

Before adding a new node, ensure the existing cluster is in yellow or green state and all ports on the new node are open.

Perform this task to make the IP address of the secondary DR site Elasticsearch available to the primary DR site.

1. From the primary site Control Room, navigate to **Administration > Settings > General > Control Room Database & Software**.
2. Click **Edit**.
3. Enter the DR secondary site **Cluster IP address** in the **Elasticsearch disaster recovery backup cluster** field.
4. Click the plus sign to add additional cluster IP addresses.
5. Click **Save Changes**.

Related concepts

[High availability deployment](#)

To support Automation 360 in your data center, configure an high availability (HA) cluster. Follow your company methods and procedures for implementing your data center cluster.

Related tasks

[Warm stand-by](#)

Host two setups or sites - primary and backup for the warm stand-by DR procedure.

Add primary IP address for cluster

If your Control Room server has multiple IP addresses or network interface cards (NICs), you can manually update the `cluster.properties` file to include the primary IP address.

To perform this task, you must be a administrator and have the required rights and permissions.

- Ensure you have the view and manage settings permission.
- Complete the Control Room installation.

- Updating the `cluster.properties` file requires a downtime, so ensure a maintenance window for the following:
 - All the user devices will be disconnected.
 - No schedules will run during maintenance.
 - Bot Agent and Automation Anywhere Control Room will not be accessible.

Update the `cluster.properties` file to ensure the caching service requirement to define a single IP address for the primary NIC of the Control Room.

Complete this task on all the Control Room nodes in a high availability cluster.

1. Locate the `cluster.properties` file in your Control Room directory.
For example, the default location is: `C:\Program Files\Automation Anywhere\Enterprise\config\`

If the file does not exist in your Control Room directory, create the file.

2. Add the following property option to the `cluster.properties` file:
`ignite.local.static.ip=<nic_ip_address>`
For example, `ignite.local.static.ip=172.16.20.168`

Note: The `ignite.local.static.ip` property is configured with a single IP address of the primary NIC of the Control Room node. You can manually reconfigure the property when more than one IP address is available.

3. Save the `cluster.properties` file.
4. Restart the following Automation Anywhere Windows services:
 - a) Automation Anywhere Control Room Caching
 - b) Automation Anywhere Control Room Messaging
 - c) Automation Anywhere Control Room Service
5. To ensure all the cache is in sync, restart the rest of the Automation Anywhere Windows services.

Configure additional IP address for a new cluster node

After installing the Control Room in the cluster node, if you add new nodes in the cluster, you have to configure additional static IP addresses for all the nodes in the property file on each node in the cluster.

To perform this task, you must be a administrator and have the required rights and permissions.

- Ensure that you have a maintenance window, which requires complete downtime for the following:
 - All the user devices will be disconnected.
 - No schedules will run during maintenance.
 - Bot Agent and Automation Anywhere Control Room will not be accessible.
- Complete the Control Room installation on any new node.

Perform the following steps on each node in the cluster:

1. Stop the following Automation Anywhere services on the Control Room node:
 - a) Automation Anywhere Control Room Reverse Proxy
 - b) Automation Anywhere Control Room Caching
 - c) Automation Anywhere Control Room Service
 - d) Automation Anywhere Elastic Search Service
 - e) Automation Anywhere Bot Insight Elastic Search
 - f) Automation Anywhere Control Room IQ Bot Service
 - g) Automation Anywhere Control Room Robotic Interface Service
 - h) Automation Anywhere Control Room Discovery Bot Service
2. Locate the `cluster.properties` file in your Control Room directory.
For example, the default location is: `C:\Program Files\Automation Anywhere\Enterprise\config\`
If the file does not exist in your Control Room directory, create the file.
3. Add the following properties and configure the primary IP addresses as a static IP address for all the cluster nodes (including existing cluster nodes) in the `cluster.properties` file.

```
ignite.discovery.mode=static
ignite.discovery.static.ips=<primary ip addresses>
```

For example: `ignite.discovery.static.ips=10.0.11.153,10.0.11.13`

4. If the nodes have multiple IP addresses, also add the following property and configure a specific primary IP address on each node in the cluster:

```
ignite.local.static.ip=<primary ip address>
```

For example: `ignite.local.static.ip=10.0.11.153`

5. Save the `cluster.properties` file.
6. Modify the `elasticsearch.yml` file for the new IP address:
 - a) Locate the `elasticsearch.yml` file in the Control Room directory.
For example, the default location is: `C:\Program Files\Automation Anywhere\Enterprise\elasticsearch\config\elasticsearch.yml`
 - b) Update `elasticsearch.yml` with the new IP address using the following property:
`discovery.zen.ping.unicast.hosts:["ip1","ip2","ip-new"]`
 - c) Save the `elasticsearch.yml` file.
7. Start all the services that were stopped in Step 1 on each Control Room node.

Note: Wait for an interval of 40 seconds before starting the next service.

Add Automation 360 On-Premises DNS to trusted list

To ensure secure access to Automation 360 online services for On-Premises deployment, add specific Automation Anywhere Domain Name System (DNS) to the safe recipients or trusted list on each user device.

DNS list

Automation 360 online service hosting uses dynamic IP addresses and therefore we recommend that you add to the safe recipients or trusted list the complete DNS instead of an IP address for the Automation Anywhere online services.

Note: The list can vary based on the end-user environment for On-Premises deployments.

Service	DNS	Port	Devices
Automation Anywhere	www.automationanywhere.com	TCP 443 (HTTPS)	All devices
Automation Anywhere community (A-People)	apeople.automationanywhere.com	TCP 443 (HTTPS)	All devices
Automation Anywhere documentation	docs.automationanywhere.com	TCP 443 (HTTPS)	All devices
Bot Store	botstore.automationanywhere.com	TCP 443 (HTTPS)	All devices
Telemetry Allows performance and usage information to be gathered anonymously in order to improve product quality.	<ul style="list-style-type: none"> cdn.pendo.io app.pendo.io/ data.pendo.io/ https://pendo-static-5673999629942784.storage.googleapis.com/ 	TCP 443 (HTTPS)	All devices
Automation Anywhere Google Chrome extension Enables you to automate using the Google Chrome browser.	https://chrome.google.com/webstore/detail/automation-360/kammdlphdfejlopbonbapgpbgakimokm	TCP 443 (HTTPS)	Bot Creator and Bot Runner devices
Automation Anywhere Microsoft Edge extension Enables you to automate using the Microsoft Edge browser.	https://microsoftedge.microsoft.com/addons/detail/automation-360/dbmodiepejcgijlbmeebedkmegndokbk	TCP 443 (HTTPS)	Bot Creator and Bot Runner devices
Automation Anywhere Mozilla Firefox extension Enables you to automate using Mozilla Firefox browser.	https://addons.mozilla.org/en-US/firefox/addon/automation-360	TCP 443 (HTTPS)	Bot Creator and Bot Runner devices

Files and folders

For information on files and folders to add to the safe list and to the antivirus exception list, see these articles:

- [Files and URLs to add to safe list for Automation 360 \(A-People login required\)](#)
- [List of files to add to antivirus exception list for Automation 360 \(A-People login required\)](#)

Related reference

[Add Automation 360 Cloud DNS to trusted list](#)

To ensure secure access to Automation 360 cloud services, add specific Automation Anywhere Domain Name System (DNS) to the safe recipients or trusted list.

Uninstalling Automation 360

Use the Automation 360 installer or the **Uninstall or change a program** option from the Windows Control Panel to remove or uninstall a Control Room instance.

1. To uninstall the Control Room using the installer, run the setup file from the installation path.
Run the installer in admin mode.
2. In the InstallShield wizard, click **Next**.
3. Click **Remove**.
4. Click **Finish** to complete uninstalling the Control Room from your machine or server.

Related concepts

[Migrate to Automation 360](#)

Related reference

[Installing Control Room On-Premises](#)

Review the installation core tasks and topics for installing the Automation 360 Control Room in a data center on an On-Premises server or a cloud service provider server instance.

Installing Control Room for Cloud-enabled deployment

With Cloud-enabled deployment, you can store and process native business and operational data on site and take advantage of management and operational services delivered from Automation Anywhere Cloud.

Automation Anywhere deploys and provisions an Automation 360 Cloud-enabled service instance in our cloud to deliver management and operational capabilities. Customer then installs the Cloud-enabled application within their infrastructure to consume these capabilities for storing and processing customer data.

Note: Linux is not supported for Cloud-enabled deployments.

For Cloud-enabled deployment, the initial welcome email that you received from Automation Anywhere contains:

- URL to the Automation Anywhere Cloud-enabled instance
- Provisioning token needed to establish trust connectivity with the Automation Anywhere Cloud Control Room

Important: Do not discard the content of this email. You will need the information in the email to setup on-premises application.

1. Receive your Automation 360 Cloud-enabled service URL from Automation Anywhere and provisioning token.
2. Install and access the On-Premises application.
Download and install the Cloud-enabled application on your network; the installation user is assigned administrator privileges.
Installing Control Room On-Premises
3. Log in to the On-Premises Control Room.
Log in to Automation Anywhere Control Room
4. Navigate to **Administration > Settings > Cloud-Enabled**.
5. Provide the provisioning token to connect to the Control Room.
6. Click **Save changes**.
The trusted relationship between the instances is created.
7. To test Cloud-Enabled functionality, open a browser, enter the URL of the Cloud Control Room service instance, and press Enter.
You are redirected to the On-Premises Control Room.

Related concepts

[Post-installation user management](#)

After completing the post-installation tasks, validate the setup by logging in to the Control Room and installing a license. First time access to the Control Room walks you through the configuration for your authentication method.

Related tasks

[Install Bot Agent and register device](#)

The Bot Agent is a lightweight application that enables you to run bots on your device by connecting the device to the Control Room. To run bots on a local machine, install the Bot Agent and add the local device to the list of enabled host devices.

Related reference

[Installed Control Room directories and files](#)

When installing the Automation Anywhere Control Room on different operating systems, the installer executes and installs files and folders in the following directories.

Naming guidelines for Control Room URLs

Adhere to Domain Name System (DNS) guidelines when you configure domain and subdomain Control Room URLs for On-Premises and Cloud deployments.

Guidelines for On-Premises Control Room deployments

By following these DNS guidelines, you can successfully register your Bot Agent with the On-Premises Control Room. According to RFC 952, RFC 1035, and RFC 1123, the following guidelines apply when creating names for domain and subdomain URLs:

- The host name can be up to 63 characters in length and can contain the following characters:
 - Uppercase characters (A–Z)
 - Lowercase characters (a–z)
 - Numerals (0–9)
 - Hyphens (-)
- The host name should not consist of all numeric values.
- The host name should not start nor end with a hyphen (-).
- The URL domain and subdomain names should not contain the underscore character (_).

Note: Instead of an underscore (_), use a hyphen (-).

Guidelines for Cloud Control Room deployments

By following DNS guidelines, you can successfully register your Bot Agent with the Cloud Control Room. The Cloud Control Room URL syntax is: `https://<domainname>.myautomationanywhere.digital`, where `<domainname>` is configurable.

- The domain name can be up to 27 characters in length and can contain the following characters:
 - Lowercase characters (a–z)
 - Numerals (0–9)
 - Hyphens (-)
- The domain name should not consist of all numeric values.
- The domain name should not start nor end with a hyphen (-).
- The URL domain and subdomain names should not contain the underscore character (_).

Note: Instead of an underscore (_), use a hyphen (-).

Related reference

[Automation 360 Cloud prerequisites](#)

Use the checklist to determine whether your device fulfills the requirements for registering with Automation 360 Cloud.

[Automation 360 On-Premises prerequisites](#)

Determine whether the system has the required hardware and software to install Control Room for Automation 360 On-Premises.

Post-installation user management

After completing the post-installation tasks, validate the setup by logging in to the Control Room and installing a license. First time access to the Control Room walks you through the configuration for your authentication method.

Configure Control Room authentication options

The options for launching the Control Room for the first time and the authentication method depend on the installation mode and deployment type.

Validate services

Validate that the following services are running in automatic mode:

- Automation Anywhere Control Room Caching
- Automation Anywhere Control Room Messaging
- Automation Anywhere Control Room Reverse Proxy
- Automation Anywhere Control Room Service
- Automation Anywhere Elastic Search Service
- Automation Anywhere Bot Compiler Service
- Automation Anywhere Control Room IQ Bot Service
- Automation Anywhere Control Room Robotic Interface Service
- Automation Anywhere Control Room Discovery Bot Service
- Automation Anywhere Control Room Discovery Bot ML Service
- Automation Anywhere Control Room Storage Service

Users

As an administrator, you can create, view, edit, delete, and enable or disable a user. Creating users steps vary depending on whether the user is a non-Active Directory, Active Directory, or single sign-on (SSO) user from an IdP server.

Related tasks

[Complete Control Room post-installation configuration](#)

After installing the Control Room, complete the configuration settings to ensure timely Automation Anywhere communications are specified and confirm Automation Anywhere services are running.

Configure the Control Room as a service provider

A valid SAML IDP setup must be configured before the Control Room can be switched to a SAML-authentication environment.

This task is performed by a network administrator. You must have the necessary privileges to complete this configuration.

Complete the necessary network-side preparations to switch the Control Room to act as the service provider in the SAML IDP setup.

1. Set the ACS or service provider URL to <Enterprise Control Room URL>/v1/authentication/saml/assertion.

Note: Ensure that you do not configure the SAML assertions for single logout.

2. Create user with matching information in the Control Room.
Key attributes include: **UserID**, **FirstName**, **LastName**, and **EmailAddress**.
This value will be required when setting up the Control Room side of this configuration.
3. Update SAML settings for Active Directory.
Make the necessary updates to pertinent directories and toolkits, making certain to select Single Sign On as the login method.

```
<saml2:AuthnStatement
  AuthnInstant="authenticated_instance" SessionIndex="index_value_required">
```

[Set up SAML authentication on the Control Room](#)

Related tasks

[Set up SAML authentication](#)

Switch an authenticated environment Control Room database to a SAML identity provider (IdP).

Configure Control Room authentication options

The options for launching the Control Room for the first time and the authentication method depend on the installation mode and deployment type.

The authentication options for Control Room in Cloud and Cloud-enabled deployments differ from the options for On-Premises deployment (installed using the Custom mode).

After the installation (Custom mode) is complete, configure the Control Room in Custom mode to authenticate users with an Active Directory (AD), Control Room database, or single sign-on (SSO).

Note: The Active Directory authentication mode is available for On-Premises deployment and not for Cloud and Cloud-enabled deployments.

Based on your installation mode (express or custom) and deployment type (On-Premises, Cloud, and Cloud-enabled), select any of the following authentication methods for the Control Room:

- After an Express mode installation, configure the Control Room in Express mode using the default settings.

[Configure Control Room in Express mode](#)

- Authenticate users using Active Directory by manually adding the LDAP URLs.

[Configure Control Room for Active Directory: manual mode](#)

- Authenticate users using Active Directory by enabling the Control Room to discover and list domains and sites in your organization.

[Configure Control Room for Active Directory: auto mode](#)

- Authenticate users using the database option.

[Configure Control Room database](#)

- Configure an authenticated environment Control Room database to a SAML identity provider (IDP).

Set up SAML authentication

- Configure the environment for Smart Card, X.509 Certificate authentication.

Configure Smart Card authentication installation procedure

Configure Control Room in Express mode

After completing the installation in Express Mode, configure the Control Room in Express Mode using the default settings.

To configure Control Room when you start it for the first time, do the following steps:

1. Open Control Room in a browser to launch the **Getting Started** wizard.
 - **Windows:** Double-click the Automation Anywhere Control Room icon on the desktop.
 - **Linux:** Open a browser and navigate to the Linux server hostname. Example:
`server1.mycompany.com`
2. Fill in the following fields:
 - **Username:** Enter a user name.
 - **First name** Enter the first name.
 - **Last name** Enter the last name.
 - **Email** Enter an email address.
 - **Password** Enter a password.
 - **Confirm password** Confirm the password.
3. Click **Next**.

The **Create security questions** page appears.
4. Enter three security questions and answers.
5. Click **Next**.

The **Credential settings** page appears.
6. Select from the following options:
 - **Express mode:** The system stores your master key to connect to the Credential Vault on the Control Room filesystem. This option is not recommended for a production environment.
 - **Manual mode:** You store the Master Key on your own, and then provide the Master Key when the Credential Vault is locked. Users use the Master Key to connect to the Credential Vault to secure their credentials and access them when creating and running TaskBots.



Warning: If you lose the key, you will not be able to access the Control Room.

7. Click **Save and log in**.

You are logged in to the Control Room as an administrator. You can now configure and manage the overall RPA environment with Control Room and clients.

After configuring the Control Room, install product licenses.

Configure Control Room for Active Directory: manual mode

Configure the Control Room to authenticate users using Active Directory by manually adding the Lightweight Directory Access Protocol (LDAP) URLs.

To configure the Control Room when you start it for the first time, do the following:

1. Double-click the Automation Anywhere Control Room icon on your desktop.
The **Configure Control Room settings** page appears.
2. Type the repository path.
This is the location where the uploaded automation files, for example, IQ Bots, and TaskBots are stored. For example, `C:\ProgramData\AutomationAnywhere\Server Files`.
3. Enter the access URL.
This is the URL for accessing your installation of Control Room.
4. Click **Save and continue**.



Warning: The **back** button of your web browser is automatically disabled after you click **Save and continue**. This ensures that the Credential Vault Master Key that generates matches the repository path and Control Room access URL.

To return to the **Configure Control Room settings** page, press `Ctrl plus F5` and restart.

The **Credential Vault settings** page appears.

5. Select from the following options:
 - **Express mode:** The system stores your master key to connect to the Credential Vault. This option is not recommended for a production environment.
 - **Manual mode:** You store the Master Key on your own, and then provide the Master Key when the Credential Vault is locked. Users use the Master Key to connect to the Credential Vault to secure their credentials and access them when creating and running TaskBots.



Warning: If you lose the key, you will not be able to access the Control Room.

6. Click **Save and continue**.



Warning: The **back** button of the web browser is automatically disabled after you click **Save and continue**. No further changes to the Control Room configuration or Credential Vault settings are allowed.

To make changes, reinstall the Control Room.

The **Authentication type for Control Room users** page appears.

7. Select Active Directory.

Automation Anywhere supports Active Directory Multi-Forest authentication for the Control Room. Before providing the Authentication Type, ensure the following:

- One-way or two-way trust is set up between all forests. For a one-way trust, this is from the Enterprise Client forest to the Control Room forest (Control Room forest must always be the trusting forest).
- Two-way trust is set up for every domain in a forest.
- The root certificate of the LDAP server is imported using the provided CertMgr tool via command.
- The provided LDAP URLs per forest cannot be behind a load balancer. Also, all LDAP URLs must point to the root (main) domain controllers.
- The node that runs the Control Room is in the same domain network where the Active Directory runs.
- The user is in the parent domain and the URL points to the parent.

This ensures that when there are two or more forests, and one of the forest has a subdomain with a different name space, a user from the other forests does not have permission to access that subdomain.

8. Type the Global Catalog URL.

For example, `ldap://server01.domain.com`.

For failsafe authentication, click the plus option to provide additional LDAP URLs.

Note: For users and groups from one or more Active Directory domains, to access the Control Room, use a fully qualified host name of the Global Catalog (GC) server, listening on port 3268 (3269 if SSL).

When adding LDAP URLs, ensure that you provide a fully qualified host name like `ldap://server01.ldap.com`.

Provide URLs of multiple Global Catalogs per forest so that if one Global Catalog in a forest goes down, the other can serve. This feature does not provide support for the load-balanced URL.

You must enter the Domain username and password and click **Manually add connections** to enter the LDAP URLs.

9. Provide service account credentials

Ensure that the username provided is a user in the Domain Users group and ideally and be set up in Active Directory with a **password never expires** option. If otherwise, there will be some downtime in RPA authentication as the service account password is reset. Provide the username in a User Principal Name (UPN) in the `username@domain.com` format and password.

10. Click Check connection.

If Control Room is unable to connect to the Active Directory database, an error message appears.

11. Click Next.

The **Control Room first administrator** page appears.

12. Select the Active Directory domain from the drop-down list and type the Control Room administrator username.**13. Click Check name in Active Directory.**

If the username is in the Active Directory the following user details are shown:

- **First name**
- **Last name**
- **Email**

You can edit these prepopulated fields.

14. Click Save and log in.

You are logged in to the Control Room as an administrator. You can now configure and manage the overall RPA environment with Control Room and clients.

After configuring the Control Room, install product licenses.

Related tasks[Configure Control Room for Active Directory: auto mode](#)

Configure the Control Room to authenticate users using Active Directory by enabling the Control Room to discover and list domains and sites in your organization.

Configure LDAP channel binding

Configure LDAP channel binding in Automation 360 On-Premises for enhanced security in network communications between an Active Directory and its clients. This method provides a more secure LDAP authentication over SSL and TLS.

Enable channel binding in the `um.properties` file when required.

1. Go to the Control Room installation path.
2. From the list of files in the `config` folder, open the `um.properties` file with an XML editor.
3. Add the `um.ldap.channel.binding.enabled` property in the `um.properties` file.
For example, `um.ldap.channel.binding.enabled=false`
4. To enable channel binding, change the value to `true`.
The default value is `false` and channel binding is disabled.
Channel binding is enabled if it is enabled on the server side.

For information about enabling channel binding on the server side, see [LDAP enforce channel binding registry entry](#).

5. Save the file.

Configure Control Room for Active Directory: auto mode

Configure the Control Room to authenticate users using Active Directory by enabling the Control Room to discover and list domains and sites in your organization.

To configure the Control Room when you start it for the first time, do the following:

1. Double-click the Automation Anywhere Control Room icon on your desktop.
The **Configure Control Room settings** page appears.
2. Type the repository path.
This is the location where the uploaded automation files, for example, IQ Bots, and TaskBots are stored. For example, `C:\ProgramData\AutomationAnywhere\Server Files`.
3. Enter the access URL.
This is the URL for accessing your installation of Control Room.
4. Click **Save and continue**.



Warning: The **back** button of your web browser is automatically disabled after you click **Save and continue**. This ensures that the Credential Vault Master Key that generates matches the repository path and Control Room access URL.

To return to the **Configure Control Room settings** page, press `Ctrl plus F5` and restart.

The **Credential Vault settings** page appears.

5. Select from the following options:

- **Express mode:** The system stores your master key to connect to the Credential Vault. This option is not recommended for a production environment.
- **Manual mode:** You store the Master Key on your own, and then provide the Master Key when the Credential Vault is locked. Users use the Master Key to connect to the Credential Vault to secure their credentials and access them when creating and running TaskBots.



Warning: If you lose the key, you will not be able to access the Control Room.

6. Click **Save and continue**.



Warning: The **back** button of the web browser is automatically disabled after you click **Save and continue**. No further changes to the Control Room configuration or Credential Vault settings are allowed.

To make changes, reinstall the Control Room.

The **Authentication type for Control Room users** page appears.

7. Select Active Directory.

Automation Anywhere supports Active Directory multi-forest authentication for the Control Room. Before providing the authentication type, ensure the following:

- For one-way trust between forests:
 - The Bot Agent devices are in one or more forests and the Control Room is in a different forest, the Control Room must be in the trusting forest.
 - Set up trust between the forest that contains the Control Room and each of the forests containing the Bot Agent devices.
 - Domains containing Bot Agent devices and the Control Room must be configured with two-way trust between the domains.
- For two-way trust between forests:
 - In the scenario where the Bot Agent devices are in one or more forests and the Control Room is in a different forest, all forests containing Bot Agent device and the Control Room are configured with two-way trust between forests.
 - Set up trust between all forests containing the Control Room and the Bot Agent devices.
 - Domains containing Bot Agent devices and the Control Room must be configured with two-way trust between the domains.
- The root certificate of the LDAP server is imported using the provided CertMgr tool via command.
- The provided LDAP URLs per forest cannot be behind a load balancer. Also, all LDAP URLs must point to the root (main) domain controllers.
- The node that runs the Control Room is in the same domain network where the Active Directory runs.
- The user is in the parent domain and the URL points to the parent.

This ensures that when there are two or more forests, and one of the forest has a sub-domain with a different name space, a user from the other forests does not have permission to access that sub-domain.

8. Type the Domain username.

Ensure you use the User Principal Name (UPN) in the `username@domain.com` format.

The username you enter is for a user who has access to all domains using the same credentials.

9. Type the Domain password.

This user is not expected to use the Control Room. Although you have an option to update the password, use an Account with the password never expires option. If it expires, it can be updated but with some downtime.

10. Click **Discover connections**.

All discovered Active Directory domains with one or more sites per domain are shown.

By default, all domains and sites are selected. If only one domain and one site under it is discovered, then it is shown in read-only mode and cannot be edited.

You can configure the maximum number of sites per domain that can be discovered across multiple domains by adding the following property in the `um.properties` file saved in `<installation path>/config`:

```
um.ldap.auto.discovery.find.max.sites=<number of sites>
```

For example, you can configure auto-discovery for a maximum of 15 sites per domain by adding the entry `um.ldap.auto.discovery.find.max.sites=15` in the `um.properties` file. This means that for every domain that you have, a maximum of 15 associated sites can be discovered per domain.

Note: If this property is not configured, by default, 10 sites per domain will be discovered.

11. Select the domains and sites to use for authentication.

Select the domains and sites to use for authentication. Select a minimum of one site for each domain that is selected

12. Click **Test connections** to register the sites to use for authentication.**13.** Click **Check connection**.

If Control Room is unable to connect to the Active Directory database, an error message appears.

14. Click **Next**.

The **Control Room first administrator** page appears.

15. Select the **Active Directory domain** from the drop-down list and type the Control Room administrator username.**16.** Click **Check name in Active Directory**.

If the username is in the Active Directory the following user details are shown:

- **First name**
- **Last name**
- **Email**

You can edit these pre-populated fields.

17. Click **Save and log in**.

You are logged in to the Control Room as an administrator. You can now configure and manage the overall RPA environment with Control Room and Bot Agent.

After configuring the Control Room, install product licenses.

Related tasks

[Configure Control Room for Active Directory: manual mode](#)

Configure the Control Room to authenticate users using Active Directory by manually adding the Lightweight Directory Access Protocol (LDAP) URLs.

[Configure Control Room database](#)

Configure the Control Room to authenticate users using the database option.

Configure Smart Card authentication installation procedure

Configure the Control Room to authenticate users using the Smart Card option.

To perform this task, you must be a administrator and have the required rights and permissions.

Follow these steps to configure your Cloud Control Room to use Smart Card, X.509 certificate authentication.

1. Configure the secondary hostname to point to the Control Room load balancer.

This process defines the secondary hostname used for authentication requests when the Control Room is configured for Smart Card authentication. The secondary hostname is configured within the Control Room load balancer automatically. Both the primary and secondary hostnames must be configured within the DNS system used by the Control Room environment (add DNS entries for primary and secondary hostnames - external to Control Room).

2. How to obtain Java KeyStore with trusted CA certificates.

Configure the location the Control Room will check for Certificate Authority (CA) certificates used to authenticate user certificates for user logins.

Note: The certificates in this location are the server certificates for the CAs that will issue the user certificates.

Option	Action
Periodically scan the following location	This setting allows the administrator to define the path to keystore file containing the CA certificates. Use this setting if you periodically update the CA truststore and set the frequency of the scan.
Upload the KeyStore manually	This setting allows the administrator to load a keystore file containing the CA certificates. Use this setting if your CAs are known and static and indicate whether or not the keystore is password protected. If the keystore is password protected, supply and confirm the password.

3. Select the revocation checking method.

Revocation checking configures the Control Room to reject authentication requests for certificates that have been revoked.

Option	Action
Online Certificate Status Protocol (OSCP)	Use this setting if your CA has OSCP implemented.
Certificate Revocation List	Use this setting if you maintain a static list of revoked certificates.
No Revocation Checking	Using this setting the Control Room will not perform revocation check. Note: This is not recommended for production deployments where revocation will typically be used.

4. Use the other method if selected method fails

This setting will attempt to use the non-selected method of revocation checking if the configured method fails.

5. Allow user to authenticate even if revocation status cannot be determined

Use this setting to assure users can authenticate if either of the revocation check method fails.

6. Configure user name mapping.

User name mapping specifies which attribute of the user certificate is used for the Control Room username. The user name must be configured in the Control Room prior to the user logging into the Control Room and must match the user name derived from the certificate.

a) Obtain user name from**Certificate subject**

Use this setting if the Control Room user name is the same as the string in the Subject field for the user certificate.

Universal Principal Name

Use this setting if the Control Room user name is the same as the string in the Universal Principal Name field for the user certificate.

b) Use Regular Expression

Enter Regular Expression that will filter the Control Room user name from the selected field of the user certificate. This may not be necessary if the Control Room user name is the same as the data within the selected certificate field.

7. Configure first name mapping.

First name mapping specifies which attribute of the user certificate is used for the Control Room username. The first name must be configured in the Control Room prior to the user logging into the Control Room and must match the user first name derived from the certificate.

a) Obtain first name from**Certificate subject**

Use this setting if the Control Room first name is the same as the string in the Subject field for the user certificate.

Universal Principal Name

Use this setting if the Control Room user name is the same as the string in the Universal Principal Name field for the user certificate.

b) Use Regular Expression

Enter Regular Expression that will filter the Control Room user first name from the selected field of the user certificate. This may not be necessary if the Control Room user first name is the same as the data within the selected certificate field.

8. Configure last name mapping.

Last name mapping specifies which attribute of the user certificate is used for the Control Room username. The last name must be configured in the Control Room prior to the user logging into the Control Room and must match the user last name derived from the certificate.

a) Obtain last name from**Certificate subject**

Use this setting if the Control Room last name is the same as the string in the Subject field for the user certificate.

Universal Principal Name

Use this setting if the Control Room user name is the same as the string in the Universal Principal Name field for the user certificate.

b) **Use Regular Expression**

Enter Regular Expression that will filter the Control Room user last name from the selected field of the user certificate. This may not be necessary if the Control Room user last name is the same as the data within the selected certificate field.

9. Configure email address mapping.

Email address mapping specifies which attribute of the user certificate is used for the Control Room username. The email address must be configured in the Control Room prior to the user logging into the Control Room and must match the user last name derived from the certificate.

a) **Obtain last name from****Certificate subject**

Use this setting if the Control Room email address is the same as the string in the Subject field for the user certificate.

Universal Principal Name

Use this setting if the Control Room user name is the same as the string in the Universal Principal Name field for the user certificate.

b) **Use Regular Expression**

Enter Regular Expression that will filter the Control Room user email address from the selected field of the user certificate. This may not be necessary if the Control Room user email address is the same as the data within the selected certificate field.

10. Click **Next**.

Control Room smart card first administrator

After configuring the smart card authentication process, an administrator user is needed. This process will walk you through setting up the first administrator for the Control Room.

To perform this task, you must be a administrator and have the required rights and permissions.

When authenticating with smart cards, the authenticating system will send a signal to the operating system to "Insert Smart Card" and prompt the user, from the smart card software, to select the certificate to use for authentication.

The following steps guide you through setting up your first administrator user with smart card authentication installed.

You should be on the correct configuration page if you have completed [Configure Smart Card authentication installation procedure](#).

1. Navigate to > **Control Room first administrator**.
2. Insert the smart card for the administrator.
3. Click **Authenticate and pre-fill user data**.

This will start the smart card authentication process and pre-fill data from the selected certificate base on the mappings defined during the configuration of the Certificate (smart card) authentication installation process. If any information requires correction, click the **Back** button and make the necessary changes.

4. Verify the data.

View the Username, First Name, Last Name, and Email Address that is pre-filled and verify that these data points were correctly mapped during the smart card authentication installation procedure.

5. Click **Save and log in**

The configuration of Certificate (smart card) authentication strategy is complete.

After configuration of the smart card authentication process, the login page of the Control Room will display only the "Insert CAC/PIV" option for authenticating the user. Pressing this button will start the smart card authentication process and the browser will signal a smart card login request to the operating system which will then prompt the user to insert their smart card and possibly an optional PIN.

The user selects the appropriate certificate on the smart card and proceeds with the Control Room login.

Configure Control Room database

Configure the Control Room to authenticate users using the database option.

To configure the Control Room when you start it for the first time, do the following:

1. Open a browser and navigate to the Control Room URL.

The **Configure Control Room settings** page appears.

- **Windows**

Double-click the Automation Anywhere Control Room icon on your desktop.

- **Linux**

Open a browser and navigate to the host name of the server on which you installed Automation Anywhere Control Room. Example: `myserver.mycompany.com`

Note: Do not retain a following slash at the end of the URL, as the validation will fail.

2. Enter the repository path.

- **Windows**

This is the location where the uploaded automation files, for example, IQ Bot s, and TaskBots are stored. For example,

```
C:\ProgramData\AutomationAnywhere\Server Files
```

- **Linux**

```
/opt/automationanywhere/enterprise/appdata
```

3. Enter the access URL.

This is the URL for accessing your installation of Control Room.

4. Click **Save and continue**.



Warning: The **back** button of your web browser is automatically disabled after you click **Save and continue**. This ensures that the Credential Vault Master Key that generates matches the repository path and Control Room access URL.

To return to the **Configure Control Room settings** page, press `Ctrl plus F5` and restart.

The **Credential Vault settings** page appears.

5. Select from the following options:

- **Express mode:** The system stores your master key to connect to the Credential Vault. This option is not recommended for a production environment.
- **Manual mode:** You store the Master Key on your own, and then provide the Master Key when the Credential Vault is locked. Users use the Master Key to connect to the Credential Vault to secure their credentials and access them when creating and running TaskBots.



Warning: If you lose the key, you will not be able to access the Control Room.

6. Click **Save and continue**.



Warning: The **back** button of the web browser is automatically disabled after you click **Save and continue**. No further changes to the Control Room configuration or Credential Vault settings are allowed.

To make changes, reinstall the Control Room.

The **Authentication type for Control Room users** page appears.

7. Select **Control Room database**.

Select from Active Directory, Single Sign-On (SAML 2.), Certificate (Smart Card), or Control Room database. Please refer to those configuration topics for specific steps and processes.

8. Click **Next**.

The **Control Room first administrator** page appears.

9. Fill in the following fields:

- **Username:** Enter a user name.
- **First name** Enter the first name.
- **Last name** Enter the last name.
- **Email** Enter an email address.
- **Password** Enter a password.
- **Confirm password** Confirm the password.

10. Click **Next**.

The **Create security questions** page appears.

11. Enter three security questions and answers.

12. Click **Save and log in**.

You are logged in to the Control Room as an administrator. You can now configure and manage the overall RPA environment with Control Room and clients.

Install a license.

Related tasks

[Configure Control Room for Active Directory: manual mode](#)

Configure the Control Room to authenticate users using Active Directory by manually adding the Lightweight Directory Access Protocol (LDAP) URLs.

[Configure Control Room for Active Directory: auto mode](#)

Configure the Control Room to authenticate users using Active Directory by enabling the Control Room to discover and list domains and sites in your organization.

Configure Control Room for HTTPS certificate

Configure Control Room for HTTPS mode using a self-signed or CA certificate either before or after performing a custom Control Room configuration.

Transportation Layer Security is configured as part of the Control Room installation. If that step was skipped or the certificate expires, configure the TLS certificate with this post-installation configuration.

Important: It is not recommended to use self-signed certificates. However, if you use a self-signed certificate, ensure you install the certificate on each device manually and accept the certificate to enable communication between the device and the Control Room after configuring the self-signed certificate.

1. Log in to the Control Room.
The Control Room instance launches in your default browser.
2. Change the Control Room URL setting and port to `HTTPS` and port number to `443`.
The **Website Security Warning** page is displayed.
3. Continue to the Control Room website to access the Control Room.

Configure Control Room authentication options

If you have already configured it, then log in to the Control Room.

Related tasks

[Import HTTPS and CA certificates](#)

After installing the Control Room, import a certificate for HTTPS, Certificate Authority (CA), or both using the Windows or Linux command prompt.

[Configure application Transport Layer Security](#)

Use the **Transport Layer Security (TLS) configuration** wizard page from the Automation 360 installer to generate a self-signed certificate or import a security certificate to set up a highly secure Control Room instance.

Import HTTPS and CA certificates

After installing the Control Room, import a certificate for HTTPS, Certificate Authority (CA), or both using the Windows or Linux command prompt.

You can import HTTPS and CA certificates in the following scenarios:

- When you switch the Control Room from HTTP to HTTPS after Automation 360 is installed.
- The certificates expire or need modification, for example, when you add a new server.

These instructions apply to both Windows and Linux installations.

To import a CA or HTTPS certificate for configuring the Control Room for secure connection using the command prompt, perform the following steps:

1. Run the command prompt in administrator mode.
2. Navigate to the Automation Anywhere installation path.

The default installation path for Windows is `C:\Program Files\Automation Anywhere\Automation360`.

The default installation path for Linux is `/opt/automationanywhere/enterprise`

3. Enter or paste the following at the command prompt:

- For Windows HTTPS certificate, enter the command:

```
jdk11\bin\java -jar certmgr.jar -appDir "C:\Program Files\Automation Anywhere\Automation360" -setServerCert "C:\Users\cradmin\Desktop\test_automationanywhere_com.pfx" -privateKeyPass <PFX Password>
```

- For Linux CentOS HTTPS certificate, enter the command:

```
jdk11/bin/java -jar certmgr.jar -appDir "/opt/automationanywhere/enterprise" -setServerCert "/home/<user>/test_automationanywhere_com.pfx" -privateKeyPass <PFX Password>
```

- For Windows CA certificate, enter the command:

```
jdk11\bin\java -jar certmgr.jar -appDir "C:\Program Files\Automation Anywhere\Automation360" -importTrustCert "D:\<user name>\My Downloads\CA31.cer"
```

- For Linux CentOS CA certificate, enter the command:

```
jdk11/bin/java -jar certmgr.jar -appDir "/opt/automationanywhere/enterprise" -importTrustCert "CA31.cer"
```

4. Restart the Control Room Reverse Proxy Service to view the imported certificates.**5.** During the installation, if you did not accept the default and indicated you want to upload your own (self-signed) certificate, add the following parameters to the `boot.db.properties` file that is located in the `config` folder, in the Automation Anywhere installation path.

- Windows file location:

```
root:\Program Files\Automation Anywhere\config\boot.db.properties
```

- Linux file location:

```
/opt/automationanywhere/enterprise/config/boot.db.properties
```

Parameter:

```
trustServerCertificate=false
```

Add Control Room certificate to Windows certificate stores

Manually add or update the Control Room certificate to the Windows certificate stores to ensure that the Bot Agent is registered successfully and works as intended. Perform this task if the Windows certificate stores does not accept the certificate and you see a certificate path validation error.

You must reinstall the certificates in the Windows certificate stores if the Bot Agent is updated.

To resolve the certificate on the browser of the Bot Agent machine, download and install the certificate.

1. To download the certificate using Google Chrome, perform these steps:
 - a) Open the Control Room instance used to access the Bot Agent.
 - b) Press the function key F12 to open the developer window.
 - c) Navigate to the **Security** tab and click the **View certificate** option.
The **Certificate Viewer** window appears.
 - d) In the **Details** tab, click the **Export** option.
 - e) Select a Base-64 encoded option from the Save as type drop-down list.
 - f) Save the file to a location of your choice.

2. To import the certificate, perform these steps:
 - a) Open a command window.
 - b) Enter `MMC` to launch the console window.
 - c) Select the **Add/Remove Snap-in** option from the **File** menu.
 - d) Double-click **Certificates** option and then select **Computer account** in the **Certificates snap-in** window.
 - e) Click **Next** and select the **Local Computer** option in the **Select Computer** window.
 - f) Click **Finish**.
 - g) Click **OK** to return to the console window.

3. Now add the certificates to the **Trusted Root Certification Authorities** and **Trusted Publishers** folders.
 - a) Double-click the **Certificates** name.
 - b) Right-click the **Trusted Root Certification Authorities** name.
 - c) Select the **Import** option from the **All Tasks** menu.
The **Certificate Import Wizard** is launched.
 - d) Click **Next**.
 - e) Click **Browse** and select the certificate that was saved.
 - f) Click **Next** and select the option to place all certificates in a store.
 - g) Click **Next** and click **Finish** to import the certificates.
The certificate is imported successfully.
 - h) Repeat the above steps to import certificates in the **Trusted Publishers** folder.
The console window now shows the certificates imported for current user.

4. Restart the Bot Agent device to validate that the device is registered successfully.

For more information on troubleshooting steps, see [Automation 360: Error while registering device - An unexpected problem occurred \(A-People login required\)](#).

Preparing for users

After completing initial installation and depending upon your deployment option, the post-installation configuration and validation, you are ready to prepare for users to login and work with bots.

See [Users](#).

Trial licenses

Automation Anywhere Control Room trial License comes with an evaluation period of 30 days. This provides the user with an ability to assess the product and make an informed decision.

Trial licenses offer three *Bot Creators* and two *Bot Runners* to begin with; also a user can contact System Administrator or Automation Anywhere Sales to purchase a new license or extend the existing trial license.

To purchase an extended license or to install a new license:

1. Login to Control Room as an Admin and the Dashboard homepage is displayed.
2. A notification is displayed with remaining days for license expiry. Click **Show details**. A message appears with a link to **Install a new license** or to **contact System Administrator or Automation Anywhere Sales**

To view bot license and usage statistics, go to **Administration > Click Licenses**.

Note: Product and bot user license statistics is only visible to users with Admin role and users with License management permission,

The License page shows Product and bot User license statistics with details.

Set up SAML authentication

Switch an authenticated environment Control Room database to a SAML identity provider (IdP).

Note: SAML integration is irreversible. After it has been established, you cannot modify the configuration.

Ensure that you are logged in to the as the administrator.

Before you set up authentication for the Control Room, setup tasks (such as introducing credentials on a new system and importing users) might be required. If you import users, then you must also include matching user IDs, email addresses, first and last names, in both the Automation Anywhere credentials and matching records to log in after the SAML integration. For example, if using Okta as a SSO, then users must have matching IDs, email addresses, first name and last names in both Automation Anywhere and Okta to log in after the SAML integration.

You should have the required user information and certificate ready. Typical user information consists of user ID, first and last name, and an email address.

Note: You must validate the SAML IdP setup before you configure the Control Room. See [Configure the Control Room as a service provider](#).

After switching to SAML authentication environments, any users with non-SAML IdP formatted IDs will not be able to log in. You need to verify that any bots located in their private folders are exported so they can be imported back against their new user accounts.

Much of this configuration relies on third-party applications to create the necessary metadata. If you require more specific configuration information based on a specific provider, see [Configure SSO authentication with Okta](#).

To switch the Control Room to a SAML-authenticated environment, follow these steps.

1. Navigate to **Administration > Settings > User authentication**.
 2. Select the **Use SAML** option.
-

Note: The **Use Control Room database** option is selected by default.

3. In the **Unique Entity ID for Control Room (Service Provider)** field, enter the entity ID.
4. In the **Encrypt SAML Assertions** field, select one of the following options:

Option	Description
Do not encrypt	SAML assertions are not encrypted.
Encrypt	SAML assertions are encrypted.

5. Optional: Enter the **Public key** and **Private key** values.

Note: Enter keys only if you require encrypted SAML assertions.

6. Click **Validate SAML Settings**.

The Control Room will log in through the SAML provider and redirect back to the **Control Room User Authentication** page.

When you click this option, you will be redirected to a SAML 2.0 service provider web page where you will be prompted to enter credentials and other data.

7. Log in to your provider when prompted.
8. Click **Save changes**.

Related tasks

[Configure the Control Room as a service provider](#)

A valid SAML IDP setup must be configured before the Control Room can be switched to a SAML-authentication environment.

Configure SSO authentication with Okta

To log in after SAML integration, configure Single Sign-On (SSO) authentication with Okta as identity provider (IDP).

Note: Okta is a third party and might update their user interface (UI) anytime. Hence, the Okta UI references and images here are indicative and meant only for basic guidance.

Ensure that the following requirements are fulfilled:

- The Control Room is a secure environment.
- A secure Automation 360 Cloud tenant is used.

1. Create a user in Okta and an admin account in Automation 360.

Note: The user must be created with the same *User ID*, *First Name*, *Last Name*, and *Email Address*. You might need to use email address for *User ID*. During testing, only email address is allowed in Okta.

2. Generate an SSL certificate with private and public keys.
These keys are required to encrypt the communication between Okta and Automation 360.
3. [Create app integration](#).
4. [Assign application to the user](#).
5. [Configure the Control Room](#).
6. [Validate the connection](#).

Create app integration

Configure Okta on a system before you import users and perform other setup tasks. Create SAML integration in Okta and set the advanced settings and attributes.

When you import users, ensure that they have a matching user ID, email address, first name, and last name in both Automation 360 and Okta to log in after the SAML integration.

1. In Okta, navigate to **Applications** and click **Create App Integration**.

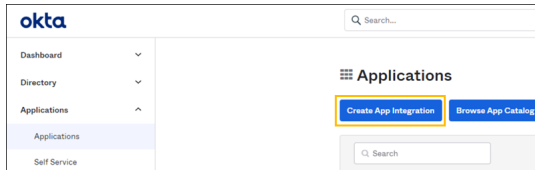

2. Select the **SAML 2.0** sign-in method and click **Next**.
3. In the **App name** field, enter the name of the app and click **Next**.

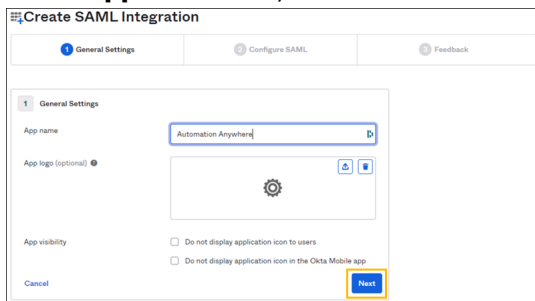

4. Enter the **Single sign-on URL**.
It is the Assertion URL on the Control Room in the `<CRURL>/v1/authentication/saml/assertion` format.
5. Enter the **Audience URI**.
This can be any word or phrase (no spaces). Make note of this term to use in the Control Room configuration.
6. Click **Show Advanced Settings**.
7. In the **Advanced Settings** section, select the **Assertion Encryption** as **Encrypted**.
8. For **Encryption Certificate**, click **Browse files** and select the public key certificate that you generated.

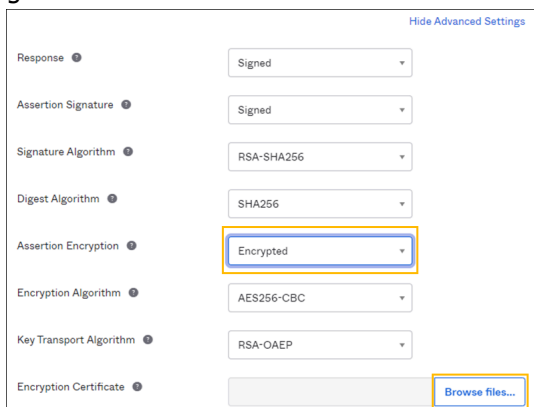

9. Scroll down to the **Attribute Statements** section and enter attributes, and then click **Next**.

Name	Name format (optional)	Value
FirstName	Unspecified	user.firstName
LastName	Unspecified	user.lastName
EmailAddress	Unspecified	user.email
UserID	Unspecified	user.login

[Add Another](#)

10. Select the appropriate option to notify whether you are a customer or a vendor, and then click **Finish**.

Edit SAML Integration

General Settings | Configure SAML | **Feedback**

3 Help Okta Support understand how you configured this application

Are you a customer or partner?

I'm an Okta customer adding an internal app

I'm a software vendor. I'd like to integrate my app with Okta

Submit your app for review

Finish

11. Scroll down and click **View Setup Instructions**.

SAML 2.0

Default Relay State

Encryption Certificate: certificata.pem (CN=)

SAML 2.0 is not configured until you complete the setup instructions.

[View Setup Instructions](#)

Identity Provider metadata is available if this application supports dynamic configuration.

Credentials Details

Application username format: Okta username

Update application username on: Create and update

Update Now

Password reveal: Allow users to securely see their password (Recommended)

The **Identity Provider metadata** field at the bottom is used in the Control Room configuration.

Assign application to user

Assign application to user

After the application is created, assign it to the user.

1. In Okta, navigate to the **Applications > Assignments** tab.

2. Click **Assign** and select **Assign to People**.

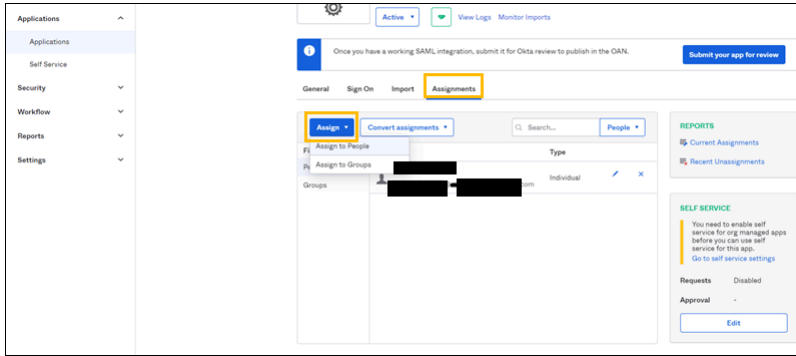

3. Click the **Assign** link that is next to the required user and confirm the assignment, and then click **Done**.

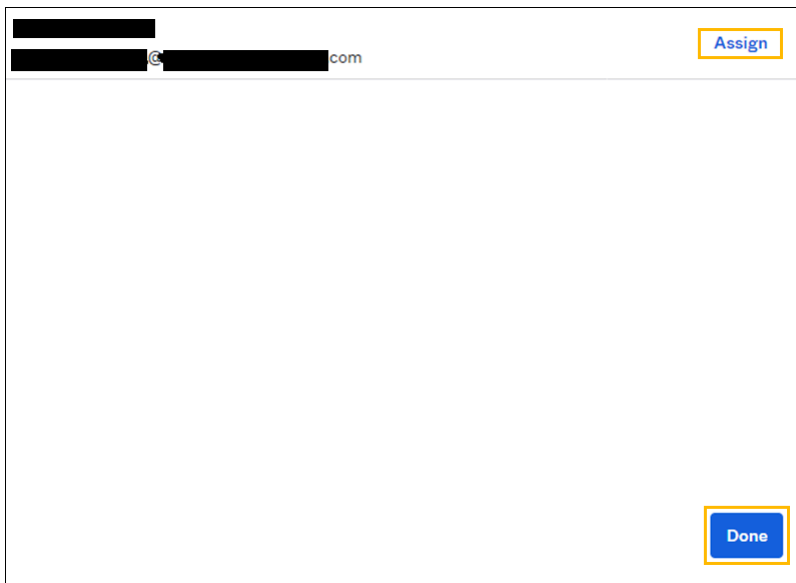

Configure Control Room for Okta user

Configure Control Room for Okta user

After the application is assigned to the user, configure the Control Room for the user assigned in Okta.

1. Log in to the Control Room as the same user configured in Okta (*User ID as Email address* on both systems).
2. Navigate to **Administration > Settings > User authentication**.
3. Select **Use SAML**.

Note: **Use Control Room database** is selected by default.

4. In the **Unique Entity ID for Control Room (Service Provider)** field, enter the entity ID.
5. In the **Encrypt SAML Assertions** field, select one of the following options:

Option	Description
Do not encrypt	SAML assertions are not encrypted.
Encrypt	SAML assertions are encrypted.

6. Optional: Enter the **Public key** and **Private key** values.

Note: Enter the keys only if you require encrypted SAML assertions.

Validate the connection

Validate the connection

After the Control Room is configured, validate the SAML settings.

1. Click **Validate SAML Settings**.

The Control Room will log in through the SAML provider and redirect back to the **Control Room User Authentication** page.

When you click this option, you are redirected to a SAML 2.0 service provider web page where you are prompted to enter the credentials and other data.

2. Log in to Okta when prompted and click **Save changes**.

Edit profile

Manage user profiles.

For users of Control Room configured with a non-directory environment, change the password, first name, last name, and email address.

1. Click the Device icon and select **Update credentials**.

In the Control Room panel, click your username and select the **My settings** link.

2. In the **Device login credentials** section, enter the **Username** and **Password** for the device.

In the **My profile** section, click **Edit**.

Device login credentials are required to run a bot from this device.

Note: Automation 360 does not validate the device login credentials until you run a bot.

If your username is part of a domain, include the domain within the format `domain\username`. Typically, home users are not part of a domain, unless they are specifically configured.

If your username contains non-ASCII characters, ensure your system locale settings are configured to use these characters.

Configuring post-installation settings

3. Enter information for general details, contact info and change password.

4. Click **Update**

Save the changes.

Installed Control Room directories and files

When installing the Automation Anywhere Control Room on different operating systems, the installer executes and installs files and folders in the following directories.

Window OS directory structure

When you install the Automation Anywhere Control Room on Windows OS, the default installation directory for many configuration files is located:

C:\Program Files\Automation Anywhere\

Linux OS directory structure

When you install the Automation Anywhere Control Room on Linux OS, the installer creates the following directories.

Directory path	Description	Comments
/opt/automationanywhere/automation360	All binary files	
/opt/automationanywhere/automation360/config	Config files	
/var/log/automationanywhere/automation360	Log files	
/tmp	Temporary files	Directory that contains temporary files created by the system and users. Files under this directory are deleted when the system is rebooted.
/opt/automationanywhere/automation360/appdata/Server Files	Server files	Control Room repository folder.
/opt/automationanywhere/automation360/_Automation 360_installation/Logs	Installer logs	Installation logs provide details about issues during installation, if any.

Configuration files

Note: Automation 360 supports UTF-8 file encoding type. When you edit or create any Bot Agent or Control Room configuration file, ensure to use UTF-8 file encoding type.

The minimum installed configuration files include:

- Installation license keys - Request the installer and appropriate license keys from your account manager.
- Bot Creator schedules configuration files
 - Log file name: logging.properties
 - Log file location: <install_location>\config
- Auto-login configuration files
 - Configuration file name: autologinhelper-logging.xml
 - Configuration file location: C:\Program Files\Automation Anywhere\Bot Agent\config

- Device configuration files
 - Configuration file name: `settings.properties`
 - Configuration file location: `<install_location>\config`

- Database configuration files

The database connection string is configured in:

- Configuration file name: `boot.db.properties`
- Configuration file location: `<installation_location>\config`

Additional configuration files that are created as needed, include:

- Cluster configuration
 - Configuration file name: `cluster.properties`
 - Configuration file location: `<installation_location>\config\`
- Key distribution center (KDC)
 - Configuration file name: `um.properties`
 - Configuration file location: `<installation_location>\config\`
- Parallel repository tuning
 - Configuration file name: `boot.server.properties`
 - Configuration file location: `<installation_location>\config\`
- Remote Desktop Protocol (RDP)
 - Configuration file name: `deployment.properties`
 - Configuration file location: `<installation_location>\config\`
- URL resources
 - Configuration file name: `DWMP_CONNECTIONS.properties`
 - Configuration file location: `<installation_location>\DWAService\bin\src\main\resources`
- Trusted list restrictions
 - Configuration file name: `repository.properties`
 - Configuration file location: `<installation_location>\config\`
- Workload management
 - Configuration file name: `wlm.properties`
 - Configuration file location: `<installation_location>\config`

Control Room fail-safe status

The Control Room connects to the Automation Anywhere Cloud license server and obtains license entitlements based on the license key that is installed on the Control Room.

A Control Room can enter the fail-safe mode in one of the following scenarios:

1. When the Control Room cannot connect to the license server, it moves into the fail-safe status.

- When the licenses are oversubscribed on the Control Room, the Control Room moves into the fail-safe status.

With respect to the Control Room license server database, the Control Room is in one of three states. These states indicate what user licensing actions can be performed. With each state change, an entry is made in the audit log.

Active

Normal operations. All API calls from the Control Room are accepted by the license server.

Users can be assigned floating licenses as they log on. Floating licenses can be released as users log off.

When the Control Room is restarted and operational, and connectivity to the license server is established, the Control Room is in the Active state:

- Users who had licenses assigned prior to the fail-safe have their original licenses reallocated.
- New users can request for and be allocated licenses.

Fail-safe

Only the heartbeat API call is allowed to the license server. All other calls from the Control Room are stopped.

- Fail-safe entry threshold:** If the license does not receive the heartbeat from the Control Room for 48 hours, then the license server considers that the Control Room is running in the fail-safe mode. This 48-hour period is called the fail-safe entry threshold.

Fail-safe-expired

The Control Room stops all operations, and all users are logged out of the Control Room.

- Fail-safe expiry threshold:** After the license server moves a Control Room into fail-safe mode, it waits up to 30 days to reinstate the license. After 30 days, the status is changed to **Suspended**, and you need to connect to technical support to restore the Control Room to fail-safe mode.

	Fail-safe entry		Fail-safe expiry	
	Due to loss of connectivity	Due to license overconsumption	Due to loss of connectivity	Due to license overconsumption
Days	Two days after loss of connectivity	Two days after overconsumption	30 days from fail-safe entry	30 days from fail-safe entry

	Fail-safe entry		Fail-safe expiry	
	Due to loss of connectivity	Due to license overconsumption	Due to loss of connectivity	Due to license overconsumption
Reason	Loss of connectivity/ license server down	License overconsumption If user licenses are consumed more than allocated, the Control Room displays a message showing the overconsumption. You will see a message similar to the following image until the overconsumption issue is solved.	Loss of connectivity/ license server down	License overconsumption. (Consumption is more than purchased license count.)

! Important - License over consumption identified

This is due to the following reasons:

- 1 Bot Creator licenses over-consumed.
- 1 AARI User licenses over-consumed.

Control Room licenses are over consumed. Control Room will not be available for further operations if the licenses are not released. It is recommended that you release licenses, and re-sync licenses from Server.

	Fail-safe entry		Fail-safe expiry	
	Due to loss of connectivity	Due to license overconsumption	Due to loss of connectivity	Due to license overconsumption
Remedy	Restore connection	Release overconsumed license and sync license with LS or renew the licenses overconsumed. <ul style="list-style-type: none"> You can remove the extra licenses associated with users and resync with the license server by clicking Sync license from server. 	Restore connection	<ol style="list-style-type: none"> 1. Renew the overconsumed license. 2. Raise support ticket to restore fail-safe entry, and then release the overconsumed license and sync data with license server.

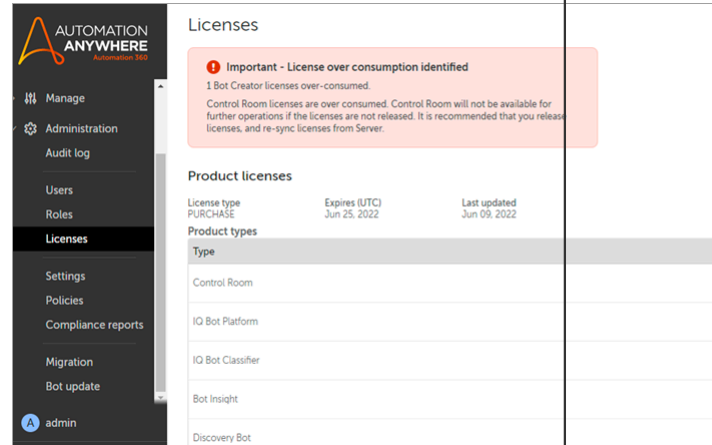

	Fail-safe entry		Fail-safe expiry	
	Due to loss of connectivity	Due to license overconsumption	Due to loss of connectivity	Due to license overconsumption
Possible operations	<ol style="list-style-type: none"> 1. Only license allocation and deallocation is allowed. The data is later synced when connectivity is restored. 2. Both admin and non-admin users are able to log in. 3. Banner is shown when you log in, along with error message on the license page. 4. RPA operations continue normally. 	<ol style="list-style-type: none"> 1. All license operations are allowed 2. Both admin and non-admin users are able to log in 3. Banner is shown when you log in along with error on license page, along with license overconsumption error on license page. 4. RPA operations continue normally. 	<ol style="list-style-type: none"> 1. Only admin user can log in. Non-admin users cannot log in. 2. No license operations are allowed 3. Banner is shown when you log in along with error message on license page. 4. RPA operations cannot continue. 	<ol style="list-style-type: none"> 1. Admin can log in and install licenses. 2. No license operations are allowed 3. Banner is shown last day before the Control Room shuts down along with overconsumption error on license page 4. RPA operations cannot continue.

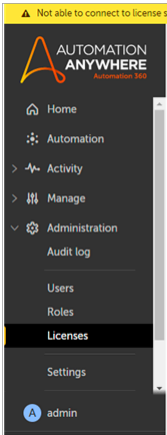
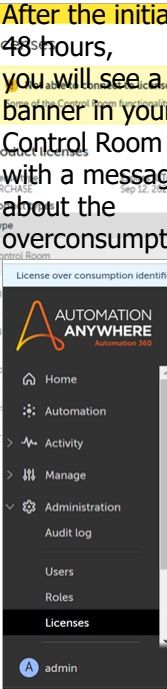
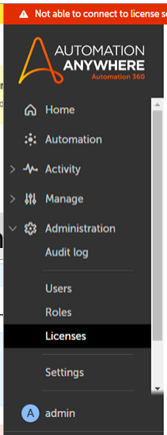
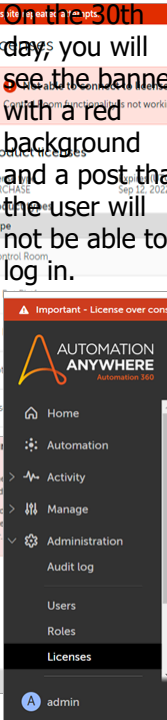
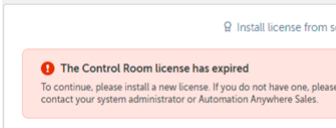
	Fail-safe entry		Fail-safe expiry	
	Due to loss of connectivity	Due to license overconsumption	Due to loss of connectivity	Due to license overconsumption
Notifications	 <p>After the initial 48 hours, you will see a banner in your Control Room with a message about the overconsumption.</p>			 <p>On the 30th day, you will see the banner with a red background and a post that the user will not be able to log in.</p>
				 <p>After the 30th day, you will not be able to use the Control Room. You will see a screen similar to the following:</p>

See also

- [Automation 360 licenses](#)
- [Licenses and cloud services](#)
- [Control Room license expiry notifications](#)

Licenses and cloud services

The Licenses and Cloud Services portal enables you to manage the licenses, Cloud Control Room instances, and cloud RPA services linked to your account. As an Automation Anywhere customer or partner, and an

RPA, Control Room, or IT administrator, you need to manage your entire IT asset framework efficiently to realize the value of your investments.

The main functionalities provided by the Licenses and Cloud Services portal are **license management** and **cloud services management** for customers and partners.

Customers can perform the following tasks through this portal:

- Provision and manage their cloud services.
- Get details about the globally unique identifiers (GUIDs) of the licenses served from the license cloud.
- Configure and download their license files (where applicable).

Partners can perform the following tasks through this portal:

- Provision and manage their cloud services and their customers' cloud services.
- Get details about their own and their customers' cloud license GUIDs served from the license cloud.
- Configure and download license files for themselves and their customers.

Overview

To efficiently use and manage their environments, IT and RPA administrators require visibility into license entitlements and a real-time view of available and used licenses. Also, these administrators require visibility into the purchased cloud services and service instances to efficiently manage the RPA requirements of their organizations. The portal helps these users gather this data and view and manage licenses and cloud services.

Accessing the portal

You can access the Licenses and Cloud Services portal on the A-People site. You must have an account on A-People, and you must be assigned as a designated portal user as part of the sales process.

1. Log in to A-People using your login credentials: [A-People home page \(login required\)](#)
2. Click the **License and Cloud Services** tab.

Alternatively, navigate directly to this page by clicking the link provided in the welcome email.

License management

You can manage the following types of product licenses through the Licenses and Cloud Services portal:

Cloud licenses

Software license entitlements that are distributed and governed by the Automation Anywhere cloud license server. The Control Room connects to the Automation Anywhere cloud license server and obtains license entitlements based on the license key that is installed on the Control Room.

The license key is in the form of a GUID and is made available on the portal. Automation 360 Cloud and On-Premises Control Room instances that have access to the cloud license server can use the cloud licenses.

File licenses

File licenses are mainly used for Automation Anywhere Enterprise 11 and Enterprise 10 versions and for some Automation 360 On-Premises Control Room deployments. One license file per Control Room can be generated from the portal and manually installed on the Control Room.

Customers and partners can perform the following tasks related to licenses:

- View all the license entitlements and get details of purchased and available licenses and subscription terms (license start and end dates).
- Configure and download the license files as needed.
- View all the license entitlements and get details of GUIDs for cloud licenses.
- As a partner, you can view and manage license entitlements for your company as well as for your end customers.

Cloud services management

Use the Licenses and Cloud Services portal to manage the following types of Cloud Control Room services:

- Pure Cloud Control Room
- Pure Cloud Sandbox Control Room
- Cloud-enabled Control Room
- Cloud-enabled Sandbox Control Room
- Cloud Control Room Migration

Pure Cloud Control Room and pure Cloud Sandbox Control Room instances have to be explicitly provisioned by the Customer License User (CLU) on demand when the customer is ready for consuming the cloud service.

Cloud-enabled Control Room and Cloud-enabled Sandbox Control Room instances are automatically provisioned by the Licenses and Cloud Services portal, providing the CLU user with a token required to install the Cloud-enabled Control Room on their infrastructure.

Customers and partners can perform the following tasks related to cloud services:

- View an inventory of all the Cloud Control Room subscribed services, with a visual display of configuration parameters associated with the cloud service.
- Perform on-demand provisioning of cloud services, such as Cloud Control Room and IQ Bot. This helps in real-time provisioning of your services.
- Access and manage ordered Control Room services.
- Migrate production and QA Control Room services.

Managing Cloud and file licenses

The Licenses and Cloud Services portal includes the following main tabs: Manage File Licenses, Manage Cloud Licenses, Cloud Control Room Instances, and Partner Drawdowns.

Manage Cloud Licenses

The tab provides customers and partners visibility into all Cloud-based license entitlements and the license keys (GUID) to be applied to all customer Control Room instances.

For Automation 360 On-Premises, a designated user can obtain the Control Room GUID from this tab and paste it into their respective Control Room instance. Please refer to [Installing additional licenses](#).

Note: For first-time Automation 360 Cloud customers, this tab is only informational because when a Cloud Control Room is provisioned for the first time, the GUID is already applied to their Control Room instance.

<https://automationanywhere.wistia.com/medias/yuuiynythnh>

Manage File Licenses

The **Manage File Licenses** tab provides customers and partners the visibility to all file-based license entitlements available. Designated license users can configure a license file for each of their Control Room instances with the necessary entitlements. Please refer to [Manage licenses](#) and [Installing additional licenses](#) for more information.

The steps below offer guidance to the licensing process for Automation 360 and Enterprise 11.

1. In the Control Room list view, click the Control Room name available as a hyperlink.

The hyperlink redirects you to the license configuration page, where you can select the entitlements you want to add to the Control Room and save and generate a license file.

Note: The portal takes a few minutes to generate the file.

2. Use the **Refresh** option to see whether the license file is generated.

After the Control Room status changes to **Active**, you can click the Control Room name again and download the file.

3. Based on your business requirements, reconfigure license files at any point of time from the same tab.

You can only configure entitlements that are in **Available** status. If all the entitlements are used in your license files, you need to reconfigure a file to release entitlements and make them available to be added to a different license file.

Please refer to these videos for more information:

<https://automationanywhere.wistia.com/medias/ft4zq01ad6>

<https://automationanywhere.wistia.com/medias/015190nebg>

For partners, the page displays an additional drop-down list, which enables you to switch context between multiple customers that you are managing. The page provides a similar view, with an additional drop-down list, which enables partners to switch the context between various customer entitlements.

Automation 360 licenses

The **All Licenses** page displays detailed information about current product and device licenses.

Product licenses

The Automation Anywhere Control Room is the web-based application at the center of the Digital Workforce providing enterprise-wide management and control. The Control Room ensures reliable, scalable, and secure bot deployment and execution. From this central vantage point, operators can receive tasks from the Bot Creator and push to the Bot Runners for execution with simple mouse clicks. The Control Room monitors and audits all scheduled and running bots, in real time.

The Control Room provides an automated mechanism for tracking and controlling the use of licensed software across Bot Creators and Bot Runners, addressing NIST Change Management CM-10.

Device licenses

The device licenses section shows the number of licenses purchased, used, and available. If the licenses are added to the Control Room from the Cloud, the Licenses page also shows the number of pages processed in other Control Room instances.

License	Permission
Bot Creator	<p>Users with this license can create, edit, schedule, and trigger bots. Additionally, these users can run bots in the following ways:</p> <ul style="list-style-type: none"> • On their local machine • From the public workspace if the Control Room administrator has specified a Run as user for unattended Bot Runner
Unattended Bot Runner Run-time license	<p>Users with this license can perform all automation tasks that attended users can perform. Additionally, this license can also be used for Automation Anywhere Control Room deployment, centralized scheduling, and API-based deployment.</p> <hr/> <p>Note: Among all the triggers, you can associate any trigger only with a user who has a Bot Runner license. Also, for a user with unattended Bot Runner license, if you associate triggers such as Hot key, Interface, or Window, the following conditions apply:</p> <ul style="list-style-type: none"> • The default device must not be in the logged-off or locked state. • The user must be logged in to the device to perform the predefined task that can trigger the bot. <hr/>
Attended Bot Runner Run-time license	<p>Users with this license can run bots on their devices. However, these users cannot run or schedule bots on another device.</p>
Citizen Developer license	<p>Users with this license can create and run bots (including bots with triggers) on their devices.</p> <p><i>Create a Citizen Developer role</i></p>
IQ Bot pages (Number of pages)	<p>This license is required for uploading documents to Automation 360 IQ Bot.</p>
Standard Forms pages (Number of pages)	<p>This license is required for uploading documents for processing in standard forms.</p>
Document AI (Number of pages)	<p>Enables Document Automation users to process documents in Google Document AI.</p> <hr/> <p>Note: This metric is visible only to customers who purchased Google Document AI licenses through Automation Anywhere.</p> <hr/>

License	Permission
Document Automation Standard Forms (Number of pages)	This license is required for processing documents in standard forms in Document Automation.
Document Automation 360 Extraction (Number of pages)	This license is for processes documents in an Automation Anywhere (Pre-trained) model, including the User-defined document type.
IQ Bot Classifier	Users with this license can upload documents to the Classifier, where the documents are sorted into document groups, which improves extraction accuracy.
Bot Insight	Bot Insight provides real-time, RPA native analytics for both business insights and operational intelligence. The Bot Insight license is purchased on a per-user basis. To access the Business dashboard, the user must be assigned this license.
Automation Anywhere Robotic Interface	The Control Room can combine the AARI user license with the Bot Creator and Bot Runner (attended and unattended) license types, which enables the user to access AARI on the web.
Discovery Bot	Process Discovery licenses must be purchased for use for business analysts and business users using Discovery Bot. Discovery Bot supports two licenses. The business analyst uses the process analyzer license to view and manage the metadata from all recordings within the process. The business user uses the process recorder license to view, record, and submit a process using the Discovery Bot recorder.

RBAC on License Management

Access to License Management is deny-all and allow by exception based on roles and domains as defined in RBAC. Only those users who have access to License Management permission can view the entitlement details from the Automation Anywhere Control Room.

Baseline inventory controls: Bot Creators, Bot Runners, and Bots

The Automation Anywhere Control Room manages all automation operations. Inventory controls are maintained through the application of RBAC to establish a single point of control for Base Line Configurations (NIST CM-2), access restrictions for configuration management (NIST CM-5 and 6). Automated baseline reporting can be configured.

Licensing in high availability and disaster recovery

The license information that is centrally stored in the database or license cloud, is shared within High Availability clusters and across Disaster Recovery sites because synchronous data replication is configured between multiple Control Room servers.

HA and DR deployment models

Related tasks[Installing additional licenses](#)

Upload new licenses to the Automation Anywhere Control Room to be distributed to users as required.

Related reference[Control Room license expiry notifications](#)

The Automation Anywhere Control Room license expiry notifications appear when the Control Room license is about to expire.

Accessing Automation 360

Any new customer who orders our products receive license confirmation from Automation Anywhere.

The designated person responsible for configuring licenses for their company receives two email confirmations.

The **SSO** email from sso@automationanywhere.com grants you access to set up a new password for your Automation Anywhere Single Sign-On (SSO) account. The **Orders** email from orders@automationanywhere.com grants you access to your license entitlement information.

Do the following:

1. Open **SSO** email → access link.
2. Enter and confirm new password.
3. Access **A-People Community**.
4. There are two options to access your license entitlements.

Option	Action
A-People	Navigate to LICENSES .
Orders email	Access link to redirect to license page.

Note: Your license entitlement validation date is provided within the context of the **Orders** email and on the A-People License configuration page.

5. You now have access to your license entitlements.

On this page, you have access to more information of your order. The **Product Versions** shows your current license entitlement version, the **License Entitlements** shows the number of license entitlements in your order, and the **Control Rooms** shows the number of control rooms in your order, and allows to configure each licenses.

Provision Cloud Control Room instances

You can access, view, provision, and edit all the purchased Cloud Control Room instances. If required, you can also purchase and provision the IQ Bot services later.

Use the Licenses and Cloud Services portal to provision Cloud Control Room and Cloud sandbox Control Room instances on demand. Cloud-enabled Control Room instances are automatically provisioned by the portal.

Customers can provision their own Cloud Control Room instances, and partner users can provision Cloud Control Room for themselves and their customers.

1. Log in to A-People using your login credentials: [A-People home page \(login required\)](#).
2. Click the **Licenses and Cloud Services** tab.
3. On the navigation pane on the left side, click the **Cloud Control Rooms Instances** tab to display a list of provisioned and unprovisioned Cloud Control Room instances for the different types of Cloud Control Room instances.

The inventory view displays the different parameters about provisioned Cloud Control Room instances, such as domain name, Control Room URL, and the region from where the Control Room is hosted. Use the region name to subscribe to maintenance notifications on `status.automationanywhere.digital`.

4. In the **Control Room Name** field, enter a name.

5. In the **Cloud Control Room Domain Name** field, enter a domain name.

The domain name must be a unique name that will be part of your Cloud Control Room URL. The portal checks and validates the uniqueness of the domain name across the system.

Consider the following examples for domain names:

- Example URL for Cloud Control Room: `https://<domain-name>.my.automationanywhere.digital`
- Example URL for Cloud sandbox Control Room: `https://<domain-name>.cloud#.automationanywhere.digital`

Note: After provisioning is done, the domain name for a Cloud Control Room cannot be changed.

6. Select an **Environment** option.

The options are **Production**, **Development**, and **UAT**. By default, for sandbox Control Room, only the sandbox option is displayed here.

7. Select the **Country** from where most of your users will access this Control Room.

Based on the country you select, your Cloud Control Room will be hosted from a region that is nearest.

Note: After provisioning is done, the **Country** for the Cloud Control Room cannot be changed.

8. Select your **Region**.

Note: After provisioning is done, the **Region** for the Cloud Control Room cannot be changed.

9. Select and specify the Cloud Control Room administrator.

You can either select from existing customer contacts or create one. If you are creating a user, enter details such as first name, last name, and email address.

10. Optional: If your account is entitled for IQ Bot service, you can register for IQ Bot by selecting the check box.

11. Click **Save** to provision the Cloud Control Room instance.

The Cloud Control Room instance is automatically provisioned, and the Control Room status changes from **Provision** to **Provisioning in-Progress**. Provisioning takes some time to complete. When provisioning is complete, the status changes to **Provisioning Complete**.

Self-service Control Room Migration

Manage the migration provisioning process with self migration capabilities and the flexibility to choose manual or automated migration.

To perform this task, you must be a administrator and have the required rights and permissions.

Complete the Cloud Migration Control Room setup before provisioning an IQ Bot server with the Control Room, if proper entitlement is licensed.

Note: Migration is currently not supported on GCP.

- 1.** Log in to A-People using your login credentials: [A-People home page \(login required\)](#).
- 2.** Click the **Licenses and Cloud Services** tab.

3. On the navigation pane on the left side, click the **Cloud Control Rooms Instances** tab to display a list of provisioned and unprovisioned Cloud Control Room instances for the different types of Cloud Control Room instances.

The inventory view displays the different parameters about provisioned Cloud Control Room instances, such as domain name, Control Room URL, and the region from where the Control Room is hosted. Use the region name to subscribe to maintenance notifications on status.automationanywhere.digital.

4. In the **Control Room Name** field, enter a name.

5. Select the type of migration.

- Automation Migration with Migration Utility. For more information, see [Install Cloud Migration Utility](#).
- Manual Migration. You will get a new Cloud Control Room to work with.

6. In the **Cloud Control Room Domain Name** field, enter a domain name.

The domain name must be a unique name that will be part of your Cloud Control Room URL. The portal checks and validates the uniqueness of the domain name across the system. Consider the following examples for domain names:

Example URL for pure Cloud Control Room: `https://<domain-name>.my.automationanywhere.digital`

Example URL for pure Cloud Sandbox Control Room: `https://<domain-name>.cloud#.automationanywhere.digital`

7. Select an **Environment** option.

The options are **Production**, **Development**, and **UAT**. By default, for Sandbox Control Room, only the Sandbox option is displayed here.

8. Select the **Country** from where most of your users will access this Control Room.

Based on the country you select, your Cloud Control Room will be hosted from a region that is nearest.

Note: After provisioning is done, the **Country** for the Cloud Control Room cannot be changed.

9. Select you **Region**.

Note: After provisioning is done, the **Region** for the Cloud Control Room cannot be changed.

10. Select and specify the Cloud Control Room administrator.

You can either select from existing customer contacts or create one. If you are creating a user, enter details such as first name, last name, and email address.

11. To generate the migration code, click **Save**.

The **View** tab displays the migration code.

12. Copy the migration code to the **Cloud Migration utility**. This will export and import the data to Cloud.

Note: You can click the **View** tab for the following:

- View the migration code.
- Regenerate the migration code when the code is expired.
- Indicates that the Cloud Control Room is ready for use by displaying the user credentials.
- Displays the status of the Cloud Control Room during the migration process.

Note: During the migration process, you can view the stages of migration: New, Consumed, Expired, Renewed, or Complete.

Viewing the Cloud Migration Control Room Details

In addition to the other details shown for regular Cloud Control Room, this page displays the migration code to be used by the migration utility.

View Cloud Migration Control Room Details

Users who trigger the provisioning and administrators of the Cloud Migration Control Room receive an email with instructions on how to get the migration code, how to install the migration utility, and how to start the migration process.

Here is some additional information regarding this process, related to **Migration Status**, **Migration Code**, and **Migration Code Expiry Date**.

Following are the important details to track from this page for Administrators:

Migration Status	Displays the current status of the migration
Migration Code	The necessary code required to complete the migration process
Migration Code Expiry Date	If the expiry date for the code has lapsed, you must generate a new migration code for application.

Manage and allocate licenses (partners)

Automation Anywhere partners can manage and process Licenses and Cloud services.

Partners can manage their and their customers entitlements from the portal. Partners access the Licenses and Cloud portal in the following ways:

- Purchases Automation Anywhere licenses for their own use.
- Participates in a customer purchases Automation Anywhere licenses through the partner.
- Partner draws down from their own license entitlements and allocates some portion of the entitlements to a customer.

Use the **Select an Account** to switch entitlements via the drop-down list. Partners can view license entitlements, configure licenses (file-based licensing), view Control Room GUIDs (cloud-based licensing), and view and manage provision ready cloud services (Control Room, IQ Bot server).

<https://automationanywhere.wistia.com/medias/yuinythnh>

For information, see [Managing Cloud and file licenses](#).

Assigning a customer and entitlements

To draw down on entitlements and assign to a customer, perform the following tasks.

1. Log in to the A-People portal: [A-People home page \(login required\)](#).
2. Click the **Licenses and Cloud Services** tab, and navigate to the **Partner Draw downs** tab. An empty page is displayed when you log in for the first time. After a few requests have been processed, this page displays a list of draw-downs that you have processed.
3. To start a new draw-down process, click **New**.
4. From the **New Partner Draw Down Request** page, select an order from the drop-down list. You can draw down from only one order at a time.

5. Enter the required information in the following fields:
 - **Assign to customer account:** Customer account name
 - **Customer website:** URL to the customer's website
 - **Customer name:** Name of your customer contact
 - **Customer email:** Email address of the customer contact
6. After entering the customer information, generate a partner draw down request (PDR) by specifying a number for each of the products available.
7. Click **Save** to generate a new PDR.
The PDR is in submitted state.

First, generate the PDR, an email notification is sent to your accounts team for approval.

Once the PDR is validated and approved (or rejected), the partner who requested for the PDR will receive an email notification. The PDR requesting partner has to then navigate back to the portal to take appropriate action.

8. After approval, click **Accept**.
After acceptance, the license entitlements from the PDR are transferred from the partner to the customer. If the PDR is rejected, you can see the reason for rejection.

Note: If for any reason the draw down is no longer required, the partner can cancel the request at this point.

9. Clone the PDR if required, make the necessary changes and resubmit the PDR.

Partners can refer to the customer documentation for managing licenses and provisioning cloud services.

- For configuring file licenses, see [Configure new Control Room licenses](#).
- For provisioning of cloud services, see [Provision Cloud Control Room instances](#).

The Licenses and Cloud portal provides the partners with an automated way to process draw downs for their customers.

<https://automationanywhere.wistia.com/medias/ed7junxfc9>

View and edit Cloud Control Room instances

You can get a complete inventory view of all the Cloud Control Room instances and Migration Control Rooms that have been purchased and linked to your account. You can check their provisioning status, which can be Not Provisioned, Provisioning in progress, Provisioning complete, or Provisioning failed. You can provision these instances as and when required.

1. Log in to A-People using your login credentials: [A-People home page \(login required\)](#).
2. Click the **License and Cloud Services** tab to open the Licenses and Cloud Services portal.
3. On the navigation pane on the left side, click the **Cloud Control Rooms Instances** tab to display a list of provisioned and unprovisioned Cloud Control Room instances for the different types of Cloud Control Room instances.

The inventory view displays the different parameters about provisioned Cloud Control Room instances, such as domain name, Control Room URL, and the region from where the Control Room is hosted. Use the Region name to subscribe to any maintenance notifications on status.automationanywhere.digital.

4. Click the **View** option for any of the provisioned Cloud Control Room instances.
It opens the page with the details about the Cloud Control Room instances, such as name and domain name, provisioning status, service type (Pure Cloud, Cloud-enabled, Cloud Sandbox, and so on), license GUID, provisioning date, Cloud-enabled token, type of environment in which the instance is deployed, and cloud region where the instance is hosted.

5. Optional: On the displayed page, click **Edit** to change the Cloud Control Room name to a name of your choice.
6. If your account is entitled for an IQ Bot service, register for it by selecting the check box in the displayed page.
7. Click **Save** to apply the changes in the page.

Control Room license expiry notifications

The Automation Anywhere Control Room license expiry notifications appear when the Control Room license is about to expire.

When the Control Room license is about to expire, the administrator sees a visible banner notification on log in to the Control Room. The Control Room checks the license status daily. At 30 days before a license expiration date, a notification message is displayed in the Control Room with the number of days remaining for the license to expire. The banner is displayed every time the administrator logs in to the Control Room during the last 30 days before the Control Room license expiration. The severity of the banner notification becomes critical in the last seven days before Control Room license expiration. As the expiration date approaches, notifications become more persistent at the following countdown intervals:

- **30 days:** When a license is within 30 days of expiration, a dismissible notification appears in the Control Room banner and the message is displayed in the banner until the license is renewed or expired.

The screenshot shows the Automation Anywhere interface with a notification banner at the top stating "The Control Room license will expire in 18 day(s)". Below the notification, the "Licenses" page is visible, showing a table of product licenses. The table has columns for "License type", "Expires (UTC)", and "Last updated". The "Product types" section includes a table with columns for "Type" and "Purchased".

License type	Expires (UTC)	Last updated
PURCHASE	Jun 25, 2022	Jun 09, 2022

Type	Purchased
Control Room	Purchased
IQ Bot Platform	Purchased
IQ Bot Classifier	Purchased
Bot Insight	Purchased
Discovery Bot	Purchased
Automation Anywhere Robotic Interface (AARI)	Purchased

- **7 days:** When the approaching license expiration date is in seven days or less, a red banner appears showing the expiry date and a link to extend the license. This notification appears in the console until the service is extended or the 30-day expiration period elapses.

The screenshot shows the Automation Anywhere interface with a red notification banner at the top stating "The Control Room license will expire in 7 day(s)". Below the notification, the "Licenses" page is visible, showing a table of product licenses. The table has columns for "License type", "Expires (UTC)", and "Last updated". The "Product types" section includes a table with columns for "Type" and "Purchased".

License type	Expires (UTC)	Last updated
PURCHASE	Jun 14, 2022	Jun 09, 2022

Type	Purchased
Control Room	Purchased
IQ Bot Platform	Purchased
IQ Bot Classifier	Purchased
Bot Insight	Purchased
Discovery Bot	Purchased
Automation Anywhere Robotic Interface (AARI)	Purchased

- **0 days (expired):** After the license has expired, you will not be able to use the Control Room. You will see a screen similar to the following with a non-dismissible notification.

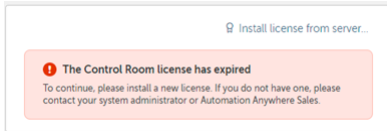

Note: In the SSO environment, if the option to install license is not displayed after the license has expired, clear the browser cache and refresh the browser. The install license option becomes visible.

See also

- [Automation 360 licenses](#)
- [Licenses and cloud services](#)
- [Control Room fail-safe status](#)

Get started with Community Edition

Use these tasks to register for, and start creating and using bots with the Community Edition of Automation 360.

1. Register for the Automation Anywhere Community Edition:
 - a) From the Automation Anywhere website <https://www.automationanywhere.com> scroll to and click the **Get Community Edition** option.
Alternatively, select **Customers & Partners > A People Community > Community Edition**. Scroll to the registration form: **GET COMMUNITY TODAY**.
 - b) Enter your identification information in the form that appears.
The form information includes your first name, last name, email, country, phone number, and company. This information is used to create your Community Edition user login credentials.

Restriction: Only the period/dot (.) and at sign (@) are allowed in the email field. No other special characters are supported.

 - c) Read and agree to the terms, privacy policy, and license agreement. Select and click **Submit**.
Wait for the email from Automation Anywhere that contains the information for you to log in to the Community Edition. The email includes the Community Control Room URL, your username, and assigned user password. After you log in, you are prompted to reset your password.
2. [Log in to Automation Anywhere Control Room](#).
To log in to Automation 360, open the Control Room URL in your browser, enter your credentials in the login screen, and click **Log in**.

3. Install the Bot Agent, register your device, and set user device credentials.

[Install Bot Agent and register device](#) | [Set user device credentials](#)

The Bot Agent is a lightweight application that enables you to run bots on your device by connecting the device to the Control Room. To run bots on a local machine, install the Bot Agent and add the local device to the list of enabled host devices.

To enable a device for running bots, set the local device credentials.

If you are using an operating system other than Windows, you will not be able to install the Bot Agent at this time. See [system requirements](#). However, you can still build bots using the [Bot editor](#).

4. [Create your first bot](#).

Follow these steps to create your first bot that prints the message, `Go be great!`, the Automation Anywhere version of `Hello World!`

5. [Run your first bot](#).

Run a bot from the same device that you used to create the bot.

Watch the following videos that illustrate some of the steps in this task:

- Installing the Bot Agent in Automation 360:
- Building your first bot:
- Running your first bot in the Community Edition:

Community capacity and limitations

Community users access and bot creation and running conditions.

Number of bots creators per Community Edition user

Each Community Edition user can use one Bot Creator at a time.

Number of bots created by Community Edition user

Each Community Edition user can create multiple bots.

Number of registered devices per Community Edition user

Each Community Edition user can register multiple devices, but only be logged in to one at a time, and only run a bot on one device at a time.

Number of bots run by Community Edition user

Each Community Edition user can run one bot at a time on any one registered device.

Export bots function for Community Edition user

Community Edition user cannot export bots from the Control Room.

Import bots function for Community Edition user

Community Edition user cannot import bots downloaded from the Bot Store to the Control Room.

Log in to Automation Anywhere Control Room

To log in to Automation 360, open the Control Room URL in your browser, enter your credentials in the login screen, and click **Log in**.

Receive your registration confirmation email.

- **Automation 360 users:** This is sent by your system administrator.
- **Community Edition users:**

1. Register for the Community Edition.

[Get started with Community Edition](#)

2. This is sent by Automation Anywhere using the information you provided when you registered.

This email contains:

- Control Room URL
- Username, credentials, and provisioning tokens (where applicable)
- Temporary password

Reset this password when you log in the first time.

Note: If you use the Microsoft Internet Explorer browser to log in to the Control Room, a notification banner is displayed indicating that support for Internet Explorer 11 is ending. Your Control Room will no longer be accessible on Internet Explorer. Starting from the Automation 360 v.25 release, you will be prompted to access the Control Room through an alternative supported browser, such as Google Chrome or Microsoft Edge (Chromium). Refer to the banner for details on how you can evaluate any potential impact to your existing automations. [Microsoft Internet Explorer 11 EOL FAQ](#)

1. Open the URL in your browser.

2. In the **Log in** form, enter your username and password.

If this is the first time you are logging in, use the password provided in your welcome email.

3. **First-time users:** Change your password. For Cloud users, create your security questions.

The change password and create security questions form automatically opens when you log in for the first time. Complete the form.

- a) Complete the **Change password** fields.

Enter your current password, enter your new password, and confirm the new password.

Passwords must be 8-15 characters long and can only contain the following characters: a-z, A-Z, 0-9, at sign (@), dash (-), underscore (_), exclamation point (!), number sign (#), dollar sign (\$), percent (%), ampersand (&), and period (.).

- b) **For Cloud users:** In each pair of question and answer fields, enter a question and an answer that you will remember if you forget your password or must confirm your login.

- c) Click **Save and log in**.

After the first login, to change the password, click your *username*, select **Change password**, and complete the form.

4. Optional: Select **Remember my username** to quickly log in to the Cloud Control Room.

5. Optional: Click **Forgot password?** to reset your password.

An email is sent to you with a link to the necessary page to reset the account password.

6. Click Log in.

The credentials are authenticated directly with the Cloud Control Room or Community Control Room database.

Note: When you access the Enterprise Control Room with the **Login with Windows** option selected, you must enter the FQDN to log in successfully.

Note: Your account is locked if you enter the wrong password a specific number of times depending on the password policy set by your administrator. For security reasons, failed log-in attempts are audited. This allows the administrator to analyze and take appropriate actions.

Related tasks[Create your first bot](#)

Perform the following steps to create your first bot that prints the message, `Go be great!`, the Automation Anywhere version of `Hello World!`

[Install Bot Agent and register device](#)

The Bot Agent is a lightweight application that enables you to run bots on your device by connecting the device to the Control Room. To run bots on a local machine, install the Bot Agent and add the local device to the list of enabled host devices.

[Reset user password](#)

The Control Room administrator generates an email process for the user to reset their password.

Install Bot Agent and register device

The Bot Agent is a lightweight application that enables you to run bots on your device by connecting the device to the Control Room. To run bots on a local machine, install the Bot Agent and add the local device to the list of enabled host devices.

- To install the Bot Agent, the Windows installer policy must be enabled for the user device.
- The read, write, and execute permissions must be enabled for the Bot Agent folders on the user device.
- Ensure the device system date and time are in sync with the current date and time so that the device registration is successful.

[Credential requirements](#)

The Bot Agent version available for download is the latest and compatible with the Control Room version that is used.

Note:

- You can now install the Bot Agent on a device with an existing Enterprise 11 client.
 - A Bot Creator can log in and access both Automation 360 and Enterprise 11 client to create bots.
 - Attended Bot Runners can run bots from both Automation 360 and Enterprise 11 Control Room instances.
 - Unattended Bot Runners can deploy bots by using the run and schedule permission on the same device.
- You cannot run bots from Enterprise 11 and Automation 360 at the same time.
- You cannot install a Bot Agent on a device with an existing Enterprise 10 client.

- When the Bot Agent is installed on a device where Enterprise 11 client is also installed and then you uninstall the client, you might face login issues with the device. Therefore, you must uninstall and re-install the Bot Agent on the device.

-
1. Log in to the Control Room through your Automation Anywhere URL using a supported browser.
 2. Install the Bot Agent and add a local device by choosing one of the following options:
 - From the menu on the left, click the device icon to connect a local device.
 - Go to the **Devices** page, and click the **Connect local device** icon located at the top-right of the Devices list.

3. Click **Connect to my computer**.

The Bot Agent setup file is downloaded.

4. Follow the steps outlined in the wizard.

Authenticated proxy access: If your device's access to the internet is controlled through an authenticating proxy server, you are prompted to provide the proxy server authentication details. These credentials are required for the device to communicate with the Control Room.

To enable the authenticated proxy, register the device through a Google Chrome browser with the Automation 360 Chrome extension enabled.

Note: The Chrome extension is installed for Google Chrome Enterprise browser users even if the device is offline. The extension is downloaded along with the Bot Agent MSI installer file.

Note: The Chrome and Edge extensions are installed for Google Chrome and Microsoft Edge Enterprise browser users, respectively, even if the device is offline. The extension is downloaded with the Bot Agent MSI installer file.

5. Select an option to install the Bot Agent either at the system level or user level.

- To install at the system level, select **Anyone who uses this computer (all users)**

All users of the device can use this Bot Agent. However, users installing the Bot Agent must have administrator privileges.

- To install at the user level, select **Only for me (username)**.

The Bot Agent will be available only to the individual user.

6. Enter the following in the **Additional information** screen:

- Device nickname (optional)
- Device type (single user or multiple user)

Note: For a multiple user device, enter the number of concurrent sessions that will be allowed. A minimum of two concurrent sessions is supported.

7. Click **Done**.

- The Bot Agent is installed to the default location `C:\Program Files\Automation Anywhere\Bot Agent`.
- The Bot Agent is registered as a Windows service: Automation Anywhere Bot Agent Service.
- A shortcut to access AARI Assistant is added to the Windows Start menu and desktop.
- The Java Runtime Environment (JRE) files are installed with the Bot Agent in the Bot Agent install folder: `C:\Program Files\Automation Anywhere\Bot Agent\jre`.

8. Set the user device credentials so that your device can run bots.

9. Refresh the **Devices** page and verify that the local device is added.

You can identify the devices by their IP address and hostname.

Note: After you remove a device, wait for 35 seconds to re-register the device.

Troubleshooting:

- If you face any issues registering your device, see [Automation 360: Error while registering device - An unexpected problem occurred \(A-People login required\)](#).
- If the Bot Agent service is paused and does not start after installation, see [Automation 360 Error: Device is disconnected or needs upgrade \(A-People login required\)](#).
- If you are using Google Chrome browser version 94 or later and if you face issues registering your device in a Control Room On-Premises, we recommend that you configure the Control Room for HTTPS instead of HTTP. Alternatively, use Microsoft Internet Explorer or Mozilla Firefox to register your device.

If you face any issues adding a new device, see [Unable to Add New Device \(A-people login required\)](#).

- If you manually remove the Google Chrome extension, existing Google Chrome policy does not allow you to add the extension (online or offline) even after you reinstall the Bot Agent. We recommend that you do not remove the extension. However, if you manually remove the extension, perform any one of the following:
 - Go to Google Chrome extension store to add the extension online.
[Automation 360 extension for Chrome](#)
 - Drag the ChromeExtension.crx file (C:\Program Files\Automation Anywhere\Bot Agent\AABrowserAgent) to the Google Chrome extension tab (**three vertical dots menu on top-right > Settings > Extensions**).

Watch the following video on how to install the Bot Agent in Automation 360:

Optionally, [Edit profile](#).

If your device is set with a proxy, see the tasks that apply to your proxy settings, [Connect Bot Agent to a device with a proxy](#).

Related concepts[About device pools](#)

Device pools are a logical grouping of devices or similar unattended Bot Runner machines on which you can run your workload management automations or scheduled unattended automations. For example, you can group the devices (system-wide type) of a specific department or unit and create a device pool.

Related tasks[Create device pools](#)

Create a device pool with a unique name and add Unattended Bot Runners to the device pool.

[Set user device credentials](#)

To enable a device for running bots, set the local device credentials.

About the Bot Agent

The Bot Agent is a lightweight application that enables you to run bots on your device by connecting the device to the Control Room. After installing the Bot Agent on a device, a registered user with role-based access privileges can create, manage, and deploy bots on that device.

Bot Agent configuration

1. A user can log in to the Control Room using the credentials provided by the administrator after the Control Room administrator creates a user and shares the credentials with the user.
2. The user can now install the Bot Agent and the user device is registered and mapped to that username in the Control Room.
3. The Bot Agent is registered as a Windows service (Automation Anywhere Bot Agent Service) on the user device and the Automation Anywhere extension is added to the user's browser. You can enable the extension from your browser settings.
4. The device communicates with the Control Room using WebSocket and stays connected.

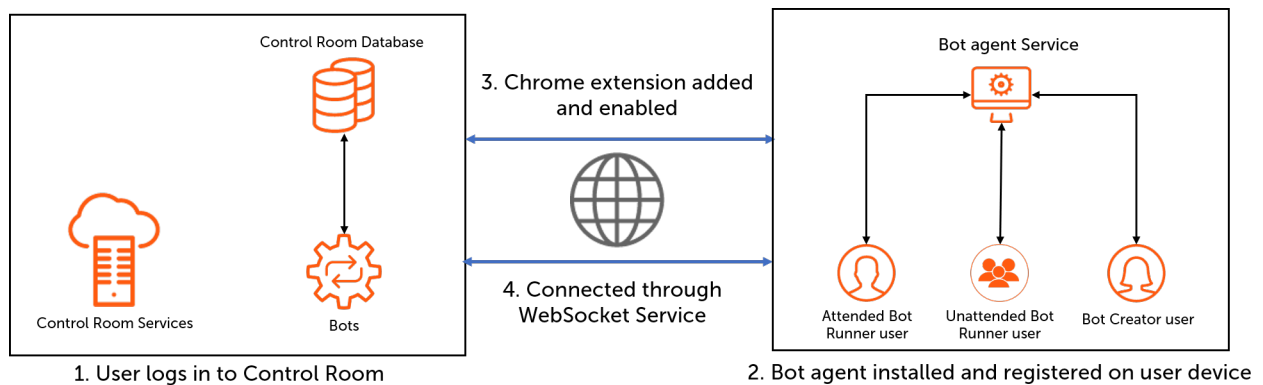

Privilege mapping

A user is granted privileges governed by role-based access and assigned a device license by the Control Room administrator. The user is allocated either a Bot Creator or Bot Runner license.

Bot Creator

Users with Bot Creator licenses can log in to the Control Room from a browser to perform the following actions:

- Create, edit, or delete bots.
- Manage bots for using in Bot Insight, IQ Bot, and Bot Store.

Bot Runner

Users with Bot Runner licenses are used to deploy bots from the Control Room.

A user can be allocated any one of the two licenses - Unattended or Attended Bot Runner license.

- Users with unattended Bot Runner license are configured to allow other Control Room users with required privileges to run and schedule automation from the Control Room. Such users are also referred as **Run as users**.
- Users with attended Bot Runner license are allowed to run attended automations on their own devices from the Control Room.

Note: If you encounter black screenshot when running bots in unattended mode, see the following article for troubleshooting steps.

[Black screenshot while running the bot in unattended mode \(A-People login required\)](#)

Related tasks

[Install Bot Agent and register device](#)

The Bot Agent is a lightweight application that enables you to run bots on your device by connecting the device to the Control Room. To run bots on a local machine, install the Bot Agent and add the local device to the list of enabled host devices.

Related reference

[Bot Agent compatibility](#)

Before you install the Bot Agent, ensure that it is compatible with the hardware and software in your environment.

Bot Agent communication with Control Room

The Bot Agent uses various channels to communicate with the Control Room. Relevant data is transferred directly and indirectly using communication channels such as loop-back interface, browser plug-in, and WebSocket connection.

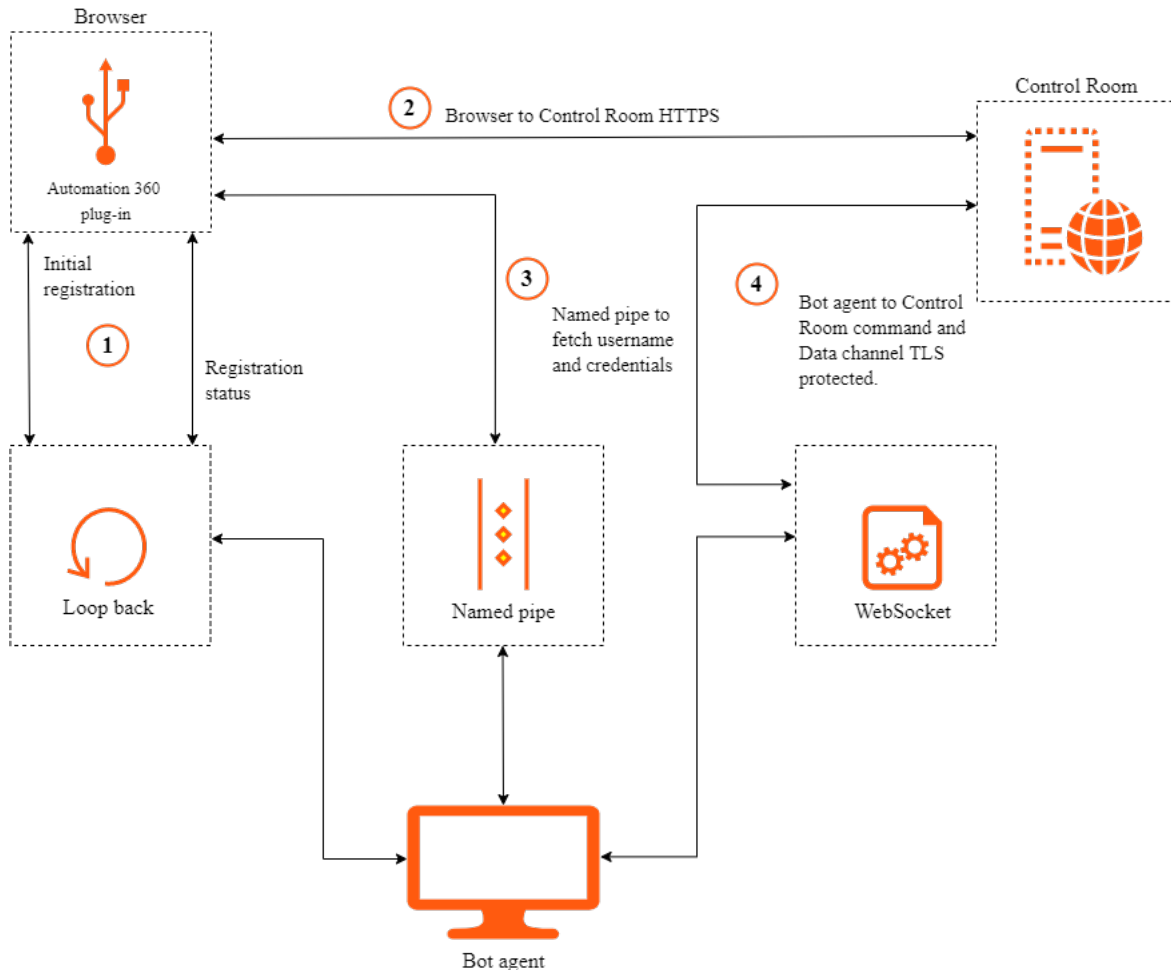

Browser to loop-back interface

The browser-to-loop-back-interface channel is used during initial Bot Agent device registration and post-registration to check the current connection status to the Control Room. The loop-back interface uses HTTP unencrypted connection.

The following initial registration data is transferred over this channel:

- Control Room user token. This is accessible through developer tools on the browser.
- Control Room URL
- Proxy metadata, such as device ID, whether the proxy is configured or not, and whether it uses authentication or not.

The following connection status data is transferred over this channel:

- Device ID
- Control Room URL
- Installation type, such as system-level or user-level
- Proxy metadata, such as device ID, whether the proxy is configured or not, and whether it uses authentication or not.

Browser to Control Room

The browser-to-Control Room channel is used by the browser to connect to the Control Room. The data transferred over this channel includes all Control Room web data. The browser uses HTTPS encrypted connection.

Plug-in to Bot Agent named pipe

The plug-in to the Bot Agent named pipe channel is used to fetch current logged-in username and credentials if an authenticated proxy is to be obtained for the browser. The plug-in channel is protected by user permissions.

Bot Agent to Control Room WebSocket

The Bot Agent-to-Control Room WebSocket channel is used for all command and data transfer between the Bot Agent and Control Room. Data transferred over this channel includes requests from the Bot Agent to the Control Room, bot code transfer, password data, Control Room-to-Bot Agent requests. Password data is payload-encrypted, with the device public key in addition to the TLS encryption of the channel.

Bot Agent compatibility

Before you install the Bot Agent, ensure that it is compatible with the hardware and software in your environment.

Compatibility with Automation 360 builds

Note: The Bot Agent version that is available for download is the latest and compatible with the Control Room version that is used.

Important:

- When you update the Bot Agent in Windows Server 2012 or earlier versions of the operating system, you may encounter unexpected system reboots during the update because of the limitations in the operating system.
 - When the Bot Agent update is optional, you can continue to use the Bot Agent from the previous release, which will be compatible with the current release. For example, for v.24, the Bot Agent update is optional, so you can continue to use the Bot Agent from the previous v.23 release.
 - If you want to use the latest version of packages from a new release, you might be required to update the Bot Agent even if the Bot Agent update is optional.
-

Automation 360 version	Automation 360 build	Bot Agent version	Bot Agent update
Automation 360 v.27	<ul style="list-style-type: none"> • Build 16667 (On-Premises) • Build 16667 (Cloud) • Build 16603 (Community Edition) 	<ul style="list-style-type: none"> • 21.230 • 21.230 • 21.230 	Optional
Automation 360 v.26	<ul style="list-style-type: none"> • Build 15450 (On-Premises) • Build 15450 (Cloud) • Build 15450 (Community Edition) 	<ul style="list-style-type: none"> • 21.222 • 21.222 • 21.222 	Optional
Automation 360 v.25	<ul style="list-style-type: none"> • Build 15112 (On-Premises) • Build 14304 (Cloud) • Build 14304 (Community Edition) 	<ul style="list-style-type: none"> • 21.210 • 21.210 • 21.210.14966 	Optional
Automation 360 v.24R2 patch	<ul style="list-style-type: none"> • Build 13343 (Cloud, On-Premises GA, Sandbox, Community Edition) • Build 13331 (On-Premises pre-GA) 	<ul style="list-style-type: none"> • 21.200 • 21.1000.14009 <p>On-Premises pre-GA build: Uninstall Bot Agent 21.1000.14009 and install Bot Agent 21.200.</p>	Optional
Automation 360 v.24	<ul style="list-style-type: none"> • Build 12350 (On-Premises) • Build 12350 (Cloud) • Build 12350 (Community Edition) 	<ul style="list-style-type: none"> • 21.134 (On-Premises) • 21.134 (Cloud) • 21.134 (Community Edition) 	Optional
Automation 360 v.23	<ul style="list-style-type: none"> • Build 11513 (On-Premises) • Build 11513 (Cloud) • Build 11524 (Community Edition) 	<ul style="list-style-type: none"> • 21.121.12191 (On-Premises) • 21.121.12191 (Cloud) • 21.121.12202 (Community Edition) 	Optional
Automation 360 v.22	<ul style="list-style-type: none"> • Build 10526 (On-Premises) • Build 10535 (Cloud and Community Edition) 	<ul style="list-style-type: none"> • 21.98.11198 • 21.100.11213 	Optional
Automation 360 v.21	<ul style="list-style-type: none"> • Build 9664 (On-Premises) • Build 9664 (Cloud and Community Edition) 	<ul style="list-style-type: none"> • 21.82.10342 • 21.82.10342 	Required

Automation 360 version	Automation 360 build	Bot Agent version	Bot Agent update
Enterprise A2019.20	<ul style="list-style-type: none"> Build 8815 (On-Premises) Build 8846 (Cloud) 	<ul style="list-style-type: none"> 20.17.9493 (On-Premises) Cloud: <ul style="list-style-type: none"> 20.18.9528 (for US-West and Japan regions) 20.17.9518 (for regions other than US-West and Japan) 	Required
Enterprise A2019.19	<ul style="list-style-type: none"> Build 8147 (On-Premises) Build 8145 (Cloud and Community Edition) 	<ul style="list-style-type: none"> 18.12.8825 18.12.8823 	Required
Enterprise A2019.18	Build 7560 (Cloud, On-Premises, and Community Edition)	16.19.8238	Optional
Enterprise A2019.17	Build 7103 (Cloud, On-Premises, and Community Edition)	16.7.7774	Required
Enterprise A2019.16	Build 6463 (Cloud, On-Premises, and Community Edition)	14.3.7141	Required
Enterprise A2019.15	Build 5933 (Cloud, On-Premises, and Community Edition)	12.7.6609	Optional
Enterprise A2019.14	Build 5322 (Cloud, On-Premises, and Community Edition)	12.1.6000	Required
Enterprise A2019.13	<ul style="list-style-type: none"> Build 4705 (On-Premises) Build 4701 (Cloud and Community Edition) 	<ul style="list-style-type: none"> 9.0.5383 9.0.5379 	Required
Enterprise A2019.12	<ul style="list-style-type: none"> Build 4111 (Cloud and Community Edition) Build 4105 (On-Premises) 	<ul style="list-style-type: none"> 7.0.4789 7.0.4783 	Required
Enterprise A2019.11	Build 3337 (On-Premises, Cloud, and Community Edition)	6.0.4015	Required
Enterprise A2019.10	Build 2545 (Cloud, On-Premises, and Community Edition)	3.3.3211	Optional
Enterprise A2019.09	Build 2094 (Cloud, On-Premises, and Community Edition)	3.0.2772	Required

Automation 360 version	Automation 360 build	Bot Agent version	Bot Agent update
Enterprise A2019.08	<ul style="list-style-type: none"> Build 1610 (On-Premises only) Build 1598 (Cloud and Community Edition) 	<ul style="list-style-type: none"> 1.0.2288 1.0.2276 	Optional
Enterprise A2019.07	<ul style="list-style-type: none"> Build 1089 (On-Premises only) Build 1082 (Cloud and Community Edition) 	<ul style="list-style-type: none"> 1.0.1767 1.0.1760 	Optional
Enterprise A2019.06	Build 543 (Cloud, On-Premises, and Community Edition)	1.0.1221	Optional
Enterprise A2019.05	Build 336 (Cloud, On-Premises, and Community Edition)	1.0.1014	Required

For information on Bot Agent device requirements, see [Device requirements for Bot Agent](#).

Related tasks

[Install Bot Agent and register device](#)

The Bot Agent is a lightweight application that enables you to run bots on your device by connecting the device to the Control Room. To run bots on a local machine, install the Bot Agent and add the local device to the list of enabled host devices.

Related reference

[Automation 360 feature comparison matrix](#)

Use the feature comparison matrix to compare the Automation 360 features with the features in Automation Anywhere Enterprise 11.3.x and Enterprise 10 versions.

[Universal Recorder supported applications and browsers](#)

Use the Universal Recorder to record interactions with objects from the supported technologies.

Auto-login support for Bot Agent

Use auto-login to automatically log on to a device, run a scheduled automation, and restore the device to its original locked or logged off state after running the automation.

Auto-login restores a device to its original state in the following scenarios:

- When an automation is stopped or paused either from the Control Room or device. This ensure that the security of the machine is not compromised when an automation is paused or stopped.

Note: When the automation resumes, it continues to run in the background on the locked device.

- When an automation encounters an error during execution.

Auto-login support: operating system

Identify the operating system support specific to auto-login on Bot Agent devices. The auto-login process involves several stages and depends on the Bot Agent activity.

The following scenarios are supported on Windows 10 and virtual machines only:

SID#	Scenario
1	No user session established (user is not logged in)
2	User session established
3	User has logged in but locked the screen
4	A different user (not the device login user used for deployment) is logged in
5	A different user is logged in and locked the screen
6	Fast user switching

The following scenarios are applicable and supported on Windows Server 2019, Windows Server 2016 R2, Windows Server 2012 R2, Windows 10, 8, and 7:

SID#	Scenario
1	No active RDP session
2	User has active RDP session
3	User's RDP session is disconnected
4	User's RDP session is locked
5	Another user has active RDP session
6	Another user has a disconnected session
7	Another user has an active session and locked

Auto-login support: operating system with cloud platform

The following table identifies the support specific to auto-login on Bot Agent devices for operating system across cloud platforms:

SID#	Scenario	Supported OS
1	No active RDP session	<ul style="list-style-type: none"> • Windows 2019 - AWS • Windows 2016 R2 - AWS • Windows 2012 R2 - AWS • Windows 10 AWS • Windows 11 (Enterprise) • Windows 10 Azure (Enterprise) • Windows 10 VMWare (ESXi 6.7 and Horizon) • Windows 10 Citrix

SID#	Scenario	Supported OS
2	User has active RDP session	<ul style="list-style-type: none"> • Windows 2019 - AWS • Windows 2016 R2 - AWS • Windows 2012 R2 - AWS • Windows 10 AWS • Windows 11 (Enterprise) • Windows 10 Azure (Enterprise) • Windows 10 VMWare (ESXi 6.7 and Horizon) • Windows 10 Citrix
3	User's RDP session is disconnected	<ul style="list-style-type: none"> • Windows 2019 - AWS • Windows 2016 R2 - AWS • Windows 2012 R2 - AWS • Windows 10 AWS • Windows 11 (Enterprise) • Windows 10 Azure (Enterprise) • Windows 10 VMWare (ESXi 6.7 and Horizon) • Windows 10 Citrix
4	User's RDP session is locked	<ul style="list-style-type: none"> • Windows 2019 - AWS • Windows 2016 R2 - AWS • Windows 2012 R2 - AWS • Windows 10 AWS • Windows 11 (Enterprise) • Windows 10 Azure (Enterprise) • Windows 10 VMWare (ESXi 6.7 and Horizon) • Windows 10 Citrix
5	Another user has active RDP session	<ul style="list-style-type: none"> • Windows 2019 - AWS • Windows 2016 R2 - AWS • Windows 2012 R2 - AWS • Windows 10 AWS • Windows 11 (Enterprise) • Windows 10 Azure (Enterprise) • Windows 10 VMWare (ESXi 6.7 and Horizon) • Windows 10 Citrix
6	Another user has a disconnected session	<ul style="list-style-type: none"> • Windows 2019 - AWS • Windows 2016 R2 - AWS • Windows 2012 R2 - AWS • Windows 10 AWS • Windows 11 (Enterprise) • Windows 10 Azure (Enterprise) • Windows 10 VMWare (ESXi 6.7 and Horizon) • Windows 10 Citrix

SID#	Scenario	Supported OS
7	Another user has an active session and locked	<ul style="list-style-type: none"> Windows 2019 - AWS Windows 2016 R2 - AWS Windows 2012 R2 - AWS Windows 10 AWS Windows 11 (Enterprise) Windows 10 Azure (Enterprise) Windows 10 VMWare (ESXi 6.7 and Horizon) Windows 10 Citrix

Additional notes on auto-login:

- Auto-login is only supported on 64-bit operating systems.
- Auto-login is unable to sign-out the root admin session, when trying with scenarios that involve two different auto-login users. Remember to log out of the admin user account before deploying a bot.
- For scenarios 4, 5, and 6 in the above tables, the active user is logged off and a new session created with device credentials for deploying the bot.

Related tasks

[Configure auto-login settings](#)

Configure auto-login settings in the Control Room to either create user sessions or reuse existing user sessions to reduce the bot startup time.

[Customize device settings](#)

Customize the settings for user devices at the device level such as device lifespan, auto-login, screen resolution, deployment, and other advanced options.

Related reference

[Bot Agent compatibility](#)

Before you install the Bot Agent, ensure that it is compatible with the hardware and software in your environment.

Device requirements for Bot Agent

Review the Bot Agent device requirements such as hardware components, compatible devices, supported operating systems and browser extensions.

Hardware requirements

You can install the Bot Agent on devices that meet the following hardware requirements.

Device	Processor	RAM	Storage (free disk space)	Network
Machine	Intel Core i3 2.6 GHz with 4 multi-cores or higher 64-bit	<ul style="list-style-type: none"> 4 GB (Minimum) 8 GB (Recommended) 	32 GB Add 100 through 150 KB per Automation Anywhere script Add 40 through 50 GB per long-term project	<ul style="list-style-type: none"> 5Mbps (Minimum) 20Mbps or higher (Recommended)
Additional users on a multi-user device	2 CPU per additional user	4 GB per additional user	No additional storage required	No additional network needed

Additional RAM requirements for the registered devices

Add additional RAM to account for applications and services running on the registered devices, for example:

- Microsoft Office applications (example: Excel)
- Browsers (example: Google Chrome)
- Enterprise applications (example: CRM, Oracle EBS, and SAP)
- VDI infrastructure applications
- Anti-virus software
- AISense Recorder

Additional disk space on registered devices

- Automation 360 scripts average approximately 100-150 KB. Additional free disk space is required to develop automation projects because temporary files such as screenshots, server logs, and audit files are created during the execution of the automation scripts.
- Free space required increases with the project size. Recommendation: Have at least 40-50 GB of free disk space for each long-term project.
- Increase storage space configuration after installation, as needed, depending on product usage. For example, depending upon the complexity of your bot, generating log files and logic creation require additional disk space later.

Device compatibility

A device running the Bot Agent to perform automation must meet the following requirements:

Note:

- Device requirements are different for the Control Room and Bot Agent.

For Control Room compatibility, see [Operating system, environment, and platform supported for Control Room](#)

- For your device to work properly on Amazon Workspaces, update the registry on all Workspace machines by renaming the `spacedeskHookKmode.sys` file to `spacedeskHookKmode.sys.old` in `C:\Windows\System32\drivers`. Restart your machine and verify that `STXHD Hosted Application Service` is not running.

For more information, see [Troubleshooting Amazon WorkSpaces issues](#).

On-Premises machines

Physical machines running on supported operating systems.

Terminal servers

Remote desktop (RDP) running on supported operating systems from Enterprise A2019.11 or later.

Virtual machines

From Enterprise A2019.09 or later, the Bot Agent can be installed on all virtual machines (VMs) with supported Windows OS.

For AI Sense recorder to work on a VM, enable AVX instructions for both Bot Runner and Bot Creator.

For details, see [Automation 360: AI Sense Recorder is crashing \(A-People login required\)](#)

The Bot Agent is certified on all major versions of VMs and supports the following:

Virtual Machine (VM)	Operating System and edition
Amazon Web Services EC2	<ul style="list-style-type: none"> Windows 11 (Enterprise) Windows 10 (Professional) Windows 2012 Server, Windows 2016 Server, and Windows 2019 Server (Standard and Datacenter)
Amazon Web Services WorkSpaces (Performance bundle)	<ul style="list-style-type: none"> Windows 11 (Enterprise) Windows 10 (Professional)

Virtual Machine (VM)	Operating System and edition
Google Compute Engine	<ul style="list-style-type: none"> Windows 11 (Enterprise) Windows 10 (Professional) Windows 2012 Server, Windows 2016 Server, and Windows 2019 Server (Standard and Datacenter)
Microsoft Azure Virtual Machine (VM)	<ul style="list-style-type: none"> Windows 11 (Enterprise) Windows 10 (Professional and Enterprise) Windows 2019 Server (Datacenter)
Microsoft Azure Windows Virtual Desktop (WVD)	<ul style="list-style-type: none"> Windows 11 (Enterprise) Windows 10 (Enterprise)
VMware VMs on ESXi 6.x	<ul style="list-style-type: none"> Windows 10 (Professional) Windows 2016 Server
Citrix XenDesktop (VDI)	Windows 2016 Server
Citrix VM	<ul style="list-style-type: none"> Windows 10 (Enterprise) Windows 2016 (Server)
VMware Horizon	Windows 10 (Enterprise)

Recommendation: When you install the Bot Agent on virtual machines, ensure that you change the virtual machine **Power and Sleep** settings to **Never** so that bot deployments from the Control Room can run without interruption.

Operating system compatibility

You can install the Bot Agent on machines running the following operating systems.

This compatibility applies to On-Premises, Cloud deployments, and Community Edition of Automation 360.

Note:

- Only 64-bit operating system version is supported.
- Bot Creator tasks are supported with all the listed operating systems.
- The Bot Agent cannot be installed on Linux systems. You cannot register a device that is running on a Linux system. However, you can use a registered device running on a Windows system to access a Control Room that is installed on a Linux system.

Windows version	Windows edition	Attended Bot Runner	Unattended Bot Runner	Bot Creator Runner
Windows 365 Cloud PC	Enterprise	Supported	Supported	Supported
Windows Server 2019	Datacenter and Standard	Supported	Supported ¹	Supported
Windows Server 2016	Datacenter and Standard	Supported	Supported ¹	Supported
Windows Server 2012	Datacenter and Standard	Supported	Supported ¹	Supported
Windows 11	Enterprise	Supported	Supported ¹	Supported
Windows 10	Professional and Enterprise	Supported	Supported ¹	Supported
Windows 8 ²	Professional and Enterprise	Supported	Supported	Supported
Windows 7 ²	Professional and Enterprise	Supported	Supported	Supported

(1) Auto-login

- Auto-login is only supported on 64-bit systems.
- If the Auto-login fails, configure the **Local Security Policy** settings. For example, in Windows, select **Security Settings > Local Policies > Security Options**. **Enable** the **Interactive logon > Do not require CTRL+ALT+DEL** option.

Recommendation: Enable the **Interactive logon > Do not require CTRL+ALT+DEL** option to ensure your device is able to bypass the screen to create a user session.

When you deploy a bot from the Control Room on a device, Bot Agent receives the deployment and creates an interactive user session for deployment. If the option is disabled, the Bot

Agent will not be able to bypass the screen to create a user session. Therefore, we recommend you enable this option.

For more information, see [Why does the policy \(Interactive logon: Do not require CTRL+ALT+DEL\) need to be enabled for Auto Login to work? \(A-People login required\)](#).

(2) Supported OS

Windows 8 (64-bit) supported on Enterprise A2019 Builds 1598 and 1610 or earlier.

Windows 7 (64-bit) supported on Enterprise A2019.12 or later.

Browser compatibility

The user interface for Bot Agent is through a browser. Log in to Automation 360 using the supported browsers to install and register your device.

For a list of supported browsers, see [Supported browsers](#)

Supported extensions

When you connect your Bot Agent device to the Control Room, you can enable supported extensions from your browser to record automations.

For a list of supported extensions, see [Extensions for automation](#)

Auto-login support

Auto-login is used to automatically log on to a device, run a scheduled automation, and restore the device to its original locked or logged off state after running the automation.

For operating system support specific to auto-login on Bot Agent devices, see [Auto-login support for Bot Agent](#)

Working with the Bot Agent

Users can perform tasks based on their access privileges after installing the Bot Agent on their device.

Install and update the Bot Agent

To install and update the Bot Agent, you must perform these tasks:

1. If you are using the Bot Agent application for the first time, verify all prerequisites to install the Bot Agent are complete.

[Bot Agent compatibility](#)

2. Install the Bot Agent on your device.

[Install Bot Agent and register device](#) | [Perform bulk installation of Bot Agent on devices](#)

Connect the Bot Agent to your device using an authentication proxy to ensure changed proxy setting or credentials are updated so that bots can be deployed on your device.

[Connect Bot Agent to a device with a proxy](#)

3. Set device credentials to enable the Control Room to deploy bots on your device.

[Set user device credentials](#)

4. Switch to a different Control Room based on your automation requirements.

[Switch Bot Agent to a different Control Room](#)

5. When updates are available, you can update the Bot Agent to the latest version.

Depending on the settings for the Bot Agent, you can either automatically update or manually update your Bot Agent.

[Automatically update the Bot Agent](#) | [Manually update the Bot Agent](#)

6. Verify the Bot Agent version and device connection in the Control Room > **Devices** page.

[Devices](#)

Related tasks

Users can also perform the following tasks:

- Use the Bot Agent diagnostic utility to perform diagnostic checks on Bot Runner devices and to help in resolution of Bot Agent connectivity challenges.

[Perform Bot Agent diagnostic checks](#)

- Use the Bot Agent relevant logs to resolve issues.

[Bot Agent log files](#)

- Create and edit TaskBots

[Create your first bot](#) | [Edit a bot](#)

- Deploy bots on attended and unattended Bot Runners with or without Workload automation.

[Run a bot](#) | [Schedule a bot](#) | [Run bot with queue](#)

- Manage different bots and packages using Bot Store, Bot Insight, and IQ Bot.

[Bot Store](#) | [Using Bot Insight](#) | [Automation 360 IQ Bot](#)

- Perform other activities such as updating user profile.

[Edit profile](#)

Resources: For additional information about the Bot Agent, see this training course: [Automation Anywhere Certification \(A-People login required\)](#)

Perform bulk installation of Bot Agent on devices

Edit the Bot Agent MSI file to bulk install (or silently install) the Bot Agent on permanent and temporary devices such as on-premises machines, virtual machines (VM), and non-persistent virtual desktop infrastructure (VDI), for example Citrix, in the Control Room.

To perform this task, you must be a administrator and have the required rights and permissions.

Ensure the following requirements are completed:

- Bot Agent setup and MSI files are downloaded from the Control Room and the parameters required to install devices are available in the Bot Agent MSI file.

If you are not able to access the MSI files, contact support on <https://www.automationanywhere.com>.

- Windows 10 Software Development Kit including Orca and Control Room are installed on your device.

You can install Orca from C:\Program Files (x86)\Windows Kits\10\bin\10.0.18362.0\x86\Orca-x86_en-us.msi.

Sample autoregistration.properties file: You can find a sample autoregistration.properties file at the end of the page for your reference.

1. Use the latest AutomationAnywhereBotAgent.msi file from the following locations:

- Download the file from the Control Room (**Administrator** > **Settings** > **Bot agent bulk install**).

The download option is available for On-Premises and Cloud deployments.

- Select the file from the <application filepath>\crui\asset folder. For example C:\Program Files\Automation Anywhere\crui\asset

This option is available only for On-Premises deployments.

2. Edit the AutomationAnywhereBotAgent.msi file using the Orca tool.
3. Click the **Property** option.
4. Enter appropriate values for the following parameters:

Parameter	Description
AA_CRTOKEN	<p>Enter the registration key that is used to install the Bot Agent on multiple devices at a time in bulk.</p> <p>The registration key is provided by the Control Room admin.</p> <p>See Generate registration key to install Bot Agent in bulk.</p>
AA_CRURL	<p>Enter the Control Room instance to which the Bot Agent will to be connected.</p> <hr/> <p>Note: Ensure you do not add a backslash (/) at the end of the Control Room URL. For example, mycr.mydomain.com/.</p> <hr/>

Parameter	Description
AA_DEVICE_TYPE	<p>Enter one of the following values for the device type:</p> <ul style="list-style-type: none"> • SINGLE_USER • MULTIPLE_USERS <hr/> <p>Note: Enter the values in uppercase letters when you install the Bot Agent.</p>
AA_LIFESPAN	<p>Enter one of the following values for a non-persistent or persistent device:</p> <ul style="list-style-type: none"> • TEMPORARY • PERSISTENT <hr/> <p>Note: Enter the values in uppercase letters when you install the Bot Agent.</p>
AA_CONCURRENT_SESSIONS	<p>Enter the concurrent sessions allowed, from 1 through 99. The default value is 1.</p>
AA_INSTALL_ONLY	<p>Choose whether you want to install the Bot Agent without registering with the Control Room.</p> <ul style="list-style-type: none"> • Enter <code>True</code> to only install and not register the Bot Agent. <hr/> <p>Note:</p> <p>The <code>autoregistration.properties</code> file is created when <code>AA_INSTALL_ONLY</code> is set to <code>True</code>. You can set <code>AA_INSTALL_ONLY</code> to <code>True</code> only for system-level installation.</p> <hr/> <ul style="list-style-type: none"> • Enter <code>False</code> to install and register the Bot Agent.
AA_DEVICE_POOL_NAME	<p>Enter a value to accept the device pool name and add the device to the device pool. The default value is 0.</p>

5. Save the changes.
6. Copy the `AutomationAnywhereBotAgent.msi` file to the VM instance (golden image) on which you want to install the Bot Agent.
7. Run the `AutomationAnywhereBotAgent.msi` file.
8. Validate that the Bot Agent is installed on the VM instance and Bot Agent service is not running in the Task Manager Services tab.

Note: An `autoregistration.properties` file will be generated at `C:\Windows\System32\config\systemprofile\AppData\Local\AutomationAnywhere`.

To deploy the Bot Agent on temporary or non-persistent devices, you must configure the SysPrep settings and create machine images on the VM instance.

9. Shut down the VM instance without SysPrep after you enable temporary or non-persistent computer name settings for the VM.
For an example of how to use SysPrep on AWS EC2 instance, see [Use Sysprep to create and install custom reusable Windows AMIs](#).
10. Create machine images on the VM instance as required.
For an example of how to create Amazon Machine Images (AMI) from an AWS EC2 instance, see [Create an AMI from an Amazon EC2 Instance](#).

If a Bot Agent is registered in the VM instance by mistake, perform these steps to restore the machine image:

1. Uninstall the Bot Agent from the Windows Control Panel of the VM instance.
2. Delete all files from `C:\Windows\System32\config\systemprofile\AppData\Local\AutomationAnywhere`.
3. Enter `True` for the `AA_INSTALL_ONLY` parameter in the `AutomationAnywhereBotAgent.msi` file that you previously used to install the Bot Agent.

Sample autoregistration.properties file

```
url=http://ec2-myexampleCR.com
token=eyJhbGciOiJSUzUxMiJ9.eyJjbGllbnRUeXB1IjoiaQk9UX0FHRU5UX0FVVE9fUkVHSVNUUkFUSU90IiwiaXNjaW50IjoiImZlcnR8sXMnr7hSfi_aYDx8emyoH2XtFAQAYuXiw6vOXWalo-TYDtPknIJsga6aAiFJ9-w6ndJAov0JvTClmeyLQgBA
device_type=MULTIPLE_USERS
concurrent_sessions=4
lifespan=TEMPORARY
delay_registration_until_login=false
```

Validate that the devices are added on the Control Room **Devices** page.

Related tasks

[Configure auto-delete temporary device settings](#)

Configure your device settings to automatically delete a temporary device when the device is disconnected from the Control Room after a certain time interval.

[Generate registration key to install Bot Agent in bulk](#)

The Control Room administrator can generate a registration key to install the Bot Agent on multiple devices at a time in bulk.

[Edit the Bot Agent installer file](#)

Edit the Bot Agent MSI installer file to add the registration key and Control Room URL to remotely install the Bot Agent on multiple devices.

Related reference

[Bot Agent compatibility](#)

Before you install the Bot Agent, ensure that it is compatible with the hardware and software in your environment.

[Devices](#)

The device is a machine through which a user connects to the Control Room to create or run bots. Manage devices that are registered to the Control Room through the **Devices** page located in the **Manage** tab.

Perform installation of Bot Agent on multiple devices

To easily switch the Bot Agent when you connect to a different Control Room, edit the Bot Agent MSI file to install the Bot Agent on multiple devices (permanent or temporary).

To perform this task, you must be a administrator and have the required rights and permissions.

Ensure that the following requirements are fulfilled:

- Bot Agent setup and MSI files are downloaded from the Control Room, and the parameters required to install devices are available in the Bot Agent MSI file.

If you are not able to access the MSI files, contact support at <https://www.automationanywhere.com>.

- Windows 10 Software Development Kit including Orca and Control Room are installed on your device.

You can install Orca from `C:\Program Files (x86)\Windows Kits\10\bin\10.0.18362.0\x86\Orca-x86_en-us.msi`.

1. Use the latest `AutomationAnywhereBotAgent.msi` file from the following locations:
 - Download the file from the Control Room (**Administrator** > **Settings** > **Bot agent bulk install**).
The download option is available for On-Premises and Cloud deployments.
 - Select the file from the `<application filepath>\crui\asset` folder. For example `C:\Program Files\Automation Anywhere\crui\asset`
This option is available only for On-Premises deployments.
2. Edit the `AutomationAnywhereBotAgent.msi` file using the Orca tool.
3. Click the **Property** option.

4. Enter appropriate values for the following parameters:

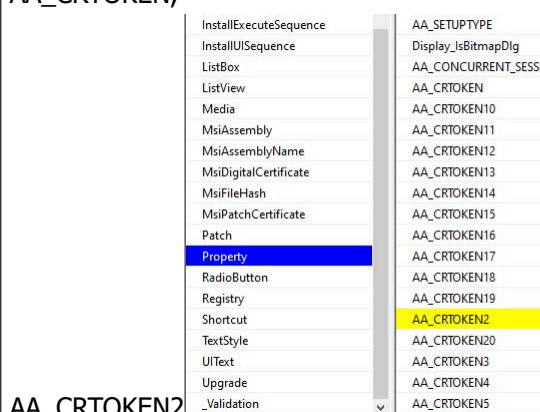
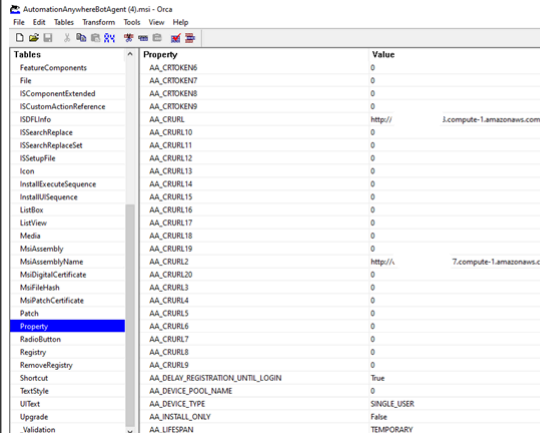
Parameter	Description
<p>AA_CRTOKEN,</p>  <p>AA_CRTOKEN2</p>	<p>Enter the corresponding registration key value for each Control Room. The registration key is provided by the Control Room admin.</p> <p>You must provide the corresponding registration tokens under AA_CRTOKEN, AA_CRTOKEN2 through AA_CRTOKEN20 for each Control Room URL configured. You can configure up to 20 Control Room URLs. There must be a one-to-one match between CR_URL and CR_TOKEN. There should be no skipping between CR_URL and CR_TOKEN and be filled consecutively. For example, to configure three Control Room URLs, it must be populated in the following order: AA_CRURL, AA_CRURL2, AA_CRURL3.</p> <p>For example, enter the registration key for AA_CRTOKEN, and the registration key for AA_CRTOKEN2 to install the Bot Agent on multiple devices.</p> <p>See Generate registration key to install Bot Agent in bulk.</p>
<p>AA_CRURL, AA_CRURL2</p> 	<p>Enter the Control Room instance to which the Bot Agent will be connected. For example, enter the specific Control Room URL for AA_CRURL and the specific Control Room URL for AA_CRURL2.</p> <p>Note: Ensure that you do not add a slash (/) at the end of the Control Room URL. For example, <code>mycr.mydomain.com/</code>.</p>

Parameter	Description
AA_DELAY_REGISTRATION_UNTIL_LOGIN	<p>Enter <code>True</code> to delay the registration to a Control Room until a user logs in to that Control Room.</p> <p>If a user logs in to any of the Control Room instances configured from the device where the Bot Agent is installed, the Bot Agent on that device will be automatically registered with that associated Control Room. If the logged-in Control Room URL is not configured, then there is no registration with that Control Room.</p>
AA_DEVICE_TYPE	<p>Enter one of the following values for device type:</p> <ul style="list-style-type: none"> SINGLE_USER MULTIPLE_USERS <p>Note: Enter the values in uppercase letters when you install the Bot Agent.</p>
AA_LIFESPAN	<p>Enter one of the following values for a non-persistent or persistent device:</p> <ul style="list-style-type: none"> TEMPORARY PERSISTENT <p>Note: Enter the values in uppercase letters when you install the Bot Agent.</p>
AA_CONCURRENT_SESSIONS	<p>Enter the concurrent sessions allowed, from 1 through 99. The default value is 1.</p>
AA_INSTALL_ONLY	<p>Choose whether you want to install the Bot Agent without registering with the Control Room.</p> <ul style="list-style-type: none"> Enter <code>True</code> to only install and not register the Bot Agent. Enter <code>False</code> to install and register the Bot Agent.
AA_DEVICE_POOL_NAME	<p>Enter a value to accept the device pool name and add the device to the device pool. The default value is 0.</p>

5. Save the changes.

6. Copy the `AutomationAnywhereBotAgent.msi` file to the VM instance (golden image) on which you want to install the Bot Agent.
7. Run the `AutomationAnywhereBotAgent.msi` file.
8. Validate that the Bot Agent is installed on the VM instance and that the Bot Agent service is not running in the Task Manager Services tab.

To deploy the Bot Agent on temporary, or non-persistent, devices, you must configure the SysPrep settings and create machine images on the VM instance.

9. Shut down the VM instance without SysPrep after you enable temporary, or non-persistent, computer name settings for the VM.
For an example of how to use SysPrep on an AWS EC2 instance, see [Use Sysprep to create and install custom reusable Windows AMIs](#).
10. Create machine images on the VM instance as required.
For an example of how to create Amazon Machine Images (AMI) from an AWS EC2 instance, see [Create an AMI from an Amazon EC2 Instance](#).

Bulk install Bot Agent using Microsoft Endpoint Configuration Manager

Install Bot Agent in bulk on multiple devices from a central location using the Microsoft Endpoint Configuration Manager or System Center Configuration Manager (SCCM).

- Ensure that Microsoft SCCM is installed on two machines, first on a machine that hosts the Control Room primary site and distribution server and then on a second machine that hosts the database server to store and process all client-server communication and operations.
- Ensure that the latest `AutomationAnywhereBotAgent.msi` file is downloaded from one of the following locations based on your Control Room deployment:
 - For On-Premises and Cloud: **Administrator > Settings > Bot agent bulk install**
 - For On-Premises: `<application filepath>\crui\asset` folder
For example, `C:\Program Files\Automation Anywhere\crui\asset`.

1. Add parameters in the `AutomationAnywhereBotAgent.msi` file using the Orca tool.
For detailed steps, see [Perform bulk installation of Bot Agent on devices](#).

2. Configure the Bot Agent application in SCCM.
 - a) Add general details, such as application name.
For example, Automation Anywhere Bot Agent Windows installer (*.msi file).
 - b) Add content details, such as content location, settings for uninstalling, and deployment options.
For example:
 - Content location: \\crserver\msibackup\
 - Settings for content uninstalling: Same as install content
 - Deployment options: Download content from distribution point and run locally
 - c) Provide the program commands required to install the application.
For example, `msiexec /i "AutomationAnywhereBotAgent.msi"/q`.
 - d) Provide the application detection method to determine whether the application is already installed on a device.
The SCCM automatically detects and adds the clause for the msi file.
 - e) Provide user experience details, such as installation behavior (install for system or user), logon requirement, installation visibility (interactive or hidden), and whether or not to enforce configuration manager behavior.
For example:
 - Installation behavior: Install for system
 - Logon requirement: Whether or not a user is logged on
 - Installation visibility: Hidden

For more information, see [Create and deploy an application with Configuration Manager](#).

3. Distribute the application on devices using the SCCM Distribution Point (DP).
To install the Bot Agent, configure the DP on the primary server on which the Control Room is installed. It is important to ensure that after the application is created, it is distributed properly to DP and it can be monitored in SCCM.
For more information, see [Install and configure distribution points in Configuration Manager](#).
4. Use boundaries in SCCM to virtually partition the devices identified through domains, subnets, or a range of IP addresses.
Boundaries help in segregating the DP for different applications and can be configured through the hierarchy configuration section from the Administration option of SCCM.
For more information, see [Define network locations as boundaries for Configuration Manager](#).
5. Right-click Automation Anywhere Bot Agent application to deploy the Bot Agent using the SCCM Applications option.
For more information, see [Deploy applications with Configuration Manager](#).
6. Verify that the devices are added on the Control Room **Devices** page.

Related tasks

[Install Bot Agent and register device](#)

The Bot Agent is a lightweight application that enables you to run bots on your device by connecting the device to the Control Room. To run bots on a local machine, install the Bot Agent and add the local device to the list of enabled host devices.

[Perform bulk installation of Bot Agent on devices](#)

Edit the Bot Agent MSI file to bulk install (or silently install) the Bot Agent on permanent and temporary devices such as on-premises machines, virtual machines (VM), and non-persistent virtual desktop infrastructure (VDI), for example Citrix, in the Control Room.

[Edit the Bot Agent installer file](#)

Edit the Bot Agent MSI installer file to add the registration key and Control Room URL to remotely install the Bot Agent on multiple devices.

Related reference

[Devices](#)

The device is a machine through which a user connects to the Control Room to create or run bots. Manage devices that are registered to the Control Room through the **Devices** page located in the **Manage** tab.

Automatically update the Bot Agent

A Control Room administrator can choose to automatically update the Bot Agent to a later version using the auto-update capability. This reduces the downtime because each user is not required to log in to the Control Room to update the Bot Agent installed on the user device.

Ensure that you are logged in to the [Control Room](#) as the administrator.

The Bot Agent will auto-update based on the following:

- All user devices are connected to the Control Room.
- The Automation 360 deployment you use.

Note: Automatic update of the Bot Agent is available only for version 21.0 or later. The auto-update setting is enabled by default for the Automation 360 Cloud and Community Edition. For On-Premises deployments, the manual update setting is enabled by default.

To manually update Bot Agent, see [Manually update the Bot Agent](#).

1. Navigate to **Administration > Settings > Devices**.
2. Select **Bot-agent software** settings.
3. Click the **Edit** icon. (✎)
4. For automatic updates of the Bot Agent, you can choose either all updates (required and optional) or only the required updates.

Option	Description
Auto update optional and mandatory	Automatically update the Bot Agent for both required and optional updates. During the update, new bot deployments on the Bot Runner user devices are queued.
Auto update mandatory updates only	Automatically update the Bot Agent only for required updates. During the update, new bot deployments on the Bot Runner user devices are queued.

Note: To set manually update the Bot Agent, choose **Disable auto updates** option.

5. Optional: [Update the Bot Agent from a local drive](#).
6. Click **Save changes**.

Verify the Bot Agent version and device connection in the **My Devices** page of the Control Room.

Related tasks

[Manually update the Bot Agent](#)

The Bot Agent is a lightweight application with which you can run bots on your device. You can update the Bot Agent when a new version becomes available.

Related reference

[Devices](#)

The device is a machine through which a user connects to the Control Room to create or run bots. Manage devices that are registered to the Control Room through the **Devices** page located in the **Manage** tab.

[Bot Agent compatibility](#)

Before you install the Bot Agent, ensure that it is compatible with the hardware and software in your environment.

Update the Bot Agent from a local drive

As a Control Room administrator, you can download the Bot Agent installation file to a local machine and update the Bot Agent from the local drive.

Ensure that the Bot Agent installation file is downloaded to the local machine.

Important: This functionality is implemented in v.26 and can be used from v.27. That is, after you update your Bot Agent to v.26, future updates can be performed from the local drive.

Update the Bot Agent on several devices by providing the local file path to the installation file.

1. Navigate to **Administration > Settings > Devices** and click the **Edit** icon (✎).
2. Go to the **Bot-agent software** settings.
3. Click the **Edit** icon. (✎)
4. In the **Bot agent installation** section, select the **Update bot agent from local drive** option.

When the **Update bot agent from local drive** option is enabled, the device checks for the installation file in the local drive and use it to update the Bot Agent.

Note: If an installation file is not available in the local drive or not compatible with Control Room, the Bot Agent will be updated with the latest version from the Control Room.

5. Enter the file path to the Bot Agent installation file in your local drive.

For example: `C:\Temp\AutomationAnywhereBotAgent.exe` or `\\network-share-name\foldername1\AutomationAnywhereBotAgent.exe`

6. Click **Save changes**.

Manually update the Bot Agent

The Bot Agent is a lightweight application with which you can run bots on your device. You can update the Bot Agent when a new version becomes available.

- To install the Bot Agent, the Windows installer policy must be enabled for the user device.
- The read, write, and execute permissions must be enabled for the Bot Agent folders on the user device.

The Bot Agent version available for download is the latest and compatible with the Control Room version that is used. See [Bot Agent compatibility](#).

Note: You can update to the latest Bot Agent version to use the new features available in the latest Automation 360 release. However, some Bot Agent versions are optional to update and does not affect your existing bots. See [Bot Agent compatibility](#).

- **Update the Bot Agent on connected host devices**

a) Log in to the Control Room by using your Automation Anywhere URL.

b) Navigate to **Manage > Devices**.

On the **Devices** page, the device status indicates whether the Bot Agent requires an update. The arrow color on the device icon indicates the status:

- Red: Update required
- Blue: Update available but not required
- Green: Current version; no update required

c) To update the Bot Agent on devices, select the devices for which you want the Bot Agent to be updated and, at the top-right corner of the devices table, click the **Update checked items** icon (☰).

The **Status** for the devices changes to indicate the progress of the update. After the update is complete, the **Status** will be changed to **Connected**.

Note: You can also update a single device with row-level actions.

Video: See the following video on updating the Bot Agent on connected host devices:

<https://aa2019packagesdkfordocumentation.s3-us-west-2.amazonaws.com/videos/bot-agent-update-connected-hosts.mp4>

- **Update the Bot Agent on a locally connected device or a remote device using the local device option**

You can update the Bot Agent on a locally connected device or a remote device without manually downloading and installing the Bot Agent.

a) On the home screen, at the bottom-left corner, click the **Local device** icon (⋮).

b) In the **Bot running device** window, click **Update now**.

The **Status** for the devices changes to indicate the progress of the update. After the update is complete, the **Status** changes to **Connected**.

Video: See the following video on how to update the Bot Agent on a locally connected device:

<https://aa2019packagesdkfordocumentation.s3-us-west-2.amazonaws.com/videos/bot-agent-update-local-device.mp4>

Video: See the following video on how to update the Bot Agent on a remote device using the local device option:

<https://aa2019packagesdkfordocumentation.s3-us-west-2.amazonaws.com/videos/bot-agent-update-remote-device.mp4>

- **Update Bot Agent on the locally connected device using the connect local device option**

You can update the Bot Agent on your locally connected device by manually downloading and installing the Bot Agent.

- a) From the Devices page, click the **Connect local device** icon (🔌) at the top-right corner of the devices table.
- b) Click **Connect to my computer**.
- c) Click the **Manually download the latest version** link.
- d) After the `AutomationAnywhereBotAgent.exe` is downloaded, install the Bot Agent and follow the instructions on the installation wizard to complete the installation.
- e) After the Bot Agent installation is complete, go back to Automation 360 Control Room and click **Next**.
- f) Follow the instructions on the screen to complete the update.

Video: See the following video on how to update the Bot Agent on the locally connected device using the connect local device option:

<https://fast.wistia.net/embed/iframe/prm89rldzp>

The following message is displayed: `Connected to your computer. Your local bot agent has been successfully installed configured.`

If you see the following message displayed: `Device is disconnected or needs upgrade!`, see [Error: Device is disconnected or needs upgrade \(A-People login required\)](#)

Verify the Bot Agent version and device connection in the **Devices** page of the Control Room.

Related tasks

[Automatically update the Bot Agent](#)

A Control Room administrator can choose to automatically update the Bot Agent to a later version using the auto-update capability. This reduces the downtime because each user is not required to log in to the Control Room to update the Bot Agent installed on the user device.

Related reference

[Devices](#)

The device is a machine through which a user connects to the Control Room to create or run bots. Manage devices that are registered to the Control Room through the **Devices** page located in the **Manage** tab.

[Bot Agent compatibility](#)

Before you install the Bot Agent, ensure that it is compatible with the hardware and software in your environment.

Switch Bot Agent to a different Control Room

Switch the Bot Agent on a registered device to work with a different Control Room manually when you work on automations using different environments.

Ensure that you have the start, stop, and pause permissions to access and edit the Windows services.

Perform this task to manually associate your device with a different Control Room in the following scenarios:

- When the Control Room is on a different release version.
- When the setting to switch devices is **not** enabled in the Control Room.

1. Stop the Bot Agent service from the local Windows Task Manager.

2. Navigate to the following folder: `C:\Windows\System32\config\systemprofile\AppData\Local\AutomationAnywhere`
3. Optional: Delete the `registration.properties` file.

Note: This is only required if you want to register the device in a different Control Room environment. To view the Control Room where the device is registered, open the `registration.properties` file and check the value for the Control Room URL.

4. Delete all `.db` files.
For example, `AA-DB.mv.db` file.
5. Log in to the Control Room.
6. Navigate to **Devices > My devices**.
7. Click the **Add local device** icon.
8. Download and install the latest Bot Agent.
9. Return to the **Devices** page in the Control Room from the updated device to check the device status.
The `registration.properties` file is not generated immediately after the Bot Agent installation. It is generated only when a user accesses a Control Room URL from that device. If the device registration is successful, the machine is shown as **Connected** and the `registration.properties` file is created at the specified location on the Bot Runner machine.
10. Navigate to the `C:\Windows\System32\config\systemprofile\AppData\Local\AutomationAnywhere` folder to ensure that the `registration.properties` file is present and verify the Bot Agent update.

<https://fast.wistia.net/embed/iframe/prm89rldzp>

Related tasks

[Install Bot Agent and register device](#)

The Bot Agent is a lightweight application that enables you to run bots on your device by connecting the device to the Control Room. To run bots on a local machine, install the Bot Agent and add the local device to the list of enabled host devices.

[Switch device registration between Control Room instances](#)

Configure the device settings in the Control Room to enable single-user devices to easily switch between different instances of the Control Room to run bots in multiple environments. This option enables you to register the Bot Agent on multiple Control Room instances without uninstalling the Bot Agent.

Connect Bot Agent to a device with a proxy

When you install a Bot Agent, your device proxy settings are imported during the installation process. However, if the proxy settings are not imported during installation, you can update the proxy configuration details manually.

Typically, when you change your proxy settings, whether you added a proxy or changed the credentials to the authenticating proxy, the Bot Agent prompts for the new credentials.

You can use two methods to add or update proxy credentials manually.

- Using `PSEXEC -sid` command.
- Using `netsh winhttp` command.

You can perform these steps before or after installing the Bot Agent.

1. Use any one of the following methods to add or update proxy credentials.

- Using `PSEXEC -sid` command.

a. Download PSTools.

[PsExec](#)

b. Extract the files from downloaded zip file.

c. Open the Microsoft command prompt in administrator mode.

d. Change to the directory where you extracted the PSTools files.

e. Execute the following command:

```
.\psexec -i -s -d cmd
```

f. In the new command prompt window, execute the following command:

```
whoami
```

The system returns the following:

```
nt authority\system
```

g. Execute the following command:

```
inetcpl.cpl
```

h. In the **Internet Properties**, navigate to **Connections > LAN settings**.

i. Select the **Use automatic configuration script** option.

j. Provide the address to the proxy auto-configuration (PAC) file.

For example: `http://localhost:888/proxy.pac`.

k. Click **OK**.

- Using `netsh winhttp` command.

a. Open the Microsoft command prompt in administrator mode.

b. List the proxy status by running the command:

```
netsh winhttp show proxy
```

c. If the command returns `Direct access`, then run the command:

```
netsh winhttp import proxy source = ie
```

If proxy settings are configured, the command returns the proxy server address. See following sample:

```
Current WinHTTP proxy settings:  
Proxy server(s) : 123.0.0.4:1234
```

```
Bypass List      : (none)
```

You do not have to import the settings.

Note: We recommend you import proxy settings using Bot Agent installer because of limitations to importing PAC file using the `netsh winhttp import proxy source = ie` command.

2. Restart the Bot Agent service from Windows services.
3. Open a Google Chrome browser with the Automation Anywhere extension enabled.
4. Log out and log back in to the Control Room.
If prompted, provide the proxy credentials.
5. From the Control Room, check the device status and verify that it is connected.

Related reference

[Automation 360 Bot Runner device requirements](#)

Review the machine hardware specifications, operating system versions, and browser types supported by Automation 360 Cloud for creating and running bots on a device. The same requirements are also valid for Automation 360 Community Edition.

[Bot Agent compatibility](#)

Before you install the Bot Agent, ensure that it is compatible with the hardware and software in your environment.

[Add Automation 360 Cloud DNS to trusted list](#)

To ensure secure access to Automation 360 cloud services, add specific Automation Anywhere Domain Name System (DNS) to the safe recipients or trusted list.

[Add Automation 360 On-Premises DNS to trusted list](#)

To ensure secure access to Automation 360 online services for On-Premises deployment, add specific Automation Anywhere Domain Name System (DNS) to the safe recipients or trusted list on each user device.

Perform Bot Agent diagnostic checks

Use the Bot Agent diagnostic utility for connectivity-related issues between the Bot Runner device and Control Room. The utility helps to diagnose issues either by providing solutions or suggestions to help resolve the issues.

Ensure the Bot Agent is installed on the user device.

1. Open the Windows command prompt.
2. Navigate to the Bot Agent installation path.
 - Default path for Bot Agent installed at system level is `C:\Program Files\Automation Anywhere\Bot Agent`.
 - Default path for Bot Agent installed at local user level is `%USERPROFILE%\AppData\Local\Programs\Automation Anywhere\Bot Agent`.

3. Enter `AADiagnosticUtility.exe` to run the Bot Agent diagnostic utility.
 Various options to perform the diagnostic check are displayed with their descriptions.

Option	Description
<code>-checkDownloadError <CR_URL></code>	<p>Check for bot dependency download errors if the bot deployment fails.</p> <hr/> <p>Note: Error messages are maintained in the device memory and are removed when the Bot Agent service is restarted.</p> <hr/> <p>Use this option when the Bot Runner device is connected to the Control Room but automations fail because the dependent packages are not downloaded on the Bot Runner device. In this case, the utility provides suggestions for further diagnosis.</p>
<code>-checkProxy <CR_URL></code>	<p>Check the proxy settings on the device.</p> <p>When the Bot Runner device is unable to connect to the Control Room, use this option to verify if a proxy is available or configured for the Bot Agent to use.</p> <p>You are also provided the option to import proxy settings using the <code>importProxy</code> option.</p>
<code>-checkWSError <CR_URL></code>	<p>Check for WebSocket connectivity and errors.</p> <hr/> <p>Note: Error messages are maintained in the device memory and are removed when the Bot Agent service is restarted from Services tab of the Windows Task Manager.</p> <hr/> <p>When a Bot Runner device is unable to connect to the Control Room because of WebSocket connection errors, this option provides the possible reasons for further investigation.</p>

Option	Description
<pre>-collectLogs</pre>	<p>Reduce the turnaround time for collecting information on issues by capturing multiple logs for the Bot Runner device.</p> <p>Use this option to capture and save current day node manager, bot launcher, and event viewer logs for debugging and troubleshooting in a zipped folder on the device where the utility is being run.</p> <ul style="list-style-type: none"> For Bot Agent installed at system level, the logs are saved in C: <pre>\ProgramData\AutomationAnywhere \BotRunner\Logs \bot_agent_logs_<datetimestamp>.zip</pre> For Bot Agent installed at local-user level, the logs are saved in %USERPROFILE% <pre>\AppData\Local\AutomationAnywhere \BotRunner\Logs \bot_agent_logs_<datetimestamp>.zip</pre> <hr/> <p>Recommendation:</p> <ul style="list-style-type: none"> To capture Windows logs for security events, run the utility with elevated privileges (run as administrator). <p>If you run the utility without elevated privileges, the following error is displayed:</p> <pre>Error: Unable to capture security_event_viewer_<date>.evtx</pre> <ul style="list-style-type: none"> To save storage space, delete the file after debugging. <hr/>
<pre>-configProxy <CR_URL></pre>	<p>Check proxy configuration and configure proxy credentials, if required.</p> <p>When the Bot Runner device is unable to connect to the Control Room because of missing credentials for an authenticated server, use this option to configure the proxy server credentials. Verify that the connectivity problem is resolved by logging in to the Control Room.</p>

Option	Description
<pre>-importProxy <CR_URL></pre>	<p>Import the proxy settings from a logged-in user device to the system user device.</p> <hr/> <p>Note: You must have administrator permission to import proxy settings.</p> <hr/> <p>When the Bot Runner device is unable to connect to the Control Room because of proxy server issues, use this option to import the proxy settings from a logged-in user to the system user for the Bot Agent.</p> <p>This option provides information about the following:</p> <ul style="list-style-type: none"> • Whether the proxy server is authenticated or not. • Control Room URL is added to the safe recipients list in the proxy server. • WebSocket connections are allowed as part of the proxy configuration.
<pre>-importSSLCertificate path_to_ssl_certificate</pre>	<p>Import a SSL certificate into the Java credential store, if required.</p> <hr/> <p>Note: You must have administrator permission to import the SSL certificate.</p> <hr/> <p>When the Bot Runner device is unable to connect to the Control Room because of an invalid SSL certificate, use this option to import the SSL certificate. You must ensure a valid certificate file is available in the file location specified in the <code>importSSLCertificatepath_to_ssl_certificate</code> option.</p> <p>You must restart the Automation Anywhere Bot Agent service so that the imported certificate becomes effective.</p>
<pre>-list</pre>	<p>View active bot deployments on the local devices.</p> <p>Use this option to check and list the automation (bots) that are running.</p>
<pre>-ping <CR_URL></pre>	<p>Check connectivity between the Control Room and Bot Runner devices.</p> <p>Use this option to check if a Bot Runner device can ping (reach) the Control Room.</p>

Option	Description
<code>-validateSSLCertificate <CR_URL></code>	<p>Check for a valid SSL certificate and view whether the certificate is valid or invalid.</p> <hr/> <p>Note: You must have read permission to perform this check.</p> <hr/> <p>When the Bot Runner device is unable to connect to the Control Room because of an invalid SSL certificate, use this option to check and view if the SSL certificate is valid or not. To resolve the issue, use the <code>importSSLCertificate</code> option.</p>

4. Enter the following option in the command prompt: `<filepath>\AADiagnosticUtility.exe -
<option> <CR_URL>`
- For example, to verify WebSocket errors, enter the following in the command prompt:
`AADiagnosticUtility.exe -checkWSError https://yourcrurl.com/`
- The option returns the following result: `Recently this device have not encountered any Web Socket errors`
- Use the other options to perform further diagnostic checks.

Set user device credentials

To enable a device for running bots, set the local device credentials.

The Bot Agent is a lightweight application that enables you to run bots on your device by connecting the device to the Control Room. To run bots on a local machine, install the Bot Agent and add the local device to the list of enabled host devices. Add the local device before editing the credentials. See [Install Bot Agent and register device](#).

For Community Edition users, your profile contains only one set of credentials at a time. These credentials are applied to any of your registered devices you select to run your bots. Ensure each device that you use accepts the credentials in your profile.

Automation 360 Cloud users have the option to apply different credentials to registered devices.

1. In the Control Room panel, click your user name and select **My settings**.
2. In **My Settings** page, navigate to **Devices > Credentials** section to update the **Username** and **Password** for the device.

Device login credentials are required to run a bot from this device.

Note: Automation 360 does not validate the device login credentials until you run a bot.

If your username is part of a domain, include the domain within the format `domain\username`. Typically, home users are not part of a domain, unless they are specifically configured.

3. Save the changes.

[Create your first bot](#)

Related tasks

[Install Bot Agent and register device](#)

The Bot Agent is a lightweight application that enables you to run bots on your device by connecting the device to the Control Room. To run bots on a local machine, install the Bot Agent and add the local device to the list of enabled host devices.

View and update Bot Agent device settings

View your local device details and update the bot running device settings. The local device is the one from which you access the Bot Agent. The bot running device is the one on which the recorder will record your automations and run the bots.

You must have the register device, view and manage all devices, attest device credentials, and edit devices permissions to perform this task. See [Credential requirements](#).

This task is performed by a user to select a local user or remote Bot Agent device to create and run bots.

1. In the Control Room, click your username and select the **My settings** link.
2. In the **Devices > Bot running device** section, click **Edit**.
3. Select a bot running device.
4. Save the changes.

Note: To update the local device settings, click the device name link. This will open the **Devices** page for your local device in view mode.

Related tasks

[Customize device settings](#)

Customize the settings for user devices at the device level such as device lifespan, auto-login, screen resolution, deployment, and other advanced options.

Create your first bot

Perform the following steps to create your first bot that prints the message, `Go be great!`, the Automation Anywhere version of `Hello World!`

naming conventions: Keep the following considerations in mind when creating and naming :

- When creating a , ensure that your name does not include the following special characters:

Slash (/)	Asterisk (*)	Comma (,)
Backslash (\)	Less than sign (<)	Left or right braces ({})
Question mark (?)	Greater than sign (>)	Left or right brackets ([])
Pipe ()	Double quotation marks (")	Plus sign (+)
Percent sign (%)	--	--

- The name must be unique. If a with the same name exists in the same folder location to which you have access in the public workspace, you cannot create or rename the with this name in the private workspace.
- Do not use names that are reserved for the Windows operating system. The reserved names are as follows:

CON	PRN	AUX	NUL	COM1
COM2	COM3	COM4	COM5	COM6

COM7	COM8	COM9	LPT1	LPT2
LPT3	LPT4	LPT5	LPT6	LPT7
LPT8	LPT9	--	--	--

- Ensure that a name does not end with a period (.) or space.
- For more information about file naming, see [Microsoft guidelines](#).

This task is performed by the user who wants to build and deploy . You must have the necessary rights and permissions to complete this task, and authorization to log in to the as the licensed user.

Note: These steps describe the guided workflow for first time users. The guided workflow is only displayed the very first time you complete these steps.

1. Log in to your instance of the Automation Anywhere Control Room.
2. Create a new bot:
 - a) On the left panel, click **Automation**.
 - b) Click **Create new > Bot**.
 - c) In the **Create Task Bot** window, enter the bot name.
 - d) Accept the default folder location: `\Bots\`
To change the default bot storage location, click **Choose** and follow the prompts.
 - e) Click **Create and edit**.
3. Insert a **Message box** action.
 - a) Click **Actions**.
 - b) Search for the Message Box package.
Click in the **Actions** search box and enter `message`. Click the arrow to expand the Message Box options.
 - c) Double-click or drag the **Message box** action to the Bot editor (open space to the right).
4. In the dialog box on the right, specify the conditions for the **Message box** action.
 - a) In the **Enter the message box window title** field, enter `My first bot!`.
 - b) In the **Enter the message to display** field, enter `Go be great!`.
 - c) Accept the defaults in the **Scrollbar after lines** field and **Close message box after** check box.
5. Click **Save**.
Your bot is now ready to run.
You can view the time spent to create a bot by navigating to **Automation > Home > My metrics**. The **Active Task Bots** table displays the time taken to create every bot. When a bot is edited, the table shows the total time spent on the bot.
For example, if you spend 10 minutes on creating and saving a bot, the **Active Task Bots** table displays the time spent as 10 minutes. If you spend 5 more minutes on editing the same bot, the **Active Task Bots** table displays the total time spent as 15 minutes.
Similarly, the **Average time spent to create a Task Bot** field on the **My Metrics** page displays the average time spent across all users on all bots.
For example, if user 1 spends 120 minutes on **Bot A**, user 2 spends 2 minutes on **Bot B**, and user 3 spends 4 minutes on **Bot C**, the average time is calculated as $(120+2+4)/3 = 42$ minutes.

- Click through the Bot editor options for viewing and editing bots:
They are located at the top of the Bot editor.

Note: You can use the search box in the **Flow**, **List**, or **Dual** view to search for text, variables, or actions in a bot. This feature can be helpful when you view or edit a bot with longer code lines.

- Flow:** Displays actions used in an automation as a flow diagram (Default)

Note: The **Flow** view is not available when you create or edit a bot and the bot exceeds 500 lines of code. Use the **Show list view** option to navigate to the list view.

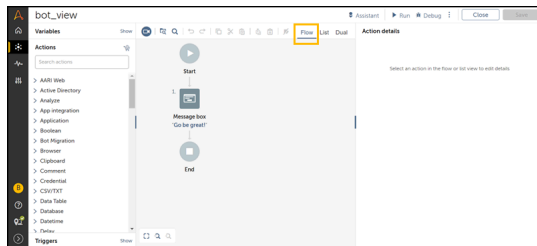

- List:** Displays the actions used in an automation as a list

Note: Drag the selected actions within the task logic.

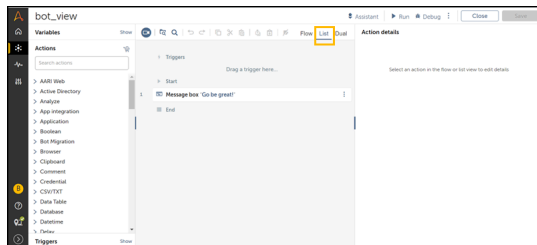

- Dual:** Displays the actions used in an automation from both **Flow** and **List** view aspects

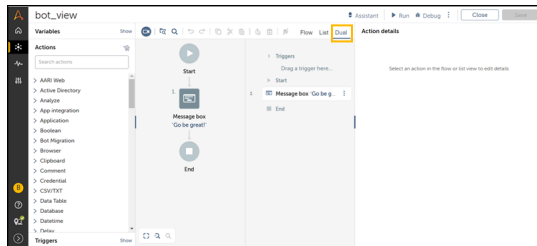

- Run your bot from your device.
See [Run your first bot](#).

Run your first bot

Run a bot from the same device that you used to create the bot.

Log in to your instance of the Automation Anywhere Control Room, and complete these steps:

- [Install Bot Agent and register device](#)
- [Set user device credentials](#)
- [Create your first bot](#)

These steps describe the guided workflow for first-time users. The guided workflow is only displayed the very first time you complete these steps.

You can run a bot from the following devices:

- The same device you are using to log in to the Control Room.
- Another device you registered that has the same login credentials as the machine you are using to log in to your Community Control Room or a device with defined credentials in the Control Room.

Note: Windows NT LAN Manager (NTLM) is a challenge or response authentication method that enables clients to provide their user name and password as encrypted credentials or plain text. Use Google Chrome browser to enable the Automation Anywhere extension and capture the proxy information. After the proxy information is captured, you can use any browser to run a bot in Automation 360.

1. Locate and select your bot.

From your Control Room dashboard left panel, select **Automation**. A list of available bots and forms is displayed.

2. Select the bot to run.

From the **Files and folders** table, mouse over the ellipsis (three stacked dots) to the right of your bot's name.

The **Edit TaskBot** panel appears.

3. Click the **Run Task bot** icon.

The **Run bot now** window opens. In the **Task Bots** table, your bot is selected to run.

4. Click **Next**.

The **Device** tab opens with a table of one or more registered devices.

5. If your device is not already selected, select your device to run the bot, and click the right arrow.

6. Click **Run bot now**.

Control Room uses the credentials in your profile to log in to the device you selected and runs the bot.

The **In progress activity** window opens with the status of the running bot. When the bot is done, it disappears from this window.

7. Click **Historical** to see if your bot ran successfully.

Watch the following video on how to run your first bot in the Community Edition:

Build bots using variables, actions, and the Universal Recorder. See [Get started building bots](#).

Update to latest Automation 360 version

If you are already using Automation 360 On-Premises, you can update to the latest version of Automation 360.

- Before each release update, ensure that you back up the database, repository, and installation configuration files.
- Ensure you are on one of the previous three releases from the latest release (on an $n-3$ release, where n refers to the latest release).

For example, to update to Automation 360 v.21 release, you must be on the v.20, v.19, or v.18 release. However, to update from v.15 to Automation 360 v.21 release, you must first update to v.18 release and then update to Automation 360 v.21 release. In the second scenario, ensure you perform backup of v.15 data before you update to v.18, and then backup v.18 data before you update to v.21.

Important:

- You must perform the following steps before you upgrade to the latest version of Automation 360:
 - Ensure you reconfigure the settings for `log4j2.xml` files after the installation because when you upgrade, the previous settings set at log level in log4j2 change back to default.
 - Configure the SSL settings (certificates) every time you upgrade.
- When you update from an Automation 360 release earlier than an n-3 release to the latest release, you might see an Elasticsearch Open Distro error message. Before updating, delete the multiple `application_log` indices from Elasticsearch, which will free up disk space for the update.

For details on the Elasticsearch indices limit, see [Cluster-level shard allocation and routing settings](#).

- Before you update from Automation 360 On-Premises v.22 to the latest release, see [A360 | Upgrading to A360.23, A360.24, A360.25 from A360.22 \(A-People login required\)](#)
- When you update to Automation 360 v.25 from an earlier release, an error might occur when the database server includes the instance name. In such a scenario, remove the instance name in the database server and continue with the installation.

For information on removing the instance name from the database server, see [Error parsing the SQL instance name while upgrading to Automation 360 v.25 \(A-People login required\)](#).

-
1. Log in to Automation Anywhere Support site to download the latest version of the Automation 360 setup file: [A-People Downloads page \(Login required\)](#).
 2. On the Downloads page, click the link to the latest Automation 360 setup file.
 3. Click `Installation Setup`, and then click either `Linux Setup` or `Windows Setup` based on the operating system of the machine on which you want to install Automation 360.
 4. Download the `Automation360_Build_<build-number>.<file-extension>` file.
 5. Install the latest version of Automation 360 without uninstalling your current version.

[Installing Control Room On-Premises](#)

Important: You must use the SQL database of the current version in the newer version of Automation 360.

<https://fast.wistia.net/embed/iframe/1n4l7m9bbv>

Related concepts

[Migrate to Automation 360](#)

Update Automation 360 on Microsoft Windows Server using scripts

Update Automation 360 using a customized script with parameters to maintain existing user configurations.

To perform this task, you must be a administrator and have the required rights and permissions.

- Verify [Automation 360 On-Premises prerequisites](#).
- Ensure that you have the following:
 - Automation Anywhere Control Room installation file
 - TLS certificate
 - License file

Sample config.properties file: For your reference, you can find a sample `config.properties` file at the end of the page.

Create and run a PowerShell script to update Automation 360.

1. Create a PowerShell script with the required parameters:

The following is a sample PowerShell script for upgrading Automation 360:

```
# Script Begins
# It fetches Data from config.properties file present under the same
  directory level

$PropertyFilePath = 'C:\script\config.properties'
$rawProperties = cat $PropertyFilePath
$propertiesToConvert = ($rawProperties -replace '\\\','\\') -join
  [Environment]:: NewLine;
$properties=ConvertFrom-StringData $propertiesToConvert
$env:SEE_MASK_NOZONECHECKS = 1

# Setting up the logger and InstallerRoot Directory

$baseLogFilePath=$properties.baseLoggingDirectory
$logFilePath=$baseLogFilePath+'Express_CR_Installation_Scenario1.txt'
$baseInstallerPath=$properties.baseInstallerDirectory
$installer_name_regex=$properties.installerNameRegex

# Logging Begins

Start-Transcript -Path $logFilePath -Append -IncludeInvocationHeader

$binary = Get-ChildItem $baseInstallerPath | Where-Object { $_.FullName -
  imatch $installer_name_regex }
$a = $binary.FullName
$final_commandline = " /update /s /v/qn /v""/L*v
  CR_Onprem_Installationlog_Scenario1.txt""

# Recording the Start Time
Get-Date -Format g

# Invoking the Installer here
$processdetail = (Start-Process -FilePath $a -ArgumentList
  $final_commandline -Wait -Passthru).ExitCode

# Recording the End Time
Get-Date -Format g

Stop-Transcript
```

2. Optional: Customize the script to include parameters according to your requirements.

3. Save the script to the installation server.

4. Log in to the installation server as administrator.

5. Start PowerShell in administrator mode.

6. Run the following:

```
Set-ExecutionPolicy Unrestricted -Scope CurrentUser -Force
.\install.ps1
```

Note: The silent installation logs are stored in the folder from which the installation script is run. For example, if you run the script from C:\Silent Install, the logs are stored in the C:\Silent Install folder.

7. Validate the following:

- All Automation Anywhere services are running in Windows Task Manager.

[Verifying Automation Anywhere services](#)

- You are able to log in to the Control Room from a supported browser.

[Log in to Automation Anywhere Control Room](#)

- You are able to install the required license in the Control Room.

[Installing additional licenses](#)

- All automations (deployed and scheduled) are running in the Control Room.

[Activities](#)

Example of config.properties file

```
# Properties utilized across all Scenarios
# Reference of Scenarios ,please check - https://
automationanywhere.atlassian.net/wiki/spaces/EN/pages/1789887938/
A2019.09+Windows+On+Prem+Installer

# Default/Express Mode Params

baseLoggingDirectory=C:\script\logs\
baseInstallerDirectory=C:\script\
installerNameRegex=AutomationAnywhereEnterprise_A2019
```

Enhancements to browser extensions

Create automation from supported browsers by using browser extensions. Extensions are periodically updated to support feature enhancements and fixes. Therefore, ensure that you have the latest versions of extensions for the Google Chrome, Microsoft Edge, and Mozilla Firefox browsers.

Before you download the latest version of a browser extension, review the information in the following tables:

Browser extension for Manifest V3

Extension name	Extension version	Link to extension
Google Chrome	3.0.6.0	Google Chrome extension for Automation 360
Microsoft Edge based on Chromium	3.0.6.0	Microsoft Edge extension for Automation 360

Fixes in version 3.0.6.0:

- In the Recorder package, you can now use the **Left click**, **Right click**, and **Set Text** with delay actions for cross-domain IFrames to automate web pages on Google Chrome and Microsoft Edge browsers with Manifest V3 extensions. Previously, these actions were not working for cross-domain IFrames with Manifest V3 extensions.

- In the Recorder package, you can now use the **Click** action for the Link and Form tag controls that have inline scripting with JavaScript using Manifest V3 extensions.

Browser extensions for Manifest V2

Impact to our customers: Automations that use Google Chrome Manifest V2 based extensions will stop working sometime after June 2023. The deprecation timelines of Manifest V2 based extensions are currently under review and subject to change by Google.

- For Google Chrome Manifest V2 extensions timelines, see [Manifest V2 support timeline](#).
- For Microsoft Edge Manifest V2 extensions timelines, see [Overview and timelines for migrating to Manifest V3](#).

Extension name	Extension version	Link to extension
Google Chrome	1.7.0.0	Automation 360 extension for Chrome
Microsoft Edge based on Chromium	1.7.0.0	Automation 360 extension for Microsoft Edge
Mozilla Firefox	1.7.0.0	Automation 360 extension for Mozilla Firefox

Related concepts

[Automation 360 Release Notes](#)

Review the new capabilities, changes, fixes (resolved issues), security fixes, deprecated features, and limitations in each release.

Related reference

[Browser requirements for RPA Workspace](#)

Access the RPA Workspace interface from a browser. After you have installed and enabled extensions in the browser, perform several tasks through the RPA Workspace interface based on your user role and automation requirements.

[Bot Agent compatibility](#)

Before you install the Bot Agent, ensure that it is compatible with the hardware and software in your environment.

Browser extensions for web applications

You can create automations using the Google Chrome and Microsoft Edge browser extensions for web applications running on Google Chrome and Microsoft Edge, which enables you to automate with enhanced security and performance.

Features using browser extensions for web applications

The following Automation 360 features use the browser extensions for web applications running on Google Chrome or Microsoft Edge browsers:

- Automation of web applications through Universal Recorder or Browser package
- User interface-based triggers
- Bot Agent device registration with the Control Room

- Packages that use window titles, for example, OCR and **Mouse** > **Click**.

Use browser extensions to automate web applications

To automate web applications, the browser extensions capture the properties of the targeted UI elements, application window title, and URL that enables you to create or update the actions that are specific to the Recorder in the bots. Newly created or updated bots are then uploaded from the browser of the Bot Creator to the Control Room. All bots are stored in the Control Room along with the properties of the UI element. When a bot is running, browser extensions are used to automate actions on the targeted UI elements of the web-based business applications.

When a Bot Creator or a Bot Runner user connects to the Control Room for the first time over Google Chrome or Microsoft Edge browsers, the browser extensions enable you to register your device by automatically sharing the device name and windows username, with the Control Room.

Note: Firefox browser extension supports object-based automation of web applications running in Firefox browser. Registering your device over Firefox browser is not yet supported.

Install and update Automation 360 IQ Bot

This collection of topics guide you through the process of installing or setting up Automation 360 IQ Bot On-Premises and Cloud.

- [Automation 360 IQ Bot Cloud deployed](#)
- [Automation 360 IQ Bot On-Premises](#)

Automation 360 IQ Bot On-Premises

Step 1: Pre-installation

Go to Automation Anywhere support site and download the Automation 360 IQ Bot On-Premises package:

[A-People Downloads page \(Login required\)](#)

Note: Automation 360 IQ Bot On-Premises uses a 3-node cluster to ensure high availability (HA).

[High availability and disaster recovery overview](#)

Review and verify the requirements and options before installing IQ Bot. This topic provides you with important information about the supported operating systems, hardware and software requirements, and the prerequisite steps you have to complete even before you begin the installation process.

[IQ Bot installation prerequisites](#)

Verify the hardware, software, and configuration required

to install IQ Bot On-Premises.

Step 2: IQ Bot installation

Install IQ Bot using any of the following installation options:

[Installing IQ Bot in Express mode](#)

Install IQ Bot in Express mode with the default settings.

[Installing IQ Bot in Custom mode](#)

Use Custom mode to install IQ Bot with configuration details.

[Installing IQ Bot in Cluster mode](#)

Install IQ Bot in Cluster mode for improved throughput. IQ Bot supports clustering of up to five IQ Bot installations.

[Installing IQ Bot in Cluster mode on Amazon EC2](#)

Install IQ Bot in the cluster mode on Amazon Elastic Compute Cloud (Amazon EC2).

Step 3: Post installation

After downloading IQ Bot, register with the Control Room and do the various configurations as required. You would also go through the checklist to ensure all services, databases, tables, and configuration settings are in place.

[Postinstallation checklist](#)

Verify that IQ Bot is installed, ensure that the IQ Bot services are running using the healthcheck APIs, and register IQ Bot with the Control Room.

Step 4 (optional): Install an OCR engine

During IQ Bot installation, the system sets the latest version of Tesseract Optical Character Reader as the default OCR engine. To use a different engine, follow the steps in the respective link:

[Use Microsoft Azure Computer Vision OCR engine](#)

[Use ABBYY FineReader Engine OCR engine in IQ Bot](#)

[Use Google Vision API OCR engine](#)

[Use Tegaki API OCR engine](#)

Step 5: Login and set up the Control Room

Create and register IQ Bot specific users in the Control Room. Learn more about IQ Bot roles and access permissions:

[IQ Bot user personas and roles](#)

Next: Connect to IQ Bot with the assigned user role, and begin creating learning instances

[Automation 360 IQ Bot](#)

Automation 360 IQ Bot Cloud deployed

Follow these steps to deploy and register as a user:

Step 1: Pre-installation

If you are your company's principal administrator and ordered Cloud deployed Automation 360 IQ Bot, you receive an email from Automation Anywhere with your URL and credentials.

Step 2: Log in to IQ Bot

To log in to Automation 360, open the Control Room URL in your browser, enter your credentials in the login screen, and click **Log in**.

[Log in to Automation Anywhere Control Room](#)

Step 3: Set up the Control Room

Create and register IQ Bot specific users in the Control Room. Learn more about IQ Bot roles and access permissions:

[IQ Bot user personas and roles](#)

Next: Connect to IQ Bot with the assigned user role, and begin creating learning instances

Go to the Control Room dashboard to access the IQ Bot URL link.

[Automation 360 IQ Bot](#)

Related concepts

[Automation 360 IQ Bot](#)

Automate document-centric business processes, end to end, by using IQ Bot, a web-based, Cloud-native intelligent document processing solution that can read and process complex documents and email. This solution combines RPA with AI techniques to extract and classify semi-structured and unstructured data.

[Get started with Automation 360 Cloud](#)

Use these tasks to start creating and using bots with Automation 360 Cloud.

[Migrate to Automation 360 IQ Bot](#)

Migration is the process of upgrading from earlier versions of IQ Bot (Enterprise 11.x, 6.x, or 5.x) to the latest Automation 360 IQ Bot version. This includes replicating your existing database and repository, converting your bots to Automation 360 format, and migrating all the learning instances.

IQ Bot installation prerequisites

Verify the hardware, software, and configuration required to install IQ Bot On-Premises.

Note: This page applies to On-Premises installations only. For Cloud deployment, see [Automation 360 IQ Bot Cloud deployed](#).

Hardware and software requirements

Important: As a prerequisite step, open ports 4369 and 25672 and add inbound firewall rules to allow traffic to these ports on each target machine. To add nodes to the cluster, sync the RabbitMQ v3.8.18 cookies to enable running any RabbitMQ v3.8.18 commands. If IQ Bot is already installed on the target machine, clean up and remove the existing cookies.

[Automation 360 IQ Bot version compatibility](#)

[IQ Bot system requirements](#)

Prerequisite

[IQ Bot prerequisite steps](#)

[IQ Bot service configuration](#)

[IQ Bot Windows services](#)

[RabbitMQ v3.8.18 and Erlang/OTP upgrade](#)

[Installing IQ Bot in Cluster mode on machines with IQ Bot preinstalled](#)

[Prerequisites for installing IQ Bot in Express mode](#)

Installation limitations

Database encryption limitations

Installation time increases when encryption of the SQL database backup file is in progress, and also when the database backup file size increases.

The encryption process of the SQL database might result in the creation of large transaction logs. Allocate at least 3 to 4 times more disk space than the database backup file size.

Note: The following list of installation packages are not supported from Automation 360.27 release onwards:

- On-Premises custom fresh installation - Custom installation + HTTP + SQL authentication + local account installation
- On-Premises Express fresh installation
- On-Premises without internet fresh installation
- On-Premises GCP fresh and upgrade
- On-Premises SDS fresh installations (AD and Non-AD)
- On-Premises Migration from IQ Bot 11.x to On-Premises Automation 360.x using Migration Assistant Tool (MAT).

Note: The base version must be Version 11.3.5.6. Any customer on IQ Bot 11.x version prior to On-Premises must first upgrade to On-Premises and then migrate to Automation 360.27.

Related tasks

[Installing IQ Bot in Express mode](#)

Install IQ Bot in Express mode with the default settings.

[Installing IQ Bot in Custom mode](#)

Use Custom mode to install IQ Bot with configuration details.

IQ Bot system requirements

Review the operating system and database compatibility, database information, and the hardware and software requirements for Automation 360 IQ Bot.

Legal disclaimer: The information provided in this workflow might vary depending on which offering is being used. Administrative instructions might not be applicable to Automation 360 IQ Bot Community Edition.

Note: When you migrate from any of the earlier IQ Bot versions (11.x or 6.x) to Automation 360 IQ Bot, ensure that you update the Microsoft Windows Server Operating System to one of the versions listed in the table below.

The following table lists the Operating System and database compatibility with Automation 360 IQ Bot On-Premises:

Operating System	Supported platforms	Database type	Database version	Database edition
Microsoft Windows Server:	<ul style="list-style-type: none"> Microsoft Azure Virtual Machines Amazon Elastic Compute Cloud (Amazon EC2) Google Cloud Platform 	<ul style="list-style-type: none"> Microsoft SQL Azure (RTM) Amazon Relational Database Service (Amazon RDS) Microsoft SQL Server 	<ul style="list-style-type: none"> 2019 2017 2016 2014 2012 	<ul style="list-style-type: none"> Express Standard Enterprise

The following table provides the required database information:

Microsoft SQL Server and Amazon RDS databases	
Required information	Description
Database (SQL Server) authentication	Provide credentials for a Microsoft SQL Server user who has permission to connect to the database.
Database name	IQBot
Database port	Default: 1433
Service credentials	Provides the user with the following permissions: <ul style="list-style-type: none"> CONNECT SQL CREATE ANY DATABASE VIEW ANY DATABASE

Note:

If you are using an older version of the Microsoft SQL Server which does not support TLS 1.2, then you must keep a IQ Bot database backup and update to a Microsoft SQL Server version that supports TLS 1.2. For more information, see <https://support.microsoft.com/en-us/topic/kb3135244-tls-1-2-support-for-microsoft-sql-server-e4472ef8-90a9-13c1-e4d8-44aad198cdbe>.

Hardware requirements

IQ Bot	Minimum requirements
Application server	<ul style="list-style-type: none"> 32 GB RAM 8 Core Processor with support for AVX instructions set (this is a requirement starting from A2019.19) 500 GB hard disk space Ensure drive C has 100 GB plus free hard disk space
For all IQ Bot related database servers	<ul style="list-style-type: none"> 16 GB RAM 8 Core Processor 500 GB hard disk space <p>Note: If you are hosting IQ Bot databases along with other application databases, ensure the hardware resources are increased proportionately.</p>
Microsoft Azure SQL Database: production environment	<ul style="list-style-type: none"> vCore model (recommended) DTU model (Premium tier recommended)

Software requirements

Software	Details
Database Management System	Automation 360 IQ Bot feature comparison matrix
Automation Anywhere Control Room	Automation 360 IQ Bot version compatibility
Web browsers	Google Chrome 80 (or later) Microsoft Edge Chromium 98 (or later) Mozilla Firefox 80 (or later)
SMB File Share	Azure File Share with Server Message Block 2.0 and 3.x (SMB) protocol.

Software	Details
Dependencies	<p>Automation 360 requires the following software, which is automatically installed during the installation:</p> <ul style="list-style-type: none"> • Microsoft .NET Framework v4.7.2 <p>The system prompts for a restart to complete the update.</p> <ul style="list-style-type: none"> • Microsoft Visual C++ Redistributable 2017 x64 package • Erlang 25.1 (13.1) • RabbitMQ 3.10.8 • NodeJS v14.20.0 • Microsoft SQL Server 2012 Native Client- QFE • Python 3.11.0 (64 bit) • Java Virtual Machine (JVM) 8 <hr/> <p>Note: In a cluster environment, all dependencies are installed on each machine where IQ Bot is installed.</p>

Related reference

[IQ Bot installation prerequisites](#)

Verify the hardware, software, and configuration required to install IQ Bot On-Premises.

IQ Bot prerequisite steps

Complete the steps before you begin installing IQ Bot.

1. User needs to have either the *SYSADMIN* role or the following privileges for SQL database account as this is used during installation to create database and run the BULK INSERT statement.
 - SQL connection (CONNECT SQL)
 - Database creation (CREATE ANY DATABASE)
 - View any database (VIEW ANY DATABASE)

Note: Installation with Microsoft Azure SQL requires the *dbmanager* role.

Note: Installation with AWS RDS requires a role with the above three privileges. These privileges are already assigned to the *db_owner* role in RDS.

Grant permissions for a specific database user and see the permissions for that role using the following TSQL query:

```
SELECT * FROM fn_my_permissions(NULL, 'SERVER').
```

2. First enable HTTPS, to configure IQ Bot with HTTPS. Keep the following HTTPS certificate files ready for use:
 - Control Room certificate in `.cert` format (Certificate Authority list bundle).
 - Control Room certificate in `.cert` format (Server side public certificate).
 - IQ Bot server certificate in `.pfx` and `.cert` format.



Attention: Install the `.cert` certificates for Control Room manually to their appropriate certificate stores.

Note: See [Configuring IQ Bot with HTTP when Control Room is configured with HTTPS](#) for more information.

3. Keep the following ports open because they are used by IQ Bot services:
 - Application access port (configurable): 3000
 - Database access port (configurable): 1433
 - Internal application services ports (fixed): 8100, 9002, 9991, 9992, 9995, 9996, 9997, 9998, 9999
 - Inbound listening ports:
 - 47100-47200 on IQ Bot server for IQ Bot-Control Room communication.
 - 47100-47200 and 47500-47600 on Control Room server.
 - RabbitMQ v3.8.18
 - Port: 5672
 - Port: 5673
4. If your SQL Server version is older than *SQL Server Native Client 2012*, a dialog box appears, giving you the option to upgrade. Open `services.msc` and stop the SQL Server (MSSQLSERVER) to do the upgrade. Then continue with the installation process.
5. During the upgrade process, the installer will detect existing learning instances from a previous version of IQ Bot. To retain the original classifier for those learning instances, select that earlier version of IQ Bot from the drop-down list. This ensures consistency in the behavior of the learning instances with that earlier version.
6. IQ Bot installer is case sensitive about the user account created for SQL Server or Windows.



Attention: Use the username as it appears on the Microsoft SQL Server Management Studio under **Security > Logins**. If it was created in upper case, then use upper case for the username to launch the installer. Additionally, verify if the collation database property is set to case sensitive.

IQ Bot service configuration

In some IQ Bot deployments, the service account can be different from the login account. As an administrator, provide the service credentials during installation.

IQ Bot Installer supports service credentials during Microsoft Windows or SQL server authentication. When installing Services for IQ Bot, in the service installation window, the **Local System Account** check box is selected by default. You can deselect this and provide a username and password.

Note:

- Use Windows authentication with a valid system administration user in service configuration.

- Use Windows authentication with a local system for a system administration user.
- When using a remote SQL server to create a database, the combination of local system account for service credentials and Windows authentication for SQL connection is not supported.
- The service account used for IQ Bot services must have full rights to the IQ Bot installation folder.

If you do not select the **Local System Account** checkbox, provide your user credentials to run the IQ Bot Services.

Note:

- A valid system administrator user requires Windows authentication with the Services user credentials.
 - When entering user credentials, ensure the credentials are associated with a domain. For example: example.com/testuser. User is unable to use this function without the domain.
-

See [Installing IQ Bot in Custom mode](#) to view the use of service credentials in IQ Bot.

Related reference

[IQ Bot installation prerequisites](#)

Verify the hardware, software, and configuration required to install IQ Bot On-Premises.

IQ Bot Windows services

IQ Bot Windows services are automatically installed when running the installation and setup.

Make sure that the following Windows services are set when installing IQ Bot.

Service name	Description
Automation Anywhere Cognitive Alias	IQ Bot service that manages domains, domain dictionary, aliases, and languages supported in the system.
Automation Anywhere Cognitive Application	IQ Bot service that provides support for all Control Room integration points and information about IQ Bot application configuration.
Automation Anywhere Cognitive Classifier	IQ Bot service that provides support to classify documents in a learning instance, into different groups.
Automation Anywhere Cognitive Console	IQ Bot user interface. Note: In contrast to other services, the Automation Anywhere Cognitive Console service runs on the local user account rather than the domain or service account.
Automation Anywhere Cognitive File Manager	IQ Bot service that manages documents in the file management system.
Automation Anywhere Cognitive Gateway-2	IQ Bot Gateway for all the IQ Bot backend services, handling authorization and validation of request/response of APIs.
Automation Anywhere Cognitive MLScheduler Service	IQ Bot service scheduler for ML Web Service.

Service name	Description
Automation Anywhere Cognitive MLWeb Service	IQ Bot service that prepares models based on user validation.
Automation Anywhere Cognitive Projects	IQ Bot service managing learning instances.
Automation Anywhere Cognitive Report	IQ Bot dashboard.
Automation Anywhere Cognitive Validator	IQ Bot service to manage documents that go for validation.
Automation Anywhere Cognitive Visionbot Manager	IQ Bot service to manage vision bots in the system.
Automation Anywhere Cognitive VisionbotEngine Service	IQ Bot service to process document based on different inputs provided.

Note: All the services can be configured either in Local System or Domain account when IQ Bot is installed in Custom mode. For IQ Bot installed in Express mode, all the services are run in Local System account.

Related reference

[IQ Bot installation prerequisites](#)

Verify the hardware, software, and configuration required to install IQ Bot On-Premises.

RabbitMQ v3.8.18 and Erlang/OTP upgrade

The IQ Bot installation package includes the RabbitMQ v3.8.18 version 3.7.17 and Erlang/OTP version 22.0.

For Automation 360 IQ Bot, ensure that you download the Microsoft Visual C++ Redistributable 2017 x64 version because it is required for the latest version of Erlang/OTP.

The following information explains different scenarios for upgrading RabbitMQ v3.8.18/Erlang/OTP:

- **Fresh installation of IQ Bot**

For a fresh installation, you do not have to perform any additional steps, as RabbitMQ v3.8.18 Erlang/OTP are included in the IQ Bot installation package. These get installed automatically on the machine during the installation process.

- **Upgrade from previous version of IQ Bot**

Uninstall the earlier version of RabbitMQ v3.8.18 / Erlang/OTP.

1. Uninstall existing RabbitMQ v3.8.18 and Erlang/OTP from the Control Panel.
2. Run the `Cleanup_Components.bat` file as an administrator.
3. Restart your machine.
4. After running the scripts, verify that RabbitMQ v3.8.18 and Erlang/OTP are removed completely. If not, uninstall them manually to delete any remaining files from the program files folder, and then repeat Step 3.

- **An earlier version of RabbitMQ v3.8.18/Erlang/OTP exists on the machine and the user wants to upgrade to the latest versions:**

You need to manually remove any older versions from the system using a batch utility file provided by Automation Anywhere. Contact the Automation Anywhere Support team to get the utility. You can then proceed with installing IQ Bot.

Related reference[IQ Bot installation prerequisites](#)

Verify the hardware, software, and configuration required to install IQ Bot On-Premises.

Installing IQ Bot in Cluster mode on machines with IQ Bot preinstalled

If you have IQ Bot already installed on your machine, uninstall IQ Bot, stop *RabbitMQ* service, and clean the existing RabbitMQ v3.8.18 cookies before installing IQ Bot in Cluster mode.

- Open ports 4369 and 25672 and add inbound firewall rules to allow traffic to these ports on each target machine.
- To add nodes to the cluster, sync the RabbitMQ v3.8.18 cookies to enable running any RabbitMQ v3.8.18 commands . If IQ Bot is already installed on the target machine, clean up and remove the existing cookies.

Follow the clean up procedure before setting up a cluster:

1. Uninstall IQ Bot from Program and Features.
2. Stop the RabbitMQ v3.8.18 service, by running the command: `net stop RabbitMQ /yes`.
3. Uninstall RabbitMQ v3.8.18 from `%Programfiles%\RabbitMQ Server\uninstall`.
4. Stop the `epmd.exe` and its descendants by running this command: `Taskkill /IM epmd.exe /F`.
5. Stop `erl.exe` and `erlsrv.exe` and its descendants by running the following commands:
 - a) `Taskkill /IM erl.exe /F`
 - b) `Taskkill /IM erlsrv.exe /F`
6. Uninstall Erlang from `%Programfiles%\erl8.2\Uninstall`.
7. Remove the following folders if they were not removed from the uninstall:
 - a) `%Programfiles%\Rabbit MQ Server`
 - b) `%Programfiles%\erl8.2`
8. Remove the following folders: `%appdata%\RabbitMQ`, `%WINDIR%\erlang.cookie`, `%USERPROFILE%\erlang.cookie`.

Do the following after completing the installation steps:

- The load balancer details for the following are available:
 - name of the load balancer
 - port
 - type of security used (For example, HTTP or HTTPS)
- Share a folder for configuring the output path.

Note: The user installing IQ Bot requires appropriate access permissions.

Related reference[IQ Bot installation prerequisites](#)

Verify the hardware, software, and configuration required to install IQ Bot On-Premises.

Prerequisites for installing IQ Bot in Express mode

Complete the prerequisites to set up *IQ Bot* in express mode.

Complete the following steps before you begin installing IQ Bot in express mode.

1. Install the Control Room in a version that is compatible with IQ Bot.
Automation 360 IQ Bot version compatibility
2. Ensure that SQL Server Browser service is up and running before installing IQ Bot in express mode.
3. Start the SQL Server Browser service in any one of the following ways:

Option 1	<ol style="list-style-type: none"> a. Launch the SQL Server Configuration Manager. b. Go to SQL Server Services. c. Start the SQL Server Browser services.
Option 2	<ol style="list-style-type: none"> a. Launch the Task Manager. b. Go to the Services tab. c. Start the SQLBrowser services.

4. Use the `Automation_Anywhere_IQ_BOT_<version_number>.exe` file to install IQ Bot.
5. The setup wizard guides you through the installation process. During installation, any software dependencies or missing prerequisites are installed.

Note: When a file is uploaded to a fresh IQ Bot instance, the database administrator is unable to extract any information about that file from the database as the data is encrypted.

6. Enable SQL authentication.
Enable the TCP protocol on the SQL server and listen to the local host at port 1433.
7. Set the SQL server instance name to `AACRSQLEXPRESS`.
8. Create a user with sysadmin permissions for username `aaadmin`, and password `aabots@123`.

See *Installing IQ Bot in Express mode* for steps to install in Express mode.

Related reference

[IQ Bot installation prerequisites](#)

Verify the hardware, software, and configuration required to install IQ Bot On-Premises.

Installing IQ Bot in Express mode

Install IQ Bot in Express mode with the default settings.

Complete the prerequisites: *Prerequisites for installing IQ Bot in Express mode*

1. Double-click the `Automation_A360_IQ_BOT_<build number>.exe` file.
2. In the IQ Bot Setup Wizard, click **Yes**, and then click **Next**.
3. In the **Prerequisites** page, review the prerequisites and click **Next**.

4. In the **License Agreement** page, review the license agreement, accept the terms, and click **Next**. IQ Bot runs a pre-installation check.

The pre-installation screen appears, displaying the applications that do not have the required version and necessary ports along with the services occupying those ports.

5. If the pre-installation check is not successful, uninstall the mentioned software and free the required ports.
 - a) Click **Retry**.
 - b) When the pre-installation check is successful, click **Next**.

The **Installation Type** page appears with **Express** and **Custom** options.

Note: Express installation installs HTTP-based IQ Bot without Active Directory support.

6. Select **Express** and click **Next**.
7. After you click **Next**, the `unable to proceed with installation` message might appear if the installer is unable to communicate with the Control Room or SQL Express. If the error message appears, perform these steps:
 - a. Click **Back** to review or change the installation settings. Alternatively, exit the Setup Wizard and click **Cancel**.
 - b. In the confirmation dialog box, click **Yes** to exit the Setup Wizard. This rolls back all the changes.
 - c. Click **No** to resume.
8. In the **Ready to install the program** page, click **Install**. The express installation begins and the system shows the **Finished** page after a few minutes to indicate a successful installation.

IQ Bot is installed with the following default settings:

Security type: None (HTTP)

Web configuration: <web url:port>

Database configuration: <database url:port> (user: aaadmin ; Authentication: SQL)

Database password: aabots@123

Host Gateway: <gateway:port> (SSL Offloading: No)

Output path: C:\Users\Public\Documents\Automation Anywhere IQBot Platform\Output\

Logging Path: C:\Users\Public\Documents\Automation Anywhere IQBot Platform\Logs\

Logging path Automation 360 IQ Bot A360.21 onward: C:\Users\Public\Documents\Automation 360 IQBot Platform\Logs\

Installation path for Automation 360 IQ Bot: C:\Program Files (x86)\Automation Anywhere IQ Bot A2019\

Installation path for Automation 360 IQ Bot A360.21 onward: C:\Program Files (x86)\Automation 360 IQ Bot\

Verify that IQ Bot is installed, ensure that the IQ Bot services are running using the healthcheck APIs, and register IQ Bot with the Control Room. [Postinstallation checklist](#)

Installing IQ Bot in Custom mode

Use Custom mode to install IQ Bot with configuration details.

1. Run the `Automation_A360_IQ_BOT_<build number>.exe` installation file as an administrator.
2. For first-time installations, a server restart might be required after the installation. Restart the IQ Bot installation process if required.
3. In the Automation Anywhere IQ Bot setup wizard, click **Next**.
 - a) Click **Next** in the **Prerequisites** window.
4. Read the license agreement, accept the terms, and click **Next**.
IQ Bot runs a pre-installation verification.

The pre-installation screen appears, displaying the applications that do not have the required version and necessary ports along with the services occupying those ports.

5. If the pre-installation verification is not successful, uninstall the mentioned software and free the required ports.
 - a) Click **Retry**.
 - b) When the pre-installation verification is successful, click **Next**.

The **Installation Type** page appears with **Express** and **Custom** options.

Note: Express installation installs HTTP-based IQ Bot without Active Directory support.

6. Select the **Custom** option and click **Next**.
7. On the **Database Configuration** window, add these details:
 - a) Hostname or IP: Enter the hostname or IP address.

Note: An underscore is not accepted in a hostname.

- b) Port: Enter the port number.

Note: If a Microsoft Windows SQL Server Express database is installed locally on the target machine, the hostname is auto-populated as *localhost*, and port as 1433.

8. Optional: To connect to your CyberArk vault to store the custom keys for encrypting and decrypting IQ Bot data, select the **Use CyberArk external vault** option and provide the following connection details to your CyberArk account.
 - **Vault URL:** The CyberArk URL endpoint on the CyberArk server
 - **Application ID:** The CyberArk-issued Application ID
 - **Object** and **Safe Name:** Identify the custom key in CyberArk
 - **Client certificate path:** The Control Room Client Certificate certificate used to authenticate to CyberArk. If the certificate is distributed in a passphrase protected file, you must enter the passphrase.
 - **(Optional) Server certificate:** You can load the CyberArk AIM Server certificate to the Control Room trust store here to make sure that the Control Room will trust the CyberArk server.

Obtain the connection details from your CyberArk vendor or IT team.

9. Enter the following database server details on the **Database Configuration** window, and click **Next**.

Option	Description
Option 1	Provide your Microsoft Windows SQL Server user credentials to log in to the database server.
Option 2	If you select the Use Windows Authentication check box, you do not need to provide the Microsoft Windows credentials to log in to the database server because the installer detects them automatically.

The Unable to connect to the SQL server with given configuration error message appears if the following scenarios occur:

- Incorrect server name/IP address, and port number
- Incorrect database server credentials
- Insufficient user privileges to connect to the database

Notes:

- When installing IQ Bot, configure the credentials of a newly hosted database on Microsoft Azure SQL PaaS. This can take up to 300 seconds to verify the credentials and move to the next screen. However, if the on-premise database for IQ Bot is already migrated to Microsoft Azure SQL PaaS before the installation, there is no delay during the database configuration.
- IQ Bot does not support retry logic for Microsoft Azure SQL PaaS. Avoid operating IQ Bot during planned maintenance events in the Microsoft Azure SQL database.
- When IQ Bot and the database instance already exist, and IQ Bot is installed again, and IQ Bot takes the default database instance during installation.
- Windows authentication with the local system works only if the `NT Authority\System` user has system administrator permissions.
- The combination of the Local System account for Service credentials and the Microsoft Windows authentication for SQL connection is not supported if you use the remote SQL server to create databases.

-
10. In the **Services Configuration** window, select the **Local system account** check box and click **Next**.

- Select the **Local system account** check box to run the services on your local system account.
- If you do not select the **Local system account** check box, provide your user credentials to run the IQ Bot services.
 - A valid system administrator user requires Windows authentication with the Services user credentials.
 - When entering user credentials, ensure the credentials are associated with a domain. For example: `example.com/testuser`. The user cannot avail this function without the domain.

11. Enter the following details in the IQ Bot **Portal Configuration** window and click **Next**.

Portal security
Select the security type: HTTPS or HTTP .
If you select HTTPS , verify that you can browse and then select a valid PFX certificate file from the Certificate Path field.
<i>Configuring IQ Bot with HTTP when Control Room is configured with HTTPS</i>

Portal security	
If you select HTTP then go to the next step.	
Enter a valid certificate passphrase from the Certificate Passphrase field.	

Portal configuration	
Hostname or IP	Enter the hostname or IP address of IQ Bot or use the auto-populated default, which is the fully qualified domain name (FQDN) of the machine on which you are installing IQ Bot. Note: This is auto-populated by default with the FQDN of the machine on which you are installing IQ Bot.
Port	Enter the port number or use the auto-populated default, 3000.

12. In the **Load Balancer Configuration** window, do the following:

- a) Select the **Use same as IQ Bot Portal** check box to use the same hostname and port number for the load balancer as specified previously in the IQ Bot **Portal Configuration** window. This check box is selected by default. Keep this check box selected if any of the following conditions exist:
 - You are installing the IQ Bot on a single machine
 - You plan to keep the load balancer configuration the same as the IQ Bot page
- b) If the configuration values for the load balancer are different from the IQ Bot page, clear the **Use same as IQ Bot Portal** check box and enter the following:
 - **Load Balancer Hostname:** Enter the hostname or IP address.
 - **Load Balancer Port:** Enter the port number.
- c) Select the **Load Balancer can handle SSL Offloading** check box if required, and click **Next**.

Note: When configuring the load balancer, if you set the security mode to HTTPS in the IQ Bot **Portal Configuration** window, the SSL offloading is disabled by default. To enable SSL offloading for the load balancer, select **HTTP** in the IQ Bot **Portal Configuration** window.

These are some additional load balancer customization options:

- When you install IQ Bot on AWS, to access the IQ Bot server from an external location, replace the Host Gateway name with the Public DNS .
- During re-installation, the hostname of the load balancer and port are automatically detected by the installer based on the previous installation details stored in the Control Room. Change

them as required because this is useful when you install multiple instances of IQ Bot for scalability (because you are not required to remember the details for each instance).

- When using an HTTPS certificate in the load balancer with an alias name, which is different from the hostname of the machine (FQDN), enter the alias name as the hostname.
- The installer takes the value from the IQ Bot Portal **Configuration** window, (from the previous page), but shows the previously retrieved values in the disabled text boxes from the Control Room.

13. In the **Destination Folder** window, make the required changes to the destination folders and click **Next**.

- **Installation Path:** Select a different installation path if required.

The default installation path is: C:\Program Files(x86)\Automation Anywhere IQ Bot <version number>\

IQ Bot A360.21 onward: C:\Program Files (x86)\Automation 360 IQ Bot\

- **Output Path:** Select the output path where the output is stored. The output path can also be a shared network path. During re-installation, the **Output Path** is automatically detected by the installer (based on the previous installation details stored in IQ Bot's Configuration database). Change the details if required.

The default output path is: C:\Users\Public\Documents\Automation Anywhere IQ Bot Platform\Output\

14. In the **Ready to Install the Program** window, verify and review your installation settings and click **Install** to start the installation.

- On first installation, during the installation process, a Microsoft Windows Security alert can prompt you to allow the installer to install Erlang. If prompted, click **Allow access**.
- Sometimes, the **Windows Security Alert** window is not visible (it can be hidden behind other active windows). Use the Alt plus tab key combination, and verify that the **Windows Security Alert** window is not hidden behind other visible windows.

15. Click **Allow access** to complete the installation, and in the **Installation Successful** window, click **Finish**.

An IQ Bot icon is created on the desktop.

If you encounter an error in launching IQ Bot, you might have to restart the Automation Anywhere Control Room Reverse Proxy and the Automation Anywhere Cognitive Console services.

16. For the Control Room, set the `cluster.properties` file as required based on the release version..

Verify that IQ Bot is installed, ensure that the IQ Bot services are running using the healthcheck APIs, and register IQ Bot with the Control Room. [Postinstallation checklist](#)

Installing IQ Bot in Cluster mode

Install IQ Bot in Cluster mode for improved throughput. IQ Bot supports clustering of up to five IQ Bot installations.

Ensure you have a load balancer for a cluster setup to distribute traffic to all application server nodes.

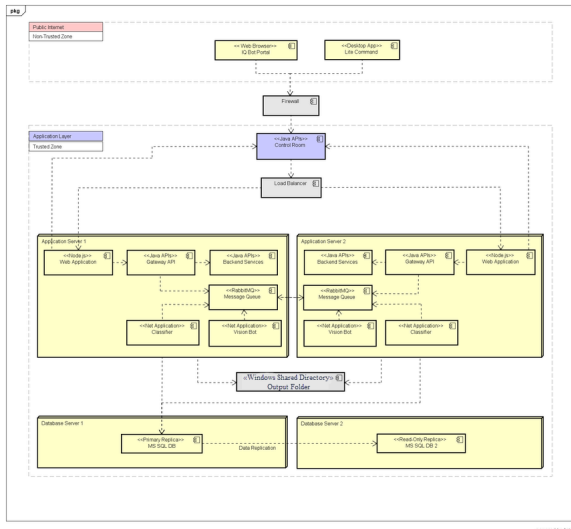

1. Install IQ Bot on each machine in custom mode.
 - During installation, on the **Load Balancer Configuration** screen, type in the load balancer host name and port.
 - Select the **Load Balancer can handle SSL Offloading** option, if the load balancer supports it to enable SSL offloading.
 - Provide the shared output path on the **Destination Folder** screen.
 - During installation, use the same database server details on all the nodes.

Installing IQ Bot in Custom mode

2. Share the **output** folder with the access role **Everyone**.
See [Make a Shared Folder Accessible](#).
3. Use Command Prompt to link each machines containing an IQ Bot installation to the primary cluster.
See [RabbitMQ cluster configuration for IQ Bot](#).
4. Optional: If you have set up [Control Room](#) in High Availability mode, you can set up IQ Bot in High Availability mode as well.
[High Availability and Disaster Recovery overview](#)
5. Configure the firewall to have ports 4369 and 25672 open.

For each machine containing an IQ Bot installation, verify that IQ Bot is installed, ensure the IQ Bot services are running using the healthcheck APIs, and register IQ Bot with Control Room. [Postinstallation checklist](#)

Note: When you register each installation of IQ Bot, in the **URL** field, enter the URL to the load balancer.

Important: In a cluster setup, if a temporary network issue occurs, the cluster breaks. To add the nodes back into the cluster, you must manually execute commands in each of the participating nodes. You also have to monitor the cluster status to know if it is healthy or broken. To avoid such issues, you can configure the cluster to automatically recover (auto-recover) from temporary network issues. See this article for information about how to enable auto-recovery: [RabbitMQ Cluster Configuration with Auto-recovery \(A-People login required\)](#).

RabbitMq cluster configuration for IQ Bot

Use the command prompt to configure three clusters.

Complete steps 1 and 2 in *Installing IQ Bot in Cluster mode*.

1. Open command prompt, navigate to {RabbitMq installation directory}\sbin and execute the following command: `rabbitmqctl.bat cluster_status`.
You will see an output similar to this:

```
Cluster status of node rabbit@IQBotCluster1 ...
  [{ nodes, [{ disc, [rabbit @IQBotCluster1] } ] }, { running_nodes, [rabbit
    @IQBotCluster1] }, { cluster_name, << "rabbit@IQBotCluster1" >> },
    { partitions, [] }, { alarms, [{ rabbit @IQBotCluster1, [] } ] } ] }
```

2. Execute the following command: `rabbitmqctl list_queues -p test`.

3. Configure the primary cluster.

- a) In IQBotCluster1 VM, open command prompt and navigate to {IQ Bot Installation Directory}\Configurations
- b) Execute the following command: `messagequeue_cluster_configuration.bat "IQBotCluster1"`.

4. Link the second cluster to the primary cluster.

- a) In IQBotCluster2 VM, open command prompt and navigate to {IQ Bot Installation Directory}\Configurations.
- b) Execute the following command: `messagequeue_cluster_configuration.bat "IQBotCluster1"`.

5. Verify if the clusters were added successfully.

Open command prompt, navigate to {RabbitMq installation directory}\sbin and execute the following command: `rabbitmqctl.bat cluster_status`.

You should see a similar output to the following, confirming that the two clusters were successfully added:

```
Cluster status of node rabbit @IQBotCluster2...[{ nodes, [{ disc,
  [rabbit @IQBotCluster1, rabbit @IQBotCluster2] } ] }, { running_nodes,
  [rabbit @IQBotCluster1, rabbit @IQBotCluster2] }, { cluster_name, <<
  "rabbit@IQBotCluster1" >> }, { partitions, [] }, { alarms, [{ rabbit
  @IQBotCluster1, [] }, { rabbit @IQBotCluster2, [] } ] } ] }
```

6. Link the third cluster to the primary cluster.

- a) In IQBotCluster3 VM, open command prompt and navigate to {IQ Bot Installation Directory}\Configurations.
- b) Execute the following command: `messagequeue_cluster_configuration.bat "IQBotCluster1"`.

You should see a similar output to the following, confirming that the third cluster was successfully added:

```
Cluster status of node rabbit @IQBotCluster3...[{ nodes,
  [{ disc, [rabbit @IQBotCluster1, rabbit @IQBotCluster2, rabbit
  @IQBotCluster3] } ] }, { running_nodes, [rabbit @IQBotCluster1,
  rabbit @IQBotCluster2, rabbit @IQBotCluster3] }, { cluster_name, <<
  "rabbit@IQBotCluster1" >> }, { partitions, [] }, { alarms, [{ rabbit
  @IQBotCluster1, [] }, { rabbit @IQBotCluster2, [] }, { rabbit
  @IQBotCluster3, [] } ] } ] }
```

When you are done linking the clusters, proceed to step 4 in *Installing IQ Bot in Cluster mode*.

Make a Shared Folder Accessible

Share the output folder with all the devices on the cluster so that when IQ Bot processes documents, the extracted data is saved to the one output folder.

Follow the steps to make your shared folder accessible to IQ Bot.

1. Change log on of the application services with `.\Administrator` account on all cluster nodes.
2. On primary (shared folder) node, change following settings:
 - a) Click **Control Panel > Network and Internet > Network and Sharing Center > Advanced Sharing Setting**
 - b) Expand **Private** and click **Network Discovery**.
 - c) In **Network Discovery**:
 1. Select **Turn on Network Discovery**.
 2. Check the **Turn on automatic setup of network connected devices** checkbox.
 3. Click **File and Printer Sharing** and then select the **Turn on file and printer sharing** checkbox.
 - d) Expand **Guest or Public** and click **Network Discovery**.
 - e) In **Network Discovery**:
 1. Select **Turn on Network Discovery**.
 2. Click **File and Printer Sharing** and then select the **Turn on file and printer sharing** checkbox.
- Open "Local Group Policy Editor". Go to Local Computer Policy >> Windows Settings >> Security Settings >> Local Policies >> Security Options. Find "Network access : Sharing and security model for local accounts". Change it to "Guest only - local users authenticate as Guest".
- f) Click **Local Group Policy Editor**.
- g) Click **Local Computer Policy > Windows Settings > Security Settings > Local Policies > Security Options**.
- h) Find **Network access : Sharing and security model for local accounts** and change it to `Guest only - local users authenticate as Guest`.
- i) Execute this Powershell script:

```
Set-ItemProperty -Path "HKLM:\SYSTEM\CurrentControlSet\Services
\LanmanWorkstation\Parameters" -Name "AllowInsecureGuestAuth" -Type
DWord -Value 1
```

You need to execute this Powershell script on every machine which is a part of the cluster.

After you have made the shared folder accessible to every device in the cluster, proceed to step 3 in [Installing IQ Bot in Cluster mode](#).

Installing IQ Bot in Cluster mode on Amazon EC2

Install IQ Bot in the cluster mode on Amazon Elastic Compute Cloud (Amazon EC2).

If you install IQ Bot in Cluster mode on Amazon EC2, make a note of the following.

- The name for the Amazon EC2 RabbitMQ v3.8.18cluster is in this format: `rabbit@ip-XXX-XXX-XX-XX`.
- Connecting to a node works if both the nodes are in the same local network, but if you connect to a cluster outside the local Amazon EC2 network, configure the host file of node 2.
- Add an entry in the host file where `AA.AA.AAA.AAA` is the public IP of node 1.

```
AA.AA.AAA.AAA
ip-XXX-XX-XX-XX
```

If all the IQ Bot instances in a cluster are not a part of the same domain, ensure that the following services are running using the Administrator user login on each instance.

- Automation Anywhere Cognitive Projects
- Automation Anywhere Cognitive Validator
- Automation Anywhere Cognitive File Manager

To run a service using the Administrator user login, do the following procedure.

1. Click **Task Manager > Services > Open Services**.
2. Right-click the target service, for example, Automation Anywhere Cognitive Projects, and click **Properties**.
3. In the Properties dialog box, select **This account** and enter the credentials for the administrator user.
4. Click **OK** and restart this service. Repeat these steps for the remaining services on this instance and all the other IQ Bot instances in the cluster.

Postinstallation checklist

Verify that IQ Bot is installed, ensure that the IQ Bot services are running using the healthcheck APIs, and register IQ Bot with the Control Room.

Step 1: Verify IQ Bot in the Control Panel

Ensure that the **Automation Anywhere IQ Bot** item exists in **Control Panel > Programs > Programs and Features** of the machine where IQ Bot is installed.

Step 2: Confirm that Automation Anywhere cognitive services are running

Ensure that the following services are installed on the machine where IQ Bot is installed and the status of the services is set to **Running** on the Microsoft Windows services window.

To see the list of services that are currently running, open `services.msc` using **Start > Run**.

- Automation Anywhere Cognitive Alias
- Automation Anywhere Cognitive Application
- Automation Anywhere Cognitive Classifier Service
- Automation Anywhere Cognitive Console

- Automation Anywhere Cognitive File Manager
- Automation Anywhere Cognitive Gateway-2
- Automation Anywhere Cognitive MLScheduler Service

Note: As of Build 12350, this service is disabled, by default.

- Automation Anywhere Cognitive MLWeb Service

Note: As of Build 12350, this service uses a new model to better detect check boxes and tables. To revert to the previous model, open the CognitiveServiceConfiguration.json file, locate the following code snippet, and update the version value to v1:

```
"MLWebService": {  
  "port": "9991",  
  "version": "v2"  
}
```

-
- Automation Anywhere Cognitive Projects
 - Automation Anywhere Cognitive Report
 - Automation Anywhere Cognitive Validator
 - Automation Anywhere Cognitive Visionbot Manager
 - Automation Anywhere Cognitive VisionbotEngine Service

To reinstall the IQ Bot services, **Run** *reinstall-allservices.bat* as an administrator from **IQ Bot Installation Directory > Configuration Folder**. You will see a list of services with serial numbers. Perform either of the following steps to reinstall the services:

1. Enter the serial number of the service that you want to reinstall.

```

ca Administrator: C:\Windows\System32\cmd.exe - reinstall-allservices.bat
(c) 2018 Microsoft Corporation. All rights reserved.
C:\Program Files (x86)\Automation 360 IQ Bot\Configur
-----
S.NO. | SERVICE |
-----
1 | All |
2 | Alias |
3 | Project |
4 | Report |
5 | Validator |
6 | Visionbot |
7 | Filemanager |
8 | Gateway-2 |
9 | Application |
10 | ML Webservice |
11 | ML Scheduler |
12 | Console |
13 | VisionbotEngine |
14 | Classifier |
-----
Select service S.No. to re-install:-1

```

2. Enter the serial number of the service followed by the domain username and password.

```

ca. Select Administrator: C:\Windows\System32\cmd.exe
C:\Program Files (x86)\Automation 360 IQ Bot\
checking input value 1
Validation passed.
Calling MAIN process...
stopped microservices.
stopped workers.
stopped npm.
starting microservices...
started microservices.
starting worker...
started worker.
starting npm...
started npm.

C:\Program Files (x86)\Automation 360 IQ Bot\

```

Step 3: Perform a healthcheck

Use the Healthcheck API to verify about the required service. The request/response details of the Healthcheck API are described in the following table.

Requests

The following table lists the API requests sent for doing a healthcheck of different IQ Bot services:

Service name	URL
Alias	http://<hostname/ IP>: 9997 / healthcheck
Application Service	http://<hostname/ IP>: 9002 / healthcheck
Project Service	http://<hostname/ IP>: 9999 / healthcheck
FileManager Service	http://<hostname/ IP>: 9996 / healthcheck
Visionbot	http://<hostname/ IP>: 9998 / healthcheck
Validator Service	http://<hostname/ IP>: 9995 / healthcheck
Report Service	http://<hostname/ IP>: 9992 / healthcheck
Gateway Service	http://<hostname/ IP>: 8100 / healthcheck
Frontend or Console Service	http://<hostname/ IP>: 3000 / healthcheck
MLWeb Service	http://<hostname/ IP>: 9991 / healthcheck

In the table listing, replace <hostname/IP> with the host name/IP address of IQ Bot to create the Healthcheck API request using a web browser on the machine on which IQ Bot is installed.

For example, if your IQ Bot is accessible at **http://localhost:3000**, the FileManager Healthcheck can be accessed using this URL: `http://localhost:9996/healthcheck`.

Responses

A typical successful response is in the following code example:

```
Subsystem
Application: <Service Name>
Status: OK
```

```

Application uptime: 0d 3h 45m 6s
Version: 1.2.0-RELEASE
Branch: RC-5.2-1
GIT #:
  d88e59c0435c3a836bb47cd586081205564904c5
Build Time: 2018-02-17T09:26:52.523Z
Dependencies:
Database Connectivity: OK
MessageQueue Connectivity: OK
Project: OK
VisionBot: OK

```

**<Service Name> could be alias, application, filemanager, project, reports, gateway, validator, or visionbot.

`Dependencies:` lists the status of all the dependent services, for example, database and message queue of probed service.

If the API responds with `Status: Not_OK`, see [Healthcheck status Not_Ok \(A-People login required\)](#).

Step 4: Verify the database

The system creates the **IQBot** database.

Log in to the database using the `<dbusername>` and `<dbpasswd>` to verify the names of the databases and tables using `<hostname>`, `<dbusername>`, and `<dbpasswd>`.

Step 5 (optional): Create the appropriate certificates and configure the HTTP and HTTPS settings

[Creating a self-signed certificate with Subject Alternative Name](#)

[Configuring IQ Bot with HTTP and HTTPS](#)

Step 6: Register

You must register IQ Bot with Control Room before you can start using IQ Bot.

[Registering IQ Bot with the Control Room](#)

If registration fails:

Do the steps in the following pages to resolve the issue:

1. [Unregistering IQ Bot from the Control Room](#)
2. [Resolving IQ Bot registration failure](#)

Next:

Install an OCR engine (optional): During IQ Bot installation, the system sets the latest version of Tesseract Optical Character Reader as the default OCR engine. To use a different engine, follow the steps in the respective link:

[Use Microsoft Azure Computer Vision OCR engine](#)

[Use ABBYY FineReader Engine OCR engine in IQ Bot](#)

[Use Google Vision API OCR engine](#)

Use Tegaki API OCR engine

Login and set up the Control Room: Create and register IQ Bot specific users in the Control Room. Learn more about IQ Bot roles and access permissions: *[IQ Bot user personas and roles](#)*

Related concepts

[Install and update Automation 360 IQ Bot](#)

This collection of topics guide you through the process of installing or setting up Automation 360 IQ Bot On-Premises and Cloud.

Creating a self-signed certificate with Subject Alternative Name

Create a self-signed certificate with Subject Alternative Name (SAN) when you want to use an SSL certificate for multiple domains.

1. Create a file with the name `domain.cnf` and add the following configuration as per your requirement:

```
[req]
default_bits = 2048
prompt = no
default_md = sha256
x509_extensions = v3_req
distinguished_name = dn

[dn]
C = ES
ST = MyState
L = MyCity
O = MyOrg
emailAddress = email@mydomain.com (Any email address)
CN = sss-laptop136.aaspl-brd.com (CR FQDN Url Name)

[v3_req]
subjectAltName = @alt_names

[alt_names]
DNS.1 = sss-laptop136.aaspl-brd.com (CR FQDN Url Name)
DNS.2 = sss-laptop151.aaspl-brd.com (IQBOT URL FQDN Name)
```

2. Download the Openssl utility.
3. Create the certificate either on Microsoft Windows or on Linux:
 - Run the following command to create the certificate on Microsoft Windows:

```
openssl.exe req -new -x509 -newkey rsa:2048 -sha256 -nodes -keyout "D:\ssc\ssc\key.key" -days 3560 -out "D:\ssc\ssc\cert.crt" -config
```

```
"D:\ssc\ssc\domain.cnf"
```

- Run the following command to create the certificate on Linux:

```
openssl req -new -x509 -newkey rsa:2048 -sha256 -nodes -keyout /tmp/cert/key.key -days 3560
-out /tmp/cert/cert.crt -config /tmp/cert/domain.cnf
```

4. Create the .pfx file from cert and key file:

- Run the following command to create the .pfx file from the cert and key file on Microsoft Windows:

```
openssl.exe pkcs12 -export -out "D:\ssc\ssc\sss-aspl.pfx" -inkey "D:\ssc\ssc\key.key"
-in "D:\ssc\ssc\cert.crt"
```

- Run the following command to create the .pfx file from the cert and key file on Linux:

```
openssl.exe pkcs12 -export -out /tmp/cert/sss-aspl.pfx -inkey /tmp/cert/key.key -in
/tmp/cert/cert.crt"
```

5. Import the .pfx file in Microsoft IIS.

Use the same .pfx file with the installation of IQ Bot.

6. Run the following command to import the certificate in the Java keystore:

```
keytool.exe -import -alias dev -keystore "C:\Program Files
(x86)\Java\jre1.8.0_91\lib\security\cacerts" -file "D:\cert\xyz.com.crt"
```

Based on the type of operating system 32-bit / 64-bit, this C:\Program Files (x86)\Java\jre1.8.0_91\lib\security\cacerts directory can differ.

If the certificate is not imported in the Java keystore, then Control Room shows the following error message: Java security certificate path validator signature check failed.

7. Go to %installation_dir%\Configurations and run stopanduninstallallservices.bat as an administrator.
8. Go to %installation_dir%\Configurations and run installandstartervices.bat as an administrator.
9. Import the cert.crt file to the Trusted Root using the Microsoft Management Console (MMC).

Related concepts

[Install and update Automation 360 IQ Bot](#)

This collection of topics guide you through the process of installing or setting up Automation 360 IQ Bot On-Premises and Cloud.

Registering IQ Bot with the Control Room

IQ Bot is integrated with Control Room for user management. Log in to the Control Room and register IQ Bot.

Do the following before registering IQ Bot with Control Room:

- Launch the Control Room and create an admin user.
- Install the license for IQ Bot. See [Configure new Control Room licenses](#).

IQ Bot can be accessed after registering it with Control Room.

Note: Make a note of the database credentials used for the Control Room installation. This is required for IQ Bot installation if you are using the same database.

1. Log in to Control Room as an administrator.
If you already logged into Control Room in the same browser session, you are automatically logged in to IQ Bot.
2. Click **Administration > Settings > IQ Bot**.
3. Click **Edit** in the IQ Bot section, and a text box appears.
4. Enter the correct IQ Bot URL for example, `http(s)://IQBotURL/`, and click **Save changes**.
If the application registration fails, try registering again.

Note: The URL `https://{CR_URL}/IQBot/` is case-sensitive. For example, ensure that the URL mentions "IQBot" and not "IQbot".

Configuring IQ Bot with HTTP and HTTPS

This section describes single and multiple domain scenarios when installing IQ Bot and Control Room with various server certificates.

There are two main scenarios:

- Installing *IQ Bot* and *Control Room* with wildcard server certificates (single domain).
- Installing *IQ Bot* and *Control Room* with individual server certificates (different domains).

You can encrypt the communication between IQ Bot and Control Room by configuring Two-way (Mutual) SSL. The following steps explain how to configure this and can be achieved by exchanging the SSL certificates between IQ Bot and the Control Room.

Note: IQ Bot does not support self-signed certificate.

Prerequisite for single domain

If Control Room and IQ Bot are on a single domain, and we name the domain as *DomainOne*, the following certificate files are required:

- **PFX file:**

Ensure you have the `DomainOne.pfx` file. The file size is approximately 7/8 KB. One pfx file is required for a single domain.

- **CA Bundled certificate from the Enterprise Control Room (with all intermediate certificate information):**

Use any tool to create the bundle certificate, or you can use *openssl* to create CA/bundled certificate from `DomainOne.pfx` file.

Use the following example command to create CA/Bundled certificate using *openssl* for `DomainOne.pfx`:

```
openssl.exe pkcs12 -in "{DomainOne.pfx file location}" -cacerts -nokeys -chain -out "
```

```
{Outputlocation}\DomainOne_ControlRoom_CA.crt
```

Note: You will need the Control Room bundle certificate for single or multiple domains.

- **Public certificates from IQ Bot and Control Room:**

Use any tool to create the public certificates or use *openssl* to create Public certificate from the *DomainOne.pfx* file.

Use the following example command to create the Public certificate using *openssl* for *DomainOne.pfx*:

```
openssl.exe pkcs12 -in "{DomainOne.pfx file location}" -clcerts -nokeys -out
"{Outputlocation}\DomainOne_ControlRoom_PublicCertificate.crt
```

Note: For a single domain, there will be one public certificate for both, IQ Bot and Control Room.

Prerequisite for multiple domains

If the Control Room and IQ Bot are on separate domains, and the domain names are *DomainOne* (Control Room) and *DomainTwo* (IQ Bot), the following certificate files are required:

- **Pfx file:**

Ensure you have the *DomainOne.pfx* and *DomainTwo.pfx* files. The file size is approximately 7/8 KB.

- **Public certificates from IQ Bot and Control Room:**

Use any tool to create the bundle certificate or use *openssl* to create Public certificate from *DomainTwo.pfx* file.

Use the following example command to create the Public certificate using *openssl* for *DomainTwo.pfx*:

```
openssl.exe pkcs12 -in "{DomainTwo.pfx file location}" -clcerts -nokeys -out
"{Outputlocation}\DomainTwo_IQBot_PublicCertificate.crt
```

Note: : If you set up Control Room or IQ Bot with HTTPS, then configure IQ Bot with HTTPS before registering.

Configuring IQ Bot with HTTPS when Control Room is configured with HTTP

Configure IQ Bot with HTTPS when Control Room is configured with HTTP.

1. Set up IQ Bot using the PFX file with HTTPS configuration during installation.
2. Put the bundled certificate (*DomainTwo_IQBot_CA.crt*) for Control Room in the IQ Bot folder, after IQ Bot installation at *C:\Program Files (x86)\Automation Anywhere IQ Bot\Portal\keys*. Rename the *DomainTwo_IQBot_CA.crt* to *ca.crt*.

Important: If the *ca.crt* file in the *C:\Program Files (x86)\Automation Anywhere IQ Bot <version number>\Portal\keys* folder is already present, then replace it with the new *ca.crt* file.

3. Add the IQ Bot Public certificate (DomainTwo_IQBot_PublicCertificate.crt) to the keystore for the Control Room by running the following command as a system administrator:

```
"{Control Room installation directory}\JRE\bin\java.exe" -jar certmgr.jar
-appDir "{Control Room
installation directory}" -importTrustCert "{FolderLocation}/
DomainTwo_IQBot_PublicCertificate.crt"
```

Configuring IQ Bot with HTTP when Control Room is configured with HTTPS

Configure IQ Bot with HTTP and HTTPS to access IQ Bot using HTTPS and HTTP in the IQ Bot URL.

1. Put the bundled certificate (DomainOne_ControlRoom_CA.crt) for Control Room in the IQ Bot folder after IQ Bot installation at C:\Program Files (x86)\Automation Anywhere IQ Bot \Portal\keys. Rename the ControlRoom_CA.crt to ca.crt.

Important: If the ca.crt file in the C:\Program Files (x86)\Automation Anywhere IQ Bot <version number>\Portal\keys folder is already present, then replace it with the new ca.crt file.

2. Add the Control Room public certificate (DomainOne_ControlRoom_PublicCertificate.crt) to the keystore for IQ Bot by running this command as a system administrator:

```
"{IQ Bot installation directory}\JRE\zulu8.40.0.20-sa-fx-jre8.0.222-
win_x64\bin\keytool.exe" -import -
alias cr -keystore "{IQ Bot installation directory}\JRE\zulu8.40.0.20-sa-
fx-jre8.0.222-
in_x64\lib\security\cacerts" -file "{FolderLocation}/
DomainOne_ControlRoom_PublicCertificate.crt "
```

The system will ask for a keystore password, which is changeit.

Note: Sometimes the system shows a message saying *cr* exists. In this case, change *cr* in the command to *cr1* or something else.

Configuring IQ Bot with HTTPS using single domain

Configure IQ Bot with HTTPS when Control Room is configured with HTTPS using single domain.

1. Set up IQ Bot using the PFX file with HTTPS configuration during installation.
2. Put the bundled certificate (DomainOne_ControlRoom_CA.crt) for Control Room in the IQ Bot folder after IQ Bot installation at C:\Program Files (x86)\Automation Anywhere IQ Bot <version number>\Portal\keys. Rename the DomainOne_ControlRoom_CA.crt to ca.crt.

Important:

If the ca.crt file in the C:\Program Files (x86)\Automation Anywhere IQ Bot <version number>\Portal\keys folder is already present, then replace it with the new ca.crt file.

3. Add the Control Room public certificate (DomainOne_ControlRoom_PublicCertificate.crt) to the keystore for IQ Bot by running this command as a **system administrator**:

```
"{IQ Bot installation directory}\JRE\zulu8.40.0.20-sa-fx-jre8.0.222-win_x64\bin\keytool.exe"
-import -alias cr -keystore "{IQ Bot installation directory}\JRE\zulu8.40.0.20-sa-fx-jre8.0.222-win_x64\lib\security\cacerts" -file "{FolderLocation}/DomainOne_ControlRoom_PublicCertificate.crt "
```

The system will ask for a keystore password, which is `changeit`.

Note: Sometimes the system shows a message saying `cr` exists. In this case, change `cr` in the command to `cr1` or something else.

Related concepts

[Naming guidelines for Control Room URLs](#)

Adhere to Domain Name System (DNS) guidelines when you configure domain and subdomain Control Room URLs for On-Premises and Cloud deployments.

Configuring IQ Bot with HTTPS using multiple domains

Configure IQ Bot with HTTPS when Control Room is configured with HTTP using multiple domains.

1. Set up IQ Bot using the `PEX` file with the HTTPS configuration during installation.
2. Put the bundled certificate (DomainOne_ControlRoom_CA.crt) for the Control Room in the IQ Bot folder after IQ Bot installation at: `C:\Program Files (x86)\Automation Anywhere IQ Bot\Portal\keys`.

Rename the `DomainOne_ControlRoom_CA.crt` to `ca.crt`.

Important: If the `ca.crt` file in the `C:\Program Files (x86)\Automation Anywhere IQ Bot <version number>\Portal\keys` folder is already present, then replace it with the new `ca.crt` file.

3. Add the Control Room public certificate (DomainOne_ControlRoom_PublicCertificate.crt) to the keystore for IQ Bot by running this command as a system administrator:

```
"{IQ Bot installation directory}\JRE\zulu8.40.0.20-sa-fx-jre8.0.222-win_x64\bin\keytool.exe" -import -alias cr -keystore "{IQ Bot installation directory}\JRE\zulu8.40.0.20-sa-fx-jre8.0.222-win_x64\lib\security\cacerts" -file "{FolderLocation}/DomainOne_ControlRoom_PublicCertificate.crt "
```

The system will ask for a keystore password, which is `changeit`.

Note: Sometimes the system shows a message saying `cr` exists. In this case, change `cr` in the command to `cr1` or something else.

4. Add the IQ Bot Public certificate (DomainTwo_IQBot_PublicCertificate.crt) to the keystore for the Control Room by running the following command as a system administrator:

```
"{Control Room installation directory}\JRE\bin\java.exe" -jar certmgr.jar
-appDir "{Control Room
installation directory}" -importTrustCert "{FolderLocation}/
DomainTwo_IQBot_PublicCertificate.crt"
```

Note: For Automation 360 IQ Bot (Build 550), change *JRE* to *jdk* in the command mentioned above.

- Next, restart the machine(s) and follow instructions to register IQ Bot.

See [Registering IQ Bot with the Control Room](#)

Use Microsoft Azure Computer Vision OCR engine

Microsoft Azure Computer Vision OCR engine is a cloud OCR engine and is available to all customers of IQ Bot. IQ Bot automates some installation steps for Microsoft Azure Computer Vision OCR engine.

When you process documents using the Microsoft Azure Computer Vision OCR engine, data is removed immediately. Microsoft Azure Computer Vision OCR engine provides approximately 18% STP and 80% accuracy with data extraction. For more information on privacy for data retention, see [Microsoft Azure Cognitive Services](#).

Note: IQ Bot also supports containerized deployment of Microsoft Azure Computer Vision OCR engine:

[Configure IQ Bot using Docker container and Azure OCR \(A-People login required\)](#)

When creating a learning instance, you can select any language from the **Primary language of documents** drop-down menu. During processing, the OCR engine tries to auto-detect the primary language and can override your selection. For example, you can specify English, but if you upload a Spanish document, the API will try to process the Spanish language.

Tip: You can troubleshoot any issues with extracting data from low quality or handwritten documents [IQ Bot unable to extract data from low quality and Handwritten documents \(A-People login required\)](#)

Follow the steps to configure the `Settings.txt` file and use Microsoft Azure Computer Vision OCR engine.

Restriction: Configuring the `settings.txt` file is not applicable to Automation 360 IQ Bot Cloud

- Ensure your IQ Bot server has internet connectivity and external DNS resolution.

Check to enable communication for the API endpoint on default port = 443: `default endpoint = https://aai-iq-bot-ocr.cognitiveservices.azure.com/.`

Note: To validate connectivity to the API endpoint and the server, open a web browser on the server and type in the complete URL for the API endpoint. If the browser returns a **404 error**, then it implies that a response from the API endpoint was received.

- You can use your own Microsoft Azure Computer Vision OCR engine subscription or spell-check keys. See [Use your own keys for Microsoft Azure Computer Vision OCR engine](#) for more information.
- Optional:** From the `C:\Program Files (x86)\Automation 360 IQ Bot <version number>\Configurations` folder, open the `Settings.txt` file, and change the OCR engine value to `OCREngine=Tesseract4` or `OCREngine=Abbyy` to `OCREngine=MicrosoftAzureAPI`. Then save the file.
- Run the **stopanduninstallallservices.bat** file at `C:\Program Files (x86)\Automation 360 IQ Bot\Configurations`. After stopping the services, run **installandstartallservices.bat** file to install and start the services.

5. Create learning instances in IQ Bot, and use Microsoft Azure Computer Vision OCR engine for the text segmentation, and OCR engine for these learning instances.

For these learning instances, you can continue to use the IQ Bot capabilities for document classification, auto-mapped fields, cognitive extraction, and field value auto-correction.

List of service URLs used for Microsoft Azure Computer Vision OCR engine (optional)

- <https://aai-iq-bot-ocr.cognitiveservices.azure.com/>
- <https://aai-iq-bot-ocr-spellcheck.cognitiveservices.azure.com/>

Note: All URLs point to a global service region in United States.

If IQ Bot is unable to process a document using Microsoft Azure Computer Vision OCR engine, you can review the troubleshooting tips.

[IQ Bot unable to process the document with Microsoft Azure OCR \(A-People login required\)](#)

Use your own keys for Microsoft Azure Computer Vision OCR engine

You can use your own Microsoft Azure Computer Vision OCR engine subscription or Spell Check keys.

Users can use a combination of their own Microsoft Azure Computer Vision OCR engine keys with the Spell Check keys provided by Automation Anywhere. Using the provided Spell Check keys from Automation Anywhere will send your data to the Automation Anywhere account. If you do not want to send any data to the Automation Anywhere Microsoft Azure account, you would have to provide your own Spell Check service keys, or turn it off by setting the value in the `AzureOCREngineSettings.json` file to `EnableAutoCorrectSegmentText: false`.

Follow the steps to use your own keys for Microsoft Azure Computer Vision OCR engine.

1. By default, IQ Bot's encrypted Microsoft Azure Computer Vision OCR engine subscription and Spell Check keys are used. If you prefer to use your own Microsoft Azure Computer Vision OCR engine subscription and, or Spell Check keys, go to `C:\Program Files (x86)\Automation Anywhere IQ Bot <version>\Configurations` and folder **Configurations** > **AzureOCREngineSettings.json** file, and specify your keys.

If both `SubscriptionKey` and `SubscriptionClientKey` are specified, then `SubscriptionClientKey` is used:

- `VisionSubscriptionKey`
- `VisionSubscriptionClientKey`
- `SpellCheckSubscriptionKey`
- `SpellCheckSubscriptionClientKey`

2. Enter your keys correctly to ensure proper API calls as follows:

Before:

```
{
  "VisionServiceUrl": "https://aai-iq-bot-ocr.cognitiveservices.azure.com/",
  "EngineType": 0,
  "VisionSubscriptionKey": "",
  "VisionSubscriptionClientKey": "",
  "SpellCheckSubscriptionKey": "",
  "SpellCheckSubscriptionClientKey": "",
  "EnableDebugging": false,
  "DebuggingFolder": "C:\\Users\\Public\\Documents\\Automation Anywhere IQBot Platform\\Output\\Engine\\Azure",
}
```

```

"HttpTimeoutInSec": 300,
"EnableReprocessLowConfidentSegment": true,
"EnableAutoCorrectSegmentText": true,
"EnableResolveOverlappedSegment": true,
"EnableFieldMerging": true,
"EnableFieldRegions": true
}

```

After:

```

{
  "VisionServiceUrl": "https://aai-iq-bot-ocr.cognitiveservices.azure.com/",
  "EngineType": 0,
  "VisionSubscriptionKey": "",
  "VisionSubscriptionClientKey": "191234d5e7abc1f382123459d4399e33",
  "SpellCheckSubscriptionKey": "",
  "SpellCheckSubscriptionClientKey": "336f8f6a503a4c30ba123456834d4abc",
  "EnableDebugging": false,
  "DebuggingFolder": "C:\\Users\\Public\\Documents\\Automation Anywhere IQBot Platform\\Output\\Engine\\Azure",
  "HttpTimeoutInSec": 300,
  "EnableReprocessLowConfidentSegment": true,
  "EnableAutoCorrectSegmentText": true,
  "EnableResolveOverlappedSegment": true,
  "EnableFieldMerging": true,
  "EnableFieldRegions": true
}

```

3. Run the `stopanduninstallallservices.bat` file as an administrator. The default location of the file is at `C:\Program Files (x86)\Automation Anywhere IQ Bot <version>\Configurations`.
4. Run the `installandstartallservices.bat` file as an administrator. The default location of the file is at `C:\Program Files (x86)\Automation Anywhere IQ Bot <version>\Configurations`.
Log in or refresh your IQ Bot web page.

Use ABBYY FineReader Engine OCR engine in IQ Bot

IQ Bot supports ABBYY FineReader Engine version 12.2, 12.3, and 12.4.

When installing IQ Bot, the system automatically installs an ABBYY FineReader Engine open run-time license on your server.

Note: If you have completed the steps to upgrade IQ Bot, you must update the folder path to the `AbbyyOCREngineSettings.json` configuration file.

Use the following steps to manually install ABBYY FineReader Engine:

1. Download the OCR plug-in with IQ Bot.
2. Unzip the OCR plug-in folder in your downloads folder, and place that unzipped folder, at `<IQ Bot Installation Path>\Automation 360 IQ Bot\`.
3. Ensure the folder says `<IQ Bot Installation Path>\Automation 360 IQ Bot\OCR Plugins\ABBY SDK\12\FineReader Engine. . .`, and the unzipping does not create `OCR Plugins\OCR Plugins` twice. After you unzip the downloaded file, make sure to keep the folder name as `OCR Plugins`, and remove the version number. For example: If the unzipped folder name is `OCR Plugins 12.4`, remove the version number (12.4) from the end of the folder name.

4. To use ABBYY FineReader Engine with IQ Bot you have the following options:

Options	Description
Set ABBYY FineReader Engine as your default OCR engine	Configure the <code>Settings.txt</code> file. Follow steps 5 and 6 to configure the <code>Settings.txt</code> file. <hr/> Restriction: Configuring the <code>settings.txt</code> file is not applicable to Automation 360 IQ Bot Cloud
Select ABBYY FineReader Engine OCR engine from the UI	To select from the UI, see Select an OCR engine .

5. **Restriction:** Configuring the `settings.txt` file is not applicable to Automation 360 IQ Bot Cloud. In Automation 360 IQ Bot Cloud, you can use the `appConfigurations` API to read and update the OCR settings.

For help with using the API, contact the Support team. [Open a support case \(A-People login required\)](#)

To set ABBYY FineReader Engine as your default OCR engine, from the `C:\Program Files (x86)\Automation 360 IQ Bot <version>\Configurations` folder, open the `Settings.txt` file, change `OCREngine=Tesseract4` to `OCREngine=Abbyy`, and save the file.



Trouble: Troubleshoot classification issue in processing Chinese language documents:

[All files are getting unclassified while processing Chinese language documents \(A-People login required\)](#)

6. Next, run the **stopanduninstallallservices.bat** file at `C:\Program Files (x86)\Automation 360 IQ Bot\Configurations`.

Remember: After stopping the services, run **installandstartallservices.bat** file to install and start the services.

7. Create learning instances in IQ Bot, and use ABBYY FineReader Engine for the text segmentation and OCR engine for these learning instances. At the same time, for these learning instances you still partner with the IQ Bot capabilities on document classification, auto-mapped fields, cognitive extraction, and field value autocorrection.

Note: If you install IQ Bot in a different folder besides `C:\Program Files (x86)\Automation 360 IQ Bot <version>`, find and open the **Configurations > ABBYYOCREngineSettings.json** folder, and update the embedded `EnginePath` and `LicensePath` to match the different folder.

For example:

```
{
  "UseOpenRuntimeLicense": true,
  "EnginePath": "C:\\Program Files (x86)\\Automation 360 IQ Bot\\OCR
Plugins\\ABBY SDK\\12\\FineReader Engine\\Bin",
  "DeveloperSN": "",
  "ProjectId": "",
  "LicensePath": "C:\\Program Files (x86)\\Automation 360 IQ Bot\\
Configurations\\Runtime.ABBYY.LocalLicense",
  "LicensePassword": ""
}
```

}

Note: Sometimes, documents can fail to classify with ABBYY FineReader Engine as your default OCR engine. See recommended workaround for this issue.

Document uploads are moving to unclassified state while using Abbyy OCR engine (A-People login required)

8. The following table lists the various ABBYY FineReader Engine versions that are supported and compatible with IQ Bot:

Table 2: Version compatibility matrix of ABBYY FineReader Engine and IQ Bot

ABBYY FineReader Engine version	IQ Bot version
12.2	(A2019.12) and below
12.2 and 12.3	(A2019.13) to (A2019.16)
12.2, 12.3, and 12.4	(A2019.17) and later

Use your own ABBYY FineReader Engine license

Follow the steps to use your own ABBYY FineReader Engine license.

1. Navigate to the **IQ Bot installation directory > configuration folder**, and open `AbbyyOCREngineSettings.json` to update the following properties:
 - Change the `EnginePath` and paste the installed ABBYY FineReader Engine engine path. For example, `C:\Program Files\ABBYY SDK\12\FineReader Engine\Bin`. Ensure the path includes separators as two backward slashes. Update the `DeveloperSN` property with the license key.
 - Update the `ProjectId` property with your license project ID.
 - Update the `UseOpenRuntimeLicense` to false.
2. From the `C:\Program Files (x86)\Automation Anywhere IQ Bot <version>\Configurations` folder, open the `Settings.txt` file to ensure or modify `OCREngine=ABBYY FineReader Engine`, and save the file.
3. Run the `stopanduninstallallservices` file at `C:\Program Files (x86)\Automation Anywhere IQ Bot <version>\Configurations`.
4. Run the `installandstartallservices` file and log in to or refresh your IQ Botweb page.

Installation steps if ABBYY FineReader Engine remains installed from a previous IQ Bot version

If ABBYY FineReader Engine remains installed from a previous IQ Bot version, use the IQ Bot ABBYY FineReader Engine open run-time license.

1. Navigate to the **IQ Bot installation directory > configuration folder**, and open the `AbbyyOCREngineSettings.json` file to update the following properties:

Change the `EnginePath` and paste the installed ABBYY FineReader Engine engine path. For example, `C:\Program Files\ABBYY SDK\12\FineReader Engine\Bin`. Ensure the path includes separators as two backward slashes.
2. Go to the ABBYY FineReader Engine installation directory, open the `Bin` folder, and remove the `Protection.Developer.dll` file.

3. From the `C:\Program Files (x86)\Automation Anywhere IQ Bot <version>\Configurations` folder, open the `Settings.txt` file, modify or ensure `OCREngine=ABBYY FineReader Engine`, and save the file.
4. Run the `stopanduninstallallservices` file at `C:\Program Files (x86)\Automation Anywhere IQ Bot <version>\Configurations`.
5. Run the `installandstartallservices` file and log in, or refresh your IQ Bot web page.

Use Google Vision API OCR engine

Use the Google Vision API OCR engine with IQ Bot to improve the accuracy of the optical character recognition (OCR) results for training documents in Asian languages, particularly in Japanese and Korean. Google Vision API OCR engine in IQ Bot supports all languages supported by the engine.

Verify that the default port 443 is available to enable communication for the API endpoint using TCP.

Note: See a list of allowed service URLs for using Google Vision API in the example section below.

Google Vision API files are installed on your machine automatically during the IQ Bot installation and is provided as a built-in plug-in, with a single-step installation, and is available for all users:

- It is a cloud OCR engine.
- Google Vision API does not support documents with more than one language. Before using this feature, ensure you want to primarily extract Japanese or Korean text only.
- Languages that are written right to left, rather than left to right, are not supported within IQ Bot for document extraction. For example, Arabic, Aramaic, Azeri, Divehi, Fula, Hebrew, Kurdish, N'ko, Persian, Rohingya, Syriac, and Urdu.

Prior to this release, the engine primarily supported data extraction for Japanese and Korean text only.

Languages supported in Automation 360 IQ Bot

- Data is not stored in Google Cloud and is removed immediately.

For additional information on privacy for data retention see: [Google Data Usage](#)

IQ Bot provides you with the license to use the Google Vision API OCR engine. You can also use your own license key.

Use your own license keys for Google Vision API OCR engine

Note: Updates to Google Vision API such as OCR engine improvements, enhancements, and bug fixes might affect content extraction when you use this OCR engine in IQ Bot. Therefore, we recommend that you periodically refer to the Google Vision API release notes for the latest updates.

See [Potential impact of Google Vision API OCR upgrade](#).

You have the following options for using this OCR engine:

Options	Description
Option 1: Set Google Vision API as your default engine	Configure the <code>Settings.txt</code> file. Restriction: Configuring the <code>settings.txt</code> file is not applicable to Automation 360 IQ Bot Cloud

Options	Description
Option 2: Select Google Vision API engine directly from the UI when creating a learning instance	<i>Select an OCR engine</i>

To set Google Vision API as your default OCR engine, configure the `Settings.txt` file as follows:

Restriction: Configuring the `settings.txt` file is not applicable to Automation 360 IQ Bot Cloud

1. Run the IQ Bot installer.
2. Optional: Set Google Vision API as the default OCR for new learning instances.
Navigate to `..\Automation 360 IQ Bot\Configurations\Settings.txt`, and modify the following value: `OCREngine=GoogleVisionAPI`.
This will set Google Vision API OCR engine as the default engine for your environment.
3. The `GoogleOCREngineSettings.json` file is generated within the `..\Automation 360 IQ Bot\Configurations` folder with default values as follows:
Use the following with Google Vision API:

```
{
  "ADCJson": null,
  "EngineType": 2,
  "EnableFieldMerging": true,
  "EnableFieldRegions": true,
  "DebuggingFolder": "C:\\Users\\Public\\Documents\\Automation 360 IQBot Platform\\Logs\\Engine\\Google"
}
```

4. For Japanese and Korean language documents, update the field: `"EnableCustomParse": true`.

Note: A service restart is not required after making the change.

List of service URLs used for Google Vision API (optional)

Use the following allowed URLs if required:

Note: All URLs point to a global service region in the US.

- API URL: <https://vision.googleapis.com/>
- Auth URL: <https://accounts.google.com/o/oauth2/auth>
- Token URL: <https://oauth2.googleapis.com/token>
- Auth Provider URL: <https://www.googleapis.com/oauth2/v1/certs>
- Client Auth URL: <https://www.googleapis.com/robot/v1/metadata/x509>

1. Create a new learning instance with the Asian language document you want to train.
2. Train the document and set your learning instance to production.
3. Upload Asian language files and run the bot.
4. Download and view the accuracy of the extraction results.

Use your own license keys for Google Vision API OCR engine

You can use your own keys for Google Vision API OCR engine subscription.

Users can use their own authentication of Google Vision API. They would need to create Google Cloud Application Default Credentials (ADC) and copy the content from ADC JSON file to the **"ADCJson"** field in `GoogleVisionOCREngineSettings.json`.

Note: Use the link to create Google Cloud Application Default Credentials for Google Vision API: <https://cloud.google.com/docs/authentication/production>.

Follow the steps to use your own keys for Google Vision API OCR engine.

1. By default, IQ Bot's encrypted Google Vision API subscription keys are used. If you prefer to use your own Google Vision API subscription keys, go to `C:\Program Files (x86)\Automation Anywhere IQ Bot <version>\Configurations`, and folder **Configurations** > **GoogleVisionOCREngineSettings.json** file, and specify your keys.
2. IQ Bot provides you with an inbuilt license for Google Vision API, but you have the option to overwrite this license if you would like to use your own. Copy the content from the ADC JSON file correctly to ensure proper API calls as follows:

```
{
  "ADCJson": {
    "type": "service_account",
    "project_id": "dark-caldron",
    "private_key_id": "9e83979f61cff072d0e0e4f91bf837e6e29bbb",
    "private_key": "-----BEGIN PRIVATE KEY-----\nMIIEVgIBADANBg.....-----\n\n",
    "client_email": "vision-test@dark-caldron.iam.gserviceaccount.com",
    "client_id": "105342202023265468399",
    "auth_uri": "https://accounts.google.com/o/oauth2/auth",
    "token_uri": "https://oauth2.googleapis.com/token",
    "auth_provider_x509_cert_url": "https://www.googleapis.com/oauth2/v1/certs",
    "client_x509_cert_url": "https://www.googleapis.com/robot/v1/metadata/x509/vision-test%40dark-caldron-254807.iam.gserviceaccount.com"
  },
  "EngineType": 2,
  "EnableDebugging": false,
  "DebuggingFolder": "C:\\Users\\Public\\Documents\\Automation Anywhere IQBot Platform\\Logs\\Engine\\Google",
  "HttpTimeoutInSec": 300,
  "EnableCustomParse": false,
  "DistanceThreshold": 15
}
```

Potential impact of Google Vision API OCR upgrade

Google Vision API OCR is Cloud based, and typically, it is upgraded to a newer version according to Google's release cycle. As a result of this upgrade, an impact might be observed on document extraction processing and extraction results in IQ Bot.

Impact on document classification in IQ Bot after the update of Google Vision API OCR

The classification of documents is based on the OCR result, particularly the order in which the fields are detected. Thus, if the content of the OCR results varies, then the classification results of the similar document processed previously might show visible differences during document extraction.

The auto-upgrade affects the classifier service in two ways:

- **Different groups are assigned to documents:** The documents when processed will be assigned to different groups versus what they were originally routed to so far. Consequently, some data extractions might fail, which were previously successful.
- **New groups are created:** The documents previously being processed with a group might now result in new group being created.

Impact on data extraction in IQ Bot after update of Google Vision API OCR

A change in OCR output might result in the following differences during data extraction from a similar document type:

- **Improvement in character recognition and its associated impact:** As a result of improved keyword character recognition, previously unrecognized values from a document will now provide better extraction results.

Note: If any processing logic is written to fix the lack of detected characters, it might cause issues when the document is processed.

- **Degradation in character recognition and its impact:** Validation might fail due to degradation in OCR output, and the document will be routed to the Validator. In a scenario where there is no validation setup, the extracted data output might see a degradation.

Options to mitigate

If you encounter any of the previously mentioned issues, you have the following options to explore:

- Retrain existing learning instance to fix issues with document classification.
- Write processing logic using Python to mitigate extraction outcomes.
- Evaluate creating learning instance with different OCR provider supported by IQ Bot.
- Raise a support ticket with Automation Anywhere.

Use Tegaki API OCR engine

Use the Tegaki API OCR engine with IQ Bot to improve the accuracy of the optical character recognition (OCR) results that is used for training documents in Japanese and Korean languages. You can configure it for use with Automation 360 IQ Bot On-Premises.

Review the following prerequisites for setting up Tegaki API OCR engine:

- Only Automation 360 IQ Bot On-Premises supports Tegaki API OCR.
- You must have a dedicated server that meets the requirements set by Cogent Labs. For more information, contact your Customer Success Manager.
- IQ Bot provides Tegaki API as a built-in plug-in. Set Tegaki API as your default OCR engine in the `settings.txt` file available in the following folder:

`C:\Program Files (x86)\Automation 360 IQ Bot <version>\Configurations`

- Set the communication for the API endpoint on default `port = 443`, using `TCP` protocol.

Restriction: Not available in Automation 360 IQ Bot Cloud.

Tegaki API OCR supports documents in the following languages:

- Japanese
- Korean
- Japanese- English
- Korean- English

1. Run the IQ Bot installer.
2. Configure the Tegaki API OCR engine for the On-Premises version on your machine based on instructions received from your Automation Anywhere representative.
3. Input your license key in the Tegaki OCR settings.json file.

As IQ Bot does not provide you with the license to use the Tegaki API OCR engine, you must use your own license key. Follow the steps to install your own license key:

- a. Navigate to the following location:

`C:\Program Files (x86)\Automation 360 IQ Bot\Configurations`

- b. Set up the Tegaki API endpoint where you have installed the On-Premises version. Set `APIKey = <your key here>` and configure the `TegakiOCREngineSettings.json` file.

```
{
  "APIKey": "<ensure your key meets UUID format (https://www.uuidgenerator.net)>",
  "RestEndpointURL": "<your Tegaki Server URL here>",
  "RestEndpointPort": <80>,
  "EngineType": 3,
  "EnableFieldMerging": false,
  "EnableFieldRegions": false,
  "DebuggingFolder": "C:\\Users\\Public\\Documents\\Automation Anywhere IQBot Platform\\Logs\\Engine\\Tegaki"
}
```

See [How to change OCR Settings in IQ Bot \(A-People login required\)](#).

4. Navigate to `..\Automation 360 IQ Bot\Configurations\Settings.txt`, and modify the following value: `OCREngine=TegakiAPI`.

The `TegakiOCREngineSettings.json` file is available after IQ Bot installation.

1. Create a new learning instance with the Asian language document you want to train.
2. Train the document and set your learning instance to production.
3. Upload Asian language files and run the bot.
4. Download and view the accuracy of the extraction results.

Related concepts[Install and update Automation 360 IQ Bot](#)

This collection of topics guide you through the process of installing or setting up Automation 360 IQ Bot On-Premises and Cloud.

Resolving IQ Bot registration failure

Use the instructions in this topic if IQ Bot registration fails due to HTTPs URL issues.

1. Use Windows **Services** to restart the Control Room service.
2. Update the Control Room HTTPs URL by logging in to **Control Room > Administration > Settings > General**.
3. Use Windows **Services** to restart the following services:
 - Automation Anywhere Control Room Cognitive Console
 - Automation Anywhere Control Room Reverse Proxy
4. Re-register IQ Bot with the HTTPs URL in the Control Room.
IQ Bot is registered successfully.

Unregistering IQ Bot from the Control Room

You have to unregister IQ Bot from the Control Room if the IQ Bot URL changes because of installation or uninstallation of IQ Bot, or when a load balancer is added.

After unregistering IQ Bot from the Automation Anywhere Control Room, restart the Automation Anywhere Cognitive Console service.

1. Using the **sysadmin** role, run two separate SQL queries in different databases.
2. Run the first set of SQL statements in the Control Room database to delete the following data:

Run the following SQL statements for versions A2019.10 to A2019.13:

```
DELETE FROM [AAE-Database].[dbo].[ACTIVEMQ_ACKS]
```

```
DELETE FROM [AAE-Database].[dbo].[ACTIVEMQ_MSGS]
```

```
DELETE FROM [AAE-Database].[dbo].[SERVICE_USER]
```

```
DELETE FROM [AAE-Database].[dbo].[USERS] where user_type='APP'
```

Run the following SQL statements for version A2019.14 and later:

- a. Run the following query:

```
USE [AAE-Database]
SELECT T.uuid As TenantID,T.name AS
  TenantName,T.created_by,T.enabled,U.id AS
  IQBotAppUserId,U.user_type,S.url AS
  IQBotURL FROM [dbo].[TENANTS] T
LEFT JOIN [dbo].[USERS] U ON T.uuid = U.tenant_uuid
LEFT JOIN [dbo].[SERVICE_USER] S ON U.id = S.id
```

```
WHERE (U.user_type='APP' AND S.type='IQBOT')
```

- b. The above query will provide you an 'IQBotAppUserId' number. Replace id = 'IQBotAppUserId'.
- c. Execute the following delete queries:

```
DELETE FROM [AAE-Database].[dbo].[SERVICE_USER] WHERE [type]='IQBOT'
```

- d.

```
DELETE FROM [AAE-Database].[dbo].[USERS] WHERE id = 'IQBotAppUserId'
```

3. Run the second set of SQL statements in the IQ Bot configuration database to delete the following data:

- ```
DELETE FROM [IQBot].[dbo].[Configurations] where [key]='controlRoomVersion'
```
- ```
DELETE FROM [IQBot].[dbo].[Configurations] where [key]='appRegistered'
```
- ```
DELETE FROM [IQBot].[dbo].[Configurations] where [key]='controlRoomUrl'
```
- ```
DELETE FROM [IQBot].[dbo].[Configurations] where [key]='appId'
```

You have unregistered successfully.

Set up log file automatic rollover

This topic addresses setting up automatic rollover of log files based on the file size.

After the log files are created, the system continues logging messages, which increases the log file size to a point where they are too large to open. This prevents the user from opening the log files for reviewing the information and error messages.

Note:

- This happens sooner if the logging level is increased to **DEBUG** or **TRACE** modes.
- To ensure smooth operation of the system, manual clear the logs periodically.

For all Java services, user can identify the log files under <IQ Bot installation directory>/Services . Open any logging configuration file, and add the following change under <SizeBasedTriggeringPolicy size="100MB" /> in the first occurrence of **Policies**:

```
<Policies>
<TimeBasedTriggeringPolicy interval="720" />
<SizeBasedTriggeringPolicy size="50MB" />
</Policies>
```

In the following example setting, after the log file reaches 50 MB, the system creates a new file automatically and starts logging in it. Though the user ends up with more files, but each file would be 50 MB only. This is standard practice to manage log files.

This example shows entries a user can add to the setting for Automation 360 IQ Bot On-Premises to automatically roll over the logs after the files reach a certain size.

```
<RollingFile name="Alias" fileName="\${env:PUBLIC}/Documents/Automation
Anywhere IQBot Platform/Logs/Alias.log"
filePattern="\${env:PUBLIC}/Documents/Automation
Anywhere IQBot Platform/Logs/Archive/\${date:yyyy-MMM}/Alias-%d{yyyy-MMM-
dd}-%i.log.zip"
immediateFlush="true"
append="true">
<PatternLayout pattern="CPL1 Alias %X{cid} %d{ISO8601}{UTC}Z
%-5level %C %M %msg %n"/>
<Policies>
<TimeBasedTriggeringPolicy />
<SizeBasedTriggeringPolicy size="50MB" />
</Policies>
<DefaultRolloverStrategy max="10"/>
</RollingFile>
```

Health Check API response if RabbitMQ v3.8.18 fails to start

Check the status of each IQ Bot service using the Health Check API if RabbitMQ v3.8.18 fails to start.

The Health Check response for RabbitMQ startup failure is different in case of FileManager, Project, Validator, VisionBot as described in the following table.

Service name	Health Check response	Reason for failure
FileManager http:// <hostname>:<9996>/ healthcheck	<p>Failure 1: localhost refused to connect</p> <p>Failure 2: localhost refused to connect</p>	<p>Reason for failure 1: The RabbitMQ v3.8.18 node/service went down when the Filemanager service was running.</p> <p>Reason for failure 2: The RabbitMQ node/service was already down when the Filemanager service started.</p>
Project http:// <hostname>:<9999>/ healthcheck	<p>Failure: localhost refused to connect</p>	<p>Reason for failure: The RabbitMQ v3.8.18 node/service is down.</p>
Validator http:// <hostname>:<9995>/ healthcheck	<p>Failure: localhost refused to connect</p>	<p>Reason for failure: The RabbitMQ v3.8.18 node/service is down.</p>
VisionBotManager http:// <hostname>:<9998>/ healthcheck	<p>Failure: localhost refused to connect</p>	<p>Reason for failure: The RabbitMQ v3.8.18 node/service is down.</p>

Service name	Health Check response	Reason for failure
Gateway-2 service http://<hostname>:8100/ healthcheck	Application: gateway-2 Failure 1: localhost refused to connect Failure 2: localhost refused to connect	Reason for failure 1: Port is blocked and the Gateway-2 service is running. Reason for failure 2: The Gateway-2 service is not running.

Reinstalling HTTPS SSL certificate for secure communication when it expires

Reinstall HTTPS SSL certificate when your HTTPS SSL certificate expires.

The HTTPS SSL certificate is required for secure and encrypted communication between your browser and IQ Bot, to protect highly confidential online transactions, for example, online financial and shopping transactions. The padlock icon on your browser indicates that you have an active secure connection.

To enable a secure connection, get the HTTPS SSL certificate as follows:

1. Go to %installation_dir%\Configurations and as an administrator, run stopanduninstallallservices.bat.

Note: In a cluster installation, stop the services on each of the nodes for IQ Bot and Control Room cluster.

2. Go to %installation_dir%\Portal\keys and make a backup of the cert.crt, key.key, and ca.crt files.
3. Convert the .pfx file of the IQ Bot certificate to .crt and .key formats by running the following commands:
 - Extract an encrypted key from .pfx file.

```
openssl.exe pkcs12 -in "path_to_cert\example.pfx" -nocerts -out "path_to_cert\example encp.key"
```

Note: If the .pfx file is password protected, you need to enter the pass phrase when prompted.

- Convert an encrypted key to a readable format.

```
openssl.exe rsa -in "path_to_cert\example encp.key" -out "path_to_cert\key.key"
This command converts encrypted key to a readable format.
```

- Convert the .pfx file to .crt format.

```
openssl.exe pkcs12 -in "path_to_cert\example.pfx" -clcerts -nokeys -out "path_to_cert\cert.crt"
```

- Fetch the ca.crt file from the Control Room certificate (.pfx) file only if the Control Room certificate also expires.

```
openssl pkcs12 -in <filename.pfx> -cacerts -nokeys -chain -out <ca.crt>
```

4. Copy or replace the `cert.crt`, and `key.key` (generated in the previous step), and the `ca.cert` (generated using the Control Room certificate `.pfx` file) to the `%installation_dir%\Portal\keys` folder.
5. Import the IQ Bot public certificate into the Java Key store for IQ Bot by running this command as a system administrator:

```
"JRE Location\bin\keytool.exe" -import -alias iqbot-keystore "cacerts
location of iq bot" -file " iq bot public certificate file"
```

Example: `C:\Program Files (x86)\Automation Anywhere IQ Bot <version number>\JRE\1.8.0_161\bin\keytool.exe" -import -alias cr -keystore "C:\Program Files (x86)\Automation Anywhere IQ Bot <version number>\JRE\1.8.0_161\lib\security\cacerts" -file "C:\Certificate\cert.crt`

6. To import the IQ Bot public certificate into Control Room, go to the Control Room installation path, such as: `C:\Program Files\Automation Anywhere\Enterprise`, and run the following command as a system administrator: `jrk\bin\java -jar certmgr.jar -appDir "C:\Program Files\Automation Anywhere\Enterprise" -importTrustCert "C:\Certificate\cert.crt"`.
7. After importing the certificates, restart the Control Room and IQ Bot servers.
This refreshes the system caches.
8. On IQ Bot Server, go to `%installation_dir%\Configurations` and as an administrator, run `installandstartallservices.bat`.

If the Control Room certificate expires

1. Follow the steps: [Import HTTPS and CA certificates](#)
2. Convert `.pfx` to `.crt` format. `openssl.exe pkcs12 -in "path_to_cert\example.pfx" -clcerts -nokeys -out "path_to_cert\cert.crt"`.
3. Fetch the `ca.crt` file from the Control Room certificate (`.pfx`) file. `openssl pkcs12 -in <filename.pfx> -cacerts -nokeys -chain -out <ca.crt>`
4. Copy or replace the `ca.crt` to the keys folder in IQ Bot.
5. Import the Control Room public certificate into Java Key store for IQ Bot by running this command as a system administrator: `"JRE Location\bin\keytool.exe" -import -alias cr -keystore "cacerts location of iq bot" -file "control room public certificate file"`.

Example: `C:\Program Files (x86)\Automation Anywhere IQ Bot <version number>\JRE\1.8.0_161\bin\keytool.exe" -import -alias cr -keystore "C:\Program Files (x86)\Automation Anywhere IQ Bot <version number>\JRE\1.8.0_161\lib\security\cacerts" -file "C:\Certificate\cert.crt`

Note: To change the Control Room certificate, follow steps here: [Import HTTPS and CA certificates](#)

Updating Automation 360 IQ Bot

Update Automation 360 IQ Bot On-Premises to the most recent version for all the latest features and enhancements.

Ensure you back up your existing IQ Bot learning instances. Depending on the Automation 360 IQ Bot version you are currently using, the following update options are available:

- **Update from earlier Automation 360 IQ Bot builds (1089, 1598, and 2079) to the latest Automation 360 IQ Bot On-Prem version**

The earlier versions of Automation 360 IQ Bot had five databases. A single unified database is available starting with Automation 360 IQ Bot On-Premises Build 2545. Use the migration script to migrate these five databases to a unified database.

Run IQ Bot On-Premises database migration script

- **Update to the latest version of Automation 360 IQ Bot On-Prem.**

Ensure you update your existing Automation 360 IQ Bot On-Premises to the latest version which provides the product improvements and bug fixes.

Update Automation 360 IQ Bot On-Premises to the latest version

- **Troubleshoot CyberArk vault integration for upgrade**

If you encounter a vault key validation error while upgrading Automation 360 IQ Bot to Build 15112, troubleshoot the issue by ensuring the JDBC Driver is in the C:\Windows\System32 folder.

Troubleshoot CyberArk vault integration for upgrade (A-People login required)

Run IQ Bot On-Premises database migration script

IQ Bot On-Premises Builds 1089, 1598, and 2079 included five databases. Starting with IQ Bot On-Premises Build 2545, one unified database is supported. You have to run a migration script to migrate the databases of Builds 1089, 1598, 2079 to the latest build.

Before you run the migration script, you must be on the latest IQ Bot On-Premises build, and verify that the SQL command utility `SQLCMD.exe` is installed on your system.

Also, verify and ensure Microsoft ODBC Driver 17 for SQL Server is installed on the IQ Bot server. This can be obtained from: <https://www.microsoft.com/en-us/download/details.aspx?id=56567>

1. Uninstall the current build of IQ Bot On-Premises.
2. Install the latest IQ Bot On-Premises build.

During installation, a new IQ Bot database is created.

Note: Remember your database username and password in order to the update migration script value.

3. Navigate to your `Binn` folder.

This might be located in `C:\Program Files\Microsoft SQL Server\Client SDK\ODBC\170\Tools\Binn`.

4. Verify that `SQLCMD.exe` is installed.

If `SQLCMD.exe` is not installed, follow these steps:

- a. Download and extract the `Data Migration.zip` from the *Installation Setup* folder onto the IQ Bot server.
- b. Navigate to **DataMigration > UTILITY-MsSqlCmdLnUtils**.
- c. Run `MsSqlCmdLnUtils.msi` to install `SQLCMD.exe`.

After `SQLCMD.exe` is installed, run the migration script.

1. Access the `AA.IQBot_Database_Migration.bat` file within the `DataMigration` folder.
2. Edit the `AA.IQBot_Database_Migration.bat` file.

3. Update the values as follows:

- a) Set the `SQLCMD` value to the path of your `Binn`.

```
SQLCMD="C:\Program Files\Microsoft SQL Server\Client SDK\ODBC\170\Tools
\Binn\SQLCMD.exe"
```

- b) Set `LOGIN` value to your database username.

```
LOGIN="database username"
```

Note: The **bulkadmin**, **dbcreator**, and **public** roles are required to run the migration script.

- c) Set the `PASSWORD` value to your database password.

```
PASSWORD="database password"
```

- d) Set the `SERVER` value to the path of your database server hostname.

```
SERVER="path of database server hostname"
```

4. Run the migration script `AA_IQBot_Database_Migration.bat` file with administrator privilege. After the migration is complete, an output is created. Verify `C:\Datamigrationlog.txt` for log history and errors.

Note: If an output is not displayed, contact support.

Update Automation 360 IQ Bot On-Premises to the latest version

If you are using any of the earlier versions of Automation 360 IQ Bot On-Premises, you can update to the latest version, which offers enhancements and bug fixes.

It is recommended that you review your existing Automation 360 IQ Bot On-Premises version and back up your database, output path, and installation configuration files.

Note: Uninstall the existing version of Automation 360 IQ Bot On-Premises from your device before updating to the latest version.

- 1.** Go to Automation Anywhere support site to download the latest version of the Automation 360 IQ Bot setup file.
[A-People Downloads page \(Login required\)](#)
- 2.** Click the link to the latest Automation 360 IQ Bot setup file.
- 3.** Click `Installation Setup`.
- 4.** Download the `Automation_Anywhere_IQ_Bot_A2019_Build_<build number>.exe` file and install it.

[Install and update Automation 360 IQ Bot](#)

The latest version of Automation 360 IQ Bot On-Premises is installed on your device.

Upgrading and downgrading IQ Bot

Uninstall and install a later version to upgrade IQ Bot. Uninstall and install an earlier version of IQ Bot to downgrade.

To upgrade or downgrade IQ Bot, perform the following procedure.

- **Upgrading IQ Bot**

- a) Create a new folder in any location and take a backup of the *Settings.txt* and both or either of the .json files *ImageProcessingConfig.json* or *AbbyyImagePreProcessingSettings.json* for your reference from the *<Installation Path/Configuration>* folder to this new folder.
- b) Take a backup of the existing IQ Bot databases before starting the upgrade.
- c) Follow the uninstall process:
[Uninstalling IQ Bot](#)
- d) Copy a later version of IQ Bot installable file from *<path of the installable file>* to your local system.
- e) Follow the installation process.

Note:

- Refer to the settings from the *Settings.txt* and both or either of the .json files *ImageProcessingConfig.json* or *AbbyyImagePreProcessingSettings.json* to enter the configuration values when you are installing an earlier version of the product.
- Back up your database to restore it in case any issue occurs in future or in case you downgrade to an earlier version of IQ Bot.
- If you are using the ABBYY FineReader Engine OCR, you must update the folder path to the *AbbyyOCREngineSettings.json* configuration file after completing the upgrade installation steps.

[Migrate learning instances](#)

- **Downgrading IQ Bot**

- a) Create a new folder in any location and take a backup of the *Settings.txt* and both or either of the .json files *ImageProcessingConfig.json* or *AbbyyImagePreProcessingSettings.json* for your reference from the *<Installation Path/Configuration>* folder to this new folder.
- b) Uninstall the later version of IQ Bot.
- c) Take a backup of the current databases.
- d) Remove the backup of the current databases.
- e) Restore the database backup of the earlier IQ Bot version.
- f) Install the earlier version of IQ Bot.

Note:

- Refer to the settings from the *Settings.txt* and both or either of the .json files *ImageProcessingConfig.json* or *AbbyyImagePreProcessingSettings.json* to enter the configuration values when you are installing an earlier version of the product.
 - Back up your database to restore it in case any issue occurs in future or in case you upgrade to a different version of IQ Bot.
-

Uninstalling IQ Bot

If you have installed Automation 360 IQ Bot On-Premises, use these steps to uninstall IQ Bot and its dependencies.

To manually uninstall, go to **Windows > Control Panel > Programs > Uninstall a program**, and choose IQ Bot.

For all other versions, use the following steps.

1. Double-click the `Automation_360_IQ_BOT_<version-number>.exe` installer file. The Automation Anywhere IQ Bot - Wizard appears.
2. Enter the administrative permissions in the **User Access Control** dialog box if a dialog box appears.

Note: Ensure you close all the existing browser instances running IQ Bot before you begin uninstallation.

3. Click **Next**. The **Ready to Remove** page appears.
4. Click **Remove**.

The uninstallation process begins.

Note: During the uninstallation process, if setup information appears, click **OK** to continue. Clicking **Cancel** to close the process.

5. When complete, the **Finished** page appears. Click **Finish** to complete the process.

Note: Uninstalling IQ Bot does not delete the IQ Bot database or any of the following dependencies. Manually remove them using recommended third party procedures.

- Erlang/OTP
 - RabbitMQ v3.8.18
 - NodeJS
 - SQL Server Native Client
 - Python
-

High Availability and Disaster Recovery overview

High availability (HA) provides a failover mechanism if an IQ Bot service or server fails. Disaster recovery (DR) enables recovery across a geographically separated distance if a disaster causes an entire data center to fail.

IQ Bot uses a minimum of 3 nodes and a maximum of 5 nodes in a cluster for high availability (HA).

IQ Bot HA and DR solution

In the context of IQ Bot, implementation of High Availability (HA) and Disaster Recovery (DR) reduces downtime and maintains continuity of business (CoB) for your bot activities.

- **High Availability (HA)**—High availability is an architectural system design that attempts to safeguard a system against certain failure scenarios. This means that even if parts of a system is failing, as a whole it is still available and usable. High availability solutions typically protect against specific scenarios

such as: server failures, single component failures, dependency failures, variable load increases, and networks splits where dependent on system components that become unreachable on a network.

- **Disaster Recovery (DR)**—Disaster recovery involves a set of policies and procedures to enable the recovery or continuation of vital infrastructure and systems following a natural or human-induced disaster. Disaster recovery addresses many different causes of failures in a system where high availability typically accounts for a predictable few. Disaster recovery has a focus on re-establishing services after an incident not just failover. Recovery of a system includes scenarios such as: restarting a service or system, restoring configuration files or a database from backups.

To ensure HA and DR protection of your IQ Bot components, configure your existing HA and DR infrastructure, load balancing, and failover systems to include IQ Bot servers and services. See your data center administrator for your approved local HA and DR procedures.

Required HA and DR infrastructure elements

- **Distributed Approach**—In addition to clustering IQ Bot related data center components, we also recommend that you deploy IQ Bot on multiple physical and, or virtual servers.
- **Load balancing**—Performed by a load balancer, this is the process of distributing application or network traffic across multiple servers to protect service activities and allows workloads to be distributed among multiple servers. This ensures bot activity continues on clustered servers.
- **Databases**—Databases use their own built-in failover to protect the data. This ensures database data recovery.
 - Between the HA clusters, configure **synchronous** replication between the primary (active) and secondary (passive) clustered MS SQL servers in the data center. This ensures consistency in the event of a database node failure.

For the required HA synchronous replication, configure one of the following:

- Backup replica to **Synchronous-Commit mode of SQL Server Always On** availability groups
- SQL to **Server Database Mirroring**
- Between the DR sites, configure your database to provide **asynchronous** replication from the primary (production) DR site to the secondary (recovery) DR site that is at a geographically separated location from the primary DR site.

Sample scenario

Point all IQ Bot instances within the same cluster to the same database and repository files. This is required to enable sharing data across multiple servers and ensuring data integrity is maintained across IQ Bots servers within a cluster.

HA and DR deployment models

To ensure your IQ Bot is protected by HA and, or DR, configure your data centers according to the deployment models described in:

- [High Availability deployment model](#)
- [Disaster Recovery deployment model](#)

HA implementation requirements

- Install IQ Bot on multiple servers.
- Access to IQ Bot is through a load balancer.
- Open a RabbitMQ v3.8.18 synchronization port between IQ Bot servers.
- Configure the Microsoft SQL Server in high availability mode.

Installation HA and DR configuration requirements

- The IQ Bot installer does not directly support cluster installation. To set up a cluster do the following:
 - Run the installer on each application server node.
 - Share the `output` folder using the access role `Everyone`.
 - Post installation, execute the `messagequeue_cluster_configuration.bat` with appropriate command line arguments.
- Configure IQ Bot in a high availability configuration.
- Open firewall ports: 4369 and 25672.
- Install RabbitMQ v3.8.18 on every IQ Bot node in the cluster.

The first node where IQ Bot is installed becomes the primary RabbitMQ v3.8.18 node. The host name of the primary node is used to configure the RabbitMQ v3.8.18 cluster.

- The load balancer is required to distribute a traffic to all IQ Bot server nodes.
- Configure Microsoft SQL Server for high availability. Use the Microsoft SQL Server **Always On** option.
- For RabbitMQ v3.8.18 specific installation, see your RabbitMQ v3.8.18 documentation.

HA and DR known limitations

- To discover the availability of IQ Bot instances, a load balancer periodically sends pings, attempts connections, or sends requests to test the IQ Bot instances. These tests are called health checks.
- Health checks do not verify the availability of RabbitMQ v3.8.18 instances.

HA cluster configuration overview

To support Automation Anywhere your data center, configure an HA cluster. Follow your company methods and procedures for implementing your data center cluster.

HA clusters protect services and data in the event of a server or service failure. The following is a list of processes associated with clusters.

Database replication

Configure synchronous replication between the primary site (active) and secondary site (passive) MS SQL servers to ensure consistency in the event of a database node failure.

Downtime

The amount of downtime depends on the number of restart attempts the administrator configures for the primary server services, the number of failovers allowed per number of hours, and the failback configuration.

Failback	<p>After the primary server is returned to normal, fail back the workload from the secondary servers to the primary servers. The primary server becomes the active server again.</p> <p>Restoring operations to the primary system or site after a failover or disaster recovery on a secondary system or site.</p>
Failover	<p>If one of the primary servers fails, the workload of the failed server automatically shifts to the secondary server in the cluster. This automatic process is called failover. Failover ensures continuous availability of applications and data. When failover completes, the secondary server becomes the active server.</p> <p>When a (primary) system detects a fault or failure, it automatically transfers control to a (secondary) duplicate system. This applies to HA clusters, where failover is from one server to another.</p>
Graceful degradation	Process allowing cluster dependencies to operate gracefully on a degraded primary site.
Redundancy	HA clusters use redundancy to prevent single points of failure (SPOF), such as a failed server or service. HA clusters include primary (active) servers that host services or databases and secondary (passive) servers that host replicated copies of the services and databases.
Replication	The secondary servers have the same configuration and software as the primary servers, they are a duplicate (redundant copy) of the primary. Data is replicated (copied) from the primary servers to the secondary servers.

To support HA and DR for Automation Anywhere, configure the selected components in your data center for HA.

Note: In the context of clusters, though the terms server, host, and node each have specific meaning, they are frequently used interchangeably.

Cluster	A cluster is a set servers (nodes) that are connected by physical cables and software. In an HA environment, these clusters of servers are allowed to be in the same physical data center.
Cluster group (role)	Group of clustered services that failover together and are dependent on each other.
Host	The cluster machine that is hosting the services.
Multiple servers	The HA technique where operations are available across multiple servers with workload managed by a load balancer. This applies to IQ Bot instances.
Node	A generic term for a machine in a cluster.

Primary node	The active node in the cluster. The machine where the production activities run. This applies to the database servers.
Secondary node	The machine that is designated as the target in the event of a failover. The secondary node is a passive duplicate of the primary node. This applies to the database servers.
Server	The machine in the cluster installed with the server operating system.

HA cluster technologies guard against three specific types of failures:

Application and service failures	These affect application software and essential services.
Site failures in multisite organizations	This is caused by natural disasters, power outages, or connectivity outages.
System and hardware failures	This affects hardware components such as CPUs, drives, memory, network adapters, and power supplies.

This ability to handle failure allows clusters to meet two requirements that are typical in most data center environments:

High availability	The ability to provide end users with access to a service for a high percentage of time and reduces unscheduled outages.
High reliability	The ability to reduce the frequency of system failure.

High Availability deployment model

The High Availability (HA) deployment model provides failure tolerance for the IQ Bot servers, services, and databases.

The following shows IQ Bot and data center components.

In this example, the IQ Bot servers and Microsoft SQL Servers have HA redundancy.

- Multiple users have access the IQ Bot cluster through their web browsers. The web browsers communicate to the IQ Bot cluster through the load balancer.
- Multiple Bot Runners communicate to the IQ Bot cluster through the load balancer.
- The server message block (SMB) file share and the Microsoft SQL Server store data from the IQ Bot cluster.
- Microsoft SQL Server uses redundancy through replication syncing to the clustered Microsoft SQL Server.

Pros	Maintains availability when server failures occur within a single data center.
Cons	Does not provide protection against data center outage.

Use Cases

Small to medium-size businesses that do not require multi-site disaster recovery.

Disaster Recovery deployment model

The Disaster Recovery (DR) deployment model uses high availability (HA) clusters distributed over a geographic area.

Disaster Recovery (DR) is a method where two high availability (HA) data center configurations are separated geographically. The extra benefit here from a single location HA configuration is that in the event of a localized disaster, the physically removed data center resumes functions with minimum downtime.

Prerequisites

Before performing the IQ Bot DR, review the following prerequisites:

- Enable the inbound and outbound ports.
- Add all the hostnames in the host file entries for all the nodes.
- Ensure that the primary and secondary databases are in sync.
- Automation Anywhere Control Room and IQ Bot must be installed on both primary (active) and secondary (passive) DR sites.
- While switching between the primary and secondary servers, ensure the following:
 - If the secondary database has read-only permission, the primary database has read/write permission.
 - If the secondary database has read/write permission, the primary database has read-only permission.

The following diagram shows the IQ Bot DR setup:

In this example, all the servers have redundancy.

- Multiple users have access the IQ Bot cluster through their web browsers. The web browsers communicate to the IQ Bot clusters through the load balancers.
- Multiple Bot Runners communicate to their IQ Bot cluster through the load balancer.
- The server message block (SMB) file share and the Microsoft SQL Server store data from their IQ Bot cluster. Both servers are asynchronously replicated to the backup disaster recovery site.
- Microsoft SQL Server uses redundancy through replication syncing to the clustered Microsoft SQL Server on the primary disaster recovery site.

For disaster recovery in IQ Bot environment.

- Deploy a second IQ Bot HA cluster in an additional data center that is in a separate geographic location.
- In the event of a primary site failure, do the disaster recovery manually. See [Disaster recovery failover steps overview](#).

Note: When a failover to a backup site occurs, it is possible that very recent changes made on the primary site are lost.

Pros

Provides business continuity when faced with data center outage or loss.

Cons

Increased operational burden.

Contact your Customer Success Manager (CSM) or Partner Enablement Manager (PEM) for more information on benchmarking IQ Bot On-Premises Disaster Recovery.

[IQ Bot On-Premises Disaster Recovery benchmarking \(A-People login required\)](#)

DR configuration requirements

When you configure your Disaster Recovery enabled data centers for IQ Bot, ensure the listed conditions are met.

Disaster Recovery configuration requirements

- **Asynchronous replication**—Configure asynchronous, rather than synchronous replication, between DR sites for all supporting services. This ensures off-site replication does not impact performance of the primary site.
- **AD domain**—Ensure the same Active Directory domain is available to both the primary and backup sites.
- **Site domains**—Ensure the backup site Control Room and device machines are members of the same domain as the primary site Control Room and machines.
- **Licenses**—Assign floating licenses for users, so that they are able to log into devices on the backup site.
- **Backup site services**—Shutdown the Control Room services at the backup site until they are needed.
- **Site configurations**—Ensure the machines at the primary site and backup site have the same specification and configuration. This includes the Control Room, Bot Runners, associated devices, and login credentials. This is required to ensure equal level of service during an outage.

Note: Schedules are stored in UTC and therefore run at the same time regardless of the physical location or time zone settings of the server.

Database Replication Details

The database replication configuration for disaster recovery is an extension of the high availability configuration. This configuration requires the use of **Always On** availability groups.

- Configure the primary site replica in **Synchronous-Commit** mode.
- Configure the recovery site replica in **Asynchronous-Commit** mode. **Asynchronous-Commit** mode ensures that the latency and reliability of the inter-datacenter does not impact the performance and availability of the primary site.
- Do not configure the recovery site replica to offer any database services until a recovery failover is triggered.

Failure mode

With asynchronous replication there is the possibility that a transaction that occurs on the primary site does not reach the recovery site replica before the failure occurs.

Note: This possibility of losing the most recent transactions applies to all DR automated application solutions using asynchronous replication, not just Automation Anywhere solution.

Deployment requires strict consistency between distant geographical locations. **Synchronous-Commit** configured between replicas with significant latency has a detrimental effect on all Control Room operations.

To prevent work items being processed twice when a failure occurs, some work items awaiting delivery to a device are placed into an error state. This ensures they can be manually reviewed and marked as ready to be processed or complete as appropriate.

Disaster recovery failover steps overview

Overview of failover steps for IQ Bot recovery after a disaster.

Complete the disaster recovery deployment on two geographically separated sites, where one site is primary (active) and the other is a backup (passive) site. Disaster recovery is performed on remote backup site.

The procedure is identical regardless of whether switching over from primary to secondary (recovery), or secondary to primary.

If the failed IQ Bot nodes are still available:

1. Shut off all IQ Bot services at the primary site.
2. Failover all IQ Bot-related databases using the database tools.
3. Failover your Server Message Block (SMB) share using the appropriate tools to make the recovery site SMB file share writable.
4. Start IQ Bot services at the recovery site.
5. Wait until the IQ Bot web interface is available.
6. Login to the web interface as an administrator.
7. After the recovery site is operating as the primary site, configure a replacement secondary site. Using the database tools, set replication from the recovery primary site to the replacement secondary site.

Re-establish a duplicate DR site

After a secondary (backup) site is recovered as the primary (production) site, establish a new secondary DR site.

The recovery site is up and running as the new production site.

The process of returning activity to a primary (active) production site, plus secondary (backup) site depends on the state of the original primary site.

- If the old production environment becomes available again, complete the following to switch back to the original DR primary site.
 - a) Restore/replicate the DR database and file system to the original production database and file system respectively.
 - b) Bring up the new DR primary (production) IQ Bot.
 - c) Verify new DR primary (production) environment is working, as expected.
 - d) Stop the DR IQ Bot services on the DR recovery site.
 - e) Establish the replication between the new DR primary (production) and DR secondary (standby) IQ Bot (DB and NAS).

- If the old DR primary production environment is rendered completely unusable due to the disaster, re-establish a new secondary (standby) DR site. Complete the recovery DR steps to re-establish primary and secondary DR sites.
 - a) Restore/replicate the database and file system data from DR environment to the new production environment.

No additional steps are required. The DR primary and secondary sites are restored.

- The bot Activation utility does not need to be run again. Activation occurs when IQ Bot is first deployed to the DR cluster sites only.
- For any subsequent disasters, only the database query needs to be run on DR secondary (standby) IQ Bot database. This is required because the replication between DR primary (production) and DR secondary (standby) overwrites DR secondary site Bot Runner data in DR secondary site database with DR primary (production) Bot Runner data.
- Similarly, the mapping between DR primary and DR secondary Bot Runner is established. Use the same mapping for all subsequent disasters or mock drills.

Migrate to Automation 360

Important: See [Upgrade launchpad \(A-People login required\)](#) for a self-guided experience tailored to your Control Room version, with resources and support to migrate to Automation 360.

Migration is the process of moving your data and bots from Enterprise 11 or Enterprise 10 to Automation 360. Migration includes but is not limited to replicating and updating your existing database and repository, converting your bots to the Automation 360 format, and migrating learning instances for IQ Bot and dashboards for Bot Insight.

Automation 360 is a single, integrated cloud-native Digital Workforce platform that is designed for flexibility and agility. Migrating to this platform provides you benefits such as faster time to value, business agility, and lower TCO.

For more information, see [About Automation 360](#).

What is migration

The migration process copies all your Enterprise 11 or Enterprise 10 entities such as users, roles, lockers, and bots to Automation 360. This eliminates the efforts required to re-create all these entities in Automation 360. The migration process also eliminates the possibility of missing out on copying an entity that might be required to run a bot after migration. All the Enterprise 11 or Enterprise 10 entities are ready for use in Automation 360 after they are successfully migrated, except bots and MetaBots.

When Enterprise 11 or Enterprise 10 data is migrated, bots are copied as `.atmx` files and MetaBots are copied as `.mbot` files. You must convert these bots and MetaBots to the Automation 360 format before you use them.

Migration also includes migrating your IQ Bot learning instances and Bot Insight dashboards.

IQ Bot migration

When migrating Enterprise 11 or Enterprise 10 bots, migrate your IQ Bot learning instances. Before starting the IQ Bot migration, ensure that your Automation 360 environment is installed and set up for use. IQ Bot migration involves migrating the bots built to use IQ Bot as well as the IQ Bot learning instances that have been trained for data extraction.

Use the IQ Bot server upgrade and learning instance procedures to move the information over to your new system. See [Migrate to Automation 360 IQ Bot](#).

Bot Insight migration

Migration of the Bot Insight data and dashboard is performed as part of the overall migration process. It involves cloning your Bot Insight database (which is separate from your Enterprise 11 Control Room database) and using the pre-migration utility to extract your dashboard metadata (widgets, layouts, and so on).

Migration phases

Migration involves three main steps, as shown in the following image:



1. *Check migration readiness*

Analyze your bots using the Bot Scanner and review the generated report to verify your migration readiness.

2. *Prepare new Control Room for migration*

Choose your deployment model (Cloud, On-Premises, or Cloud-enabled) and request for the migration licenses. Prepare your Control Room and environment for the migration.

3. *Migrate and validate bots*

Convert your Enterprise 11 or Enterprise 10 bots to Automation 360 format. After migration, verify the converted bots run successfully, and update bots as required based on the migration reports or testing phase.

Note: If you encounter any error when you migrate from Enterprise 11 or Enterprise 10, you might have to review or take some actions on the migrated bots. See [Migration messages](#).

Tools used for migration

The following tools are available for migration:

Bot Scanner

The Bot Scanner scans your existing bots (TaskBots and MetaBots) and generates reports. These reports provide information about the commands and variables used in these bots and how many of these commands and variables are supported for migration in Automation 360. (The scanner was previously called the pre-migration utility.)

[Bot Scanner overview](#)

Bot Migration Wizard

Integrated in the Automation 360 Control Room, this tool guides you through the process of converting the bots to the Automation 360 compatible format after you have completed the prerequisites steps. The wizard enables you to migrate multiple bots (TaskBots and MetaBots) and their dependent bots.

The migration wizard migrates a bot only if all of the components used in that bot are supported for migration in Automation 360.

[Migrate Enterprise bots](#)

Cloud Migration Utility

This tool enables you to upload all your Enterprise 11 data to Automation Anywhere Cloud. After the data is successfully uploaded to Cloud, the Cloud Control Room is created and all the uploaded data

is available for use in that Control Room. The utility migrates data from Control Room repository (bots, their dependencies, and Credential Vault) and Control Room database (users, roles, schedules, queues, and Control Room settings).

[Upload Enterprise 11 data using Cloud Migration Utility](#)

Audit log data migration utility

This utility enables you to export the audit log data from the Enterprise 11 Control Room to a JSON file. You must paste the JSON file in the Automation 360 repository and then migrate the audit log data.

Bot Insight pre-migration utility

This utility enables you to export Enterprise 11 Bot Insight dashboard metadata (widgets and layouts) and dashboard profiles as a zip file. You must paste the zip file in the Automation 360 repository to migrate the Bot Insight dashboards.

[Export Enterprise 11 Bot Insight dashboards for migration](#)

What is migrated and not migrated

Enterprise 10: Review the information about what is migrated and what is not migrated for the On-Premises deployment model.

Enterprise 10	Migrated to On-Premises
Bots and their dependencies	Yes
Credential Vault	Yes
Roles	Yes
Users	Yes
Schedules (these are disabled after they are migrated to Automation 360)	Yes
Audit logs	No
Bots version control history	No
Devices and device pools	No
File system logs	No
IQ Bot (IQ Bot migration requires a separate process)	No



Enterprise 11: Review the information about what is migrated and what is not migrated for the different deployment models.

Enterprise 11	Cloud	On-Premises
Users, roles, and credential variables and lockers	Yes	Yes
Bots and their dependencies	Yes	Yes

Enterprise 11	Cloud	On-Premises
Schedules (these are disabled after they are migrated to Automation 360)	Yes	Yes
Workload queues	Yes	Yes
Bot Insight dashboards <ul style="list-style-type: none"> • Published dashboard • Default and customized dashboard 	Yes	Yes
Bots transactional data <ul style="list-style-type: none"> • Private workspace transactional data (bots which run with Bot Creator license) • Public workspace transactional data (bots which run with Bot Runner license) 	Yes	Yes
Bot execution operational data	Yes	Yes
Licenses	Yes (Requires unique license GUID)	Yes
IQ Bot learning instances (IQ Bot migration requires a separate process)	No	Yes
Audit logs	No	Yes
Device pools	No	Yes
Historical data	Yes	Yes
Control Room settings	No	Yes
Bots version control history	No	No
Devices	No	No
File system logs	No	No
Workflows	No	No
Bot Insight dashboards for imported bots	Yes	No
AASettings.xml file data	No	No

Choose your migration path

After you have verified the migration readiness for your current version, choose your migration path based on the Automation 360 deployment model that meets your business requirements.

If you are on this version	Start your migration
<p>Enterprise 11</p>	<ul style="list-style-type: none"> Enterprise 11 to Automation 360 Cloud (using the Cloud Migration Utility) <p>Workflow map: Click the following schematic image to view this migration workflow in an interactive visual</p>  <p>format:</p> <ol style="list-style-type: none"> Migrating from Enterprise 11 to Automation 360 Cloud Enterprise 11 to Automation 360 On-Premises <p>Workflow map: Click the following schematic image to view this migration workflow in an interactive visual</p>  <p>format:</p> <ol style="list-style-type: none"> Migrating from Enterprise 11 to Automation 360 On-Premises Manually migrate to Automation 360 Cloud Manually migrate to Automation 360 On-Premises Enterprise 11 to Cloud-enabled Enterprise 11 to Automation 360 on Linux CentOS
<p>Enterprise 10</p>	<ul style="list-style-type: none"> Enterprise 10 to Automation 360 On-Premises <p>Workflow map: Click the following schematic image to view this migration workflow in an interactive visual</p>  <p>format:</p> <ol style="list-style-type: none"> Migrating from Enterprise 10 to Automation 360 On-Premises

If you have a large number of bots, you can run both Automation 360 and Enterprise 11 or 10 in parallel. This dual-environment method helps to eliminate downtime. Choose one of the following procedures based on your deployment model:

If you want to use these dual environments	Use this procedure
Enterprise 11 and Automation 360 Cloud	Enterprise 11 and Automation 360 Cloud in parallel
Enterprise 11 and Automation 360 On-Premises	Enterprise 11 and Automation 360 On-Premises in parallel
Enterprise 10 and Automation 360 On-Premises	Enterprise 10 and Automation 360 On-Premises in parallel

Other resources

The following resources can help you in your journey with Automation 360:

- [Upgrade launchpad \(A-People login required\)](#): Provides a self-guided experience tailored to your Control Room version, with resources and support to migrate to Automation 360.
- [Migration resource center](#): Access multiple migration resources, including videos, project templates, and high-level information from one place.
- [Automation Anywhere University: RPA Training and Certification \(A-People login required\)](#): Access the *Migrating to Automation 360* learning trail.

Learn how to use Automation 360 with Automation Anywhere University for hands-on learning that is designed for beginners to advanced developers. Instructor-led training options are also available.

- [Automation 360 Migration FAQ](#)
- [XML path is not working which works fine in Enterprise 11](#)

Related tasks

[Update to latest Automation 360 version](#)

If you are already using Automation 360 On-Premises, you can update to the latest version of Automation 360.

Migration best practices

Review best practices and guidelines on the migration process (migrating your bots, Bot Insight, and IQ Bot) and on the Bot Scanner, Control Room, and Credential Vault to complete your migration successfully.

Bot Scanner

When using the Bot Scanner to check your migration readiness, consider these best practices:

- Create a copy of your Enterprise 11 or Enterprise 10 Control Room repository.
Create a copy of your Control Room repository on the device on which you want to run Bot Scanner.
- Use the latest version of Bot Scanner.

New versions of Bot Scanner are available with each Automation 360 release. The latest version is updated with support for more Enterprise 11 or Enterprise 10 commands and features, which helps you to decide when to migrate.

- Always run the Bot Scanner on the copy of the Enterprise 11 or Enterprise 10 repository.

- Do not mix bots from multiple Control Room instances. For example, if you have two Control Room instances, do not copy bots from both Control Room instances at the same location and use that location in the Bot Scanner to scan these bots.
- Review the Bot Scanner report thoroughly.

The report helps you to determine which bots are ready for migration and when support for unsupported commands and features will be available. Understanding timelines for unsupported commands and features helps you decide when to migrate.

Control Room and Credential Vault

- Create and save a backup of Enterprise 11 or Enterprise 10 Control Room repository and database before you install Automation 360.

Use this backup to perform migration so that there is no disruption to your existing Enterprise 11 or Enterprise 10 automation.

- Do not change the name of the database when you restore the backup of the Enterprise 11 or Enterprise 10 database.
- For migration, do not use a machine on which Automation 360 is already installed.
- Configure Credential Vault in express mode.

Bot building

When building new bots in Enterprise 11 or Enterprise 10, keep the following considerations in mind so that migration to Automation 360 is easier.

Note: These considerations will mainly help users who have a dual environment (running Enterprise 11 or Enterprise 10 and Automation 360 in parallel).

- Do not use Microsoft Internet Explorer to build your automations as Microsoft is planning to discontinue support for Internet Explorer from June 2022 on certain operating systems.
- Use object-based automation wherever possible: For example, use Object Cloning command instead of Web Recorder command.
- Use AISense Recorder very minimally as migration of this recorder is not yet supported in Automation 360.
- Do not use Citrix Automation, Internet Connection commands, Apache Flex, Adobe Flash, or the Microsoft Edge (legacy) browser in Object Cloning as these are not supported in Automation 360.

Bot migration

- Assign the required migration role and permissions to users who will start the migration process and the Bot Runners that will be used for bot migration.
- Assign the required device permissions for the devices that will be used for bot migration.
- Install the Bot Agent on the devices that will be used for bot migration.
- Test the Automation 360 setup before using the Bot Migration Wizard to migrate your bots.

Create and run a sample bot before using the Bot Migration Wizard. This helps to ensure that Automation 360 system prerequisites such as device registration, credential updates, and Auto Login are met.

- Start migration with a business process for which all the bots are completely ready for migration.

- Check for any required manual updates for migrated .

Review the messages for the migrated bots to check if any updates are required for the migrated bots to run these bots successfully. The list of bots that require updates after migration is available in the **Action required** tab of the Bot Scanner report.

Post-migration

- Validate the migrated bots.

Plan a dedicated time to validate and ensure that the bots are migrated successfully. Do not delete the Enterprise 11 or Enterprise 10 format bots until you complete validating that these bots run successfully after migration.

- Create all new bots in Automation 360 after migration is completed.
- If you have updated any bots in Enterprise 11 or Enterprise 10 after migration, you must migrate these bots again.

Bot Insight migration

- Back up and restore the Enterprise 11 Bot Insight database before you install Automation 360.
- Use the same credentials you have used for Enterprise 11 database when you restore the database.

IQ Bot migration

- Download the database migration assistant that is compatible with your Automation 360 version.
- Create backups of Enterprise 11 databases.
- Stop processing, training, and validating documents in Enterprise 11.
- Prepare a new environment for IQ Bot and the database migration assistant installation.
- Restore backed-up Enterprise 11 databases in different locations.
- Review the database migration assistant log file.
- Clean up the application registration information in the IQ Bot database if the Automation 360 Control Room address is new.
- Migrate learning instances one at a time. Do not place all learning instances in one `iqba` file.

Tools for migration

We have moved the information that was on this page to other pages. See the following links for more information.

- For an overview of migration, including information that was previously on this page, see [Migrate to Automation 360](#).
- For information about Bot Scanner, see [Bot Scanner overview](#) .
- For information about Bot Migration Wizard, see [Bot Migration Wizard](#).

Check migration readiness

Perform the tasks in this workflow to verify whether you are ready to migrate to Automation 360 from Enterprise 11 and Enterprise 10.



1. Verify the current version of your Enterprise 11 or Enterprise 10 platform.
[Verifying your Enterprise 11 or Enterprise 10 version for migration](#)
2. Check whether your current Enterprise 11 or Enterprise 10 version is supported for migration.
[Supported Control Room versions for migration](#)
3. Compare Automation 360 and Enterprise 11 or Enterprise 10 features.
[Automation 360 feature comparison matrix](#)
4. Review information about packages mapping and variables mapping to understand how Enterprise 11 or Enterprise 10 commands and variables differ from the equivalent Automation 360 packages and variables.
[Package mapping for migration](#) | [Variable mapping for migration](#)
5. Use the Bot Scanner to analyze your bots and identify commands and variables used in the bots that are supported for migration in Automation 360.
[Scan Enterprise 11 or 10 bots using Bot Scanner](#)
6. Analyze the report generated by the Bot Scanner.
[Analyze Bot Scanner report for migration](#)

[Prepare new Control Room for migration](#)

Supported Control Room versions for migration

Review the Enterprise 11 and Enterprise 10 versions that are certified and supported for migration to Automation 360 On-Premises and public or private Cloud on Microsoft Windows Server. A *certified* Enterprise 11 or Enterprise 10 version means that major functionality of that platform version and bots developed on the version are supported in Automation 360.

Support for more Enterprise 11 and Enterprise 10 versions will be added over a period of time.

Remember: The Enterprise 11 and Enterprise 10 versions that are not listed in the following tables are not certified for migration. If you are using a version that is not certified for migration and you want to migrate to Automation 360, you must first upgrade to a version that is certified and then proceed with migration.

If you are migrating from OEM products such as IBM RPA, contact Automation Anywhere Support: [Open a support case \(A-People login required\)](#)

On-Premises migration: Supported Enterprise 11 and 10 versions

If you are using any of the following Enterprise 11 and Enterprise 10 versions, you can perform the migration. The table also lists the base version of Automation 360 from which the specific Enterprise 11 or Enterprise 10 version is supported.

[Supported Enterprise 11 versions](#) | [Supported Enterprise 10 versions](#)

Enterprise 11 versions for On-Premises migration

Enterprise 11 releases	Supported Control Room version	Supported Automation 360 ba
11.3.5	<ul style="list-style-type: none"> • 11.3.5.5 • 11.3.5.4 • 11.3.5.3 • 11.3.5.2 • 11.3.5.1 • 11.3.5 	<ul style="list-style-type: none"> • v.23 and later • v.24 and later • v.24 and later • v.23 and later • v.16 and later • v.18 and later
11.3.4	<ul style="list-style-type: none"> • 11.3.4.7 • 11.3.4.6 • 11.3.4.5 • 11.3.4.4 • 11.3.4.3 • 11.3.4.2 • 11.3.4.1 • 11.3.4 	<ul style="list-style-type: none"> • v.25 and later • v.23 and later • v.24 and later • v.23 and later • v.16 and later • v.20 and later • v.19 and later • v.17 and later
11.3.3	<ul style="list-style-type: none"> • 11.3.3.5 • 11.3.3.3 • 11.3.3.2 • 11.3.3.1 • 11.3.3 	<ul style="list-style-type: none"> • v.23 and later • v.16 and later • v.22 and later • v.21 and later • v.17 and later
11.3.2	<ul style="list-style-type: none"> • 11.3.2.5 • 11.3.2.4 • 11.3.2.2 • 11.3.2.1 • 11.3.2 	<ul style="list-style-type: none"> • v.23 and later • v.15 and later • v.09 and later • v.09 and later • v.08 and later
11.3.1	<ul style="list-style-type: none"> • 11.3.1.11 (over 11.3.1) • 11.3.1.11 (over 11.3.1.2) • 11.3.1.10 • 11.3.1.9 • 11.3.1.8 • 11.3.1.7 • 11.3.1.5 • 11.3.1.4 • 11.3.1.2 • 11.3.1.1 • 11.3.1 	<ul style="list-style-type: none"> • v.23 and later • v.23 and later • v.22 and later • v.17 and later • v.19 and later • v.15 and later • v.17 and later • v.20 and later • v.22 and later • v.21 and later • v.09 and later
11.3	<ul style="list-style-type: none"> • 11.3 	<ul style="list-style-type: none"> • v.10 and later

Enterprise 11 releases	Supported Control Room version	Supported Automation 360 base version
11.2.1	<ul style="list-style-type: none"> • 11.2.1.6 • 11.2.1.5 • 11.2.1.4 • 11.2.1.3 • 11.2.1.2 • 11.2.1.1 • 11.2.1 	<ul style="list-style-type: none"> • v.23 and later • v.20 and later • v.15 and later • v.11 and later • v.11 and later • v.23 and later • v.23 and later
11.2	<ul style="list-style-type: none"> • 11.2 	<ul style="list-style-type: none"> • v.19 and later
11.1	<ul style="list-style-type: none"> • 11.1.2 • 11.1.0 	<ul style="list-style-type: none"> • v.22 and later • v.23 and later

Enterprise 10 versions for On-Premises migration

Supported Control Room Enterprise 10 version	Supported Automation 360 base version
10.7.5	v.16 and later
10.5.141	v.22 and later
10.5.113	v.18 and later
10.5.112	v.18 and later
10.5.17	v.18 and later
10.5.16	v.12 and later
10.5.15	v.16 and later
10.5.14	v.22 and later
10.5.13	v.20 and later
10.5.12	v.22 and later
10.5.11	v.15 and later
10.5.9	v.17 and later
10.5.0	v.12 and later
10.3.11	v.25 and later
10.3.5	v.25 and later
10.3.0	v.22 and later

Cloud migration: Supported Enterprise 11 versions

If you are using any of the following Enterprise 11 versions, you can perform the Cloud migration.

All supported Enterprise 11 Control Room versions listed in this table also support Bot Insight migrations.

Enterprise 11 releases	Supported Control Room versions
11.3.5	<ul style="list-style-type: none"> • 11.3.5.5 • 11.3.5.4 • 11.3.5.3 • 11.3.5.2 • 11.3.5.1 • 11.3.5
11.3.5	Certified for IBM installer versions: <ul style="list-style-type: none"> • 11.0.0.10.iFix004 (over Automation Anywhere 11.3.5.4) • 11.0.0.10.iFix003 (over Automation Anywhere 11.3.5.3) • 11.0.0.10.iFix002 (over Automation Anywhere 11.3.5.2) • 11.0.0.10.iFix001 (over Automation Anywhere 11.3.5.1) • 11.0.0.10 (over Automation Anywhere 11.3.5 JDK update) • 11.0.0.9 (over Automation Anywhere 11.3.5)
11.3.4	<ul style="list-style-type: none"> • 11.3.4.6 • 11.3.4.5 • 11.3.4.4 • 11.3.4.3 • 11.3.4.2 • 11.3.4.1 • 11.3.4
11.3.3	<ul style="list-style-type: none"> • 11.3.3.5 • 11.3.3.3 • 11.3.3.2 • 11.3.3.1 • 11.3.3
11.3.2	<ul style="list-style-type: none"> • 11.3.2.5 • 11.3.2.4 • 11.3.2.2 • 11.3.2.1 • 11.3.2

Enterprise 11 releases	Supported Control Room versions
11.3.1	<ul style="list-style-type: none"> • 11.3.1.11 (over 11.3.1.2) • 11.3.1.11 (over 11.3.1) • 11.3.1.10 (over 11.3.1) • 11.3.1.9 (over 11.3.1) • 11.3.1.7 (over 11.3.1.2) • 11.3.1.7 (over 11.3.1) • 11.3.1.5 (over 11.3.1) • 11.3.1.4 (over 11.3.1.2) • 11.3.1.4 (over 11.3.1) • 11.3.1.2 • 11.3.1.1 • 11.3.1
11.3	<ul style="list-style-type: none"> • 11.3
11.2	<ul style="list-style-type: none"> • 11.2.1.6 • 11.2.1.5 • 11.2.1.4 • 11.2.1.3 • 11.2.1.2 • 11.2.1.1 • 11.2.1 • 11.2
11.1	<ul style="list-style-type: none"> • 11.1.2 • 11.1.0

Cloud migration: Supported database deployment types

Cloud migration is supported for the following database deployment types:

Database deployment type	Contained database	Uncontained database
Microsoft SQL Server on AWS RDS	Yes	Yes
Microsoft SQL Server on Azure PaaS	Yes	Yes
Microsoft SQL Server on Google cloud	Yes	Yes

Supported Microsoft SQL Server database versions

For database deployment types listed in the previous table, you can host any of the following Microsoft SQL Server database versions. Note that all the Database editions (Enterprise, Express, Standard, Developer (for 2019), and GCP Cloud SQL) are supported for migration.

Database	Build	File version	Supported operating system
Microsoft SQL Server 2014	12.0.2000.8	2014.120.2000.8	Windows Server 2012 R2 Standard and later
	12.0.6024.0	2014.120.6024.0	
Microsoft SQL Server 2016	13.0.5026.0	2015.131.5026.0	Windows Server 2012 R2 Standard and later
Microsoft SQL Server 2017	14.0.1000.169	2017.140.1000.169	Windows Server 2012 R2 Standard and later
Microsoft SQL Server 2019	15.0.2000.5	2019.150.2000.5	Windows Server 2016 and later

Verifying your Enterprise 11 or Enterprise 10 version for migration

Migration to Automation 360 is supported for many certified versions of Enterprise 10 and Enterprise 11. Before you start the migration process, verify your current platform version and then check if that version is currently supported for migration.

Verify your current platform version

You can find your current platform version in both the Control Room and Enterprise Client. Verify your platform version from your Control Room:

1. Log in to your Enterprise 11 Control Room.
2. Click the Help icon on the top-right of the Control Room to verify the version number, which is listed at the bottom of the menu.

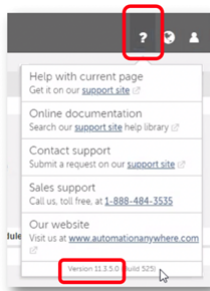

Verifying versions supported for migration

After you have verified which Enterprise 11 or Enterprise 10 version your organization has deployed, check which versions are supported for migration.

1. Go to the following page: [Supported Control Room versions for migration](#).
2. Verify if your version is supported for migration.

The supported versions for both Cloud and On-Premises migration are listed on this page.

Platform version not on supported list

Although we recommend that you begin migration after confirming if your version is supported for migration, you can still run the Bot Scanner to determine which of your bots and their corresponding commands are ready for migration. This will help you plan your migration by learning when currently unsupported bots and commands will be supported in an upcoming release.

Unsupported features for migration

Review the features that are not supported for migration from Enterprise 11 or Enterprise 10 to Automation 360.

Features not yet supported

The following features are **not yet supported** for migration:

- In migrated bots, if you are using OLE DB Driver version 18 or later and when you export SQL Server Database with bit columns to a CSV file, the bit value of `-1` is returned instead of `1` for string value `TRUE`.
Fixed in: **v.27**
- When you migrate bots using **SAP > Select item by index** command, incorrect index is displayed in the migrated bot.
Fixed in: **v.26**
- Bots that include the Terminal Emulator package are migrated only to **Advanced Technology** and not to **Legacy Technology**.
- When you migrate a bot that was using the Manage Window Controls action, the last digit of the height value is not available after migration. However, the bot will execute successfully.
Fixed in: **v.26**
- When an Excel session is active in SAP, a corresponding Excel process starts in the background. In such a scenario, Automation 360 uses the same Excel process that SAP started. When you run a bot to automate spreadsheet data, Automation 360 processes the first request successfully. However, during execution, if the Excel is closed and a subsequent request is sent for automating the spreadsheet data, Automation 360 does not process the request because the Excel process is still being accessed by SAP. Therefore, the correct window is not activated for automating the spreadsheet data.
Fixed in: **v.26**
- If a bot is using the **Structured text** type field in the **PDF > Extract text** action, some of the characters might not be extracted correctly.
Fixed in: **v.25**
- After migration, the **Before**, **Before and/or after**, and **After** options in the **String > Extract text** action does not match the case in a string.
Fixed in: **v.25**
- After migration, bots that were using the **Get text > All lines** action in Enterprise 11 will display only 24 rows of lines in the Terminal Emulator.
Fixed in: **v.26**
- Migrating bots with **Get Total Rows** command in SAP GUI returns values as **Float** string type instead of an **Integer** type after migration.
Fixed in: **v.26**

- If you are a Bot Creator or a Bot Runner user, you might not be able to view the Review messages displayed in the **Bot Assistant** without having the **View migration** permission.

Fixed in: **v.26**

- When you use counter as a variable in a nested loop, the parent loop functions properly but the child loop does not run as expected.

Fixed in: **v.27**

- Bots with SAP packages cannot pick and convert window titles that include "*" (asterisk) character. These window titles are not converted to currently active window names after migration.

Fixed in: **v.26**

- Bot deployment might fail when you run migrated bots with the **SAP > Get Property** command. This issue occurs because of the following reason: In Enterprise 11, property name is case in-sensitive. During migration, property name is changed to being case sensitive, so bot deployment fails when the case of property name does not match.

Fixed in: **v.26**

- When you send an email through **Exchange Web Services (EWS)**, the format of the email output do not have line breaks , the content appears tampered, and the entire content of the email appears in a single line.

Fixed in: **v.26**

- The Enterprise 11 or Enterprise 10 Bot Runner and Bot Creator devices are not included in the migration process and are therefore not migrated to Automation 360.

The Automation 360 Bot Agent replaces the Enterprise 11 and Enterprise 10 Enterprise Client. Use the Bot Agent to connect a device to the Automation 360 Control Room and run bots on the connected devices.

- When you run a migrated bot with the option **Validate if attachment is missing** option checked, and if the attachment is missing when you send the email, the bot might not run successfully.
- Workflows, triggers, version control history of bots, and file system logs.
- Migration of Enterprise 11 bots that uses Subversion Version Control for version control.
- Control Room that uses Automation 360 Cloud on Google Cloud Platform.
- Control Room that uses Oracle Database.

Fixed in: **v.26**

- Migration of Bot Insight data and other entities such as users, roles, schedules and credential variables when Automation 360 is installed using a fresh database.
- Cut, copy, paste, and Ctrl+A functions on the terminal screen when using Terminal Emulator.

Fixed in: **v.27**

- Use of a variable within a variable (except value type variables) in a bot.

For example, if a bot contains \$variable1\$, where \$variable1\$ contains \$variable2\$, and \$variable2\$ contains the actual value, this bot cannot be migrated.

- Use of a fixed value and a variable to specify the index position, for example, \$v_ArrVar(1\$RowIndex \$,1)\$.
- The capability to capture images from the runtime window when a bot is being executed.
- Enterprise 11 or Enterprise 10 bots that use a string value in a variable that is used in the If command along with '<' or '=' operator are migrated to Automation 360. However, these bots encounter an error when they run in Automation 360.
- The If command or the Loop command that use '<', '>', '<=', or '>=' operator with variables that contain a string value encounters an error after migration.

For example, if you have a bot that contains a variable with the value `abcd` and uses the `>` operator, the bot encounters an error when it is run after the migration because string type variables are not suppose to use the `<`, `>`, `<=`, or `>=` operator.

- Object Cloning command that automates the following applications:
 - Flash applications
 - Web application running on Edge-Legacy browser
- Enterprise 11 or Enterprise 10 bots were able to run a Microsoft Excel macro from the Microsoft Excel file available in the `XLSTART` folder when the that macro is called from another Excel file that does not contain that macro. After migration, these bots are not able to run the macros which are available in another Excel
- The arrow symbol is not displayed in the Automation 360 Bot editor.

When the arrow symbol is used in Enterprise 11 or Enterprise 10 bots, the Bot editor does not display any symbol after migration, with one exception. The exception is that when the symbol is used in multiple IF/ELSE commands, the Bot editor displays the `$String:FormFeed$` variable instead of the arrow symbol.

Unsupported features with workaround

You can migrate bots with the following features if you update them based on the specified workaround:

- In Enterprise 11, if bots were using a window title value or variable that contained leading spaces, after migration, the bots will be unable to select the corresponding window.

Workaround: Remove the leading spaces from the window title value or variable and then run the bots.

- When you use the Recorder to capture an object, select **HTML Tag**, **HTML InnerText**, and **HTML type** properties in **Search** Criteria, or migrate a bot with similar properties selected in **Search** Criteria, the bot fails to identify or locate the object and perform the selected action.

Workaround: Modify the **DomXpath** according to the controls you capture or add more properties in **Search** Criteria.

- When your bot has some error, you add the **Try/Finally** block around those actions and insert one more action in the **Finally** block. When you save and run the bot, you will see the Bot error dialog shows the wrong error line number within the **Finally** block.

Workaround: If you are using **Try** and **Finally** without using **Catch** action, the Bot error dialog will not show the correct line number. Instead, use **Try/Catch**, the **Try** action handles the error and sends execution to **Catch** with line number and description. This would give the correct line number within the **Finally** block.

- **Note:** Issue applies only to v.22 and earlier (as this is fixed in v.23, see [Migration of non-credential vault variables](#)). The **Run Logic** command that uses credential variables as input for a logic of a MetaBot

Workaround: Bots that use the **Run Logic** command that passes Credential Vault attributes from a TaskBot to a MetaBot logic can be migrated to Automation 360. The credential name and attribute name are displayed in the fields in the corresponding line of the migrated bot.

If you have migrated using the restored Enterprise 11 database, an equivalent locker is created in Automation 360 for the credential variables used in the Enterprise 11 bot.

Choose one of the following options to run the migrated bots successfully:

- **Option 1:** Pass the credential type variables.
 1. Create a credential type variable in the child bots as input variables.
 2. In the **Run** action of the Task Bot package of the parent bot, update the input value fields to use the Credential Vault attributes for the credential type variable created for the child bot (corresponding to MetaBot logic).
- **Option 2:** Pass the credential values as a global value.
 1. Create the Global value in Automation 360 for the credentials use in the **Run Logic** command in Enterprise 11.
 2. In the **Run** action of the Task Bot package of the parent bot, update the Input value fields to use the Global values for the credential type variable created for the child bot (corresponding to MetaBot logic).

If you have not used the restored Enterprise 11 database when installing Automation 360, you must first create the required locker for the credential variables used in the Enterprise 11 bot, before performing the preceding steps.

Note: Automation 360 provides enhanced security by allowing you to assign Credential Vault attributes only to the credential type variables. This restricts any nonsecure handling of Credential Vault attributes where they might have been assigned to non-credential type variables.

- When you create DLLs with different functions, if you use the same filename for DLLs and add them to multiple MetaBots, after migration, if a TaskBot is using the Logic of these MetaBots, an error occurs during execution.

The error occurs because the DLL sessions are based on the DLL filenames, and only the session of the first DLL will be active during execution. Any function called from subsequent DLLs will not be present in the first DLL session that is active.

For example, consider that MetaBot1 is using a DLL that has function1 and MetaBot2 is using a DLL that has function2, and both the DLLs have the same filename `test.dll`. After migration, when you run a TaskBot that uses MetaBot1 Logic and MetaBot2 Logic, the DLL session of MetaBot1 Logic is activated and function1 runs successfully. However, when the MetaBot2 Logic is run, the corresponding DLL is not activated because the session with the same DLL filename is already active, and function2 is not present in the DLL of MetaBot1 Logic, which results in an error.

Workaround: Depending on your requirements, you can perform one of the following workarounds:

- Before migrating the bots, ensure that you rename the DLL filename of one of the DLLs, update the references to the DLL function in MetaBots Logic, and then migrate the bots.
- After migrating the bots, change the session name in the **Create DLL session** box of the Open DLL action and then update the same DLL session name in the related **If** action for the **DLL Session does not exist** condition and the **Run DLL** action.

- In Enterprise 11, if a MetaBot was using `Microsoft.Exchange.WebServices.dll` to use Microsoft Exchange services, after migration, when you use the **Get DLL details** option in the **DLL Run function**, an error is encountered. The error is because, in Automation 360, the `Microsoft.Exchange.WebServices.dll` is not automatically installed in the global assembly cache (GAC) on your device.

Workaround: You must manually install the `Microsoft.Exchange.WebServices.dll` in GAC on your device and then use the **Get DLL details** option.

See [How to: Install an assembly into the global assembly cache](#).

- In Enterprise 11, if you used the Loop action to open the same Excel sheet multiple times without closing it, after migration, an error occurs. The error occurs because, in Automation 360, only one Excel session can be active at a time.

Workaround: In the Loop action, ensure that you use the **Close** action to close the Excel session before opening the Excel sheet again with the same session name.

- In Enterprise 11, if bots were using the **String > Replace** action to find a carriage return line feed (CRLF) character and replace it with another character, after migration, the output might not be the same as the output seen in Enterprise 11.

Workaround: In the **Find string** option, instead of the **Enter** (LF) variable, use the **Newline** (CRLF) variable.

- After migration, bots that were using the Log To File action to log files are using the LF character instead of the CRLF character for new lines.

Workaround: Use the `$String:Newline$` variable to use the CRLF character in the migrated bots.

- If a MetaBot Logic (for example, Logic A) is referenced to a TaskBot or another MetaBot Logic and if Logic A was renamed or moved from one logic folder to another within the same MetaBot, after migration, the TaskBot or MetaBot Logic does not work when it calls for Logic A.

Workaround: In the TaskBot or MetaBot Logic which calls for Logic A, update the name or path to reference to Logic A.

- If a bot is using the **Browser > Download files** action to download files from a URL, some files whose URLs have special characters or require Windows native authentication access might not download properly.

Workaround: Use the **Browser > Open** action instead.

- Automated migration to Automation 360 Cloud.

Workaround: You can use the manual process to migrate to a Cloud-enabled instance. See [Prepare for Enterprise 11 to Automation 360 Cloud-enabled migration](#).

- When you insert XML > **Insert node** as an attribute using a variable, the bot migration might fail.

Workaround: Insert the attribute by providing the direct value instead of a variable.

- When you run migrated bots that open URL without the protocol information (such as http, https, or file), the web page might not open properly.

Workaround: Ensure that you add the appropriate protocol information to the URL.

- If a MetaBot Logic was using a DLL file that used classes without a namespace, after migration, any TaskBot that uses the MetaBot Logic will not work.

Workaround: Manually update the DLL file to include namespace for classes.

- After migrating bots, an error is seen when using FTP actions on bots that are using comma in the filenames and when using the Delete files and Delete folder FTP actions on bots that are using colon in the filenames.

Workaround: Ensure that you remove comma in the filenames before using the FTP actions and colon in the filenames before using the Delete files and Delete folder FTP actions.

- If a bot was using the Send action to send an email with attachments where the path for the attachments were variables, the bot will either fail to execute or ignore the attachment.

Workaround: Replace variables with the paths for the attachments.

- Enterprise 11 or Enterprise 10 bots encounter an error after migration when these bots use the **Run Logic** command to run a MetaBot logic and the location of the logic is specified up to the folder that contains that logic. For example, consider you want to run Logic1 that is available in `D:Metabots\Logics\Finance` location. If you specify only `D:Metabots\Logics\Finance` instead of the complete path (`D:Metabots\Logics\Finance\Logic1`) of the logic, an error is encountered.

Workaround: Update the path of all the MetaBot logic to the complete path in Enterprise 11 or Enterprise 10 bots before migration.

- Enterprise 11 or Enterprise 10 MetaBots that use the credential variable to pass a numeric value as an input to a DLL function.

Workaround:

1. Update the DLL function to use the input parameter of type string.
 2. Delete the commands from the MetaBots that pass the numeric type input parameter to the DLL function.
 3. Add the commands in the MetaBots to pass the string type input parameters to the DLL function.
 4. Migrate the relevant TaskBots and MetaBots.
- If you are migrating to Automation 360 Cloud and you have configured SAML as the authentication type in Enterprise 11, the migration process changes the authentication type to the Control Room database authentication type for the migrated Automation 360 Control Room.

Workaround: To configure SAML as the authentication type for the Cloud Control Room after migration, perform these steps:

1. Delete the user that was used to configure SAML in Enterprise 11 from Automation 360.
 2. Create another user with the required permissions and use that user to configure SAML in Automation 360.
- **Applicable to v.24 and earlier:** Migration from Enterprise 10 to Automation 360 Cloud.

Workaround: Migrate to an Enterprise 11 version that is supported for migration to Automation 360 Cloud and then migrate to Automation 360 Cloud.

- Enterprise 11 bots that use the Exchange Web Service (EWS) to send email using the Send Email command encounters an error after they are migrated to Automation 360

Workaround: Create the following global values in Automation 360 and update the migrated bots to use EWS in all the actions:

- AAE_EmailSettings_auth
- AAE_EmailSettings_host
- AAE_EmailSettings_port
- AE_EmailSettings_ssl

The values for these global values must be as specified in Enterprise 11.

- The Loop command or the If command that use date conditions to compare dates in different formats encounters an error after migration. For example, a date with MM/dd/yyyy format does not work with a date with MM/dd/yyyy hh:mm:ss format.

Workaround: Update dates with the different format to the same format.

- A bot cannot use a variable or an object that contains data larger than 64 KB. For example, if you have captured a table from a website using the Object Cloning command and the captured object contains data larger than 64 KB. Bots containing such objects encounters an error after migration.

Workaround: Remove unwanted data or copy the data in a CSV or a text file and uses the **Read** action of the CSV/TXT package.

- Migration fails for action from which the Credential Vault value is missing in the Control Room.

Workaround: Create the Credential Vault value in the Automation 360 before migration and start the migration again using the Bot Migration Wizard.

Migrating bots with N/A status

The Bot Scanner reports shows the status of bots that contain unsupported commands and cannot be migrated as N/A. You can migrate such bots by modifying them in your Enterprise 11 or Enterprise 10 machine as specified in the following table:

Message	Migration of bots not yet supported due to child bots using unsupported commands.
Description	A child bot that uses a command that is currently unsupported for migration cannot be migrated. As a result, parent bots that use this child bot also cannot be migrated.
Action	To migrate these parent bots, remove references to the child bot from the parent bot and then migrate that parent bot. To view the unsupported commands used in the child bots, go to the list of bots that cannot be migrated and click the child bot name.

Message	Migration of "Object Cloning" with "HTML (Edge)" is not yet supported
Description	The Microsoft Edge Legacy browser is not supported in the Automation 360, so the migration of bots configured with this browser is not supported.
Action	Update the Enterprise 11 bots using other supported browsers such as Google Chrome, Firefox, Internet Explorer, or Microsoft Edge Chromium browser.

Message	Migration of MetaBot is not supported. The screen file does not exist. Please fix the bot and try again.
Description	MetaBot Logic refers to a screen that does not exist in the MetaBot.
Action	To migrate the MetaBot, either add the screen again or remove references to the non-existent screens.

Message	Migration of "Variable Operation" command where variable types do not match is not supported. Please fix the bot and try again.
----------------	---

Description	Enterprise 11 or Enterprise 10 bot uses the Variable Operation command where the variable types of the variables used are not the same.
Action	Update the Variable Operation command in the Enterprise 11 or Enterprise 10 bots to ensure that the referenced variables are of the same type.

Message	Migration of "Variable Operation" command where the variable does not exist is not supported. Please fix the bot and try again.
Description	Enterprise 11 or Enterprise 10 bot references a non-existent variable in the Variable Operation command.
Action	Either create a variable with the same name and type, or remove the command that references the non-existent variable.

Message	Migration of "If" command where the variable does not exist is not supported. Please fix the bot and try again.
Description	Enterprise 11 or Enterprise 10 bot references a non-existent variable in the If command.
Action	Either create a variable with the same name and type, or remove the command that references the non-existent variable.

Message	Migration of "ElseIf" command where the variable does not exist is not supported. Please fix the bot and try again.
Description	Enterprise 11 or Enterprise 10 bot references a non-existent variable in the Else If command.
Action	Either create a variable with the same name and type, or remove the command that references the non-existent variable.

Message	Migration of "Loop" command where the variable does not exist is not supported. Please fix the bot and try again.
Description	Enterprise 11 or Enterprise 10 bot references a non-existent variable in the Loop command.
Action	Either create a variable with the same name and type, or remove the command that references the non-existent variable.

Message	Migration of "Run Task" with bot path defined using "AAApplicationPath" not followed by valid repository folder path is not supported. Please fix the task bot path in the 11.x bot and migrate again.
----------------	--

Description	Enterprise 11 or Enterprise 10 bot uses an invalid path in the Run Task command of the child bot.
Action	To migrate this bot, modify the Enterprise 11 bot to ensure a valid child bot path is provided after AAAApplicationPath.

Message	Migration of "If - TaskSuccessful" with bot path defined using "AAAApplicationPath" not followed by valid repository folder path is not supported. Please fix the task bot path in the 11.x bot and migrate again.
Description	Enterprise 11 or Enterprise 10 bot uses an invalid path within the If > Task Successful condition of the child bot.
Action	Update the Enterprise 11 or Enterprise 10 bot to ensure a valid child bot path followed by a proper folder structure is provided after AAAApplicationPath.

Message	Migration of "If - TaskUnsuccessful" with bot path defined using "AAAApplicationPath" not followed by valid repository folder path is not supported. Please fix the task bot path in the 11.x bot and migrate again.
Description	Enterprise 11 or Enterprise 10 bot uses an invalid path within the If > Task Unsuccessful condition of the child bot.
Action	Update the Enterprise 11 or Enterprise 10 bot to ensure a valid child bot path followed by a proper folder structure is provided after AAAApplicationPath.

Message	Migration of "ElseIf - TaskSuccessful" with bot path defined using "AAAApplicationPath" not followed by valid repository folder path is not supported. Please fix the task bot path in the 11.x bot and migrate again.
Description	Enterprise 11 or Enterprise 10 bot uses an invalid path within the Else If > Task Successful condition of the child bot.
Action	Update the Enterprise 11 or Enterprise 10 bot to ensure a valid child bot path followed by a proper folder structure is provided after AAAApplicationPath.

Message	Migration of "ElseIf - TaskUnsuccessful" with bot path defined using "AAAApplicationPath" not followed by valid repository folder path is not supported. Please fix the task bot path in the 11.x bot and migrate again.
Description	Enterprise 11 or Enterprise 10 bot uses an invalid path within the Else If > Task Unsuccessful condition of the child bot.
Action	Update the Enterprise 11 or Enterprise 10 bot to ensure a valid child bot path followed by a proper folder structure is provided after AAAApplicationPath.

Message	Migration of "Variable Operation" command resetting system variable "\$WorkItemResult\$" will not be supported.
Description	Resetting the system variable \$WorkItemResult\$ is not supported for Variable Operation command.
Action	Use the String > Assign operation and assign an empty string to the \$WorkItemResult\$ system variable instead of resetting it.

Message	Migration of "Windows - Close All Open Windows" is not yet supported.
Description	If you have used the Close command with the All open windows option selected in a bot, you cannot migrate that bot.
Action	Update the Enterprise 11 or Enterprise 10 bot so that it does not use the All open windows option before you migrate it

Message	Migration of "If - ObjectProperties" with field "OObjectPlay_PropertyInfo_ReviewMessage" of type "String" is not yet supported.
Description	Enterprise 11 or Enterprise 10 bot uses an object in the If > Object Properties command that has one of the properties with size larger than 64 KB.
Action	To migrate this bot, you can perform one of the following actions: <ul style="list-style-type: none"> • Delete the property value that is larger than 64 KB in size, in the If > Object Properties command. • Store the property value which exceeds 64 KB into a text file. Then, create a variable which reads the value from this file. Assign this new variable to the corresponding property in the If > Object Properties command.

Message	Migration of "ElseIf - ObjectProperties" with field "OObjectPlay_PropertyInfo_ReviewMessage" of type "String" is not yet supported.
Description	Enterprise 11 or Enterprise 10 bot uses an object in the Else If > Object Properties command that has one of the properties with size larger than 64 KB.
Action	To migrate this bot, you can perform one of the following actions: <ul style="list-style-type: none"> • To migrate this bot, delete the property value that is larger than 64 KB in size, in the Else If > Object Properties command. • Store the property value which exceeds 64 KB into a text file. Then, create a variable which reads the value from this file. Assign this new variable to the corresponding property in the Else If > Object Properties command.

Message	Migration of "Loop.Condition - ObjectProperties" with field "OObjectPlay_PropertyInfo_ReviewMessage" of type "String" is not yet supported.
Description	Enterprise 11 or Enterprise 10 bot uses an object in the Loop while > Object Properties command that has one of the properties with size larger than 64 KB.
Action	To migrate this bot, you can perform one of the following actions: <ul style="list-style-type: none"> • To migrate this bot, delete the property value that is larger than 64 KB in size, in the Else If > Object Properties command. • Store the property value which exceeds 64 KB into a text file. Then, create a variable which reads the value from this file. Assign this new variable to the corresponding property in the Else If > Object Properties command.

Differences in Automation 360 and Enterprise 11/Enterprise 10 features

Review how some features and functionalities, such as folder structure, bot deployment, packages, variables, and MetaBots, are different in Automation 360 as compared with Enterprise 11 and Enterprise 10.

Folder structure

The folder structure in which bots (TaskBots and MetaBots) are stored in Automation 360 is different compared with Enterprise 11 and Enterprise 10.

Automation 360 folder structure

The bots (TaskBots and MetaBots) are available in the **Automation > Bots**. Bots that are migrated from Enterprise 11 or Enterprise 10 are available in the public workspace.

The following image shows the folder structure in Automation 360

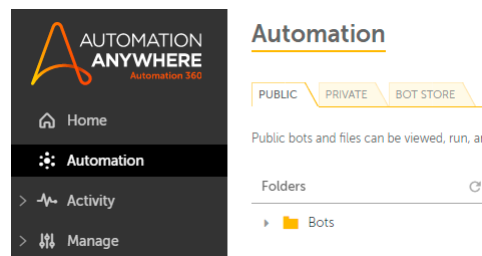

Enterprise 11 and Enterprise 10 folder structure

Bots (TaskBots only) are available in the **My Tasks** folder (**Automate > Tasks > My Tasks**) and MetaBots are available in the **My MetaBots** folder.

The following image shows the folder structure in Enterprise 11:

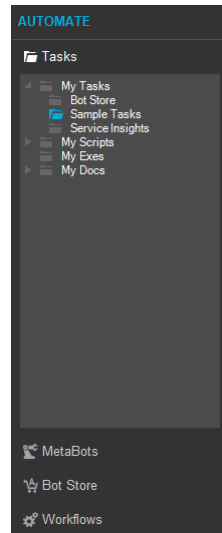

Bot deployment

- **Enterprise 11:** When a low-priority bot is running and a high-priority bot is deployed, the system pauses the low-priority bot and runs the high-priority bot. After the high-priority bot is run, the low-priority bot resumes.
- **Automation 360:** The priority of bots is verified at deployment. When bots are queued for a Bot Runner user, higher-priority bots are deployed before lower-priority bots. However, if a lower-priority bot is already running, the higher-priority bots are deployed only after the lower-priority bot completes running.

Packages

For most of the Enterprise 11 or Enterprise 10 commands, similar or equivalent actions and packages are available in Automation 360. However, the behavior of some of the Automation 360 commands is different compared with those in Enterprise 11 or Enterprise 10.

- Automation 360 is created afresh to support not only the current but also the future automation needs of modern enterprises. Accordingly, Automation 360 is built to meet important objectives, such as providing the following features:
 - A standardized, predictable, and scalable platform
 - Consistent user experience
 - Improved flexibility and security

With Automation 360, we aim to provide these features by employing industry-standard exception handling, rich support for dedicated data types, and so on.

Because Automation 360 is created afresh, some of the Enterprise 11 capabilities that have been redesigned in Automation 360 might not have a directly corresponding Automation 360 feature.

However, to ensure that the migrated bots produce output that is identical to that produced by their corresponding Enterprise 11 bots, we have mapped Enterprise 11 commands to their corresponding actions in Automation 360.

In instances where a direct mapping between an Enterprise 11 command and an Automation 360 action is unavailable, we have used "expressions" to ensure that the migrated bots produce output that is

identical to that produced by their corresponding Enterprise 11 bots, without requiring you to manually update the bots.

Note: The usage of expressions leads to more number of lines and additional variables in the migrated bots as compared to their corresponding Enterprise 11 bots.

For information about expressions, see [Legacy Automation package](#).

- For Enterprise 10/Enterprise 11 command using a windows title field configured with a user defined variable, the migration process migrates the bot by adding the **Set Title** action just above the respective command. Automation 360 does not allow user variables in the **Windows Title** field. Use the **Set Title** action to achieve the same behavior.
- In Enterprise 11, when a bot contains more than one command with the **resize window** option selected, the window is resized to the dimensions specified by the first command. In Automation 360, the window is resized each time the bot encounters an action with the **resize window** option selected. This ensures that at runtime the window dimensions of each action match the dimensions at which that action was configured, which enhances the bot's ability to find the object.
- In Enterprise 11 or Enterprise 10, loop indexing of table starts with 1 and increments by 1. Automation 360 starts indexing with 0 and increments by 1.
- The migration process migrates IF and Loop commands that contain multiple conditions of a variable.
- Disabled commands are migrated as follows based on the different coding patterns:
 - An individually disabled command (with or without any validation error) is migrated as a disabled action. All actions are disabled if one disabled command is migrated to multiple actions in Automation 360.
 - Disabled **Error Handling** command is migrated to disabled try and catch block including all other actions depending on its configuration.
 - Disabled **Loop** command is migrated to a disabled **Loop** action in Automation 360.
 - Disabled **If** command is migrated as a comment so that the migrated bot returns the same result as that returned by the corresponding Enterprise 10 or Enterprise 11 bot.
- In Enterprise 11 or Enterprise 10, some String operation commands use Tab, Enter, and Separator special characters. In Automation 360, these characters are system variables in the String package.

Enterprise 10/Enterprise 11	Automation 360
[Tab]	\$String:Tab\$
[Enter]	\$String:Enter\$
[Separator]	\$String:Separator\$

See [String package](#).

- Enterprise 11 or Enterprise 10 provides various presets as part of the windows title selection and they are migrated to respective presets in Automation 360.

Enterprise 10/Enterprise 11 Options	Automation 360 Options
Current Active Window	Current Active Window

Enterprise 10/Enterprise 11 Options	Automation 360 Options
Desktop	<ul style="list-style-type: none"> For the Insert mouse click command, use the Screen for window title option. For the Insert keystroke command, use the Current Active Window option. For Screen > Capture area, use the Screen for window title option. For the Capture Desktop command of the Screen Capture command, use the Capture area action of the Screen package with the Screen option selected from the list available in the Application tab.
Wallpaper	Desktop
Taskbar	Taskbar

Package mapping for migration

Variables

For most of the Enterprise 11 or Enterprise 10 user, system, and credential variables, similar or equivalent system variables are available in Automation 360. The behavior of some of the Enterprise 11 or Enterprise 10 variables is different compared with Automation 360.

- For each variable passed as input in Enterprise 11 or Enterprise 10 bot, a line is added in the migrated bot in Automation 360. For example, if you are passing 100 variable as input in Enterprise 11 bot, after migration that bot has 100 new lines.
- Enterprise 11 or Enterprise 10 allows you to specify a session name to open a file or establish a connection and use a variable in a loop command to use the same session. After migrating these bots to Automation 360, you must update the bot to use either a session name or variable to open a file and in a loop command.
- Enterprise 11 or Enterprise 10 commands that store the return values to the \$Clipboard\$ system variable are not supported in Automation 360. When you migrate bots with this functionality, the migration process assigns the values to a temporary variable and then assigns the value to the Automation 360 \$System:Clipboard\$ system variable by adding the **Copy To** action to the **Clipboard** package.
- Some commands return values to variables for further processing. In Enterprise 11 or Enterprise 10, users can store these values in different types of variables, where as in Automation 360, these values are stored in a specific type of variable only.

For example, if a command returns a value to an array for a specific cell, then in Automation 360, we store the value in a temporary string variable. Then in the next action, we store this temporary value to an actual array variable to ensure that the bot execution logic stays intact.

- In Automation 360, the single dollar sign (\$) is reserved for Automation Anywhere use, so all user entries of a single dollar sign are automatically replaced with two dollar signs (\$\$). For example, if you have a text field, "Pay \$5.00", we convert that field to read "Pay \$\$5.00" in Automation 360 for it to display properly to users.

- In Enterprise 11 or Enterprise 10, bots can use a variable to specify the child bot you want to run. In Automation 360, the task path is updated to the `Bots` folder. The following table provides a few examples:

Enterprise 11/ or Enterprise 10	Automation 360
D:\My Documents \AAE_V11\Automation Anywhere Files\Automation Anywhere\My Tasks\Migration\\${bot_name}\$	Bots\My Tasks\Migration\\${bot_name}\$
\$\$\$Applicationpath\$\Automation Anywhere\My Tasks\Migration\ \${bot_name}\$	Bots\My Tasks\Migration\\${bot_name}\$
D:\\${UserName}\My Documents \AAE_V11\Automation Anywhere Files\Automation Anywhere\My Tasks\Migration\\${bot_name}\$	Bots\My Tasks\Migration\\${bot_name}\$
D:\My Documents \AAE_V11\Automation Anywhere Files\Automation Anywhere\ \${bot_path}\\${bot_name}\$	Bots\My Tasks\\${bot_path}\ \${bot_name}\$

Variable mapping for migration

Variables support

MetaBots

MetaBots are not available in Automation 360. When you migrate Enterprise 11 or Enterprise 10 MetaBots, they are migrated to equivalent TaskBots in Automation 360. These TaskBots provide similar output and capabilities of the MetaBots.

The migration process migrates the DLLs and logic to equivalent bots. The **Run Logic** command is converted to the **Run** action of the Task Bot package. The DLLs in the MetaBots use the **Execute** command to run a function from that DLL. After migration to Automation 360, each **Execute** command is converted to **Open**, **Run function**, and **Close** actions of the **DLL** package. Information about which function to run from the DLL, which parameters to use, and other details in the **Execute** command is migrated to the **Run** action. MetaBots with DLLs that use credential variables of string, character, and Byte data type can be migrated to Automation 360.

Earlier to Automation 360 v.17, the dictionary variable was used to provide input parameters in a migrated bots which used to add additional steps in the bot. Starting from v.17, the Entrylist variable is used to provide input parameters in a migrated bot. This reduces the number of steps added to the migrated bot.

How MetaBots are migrated

Bot Scanner overview

The Bot Scanner analyzes bots (TaskBots and MetaBots) created in your Enterprise 10 or Enterprise 11 Control Room. The scanner generates a report summarizing the number of bots, commands, and variables that are ready for migration and those not yet supported for migration, and provides a recommendation on whether you are ready for migration.

You can also use the Bot Scanner to scan and identify bots that use Internet Explorer that can be converted to a supported browser. For more information, see [Scanning bots that use Internet Explorer](#).

Note: A new version of Bot Scanner is released with each Automation 360 release. Use the latest Bot Scanner version to monitor the commands and variables that are supported for migration in Automation 360 with each update. The scanner obtains information about the Automation Anywhere components used by customers and prioritizes support for these components for migration.

Considerations for using Bot Scanner

- Ensure that you are on the supported Enterprise 10 or Enterprise 11 Control Room version for migration before you scan your bots.

[Supported Control Room versions for migration](#)

- You do not have to install Automation 360 to run the Bot Scanner, but access to your Enterprise 10 or Enterprise 11 repository is a requirement.
- You must run the Bot Scanner before performing any migration steps.

How Bot Scanner works

The Bot Scanner reads the contents of your Enterprise 10 or Enterprise 11 and provides a summary report for your analysis. The scanner provides a recommendation on whether or not to migrate now and an estimated time of availability (ETA) on when unsupported commands will be supported in Automation 360.

Note: The Bot Scanner does not migrate bots or perform any other action. If you are not ready for migration, the Bot Scanner identifies the reasons why the bots cannot be migrated.

The bots (.atmx and .mbot files) are scanned at the location you specify and the summary report provides the following information:

- The number of bots scanned
- The number of bots that can and cannot be migrated to Automation 360
- The commands and variables that are used in the scanned bots and supported in Automation 360
- The commands that are migrated to Automation 360 with some modifications that have to be reviewed

Note: The Bot Scanner generates the summary report in HTML format and a separate report for each bot in XML format.

Bot Scanner reports

The Bot Scanner generates the following reports to help you decide whether you should start the migration.

Proceed with migration

This recommendation is provided when **95% or more than 95%** of your bots can be migrated. As the majority of your bots are ready for migration, you are eligible for migration. You might have to perform some work before or after migration to migrate some of the remaining bots.

Wait to migrate

This recommendation is provided when **less than 95%** of your bots can be migrated. In this case, you must run the latest version of the Bot Scanner available with next release of Automation 360, to assess your eligibility for migration.

Sharing Bot Scanner report to improve experience

You can help improve the experience of migration to Automation 360 by sharing the reports generated by the Bot Scanner. These reports help our engineering team focus on supporting the components that are more frequently used by our customers.

Important: We maintain the privacy of the shared reports. No personally identifiable information (PII) is included and you can review the reports before sharing. Contact your Customer Success Manager (CSM) or Partner Enablement Manager (PEM) for more details.

Scanning bots that use Internet Explorer

You can use Bot Scanner to scan Internet Explorer bots that have to be converted to a supported browser.

To help convert bots that use Internet Explorer, Bot Scanner scans all bots and identifies those that use Internet Explorer so that you do not have to identify them manually. The Bot Scanner then generates a report that provides details on the number of bots that can be converted and the number of bots that cannot be converted, along with review messages.

For more information, see [Analyze report for Internet Explorer bots](#) and [Internet Explorer conversion or scanning messages](#).

Scanning bots that use basic authentication

You can use Bot Scanner to scan bots that are using basic authentication in the Email package and Email trigger.

Bot Scanner scans all bots and identifies those that use basic authentication so that you do not have to identify them manually. The Bot Scanner then generates a report that provides details on the number of bots that can be updated, along with review messages.

For more information, see [Scan Automation 360 bots for Email action with Basic authentication usage](#) and [Basic authentication scanning messages](#).

Scan Enterprise 11 or 10 bots using Bot Scanner

Before you migrate to Automation 360, it is important to verify the migration readiness of your bots. Scan the bots using Bot Scanner and analyze the generated report for information about the commands and variables used in these bots and how many of these commands and variables are supported for migration.

Ensure you meet the system requirements for using the Bot Scanner:

- **Hardware requirements**

Processor	2.66 GHz or higher (64-bit)
RAM	2 GB or higher

Disc space	200 MB
-------------------	--------

- **Software requirements**

Operating systems: Windows 7 or later (32-bit and 64-bit)

You can also use the Bot Scanner to scan and identify bots that use Internet Explorer that can be converted to a supported browser.

1. Download the latest version of Bot Scanner from the Automation Anywhere Support site.
 - a) Navigate to the [A-People Downloads page \(Login required\)](#).
 - b) Click the Automation 360 v.xx <Build_number> link.
The xx in the link refers to the release number. For example, Automation 360 v.21.
 - c) Click the Installation Setup folder.
 - d) Click the AAE Bot Scanner zip file, and then click **Download** on the toolbar.

See the following video on how to download Bot Scanner: <https://fast.wistia.net/embed/iframe/8xyyvivhfz>

2. Extract the files from the zip file you have downloaded and double-click AAE_Bot_Scanner.exe.

Note: Ensure that you save the AAE_Bot_Scanner.exe file in a location path that does not contain a double-byte character. Otherwise, the Bot Scanner encounters an error when it is run.

You can use the Bot Scanner to scan bots that use Internet Explorer. The scanner generates a report that provides details on the number of bots that can be converted and the number of bots that cannot be converted to a supported browser.

3. From the **Automation Anywhere Bot Scanner** dialog box, select one of the following options:
 - Migration to Automation 360
 - Migration + Bots using Internet Explorer
 - Bots using Internet Explorer

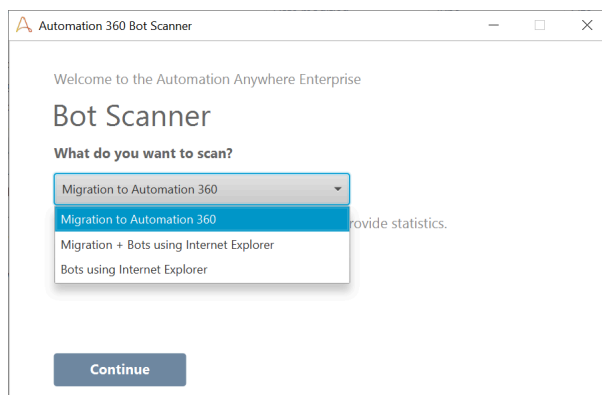

The second and third options provide Internet Explorer usage statistics that helps you to convert Internet Explorer bots to a supported browser.

4. In the **Automation Anywhere Bot Scanner** dialog box, enter the location of the folder that contains the bots that you want to analyze in the **Select repository path** field.

Important: You must create a copy of the Control Room repository and provide the location of the copied folder instead of the actual repository folder.

- a) Copy the Control Room repository.

For example, if the current location of the repository is `C:\ProgramData\AutomationAnywhere\Server Files\Default\Automation Anywhere`, you must copy the `Automation Anywhere` folder.

- b) Paste the copied repository at a temporary location. For example, `D:\My Bots` folder.

You must provide this location (`D:\My Bots`) in the **Select repository path** field in Step 3.

5. Enter the location where you want to save the generated report in the **Select destination folder** field.

Note: The Bot Scanner related files and folders in the destination folder are overwritten if you have specified the same location when you have used the Bot Scanner previously.

6. Enter a value in the **Timeout** field to specify the maximum time the Bot Scanner should take to analyze a bot.

If the scanning of a bot takes more than the value specified in the **Timeout** field, Bot Scanner stops scanning that bot and proceeds to scanning other bots in the repository.

7. In the **Generate output report for** option, select the options for which you need to generate the report.

Note: For repositories that are more than 10 GB in size, we recommend that you select only the **Bots** option for generating the report.

8. Click **Create report**.

The Bot Scanner starts analyzing the bots available in the repository.

The Bot Scanner displays an error if it scans a bot that is created using an unsupported version of Enterprise Client. You must upgrade the bot to a supported version of Enterprise Client and scan the bot again.

9. Optional: You can click **Stop scanning** when the Bot Scanner is analyzing the bots to cancel the operation.

The summary report and individual reports are available for the bots that were analyzed before the operation was canceled.

10. Click **Open report** to open the summary report in the default browser after the Bot Scanner has completed analyzing all the bots available in the repository.

See the following video on how to use the scanner to scan Enterprise 11 or 10 bots:

<https://fast.wistia.net/embed/iframe/6btqpo8ho7>

- For migration: [Analyze Bot Scanner report for migration](#)
- For IE EOL: [Analyze report for Internet Explorer bots](#)
- For Basic authentication EOL: [Scan Automation 360 bots for Email action with Basic authentication usage](#)

Related concepts

[Bot Scanner overview](#)

The Bot Scanner analyzes bots (TaskBots and MetaBots) created in your Enterprise 10 or Enterprise 11 Control Room. The scanner generates a report summarizing the number of bots, commands, and variables that are ready for migration and those not yet supported for migration, and provides a recommendation on whether you are ready for migration.

Related reference

[Analyze Bot Scanner report for migration](#)

You can analyze the report generated by the Bot Scanner to get information about the bots (TaskBots and MetaBots) and processes that can be migrated. Use the Bot Scanner to decide if you are ready to start migration now or prefer to wait until more commands are supported.

Analyze Bot Scanner report for migration

You can analyze the report generated by the Bot Scanner to get information about the bots (TaskBots and MetaBots) and processes that can be migrated. Use the Bot Scanner to decide if you are ready to start migration now or prefer to wait until more commands are supported.

The Bot Scanner report provides the following information:

- **Bots:** In the Bot Scanner report, a bot is an individual TaskBot (.atmx) or MetaBot (.mbot) that is used in other bots.

The **Bots** tab provides detailed information about bots that can be migrated, those that require action or review, and those that cannot be migrated.

- **Processes:** In the Bot Scanner report, a process is a bot that is not used in any other bots and can include one or more child bots.

The **Processes** tab provides detailed information about processes that can be migrated, those that require action or review, and those that cannot be migrated.

The Bot Scanner provides the following important information about the bots and processes:

- Number of bots and processes analyzed
- A high-level summary in the form of boards to indicate the migration status of bots and processes
- Number of bots and processes that you can and cannot migrate to Automation 360
- Commands that are used in the bots and the frequency of usage
- Reasons why bots and processes cannot be currently migrated and frequency of such occurrences
- Actions and reviews required by the users after migration due to change in the behavior of the commands
- Bots and processes that cannot be migrated and their corresponding error messages
- Number of lines in bots, and total number of lines of each bots associated with a process
- Line number for individual bots and processes that need review or action

Important: Automation 360 is updated frequently in order to achieve 100% functional equivalency with Enterprise 10 or Enterprise 11 versions. The percentage of bots, commands, and variables that are supported for migration in Automation 360 will increase until it reaches 100% over the next upcoming releases. That is, for every function you do in Enterprise 10 or Enterprise 11, an equivalent capability is in Automation 360.

Most of the Enterprise 10 or Enterprise 11 features are available as is; however, some features are implemented differently to support web (without a client) operations. For these features, you have to change the way bots are written.

The Bot Scanner is designed to scan bots (TaskBots and MetaBots) created using both Enterprise 10 and Enterprise 11 versions of Enterprise Client. The total file count includes the number of files that were skipped and not scanned.

The reports are available at the output location you specified in the **Select destination folder** field in the **Automation Anywhere Bot Scanner** dialog box. The Bot Scanner generates a summary report (`summary.html`) and a separate XML for each bot that it scanned. It creates a separate report for each logic available in a MetaBot.

A `raw-data` folder is created that contains the reports (in XML format) for each bot scanned. It helps our engineers to further analyze the migration process and take corrective actions, if required. No personally identifiable information (PII) is included in the summary report or the individual reports of the scanned bots.

If you choose to share the reports with us to help improve the product, compress the files in the `raw-data` folder and coordinate with your Customer Success Manager (CSM) or Partner Enablement Manager (PEM). No data is automatically shared with Automation Anywhere.

Summary report for all bots

The Bot Scanner utility provides an option to scan for either bots or processes, or bots and processes. Depending on what you choose, the summary report will contain information about the bots, processes, or bots and processes. Most of the sections seen in these summary reports will be the same except that in the bots and processes summary report you will also see an additional **All** tab that lists all the bots or processes that are flagged and sorted as **Action required**, **Review required**, **No review required**, and **Non Migratable**.

Note: For generating processes summary report, the maximum repository size that is supported is up to 10 GB.

The summary report provides information about the following:

- whether you can migrate to Automation 360
- the total number of bots scanned
- bots only report that provides information about the bots supported for migration to Automation 360 (in percentage)
- processes only report that provides information about the processes supported for migration to Automation 360
- bots and processes combined report that provides information about the bots and processes supported for migration to Automation 360

For example, consider the Bot Scanner has scanned 10 bots. Of the 10 bots, if 8 bots are ready for migration to Automation 360, then percentage of bots that can be migrated is 80% and the percentage of bots that cannot be migrated now is 20%.

Reviewing the Bot Scanner report for bots

Consider a scenario where you have scanned a total of 1618 bots, of which 98% (1614 bots) can be migrated to Automation 360. However, 5% of bots require action after migration, and 2% (4 bots) cannot be currently migrated due to certain reasons. In such a scenario, the Bot Scanner report enables you to perform the following actions:

- Identify the actions and reviews for the remaining 5% of bots so that you can successfully migrate a majority of your bots and run them in Automation 360 after migration.
- Identify bots that can be migrated to Automation 360 without any manual intervention.
- Identify the reason why 2% of bots cannot be currently migrated and the estimated time for when you can migrate them later. The reason might be due to commands and variables not yet supported in Automation 360.

Reviewing the Bot Scanner report for processes

To review a process message, perform these steps:

1. Click the **Processes** tab.
2. Click the messages tab that you want to review.
3. In the **Master Task Reference** column, click the expand icon (+) to view the process.
4. Click a process name to view the message.

Consider a scenario where you have a total of 100 processes, of which 99 processes can be migrated to Automation 360. However, 5 processes require action after migration, 10 processes require review after migration, and 1 processes cannot be currently migrated due to certain reasons. In such a scenario, the Bot Scanner report enables you to perform the following actions:

- Identify the actions and reviews for the remaining 15 processes so that you can successfully migrate a majority of your processes and use them in Automation 360 after migration.
- Identify processes that can be migrated to Automation 360 without any manual intervention.
- Identify the reason why that 1 process cannot be currently migrated and the estimated time for when you can migrate them later.

The reason might be due to commands and variables not yet supported in Automation 360.

The following image is a sample bot report from the Bot Scanner:

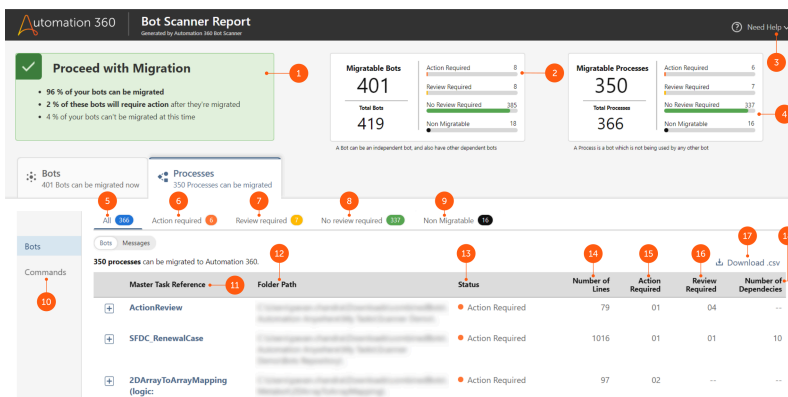

The following table describes the various fields in the sample Bot Scanner report (as numbered in the previous image):

Field/option	Description
1	<p>Provides a summary and status of the migration readiness of your bots. Review the status of migrated based on the following:</p> <ul style="list-style-type: none"> • Green: You can proceed with migration provided that you review the report for any action or review required for your bots. • Amber: You have to wait for migrating your bots as the percentage of bots that are qualified for migration do not meet the migration requirements.

Field/option	Description
2	<p>Provides a summary of the following information for bots:</p> <ul style="list-style-type: none"> • Migratable Bots: Provides a summary of the total number of bots that can be migrated. • Total Bots: Provides a summary of the total number of bots that were scanned. • Action Required: Provides a summary of the total number of bots that require action after migration to Automation 360. • Review Required: Provides a summary of the total number of bots that require review after migration to Automation 360. • No Review Required: Provides a summary of the total number of bots that can be migrated to Automation 360 without any manual intervention. • Non Migratable: Provides a summary of the total number of bots that cannot be currently migrated to Automation 360.
3	<p>Provides additional resources to ease the migration process.</p>
4	<p>Provides a summary of the following information for processes:</p> <ul style="list-style-type: none"> • Migratable Processes: Provides a summary of the total number of processes that can be migrated. • Total Processes: Provides a summary of the total number of processes that were scanned. • Action Required: Provides a summary of the total number of processes that require action after migration to Automation 360. Even if a child bot in a process requires action, the process is flagged as Action Required. <hr/> <p>Note: If a process contains bots where some of them require review and some others require action, then the process is flagged as Action Required. The Action Required status takes precedence over the Review Required status.</p> <hr/> <ul style="list-style-type: none"> • Review Required: Provides a summary of the total number of processes that require review after migration to Automation 360. Even if a child bot in a process requires review, the process is flagged as Review Required. • No Review Required: Provides a summary of the total number of processes that can be migrated to Automation 360 without any manual intervention. All the bots in the process can be migrated. • Non Migratable: Provides a summary of the total number of processes that cannot be currently migrated to Automation 360. All the bots in the process cannot migrated.

Field/option	Description
5	<ul style="list-style-type: none"> • Bots > All > Bots or Processes > All > Bots: Go to this view for a list of all the bots or processes that are flagged and sorted as Action required, Review required, No review required, and Non Migratable. • To view the message for a specific bot that require action or review, click the bot name. • To view the message for a specific process that require action or review, click the expand icon (+), and then click the task reference name. <p>Click the message code to view the information about changes in Automation 360 behavior for the command compared with the Enterprise 11 or Enterprise 10 behavior.</p> <hr/> <p>Note: Each message includes information you have to review after migration. For a list of these messages, see Review required messages. Use the message code (for example R102) to view the specific message quickly.</p>
6	<p>Bots > Action required > Bots or Processes > Action required > Bots: Go to this view for the list of bots or processes that require action after migration to Automation 360.</p> <ul style="list-style-type: none"> • To view the message for a specific bot that require action, click the bot name. • To view the message for a specific process that require action, click the expand icon (+), and then click the task reference name. <p>Click the message code to view the information about changes in Automation 360 behavior for the command compared with the Enterprise 11 or Enterprise 10 behavior.</p> <hr/> <p>Note: Each message includes information you have to review after migration. For a list of these messages, see Review required messages. Use the message code (for example R102) to view the specific message quickly.</p>
7	<ul style="list-style-type: none"> • Bots > Review required > Bots or Processes > Review required > Bots: Go this view for a list of the bots or processes that require review after migration to Automation 360. • To view the review required message for a specific bot, click the bot name. • To view the review required message for a specific process, click the expand icon (+), and then click the task reference name. <p>Click the message code to view the information about changes in Automation 360 behavior for the command compared with the Enterprise 11 or Enterprise 10 behavior.</p> <hr/> <p>Note: Each message includes information you have to review after migration. For a list of these messages, see Review required messages. Use the message code (for example R102) to view the specific message quickly.</p>
8	<p>Bots > No review required > Bots or Processes > No review required > Bots: Go to this view for a list of bots or processes that can be migrated to Automation 360 without any manual intervention.</p>

Field/option	Description
9	Bots > Non Migratable > Bots or Processes > Non Migratable > Bots: Go to this view for a list of bots or processes that cannot be currently migrated to Automation 360.
10	Bots > Commands : Go to this view for a list of the commands that can be migrated and the number of times the commands are used across all your scanned bots.
11	<ul style="list-style-type: none"> • Bot name: In the Bots tab, click a bot name to view the action required message of a specific bot, click the bot name. • Master Task Reference: In the Processes tab, to view the action required message of a specific process, click the expand icon (+), and then click a task reference name. <p>Click the message code to view the manual steps you must perform to run the migrated process successfully in Automation 360.</p> <p>You can also view the commands that the bot contains and the frequency or the number of times the command is used in the bot.</p> <hr/> <p>Note: Each message includes the cause and the action you have to perform after migration. For a list of these messages, see Action required messages. Use the message code (for example A101) to view a specific message quickly.</p>
12	Provides the location of the bot.
13	Provides the status of the bot or process.
14	<ul style="list-style-type: none"> • For bots, this field displays the number of lines used in a bot. This information will help you understand the complexity of the bot. • For processes, this field displays the sum of the total number of lines used in the parent and child bots within a process. This information will help you understand the complexity of the process.
15	<p>For processes, this field displays the number of bots in a process that requires action after migration to Automation 360.. Click the expand icon (+) and then click a task reference name that is flagged as Action Required.</p> <p>Click the message code to view the information about changes in Automation 360 behavior for the command compared with the Enterprise 11 or Enterprise 10 behavior.</p> <hr/> <p>Note: This field is available only for processes.</p>
16	<p>For processes, this field displays the number of bots in a process that requires review after migration to Automation 360. Click the expand icon (+) and then click a task reference name that is flagged as Review Required.</p> <p>Click the message code to view the information about changes in Automation 360 behavior for the command compared with the Enterprise 11 or Enterprise 10 behavior.</p> <hr/> <p>Note: This field is available only for processes.</p>

Field/option	Description
17	Download (as a CSV file) the list of bots, processes, or commands that can or cannot be migrated so that you can share the file with others.
18	<ul style="list-style-type: none"> For bots, this field displays the number of times a bot is used as a child bot. For processes, this field displays the sum of the total number of dependencies used in the parent and child bots within a process.

The report is valid until the next version of Bot Scanner is available. When the next version of Bot Scanner is available, a report expiry message is displayed. You must download the latest version of Bot Scanner and scan the bots again.

Verifications and actions required after migration

Some commands in the bots might be marked as review required in the Bot Scanner report. For these items, you need perform certain validation or update the bots after they are migrated.

The following Bot Scanner messages require verification or some actions:

- Child bot path is completely variablized and is resolved at runtime. Bot would fail upon execution if the path specified in the variable is not valid. Please review the migrate bot.

Ensure that the child bot is available at the location specified in the variablized path. If the path in the parent bot is not correct, update the path to point to the correct child bot.

- Value returned by system variable "Error Description" might be different w.r.t. legacy versions. Please review the migrated bot.

Description of some of the error messages in Automation 360 might be different than Enterprise 11 or Enterprise 10 for the same error. If an Enterprise 11 or Enterprise 10 bot is configured to take decisions based on the description of the error messages, you might have to update the migrated bot based on the new description of error messages.

- Migration of "Database - Connect" command is completed but additional configuration required for "Windows authentication". Please refer the database package documentation for more details.

Complete the steps specified to connect to a Microsoft SQL Server with Windows authentication. See [Connect to Microsoft SQL Server with Windows authentication](#).

- Migration of "IF" with variable condition is completed. However, could not determine the date format of the user variable, hence migrated with default date format mm/dd/yyyy HH:mm:ss. Please review and change the format if required.

Update the date format in the migrated bot to the same format used in Enterprise 11 for that bot.

- Could not determine if a variable used as position is index or column name. Index position starts from 0 instead of 1 hence take necessary actions if needed.

If you have used the FileData Column[\$variable\$] or Excel Column[\$variable\$] system variables in the Enterprise 11 or Enterprise 10 bot, we assume that you have used the column name in the \$variable\$. In such cases, the migrated bot contains the FileData Column{\$variable\$} expression. If the \$variable\$ in the Enterprise 11 or Enterprise 10 bot contains the column number, you must update the expression in the migrated bot to FileDataColumn[\$var.String:toNumber()\$].

- The Run Logic command that uses credential variables as input for a logic of a MetaBot

Bots that use the **Run Logic** command that passes Credential Vault attributes from a TaskBot to a MetaBot logic can be migrated to Automation 360. The credential name and attribute name are displayed in the fields in the corresponding line of the migrated bot.

If you have migrated using the restored Enterprise 11 database, an equivalent locker is created in Automation 360 for the credential variables used in the Enterprise 11 bot.

Choose one of the following options to run the migrated bots successfully:

- **Option 1:** Pass the credential type variables.
 1. Create a credential type variable in the child bots as input variables.
 2. In the **Run** action of the Task Bot package of the parent bot, update the input value fields to use the Credential Vault attributes for the credential type variable created for the child bot (corresponding to MetaBot logic).
- **Option 2:** Pass the credential values as a global value.
 1. Create the Global value in Automation 360 for the credentials use in the **Run Logic** command in Enterprise 11.
 2. In the **Run** action of the Task Bot package of the parent bot, update the Input value fields to use the Global values for the credential type variable created for the child bot (corresponding to MetaBot logic).

If you have not used the restored Enterprise 11 database when installing Automation 360, you must first create the required locker for the credential variables used in the Enterprise 11 bot, before performing the preceding steps.

Note: Automation 360 provides enhanced security by allowing you to assign Credential Vault attributes only to the credential type variables. This restricts any nonsecure handling of Credential Vault attributes where they might have been assigned to non-credential type variables.

Report for an individual bot

The report for each bot provides information about its dependencies, variables, and commands used.

The individual bot report looks similar to the following code:

```
<analysis version="1.3.0">
  <stat>
    <dependencies ucount="0" count="0"/>
    <errors ucount="6" count="12">
      <error count="1">System variable $AAApplicationPath
$</error>
      <error count="1">Command [If FolderNotExist]
is not supported</error>
      <error count="3">System variable $CurrentDirectory
$</error>
      <error count="3">System variable $Extension$</error>
    </errors>
  </stat>
</commands>
```

```

line="1"      <command target-action="assign" name="VariableOperation"
              grp="VariableOperation" api="VarOpe">
              <msg type="error" review="true"
category="variable">System
              variable $AAApplicationPath$</msg>
              <msg type="info" review="false"
category="default">Command
              parameter [Option] of type [String] is not
required.</msg>
              </command>
              <command target-action="createFolder"
name="createFolder" line="3"
              grp="FilesFolders" api="CreateFolder"/>
              <command target-action="copyFiles" name="CopyFiles"
line="5"
              grp="FilesFolders" api="CreateFolder"/>
              <command target-action="connect" name="Connect"
line="3"
              grp="Database" api="Connect"/>
              <command target-action="OpenCSVTXT" name="ReadFrom"
line="9"
              grp="CsvText" api="Csv"
              <msg type="info" review="false"
category="command">Line
              in 11.x client, there is no separate option given
for CSV
              and TEXT in Automation 360</msg>
              <msg type="error" review="true"
category="variable">System
              variable $CurrentDirectory$</msg>
              <msg type="error" review="true"
category="variable">System
              variable $Extension$</msg>
              <msg type="error" review="true"
category="variable">System
              variable $FileName$</msg>
              </command>
              </commands>
              <variables>
              <variable name="$CSV-TXT-Default-DATA$"
              type="TABLE" value-type=""/>
              </variables>
</analysis>

```

The following table describes the various attributes available in the XML report shown in the previous image:

Node	Attribute	Description
Stat	--	Provides information about the number of dependencies, error, and warnings.
--	dependencies	Specifies the number of dependencies for the bot. The <code>ucount</code> indicates the number of unique dependencies and the <code>count</code> indicates the total number of dependencies.
--	error	Specifies the number of errors for the bot. The <code>ucount</code> indicates the number of unique errors and the <code>count</code> indicates the total number of errors.

Node	Attribute	Description
Command	--	Provides information about the various commands and actions used in the bot.
--	command target- action	Specifies the action being performed for the command.
--	name	Specifies the name of the command.
--	line	Specifies the line number where the command is available in the bot.
--	grp	Specifies the command group the command belongs to.
--	api	Specifies the name of the API the command uses.
--	msg type	Provides information about the message type. The <code>error</code> type indicates that the command cannot be migrated to Automation 360, and an <code>info</code> type indicates that the command can be migrated but some of its attributes will be changed during migration.
--	review	Provides information about whether the command has to be reviewed. This attribute is always true for <code>error</code> type messages, which indicates that migration of that command to Automation 360 is not yet supported. For <code>info</code> type messages, if the attribute is true, you must review the value in the <code>category</code> attribute. You can decide whether you want to take any action on the migrated bot based on the value available in the <code>category</code> attribute.
--	category	Provides information about the command or variable for which the message is displayed.
Variables		Provides information about the system variables used by the bot.
--	variable name	Specifies the name of the variable.
--	type	Specifies the type of variable.
--	value type	Specifies the type of value provided for that variable.

See the following video on how to analyze the scanner report

<https://fast.wistia.net/embed/iframe/wx7yephsa6>

Get migration license

Migration is offered for free. To migrate to an Automation 360 environment (Cloud or On-Premises), you must request a migration license.

License terms and duration

- If your migration is taking longer than expected to complete, contact your Customer Success Manager or Account Representative to discuss extensions.

- Your Automation 360 migration license is transitional, which means it will overlap with your Enterprise 10 or Enterprise 11 license during the migration period.

After you have completed your migration, your Automation 360 products and licenses will transfer over to the 1-to-1 equivalents of your current contract. You should review your automation requirements or renewal dates and determine if any updates in licensing are necessary.

Note: Run the Bot Scanner and determine when to migrate first. We recommend that you request a migration license only after you have run the Bot Scanner and have reviewed the prerequisites for your deployment choice.

Requesting your migration license

When you are ready to begin migration, contact your Account Representative, submit your Bot Scanner report, and specify if you are requesting licenses for an Automation 360 Cloud or On-Premises deployment.

- To get started with Automation 360 (Cloud or On-Premises), you will be required to accept the in-product user terms.
- Because Automation Anywhere will be hosting customer data, customers migrating to Automation 360 Cloud must also agree to the Cloud Automation Agreement.

For Cloud migration, keep in mind the following:

- You must request the equivalent number of licenses for Control Room and other entitlements such as Bot Creators, Bot Runners, IQ Bot, and Bot Insight.

Migration fails if the number of Automation 360 licenses is not equivalent to the number of Control Room and other entitlements available in your Enterprise 11 environment.

Ensure that the number of Automation 360 licenses is equal to the number of Control Room and other entitlements available in your environment.

Otherwise, non-migrated user accounts will require further action after migration.

- You must request for the license when you are ready to begin migration because the migration code is valid for 30 days.

If you are not ready to begin migration and you get the migration license (along with the migration code), the 30-day validity of the code might expire by the time you begin migration or you might not have sufficient time to complete the migration.

Activating the license

- **Automation 360 Cloud:** You will be provided with a migration code that includes your migration license. Paste this code into the Cloud Migration Utility, and then run the utility to activate your license.
- **Automation 360 On-Premises:** When you complete your Automation 360 installation, upload your GUID when you open the Automation 360 Control Room. If you do not have a license GUID, then upload the current license file.

Prepare new Control Room for migration

Perform the tasks in this workflow to prepare your Automation 360 environment for migration.

Ensure that you have completed all the tasks to check your readiness for migration: [Check migration readiness](#).



1. *Choose a deployment model (Cloud, Cloud-enabled, or On-Premises).*
2. *Request and activate your migration license.*
3. Based on the deployment model you have selected, prepare your environment for migration:

Deployment model	Actions
Cloud	<ul style="list-style-type: none"> • Migrate using the Cloud Migration Utility: <i>Prepare for Enterprise 11 to Automation 360 Cloud migration</i> • Use both Automation 360 Cloud and Enterprise 11 in parallel: <i>Prepare for migration when using Enterprise 11 and Automation 360 Cloud in parallel</i> • Manually migrate to Cloud: <i>Prepare to manually migrate to Automation 360 Cloud</i>
Cloud-enabled	<ul style="list-style-type: none"> • <i>Prepare for Enterprise 11 to Automation 360 Cloud-enabled migration</i>
On-Premises	<ul style="list-style-type: none"> • Enterprise 11 to Automation 360: <ul style="list-style-type: none"> • <i>Prepare for Enterprise 11 to Automation 360 On-Premises migration</i> • Use both Automation 360 On-Premises and Enterprise 11 in parallel: <i>Prepare for migration when using Enterprise 11 and Automation 360 On-Premises in parallel</i> • Enterprise 10 to Automation 360: <ul style="list-style-type: none"> • <i>Prepare for Enterprise 10 to Automation 360 On-Premises migration</i> • Use both Automation 360 On-Premises and Enterprise 10 in parallel: <i>Prepare for migration when using Enterprise 10 and Automation 360 On-Premises in parallel</i>

4. *Complete the pre-migration tasks.*

Migrate and validate bots

Choose deployment model

The Automation 360 platform is developed on a cloud-native architecture with a single codebase that supports both Cloud and On-Premises deployments. The experience of all the components is the same whether the platform is deployed on Cloud or On-Premises on your own infrastructure, which can be physical servers, your private Cloud, or a public Cloud.

Note: Migration is available in Automation 360 starting from Build 2079 for On-Premises and from Build 7554 for Cloud deployments.

Deployment models

Automation 360 provides the following deployment models:

Cloud

Automation 360 Cloud is hosted by Automation Anywhere, providing an easy consumption model of the Automation 360 platform built on a cloud-native architecture. With the Automation 360 Cloud service, the Automation 360 platform, which includes the Automation 360 Control Room and applications (RPA Workspace, IQ Bot, Bot Insight, AARI, and Discovery Bot), is hosted by Automation Anywhere and accessed by users through a web browser. The Bot Agent devices where the bots run and execute the automations remain on the customer's infrastructure and securely connect to the Automation 360 Cloud service through HTTPS.

Cloud-enabled

In this deployment model, data is hosted On-Premises. This model is suitable for customers who have to adhere to strict regulatory norms where data sovereignty is mandatory.

On-Premises with packages updates through Cloud

With Automation Anywhere On-Premises with packages updates through Cloud service, all business, personal, and operational data is kept on and deployed from the server on-premises on the customer network.

The following image shows the deployment models for Automation 360:

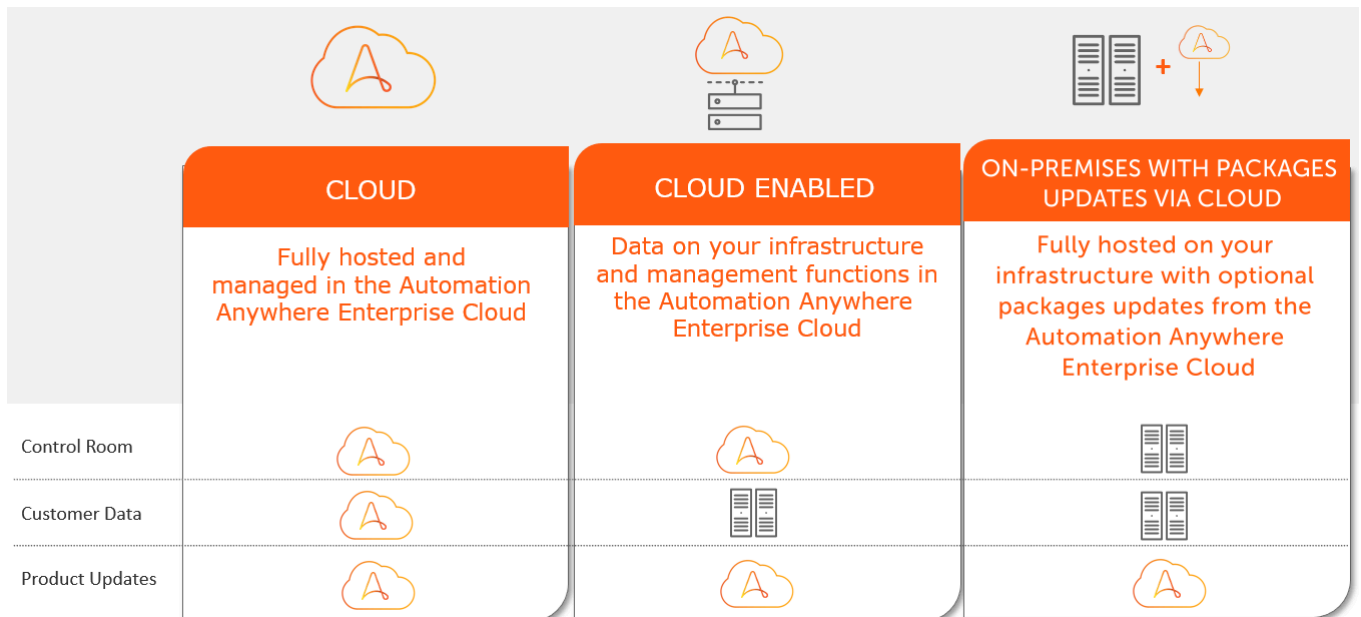

See also [Cloud operational responsibilities](#).

Environment considerations:

- Irrespective of the deployment model you choose, we recommend that you set up your first Automation 360 instance as a development (Dev) environment.

- We recommend that you have three separate environments for Bot Lifecycle Management: development (Dev), testing (Test or UAT), and production (Prod).
 - Setting up a Dev environment during the migration process provides two advantages:
 - A platform to test the migrated Enterprise 11 or Enterprise 10 bots to ensure that they run successfully and provides expected outcomes.
 - Access for your developers to the new Automation 360 environment to build new automation simultaneously when migrated bots are being tested.
-

Getting ready for Cloud

When you choose an Automation Anywhere Cloud deployment, there is no additional physical server infrastructure to set up for the Control Room. After you have completed your upgrade, you will benefit from automatic updates across your organization and scale easily in the Cloud. As you get started with Automation 360 on Automation Anywhere Cloud, ensure the system and compatibility requirements for running Automation 360:

- *Bot Agent compatibility requirements*: Bot Agent must be installed on registered devices so users can build and run bots on them.

Getting ready for Automation 360 Cloud-enabled

When you choose the Cloud-enabled deployment, two instances of Control Room are required: one deployed on Automation Anywhere Cloud and another installed on your own infrastructure. The Control Room deployed on Cloud manages the operational services and the Control Room installed on your infrastructure manages your business and operational data.

- *Bot Agent compatibility requirements*: Bot Agent must be installed on registered devices so users can build and run bots on them.
- *System requirements*: Hardware and data center requirements, including server, database, ports, protocols, and more.

Getting ready for On-Premises (customer's infrastructure)

Install and maintain Automation 360 on your own infrastructure. After you have completed your upgrade, you will benefit from regular updates for packages with new release builds made available to download and install. Ensure you meet the system and setup requirements for Automation 360 On-Premises:

- *Bot Agent compatibility requirements*: Bot Agent must be installed on registered devices so users can build and run bots on them.
- *System requirements*: Hardware and data center requirements, including server, database, ports, protocols, and more.

Prepare for Enterprise 11 to Automation 360 Cloud migration

Perform the tasks in this workflow to migrate from Enterprise 11 to Automation 360 Cloud, including migrating your bots.

Workflow map: You can also view this migration workflow in an interactive visual format by clicking the



following schematic image:

1. [Migrating from Enterprise 11 to Automation 360 Cloud](#)

1. Ensure that you have completed the following tasks to check your readiness for migration

[Check migration readiness](#)

2. Ensure you have procured and activated your migration license.

[Get migration license](#)

For information about managing and processing licenses and Cloud services , see [Manage and allocate licenses \(partners\)](#).

Important:

- Migration is performed to a new Cloud Control Room, which will be provisioned during the migration. You cannot reuse an existing Cloud Control Room for the migration.
- Logs and Bot Insight dashboard data are excluded from the upload to the new Cloud Control Room.
- Migrating data from standard Microsoft SQL database deployments is supported. See [Supported Control Room versions for migration](#).
- If Enterprise 11 is configured to use Active Directory or single sign-on (SSO), the authentication type for all migrated users in Automation 360 Cloud is changed to database. The password for all the migrated users is set to null except for the principal administrator.
Login credentials for the principal administrator is shared through email. The principal administrator can change the authentication type for users to SSO before migrating bots.
- **Recommended:** Create a backup of your data that is not migrated to Automation 360 Cloud such as audit logs and system logs before you decommission your Enterprise 11 instances.

For IQ Bot migration, see [Migrate from Automation 360 IQ Bot On-Premises to Cloud](#).

1. Ensure that all the credential variables used in the Enterprise 11 bots are available in the Enterprise 11 Control Room.
2. Download and install the Cloud Migration Utility.
[Install Cloud Migration Utility](#)
3. Use the utility to upload Enterprise 11 data to Automation Anywhere Cloud.
[Upload Enterprise 11 data using Cloud Migration Utility](#)

[Prerequisite tasks for migrating bots](#)

Recommended workflow for Cloud migration

Review the process of how Enterprise 11 data is migrated to Automation 360 Cloud, particularly when you maintain separate development, testing, and production environments.

Important: This is the recommended workflow for migrating from Enterprise 11 to Automation 360 Cloud.

In some scenarios, there might be a separate Enterprise 11 environments for development (Dev), testing (UAT), and production (Prod) based on the requirements and each of these environments might have multiple Control Room instances. The number of Cloud Control Room licenses you request must be the same as the total number of Control Room instances in all of your Enterprise 11 environments. For example, if you have separate environments for Dev, UAT, and Prod, and each of these environments has two Control Room instances, you must request six Cloud Control Room licenses.

When you migrate from Enterprise 11 to Automation 360 Cloud, you must copy all the bots from the production and testing environments to the development environment using Bot Lifecycle Management. This ensures that all new or modified bots available in the production and testing environments are available in the development environment before you start the migration process.

The following image shows the Enterprise 11 to Automation 360 Cloud migration workflow:

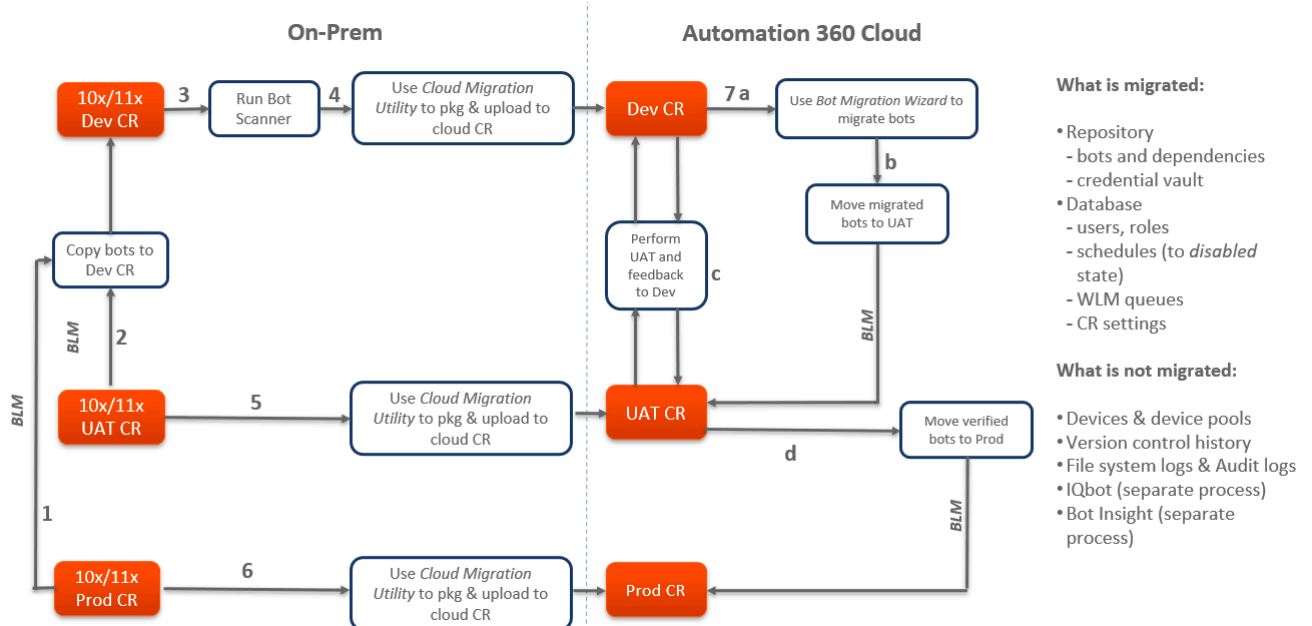

1. Optional: Copy bots from the Enterprise 11 Prod environment to the Dev environment using Bot Lifecycle Management.

[Bot Lifecycle Management - an overview](#)

2. Optional: Copy bots from the Enterprise 11 UAT environment to the Dev environment using Bot Lifecycle Management.

[Bot Lifecycle Management - an overview](#)

3. Analyze your bots and identify commands and variables used in the bots that are supported for migration to Automation 360.

[Scan Enterprise 11 or 10 bots using Bot Scanner](#) | [Analyze Bot Scanner report for migration](#)

4. Upload Enterprise 11 data to Dev Cloud Control Room using the Cloud Migration Utility.

[Install Cloud Migration Utility](#) | [Upload Enterprise 11 data using Cloud Migration Utility](#)

5. Upload Enterprise 11 data to UAT Cloud Control Room using the Cloud Migration Utility.
6. Upload Enterprise 11 data to Prod Cloud Control Room using the Cloud Migration Utility.
7. Complete the following steps on Automation 360 Cloud Dev environment:
 - a. Convert the bots (TaskBots and MetaBots) in `.atmx` and `.mbot` format to the `.bot` Automation 360 format using the Bot Migration Wizard.
 - b. Copy the converted bots to the Automation 360 Cloud UAT environment using Bot Lifecycle Management.

Bot Lifecycle Management
 - c. Test the converted bots in the Automation 360 Cloud UAT environment.

If any of the migrated bots are not working as expected and require some modification, move such bots to the Automation 360 Cloud Dev environment.

After the bots are modified, move them to Automation 360 Cloud UAT environment for testing. Repeat this process until all of the migrated bots work as expected.
 - d. After all the converted bots are tested and work as expected, copy these bots to the Automation 360 Cloud Prod environment.

Install Cloud Migration Utility

The Cloud Migration Utility enables you to upload all your Enterprise 11 data to Automation Anywhere Cloud. After the data is successfully uploaded to Cloud, the Cloud Control Room is created and all the uploaded data is available for use in that Control Room.

The utility migrates data from Control Room repository (bots, their dependencies, and Credential Vault) and Control Room database (users, roles, schedules, queues, and Control Room settings).

Note: Migration of Enterprise 11 Control Room data, such as users, roles and credentials, to Automation 360 Cloud on Google Cloud Platform is not supported.

Consider the following recommendations:

- Ensure that you install the Cloud Migration Utility on the same application server where the Enterprise 11 Control Room is installed. For Enterprise 11, also ensure that the utility is installed on the same database where the Bot Insight database is hosted.
 - If you installed Enterprise 11 in cluster mode, install the migration utility on one of the nodes of the cluster.
1. Download the latest version of the Cloud Migration Utility from the Automation Anywhere support site: [A-People Downloads page \(Login required\)](#).
 - a) In the Automation Anywhere Automation 360 section, click the **Automation Anywhere Enterprise Cloud Migration Utility** link.
 - b) Download the `.zip` file.
 2. Extract the `.zip` file and run the `AAE Cloud Migration Utility.exe` file as administrator.
 3. On the **Requirement** screen, click **Install**.

The screen lists the applications that are required to install the utility on the machine. The utility installs the required applications; no separate installation is required.
 4. On the **Welcome** screen, click **Next**.
 5. On the **License Agreement** screen, read and accept the license, and click **Next**.

6. On the **Destination Folder** screen, click **Change** if you want to change the location where you want to install the utility, and click **Next**.
7. On the **Ready to Install the Program** screen, click **Install**.
The **Installing AAE Cloud Migration Utility** screen displays the progress of the installation.
8. On the **Completed** screen, click **Finish**.

For Enterprise 11, [Upload Enterprise 11 data using Cloud Migration Utility](#)

Prerequisites for Cloud migration

After you have installed the Cloud migration utility, you must perform certain tasks before you start uploading data to Automation 360.

Complete the following requirements before you run the Cloud Migration Utility to upload data to Automation 360 Cloud:

- **Cloud Migration Utility**

- [Install the Cloud Migration Utility](#)
- You can migrate only one Control Room at a time. So when you connect to the Control Room, ensure that the installation path, the repository path, and the database details belong to the same Control Room before you run the Cloud Migration Utility.

- **Migration code:** Ensure you have received an email that contains a migration code. Contact your sales representative to receive the code.

The migration code is valid for one Control Room only. If you have multiple Control Room instances, you will receive an equivalent number of migration codes. Ensure that you use the correct migration code for the migration of a specific Control Room.

Important: The migration code you receive through email is valid for 30 days from the date it is generated and shared with you. So start the migration before the code expires. Otherwise, you will have to request a new code, which might take a significant amount of time.

- **Automation Anywhere Cloud customer tenant:**

- The tenant name does not support the underscore (_) character. So an underscore is used in the tenant name, the specified URL will not be created.

- **Port, firewall, internet connection**

- The port that is used to connect to the Enterprise 11 Control Room database must be open and available for the utility.
- The firewall must be configured to allow the utility to connect to the following for outbound HTTPS traffic over the port 443:
 - <https://aa-provsvc.globalservices.automationanywhere.digital/>
 - <https://aws.amazon.com>
- Ensure a stable internet connection with sufficient bandwidth to upload the data within 60 minutes. If the upload time exceeds 60 minutes, the Cloud Migration Utility will timeout and you need to start the upload process again.

- **Enterprise 11 Control Room**

- We recommend that you plan for some downtime for the Enterprise 11 Control Room or stop all user activities when you use the migration utility.

The downtime is required to ensure that no data is missed when the Cloud Migration Utility is packaging Enterprise 11 data for upload. If downtime is not possible, ensure no user activities are

performed on the Enterprise 11 Control Room for the time period when the Cloud Migration Utility is uploading data.

- **Control Room:** Ensure that the size of the Enterprise 11 repository is less than 20 GB and the Enterprise 11 database is less than 9 GB.

If the size of the repository or database is more than these sizes, contact Automation Anywhere support for assistance.

- Ensure that the credentials you have used to connect with the Enterprise 11 database has db_owner permission.
- Ensure that the Enterprise 11 repository and database you specify in the Cloud Migration Utility belong to the same Enterprise 11 Control Room.
- **Log files:** Grant access to the `C:\ProgramData\AutomationAnywhere` folder for the migration utility to store the log files.
- **Credential Vault:** Ensure that the Credential Vault mode is set to express mode.
 - This mode ensures that the credentials and variables available within the Enterprise 11 Credential Vault are migrated to the Cloud Control Room.
 - If the Credential Vault mode is set to manual mode in Enterprise 11, the credentials and variables in the Enterprise 11 Credential Vault are not migrated to the Cloud Control Room.

You can change the mode back to manual after the Control Room data is migrated. See [Configure Credential Vault Connection mode](#).

- **SSO:** If you want to integrate SSO after migrating to Automation 360 Cloud, ensure that the IDs of users in the Enterprise 11 Control Room exactly match the IDs in the SSO database. SSO integration will fail for IDs that do not match.

Related concepts

[Get migration license](#)

Migration is offered for free. To migrate to an Automation 360 environment (Cloud or On-Premises), you must request a migration license.

Upload Enterprise 11 data using Cloud Migration Utility

Use the Cloud Migration Utility to gather Enterprise 11 data and upload it to Automation Anywhere Cloud.

Ensure you have completed all the prerequisites before you start uploading data to Automation 360. See [Prerequisites for Cloud migration](#).

Recommendation: Stop the Automation Anywhere Control Room Reverse Proxy service.

If Enterprise 11 is installed in a cluster setup, you must stop the Automation Anywhere Control Room Reverse Proxy service on all the nodes in the cluster.

1. Run the Cloud Migration Utility as administrator.
2. Select the **Connect to the internet via proxy** option if you want to connect to the internet using a proxy server, and then click **Get started**.
 - a) Specify the hostname or IP address of the proxy server in the **Proxy hostname/IP address** field.
 - b) Specify the port you want to use to connect to the proxy server in the **Port** field.
 - c) Select the **Authentication** option if the proxy server requires authentication.
 - d) Specify the credentials you want to use for authentication in the **Username** and **Password** fields.

3. On the **Connect to Control Room** screen, enter the following details about the Enterprise 11 environment.

Important: These fields are automatically populated with the required values from the Enterprise 11 environment when the Cloud migration utility is run on the same application server where the Enterprise 11 Control Room is installed.

As you can migrate only one Control Room at a time, ensure that the installation path, the repository path, and the database details belong to the same Control Room.

Field	Value
Installation Path	Location where the Control Room is installed. The Installation path value is auto-populated to ensure that the details match with the Control Room database. Note: Network path is not supported as an Installation Path value.
Repository Path	Location where the Control Room repository is stored. The Repository Path value is automatically populated and cannot be edited. This is to ensure that the details match those in the Control Room database.
IP address/Hostname	IP address or hostname of the database server.
Port	Port that is used to connect to the database server.
Database Name	Name of the Control Room database that you want to upload.
Secure Connection	Option to use a secure connection to connect with the database.

Field	Value
Authentication	<p>Authentication method that you want to use:</p> <ul style="list-style-type: none"> • Windows authentication: Select this option to use Windows authentication for establishing a connection with the database server. <hr/> <p>Note: The user who is logged in to the Enterprise 11 server and is running the Cloud migration utility must be a Windows user administrator with db_owner permission to the Enterprise 11 database.</p> <hr/> <ul style="list-style-type: none"> • SQL authentication: Select this option to use database credentials for authentication when establishing a connection with the database server. <p>If you select this option, provide the credentials you want to use to connect to the database server in the Username and Password fields.</p>
Backup Path	Location where you want to store backup of the Enterprise 11 Control Room data.

4. Click **Next**.
5. On the **Summary** screen, review the information and click **Next**.
6. On the **Validate migration code** screen, enter the migration code you received through email and click **Validate**.
The system validates the migration code you have entered.
7. Click **Next**.
The system extracts the Enterprise 11 data and starts transferring data to Automation Anywhere Cloud.
8. Click **Exit**.
After the data is successfully uploaded, you will receive an email with a link and login credentials to access the Control Room.

See the following video on how to upload Enterprise 11 data using the Cloud Migration Utility:

<https://fast.wistia.net/embed/iframe/gnvwudhdir>

See the following video on how to verify the Enterprise 11 data in the Cloud Control Room:

<https://fast.wistia.net/embed/iframe/6ri2nq4tr2>

Migrate Enterprise bots

Prepare for migration when using Enterprise 11 and Automation 360 Cloud in parallel

Perform the tasks in this workflow if you want to use both Automation 360 Cloud and Enterprise 11 in parallel. You can continue to use both environments till the time you are ready to start the migration from Enterprise 11 to Automation 360 Cloud.

1. Ensure that you have completed the following tasks to check your readiness for migration

Check migration readiness.

2. Ensure you have procured and activated your migration license.

Get migration license

Important:

- Migration is performed to a new Cloud Control Room, which will be provisioned during the migration. You cannot reuse an existing Cloud Control Room for the migration.
- You cannot use the Cloud Migration Utility to upload your data to the Cloud Control Room if you have selected the standard Automation 360 Cloud SKUs when you signed the order form.

If you want to use the Cloud Migration Utility, you must have selected the Automation 360 Cloud migration SKUs when you signed the order form.

-
1. Ensure that all the credential variables used in the Enterprise 11 bots are available in the Enterprise 11 Control Room.
 2. Download and install the Cloud migration utility.
Install Cloud Migration Utility
 3. Use the Cloud migration utility to upload Enterprise 11 data to Automation Anywhere Cloud.
Upload Enterprise 11 data using Cloud Migration Utility
 4. Continue using both Enterprise 11 and Automation 360 environments in parallel.

Recommendation: Create all new bots and entities such as users, roles, and schedules in Automation 360.

-
5. If you create any new entity such as users, roles, or schedules (except bots) in Enterprise 11 after installing Automation 360, create the same entity in Automation 360.
 6. When you are ready to use only Automation 360 as your production environment:
 - a) If you have created new bots in Enterprise 11 data is uploaded in Automation 360 Cloud:
 1. Export all the bots and their dependencies that were created after data was uploaded in Automation 360 Cloud using Bot Lifecycle Management.
Export bots
 2. Import all the bots to Automation 360 using Bot Lifecycle Management.
Import bots

Note: After migration, if you add any new Bot Insight data or dashboard or modify any existing data in Enterprise 11, these changes are currently not imported to Automation 360 and therefore will not be migrated.

Prerequisite tasks for migrating bots

Prepare to manually migrate to Automation 360 Cloud

You can manually migrate from Enterprise 11 or Enterprise 10 to Automation 360 Cloud (without using the Cloud Migration Utility) by creating users, roles, permissions, and other entities required by the migrated bots to run successfully.

Note: The only way by which you can migrate from Enterprise 11 or Enterprise 10 to Automation 360 Cloud on Google Cloud Platform is by using the following procedure.

1. Ensure that you have completed the following tasks to check your readiness for migration

Check migration readiness.

2. Ensure you have procured and activated your migration license.

Get migration license

Recommended: Use the manual migration in the following scenarios:

- You have an existing Automation 360 Cloud instance and want to migrate your Enterprise 11 data.
 - When you want to migrate only bots and re-create all other Enterprise 11 or Enterprise 10 entities such as users, roles, and credentials manually in Automation 360.
 - When you want to migrate only a few of the Enterprise 11 or Enterprise 10 entities. For example, if you have 50 users and 10 user-defined roles in Enterprise 11 or Enterprise 10 and you want to migrate only 40 users and 7 roles to Automation 360. Similarly, if you want to migrate only users and roles and want to re-create the required schedules in Automation 360.
-

For information about automated migration to Cloud (using the Cloud Migration Utility), see *Prepare for Enterprise 11 to Automation 360 Cloud migration*.

1. Create all the Enterprise 11 or Enterprise 10 entities in Automation 360 Cloud.
For more information about the entities you must create, see *Prerequisites for manual migration*.
2. Upload the bots:

Version	Steps
Enterprise 11	<i>Import bots</i>

Version	Steps
Enterprise 10	<p>a. <i>Upload bot and its dependencies</i></p> <p>The bots are uploaded to the private workspace in Automation 360. Ensure you have created the same folder structure in the public workspace as in Enterprise 10 Control Room.</p> <p>You must upload all dependent bots and other files required by the uploaded bots to run successfully in Automation 360. All uploaded bots, their dependent bots, and other required files must be stored in the same folder in the Automation 360 as in Enterprise 10.</p> <p>b. Check in the uploaded bots that are available in the private workspace.</p> <p><i>Check in a bot</i></p>

See the following video on how to manually migrate to Automation 360 using Bot Lifecycle Management:

<https://fast.wistia.net/embed/iframe/1oi2c0s2kp>

Prerequisite tasks for migrating bots

Prerequisites for manual migration

When you migrate from Enterprise 11 or Enterprise 10, if you have not used the Enterprise 11 database or copied Enterprise 10 data, you must manually create all the entities of Enterprise 11 or Enterprise 10 in Automation 360.

Create the following Enterprise 11 or Enterprise 10 entities except bots in Automation 360:

- *Create a user*
- *Create a role*
- Credentials and lockers used in bots

Credentials and lockers in the Credential Vault

- **AAApplicationPath** global value and set its value the same as Enterprise 11 or Enterprise 10 for the required users
- **AADefaultDateFormat** global value and set its value as MM/DD/YYYY HH:MM:SS.
- The following global values that will be used by the **Send email** action:
 - AAE_EmailSettings_auth
 - AAE_EmailSettings_host
 - AAE_EmailSettings_port
 - AAE_EmailSettings_ssl

The values for the preceding global values must be the same as those specified in Enterprise 11 in **Tools > Options > Email Settings**.

You must create the AAE_EmailSettings_auth and AAE_EmailSettings_ssl global values of type boolean. The value for these must be assigned based on the Enterprise 11 configuration. For example, if

the **My server requires authentication** option is selected in Enterprise 11, you must set the `AAE_EmailSettings_auth` value as `true`. Similarly, if the **My server uses a secure connection** option is selected in Enterprise 11, you must set the `AAE_EmailSettings_ssl` value as `true`.

- The following global values if you have used Exchange Web Services (EWS) in Enterprise 11:
 - `AAE_EmailSettings_tenantId`
 - `AAE_EmailSettings_clientId`
 - `AAE_EmailSettings_domainName`
- Create the same folder structure as Enterprise 11 or Enterprise 10 in Automation 360.

Important: You must create the `MetaBots` folder in the `Bots` folder in Automation 360 even if you do not have any MetaBots in Enterprise 11 or Enterprise 10.

- Upload all Enterprise 11 or Enterprise 10 bots and their dependencies to the Automation 360 Control Room.

You must upload the bots and their dependencies at the same location as in Enterprise 11 or Enterprise 10.

- Migrate the bots in the following sequence:
 1. MetaBots
 2. Child bots
 3. Parent or main bots

Important: You must create all of the preceding entities in Automation 360 the same as how they are available in Enterprise 11 or Enterprise 10.

Prepare for Enterprise 11 to Automation 360 On-Premises migration

Perform the tasks in this workflow to migrate from Enterprise 11 to Automation 360 On-Premises, including migration of your bots to Automation 360. Dashboards created in Bot Insight for Enterprise 11 analytics bots are also migrated.

Workflow map: You can also view this migration workflow in an interactive visual format by clicking the



following schematic image:

1. [Migrating from Enterprise 11 to Automation 360 On-Premises](#)

1. Ensure that you have completed the following tasks to check your readiness for migration
[Check migration readiness](#).
2. Ensure you have procured and activated your migration license.
[Get migration license](#)

3. If you are installing Automation 360 on a machine on which Enterprise 11 was previously installed, you must delete the data from the Elasticsearch data folder located at `C:/ProgramData/elasticsearch/data`.

If the location of the Elasticsearch data folder was changed, you can find the updated information in the `C:\Program Files\Automation Anywhere\Enterprise\elasticsearch\config\elasticsearch.yml` file.

Important: If you delete the Elasticsearch data, you will lose the Enterprise 11 audit data.

Recommendation: Install Automation 360 on a separate server to ensure that your Enterprise 11 environment is not impacted by the migration activities.

1. We recommend that you create a backup of the Enterprise 11 database and restore it in the same or different SQL instance to avoid failure of any automation task that is using the Enterprise 11 database.

Quickstart: Back up and restore a SQL Server database on-premises

Bot Insight migration: The Bot Insight data and dashboards are migrated as part of the overall migration process. For the migration, clone your Bot Insight database (which is different from your Enterprise 11 Control Room database) and extract and export your dashboard metadata to Automation 360 using the Bot Insight pre-migration utility.

Export Enterprise 11 Bot Insight dashboards for migration

The following video shows how to create a backup of the Enterprise 11 database:

<https://fast.wistia.net/embed/iframe/ie802hliy9>

2. If you are migrating from Version 11.3.x or later versions, delete data from the `ES_SETTINGS` table from the Enterprise 11 Control Room database.
3. Copy and paste the Enterprise 11 Control Room repository and update the Enterprise 11 database with the Automation 360 repository path.
Copy and paste Enterprise 11 information to Automation 360
4. Ensure that all the credential variables used in the Enterprise 11 bots are available in the Enterprise 11 Control Room.
5. Install Automation 360 On-Premises:
 - a) Ensure you meet the system requirements.
Automation 360 On-Premises prerequisites
 - b) Install Automation 360 On-Premises Control Room in custom mode to a staging environment.
Installing Control Room using Custom mode

Important: During the installation, configure the Automation 360 On-Premises Control Room to use the restored Enterprise 11 database. This ensures that all your Enterprise 11 data is available in Automation 360 as is. For information on what is migrated and not migrated, see *What is migrated and not migrated*.

6. After installing the Automation 360 On-Premises, update Automation 360 access URL in the restored Enterprise 11 Control Room database. This access URL will be used to access the Control Room in Automation 360.

To update the access URL: update CONFIGURATION set value = '[Automation 360 Control Room URL]' where category = 'CR_setup_general' and config_key = 'AccessUrl'

Example query: update [Automation 360-Database].[dbo].[CONFIGURATION] set value ='http://Automation 360-curl.com' where config_key='AccessUrl'

Note: Do not include a slash (/) at the end of the access URL that you provide in the above command.

7. Verify that all the data you pasted is available in the relevant files and folders.
8. Optional: Migrate audit log data.

Migrate Enterprise 11 audit logs

To learn more, search for the *Migrating from enterprise 11 to Automation 360 On-Premises* course in *Automation Anywhere University: RPA Training and Certification (A-People login required)*.

Prerequisite tasks for migrating bots

Related tasks

[Prepare for Enterprise 10 to Automation 360 On-Premises migration](#)

Perform the tasks in this workflow to migrate from Enterprise 10 to Automation 360 On-Premises, including migration of your bots to Automation 360.

Back up and restore Enterprise 11 or Enterprise 10 database

Before you start migration, back up and restore your Enterprise 11 or Enterprise 10 database.

Quickstart: Back up and restore a SQL Server database on-premises.

Copy and paste Enterprise 11 information to Automation 360

The Enterprise 11 server repository files and the Credential Vault file are required in the Automation 360 environment. The most efficient way to get this data is to copy it from the Enterprise 11 environment into Automation 360.

You must copy the necessary files from Enterprise 11 data and paste it **before** installing Automation 360. You must also run the queries to update the Control Room access URL and repository path.

To learn more about how to migrate to Automation 360, search for the following courses in *Automation Anywhere University: RPA Training and Certification (A-People login required)*:

- *Migrating from Enterprise 11 to Automation 360 On-Premises*
- *Migrating from Enterprise 10 to Automation 360 On-Premises*

1. Copy and paste the Enterprise 11 repository data.

The location of the Enterprise 11 repository is available from **Administration > Settings > General** in the Enterprise 11 Control Room.

See *Configuration settings* .

Remember:

- If the Enterprise 11 Credential Vault is configured in **Manual** mode, copy the file containing the master key of the Credential Vault that is stored at a secured location. The master key is required

when you log in to Automation 360 for the first time after migrating from Enterprise 11 using the restored Enterprise 11 database.

- If your Enterprise 11 Control Room has version control enabled, the latest versions of each bot, including the dependencies, are copied and migrated from the Enterprise 11 repository to Automation 360. However, the version history of the bot and its dependencies are not copied and migrated.
- If you want to set up a cluster configuration in Automation 360, you must paste the copied Enterprise 11 data on a shared network location that all the nodes can access in the cluster.
- If you are using NAS to store Enterprise 11 repository data and your Automation 360 repository data is on local drive, the process of copying Enterprise 11 data from NAS to Automation 360 local drive remains the same.

- a) Create the following folder structure at any location on the device if it does not already exist. For example, `C:\ProgramData\AutomationAnywhere\Server Files`

Notes:

- If you want to set up a cluster configuration in Automation 360, you must paste the copied Enterprise 11 data on a shared network location that all the nodes can access in the cluster.
- If your Enterprise 11 database is stored in NAS storage and you want to migrate to your Automation 360 local drive, the process of copy and paste is same.

- b) Create the following folders within the Server Files folder you have created in Step a: `Default\0\Automation Anywhere\Bots`

Based on the folders you created in the previous step, the final folder structure must be: `C:\ProgramData\AutomationAnywhere\Server Files\Default\0\Automation Anywhere\Bots`

The `C:\ProgramData\AutomationAnywhere\Server Files` in the folder structure is the dynamic path, which can be any location based on your requirement. Whereas the `Default\0\Automation Anywhere\Bots` is a constant path that does not change.

Note: This path is not a temporary path for migration but will be used to store all the bots and packages.

- c) Copy and paste the Enterprise 11 `CredentialVault.dat` file and the folders that contain bots and MetaBots in the folder structure you have created in the previous step.

Enterprise 11 files and folders to be copied	Enterprise 11 location	Automation 360 location
CredentialVault.dat file	AutomationAnywhere\Server Files	AutomationAnywhere\Server Files
	The CredentialVault.dat file is available at this location only if the Enterprise 11 Credential Vault is configured in Express mode.	

Enterprise 11 files and folders to be copied	Enterprise 11 location	Automation 360 location
All the files and folder including My Tasks and My MetaBots folders	AutomationAnywhere Server Files DefaultAutomation Anywhere	AutomationAnywhere Server Files Default Automation AnywhereBots

- a) Create a folder for Automation 360 at any location on the device.
For example, D:\New project\Automation 360.

Notes:

- If you want to set up a cluster configuration in Automation 360, you must paste the copied Enterprise 11 data on a shared network location that all the nodes can access in the cluster.
- If your Enterprise 11 database is stored in NAS storage and you want to migrate to your Automation 360 local drive, the process of copy and paste is same.

- b) Create the following folders within the Automation 360 folder you have created in the previous step: AutomationAnywhere\Server Files\Default\Automation Anywhere\Bots
Based on the folders you created in the previous step, the final folder structure must be: D:\New project\Automation 360\AutomationAnywhere\Server Files\Default\Automation Anywhere\Bots

The D:\New project\Automation 360 in the folder structure is the dynamic path, which can be any location based on your requirement. Whereas the AutomationAnywhere\Server Files\Default\Automation Anywhere\Bots is a constant path that does not change.

- c) Copy and paste the Enterprise 11 CredentialVault.dat file and the folders that contain bots and MetaBots in the folder structure you have created in the previous step.

Enterprise 11 files and folders to be copied	Enterprise 11 location	Automation 360 location
CredentialVault.dat file	AutomationAnywhere Server Files	AutomationAnywhere Server Files
	The CredentialVault.dat file is available at this location only if the Enterprise 11 Credential Vault is configured in Express mode.	

Enterprise 11 files and folders to be copied	Enterprise 11 location	Automation 360 location
All the files and folder including My Tasks and My MetaBots folders	\AutomationAnywhere \Server Files \Default\Automation Anywhere\	\AutomationAnywhere \Server Files \Default \0\Automation Anywhere\Bots\

See the following video on how to create the Enterprise 11 Control Room repository in the Automation 360 server:

<https://fast.wistia.net/embed/iframe/4do5jlaqjp>

You must perform the following step (Step 2) on the Enterprise 11 restored database that you backed up as part of Step 1 in *Prepare for migration*.

2. Update the Automation 360 repository path in the restored Enterprise 11 database by running the following SQL command:

To update the repository path, update CONFIGURATION set value = Automation 360 Control Room dynamic path followed by \AutomationAnywhere\Server Files where category = 'CR_setup_general' and config_key = 'RepositoryPath'

The dynamic path in the query is the dynamic path where you have pasted the copied Enterprise 11 data in the above step.

Example query: update [Automation 360-Database].[dbo].[CONFIGURATION] set value ='C:\ProgramData\AutomationAnywhere\Server Files' where config_key='RepositoryPath'

The path mentioned in the query is the same as the dynamic path where the Enterprise 11 data is copied in the example in the previous step.

See the following video on how to restore a backed-up Enterprise 11 database:

<https://fast.wistia.net/embed/iframe/f89ddewr8n>

Complete the steps listed in *Prepare for Enterprise 11 to Automation 360 On-Premises migration*.

Export Enterprise 11 Bot Insight dashboards for migration

Use the Bot Insight pre-migration utility to export your Enterprise 11 Bot Insight dashboard metadata (widgets and layouts) and dashboard profile as a zip file. Run this utility in your Enterprise 11 device and paste the zip file in the Automation 360 repository to migrate the Bot Insight dashboards.

- Back up the Bot Insight database after you have backed up the Enterprise 11 Control Room database and restore it in the SQL Server instance. Ensure the following when you restore the Bot Insight database:
 - Use the same username and password of the Control Room database used in Automation 360.
 - The name of the Bot Insight database that you are restoring in Automation 360 environment is the same as the Enterprise 11 Bot Insight backed up database.
- Ensure that JRE is installed in the Enterprise 11 device.

Important: Migration of Bot Insight is supported only if the database is installed on Microsoft SQL Server or if the Metadatabase is installed on either Microsoft SQL Server or PostgreSQL Server. Bot Insight migration is not supported if the database is installed on PostgreSQL Server.

Note: After data is migrated from Enterprise 11 to Automation 360, ensure that the end-to-end migration activity is completed within 90 days from the first day of data migration. After 90 days, the Bot Insight analytical data will be deleted.

1. Download the latest version of the Bot Insight pre-migration utility from the Automation Anywhere Support site.
-

Important: You must download the utility on the device on which the Enterprise 11 Control Room is installed.

- a) Navigate to the Automation Anywhere Downloads page: [A-People Downloads page \(Login required\)](#).
- b) Click the **Automation 360** download link.
- c) Open the **Installation Setup** folder and download the `AAE_Export_BI_Dashboards_<version_number>` file, for example, `AAE_Export_BI_Dashboards_A360.23.jar`.

See the following video on how to download the pre-migration utility:

<https://fast.wistia.net/embed/iframe/zibcotu9ke>

2. Run the utility in the Enterprise 11 device.

- a) Open the Windows command prompt.

- b) Run the following command to export the Bot Insight dashboards to a zip file:

```
java -jar "<path_of_downloaded_utility_jar>/AAE_Export_BI_Dashboards_<version_number>.jar" -installationPath "<installation_path>/Enterprise" -outputDir "<path_to_save_zip_file>/dashboards"
```

For example:

```
java -jar "Downloads/AAE_Export_BI_Dashboards_A360.23.jar" -installationPath "C:/Program Files/Automation Anywhere/Enterprise" -outputDir "E:/AA/work/release/A360/migration/dashboard"
```

The utility generates the `dashboards.zip` file at the output directory you specified.

Note: You can also use double backslash (\\) to run the JAR file.

3. Create the `bot-insight` folder at the Automation 360 installation location.

For example, `C:\Program Data\Automation Anywhere\Server Files\bot-insight`

In this path, `C:\Program Data\Automation Anywhere\Server Files` is a dynamic path, which can be any location based on your requirement. The folder structure following the dynamic path (`\bot-insight`) is a constant path that does not change.

4. Copy the `dashboards.zip` file available at the output location and paste in the `Server Files\bot-insight` folder.

After exporting dashboards in the Automation 360 repository, do the following for migrating the Bot Insight dashboards.

1. Install Automation 360 and log in to your Automation 360 staging environment.

[Installing Control Room On-Premises](#)

2. Migrate the bots along with the Bot Insight data and dashboards using the Bot Migration Wizard.

[Migrate Enterprise bots](#)

See the following video on how to prepare Bot Insight data for migration:

<https://fast.wistia.net/embed/iframe/th2jtps07k>

Migrate Enterprise 11 audit logs

The audit log export utility enables you to export the audit log data from the Enterprise 11 Control Room to a JSON file. You must paste the JSON file in the Automation 360 repository and then migrate the audit log data.

Note: Migration of audit logs from Enterprise 11 to Automation 360 is supported only for On-Premises deployments.

Ensure you have the **AAE_Admin** role or the **Manage Migration** permission.

- Starting with Automation 360 v.23, you can migrate audit log data of Version 11.3.5 or later versions.
- The audit log export utility exports information about all Enterprise 11 log events, including those that are currently not supported in Automation 360 such as multi-factor authentication (MFA) and run bots through command line.

Based on the current version of your Control Room, choose one of the following ways to export and migrate the audit log data:

- **For Version 11.3 and later:**

- a) Download the latest version of the audit log export utility from the Automation Anywhere Support site.

Important: You must download the utility on the machine on which the Version 11.3 Control Room is installed. If the Control Room is installed in **Cluster mode**, you can download the utility on any of the node available in the cluster.

- a. Navigate to the Automation Anywhere Downloads page: [A-People Downloads page \(Login required\)](#).
- b. Click the Automation 360 link.
- c. Click **Installation Setup**, and then click `AAE_Export_Audit_Log_v2.zip` file..

- b) Extract the files from the zip file you have downloaded.

- c) Open the Windows command prompt.

- d) Change the working directory to `AAE_Export_Audit_Log_v2` and enter the following command: `bin\java -jar AAE_Export_Audit_Log_v2.jar export.path="OUTPUT LOCATION" cr.version="CONTROL ROOM VERSION" install.path="CONTROL ROOM INSTALLATION PATH"`

Update the following values in the command:

- **OUTPUT LOCATION:** Replace the text with the location where you want to save the output.
 - Ensure that the folders mentioned in the location exist.
 - Ensure that you specify the location of the output folder in double quotation marks.
- **CONTROL ROOM VERSION:** Replace the text with the current version of the Enterprise 11 Control Room that is installed. The `cr.version` value is the first three digits of the Enterprise

11 Control Room. For example, if the Control Room is Version 11.3.4.4, enter the `cr.version` value as 11.3.4.

- **CONTROL ROOM INSTALLATION PATH:** Replace the text with the full path of the location where the Control Room is installed. For example, `C:\Program Files\Automation Anywhere\Enterprise`.

Command example: `bin\java -jar AAE_Export_Audit_Log_v2.jar export.path="C:\Migration\Audit Log" cr.version="11.3.2" install.path="C:\Program Files\Automation Anywhere\Enterprise"`

The utility generates the `es_export.json` file at the output location you specified. The generated JSON file contains a maximum of 10000 records. If there are more than 10000 records available in the audit data, the utility generates multiple JSON files at the same location and adds a suffix such as `es_export_1`.

- Create the `migration\es-data` folders in the Automation 360 repository.
- Copy the JSON file available at the output location.
If the utility has generated multiple JSON files, you must copy all the files.
- Paste the JSON file in the `Server Files\migration\es-data` folder.
See the following video on exporting 11.3.x audit log data for migration:

<https://fast.wistia.net/embed/iframe/vhy6sa90xp>

- Log in to your Automation 360 staging environment.
- Go to **Administration > Migration**.
- Click **Migrate Audit log** from the **Migrate bots** menu on the top-right of the screen.
The system starts retrieving and migrating the audit log data from the `es_export.json` file and uploading it to Automation 360 Elasticsearch. The entries are displayed in the **Audit Log** tab of Automation 360.

After the Audit log migration is complete, navigate to **Administration > Migration** page to view the status of the audit log migration and other related information. You can also filter the audit log migration results based on the migration **Type** as the **Audit log migration**.

Click the **View migration** option for each audit migration instance to see additional information such as the audit log file path and the reasons why individual `es_export.json` files were skipped or were not successfully migrated when migrating the audit logs.

[View migration reports](#)

- **For version 11.2 and earlier:**

- Log in to your Automation 360 staging environment.
- Go to **Administration > Migration**.
- Click **Migrate Audit data** from the **Migrate bots** menu on the top-right of the screen.
The system starts retrieving and migrating the audit data from the database and uploading it to the Automation 360 Elasticsearch. The entries are displayed in the **Audit Log** tab of Automation 360.

See the following video on migrating Enterprise 11 audit log data:

<https://fast.wistia.net/embed/iframe/57or6fu6k5>

Related tasks

[View migration reports](#)

Use the reports to analyze the status of individual bot migration, data migration, and audit log migration and identify the status and summary of the individual migration.

Prepare for migration when using Enterprise 11 and Automation 360 On-Premises in parallel

Perform the tasks in this workflow if you want to use both Automation 360 On-Premises and Enterprise 11 in parallel. You can continue to use both environments till the time you are ready to start the migration from Enterprise 11 to Automation 360 On-Premises.

1. Ensure that you have completed the following tasks to check your readiness for migration

Check migration readiness.

2. Ensure you have procured and activated your migration license.

Get migration license

3. If you are installing Automation 360 on a machine on which Enterprise 11 was previously installed, you must delete the data from the Elasticsearch data folder located at `C:/ProgramData/elasticsearch/data`.

If the location of the Elasticsearch data folder was changed, you can find the updated information in the `C:\Program Files\Automation Anywhere\Enterprise\elasticsearch\config\elasticsearch.yml` file.

Important: If you delete the Elasticsearch data, you will lose the Enterprise 11 audit data.

Recommended: Install Automation 360 on a separate server to ensure that your Enterprise 11 environment is not impacted by the migration activities.

1. We recommend that you create a backup of the Enterprise 11 database and restore it in the same or different SQL instance to avoid failure of any automation task that is using the Enterprise 11 database.

Quickstart: Back up and restore a SQL Server database on-premises

Bot Insight migration: The Bot Insight data and dashboards are migrated as part of the overall migration process. For the migration, clone your Bot Insight database (which is different from your Enterprise 11 Control Room database) and extract and export your dashboard metadata to Automation 360 using the Bot Insight pre-migration utility.

Export Enterprise 11 Bot Insight dashboards for migration

2. If you are migrating from Version 11.3.x or later versions, delete data from the `ES_SETTINGS` table from the Enterprise 11 Control Room database.
3. Copy and paste the Enterprise 11 Control Room repository and update access URL and repository path.
Copy and paste Enterprise 11 information to Automation 360
4. Ensure that all the credential variables used in the Enterprise 11 bots are available in the Enterprise 11 Control Room.

5. Install Automation 360 On-Premises:

- a) Ensure you meet the system requirements.

Automation 360 On-Premises prerequisites

- b) Install Automation 360 On-Premises Control Room in custom mode to a staging environment.

Installing Control Room using Custom mode

Important: During the installation, configure the Automation 360 On-Premises Control Room to use the restored Enterprise 11 database.

6. Continue using both Enterprise 11 and Automation 360 environments in parallel.

Recommendation: Create all new bots and entities such as users, roles, and schedules in Automation 360.

- 7. If you create any new entity such as users, roles, or schedules (except bots) in Enterprise 11 after installing Automation 360, create the same entity in Automation 360.**

8. When you are ready to use only Automation 360 as your production environment:

- a) If you have created new bots in Enterprise 11 after installing Automation 360:

- 1. Export all the bots and their dependencies that were created after Automation 360 was installed using Bot Lifecycle Management.**

Export bots

- 2. Import all the bots to Automation 360 using Bot Lifecycle Management.**

Import bots

9. Optional: Migrate audit log data.

Migrate Enterprise 11 audit logs

Prerequisite tasks for migrating bots

How workload management data is migrated

Enterprise 11 workload management data is automatically migrated to Automation 360 when you install Automation 360 and point the Control Room to the restored Enterprise 11 database.

When you migrate workload management data to Automation 360, all related workload management is moved to the Automation 360 environment, including queues, device pools, owners, and consumers. Migrated device pools are empty because the migration process does not migrate devices. You must update the device pool with the relevant unattended Bot Runner devices.

Note: Bots that are deleted in the workload management automation records are skipped during migration. These bots are displayed as **N/A** in the workload queues.

Bots associated with a workload template are migrated to the same Automation 360 template with all information intact.

The following work item variables are supported for migration:

- `$WorkItem$` – How this variable is migrated depends on the String, Number, and DateTime type associated with it.

Variable mapping for migration

- `$WorkItemResult$` – Bots using this variable must be associated with a workload template in Enterprise 11 if you want to use it after migration. If you migrate a bot that has the `$WorkItemResult$` variable in a command and the bot is not linked to a workload template, then the command shows an error when it is opened in the Bot editor in Automation 360.

The following work item variable operations are not yet supported and bots using these variable operations cannot be migrated successfully:

- Reset `$WorkItem$`
- Reset `$WorkItemResult$`

Related tasks

[Edit device pools](#)

As a Control Room user with device pool management privileges or as a device pool owner, you can edit device pool details to customize your automation requirements.

[Use Work Item variables](#)

You can use the Work Item variables to pass the Work Item attributes or values to the TaskBot from the Control Room when you run the bot with the option **Run bot with queue**.

Prepare to manually migrate to Automation 360 On-Premises

You can manually migrate from Enterprise 11 to Automation 360 On-Premises by creating users, roles, permissions, and other entities required by the migrated bots to run successfully.

1. Ensure that you have completed the following tasks to check your readiness for migration

[Check migration readiness](#)

2. Ensure you have procured and activated your migration license.

[Get migration license](#)

Recommended: Use the manual migration in the following scenarios:

- You have an existing Automation 360 On-Premises instance and want to migrate your Enterprise 11 data.
- When you want to migrate only bots and re-create all other Enterprise 11 entities such as users, roles, and credentials manually in Automation 360.
- When you want to migrate only a few of the Enterprise 11 entities. For example, if you have 50 users and 10 user-defined roles in Enterprise 11 and you want to migrate only 40 users and 7 roles to Automation 360. Similarly, if you want to migrate only users and roles and want to re-create the required schedules in Automation 360.
- When you want to migrate Enterprise 11 entities to Automation 360 using a freshly installed database and server.

-
1. Install Automation 360 On-Premises:

- a) Ensure you meet the system requirements.

[Automation 360 On-Premises prerequisites](#)

- b) Install Automation 360 On-Premises Control Room in custom mode to a staging environment.

[Installing Control Room using Custom mode](#)

Important: You must install Automation 360 with a new database.

2. Create all the Enterprise 11 entities in Automation 360 On-Premises.
For more information about the entities you must create, see [Prerequisites for manual migration](#).
3. Export all the bots and their dependencies that were created after Automation 360 was installed using Bot Lifecycle Management.
[Export bots](#)
4. Upload the bots to Automation 360 On-Premises.
[Import bots](#)

[Prerequisite tasks for migrating bots](#)

Prepare for Enterprise 11 to Automation 360 Cloud-enabled migration

Perform the tasks in this workflow to migrate from Enterprise 11 to Automation 360 Cloud enabled, including migration of your bots.

If you are installing Automation 360 on a machine on which Enterprise 11 was previously installed, we recommend you delete the data from the Elasticsearch data folder located at `C:\ProgramData\elasticsearchdata`.

Note: If the location of the Elasticsearch data folder was changed, you can find the updated information in the `C:\Program Files\Automation Anywhere\Enterprise\elasticsearch\config\elasticsearch.yml` file.

1. Ensure that you have completed the following tasks to check your readiness for migration
[Check migration readiness](#).
 2. Ensure you have procured and activated your migration license.
[Get migration license](#)
-
1. Install the Automation 360 for Cloud enabled deployment.
[Installing Control Room for Cloud-enabled deployment](#)
 2. Create all the entities such as users, roles, and credentials except bots in Automation 360 the same as how they are available in Enterprise 11.
[Prerequisites for manual migration](#)
 3. Export all Enterprise 11 bots and their dependencies that you want to migrate to Automation 360 using Bot Lifecycle Management.
[Export bots](#)
 4. Import all Enterprise 11 bots to Automation 360 using Bot Lifecycle Management.
[Import bots](#)
 5. Optional: Migrate audit log data.
[Migrate Enterprise 11 audit logs](#)

[Prerequisite tasks for migrating bots](#)

Prepare for Enterprise 11 to Automation 360 on Linux CentOS migration

Perform the tasks in this workflow to migrate from Enterprise 11 to Automation 360 On-Premises on Linux CentOS, including migrating your bots to Automation 360. If the Enterprise 11 bot is enabled for analytics, the associated Bot Insight data and business analytics dashboard are also migrated.

Recommendation: Create a new environment for migrating to Automation 360 to avoid any issues to your existing bots due to migration activities.

1. We recommend that you create a backup of the Enterprise 11 database and restore it in the same or different SQL instance to avoid failure of any automation task that is using the Enterprise 11 database.
Quickstart: Back up and restore a SQL Server database on-premises
2. If you are migrating from Version 11.3.5 or later versions, you must delete data from the ES_SETTINGS table from the Enterprise 11 Control Room database.
3. Ensure that all the credential variables used in the Enterprise 11 bots are available in the Enterprise 11 Control Room.
4. Copy and paste the Enterprise 11 Control Room repository:
 - a) Use the `sudo mkdir -p /opt/automationanywhere/enterprise/appdata/` command to create the required Automation 360 folders.
 - b) Use the `sudo chmod -R 775 /opt/automationanywhere` command to provide the required permissions for the folders.
 - c) Use the `sudo mv` command to copy the Enterprise 11 repository and paste it in the `automationanywhere/enterprise/appdata/` location.
5. Update the Control Room access URL and repository path by running the following SQL commands on the restored Enterprise 11 database:
 - a) To update the access URL: update CONFIGURATION set value = '[Automation360 Control Room URL]' where category = 'CR_setup_general' and config_key = 'AccessUrl'
Example query: update [Automation360-Database].[dbo].[CONFIGURATION] set value = 'http://Automation360-crurl.com' where config_key='AccessUrl'

Note: Do not include a slash (/) at the end of the access URL that you provide in the above command.

 - b) To update the repository path: update CONFIGURATION set value = /opt/automationanywhere/enterprise/appdata/Server Files where config_key = 'RepositoryPath'
6. Install Automation 360 On-Premises:
 - a) Ensure you meet the system requirements.
Automation 360 On-Premises prerequisites
 - b) Install Automation 360 On-Premises Control Room in custom mode to a staging environment.
Installing Control Room on Linux

Important: During the installation, configure the Automation 360 On-Premises Control Room to use the restored Enterprise 11 database.

7. Optional: Migrate audit log data.

[Migrate Enterprise 11 audit logs](#)

Prerequisite tasks for migrating bots

Prepare for Enterprise 10 to Automation 360 On-Premises migration

Perform the tasks in this workflow to migrate from Enterprise 10 to Automation 360 On-Premises, including migration of your bots to Automation 360.

Workflow map: You can also view this migration workflow in an interactive visual format by clicking the



following schematic image:

1. [Migrating from Enterprise 10 to Automation 360 On-Premises](#)

1. Ensure that you have completed the following tasks to check your readiness for migration

[Check migration readiness.](#)

2. Ensure you have procured and activated your migration license.

[Get migration license](#)

Recommendation: Install Automation 360 on a separate server to ensure that your Enterprise 10 environment is not impacted by the migration activities.

1. We recommend that you create a backup of the Enterprise 10 database and restore it in the same or different SQL instance to avoid failure of any automation task that is using the Enterprise 10 database.

[Quickstart: Back up and restore a SQL Server database on-premises](#)

2. Ensure that all the credential variables used in the Enterprise 10 bots are available in the Enterprise 10 Control Room.

3. Install Automation 360 On-Premises:

a) Ensure you meet the system requirements.

[Automation 360 On-Premises prerequisites](#)

b) Install Automation 360 On-Premises Control Room in custom mode to a staging environment.

[Installing Control Room using Custom mode](#)

Important: You must install Automation 360 with a new database.

c) Configure the same authentication in Automation 360 as in Enterprise 10.

Do not switch authentication types between Enterprise 10 and Automation 360. For example, if Active Directory is set as authentication in Enterprise 10, you must configure Active Directory as authentication in Automation 360 as well.

4. Copy the Enterprise 10 data to Automation 360.

[Copy Enterprise 10 data](#)

5. Create the **AAApplicationPath** global value in Automation 360 and set the same value as Enterprise 10.

Migrating from Enterprise 10

6. Complete the pre-migration tasks.

Pre-migration tasks

Migrate Enterprise bots

How Enterprise 10 data is copied to Automation 360

Enterprise 10 users, roles, licenses, credentials, bots, and schedules are copied to Automation 360 as part of the copy data process.

The system copies Enterprise 10 data in the following order:

1. Roles
2. Users
3. Credentials
4. Bots
5. Schedules

If the copy process skips an item in the sequence for any reason, then all related items are also skipped and are not migrated. For example, if the Bot_Manager role is not migrated and the user Jane_Smith belongs only to that role, then that user account and any credentials, bots, or schedules associated with that role are also not migrated.

Enterprise 10 items	How Enterprise 10 items are copied to Automation 360
Users	<p>When you copy Enterprise 10 users the first time, if the system encounters a user of the same name in Automation 360, the migration process renames the Enterprise 10 username by adding a suffix such as <code>_1</code>, <code>_2</code>, and so on, and then copies the renamed user to Automation 360. For example, a duplicate username Jane_Smith is renamed as Jane_Smith_1 in Automation 360. Subsequent data copy operations will skip the previously migrated user data.</p> <p>For Active Directory users, the system does not migrate duplicate users. If a domain user with the same name already exists in Automation 360, the migration process skips that user and its dependencies.</p>
Roles	<p>The first time you copy Enterprise 10 roles, the migration process handles duplicate system roles and custom roles differently. The migration process maps Enterprise 10 system roles to Automation 360 system roles. For example, the Enterprise 10 Admin role and Basic role are mapped to the AAE_Admin role and AAE_Basic role, respectively.</p> <p>If a custom role of the same name exists in Enterprise 10 and Automation 360, the migration process renames it by adding a suffix such as <code>_1</code>, <code>_2</code>, and so on, and then copies the renamed role to Automation 360. For example, a duplicate Sales_Operations role is renamed as Sales_Operations_1 in Automation 360.</p> <p>Subsequent data copy operations will skip previously migrated roles.</p>

Enterprise 10 items	How Enterprise 10 items are copied to Automation 360
Licenses	<p>The migration process automatically migrates user allocated licenses, but they are not shown in the migration report. If the Automation 360 Control Room has fewer Bot Creator or Bot Runner licenses than Enterprise 10 Control Room and all Automation 360 licenses have been consumed, then newly migrated users will not be allocated any licenses. The system migrates these users and the related data without allocating any new licenses.</p>
Credentials	<p>For system credentials associated with a migrated user, the system migrates only the Email Settings and Autologin Settings system credentials.</p> <p>For credentials created by the Control Room administrator, the system creates the AAE_10x_Credentials locker in the Automation 360 Credential Vault and adds the credentials from Enterprise 10 as standard credentials. The system assigns the user who migrates the Enterprise 10 data as the owner of the AAE_10x_Credentials locker and all custom roles as consumers of the locker. If a locker with the name AAE_10x_Credentials already exists in Automation 360, the system adds the migrated credentials in that locker.</p> <hr/> <p>Note:</p> <ul style="list-style-type: none"> • Migration of credentials with more than 50 attributes is not supported. • Users with only AAE_Basic role assigned to them in Enterprise 10 must be granted a custom role in Automation 360 to be a consumer of the AAE_10x_Credential locker. <hr/> <p>For MetaBots that contain screens as assets and use password type variables in these screens, equivalent credential type variables are created in Automation 360. If the password type variable in the MetaBot is an input variable and a value to that variable is passed from the parent bot in Enterprise 10, complete the following steps before you run the migrated bots:</p> <ol style="list-style-type: none"> 1. Create the credential with the Standard option selected as input. 2. Create a locker and use the credential you created in the previous step in that locker. 3. In the migrated parent bot, use the credential you created to pass that credential to the child bots. <p>If you have used an array variable within a loop to pass multiple values to the password type variable used in the MetaBot, the migrated bot uses the credential you created to pass a single value.</p>

Enterprise 10 items	How Enterprise 10 items are copied to Automation 360
Bots	<p>If a bot of the same name exists in Enterprise 10 and Automation 360, the copy data process skips the bot migration and its associated schedule. Commands that use credential variables in Enterprise 10 bots use the AAE_10x_Credentials locker after migration.</p> <p>If your Enterprise 10 Control Room is configured with SVN version control, then the copy data process also copies the latest version of each bot including the dependencies from the Enterprise 10 repository to the Automation 360 repository. Use the bot migration wizard to migrate the Enterprise 10 bots to Automation 360. However, the version history of the bot and its dependencies are not copied and migrated.</p> <hr/> <p>Note: Migration of the production version of Enterprise 10 bots is currently not supported. As a workaround, make or set the current production version of the bots as the latest version and then migrate the bots.</p> <hr/>
Schedules	<p>If duplicate schedules exist in both environments, the duplicate schedule is migrated and results in two schedules of the same name in Automation 360.</p> <p>Migration of schedules fails if the associated user does not exist in Automation 360.</p>

See the following video on how to review the copied Enterprise 10 data in Automation 360:

<https://fast.wistia.net/embed/iframe/2bik88e0oj>

Related tasks

[Copy Enterprise 10 data](#)

You must copy the Enterprise 10 data to Automation 360 before you convert the Enterprise 10 bots.

[Enable schedules after migration](#)

When you copy Enterprise 10 data to Automation 360, the Enterprise 10 schedules are migrated. Version Enterprise 11 schedules are migrated when you update the Enterprise 11 data to Automation 360.

Copy Enterprise 10 data

You must copy the Enterprise 10 data to Automation 360 before you convert the Enterprise 10 bots.

The user performing this task must have the **AAE_Admin** role.

1. Log in to your Automation 360 staging environment.
2. Click **Administration > Migration**.
3. Click **Copy 10.x data**.
4. Provide the following information on the **GENERAL** page.

Option	Action
Name	Enter a migration name or use the default one. The default migration name shows the name of the user who is logged in, current date, and time stamp.
Description	Enter a description for the migration.

5. Click **Next**.

6. Provide the following information on the **DATABASE** page.

Option	Action
Use secure connection	Select this option to use a secure connection to connect with the database.
Server host name	Enter the host name of the database server that contains the Enterprise 10 data you want to migrate.
Server port	Enter the port you want to use to connect with the database server.
Use database credentials	Select this option to use database credentials for authentication when establishing a connection with the database server. If you have selected this option, provide the credentials you want to use to connect to the database server in the Username and Password fields.
Use Windows authentication	Select this option to use Windows authentication for establishing a connection with the database server. Important: This option works only if you have configured a domain account during installation and which has read and write permissions for Enterprise 10 database.
Database name	Enter the database name that contains the Enterprise 10 data you want to migrate.
Connect	Click this option to establish a connection with the database.

7. Click **Next**.8. Provide the following information on the **REPOSITORY** page.

Option	Action
Repository path	Enter the location of the restored Enterprise 10 data that is available on the device.
Master key	Enter the master key for Enterprise 10.
Validate	Click this option to validate the connection before you copy the Enterprise 10 data.

9. Click **Copy data**.

See the following video on how to copy Enterprise 10 data to Automation 360:

<https://fast.wistia.net/embed/iframe/h9jhnyazej>

Create AAApplicationPath global value in Automation 360

Related concepts

[How Enterprise 10 data is copied to Automation 360](#)

Enterprise 10 users, roles, licenses, credentials, bots, and schedules are copied to Automation 360 as part of the copy data process.

Related tasks

[Enable schedules after migration](#)

When you copy Enterprise 10 data to Automation 360, the Enterprise 10 schedules are migrated. Version Enterprise 11 schedules are migrated when you update the Enterprise 11 data to Automation 360.

Prepare for migration when using Enterprise 10 and Automation 360 On-Premises in parallel

Perform the tasks in this workflow if you want to use both Automation 360 On-Premises and Enterprise 10 in parallel. You can continue to use both environments till the time you are ready to start the migration from Enterprise 10 to Automation 360 On-Premises.

1. Ensure that you have completed the following tasks to check your readiness for migration

[Check migration readiness.](#)

2. Ensure you have procured and activated your migration license.

[Get migration license](#)

Recommendation: Create a new environment for migration to Automation 360 to avoid any issues to your existing bots because of migration activities.

1. We recommend that you create a backup of the Enterprise 11 database and restore it in the same or different SQL instance to avoid failure of any automation task that is using the Enterprise 11 database.

[Quickstart: Back up and restore a SQL Server database on-premises](#)

2. Ensure that all the credential variables used in the Enterprise 11 bots are available in the Enterprise 11 Control Room.

3. Install Automation 360 On-Premises:

a) Ensure you meet the system requirements.

b) Install Automation 360 On-Premises Control Room in custom mode to a staging environment.

[Installing Control Room using Custom mode](#)

Important: You must install Automation 360 with a new database.

4. Complete the pre-migration tasks.

[Pre-migration tasks](#)

5. Create the **AAApplicationPath** global value in Automation 360 and set the same value as Enterprise 10.

[Variable mapping for migration](#)

6. Copy the Enterprise 10 data to Automation 360.

[Copy Enterprise 10 data](#)

7. Continue using both Enterprise 10 and Automation 360 environments in parallel.

Recommendation: Create all new bots and entities such as users, roles, and schedules in Automation 360.

8. If you create any new entity such as users, roles, schedules, and bots in Enterprise 10 after installing Automation 360, create the same entity in Automation 360.

9. When you are ready to use only Automation 360 as your production environment:

If you have created new bots or updated the existing ones in Enterprise 10 after installing Automation 360, based on your environment, follow these steps:

- **Applies from v.24 onwards:**

- a. Export all the bots and their dependencies that were created after Automation 360 was installed using the export utility.

[Migrate new or updated Enterprise 10 bots to Automation 360](#)

- b. Import all the bots to Automation 360 using Bot Lifecycle Management.

[Import bots](#)

- **Applies to v.23 and previous versions**

- a. Copy all the bots and their dependencies from Enterprise 10 by using the **Copy 10.x data** option in the Automation 360.
- b. Login as the Bot Creator to upload the bots and their dependencies to the Automation 360 private workspace. Note that the folder structure of the bots and their dependencies must be same as that of version Enterprise 10.
- c. Check in the bots to the public workspace.

[Migrate Enterprise bots](#)

Migrate new or updated Enterprise 10 bots to Automation 360

The Enterprise 10 export utility enables you to migrate new or modified Enterprise 10 bots to Automation 360 after an earlier migration.

Use the export utility to create an `.aapkg` package that can be imported using the Bot Lifecycle Management and then migrated using the Bot Migration Wizard in Automation 360.

- 1.** Download the latest version of the bot export utility from the Automation Anywhere Support site.
 - a) Navigate to the Automation Anywhere Downloads page: *[A-People Downloads page \(Login required\)](#)*.
 - b) Click the Automation 360 link.
 - c) Click **Installation Setup**, and then click `AAE_Export_Legacy_Bots_v1.zip` file.
- 2.** Extract the files from the zip file you have downloaded.
- 3.** Open the Windows command prompt.

4. Change the working directory to `AAE_Export_Legacy_Bots_v1` and enter the following command:
`bin\java -jar AAE_Export_Legacy_Bots_v1.jar -INPUT="INPUT LOCATION" -
OUTPUT="OUTPUT LOCATION" -INCLUDE_SUBFOLDERS`
Update the following values in the command:

- **INPUT:** Replace the text with the file path or folder path of the Control Room repository from where the bot files (`.atmx` and `.mbot` files) have to be exported.
 - Ensure that the folders mentioned in the location exist.
 - Ensure that you specify the location of the input folder in double quotation marks.
- **OUTPUT:** Replace the text with an output location where you want to store the exported bot files in a package (`.aapkg`) with time stamp.
 - Ensure that the folders mentioned in the location exist.
 - Ensure that you specify the location of the output folder in double quotation marks.
- **INCLUDE_SUBFOLDERS:** Provide this optional parameter to indicate whether the bot files from the nested subfolders of the Control Room repository should be exported or not.

Command example to export folder: `bin\java -jar AAE_Export_Legacy_Bots_v1.jar -
INPUT="E:\Migration10x\Automation Anywhere Server Files\Default\Automation
Anywhere\My Tasks\10X\Sample_Tasks" -OUTPUT="F:\10x-Export-Utility
\Exported-Bots"`

Command example to export file: `bin\java -jar AAE_Export_Legacy_Bots_v1.jar -
INPUT="E:\Migration10x\Automation Anywhere Server Files\Default\Automation
Anywhere\My Tasks\10X\AutomationTask.atmx" -OUTPUT="F:\10x-Export-Utility
\Exported-Bots"`

The utility generates the `.aapkg` file at the output location you specified.

5.

1. Navigate to **Automation > Import bots** to import the `.aapkg` package file in Automation 360.
[Import bots](#)
2. Navigate to **Administration > Migration** to migrate the bots (convert `.atmx` file to `.bot` file) in Automation 360 using the Bot Migration Wizard.
[Migrate Enterprise bots](#)

Prerequisite tasks for migrating bots

After you have set up Automation 360, you must perform certain tasks before migrating the Enterprise 11 or Enterprise 10 bots.

- **Licenses:**
 - For migration to be successful, the license requirements of the target environments must match the existing source or environments.
 - At least one license is required for migration.

- **Roles:**

Assign the **AAE_Bot Migration Admin** role to the user who will initiate the migration and the Bot Runner user who will perform the migration. The Bot Runner user who runs the migration must have the following permissions and criteria:

- An unattended Bot Runner license
- **Autologin Set** status
- Default device configured

See the following video on how to create an Admin user to initiate bot migration:

<https://fast.wistia.net/embed/iframe/f25wouq30r>

See the following video on how to create a Bot Runner user to perform the bot migration:

<https://fast.wistia.net/embed/iframe/voytwilvtt>

- **Control Room settings:**

- Enterprise 11 users who have installed Automation 360 using a fresh database and Enterprise 10 users who have not copied Enterprise 10 data must manually create all the Enterprise 11 or Enterprise 10 entities, except bots, in Automation 360. See information about the entities you must create, see [Prerequisites for manual migration](#).

- **Bot Agent:** Install the Bot Agent on the device that you want to use for migration: [Install Bot Agent and register device](#).

See the following video on how to install the Bot Agent on the device identified for bot migration:

<https://fast.wistia.net/embed/iframe/az9qsfsvju>

- **Bots:** To migrate the production version of bots, import the Enterprise 11 bots using the Bot Lifecycle Management feature from the SVN version control enabled Enterprise 11 Control Room. See [Import bots](#).

Next steps

[Migrate Enterprise bots](#)

Migrate and validate bots

Perform the tasks in this workflow to convert your bots to the Automation 360 format and to validate them after migration.

Ensure that you have completed all the tasks about preparing your Automation 360 environment for migration: [Prepare new Control Room for migration](#).



1. Migrate your Enterprise 11 and Enterprise 10 bots to Automation 360: [Migrate Enterprise bots](#).
2. Verify the migration is completed successfully:
 - [View migration reports](#)
 - [Verify the bot migration](#)
 - [Export to CSV](#)
 - [View changes to migrated bots using Bot Assistant](#)

See also the following video on migrating, testing, and updating your migrated bots:

Bot Migration Wizard

This wizard is integrated in Control Room in Automation 360 and guides you through the migration process after you complete the prerequisites. You can migrate multiple bots and their dependent bots using this wizard.

The Bot Migration Wizard migrates a bot only if all of the components used in that bot are supported for migration. If a bot uses other dependent files such as .txt, .doc, and .png, you have to add these files as dependencies manually after migrating the bots.

You can also use the **Bot migration** package to migrate individual bots. However, we do not recommend using this package because it does not migrate bot dependencies and other entities that are required to run the bot after migration.

In the Control Room (**Administration > Migration > Overview**) tab, you can get a consolidated view of the status of migrated bots.

Overview tab

Important: You must have both **View migration** and **Manage Migration** permission to view this tab.

You can view the overall status of bot migration, including the following details:

- Bots that are migrated successfully
- Bots that failed to migrate
- Bots that are migrated with a review message
- Bots that are migrated with an action required message
- History of migration: Information about past migrations that were run from a specific folder or from all folders.

You can also perform the following actions:

- Rerun migration on selected bots and view the history of each bot that has gone through multiple migrations.
- View the time when the bot was migrated using the time stamp.
- Get a summary count of bots that are successfully migrated, that failed to migrate, and those that require your review or action.
- Export a specific list of bots.
- View the version of the migrated bot.
- View the version history of the migrated bot (the check-in message indicates that the bot is migrated from legacy Enterprise 10 and Enterprise 11 version).

To view the updated status of the remigrated bot, you can refresh either the table or the screen, shown in the following

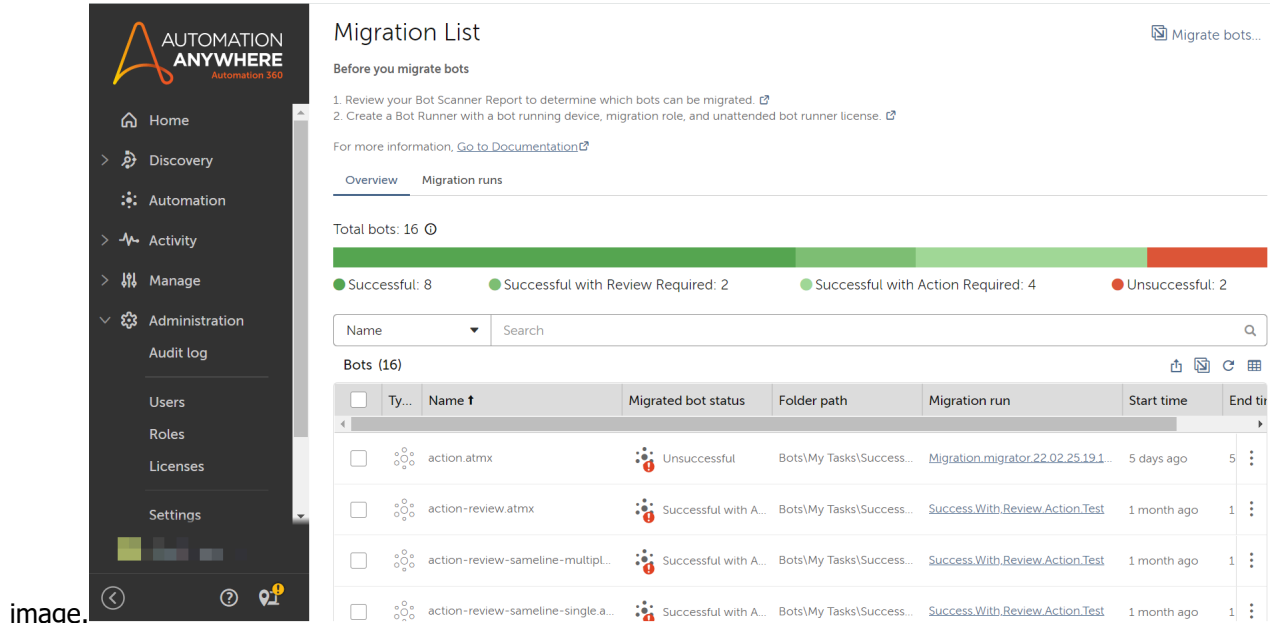

Watch the following video to learn how to convert Enterprise 11 or 10.x bots in .atmx and .mbot format to .bot format to Automation 360. You perform this task after you have replicated your Enterprise 11 or Enterprise 10 database and bots are available in Automation 360 Control Room.

Considerations when you migrate and validate bots

The migration process is designed to be seamless. Learn what to expect while you convert, validate, and migrate bots so that you can run your daily automated processes as usual.

Time taken for migration

Migration time will vary based on the number of bots in your Enterprise 11 or Enterprise 10 repository, the number of processes automated, and the number of Bot Runners and machines that are performing the migration. The time required to migrate varies based on your internal processes and requirements.

Note: After data is migrated from Enterprise 11 to Automation 360, ensure that the end-to-end migration activity is completed within 90 days from the first day of data migration. After 90 days, the Bot Insight analytical data will be deleted.

The following factors impact the time taken for migration:

- Number and complexity of bots
- Number of lines in a bot
- Control Room and Bot Agent configuration
- Current load on Control Room (indicated by the number of users connected to a Control Room at a specific time)

- Migration environment: whether migration is being performed on an isolated production or staging environment.

Migration in an isolated environment occurs faster.

- Whether the bots to be migrated are located in a single folder or are located across multiple folders

Bots present in a single folder are migrated faster.

- Hardware requirements of the device from where the migration is performed
- Network bandwidth

Migrating at your pace

The migration tools provide you with control over what to migrate and when to migrate. You can choose to migrate all of your bots at the same time or migrate a few bots at a time. During the transition period from Enterprise 11 or Enterprise 10 to Automation 360, you can continue to run bots on the previous platform as usual until your migration is complete.

Note: After the migration is completed, all new bots must be built on Automation 360. This will help you manage your bots and your organization to transition.

Zero downtime

Migration does not impact any scheduled bots or the ability to run bots as planned on Enterprise 11 or Enterprise 10 when you migrate data to Automation 360. As long as your infrastructure requirements are met according to your automation needs, and you run Enterprise 11 or Enterprise 10 and Automation 360 in parallel, there should be no pause in regular automation activities.

Running Enterprise 11 or Enterprise 10 and Automation 360 in parallel

During the transition period, we recommend that customers run automation on Enterprise 11 or Enterprise 10 until migrated bots are tested and running successfully on Automation 360. This is the best way to ensure zero downtime.

Migrate Enterprise bots

The bot migration process uses the Bot Migration Wizard to convert Enterprise 11 or Enterprise 10 bots (TaskBots and MetaBots) in `.atmx` and `.mbot` format to the `.bot` format used in Automation 360 and uploads the successfully migrated bots to the Control Room public workspace.

Ensure you have completed all the prerequisite tasks for migrating bots: [Prerequisite tasks for migrating bots](#).

All manual dependencies of bots are automatically converted as Control Room dependencies during migration. The **Copy Control Room file** action copies these dependencies from the Control Room to the respective locations.

1. Log in to your Automation 360 staging environment.
2. Click **Administration > Migration**.

Note: If you have migrated bots from Enterprise 10 to Enterprise 11, the information about that migration is not displayed on the **Migration List** page.

3. On the Bot Migration Wizard screen, click **Migrate bots**.

Migrate bots

Cancel Migrate bots

Settings

Name: Migration.admin.22.09.06.13.48.38
Maximum = 255 characters

Description (optional):
Maximum = 255 characters

Bot Migration settings

- Overwrite if a bot with the same name exists
- Exclude bot dependencies
If this option is selected, all the bot dependencies will be excluded while migrating.

Bot behaviour configuration

- Use "Excel Cell Row" legacy behavior
If you are migrating from 11.3.0 and below, we recommend selecting this option.
- EWS email server settings
If this option is selected, settings will be applicable to bots that contain email actions.
- Include web services settings
This allows you to migrate along with the web services proxy host and port. If this value is selected, pre-created global values will be available to the bot for connecting with web services proxy.
- Convert bots built using Internet Explorer to Edge with Internet Explorer mode
If you are migrating bots built on Internet Explorer, we recommend selecting this option to convert them to Edge with Internet Explorer mode.
- Convert \n characters to \r\n in 'Log to File' action
This allows you to convert \n characters(LF) into \r\n characters(CRLF), which automatically take new line in bots using Log to File action.

Bot Insight configuration

- Tag bots and variables for analytics
This allows you to tag bots and variables for analytics through Bot Insight. If you are not using Bot Insight in legacy bots, we recommend you not to select this option.

Next >

4. Select the options and configuration as required in the the **Settings** tab.

Option	Action
Name	Enter a migration name or use the default one. The default migration name shows the name of the user who is logged in, current date, and time stamp.
Description	Enter a description for the migration.
Overwrite if a bot with the same name exists	Select this option to overwrite an existing bot if a bot with the same name exists in the folder.
Exclude bot dependencies	Select this option to exclude child bots of sub-tasks from migration or updating. By selecting this flag, you can now choose to migrate parent and child bots separately or independently.
Use "Excel Cell Row" legacy behavior	Select this option if you are migrating from a version earlier than Version 11.3.0 or you want to retain the legacy behavior of the Excel Cell Row system variable.
Use outgoing Email server settings	Select this option if your bot contains the Send Email command. Use these settings to specify the type of email server to use.

Option	Action
EWS email server settings	<p>Select this option if you have used EWS in Enterprise 11. If you have selected this option, complete the following fields:</p> <ul style="list-style-type: none"> • Domain name: This field is prepopulated with the default global value. • Exchange version: Select an option from the list to specify the version of the EWS server configured in Enterprise 11. • Authentication type: Select an option from the list to specify the authentication type set for the EWS server configured in Enterprise 11.
Include web service settings	<p>Select this option for custom proxy configuration support. When you select this option, the REST commands with Custom proxy configurations that use the following global variables are migrated:</p> <ul style="list-style-type: none"> • <code>AAProxyHost</code> for Hostname • <code>AAProxyPort</code> for Port
Convert bots built using Internet Explorer to Edge with Internet Explorer mode	<p>Select this option if you want to migrate Enterprise 10 or Enterprise 11 bots that use Internet Explorer to Automation 360 bots that use Microsoft Edge with IE mode.</p>
Convert \n characters to \r\n in Log to File action	<p>Select this option to convert \n characters (LF) into \r\n characters (CRLF), which automatically take new line in migrated bots using Log to File action.</p>

Option	Action
<p>Tag bots and variables for analytics</p>	<p>Select this option when Bot Insight data exists in the Enterprise 11 bots, and you also want to migrate the Bot Insight data with those bots. When you select this option, the Bot Insight Open and Close actions are created.</p> <hr/> <p>Note: To migrate Bot Insight data, you must enable this option.</p> <hr/> <p>When you migrate Bot Insight data along with bot migration, ensure that the Bot Insight prerequisites are met. Bot Insight prerequisites Cloud Migration Utility prerequisites</p> <p>If the Bot Insight prerequisites are not met, Cloud migration with Bot Insight might become stuck in the In Progress state.</p> <p>Also, regardless of whether the Bot Insight and the Cloud Migration utility prerequisites are met or not, import or upload of the .atmx file > Migrate. This issue is observed on both On-Premises and Cloud deployments.</p>

5. Click **Next**.

6. Select the bots and the folders that contain the bots (TaskBots and MetaBots) that you want to migrate.

The ability to select a folder eliminates the effort required in selecting individual bots from that folder.

- If you selected a folder, all subfolders within that folder and the bots within these subfolders are automatically selected for migration.
- If the folder is empty, the migration process encounters an error.

The **Last Migrated** column indicates when the bot was migrated previously. N/A means the bot has not been migrated before.

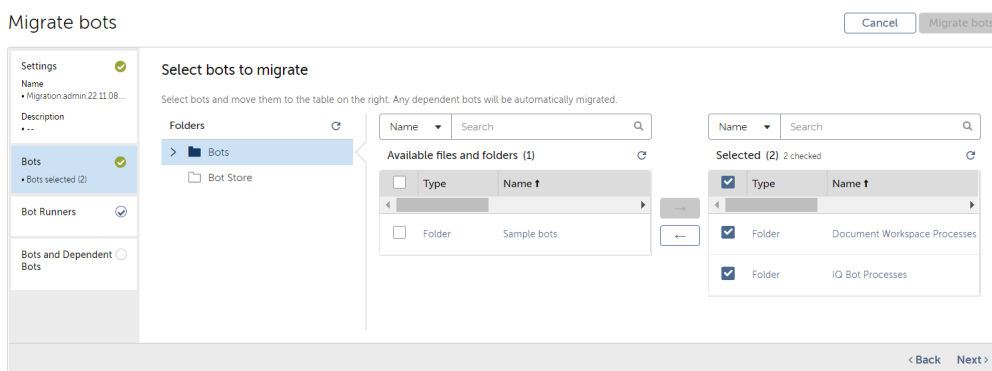

7. Click **Next**.

8. Select one or more usernames from the list to run the migration and click the right arrow.

Username can display either the message *Picked at run time* or the device name in the **Device** column. A device name indicates the registered device for that user. *Picked at run time* is shown when a user does not have a default device, for example, a user who has not registered a device and

a system administrator has assigned a device to that user. A default device must be configured for all Bot Runners you have selected.

- Bots are distributed across selected Bot Runner users in a round-robin method.
- The first Bot Runner user on the selected list is the first one used.
- A parent bot and its dependencies are assigned to a single Bot Runner user.

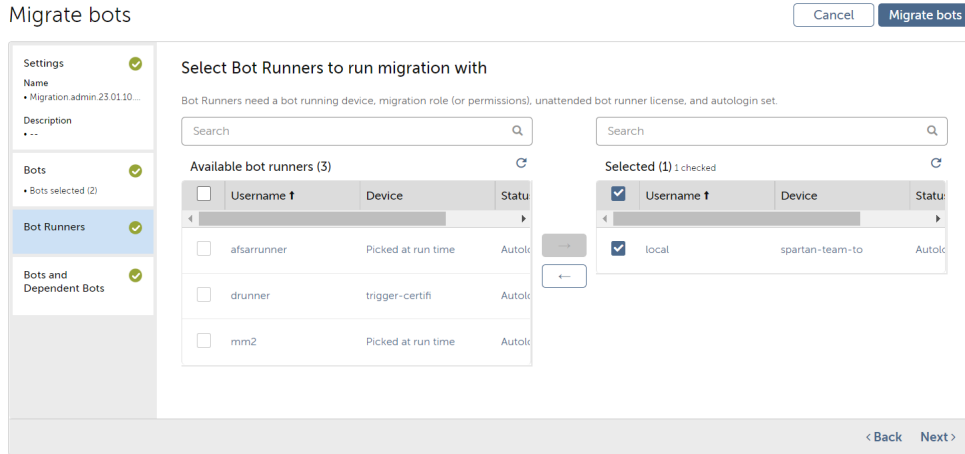

9. Click **Next**.

10. Optional: Review the dependent TaskBots and MetaBots on the **Bot and Dependent Bots** page before you migrate them.

If you have selected a folder and bots from the **Bots** page, that folder and dependencies of the selected bots are displayed in the table.

Dependent bots (TaskBots and MetaBots) are migrated before the primary bot.

The table shows the primary bot at the bottom and its dependencies above. For example, the following information means that `Sample05.atmx` has a dependency on `Sample04.atmx`, and `Sample04.atmx` has a dependency on `MessageBox.atmx` and `MetaTask.mbot`.

Type	Name	Path
MetaBot (mbot)	MetaTask.mbot	Bots\My Metabots \MetaTask.mbot
TaskBot (atmx)	MessageBox.atmx	Bots\MyTasks \MessageBox.atmx
TaskBot (atmx)	Sample04.atmx	Bots\MyTasks \Sample04.atmx
TaskBot (atmx)	Sample05.atmx	Bots\MyTasks \Sample05.atmx

11. Click **Migrate bots**.

The system validates whether the user who initiated the migration and the Bot Runner users selected have the required permissions to perform the migration. The system verifies whether all of the

following permissions are granted to the user performing the migration and the Bot Runners you have selected:

- User performing migration:
 - **View Migration** permission
 - **Manage Migration** permission
 - Permission on the folders containing the bots and MetaBots you want to migrate
 - A role that has access to Bot Runners that you want to select for running the migration (on the **Administration > Migration > Run As** page)
 - **View & edit ALL credentials attributes value** permission
- Bot Runners:
 - An unattended Bot Runner license
 - **Autologin Set** status
 - **Allow a bot-runner user to run migrations** permission
 - **Create standard attributes for a credential** permission
 - **Create folder** permission
 - **View package** permission
 - **Register device** permission
 - **View my bots** and **Run my bots** permissions
 - **Check-in** and **Check-out** permissions for the *My Tasks* and *My Metabots* folders in Automation 360
 - **Default device** settings

If any of the required permission is not granted, the system displays those permissions in the validation results. You must grant the required permissions and start the migration process again.

If all the required permissions are granted to the users, the system starts migrating the selected bots and their dependent bots.

After the migration, the system uploads successfully migrated bots, the associated Bot Insight data, and the published dashboards to the public workspace of the Automation 360 Control Room (in the

same folder in which the `.atmx` file is available). Only bot migrations initiated from the Control Room are stored in the public workspace.

Validation error details for each bot are displayed in the bot migration results. The error details include the line number, error details, and the reason and recommendation.

The Bot migration results display the number of bots migrated, along with their individual statuses. Click the **Status** column to filter bots with specific statuses for quick analysis.

In the **Reasons** column, click the **View Migration issues** option to see detailed reasons for the error. The **View Migration issues** dialog box displays the line number where the error occurred, a summary of the error, and a detailed error report for your review.

- a) Check out the bot to migrate the private dashboards associated with that bot.
The private dashboards are migrated only for the user who checked out the associated bot for the first time.
- b) View in-progress migration activities from the **Activity** > **In progress** page.

Status	Name	Type	Start time	End time	Duration
Successful	array_CS ISue	Bot migration	5 days ago	5 days ago	28 sec
Successful	Migration.migadmin_22.12.06.12	Bot migration	1 month ago	1 month ago	23 sec
Successful	Migration.migadmin_22.12.06.12	Bot migration	1 month ago	1 month ago	23 sec
Successful	Migration.migadmin_22.12.06.12	Bot migration	1 month ago	1 month ago	27 sec
Unsuccessful	Migration.migadmin_22.12.06.12	Bot migration	1 month ago	1 month ago	30 sec
Successful	Migration.shweta_22.12.02.16.4	Bot migration	1 month ago	1 month ago	1 min 1 sec
Successful	Migration.shweta_22.12.02.16.3	Bot migration	1 month ago	1 month ago	1 min 13 sec
Successful	Migration.shweta_22.12.02.16.2	Bot migration	1 month ago	1 month ago	1 min 3 sec
Unsuccessful	Migration.shweta_22.12.02.16.2	Bot migration	1 month ago	1 month ago	35 sec

See the following video on how to migrate Enterprise 11 or Enterprise 10 bots:

<https://fast.wistia.net/embed/iframe/aolyapmxbb>

See the following resources if you encounter errors during migration:

- [Migration error: Physical bot files aren't available \(A-People login required\)](#)
- [Migration error: Unable to download the source bot file for conversion \(A-People login required\)](#)
- [Migration shows unsuccessful by creating duplicate atmx files \(A-People login required\)](#)
- [Unable to migrate due to java.lang.StackOverflowError exception \(A-People login required\)](#)
- [Migration error: Unable to delete the file MigrationBot \(A-People login required\)](#)

[Verify the bot migration](#) | [View migration reports](#)

Related tasks

[View migration reports](#)

Use the reports to analyze the status of individual bot migration, data migration, and audit log migration and identify the status and summary of the individual migration.

[Export Enterprise 11 Bot Insight dashboards for migration](#)

Use the Bot Insight pre-migration utility to export your Enterprise 11 Bot Insight dashboard metadata (widgets and layouts) and dashboard profile as a zip file. Run this utility in your Enterprise 11 device and paste the zip file in the Automation 360 repository to migrate the Bot Insight dashboards.

How MetaBots are migrated

When you migrate a MetaBot to Automation 360, equivalent bots are created for the various logic available in the MetaBot, except for application screens. After successful migration, each logic in a .mbot file is converted to a TaskBot file.

A MetaBot contains assets and logic. Assets are the application screens or DLLs that are used to automate a task on an application. Logic is a set of commands to perform an operation and interact with other logic and bots.

Note:

- Before you migrate .atmx or .mbot using the Bot Migration Wizard, ensure that all the Logics, dlls, .mbots, .atmx files and other dependencies related to the MetaBots or TaskBots that were previously migrated are not in the **Checked-out** state. Otherwise, the following error occurs during re-migration:

```
Bot is not ready for migration.
```

The details of the unsuccessful migration are displayed in the **Bot Migration wizard > Results > Skipped** tab.

- If the bot that you are migrating has been checked out or has been migrated previously, ensure that the bot to be migrated is in the **Checked-in** state. Also, to reuse the migrated bot, in the Bot Migration Wizard, select the **Overwrite if a bot with same name exists** option. To use an updated bot, disable the **Overwrite if a bot with same name exists** option.

The migration process performs the following actions:

- Converts MetaBot logic to corresponding TaskBots.
- Maintains the folder structure of the MetaBots after it is migrated. The new folders created in Automation 360 contain the TaskBots for each logic migrated to Automation 360.
- Updates the TaskBots that use MetaBot logic to refer to the new TaskBots that are created for the migrated MetaBot logic.

You do not have to update the TaskBots manually.

Features such as use of DLLs, input and output variables, and **Execute** permission which were available only for MetaBots are now available for all TaskBots.

We will use the following MetaBot to explain how it is migrated to Automation 360:

- MetaBot name: MetaTask
- Assets:
 - Login screen
 - General.dll
 - DLL\Binary.dll

- Logic:
 - Common
 - Process1\Connect
 - Process1\Disconnect
 - Process1\Operations\Numeric

Benefits of reusable TaskBots in Automation 360

The following table lists the benefits of using reusable TaskBots in Automation 360 compared with MetaBots in Enterprise 11:

Automation 360 reusable TaskBots	v11 MetaBots
You can navigate to a child bot through fewer clicks using the Finder component, thus saving time. Navigate to Editor > Finder to reach the child bot.	You must navigate through the TaskBot > Run action to reach the child bot.
You can search the child bots from the private workspace as well as public workspace to use them in TaskBots.	You must download the MetaBots to the local repository to use a child bot in the TaskBots.
Only a specific Logic is deployed when it is used in a task, which saves time and bandwidth.	Entire MetaBot is deployed to the Bot Runner machine even if only one Logic is used in the Task.
Provides better RBAC, which enables you to customize permissions.	MetaBots forces all Logic to have the same permissions even if multiple Logic are spread across different folders.

MetaBot migration process

The system creates a folder with the same name as the MetaBot within the `My MetaBots` folder available in the `Bots` folder, and the same folder structure as Enterprise 11 is retained. For example, if the folder structure in Enterprise 11 is `Accounts/Tax/MetaTask.mbot`, the system retains the folder structure as `Accounts/Tax/MetaTask.mbot`. All the components of a MetaBot are stored in the folder created for that MetaBot. In this example, the system creates the `MetaTask` folder in the `Bots\My MetaBots` folder and stores all the components the MetaBot in that folder.

Enterprise 10 bots that directly call DLLs and screens in a MetaBot without using MetaBot logic are migrated to the equivalent TaskBots and actions in Automation 360. In Enterprise 10, if a DLL that returns a list or array type parameters and the output of that DLL is mapped with a value type parameter, an extra space is added at the start of the output value. The extra space is not added to the output value after the bot is migrated.

10.1 MetaBots that use DLL functions that accept one-dimensional array and list type input parameters and is mapped with the array type parameter. In such cases, row index and column index are required as input to specify the value to be returned. After migration, the row index is considered as column number.

Note: For bots that are upgraded from 10.1 to 10.3.5 and then migrated to Automation 360, the Bot Migration Wizard does not show the dependency on the **Bot and Dependent Bots** page. For such bots, you must migrate the MetaBots before migrating the TaskBots that are calling those MetaBots.

Migration of DLLs

The system does not maintain the folder structure for assets in order to maintain the references between the DLLs. For the above example, `General.dll` and `Binary.dll` are stored in the `MetaTask` folder although the `Binaary.dll` is stored in the `DLL` subfolder.

See the following video for information on migrating MetaBots with DLLs to Automation 360:

MetaBot migration process overview

Use the information provided in this section to understand the processes involved in migrating MetaBot to Automation 360.

Concept of DLL session in the migrated bot

The following DLL changes are observed in the migrated bot:

- When you migrate a TaskBot with multiple MetaBots that contain DLLs with the same name, a session name using the name of the first DLL is created. When the subsequent DLL with the same name from another MetaBot is migrated, the ID of the folder in which the DLL resides is used as a session name.

For example: `M_DLL_Session-
<MetabotFolderId>_<DLLName>`.

- When the **Execute DLL** command in Enterprise 11 is migrated to Automation 360, the command is converted to the **Open** and **Run function** actions and the **Dll Session does not exist** If condition.
- The DLL session name is created by appending the DLL name to the "M-DLL-Session-" token. For example, if the DLL name is *Sample.dll*, after migration, the DLL session name will be *M-DLL-Session-Sample*.
- The DLL session represents the DLL it is using to run the DLL functions.
- To run multiple functions from the same DLL, the same DLL session name must be provided in the **Session name** field.

Condition to check for the existence of a DLL session in a migrated bot

After migration, when the same DLL is used across multiple logics of the same MetaBot, a condition to check if a DLL session is already open is added for every DLL to ensure that the DLL session is opened only once. Some DLLs that are used in MetaBot share sessions or global variables across multiple DLL functions. If such DLL functions are called from different logics, sharing of such sessions and variables is possible only if the DLL session is opened only once and a condition is added to check if a DLL session is already available. If a DLL

session is missing, Automation 360 creates a DLL session of type **Global**.

What happens to a migrated TaskBot that has reference to two DLL functions from same or different logics of a MetaBot?

In Enterprise 11, if a TaskBot was referencing to a logic that called two functions using the **Run Logic** command, in Automation 360, a DLL session will be created in the TaskBot (logics are migrated as TaskBots) and will be used in the **Run function** action. Also, when a TaskBot refers multiple logics that calls multiple functions, the TaskBots will use the same DLL session name to execute the functions. The DLL session condition check will ensure that only one session is created across such logics.

For example, if a TaskBot is using MetaBot1 Logic and MetaBot2 Logic where MetaBot1 Logic and MetaBot2 Logic are calling multiple functions, when you run the Taskbot, a DLL session name is created to run MetaBot1 Logic. The DLL session name that was created to run MetaBot1 Logic will be used to run MetaBot2 Logic as well.

Migration of screens

Each screen in a MetaBot is converted to a windows variable and the actions performed on the screen are migrated to the equivalent actions in Automation 360.

The following table lists the screens that can be migrated to Automation 360:

Browser	Internet Explorer Google Chrome (for object play type only)
Screen type	Standard
Technology	Java, HTML, MSAA, .Net, UI Automation (for object play type only)
Play type	Object, Image, Coordinate

You can also migrate MetaBots with screens that are captured in the Citrix environment from applications that are based on Java, UI Automation, and MSAA technologies.

The linked objects on a MetaBot screen that are captured using the object play type are migrated to the **Capture** action of the Recorder package. The source object is displayed in the **Main** tab and the linked object is displayed in the **Anchor** tab of the **Capture** action.

The following table provides information about the actions that are performed on an object play type object and text play type linked object available on the screen is migrated to the equivalent actions in Automation 360:

Play type	Enterprise 11 Action	Automation 360 Action
Object	Get Property, Get Total Items, Get Selected Index, Get Selected Text, Select Item by Text, Select Item by Index, Click, Left Click, Right Click, Double Click, Set Text, Append Text, Get Property, Check, Uncheck, Toggle, Expand, Select, Get Status,	<p>Migrated to the Capture action of the Recorder package.</p> <p>The GetAllChildrenName and GetAllChildrenValue commands in Enterprise 11/Enterprise 10 return string type variable values. In Automation 360, they return list values. The migration process joins the list values and stores them into a string variable to maintain consistent bot behaviors across releases.</p> <p>The Object Cloning command with the Export to CSV action in Enterprise 11/Enterprise 10 is migrated to:</p> <ul style="list-style-type: none"> The Capture action of the Recorder package. This action saves the captured data into a table variable. The Write to file action of the Data Table package. This action saves the data from the table variable to the CSV file.

The following table provides information about the actions that are performed on an image play type object image play type linked object available on the screen is migrated to the equivalent actions in Automation 360:

Play type	Enterprise 11 Action	Automation 360 Action
Image	Left Click	Migrated to the Find window in window action of the Image Recognition package with the Left Click selected from the Action list.
	Right Click	Migrated to the Find window in window action of the Image Recognition package with the Right Click selected from the Action list.
	Double Click	Migrated to the Find window in window action of the Image Recognition package with the Double Click selected from the Action list.
	Middle Click	Migrated to the Find window in window action of the Image Recognition package with the Left Click selected from the Action list.
	Set Text	<p>Migrated to:</p> <ul style="list-style-type: none"> The Find window in window action of the Image Recognition package with the Left Click selected from the Action list. The Delay action of the Delay package with the Regular delay set to 500 milliseconds. The Simulate keystrokes action of the Simulate keystrokes package.

Play type	Enterprise 11 Action	Automation 360 Action
	Get Text	Migrated to the Capture area action of the OCR package.
	GetVisibility	Migrated to IF action with condition Image Recognition: Find Window in window . The GetVisibility action returns a True or False value based on whether the object in an image is visible or not. Similarly, the condition within the IF action is evaluated based on whether the window is found in another window. The result is stored in a temporary variable.

The following table provides information about the actions that are performed on a coordinate play type object coordinate play type linked object available on the screen is migrated to the equivalent actions in Automation 360:

Play type	Enterprise 11 Action	Automation 360 Action
Coordinate	Click	Migrated to the Click action of the Mouse package with the Left Button and Click options selected.
	Left Click	Migrated to the Click action of the Mouse package with the Left Button and Click options selected.
	Right Click	Migrated to the Click action of the Mouse package with the Right Button and Click options selected.
	Middle Click	Migrated to the Click action of the Mouse package with the Middle Button and Click options selected.
	Double Click	Migrated to the Click action of the Mouse package with the Left Button and Double click options selected.
	Set text	Migrated to: <ul style="list-style-type: none"> • The Click action of the Mouse package with the Left Button and Click options selected. • The Delay action of the Delay package with the Regular delay set to 500 milliseconds. • The Simulate keystrokes action of the Simulate keystrokes package.

Play type	Enterprise 11 Action	Automation 360 Action
	Get text	Migrated to: <ul style="list-style-type: none"> • The Click action of the Mouse package with the Left Button and Click options selected. • The Clear action of the Clipboard package. • The Delay action of the Delay package with the Regular delay set to 500 milliseconds. • The Simulate keystrokes action of the Simulate keystrokes package. • The Delay action of the Delay package with the Regular delay set to 500 milliseconds. • The Copy to action of the Clipboard package.

The following table provides information about actions that are performed on a coordinate play type custom object available on the screen that is migrated to equivalent actions in Automation 360:

Play type	Enterprise 11 action	Automation 360 action
Coordinate	Click	Migrated to the Click action of the Mouse package with the Left Button and Click options selected.
	Left Click	Migrated to the Click action of the Mouse package with the Left Button and Click options selected.
	Middle Click	Migrated to the Click action of the Mouse package with the Middle Button and Click options selected.
	Double Click	Migrated to the Click action of the Mouse package with the Left Button and Double click options selected.
	Set text	Migrated to the following: <ul style="list-style-type: none"> • The Click action of the Mouse package with the Left Button and Click options selected. • The Delay action of the Delay package with the Regular delay set to 500 milliseconds. • The Simulate keystrokes action of the Simulate keystrokes package.
	Get text	Migrated to the following: <ul style="list-style-type: none"> • The Click action of the Mouse package with the Left Button and Click options selected. • The Clear action of the Clipboard package. • The Delay action of the Delay package with Regular delay set to 500 milliseconds. • The Simulate keystrokes action of the Simulate keystrokes package. • The Delay action of the Delay package with Regular delay set to 500 milliseconds. • The Copy to action of the Clipboard package.

The following table provides information about actions that are performed on a text play type custom object available on the screen that is migrated to equivalent actions in Automation 360:

Play type	Enterprise 11 action	Automation 360 action
Text	Click	Migrated to the Find window in window action of the Image Recognition package with Left Click selected from the Action list.
	Left Click	Migrated to the Find window in window action of the Image Recognition package with Left Click selected from the Action list.
	Double Click	Migrated to the Find window in window action of the Image Recognition package with Double Click selected from the Action list.
	Set text	Migrated to the following: <ul style="list-style-type: none"> The Find window in window action of the Image Recognition package with Left Click selected from the Action list. The Delay action of the Delay package with Regular delay set to 500 milliseconds. The Simulate keystrokes action of the Simulate keystrokes package.
	Get text	Migrated to the Capture area action of the OCR package.

Migration of logic

Each logic in a MetaBot is converted to a TaskBot and each command used in a logic is converted to the equivalent action in Automation 360. The variable used in a logic is converted to an equivalent variable in Automation 360. Credential variables used in the logic are migrated to Automation 360 and used in the equivalent actions in the migrated bots. If the **Parameter Type** of a variable is input or output, the same is maintained after that variable is migrated to Automation 360. For example, if the **Parameter Type** of the variable ABC is set as **Input**, the variable ABC created in Automation 360 has the **Use as input** option selected after it is migrated. The system retains the internal folder structure of the logics. For the above example, all the migrated logics are stored as listed in the following table:

Folder structure in Automation 360	Entry
MetaTask	Common
MetaTask\Process1	Connect
MetaTask\Process1	Disconnect
MetaTask\Process1\Operations	Numeric

The following table provides information about how the Import DataSet command used in the MetaBot logic is migrated to the equivalent actions in Automation 360:

Play type	Enterprise 11 Action	Automation 360 Action
Object	Get Property, Get Total Items, Get Selected Index, Get Selected Text, Select Item by Text, Select Item by Index, Click, Left Click, Right Click, Double Click	Migrated to the Capture action of the Recorder package.
Image	Left Click	Migrated to the Find window in window action of the Image Recognition package with the Left Click selected from the Action list.
	Right Click	Migrated to the Find window in window action of the Image Recognition package with the Right Click selected from the Action list.
	Double Click	Migrated to the Find window in window action of the Image Recognition package with the Double Click selected from the Action list.
	Middle Click	Migrated to the Find window in window action of the Image Recognition package with the Left Click selected from the Action list.
	Set Text	Migrated to: <ul style="list-style-type: none"> The Find window in window action of the Image Recognition package with the Left Click selected from the Action list. The Delay action of the Delay package with the Regular delay set to 500 milliseconds. The Simulate keystrokes action of the Simulate keystrokes package.
Coordinate	Click	Migrated to the Click action of the Mouse package with the Left Button and Click options selected.
	Left Click	Migrated to the Click action of the Mouse package with the Left Button and Click options selected.
	Middle Click	Migrated to the Click action of the Mouse package with the Middle Button and Click options selected.
	Double Click	Migrated to the Click action of the Mouse package with the Left Button and Double click options selected.
	Set text	Migrated to: <ul style="list-style-type: none"> The Click action of the Mouse package with the Left Button and Click options selected. The Delay action of the Delay package with the Regular delay set to 500 milliseconds. The Simulate keystrokes action of the Simulate keystrokes package.

The following table provides information about how the Export Dataset command used in the MetaBot logic is migrated to the equivalent actions in Automation 360:

Play type	Enterprise 11 Action	Automation 360 Action
Object	Get Property, Get Total Items, Get Selected Index, Get Selected Text, Select Item by Text, Select Item by Index, Click, Left Click, Right Click, Double Click	Migrated to the Capture action of the Recorder package.
Image	Left Click	Migrated to the Find window in window action of the Image Recognition package with the Left Click selected from the Action list.
	Right Click	Migrated to the Find window in window action of the Image Recognition package with the Right Click selected from the Action list.
	Double Click	Migrated to the Find window in window action of the Image Recognition package with the Double Click selected from the Action list.
	Middle Click	Migrated to the Find window in window action of the Image Recognition package with the Left Click selected from the Action list.
	Get Text	Migrated to the Capture area action of the OCR package.
Coordinate	Click	Migrated to the Click action of the Mouse package with the Left Button and Click options selected.
	Left Click	Migrated to the Click action of the Mouse package with the Left Button and Click options selected.
	Middle Click	Migrated to the Click action of the Mouse package with the Middle Button and Click options selected.
	Double Click	Migrated to the Click action of the Mouse package with the Left Button and Double click options selected.
	Get text	Migrated to: <ul style="list-style-type: none"> • The Click action of the Mouse package with the Left Button and Click options selected. • The Clear action of the Clipboard package. • The Delay action of the Delay package with the Regular delay set to 500 milliseconds. • The Simulate keystrokes action of the Simulate keystrokes package. • The Delay action of the Delay package with the Regular delay set to 500 milliseconds. • The Copy to action of the Clipboard package.

Migration of Run Logic command

The **Run Logic** command is used in a bot to run a specific logic from a MetaBot in Enterprise 11. When you migrate that bot, the **Run Logic** command is converted to the **Run** action of the Task Bot package.

The input variables are converted to equivalent variables in Automation 360 and the output variables are migrated to a dictionary variable. You use the key in the dictionary variable to use the associated value. The dictionary variable might contain other variable types, for example, list, value, integer, and array. You can map the variables available in the dictionary variable with other variable types. For example, you can map the list type variable available in the dictionary variable with the list, value, and array type variables.

Migration of Execute command

The DLLs in the MetaBots use the **Execute** command to run a function from that DLL. After migration to Automation 360, each **Execute** command is converted to **Open**, **Run function**, and **Close** actions of the **DLL** package. Information about which function to run from the DLL, which parameters to use, and other details in the **Execute** command is migrated to the **Run** action.

Starting from Enterprise A2019.16 (6448), you can migrate MetaBots that contain DLLs whose return types are different from that of the MetaBot. The following table provides information about the variable type of the output of the MetaBot and the return type of a DLL.

MetaBot variable type	DLL function return type
Value	Two-dimensional array, List, Byte in array (Byte[]), unsigned integers (UInt32, UInt64), signed integers, IDictionary, IList, and unsigned integers in array (UInt16[], UInt32[], UInt64[]), signed Byte
Array	Two-dimensional array, List, unsigned integers (UInt16[], UInt32, UInt64), signed integers, IList, signed Byte and IDictionary

Note: The migration of bots that uses IDictionary variable is supported, however, the migrated bots might not return the correct value. This behavior is same as in Enterprise 11 or Enterprise 10.

The following table provides information about the variable type that is passed from the MetaBot and the input type a DLL accepts.

Variable type of MetaBot	Input variable type the DLL accepts
List	Two-dimensional array, list, byte, unsigned integers (UInt16, UInt32, UInt64), signed integers, signed Byte, byte in array (Byte[]), and unsigned integers in array (UInt16[], UInt32[], UInt64[])
Array	Two-dimensional array, list, byte, unsigned integers (UInt16, UInt32, UInt64), signed integers, signed Byte, byte in array (Byte[]), and unsigned integers in array (UInt16[], UInt32[], UInt64[])
Value	Byte, unsigned integers (UInt16, UInt32, UInt64), signed integers, signed Byte

Variable type of MetaBot	Input variable type the DLL accepts
Dictionary	Byte, unsigned integers (UInt16, UInt32, UInt64), signed integers, signed Byte

How AAApplicationPath variable is migrated

The AAApplicationPath variable is used in Enterprise 11 and Enterprise 10 to specify the physical path of a bot or file that is used in the current bot. The AAApplicationPath system variable returns the path that is set in **Tool > Option** of what is known as the “client application”.

Migrating from Enterprise 11 using restored Enterprise 11 database

When you migrate to Automation 360 using a restored Enterprise 11 database, the migration process performs the following actions:

- Creates the AAApplicationPath global value when the first bot is migrated using the Bot Migration Wizard.
- Copies the value for the AAApplicationPath system variable specified for each user in Enterprise 11 and sets that value to the AAApplicationPath global value for all these users in Automation 360.
- Updates references you have used in Enterprise 11 bots with the **AAApplicationPath** global value available in the Automation 360 Control Room, eliminating any requirement to update the migrated bots to use the AAApplicationPath.
- Updates the path in the **Run Task** command set in the Enterprise 11 bot. For example, if the path in the **Run Task** command is set to `$AAApplicationPath$\Automation Anywhere\My Tasks\child-task.atmx` in Enterprise 11, this path is automatically converted to `Bots\My Tasks\child-task.atmx` after migration.

Therefore, no manual update is required and the bot runs as is after migration.

Important: When you migrate bots using the Bot Migration package, you must manually create the AAApplicationPath global value. After you have created the AAApplicationPath global value, all users who have used the AAApplicationPath system variable in Enterprise 11 must update the AAApplicationPath global value with the value that is used in Enterprise 11.

See [Migrate from Enterprise 11 using a restored Enterprise 11 database](#).

Migrating from Enterprise 10

When you migrate from Enterprise 10, you must manually create the **AAApplicationPath** global value in Automation 360 with the **CAN be changed** option selected. After you have created the AAApplicationPath global value, all users who have used the AAApplicationPath system variable in Enterprise 10 must update the AAApplicationPath global value with the value that is used in Enterprise 10. This update ensures that when you run the bot in Automation 360, the **AAApplicationPath** folder value is uniquely resolved for each user.

Example: If the Enterprise 10 path value for **AAApplicationPath** is `D:\John.Doe\My Documents\Automation Anywhere Files`, then you must create the **AAApplicationPath** global value in Automation 360 and update with this path.

Note: Bot Runners and Bot Creators must update the global value for the **AAApplicationPath** in the Control Room before they run migrated bots in Automation 360.

See [Prepare for Enterprise 10 to Automation 360 On-Premises migration](#).

Manually migrating from Enterprise 11 or Enterprise 10

When you manually migrate from Enterprise 11 or Enterprise 10, you must manually create the AAApplicationPath global value in Automation 360 with the **CAN be changed** option selected. After you have created the AAApplicationPath global value, all users who have used the AAApplicationPath system variable in Enterprise 11 or Enterprise 10 must update the AAApplicationPath global value with the value that is used in Enterprise 11 or Enterprise 10.

See [Prerequisites for manual migration](#).

AASettings supported in Automation 360

Review the configurations supported in the AASettings file for the Control Room.

After migration, you can configure the AASettings that are supported in Automation 360.

Key	Description	Values allowed	Default value	Supported in Automation 360
allowaddingdefaultnamespace	<p>This parameter is used to enable DefaultNSPrefix. In the XML package, when you insert a node into the XML file, DefaultNSPrefix is no longer added. In the Advanced view tab of the insert a node action, xmlns (the default XML namespace) is not allowed either as a prefix or as an attribute.</p> <hr/> <p>Note: If DefaultNSPrefix is enabled and the value of allowaddingdefaultnamespace is set to True, when you insert or update a new node as an empty node, a newline character will be added and indentation will be lost.</p> <hr/>	True, False	False	No

Key	Description	Values allowed	Default value	Supported in Automation 360
allowlowersecuritycipher	Allows you to lower the security cipher for connecting to mainframe hosts that use SSL connections with lower security cipher.	True, False	False	No
applyshiftkeyfix	Allows you to check for any missing special key in child bots and executes the key if the special key is missing.	0, 1	0	No
capturehtmlwithjs	Allows you to enable capturing HTML by MetaBot screen capture.	True, False	True	No
citrixchanneltimeout	Allows you to set the Citrix channel timeout value for the Citrix remote agent.	Integer	--	No
closebrowserbyhandle	Allows you to enable CloseIEInstanceByhandle if CloseIEInstanceByprocess fails.	0, 1	0	No
connectionretryattempts	Allows you to configure the number of attempts to try for connecting to the mainframe if connection to the mainframe failed.	Integer	3	No
connectionretryinterval	Allows you to configure the timeout value, in milliseconds, to wait before attempting the next connection.	Integer	3000	No

Key	Description	Values allowed	Default value	Supported in Automation 360
connectiontimeout	Allows you to configure the timeout value, in minutes, for database connections. We recommend that you configure this timeout value to 30 minutes.	Integer	30	No
CustomDateFormat	Allows you to set a custom date format.	String (mm/dd/yyyy HH:mm:ss)	--	No
DecimalPlaces	Allows you to configure the number of decimal places for digits used in the Number element.	Integer from 0 to 16	4	No
enablesetfocusapi	Allows you to configure the SetFocus API for Oracle applications.	True, False	False	No
fetchemailretrycount	Allows you to configure the number of retries for fetching emails.	Integer	3	No
findiewndattmpt	Allows you to use the MetaBot recorder to search for objects.	Integer	5	No
ietimeoutvalue	Allows you to configure the timeout value for capturing MetaBot screens.	Integer	240	No
IETimeoutValue	Allows you to configure the maximum timeout value, in seconds, for loading a webpage on Internet Explorer.	Integer	240	No

Key	Description	Values allowed	Default value	Supported in Automation 360
IsEnabled	Allows you to check whether the decimal places option in the Number element is enabled or disabled.	True, False	False	No
isremoteobjectdetected	Allows you to enable automation of Citrix XenApp through the Enterprise Client.	True, False	False	No
iterationtoverify	Allows you to configure the number of retries to verify a value in a cell.	Integer	3	No
keystrokedelay	Allows you to configure a delay between the up and down keys in an Excel table.	Integer	25	No
legacybehaviourforcomma	Allows you to retain the legacy behavior for the comma sign.	True, False	True	No
multithreadlogic	Allows you to enable or disable multithreading.	0, 1	1	No
NormalizationForm	Allows you to verify whether string normalization is available.	NFC, NFD, NFKC, NFKD	--	No
ParallelThreadCount	Allows you to configure the number of links that can be processed at a time.	Integer	10	No
perchardelay	Allows you to configure the delay between entering two characters as input.	Integer	0	No

Key	Description	Values allowed	Default value	Supported in Automation 360
percommanddelay	Allows you to configure the delay between running keystroke commands.	Integer	0	No
readvirtualproperty	Allows you to enable the GetvirtualAccessibleName API.	True, False	True	No
readwithsystemencoding	Allows you to configure the default encoding for the system.	True, False	True	No
restclienttype	Allows you to execute REST Web Service.	restsharpclient, nativerestclient	restsharpclient	No
retainexcelcellrowlegacybehavior	Allows you to revert the behavior of ExcelCellRow to Enterprise 11 version 11.3.1 or earlier.	True, False	False	No
screenchangewaittime	Allows you to configure the timeout value, in milliseconds, to wait for the application after sending certain keys because the screen might change after sending some keys.	Integer	5	No
searchinmultiplewindows	Allows you to check for windows with the same name.	0, 1	0	No
ShutDownTimeout	Allows you to configure the timeout value for the Shutdown action in the System package.	Integer	30000	No

Key	Description	Values allowed	Default value	Supported in Automation 360
skipappnames	Allows you to check whether the application is Oracle.	Comma-separated application starting name. For example, if the application window title is Test Application , then it should contain the following value: Test,abc,xyz	--	No
textplayirpercentage	Allows you to configure the match percentage of the image recognition based control finding in the legacy AISense Recorder.	Integer from 0 to 100	95	No
timeout	Allows you to configure the HTTP request timeout value for the REST Web Service command.	String	60000	No
Timeout	Allows you to configure the timeout value for each web response while traversing through webpages.	Integer	10	No
usesinglethreading	Allows you to enable or disable single threading.	True, False	True	No
version	Allows you to select multiple versions of keystroke commands in Enterprise 11.	Integer	1	No
WaitForPageLoad	Allows you to configure additional delay for loading webpages in MetaBot and Recorder.	0, 1	0	No

Key	Description	Values allowed	Default value	Supported in Automation 360
WaitForWindow	Allows you to configure the wait time for window.	Integer	30	No
WaitForWindowCheck	Allows you to check whether the wait time for window is enabled.	0, 1	0	No
windowactivationmode	Allows you to activate Window using a None key.	0, 1, 2	0	No
windowresize	Allows you to disable the resizing of window during execution.	True, False	True	No

Enable schedules after migration

When you copy Enterprise 10 data to Automation 360, the Enterprise 10 schedules are migrated. Version Enterprise 11 schedules are migrated when you update the Enterprise 11 data to Automation 360.

After you migrate a bot associated with a schedule, the system automatically replaces the .atmx bot within that schedule with the Automation 360 bot. Migrated schedules are inactive and do not have associated devices, so some dependencies must be remapped in the Automation 360 environment.

To reenable migrated schedules, follow these steps:

1. Confirm that the bot linked to the schedule has been successfully migrated.
Migrated schedules only point to successfully migrated bots. If a bot migration fails, then the associated schedule continues pointing to the .atmx bot.
2. Install the Bot Agent on your Bot Runner devices.
[Install Bot Agent and register device](#)
3. Edit the schedule to add relevant devices.
[Schedule a bot](#)
4. Enable the schedule by clicking **Enable** after you have provided the required information for scheduling a bot.
[Schedule a bot](#)

Related concepts

[Migrate to Automation 360](#)

Related tasks

[Copy Enterprise 10 data](#)

You must copy the Enterprise 10 data to Automation 360 before you convert the Enterprise 10 bots.

[Copy and paste Enterprise 11 information to Automation 360](#)

The Enterprise 11 server repository files and the Credential Vault file are required in the Automation 360 environment. The most efficient way to get this data is to copy it from the Enterprise 11 environment into Automation 360.

[Migrate Enterprise bots](#)

The bot migration process uses the Bot Migration Wizard to convert Enterprise 11 or Enterprise 10 bots (TaskBots and MetaBots) in `.atmx` and `.mbot` format to the `.bot` format used in Automation 360 and uploads the successfully migrated bots to the Control Room public workspace.

Pause and resume bot migration

You can pause and then resume the paused bot migration. You might want to pause a bot migration if you want to perform a high-priority task on the same Bot Runner device on which the bot migration is running.

You must have the required permissions to start bot migration.

- Pause and resume bot migration when only one Bot Runner is used for bot conversion:
 - a) Select the active bot migration you want to pause from the **Activity > In progress** page.
 - b) Click the pause icon in the bot Launcher or on the **In progress** page.
The system pauses the bot migration. The status of bot migration is listed on the following:
 - The **Activity > In progress** page and marked as paused.
 - The bot migration on the **Administration > Migrations** page, where the status is displayed as paused.
 - The **Bot migration report** tab, where the status of the bot that was being converted and the bot migration that was paused is set as paused. The status of all other bots that were not converted is set as pending.
 - c) Select the paused bot migration that you want to resume from the **Activity > In progress** page.
 - d) Click the resume icon in the bot Launcher or on the **In progress** page.
The system resumes the paused bot migration. The details status of the resumed bot migration is available on the following:
 - The **Activity > In progress** page where the status is marked as active.
 - The **Administration > Migrations** page where the status is marked as in progress.
 - The **Bot migration report** tab, where the status of the bot that was being converted and the bot migration was paused is set as in progress.

- Pause and resume bot migration on some of the Bot Runners when multiple Bot Runners are used for bot conversion:
 - a) Select the active bot migration you want to pause from the **Activity > In progress** page.
 - b) Click the pause icon on the toolbar to pause the selected migration processes.
The system pauses the selected migration processes that were running on various Bot Runners. The status of the paused bot migration is displayed on the **Activity > In progress** page and marked as paused.

There is no change in the status of the bot migration on the **Administration > Migrations** page and on the **Bot migration report** tab.
 - c) Select the paused bot migrations you want to resume from the **Activity > In progress** page.
 - d) Click the resume icon on the toolbar to resume the selected paused bot migration.
The system resumes the bot migration for the selected Bot Runners. The status of Bot Runners for which the bot migration is resumed is displayed on the **Activity > In progress** page and marked as active.

The status of the bot migration on the **Administration > Migrations** page is displayed as in progress.

- Pause a bot migration for all Bot Runners when multiple Bot Runners are used for bot conversion.
 - a) Select all the active bot migration you want to pause from the **Activity > In progress** page.
 - b) Click the pause icon on the toolbar to pause the selected bot migration.
The system pauses the selected bot migrations that were running on various Bot Runners. The entry for all the paused migration processes is available on the following:
 - The **Activity > In progress** page and marked as paused.
 - The **Administration > Migrations** page where it is displayed as paused.
 - The **Bot migration report** tab, where the status of the bots for which migration has not started is set as paused.
 - c) Select all the paused bot migration you want to resume from the **Activity > In progress** page.
 - d) Click the resume icon in the bot Launcher or on the **In progress** page for all Bot Runners.
The system resumes the paused the bot migration. The status for all the Bot Runners is available on the following:
 - The **Activity > In progress** page and marked as active.
 - The **Administration > Migrations** page where it is displayed as in progress.
 - The **Bot migration report** tab, where the status of the bot that was being converted and the bot migration was paused is set as in progress.

Stop bot migration

You can stop an in-progress bot migration if that bot migration is not progressing or is not responding.

You must have the required permissions to start bot migration.

1. Select the active bot migration that you want to stop from the **Activity > In progress** page.
2. Click the stop icon in the bot Launcher or on the **In progress** page.
The system immediately terminates the bot migration. The status of the stopped bot migration is listed on the following:
 - The **Activity > Historical** page and marked as failed.
 - The **Administration > Migrations** page, where it is displayed as unsuccessful.
 - The **Bot migration report** tab, where the status of the bot that was being converted and the migration process that was stopped is set as unsuccessful. The status of all other bots that were not converted is set as pending.
 - The **View historical activity** page for the entry shows the reason for the failure.

Validating and updating bots after migration

Migrated bots are uploaded to the public repository of the Automation 360 Control Room (in the same folder containing the equivalent .atmx files). You can review the current status of the migrated bots and any errors encountered due to unsupported commands or attributes available in those bots from the **Migration List** page.

It is important that you review, test, and verify all migrated bots to ensure that they run successfully in the Automation 360 environment.

The migration assistant is merged with the error assistant to provide a comprehensive view of all the lines in a bot that require review or action by you, or which have errors in these and therefore require you to address them. This feature helps you to quickly identify the areas of bots that require your

attention. Before testing any bot, scroll through the entire migrated bot from the first to last line so that the Migration Assistant flags any issues.

If you do not review the entire bot, you might see a `failed to compile` error.

Updating your bots

If a bot requires any modifications based on the migration reports or testing phase, you can edit the bot:

1. Check out the bot from the public repository into a private repository.
2. Use the Migration Assistant to view changes to migrated bots.

The Migration Assistant will guide you for any required changes and provide opportunities to leverage new Automation 360 features.

3. Edit the bot in the Bot editor if required.

You can run the bot directly from the Bot editor as you modify your bot and test the process steps.

Perform these steps in your Development (DEV) environment. After the migrated bots clear your preset pass criteria, move them to the User Acceptance Testing (UAT) environment to test the bots against production-like systems with larger datasets.

Only when the bot clears the UAT requirements should you deploy it in a Production (PROD) environment. This process is part of the typical industry standard software development lifecycle (SDLC) best practices.

Moving bots using Bot Lifecycle Management

Use Bot Lifecycle Management to move bots from one environment to another. After you have tested and successfully run the migrated bots in the development (DEV) environment, you can use Bot Lifecycle Management to move the bots from the development environment to the UAT environment. Similarly, you use Bot Lifecycle Management to move the bots from the UAT production (PROD) environment.

When you move bots, if the following error occurs "Can't create directory: <directory name>", see [Unable to import or export the bots from v11 to Automation 360 \(A-People login required\)](#).

Bot compatibility version

After migration, if you remove the `AAApplicationPath` from the destination path and the bot compatibility version is set to **1**, the bot deployment fails. This occurs because in version 1 the file path is parsed during compilation time. Depending on the Control Room device (Linux or Windows), the file or folder paths might differ causing an error when this path is parsed during bot compilation time.

Recommendation: Change the bot compatibility version to **2**. In this version, the file path is parsed during bot runtime depending on the device on which the bot runs.

See the following video on how to validate changes made to migrated bots:

<https://fast.wistia.net/embed/iframe/lhqt2v23lz>

Related reference

[Package mapping for migration](#)

This page contains information about Enterprise 10 and Enterprise 11 commands and how they map to respective Automation 360 actions or packages. In some cases, an Enterprise 10 or Enterprise 11

command migrates to more than one Automation 360 action. This is to ensure that the behavior of the migrated bot is unchanged.

[Variable mapping for migration](#)

In migration, some variables map directly from previous product versions to Automation 360 while others behave differently or contain configuration changes.

Package mapping for migration

This page contains information about Enterprise 10 and Enterprise 11 commands and how they map to respective Automation 360 actions or packages. In some cases, an Enterprise 10 or Enterprise 11 command migrates to more than one Automation 360 action. This is to ensure that the behavior of the migrated bot is unchanged.

Automation 360 has a new package called **Legacy automation**. This package provides the additional support needed during migration. The **Legacy automation** package is for use during migration only; we do **not** recommend using this package for new bot development. [Legacy Automation package](#)

You can migrate bots when the user doing the migration is using an authenticated proxy server.

Note: For a list of packages and actions that support migration and conversion of Internet Explorer bots from Enterprise 11 or Enterprise 10 to Automation 360 with **Edge with IE mode**, see [Packages and Actions](#).

Active Directory

Respective **Active Directory** commands are migrated within the **Connect** and **Disconnect** actions. Each command is migrated as follows:

Enterprise 11 or Enterprise 10 commands	Equivalent Automation 360 actions and packages
Create user	Create user
Modify group command with the Rename group option selected	Rename group
Modify group command with the Delete group option selected	Delete group
Modify group command with the Add users to group option selected	Add users to group
Modify group command with the Remove users from group option selected	Remove users from group
Modify group command with the Set property option selected	Set group property
Modify group command with the Disable user account option selected	Disable user account
Modify group command with the Update user details option selected	Update user details
Modify user command with the Rename user option selected	Rename user
Modify user command with the Delete user option selected	Delete user

Enterprise 11 or Enterprise 10 commands	Equivalent Automation 360 actions and packages
Modify user command with the Enable user account option selected	Enable user account
Modify user command with the Update Account Options option selected	Update account options
Modify user command with the Change Password option selected	Change Password
Create object command with the Computer object option selected	Computer object
Create object command with the Organizational unit object option selected	Create organizational unit
Search command with the Run Query option selected	Run Query
Search command with the Get all users of a Group option selected	Get all users of a group
Get property command with the User option selected	Get user property
Get property command with the Group option selected	Get group property
Get property command with the Computer option selected	Get computer property
Get property command with the Organizational unit option selected	Get organizational unit property
Modify Object command with Computer object type and the Rename Object option selected	Rename computer
Modify Object command with Computer object type and the Delete Object option selected	Delete computer
Modify Object command with Computer object type and the Move Object option selected	Move computer
Modify Object command with Computer object type and the Set Property option selected	Set computer property
Modify Object command with Organizational Unit object and the Rename Object option selected	Rename organizational unit
Modify Object command with Organizational Unit object and the Delete Object option selected	Delete organizational unit
Modify Object command with Organizational Unit object and the Move Object option selected	Move organizational unit
Modify Object command with Organizational Unit object and the Set Property option selected	Set organizational unit property

See [Active Directory package](#).

App Integration

App Integration in Automation 360 does not have actions for each technology, unlike in Enterprise 10/Enterprise 11. In Automation 360, all actions are divided into individual actions.

Enterprise 11 or Enterprise 10 commands	Equivalent Automation 360 actions and packages
App Integration commands that capture text from a window	Capture text from window action of the App Integration package
Modify group command with the Rename group option selected	Rename group
Modify group command with the Delete group option selected	Delete group
Modify group command with the Add users to group option selected	Add users to group

Enterprise 11 bots that resize the application window when they are deployed can be migrated to Automation 360.

See [App Integration package](#).

Clipboard

All commands of Clipboard are migrated to equivalent actions of the Automation 360 **Clipboard** package. There is no change in behavior or command name.

See [Clipboard package](#).

Comment

Comment is migrated to Automation 360 **Comment** action.

If the Comment command contains a variable or a \$ symbol, the command gets disabled after migration.

Database

Enterprise 10/Enterprise 11 uses ODBC drivers and Automation 360 uses JDBC drivers.

The **SQL Query** action is called **Read from** in Automation 360.

The following table shows the commands that currently can be migrated.

Enterprise 11 or Enterprise 10 commands	Equivalent Automation 360 actions and packages
Connect	Migrates to the Connect command. If you encounter an unsupported connection string in Automation 360, the reasons might vary based on your environment. More details are available as part of the migration process. Contact Technical Support if you need assistance resolving the issue. 0 is not a valid time out value in Automation 360. The migration process replaces 0 with an empty value.

Enterprise 11 or Enterprise 10 commands	Equivalent Automation 360 actions and packages
Run Stored Procedure	<p>The parameter name and output parameter are mandatory fields in Automation 360.</p> <hr/> <p>Action required: After you migrate the bot, you must provide the parameter name and output parameter type in the Run stored procedure action.</p> <hr/>

See [Database package](#).

Delay

Delay command is migrated to the **Delay** action in Automation 360. "Delay in Milliseconds" and "Delay in Seconds" options (Enterprise 11) have changed to radio options within the **Time unit** area (Automation 360). See [Delay package](#).

Email

There are no sessions for Email commands in Enterprise 10 or Enterprise 11. However, Automation 360 includes **Connect** and **Disconnect** actions to ensure email sessions are started and closed. Therefore, during migration, the **Connect** action is placed before the respective email action and the **Disconnect** action after the respective email action.

The **Save attachment** option of the **Get All Messages** command is now a dedicated action called **Save attachment** in the **Email** package in Automation 360.

For bots created to automate email-related tasks on the Exchange Web Services (EWS) server, the **Get All Message** command is migrated to the **Loop** action with the iteration set to **For all each mail in mailbox**. Similarly, the **Delete** and **Delete all** commands are migrated to **Delete** and **Delete all** actions.

When you migrate Enterprise 11 bots that contain the Email package with **Authentication type** set to **OAuth2**, most of the parameters included in the package migrate to the same values in Automation 360. However, the following parameters migrate with different values:

- The **IMAP** and **POP3** protocols migrate to the corresponding Email server in Automation 360.
- The **Use Local timezone** migrates to the **Loop** action as a Boolean value in Automation 360.

See [Email package](#).

Error Handling

Disabled Error Handling commands are not migrated to Automation 360.

Begin Error Handling and **End Error Handling** is migrated to the **Try/Catch** block of the Error handler package in Automation 360. Many options available in Begin Error Handling are migrate to respective Automation 360 actions.

Note: To avoid an exception error when you use the **Try/Catch** block in a Loop, we recommend that you validate all the command inputs.

Refer the below table for details:

Enterprise 11 or Enterprise 10 commands	Equivalent Automation 360 actions and packages
Continue	By default, execution continues after executing the Catch block in Automation 360.
Stop	Stop action of the Task package is added in the Catch block.
Take Snapshot	<p>When the Take Snapshot option is selected and the location is provided in the File Path field of the Enterprise 11 bot, the migrated bot contains:</p> <ul style="list-style-type: none"> • The Capture desktop action of the Screen package to capture the error screen. • The Log to file action of the Log To File package to capture the error message in a text file. • The To string action of the Datetime package to convert the datetime value to string that will be stored in the text file along with the error message. <p>The above actions are added in the Catch block of the migrated bot and the captured image and the error message are stored at the location provided in the File Path field of the Enterprise 11 bot.</p> <p>When the Take Snapshot, Send Email, and Attach Sanpshot options are selected and the location is not provided in the File Path field in the Enterprise 11 bot, the migrated bot contains the following:</p> <ul style="list-style-type: none"> • The Create action of the Folder package to create a temporary location to store the captured image and the text file that contains the error message. • The Capture desktop action of the Screen package to capture the error screen. • The Log to file action of the Log To File package to capture the error message in a text file. • The To string action of the Datetime package to convert the datetime value to string that will be stored in the text file along with the error message. • The Send action of the Email package to send an email notification with the image and text file attached. • The Delete action of the File package to delete the image and text file stored in the temporary location. <p>The above actions are added in the Catch block of the migrated bot.</p>
Run Task	<p>Run action of the Task package is added in Try block.</p> <p>When a child bot encounters an error, the bot continues with the execution of the next action of the parent bot.</p>
Log Data into File	Log to File action is added in Catch block.
Send Email	<p>Send action from the Email package is added to the Catch block.</p> <p>The TaskBot variables and variable values sent as email attachment using the Attach Variable option are also migrated.</p>
Variable Assignment	Assign action of the String package is added with respective the condition in the Catch block.

See [Error handler package](#).

Excel

The Enterprise 10/Enterprise 11 Excel commands are migrated to respective Automation 360 actions of the **Excel Advanced** package.

In Enterprise 11, a bot can open a Microsoft Excel spreadsheet even when a file extension is not provided. In Automation 360, the migrated bots uses the **Open** action in the Excel advanced package to open a Microsoft Excel spreadsheet when a file extension is not provided.

In Enterprise 10/Enterprise 11, data returned by **Get Multiple Cells** and **Get All Cells** commands are returned to the **Loop > Each Row in an Excel Dataset** command. In Automation 360, the functionalities of **Get Multiple Cell** and **Get All Cells** are available in **Loop > Each Row in an Excel Dataset** action, so values from these commands are migrated to the loop instead of actual actions.

Bots that use the **Get Single Cell** command with the **Specific cell** and **Get Cell Value** options are migrated to the **Get single cell** action of the Excel advanced package with the **Specific cell** and **Read cell value** options selected after migration.

The following table shows action name changes:

Enterprise 11 or Enterprise 10 commands	Equivalent Automation 360 actions and packages
Save Spreadsheet	Save workbook
Open Spreadsheet	Open
Close Spreadsheet	Close Note: When you migrate a bot with Excel: Close action, in Enterprise 10/Enterprise 11, the bot ignores the Save option for the read-only file, whereas in Automation 360, the following prompt is displayed: The File already exists .
Get Cells	Divided into Get single cell and Get multiple cells actions Note: The Get Cells action retrieves output in different formats for Enterprise 10/Enterprise 11 and Automation 360 for specific data types such as Boolean and Date.
Activate Sheet	Switch to sheet Note: In Enterprise 11, the bot containing the Activate Sheet command does not switch to and perform operations on a hidden worksheet. However, after migration to Automation 360, the bot containing the equivalent Switch to worksheet action switches to the hidden worksheet and performs operations on it. After the operations are completed, the worksheet remains hidden and is not activated.

Enterprise 11 or Enterprise 10 commands	Equivalent Automation 360 actions and packages
Find/Replace	<p>Divided into Find and Replace actions</p> <p>When you migrate a bot with the Excel > Find action and if the value is present at the beginning of a cell address, the migrated bot retrieves the same output results in a different sequence for the Find Text for Enterprise 11 and Automation 360. For example, if A2, B5, and D15 cell addresses have the value XYZ and you search for XYZ in the range A2:D15, the Enterprise 11 bot collects the result in the sequence: B5, D15, and A2. However, the migrated bot will collect the result in a different sequence: A2, B5, and D15, after migrating to Automation 360.</p>

See [Excel advanced package](#).

- In Enterprise 11 or Enterprise 10 and in Automation 360, a session (used to open a Microsoft Excel spreadsheet) can be shared between the parent bot and a child bot. In Automation 360, you can close a shared session from the child bot.

Note: When you use more than one spreadsheet to automate an operation, you must use different session names for each spreadsheet. If you want to use the same session name to automate all the spreadsheets, you must first close the session of one spreadsheet before using the same session name for another spreadsheet.

- In Enterprise 11 or Enterprise 10, when you try to save a read-only spreadsheet, an error is not displayed. However, in Automation 360, when you try to save a read-only spreadsheet, an error message that the workbook cannot be saved is displayed.

Workaround: Ensure that you have the **Edit** access for the file and retry the operation. If the issue persists, contact your system administrator. The **Write** action is not allowed on such files.

File and Folder

All commands of **File/Folder** have been split into **File** and **Folder** packages.

The following **File** related actions have changed in Automation 360:

Enterprise 11 or Enterprise 10 commands	Equivalent Automation 360 actions and packages
Copy Files	Copy action of the File package
Create Files	Create action of the File package
Create File Shortcut	Create shortcut action of the File package
Delete Files	Delete action of the File package
Open Files	Open action of the File package
Print Files	Print action of the File package
Rename Files	Rename action of the File package
Unzip Files	Unzip action of the Folder package
Zip Files	Zip action of the Folder package

The following **Folder** related actions have changed in Automation 360:

Enterprise 11 or Enterprise 10 commands	Equivalent Automation 360 actions and packages
Copy Folder	Copy action of the Folder package
Create Folder	Create action of the Folder package
Create Folder Shortcut	Create shortcut action of the Folder package
Delete Folder	Delete action of the Folder package
Open Folder	Open action of the Folder package
Rename Folder	Rename action of the Folder package

See [File package](#) and [Folder package](#).

Enterprise 11 bots can use regular expressions in the **Copy Files**, **Delete Files**, **Print Multiple Files**, **Rename Files**, and **Zip Files** commands to search for files on which you want to perform an operation. The equivalent actions in Automation 360 too can use regular expressions to search for files on which you want to perform an operation.

FTP/SFTP

All commands of **FTP/SFTP** are migrated to equivalent Automation 360 actions of the **FTP/SFTP** package. There is no change in behavior or command name.

Get files and **Get folder** actions return runtime errors if they have additional criteria based on dates, which are provided as variables that have values in a format other than MM/DD/YYYY. You must fix such instances after bot migration. During the migration process, these two actions also add extra error handlers in the migrated bots when filtering is done on datetime.

If/Else

Variables containing string condition

"If" with the following operators is migrated as a String condition in Automation 360:

- =
- < >
- Include
- Does not Include

For the **Random** variable of the **String** subtype, Automation 360 adds the **Generate random string** action of the **String** package to generate a random string above the If condition and assigns the value to the respective migrated variable.

Variable containing number condition

"If" with the following operators is migrated as a Number condition in Automation 360:

- >=
- <=
- >

- <

For the **Random** variable of the **Number** subtype, Automation 360 adds the **Assign a random number** action of the **Number** package to generate a random string above the If condition and assigns the value to the respective migrated variable.

Value type variable containing date

The system tries to evaluate if a condition on a variable has a date value. If found, it migrates If with the Datetime condition in Automation 360. Otherwise, the system migrates it as a string or number condition based on the operator used. In those cases, you must change it to a date condition after the bot migration if a date operation is involved.

Additionally, you might also have to change the date format to one that is compatible with your data. The default format used to convert a date to string is `MM/dd/yyyy HH:mm:ss`.

See [If package](#) .

Image Recognition

The **If** command with the **Image Recognition** condition in Enterprise 10/Enterprise 11 can become one of the following actions in Automation 360 based on the selected Enterprise 10/ options:

- If > **Image file is found in image file** – Created if *Image1* has the **From File** option selected and *Image2* has the **From File** option selected in Enterprise 10 or Enterprise 11.
- If > **Image file is found in a window** – Created if *Image1* has the **From File** option selected and *Image2* has the **From Window** option selected in Enterprise 10 or Enterprise 11.
- If > **Window is found in image file** – Created if *Image1* has the **From Window** option selected and *Image2* has the **From File** option selected in Enterprise 10 or Enterprise 11.
- If > **Window is found in a window** – Created if *Image1* has the **From Window** option selected and *Image2* has the **From Window** option selected in Enterprise 10 or Enterprise 11.

See [If package](#) .

Action Required: If a condition involves date, under certain situation, you must change the migrated information to a date condition after the bot migration.

The table below shows how various conditions are migrated to the respective Automation 360 conditions.

Enterprise 11 or Enterprise 10 commands	Equivalent Automation 360 actions and packages
Task Successful or Task Unsuccessful	Migrated to the equivalent If condition of Task Bot package.
Script Successful or Script Unsuccessful	Script successful/unsuccessful is migrated to respective If > Script Successful and If > Script Unsuccessful actions of the Legacy automation package.
Object Properties	Migrated to the If > Condition > Window Exists and Object conditions of the Recorder package.
Application Running or Application Not Running	Migrated to the equivalent If condition of the Application package.
File Exists, File Does Not Exist, File Date, File Size	Migrated to the equivalent If condition of the File package.
Folder Exists or Folder Does Not Exist	Migrated to the equivalent If condition of the Folder package.
Ping Successful Or Ping Unsuccessful	Migrated to the equivalent If condition of the Ping package.
Web Control Exists or Web Control Does Not Exists	Migrated to the equivalent If condition of the Legacy Automation package.
Window Exists/Window Does Not Exist	<p>The following commands configured with the "Show child and hidden windows" option selected are migrated to the Automation 360 Legacy Automation package:</p> <ul style="list-style-type: none"> • If > Condition > Window Exists • If > Condition > Window Does Not Exist

Enterprise 11 or Enterprise 10 commands	Equivalent Automation 360 actions and packages
Logic Successful/Logic Unsuccessful	<p>The If command is migrated to If > Task Successful and If > Task Unsuccessful respectively.</p> <p>The Else If command is migrated to Else If > Task Successful and Else If > Task Unsuccessful respectively.</p> <p>Bots that use the Logic Successful or Logic Unsuccessful condition and return an output variable to the parent bot, can be migrated to Automation 360.</p> <p>Bots that use Credential Vault variables are passed from one MetaBot Logic to another MetaBot Logic for both IF > Logic Successful and IF > Logic Unsuccessful commands.</p> <p>You can migrate a MetaBot with a Logic (parent) that includes a renamed Logic (child). If a child Logic is renamed after it is mapped to the parent Logic, this parent Logic mapping is migrated with the new name.</p> <p>Applies from v.25:Enterprise 11 or Enterprise 10 bots that use the If > Logic Successful or If > Logic Unsuccessful command are migrated when a referred MetaBot Logic name is renamed or has changed the relative path after mapping. If a MetaBot Logic is renamed or changed the path after being mapped in the TaskBots, then the TaskBots are now migrated with the new MetaBot Logic name or path.</p> <p>For information about how a bot is migrated if the Logic Successful command passes a Credential Vault variable, see Run Logic.</p>
Service is running/Service is not running	<p>The If command is migrated to If > Service is running and If > Service is not running.</p> <p>The ElseIf command is migrated to Else If > Service is running and Else If > Service is not running.</p>

Image Recognition

The **Image Recognition** command is split into **Find file image inside window image** and **Find window image inside another window image** actions in Automation 360.

In Automation 360, **Advanced** option is used as the default comparison mode. The other comparison modes (such as **Gray-scale**, **Normal** and **Monochrome**) that existed in Enterprise 10 and Enterprise 11, are hidden in Automation 360 but match the behavior with Automation 360 after migration. The migration process maps the information automatically and does not impact related bots.

Migration of bots with the **Image Recognition** command might fail if the command is using any file type other than the following:

- .jpg
- .jpeg
- .jpe
- .jfif
- .bmp

- .gif

See [Image Recognition package](#).

Insert Keystrokes

This command is called **Simulate Keystrokes** in Automation 360. The following keystroke conventions have changed:

Enterprise 11 or Enterprise 10 commands	Equivalent Automation 360 actions and packages
[PAGE UP]	[PAGE-UP]
[NUM LOCK]	[NUM-LOCK]
[SCROLL LOCK]	[SCROLL-LOCK]
[PAGE DOWN]	[PAGE-DOWN]
[CAPS LOCK]	[CAPS-LOCK]
[UP ARROW]	[UP-ARROW]
[LEFT ARROW]	[LEFT-ARROW]
[RIGHT CLICK]	[MENU]
[RIGHT ARROW]	[RIGHT-ARROW]
[DOWN ARROW]	[DOWN-ARROW]
[ALT GR DOWN]	[ALT-GR DOWN]
[ALT GR UP]	[ALT-GR UP]
[\$]	[DOLLAR]

In Enterprise 11 or Enterprise 10, the delay time is divided by the total characters and applied between each character stroke. In Automation 360, the delay you specify applies to the time between each keystroke.

The legacy **Get keystrokes delay** action in Automation 360 supports migrated bots that include the **Simulate keystrokes** action. The legacy **Get keystrokes delay** action matches the duration of delay defined in Enterprise 11 bots for the Insert Keystrokes command and simulates the same value in Automation 360 for the **Simulate keystrokes** action. After migration, if keystrokes are typed faster (for example, keystrokes used to perform shortcuts in Office 365 Excel), add the **Delay** action after the **Simulate keystrokes** action to ensure that the bots run without issues. The legacy **Get keystrokes delay** action provides similar delay, as seen in Enterprise 11, in the migrated bots to ensure that the migrated bots produce the same output as seen in Enterprise 11. However, this change leads to the command being split into multiple lines after migration.

If the **Encrypt Keystrokes** option is selected in Enterprise 11 or Enterprise 10 bots, after migration the value is stored in the Credential Vault. The migration process creates a locker in the Credential Vault with the following attributes:

- Name of the locker created in Automation 360 is name `AAE_<folder_name>` (folder_name is the folder in which the migrated bot is available).

The migrated bot uses this locker. Users who have any permission for the folder that contains the bot can access the locker. The migration run-as user must have the **Create standard attributes for a credential** permission.

- A locker contains only one credential for each bot. The name of the credential created is `Keystrokes_<bot name>` for the TaskBots and `Keystrokes_<Metabot name>_<Logic name>` for MetaBots.
- Attributes for the locker are created with the name `Encrypted_keystrokes`.

If a locker, credential, or attribute with the same name is already available, the system appends the locker name, credential name, and attribute name with a numeric value. For example, `AAE_<folder_name>_1`, `Keystrokes_<bot name>_1`, and `Encrypted_keystrokes_1` respectively. If name of the locker, credential, or attribute is longer than 50 characters, the system trims the characters at the end to limit the name to 50 characters.

Note: You cannot migrate a bot that is available on the local device and the **Encrypt Keystrokes** option is selected.

See [Simulate keystrokes package](#).

Launch Website

This command is migrated to the **Open** action of the **Browser** package in Automation 360.

Commands with the **Edge** or **Override default browser** option deselected in the legacy product is automatically changed to use **Default Browser** after migration.

Enterprise 11 bots that open a website in a new window of all browsers supported by Automation 360 can be migrated. The Enterprise 11 bots that open the website in a new or an existing tab of the Internet Explorer browser can be migrated to Automation 360. The equivalent option to open the website in a new window, tab, or an existing tab is selected in the migrated bots.

Note: The support for the Microsoft Edge Legacy browser is no longer available, whereas the Microsoft Edge Chromium browser is supported. As a result, you cannot create new bots using the Microsoft Edge Legacy browser. However, the existing bots created in Microsoft Edge Legacy browser can be updated using other supported browsers such as Google Chrome or Microsoft Edge Chromium browser.

See [Browser package](#).

Action Required: If you have created bots in Enterprise 11 or Enterprise 10 using the Microsoft Edge browser, you must first port these bots to another browser, and then you can migrate them.

Log To File

This command is migrated to **Log to file** action in Automation 360.

See [Log To File package](#).

Loop

The following table shows how the Loop command is migrated to the equivalent Automation 360 actions and packages:

Enterprise 11 or Enterprise 10 commands	Equivalent Automation 360 actions and packages
Loop command with the Times option selected	Loop action of the Loop package with the For n times option selected.

Enterprise 11 or Enterprise 10 commands	Equivalent Automation 360 actions and packages
Loop command with the List option selected	Loop action of the Loop package with the For n times option selected.
Loop command with the Each Row in an Excel Dataset option selected	Loop action of the Loop package with the For each row in worksheet option selected. The system variable \$Excel Column\$ used inside the loop is now a user defined variable specified in the same iterator.
Loop command with the Each Row In A SQL Query Dataset option selected	Loop action of the Loop package with the For each row in a SQL query Dataset option selected. The system variable \$Dataset Column\$ used inside the loop is now a user defined variable specified in the same iterator.
Loop command with the Each File In A Folder option selected	Loop action of the Loop package with the For each file in a folder option selected. The system variables \$Filename\$ and \$Extension\$ are now keys name and extension of a dictionary variable specified in the same iterator. In Enterprise 11, the bots does not encounter an error if the folder does not exist. In Automation 360, the migrated bots encounter an error if the folder does not exist.
Loop command with the Each Folder In A Folder option selected	Loop action of the Loop package with the For each folder in a folder option selected. The system variable \$Folder name\$ used inside the loop is now a user defined variable specified in the same iterator. In Enterprise 11, the bots does not encounter an error if the folder does not exist. In Automation 360, the migrated bots encounter an error if the folder does not exist.
Loop command with the Each Row In A CSV/Text File option selected	Loop action of the Loop package with the For each row in CSV/TXT option selected. The system variable \$Filedata Colum\$ used inside the loop is now a user defined variable specified in the same iterator.
Loop command with the Each Email Message On Mail Server option selected	Loop action of the Loop package with the For each mail in mailbox option selected. The system variables \$Email Cc\$, \$Email From\$, \$Email Message\$, \$Email Received Date\$, \$Email Received Time\$, \$Email Subject\$, and \$Email To\$ are now keys emailCc, emailFrom, emailMessage, emailReceivedDate, emailReceivedTime, emailSubject, and emailTo respectively of a dictionary variable specified in the same iterator.
Loop command with the Each Node In An XML Database option selected	Loop action of the Loop package with the For each node in an XML database option selected. The system variable \$XML Data Node\$ used inside the loop is now a user defined variable specified in the same iterator.

The following commands configured with the **Show child and hidden windows** option selected are migrated to the Automation 360 **Legacy Automation** package:

- **Loop > Condition > Window Exists**
- **Loop > Condition > Window Does Not Exist**

Variables containing string condition

"If" with the following operators is migrated as a String condition in Automation 360:

- =
- < >
- Include
- Does not Include

For the **Random** variable of the **String** sub-type, Automation 360 adds the **Generate random string** action of the **String** package to generate a random string above the If condition and assigns the value to the respective migrated variable.

Variable containing number condition

"If" with the following operators is migrated as a Number condition in Automation 360:

- >=
- <=
- >
- <

For the **Random** variable of the **Number** sub-type, Automation 360 adds the **Assign a random number** action of the **Number** package to generate a random string above the If condition and assigns the value to the respective migrated variable.

Variable containing date conditions

The system tries to evaluate if a condition on a variable has a date value. If found, it migrates IF with the Datetime condition in Automation 360. Otherwise, the system migrates it as a string or number condition based on the operator used. In those cases, you must change it to a date condition after the bot migration if a date operation is involved.

Additionally, you might also need to change the date format to one that is compatible with your data. The default format used to convert a date to string is `MM/dd/yyyy HH:mm:ss`.

List type variable

Loop on a variable condition of type List is migrated to either String or Number condition based on the operator used in the condition. The system uses the list index to validate the condition.

Web Control Exists or Web Control Does Not Exist

Loop with **Web control exists** and **Web control does not exist** conditions are migrated to **Loop > While** conditions Web control exists and Web control does not exist of the **Legacy Automation** package respectively.

See the following table to understand how various conditions are migrated to the respective Automation 360 conditions.

Enterprise 11 or Enterprise 10 conditions	Equivalent Automation 360 actions and packages
Web Control Exists or Web Control Does Not Exists	Migrated to the equivalent If condition of the Legacy Support package.
Object Properties	Migrated to the Object condition of the Recorder package.
Application Running or Application Not Running	Migrated to the equivalent If condition of the Application package.
File Exists, File Does Not Exist, File Date, File Size	Migrated to the equivalent If condition of the File package.
Folder Exists or Folder Does Not Exist	Migrated to the equivalent If condition of the Folder package.
Ping Successful Or Ping Unsuccessful	Migrated to the equivalent If condition of the Ping package.
Service is running or Service is not running	Migrated to the equivalent If condition of the Service package.

The following table shows the Loop commands supported for migration and their respective mappings in Automation 360.

Enterprise 11 or Enterprise 10 commands	Equivalent Automation 360 actions and packages
Exit Loop	Break
Continue	

Message Box

This command is migrated to **Message box** action in Automation 360.

See [Message box package](#).

Object Cloning

This command is migrated to the **Recorder** package > **Capture** action in Automation 360.

Migration is supported for applications using the following technologies (including when they are within a Citrix environment):

- MSAA (Standard desktop technology)
- Google Chrome browser
- Internet Explorer browser
- Java desktop
- Web Java
- UI Automation (advanced)
- Firefox browser (object based on HTML technology only)

- Microsoft Silverlight version 5

The following table lists the behavioral differences between Enterprise 11 or Enterprise 10 and Automation 360:

Enterprise 11 or Enterprise 10 behavior	Automation 360 behavior
GetAllChildrenName and GetAllChildrenValue commands return string type variable values	The equivalent actions in Automation 360 return list values. The migration process joins the list values and stores them into a string variable to maintain consistent bot behaviors across releases.
In Enterprise 11, the command is used to capture the control in an image	The entire window image is captured with the control highlighted using a red rectangle

Object Cloning with the **Export to CSV** action in Enterprise 10/Enterprise 11 is migrated into the following packages/actions combinations because the action does not exist in Automation 360:

- The **Capture** action saves the captured data into a table variable.
- The **Write to file** action of the **Data table** package is then used to save the data from the table variable to the CSV file.

The window title is copied from the source command to the destination action.

The X, Y coordinates and window title are also migrated to Automation 360.

The **Coordinate** and **Image** execution or play modes from Enterprise 11 are migrated as the following actions:

- Play mode as coordinates:

Play mode as coordinates

Mouse click actions: The Click, Right Click, Left Click, Middle Click, and Double Click actions are migrated in the Mouse: Click action as a combination of Button and Events. The corresponding mouse buttons with events are migrated as shown:

- Click changes to Left Button-Click
- Right Click changes to Right Button-Click
- Left Click changes to Left Button-Click
- Middle Click changes to Middle Button-Click
- Double Click changes to Left Button Double-Click

Get Text

The Get Text action is migrated as a combination of actions that include Mouse: Click with Left Button-Click, Clipboard: Clear, Delay, and Simulate keystrokes.

Set Text

The Set Text action is migrated as a combination of actions that include Mouse: Click with Left Button-Click, Clipboard: Clear, Delay, and Simulate keystrokes.

The following table shows the property name changes for the controls and objects captured using **Object Cloning**. The migration process automatically maps the name changes. However, if a property is used inside a variable, you must manually enter the new name in the variable.

Enterprise 11 or Enterprise 10 property name	Automation 360 property name
Object ID	ID
Type	Control Type
State(s)	States
Action	DefaultAction
Bold	IsBold
Italic	IsItalic
Underline	IsUnderline
Strike Through	IsStrikethrough
Super Script	IsSuperscript
Sub Script	IsSubscript
Background Color	BackgroundColor
Foreground Color	ForegroundColor
Font	FontFamily
Font Size	FontSize
First Line Indent	FirstLineIndent
Left Indent	LeftIndent
Right Indent	RightIndent
Line Spacing	LineSpacing
Space Above	SpaceAbove
Space Below	SpaceBelow
Item Name	ItemName
Item Value	ItemValue
Animated	IsAnimated
CapStyle	Cap
Font Weight	FontWeight
Horizontal Alignment	HorizontalAlignment
Hidden	IsHidden
Read Only	IsReadOnly
Bottom Margin	BottomMargin
Left Margin	LeftMargin
TopMargin	TopMargin
Right Margin	RightMargin

Enterprise 11 or Enterprise 10 property name	Automation 360 property name
Overline Color	OverlineColor
Strikethrough Color	StrikethroughColor
Tabs Style	Tabs
Text Flow Direction	TextFlowDirection
Underline Color	UnderlineColor
HTML ID	IEID
HTML Name	IEName
HTML Alt	IEAlt
HTML Tag	IETag
HTML Class	IEClass
HTML InnerText	IEInnerText
HTML SourceIndex	IESourceIndex
HTML HRef	IEHref
HTML Value	IEValue
HTML Type	IEType
HTML ClassId	IEClassId
HTML Title	IETitle
HTML Tag Index	IETagIndex
HTML HasFrame	IEHasFrame
HTML FrameID	IEFrameID
HTML Frame Name	IEFrameName
HTML Frame Src	IEFrameSrc
HTML Width	IEWidth
HTML Top	IETop
HTML Left	IELeft
HTML Height	IEHeight
HTML Frame Path	IEFramePath
Item Collection	ItemCollection
OCR Engine	OCREngine
OCR Occurrence	OCROccurrence
Row Control Type	RowControlType
GetSelectedIndex	GetSelectedIndex

Enterprise 11 or Enterprise 10 property name	Automation 360 property name
GetSelectedText	GetSelectedText

- The migration process truncates the data to 64 KB if the Enterprise 11 or Enterprise 10 bots that use an object and any properties of that object contain data larger than 64 KB. This is to ensure that these bots do not encounter an error after migration.
- In Enterprise 11, you can remove the control type of an object from the search criteria, but this option is not available in Automation 360. In Automation 360, the capture action executes only on objects with the same control types. If you want to use this action on objects with different control types, you must capture these control types in separate capture actions.

See [Using the Capture action](#).

OCR

All commands of **OCR** are migrated to equivalent Automation 360 actions of the **OCR** package. There is no change in behavior or command name.

In Enterprise 11, **ABBYY, MODI, TESSERACT, TOCR** OCR options are available as OCR engines. In Automation 360, by default only **ABBY** OCR engine is used.

See [OCR package](#).

Open Program/File

This command is migrated to the **Open program/file** action of the **Application** package. In Enterprise 10/Enterprise 11, this command does not throw an error if you provide an incorrect value in the **Start In** field. Automation 360 validates the value entered for the same field and throws an error during bot execution.

See [Application package](#).

Action Required: Users must change the bot accordingly if they want to continue even if the Start In value field is incorrect.

PDF integration

The following table shows the PDF integration command and their equivalent actions and packages in Automation 360:

Enterprise 11 or Enterprise 10 commands	Equivalent Automation 360 actions and packages
Merge Document	Merge document
PDF to Image	Extract image
Extract Form Fields	Extract field
Extract Text	Extract text
Split Documents	Split documents
Encrypt Document	Encrypt document

Enterprise 11 or Enterprise 10 commands	Equivalent Automation 360 actions and packages
Decrypt Document	Decrypt document

If the Enterprise 11 bot uses the **Extract Form Fields** command and stores values in the Credential Vault, the migration process migrates these values in the Automation 360 Credential Vault.

The output of an Enterprise 11 bot is mapped with multiple variables in the equivalent actions of the PDF package after that bot is migrated to Automation 360. This reduces the number of actions in the migrated bot because a separate action is no longer required to map output to a variable.

See [PDF package](#).

PGP

All commands of **PGP** are migrated to equivalent Automation 360 actions of the **PGP** package. There is no change in behavior or command name.

See [PGP package](#).

Play Sound

All commands of Play Sound are migrated to its equivalent actions of the **Sound** package in Automation 360.

Automation 360 supports only .mp3 and .wav file types in Play media file action.

See [Play Sound package](#).

Printer

Default Printer, **Remove Printer**, and **Select Default Printer** are migrated to the equivalent actions of the **Printer** package in Automation 360.

See [Printer package](#).

Prompt

All commands of **Prompt** are migrated to equivalent Automation 360 actions of the **Prompt** package.

The following table shows commands that can be migrated with name changes.

Enterprise 11 or Enterprise 10 commands	Equivalent Automation 360 actions and packages
Prompt For Value	Converts to the For value action. In addition, Simulate keystroke action is added below the For value action to perform the keystrokes on the specific window title. This is to retain the execution behavior of old bots.
Prompt for File	For file
Prompt for Folder	For folder

Enterprise 11 or Enterprise 10 commands	Equivalent Automation 360 actions and packages
Prompt For Yes/No	For yes/no

See [Prompt package](#).

Read from CSV/Text

The **Read from CSV/Text** is converted to **Open**, **Read**, and **Close** actions in the Automation 360 **CSV/TXT** package.

If your Enterprise 10/Enterprise 11 bot is using a variable as a session name and the **Loop** action used to read all rows of the **CSV/TXT** is using a hard-coded session name instead of a variable, then you must review the migrated bot and set the output variable of the **CSV/TXT > Read** action in the respective loop. Otherwise, you will get a UI error when you edit the Automation 360 bot.

In Automation 360, if the CSV/TXT file is not present in the specified file path, the bot returns an error message, whereas in Enterprise 11, the bot does not return such message.

Action Required: Review the migrated bot and set the output variable of the **CSV/TXT > Read** action in the respective loop.

REST Web Service

The **Save Header To** option in Enterprise 11 is migrated to Automation 360. This option enables you to store the response header in the array and dictionary variables with the response header name as key and its header value as the value of the dictionary.

In Enterprise 11, the failure response is captured by default. In Automation 360, enabling the **Capture failure response** option captures the errors and adds to the response dictionary variable. When you migrate an Enterprise 11 bot to Automation 360, the **Capture failure response** option is enabled by default to capture the failure response of the migrated bot.

The time-out value configured in Enterprise 11 to send REST request is migrated to Automation 360 as part of global values (AARestTimeOut). The default time-out value is set as 60000 ms in Automation 360. You can update this value if the REST Web Service is taking more time to receive a response.

See [REST Web Service package](#).

Run Logic

Run logic command is migrated to the **Run** action of the **Task Bot** package in Automation 360.

Additionally, **Error Handling** with the **Run Logic** command is migrated to the **Try and Catch** block.

- **Applies from v.25:**Enterprise 11 or Enterprise 10 bots that use the **Run Logic** command are migrated where a referred MetaBot Logic name is renamed or has changed the relative path after

mapping. If a MetaBot Logic is renamed or changed the path after being mapped in the **TaskBots**, then the **TaskBots** are now migrated with the new MetaBot Logic name or path.

Changing the relative path is applicable in the following scenarios:

- Logic is moved from one folder to another.
 - Logic is moved from a MetaBot root-level folder to a subfolder.
 - Logic is moved from a subfolder to a folder at MetaBot root level.
 - The folder that has the Logic is renamed.
- Bots that use the **Run Logic** command that passes Credential Vault attributes from a TaskBot to a MetaBot logic can be migrated to Automation 360. The credential name and attribute name are displayed in the fields in the corresponding line of the migrated bot.
 - If you have migrated using the restored Enterprise 11 database, an equivalent locker is created in Automation 360 for the credential variables used in the Enterprise 11 bot.
 - **Applies from v23:** Enterprise 11 or Enterprise 10 bots that use the **Run Logic** command are allowed to pass Credential Vault type variables from the parent bot to a MetaBot non-Credential Vault type variable. However, in Automation 360, Credential Vault variables are passed only to credential type variables (and not to non-Credential Vault type variable) for enhanced security. Therefore, the migration process first converts the Credential Vault type variable to the string type variable using the **Convert credential to string** action of the **Credential package** so that the migrated bot can run successfully. The string variable is then assigned to a temporary variable that is used as an input parameter in the **Task > Run** action to call the MetaBot Logic.
 - Bots that use Credential Vault variables are passed from one MetaBot Logic to another MetaBot Logic for the **Begin Error Handling > Run Logic** command.
 - When you perform a **Begin Error Handling > Run Logic** command, you can migrate a MetaBot with a Logic (parent) that includes a renamed Logic (child). If a child Logic is renamed after it is mapped to the parent Logic, this parent Logic mapping is migrated with the new name.

Choose one of the following options to run the migrated bots successfully:

- **Option 1:** Pass the credential type variables.
 1. Create a credential type variable in the child bots as input variables.
 2. In the **Run** action of the Task Bot package of the parent bot, update the input value fields to use the Credential Vault attributes for the credential type variable created for the child bot (corresponding to MetaBot logic).
- **Option 2:** Pass the credential values as a global value.
 1. Create the Global value in Automation 360 for the credentials use in the **Run Logic** command in Enterprise 11.
 2. In the **Run** action of the Task Bot package of the parent bot, update the Input value fields to use the Global values for the credential type variable created for the child bot (corresponding to MetaBot logic).

If you have not used the restored Enterprise 11 database when installing Automation 360, you must first create the required locker for the credential variables used in the Enterprise 11 bot, before performing the preceding steps.

Note: Automation 360 provides enhanced security by allowing you to assign Credential Vault attributes only to the credential type variables. This restricts any nonsecure handling of Credential Vault attributes where they might have been assigned to non-credential type variables.

Run Script

The **Run Script** command is migrated to the **Run Script** action of the **Legacy automation** package.

When you use the **Legacy automation** package with the **Run Script** action after migration, you might run into issues in some scenarios, so review the cause and how to resolve the issue:

- **Cause:** In the **Run Script action > Input Parameters** field, if the value of the argument (passed by **String > Assign action**) contains double quotation marks followed by a backslash at the end of the argument and the variable value contains a space, the string breaks where the first space occurs (this is due to upgrade changes in openJDK).
- **Example:** Consider a folder path as the argument value that is passed using **String > Assign action**, "`\\fwus129ns.ny.fw.gs.com\mahatb\home\My Documents\Test Adhoc Request`". When you migrate this Enterprise 11 bot to Automation 360, this single argument value is considered as four different argument values in Automation 360, as follows:
 - `\\fwus129ns.ny.fw.gs.com\mahatb\home\My`
 - `Documents\Test`
 - `Adhoc`
 - `Request\`
- **Solution:** Edit the Enterprise 11 bot and remove the double quotation marks in the variable value in **String > Assign action**.

SAP Integration

This command is migrated to the Recorder package > **Capture** action in Automation 360. All object properties in the Enterprise 11 bots are mapped with the equivalent properties in the migrated bots.

Note: If the Enterprise 11 bot with the SAP Integration command is using **SAP GUI 740** or earlier versions, perform additional steps in the Bot Agent machine to run the migrated bot successfully in Automation 360. For more information, see [Failed to capture SAP application using SAP GUI 740 \(A-People login required\)](#).

The following table provides a list of SAP objects and the actions that can be migrated to Automation 360.

Object	Action
Text box	Set Text, Append Text, Left Click, Right Click, Double Click
Combo box	Select Item By Text, Select Item By Index, Get Total Items, Get Selected Item Text, Get Selected Item Key, Get Property, Set Focus, Left Click, Right Click, Double Click
Check box	Check, Uncheck, Toggle, Get Status, Get Property, Set Focus, Left Click, Right Click, Double Click
Button	Click, Get Property, Left Click, Right Click, Double Click
Radio button	Select, Get Status, Get Property, Set Focus, Left Click, Right Click, Double Click

Object	Action
Menu bar	Select Item By Text, Get Property, Set Focus, Left Click, Right Click, Double Click
Tree	Get Property, Set Focus, Left Click, Right Click, Double Click, Get total items, Get selected index, Get selected text, Select item by index, Select item by text
Label	Click, Get Property, Set Focus, Left Click, Right Click, Double Click
Tab	Get Property, Set Focus, Left Click, Right Click, Double Click, Get total items, Get selected index, Get selected text, Select item by index, Select item by text
Rest of the control (It includes controls such as: GuiMainWindow, GuiBox, GuiUserArea, GuiTitlebar, and GuiStatusbar)	Get Property, Set Focus, Left Click, Right Click, Double Click

The following table shows the actions performed on the main window object and their equivalent actions in Automation 360:

Enterprise 11 action	Equivalent Automation 360 action
Activate Window	Activate action of the Window package.
Close Window	Close action of the Window package.
Execute Script	Append SAP session and Run function actions of the Legacy Automation package.
Maximize Window	Maximize action of the Window package
Restore Window	Restore action of the Window package

SAP commands that support BAPI features in Enterprise 11 are migrated to equivalent actions of the SAP BAPI package in Automation 360.

The following table shows the Enterprise 11 command and its equivalent action in Automation 360:

Enterprise 11 command	Automation 360 action
Connect	SAP BAPI > Connect You must create the JcoDllPath and JcoJarPath global values. Update the JcoJarPath global value with the location of the SAP Java connector package and the JcoDllPath with the location of the SAP Java connector DLL.
Create Function	SAP BAPI > Create function
Get Data command with the Field option selected	SAP BAPI > Get field

Enterprise 11 command	Automation 360 action
Get Data command with the Table option selected	SAP BAPI > Get table
Get Data command with the Structure option selected	SAP BAPI > Get structure
Set Data command when the Fields, Table, or Structure option is selected	SAP BAPI > Set field
Invoke Function	SAP BAPI > Run function
Run standard workflow	SAP BAPI > Run standard workflow
Run custom workflow	SAP BAPI > Run custom workflow

Send Email

In Enterprise 10/Enterprise 11, the Send Email command uses user-specific email settings stored as credential attributes within the system locker. When the first bot is migrated, we create a custom locker called **AAE_Email** and add the **AAE_EmailSettings** credential with the Username and Password attributes to it. Additionally, we create Global Values for the non-credential attributes, such as Server host, port, SSL and authentication, which correspond to the same Email Settings. Enterprise 10/Enterprise 11 Email Settings credentials are split into Credential Variable and Global Values in Automation 360, so during the migration process, email settings are migrated as follows:

Enterprise 10/Enterprise 11 Email Settings	Automation 360 Email Settings	Automation 360 Storage Type
Host	AAE_EmailSettings_host Global Value of type String	
Port	AAE_EmailSettings_port Global Value of type Number	
Use secure connection (SSL/TLS)	AAE_EmailSettings_ssl Global Value of type Boolean	
My server requires authentication	AAE_EmailSettings_auth Global Value of type Boolean	
Username	userName Credential attribute within AAE_EmailSettings credential assigned to AAE_Email locker	
Password	password Credential attribute within AAE_EmailSettings credential assigned to AAE_Email locker	

Services

All commands of **Services** are migrated to equivalent Automation 360 actions of the **Service** package. There is no change in behavior or command name.

SOAP Web Service

This package behaves the same in Automation 360.

If a SOAP web service is configured to call REST APIs, then we migrate them to the REST web service action instead of the SOAP web service action. Based on additional XML operations, we add actions from the **XML** package to make sure the migrated bot gives same result as the legacy bot.

The time-out value configured in Enterprise 11 to send SOAP request is migrated to Automation 360 as part of global values (AASoapTimeOut). The default time-out value is set as 60000 ms in Automation 360. You can update this value if the SOAP Web Service is taking more time to receive a response.

Example of using the SOAP web service action

Enterprise 11 provides options to select the **URI type for execution** such as **Default**, **Static**, and **Dynamic**. However, in Automation 360, no option is available to select the URI type for execution. The Enterprise 11 URI types are migrated in Automation 360 as follows:

- **Default and Static:** If your Enterprise 11 bot is configured with the **Default** or **Static** URI type, it is migrated as static and the **Address location** field is automatically populated.
- **Dynamic:** If your Enterprise 11 bot is configured with the **Dynamic** URI type, it is migrated as dynamic and the **Address location** field is empty.

See [SOAP Web Service package](#).

String Operation

The Enterprise 11 or Enterprise 10 String Operation command is migrated to equivalent actions of the String package.

The following table shows the String Operation commands and their equivalent actions in Automation 360.

Enterprise 11 or Enterprise 10 commands	Equivalent Automation 360 actions and packages
Before-After	Extract
Compare	Compare
Find	Find
Length	Length
Lower Case	Lowercase
Replace	Replace
Reverse	Reverse
Split	Split
Substring	Substring
Trim	Trim
Upper Case	Uppercase

In Enterprise 11, both carriage return (CR) and newline (LF) were enumerated to calculate the total length of String Operation. However, in Automation 360, only newline (LF) is considered for the length of String Operation. Hence, the length count in the resulting output in Automation 360 is lesser.

Enterprise 11 bots can use regular expressions in the **Find** and **Replace** commands to search for the string on which you want to perform an operation. The equivalent actions in Automation 360 too can use regular expressions to search for the string on which you want to perform an operation.

In Enterprise 11, the system considers the new line character (/n) used in the variable when you use the **Find** and **Replace** commands. However, in Automation 360, the system does not consider the new line character when you use the **Find** and **Replace** commands.

When you migrate a bot to Automation 360 with the string operation set to **Before** or **After** action, the output is retrieved correctly and the operation is successful. The matching output is displayed even if no characters are present before the matched string. In Enterprise 11, bots with **Before** or **After** action do not retrieve output correctly and therefore retrieve the source string itself. If no characters are present before the matched string, the output is displayed as no match is found.

Example:

Drag Before/After Action → (Inputs : [Source = (ABCZ)] → [Before = Z] → [assign to Prompt-assign] → Output : Empty(""))

Drag Before/After Action → (Inputs : [Source = (ZABC)] → [After = Z] → [assign to Prompt-assign] → Output : ZABC

System

Lock computer, Logoff, Restart, and Shutdown actions are migrated to the equivalent actions of the **System** package in Automation 360.

See [System package](#).

Task

The following table shows the different commands that are migrated to the respective actions of the Automation 360 **Task Bot** package.

Enterprise 11 or Enterprise 10 commands	Equivalent Automation 360 actions and packages
Pause	Pause
Stop Task	Stop
Run Task	Run. The output returned by the child bots is mapped to the respective variable in the parent bots.

Terminal Emulator

Encrypt text is not supported in the **Send Text** and **Set Field** actions for Automation 360. We recommend that you use Credential Vault instead of plain text.

In Enterprise 11 and in Automation 360:

- Bots that use the following terminal model can be migrated to Automation 360:
 - VT 220 model of the VT Series terminal type
 - IBM 5555 B01 and C01 models of the TN 5250 terminal type

- A session (used to establish a connection with the terminal server) can be shared between the parent bot and a child bot. You can close a session from the child bot instead of closing the session from the parent bot.
- You can use the **Default** terminal in bots for the VT100 terminal type.
- Bots that send Japanese text using the **Send Text** command in Enterprise 11 with the **DBCS** option from the **Encoding** list and the **Japanese Shift-JIS (932)** option from the **CodePage** list selected in the **Connect** command can be migrated to Automation 360.
- **Applies only to v.24 and earlier:** In the Terminal Emulator, when you manually click the key in the keyboard, the main keyboard **Enter** is identified as {enter} in Enterprise 11, while in Automation 360, it is identified as {return}.

Automation 360 does not support legacy technology and by default supports all capabilities of Advance Technology of the Enterprise 10/Enterprise 11 bots.

The maximum index value in Automation 360 is 99999. The migration process automatically updates the value of **Field index** in the **Set Field** action to 99999 to meet the maximum value restriction. If the index value is higher than 99999 and is used in a variable, then you must change it manually.

The SSHI feature is not yet supported in Automation 360.

The **Search field** action enables you to search for field index or field name by using a text.

Bots created in Enterprise 11 no longer show the `Trying...` text after the bots are migrated to Automation 360.

See [Terminal Emulator package](#).

Variable Operation

The following are the operations when a value is **assigned** to the variable:

Value type variables

The functionality for this command has been divided into multiple packages in Automation 360.

In Enterprise 10/Enterprise 11, this command was performing assignment operations for all the supported datatypes. Automation 360 has built a dedicated **Assign** action for each data type. The migration process handles the mapping of the corrected packages and action based on the assignment that the respective variable operation is performing.

For Enterprise 11 bots that use the **Decimal configuration** option, the **To string** action of the Number package is added in the migrated bots. In Enterprise 11, the system rounds off the value based on the value specified in the **Decimal configuration** field. For example, if the value that is assigned to the variable is 13.456 and the value specified in the **Decimal configuration** field is 2, the system rounds off the value in Enterprise 11 to 13.46. In Automation 360, the value is trimmed instead of rounded off. For example, the value 13.456 will be converted to 13.45 in Automation 360.

List type variables

Operations involving on list assignments are migrated to the **Set item** of the **List** package. If the operation has a fixed value, the system creates a temporary variable and stores the fixed value in it. You can then use this temporary variable in the **Assign** action of the **List** package to save it.

Array type variables

Operations involving on array assignment is migrated to **Set value of a single cell** action of the **Datatable** package to set a value for specific rows and columns.

Dictionary type variables

Operations involving dictionary assignment is migrated to the **Put** action of the **Dictionary** package to set the value for a specific key. If the key is a combination of a variable and fix value (for example `$Dictionary(key-$id$)`), then the **String** package > **Assign** action is added to get the actual key.

System variable \$Date\$

The Enterprise 10/Enterprise 11 Variable Operation command that uses the **\$Date\$** system variable is migrated to Automation 360 by adding new date actions based on the operation being performed using **\$Date\$**. The migration process also converts the date value to a default string format – `mm/dd/yyyy HH:mm:ss`.

Random variable of sub type string: We migrate and map this directly.

The following are the variable operations when a value of the variable is **reinitialized**:

List variable

For the **Variable Operations** command that reinitialize the list variable in Enterprise 10/Enterprise 11, the migration process creates a temporary list variable with new values and assign it to the destination list variable in Automation 360.

List variable declared by reading a Text file

This command is migrated to the **Import list from text file** action in the **Legacy Automation** package.

Note: In Automation 360, the bot encounters an error if the source file is empty or does not contain a key for initializing the list variable, unlike in Enterprise 10 or Enterprise 11.

Array variable declared by reading a Text file

The Array variable type is migrated as a Table variable type in Automation 360. The system uses the **CSV/TXT** package to read and load the respective data into the table variable in the bot.

Dictionary variable

The migration process creates a temporary dictionary variable to store all keys and values. Then the system uses the **Dictionary** package > **Assign** action to update the target variable with the keys and values from the temporary dictionary variable.

Dictionary variable declared by reading a Text file

The migration process addresses this use case by adding actions to read the CSV file using the **CSV/Text** package and storing the data in a table variable. Then it adds actions to perform a loop on the table variable and uses the **Dictionary** package > **Put** action to add keys and values into the dictionary variable.

Array variable declared by reading an Excel/CSV file

The migration process addresses this use case by migrating the Array variable type as a Table variable type in Automation 360. The system adds **Open**, **Get Multiple Cells**, and **Close** actions of the **Excel Advance** package and populates the table variable.

The following are the variable operations when a value of the system variable is **reset**:

Variable Operation (resetting system variables)

The following system variables are migrated as user defined variables in Automation 360. The system adds a respective action to clear the value of the equivalent variable created in Automation 360.

- Email Cc
- Email From
- Email Message
- Email Received Date
- Email Received Time
- Email Subject
- Email To
- Error Description
- Error Line Number

Wait

Wait for window and **Wait for screen change** in Automation 360 throws an exception error if the respective window is not open/close in the specified time or the screen is not found in specified time. In these cases, the system adds try and catch block if the command was configured to stop the bot and adds the **Stop task** action in the catch block. This is to ensure that the execution behaviour of migrated bots is the same as Enterprise 10/Enterprise 11.

Because we are migrating commands with the **Stop bot** action is encapsulated with the try and catch block in Automation 360, the bot also stops if the action fails due to some other reason. During the migration process, the **Stop bot** action also adds extra error handlers in the migrated bots when the **Stop the task** option is selected.

The **Wait for window** action can have negative values for coordinates that are not supported in Automation 360. The negative values are changed to 0 during the migration process.

Web Recorder

All commands (except those mentioned below explicitly) of **Web recorder** are migrated to respective actions within the **Legacy Automation** package in Automation 360. The **Legacy Automation** package ensures that the migrated bots give the same results as Enterprise 10/Enterprise 11. However, it is not recommended to use the **Legacy Automation** package for new development.

Find broken links is migrated to **Browser > Find broken links** package. Additionally, Enterprise 10/Enterprise 11 has the "Find broken links timeout" and "Find broken links" options within the Tools > Options. Automation 360 has these options as part of the action and the timeout defaults to 10 seconds and the number of parallel threads value defaults to 10.

Download files is migrated to **Browser > Download files** package.

During the migration process, the **Extract table** action adds extra error handlers in the migrated bots when the **On error continue with next action** check box is enabled.

Window Action

All commands of Windows Actions are migrated to its equivalent actions of the Window package in Automation 360.

Enterprise 11 bots can use regular expressions in the **Get Active Window Title, Activate Window, Maximize Window, Minimize Window, Close Window,** and **Resize Window** commands to search for the window on which you want to perform an operation. The equivalent actions in Automation 360 too can use regular expressions to search for the window on which you want to perform an operation.

See [Window package](#).

XML

All commands of XML are migrated to its equivalent actions of the **XML** package in Automation 360.

The following command names have changed:

Enterprise 10/Enterprise 11	Automation 360
End XML session	End session
Start XML session	Start session
Delete Node/Attribute	Delete node
Update Node/Attribute	Update node
Get nodes action with the "Single Nodes" option selected	Get single node action
Get nodes action with the "Multiple Nodes" option selected	Get multiple node action

In Enterprise 11, when you set the XML command to **Get Node(s)** with the **Multiple Nodes** option selected, the **XPath Expression** returns only the last element of the matching expression. In Automation 360, the **XPath Expression** returns all the matching elements.

Enterprise 11 bots that extract nodes that contain namespaces from an XML file can be migrated to Automation 360. If you add a namespace to a node in an XML file, you must save and reload the XML file to reflect the changes.

See [XML package](#).

Variable mapping for migration

In migration, some variables map directly from previous product versions to Automation 360 while others behave differently or contain configuration changes.

Note: In Enterprise 11, if a bot used a variable that was followed by a space and a string that began with a dollar sign character (\$) and enclosed in parentheses, brackets, or braces, after migration, the variable field encounters an error. The error occurs because, in Automation 360, two dollar sign characters (\$\$) are required in a string to display the dollar sign. To fix this error, add another dollar sign to the string. For example, if you are using the **prompt-assignment** variable to display a string followed by \$5 [`[$Prompt-Assignment$ ($5)`], after migration, the variable field displays an error. To fix the error, edit the variable field to add another dollar sign, as follows: [`[$Prompt-Assignment$ ($$5)`].

User-defined variables

In Automation 360, all variables defined in bots are created as `Use as input` and `Use as output` types during migration to exchange values between parent bots and child bots.

If variables are mapped between a parent bot and a child bot in Enterprise 11 and some of the mapped variables are not available in either the parent bot or the child bot, the migration process removes these variables. The migration process removes such variables for child bots that are migrated along with the parent bots and for child bots that are already migrated.

For information about the list of variables supported, see [Variables support](#).

Review how the following user-defined variables are migrated.

- [Array](#)
- [Dictionary](#)
- [List](#)
- [Random](#)
- [Value](#)

Array

This section explains how **Array** variable is migrated to Automation 360. In some cases, you might have to perform some actions or ensure a few things before or after migration.

Subtype "Value"

Variables with this subtype are migrated to **Table** with all column values as **String**.

Subtype "Read from text file"

Variables with this subtype are migrated to **Table** with all column values as **String**.

The following actions are added as part of migration to configure data in the variable:

Automation 360 actions	Function
CSV/TXT > Open	Opens the file for reading.
CSV/TXT > Read	Returns the value in the Table variable.

Automation 360 actions	Function
CSV/TXT > Close	Closes the file.

Subtype "Read from database"

Variables with this subtype are migrated to the **Table** package with all column values as **String**.

The following actions are added as part of migration to configure data in the variable:

Automation 360 actions	Function
Database > Connect	Adds the Connect action with the respective connection string.
Database > Export to datatable	Adds the Export to datatable action to return the results to the datatable variable.
Database > Disconnect	Adds the Disconnect action to disconnect the database.

See also: [Database package](#).

Subtype "Read from Excel/CSV file"

Variables with this subtype are migrated to **Table** with all column values as **String**.

The following actions are added as part of migration to configure data in the variable:

Automation 360 actions	Function
Advance Excel > Open	Opens the file for reading.
Advance Excel > Get multiple cells	Returns the Table variable value if the All Cells or Range option is chosen in the variable declaration.
Advance Excel > Read now	Returns the Table variable value if the Entire Row option is chosen in the variable declaration.

Automation 360 actions	Function
Advance Excel > Read column	Returns the Table variable if the Entire Column option is chosen in the variable declaration. Additionally, the Assign list to datatable of list package is used to store the returned valued to the variable.
Advance Excel > Close	Closes the file.

Action required: In Automation 360, an empty table variable returns a runtime error. If your migrated bot contains an empty table variable, you must resolve the issue in Automation 360.

Array variable: Input types accepted by DLL function

When the system passes an Array variable from an Enterprise 11 bot to a DLL function of a different type, the DLL function accepts the following as input types:

- UInt16[], Int16[], Int32[], Int64[], Int[], Char[], Single[], Decimal[], Float[], Double[], Boolean[], bool[], Byte[], String[], and Datetime[]
- UInt16, Int16, Int32, Int64, Int, Char, Single, Decimal, Float, Double, Boolean, bool, Byte, String, and Datetime
- List<UInt16>, List<Int16>, List<Int32>, List<Int64>, List<Int>, List<Char>, List<Single>, List<Decimal>, List<Float>, List<Double>, List<Boolean>, List<bool>, List<Byte>, List<String>, List<Date-Time>
- UInt16[,], Int16[,], Int32[,], Int64[,], Int[,], Char[,], Single[,], Decimal[,], Float[,], Double[,], Boolean[,], bool[,], Byte[,], String[,], and Datetime[,]

More information

You can migrate your Enterprise 10 or Enterprise 11 bots that include Array variables.

The following are some key behavior differences:

- The index position starts with 1 in Enterprise 10 and Enterprise 11, while the index position starts with 0 in Automation 360. For example, `$arrayVariable(1,1)$` becomes `$arrayVariable[0][0]$`

- If an array has 10 rows/columns and a loop is running more than 10 times, then Enterprise 10/Enterprise 11 returns the name of the array variable with the index position.
- In Enterprise 11, if you pass a constant string value to an array index in any command (for example `$array(field1)`, where `field1` is not a variable), the value is used as is (for example, `$array(field1)`). However, after the bot is migrated to Automation 360, a compile time error occurs if the command has a non-variable value.
- In Enterprise 11, if you pass an array variable without any index (for example "`$array$`", "`$array()`", where index is missing), the value is used as is (for example, "`$array$`", "`$array()`"). However, after the bot is migrated to Automation 360, a compile time error occurs.

Action required: If an invalid index is used to access any arrays in Enterprise 11, ensure that you resolve the bot error before or after migration.

Dictionary

This section explains how **Dictionary** variable is migrated to Automation 360. In some cases, you might have to perform some actions or ensure a few things before or after migration.

Run Logic

In Enterprise 11, when you perform a **Run Logic** operation, you can select a specific key from the Dictionary variable and map it to the required value variable.

In Automation 360, you can only map variables directly and cannot map a Dictionary(key) variable to a string.

Subtype "Value"

The system migrates these variables to the **Dictionary** type with the **String** subtype in Automation 360.

Subtype "Read from CSV file"

The migration process adds actions to read the CSV file using the **CSV/Text** package and stores the data in a table variable. The process also adds actions to perform a loop on the **Table** variable and uses the Put action of the **Dictionary** package to add the key and values in the **Dictionary** variable.

Dictionary variable: Input types accepted by DLL function

When the system passes a dictionary variable from an Enterprise 11 bot to a DLL function of a different type, the DLL function accepts the following as input types: UInt16, Int16, Int32, Int64, Int, Char, Single, Decimal, Float, Double, Boolean, bool, Byte, String, and Datetime.

More information

You can migrate your Enterprise 10 or Enterprise 11 bots that include Dictionary variables.

The following table describes some key behavior differences and how they work in Automation 360:

Enterprise 10 or Enterprise 11 behavior	Automation 360 behavior
Dictionary keys are not case-sensitive in Enterprise 10 or Enterprise 11.	Dictionary keys are case-sensitive in Automation 360. To maintain the bot execution resilience, the migration process converts all dictionary keys to lowercase values. String express Lower case is used if a variable is used as a dictionary key to obtain the lowercase key name.

List

This section explains how **List** is migrated to Automation 360. In some cases, you might have to perform some actions or ensure a few things before or after migration.

Subtype "Value"

These variables are migrated to **List** with subtype **String**.

Sub-type Array

These variables are migrated to **List** with subtype **String**.

Subtype "Reading from text file"

Where a variable that is declared by reading a file is called, the **Import list from text file** action of the **Legacy automation** package is added above the action that is being migrated.

Declared as "Make Random"

The **List** variable can be declared as `Make Random` in Enterprise 10 or Enterprise 11 to return a random item from the list. The migration process adds the new **Size** action to the **List** package to get the list size and adds the **Assign a random number** action to the **Number** package to find the random position and use it to get a random list item.

Action required: In Automation 360, an empty list variable used outside a loop returns a runtime error. If your migrated bot meets this criteria, you must resolve the issue in the Automation 360 environment.

More information

- In Enterprise 10 and Enterprise 11, **List** is accessible without specifying any index. In

Automation 360, you must specify the respective index to retrieve the specific value from the list.

Example: List variables can be accessed by index in the following way:

```
$listVariable[0]$
```

Here, 0 represents the first value in the list.

- Index position starts with 1 in Enterprise 10 or Enterprise 11, whereas it starts with 0 in Automation 360.
- **Enterprise 11 behavior:** In Enterprise 11, when a list with a fixed index is used, the system returns the value available in the first index of the list.

Example: For example, consider that you have a list with values 1, 2, 3, and 4, and you use `$IntList(3)$` to retrieve the value in the third index position of the list. The system returns the value available in the first index position of the list (1) instead of the specified index position (3).

Automation 360 behavior: In Automation 360, the system returns the value available in the specified index position (for the above example, it returns 3).

Behavior of migrated bots: Enterprise 11 bots that use such expressions with fixed indexes in the list and are migrated to Automation 360 return the value available in the specified index position.

- If a list has 10 items and a loop is running for more than 10 times, then Enterprise 10 or Enterprise 11 returns the first value of the list after the 10th iteration.

List variable: Input types accepted by DLL function

When the system passes a List variable from an Enterprise 11 bot to a DLL function of a different type, the DLL function accepts the following as input types:

- UInt16[], Int16[], Int32[], Int64[], Int[], Char[], Single[], Decimal[], Float[], Double[], Boolean[], bool[], Byte[], String[], and Datetime[]
- UInt16, Int16, Int32, Int64, Int, Char, Single, Decimal, Float, Double, Boolean, bool, Byte, String, and Datetime
- List<UInt16>, List<Int16>, List<Int32>, List<Int64>, List<Int>, List<Char>, List<Single>, List<Decimal>, List<Float>, List<Double>, List<Boolean>, List<bool>, List<Byte>, List<String>, List<Date-Time>
- UInt16[,], Int16[,], Int32[,], Int64[,], Int[,], Char[,], Single[,], Decimal[,], Float[,], Double[,],

Boolean[,], bool[,], Byte[,], String[,], and
Datetime[,]

See also: [List package](#).

Random

This section explains how **Random** variable is migrated to Automation 360. In some cases, you might have to perform some actions or ensure a few things before or after migration.

Subtype "Random String"

When there is a Random variable of the subtype **String**, the migration process adds the **Generate random string** action of the **String** package to generate a random string above the **If** condition and assigns the value to the respective migrated variable in Automation 360

Subtype "Random Number"

When there is a Random variable of the subtype **Number**, the migration process adds the **Assign a random number** action of the **Number** package to generate a random string above the **If** condition and assigns the value to the respective migrated variable in Automation 360.

Value

This section explains how **Value** is migrated to Automation 360. In some cases, you might have to perform some actions or ensure a few things before or after migration.

Subtype "Value"

These variables are always migrated as **String** in Automation 360, even if they have number, boolean, or datetime values in them. Expressions are used in Automation 360 to convert a string to other types if required.

Subtype "Read from text file"

To maintain the integrity of bot execution during migration, where a variable that is declared by reading a file is called, the **Import string from text file** action of the **String** package is added just above the action being migrated.

If Enterprise 11 bots contain variables that read values from a text file, then these bots are migrated using the **Read variable** action.

If a specific variable does not exist in the text file, or if the specific variable is reading a value from a file that does not exist, then Automation 360 generates an exception error.

After migration, when you run the bot that contains the **Read from file** variable, the reading occurs only once in the **Read variables** action at the start of the bot running process. If the file that the variable is trying to read gets updated while the bot is running, then the **Read file** variable is not refreshed.

More information

Bots that use value type variables within a variable can be migrated to Automation 360. For Enterprise

11 bots that use a variable within a variable in the Insert Keystrokes command, the **Evaluate value** action of the String package is added in the migrated bot

See also: [String package](#) | [Number package](#) | [Boolean package](#) | [Datetime package](#)

System variables

In some cases, system variables such as Error Line Number, Error Description, and OS Name return a different value in Automation 360. Bots using these variables in a decision-making or string operation require a review after migration.

Some system variables used inside a loop are user-defined variables in the loop after migration. In some instances, the user-defined variable might require some configuration in the migrated bot.

Some system variables are migrated as actions in Automation 360. These actions are added just above the action that uses these variables.

If a variable is defined at the index position for the following system variables, you might have to resolve the migrated bots because the migration process could not determine if the variable contains an index or column name. If you do not resolve it, the bot might return a `Key not found in record` runtime error. The migration process treats the value of a variable as name; but if it is an index, you must change it accordingly.

- \$Filedata Column\$
- \$Dataset Column\$
- \$XML Data Node\$
- \$Excel Column\$

The following table provides information about the various system variables and how they are migrated to Automation 360. Some variables are part of actions, some become actions, and some are known as system variables but have syntax changes.

Note: Migrated bots do not preserve data outside of the loop for the following system variables:

- \$FolderName\$
- \$FileName\$
- \$Extention\$

System variable	How they are migrated to Automation 360
\$Day\$	Becomes <code>\$System:Day.Number:toString\$</code> in Automation 360
\$FileName	After migration, the system automatically creates this variable according to the Automation 360 naming convention, to run the migrated bots successfully.
\$Error Description	After migration, the system automatically creates this variable according to the Automation 360 naming convention, to run the migrated bots successfully.
\$Error Line Number\$	After migration, the system automatically creates this variable according to the Automation 360 naming convention, to run the migrated bots successfully.

System variable	How they are migrated to Automation 360
\$Extension\$	After migration, the system automatically creates this variable according to the Automation 360 naming convention, to run the migrated bots successfully.
\$Folder Name\$	After migration, the system automatically creates this variable according to the Automation 360 naming convention, to run the migrated bots successfully.
\$Month\$	Becomes <code>System:Month.Number.toString</code> in Automation 360
\$Year\$	Becomes <code>System:Year.Number.toString</code> in Automation 360
\$Date\$	Becomes <code>System:Date</code> in Automation 360 The date format set for the variable in the Enterprise 11 or Enterprise 10 bot is stored in the AADefaultDateFormat global value.
\$Hour\$	Becomes <code>System:Hour.Number.toString</code> in Automation 360
\$Minute\$	Becomes <code>System:Minute.Number.toString</code> in Automation 360
\$Clipboard\$	Becomes <code>System:Clipboard</code> in Automation 360
\$Machine\$	Becomes <code>System:Machine</code> in Automation 360
\$MiliSecond\$	Becomes <code>System:MiliSecond.Number.toString</code> in Automation 360
\$ArrayColumns(\$arrayVariable\$)\$	Becomes an expression in Automation 360: <code>\$arrayVariable.DataTable.columnCount</code>
\$ArrayRows(\$arrayVariable\$)\$	Becomes an expression in Automation 360: <code>\$arrayVariable.DataTable.rowCount</code>
\$AAControlRoom\$	Becomes <code>System:AAControlRoom</code> in Automation 360
\$RAMUsage\$	Becomes <code>System:RAMUsage</code> in Automation 360
\$TotalRAM\$	Becomes <code>System:TotalRAM</code> in Automation 360
\$OSName\$	Enterprise 10 or Enterprise 11 returns the Microsoft Windows 10 Pro 64-bit value. In Automation 360, this variable becomes <code>System:OSName</code> and returns the Windows 10 64-bit .
\$CPUUsage\$	Becomes <code>System:CPUUsage</code> in Automation 360
\$Counter\$	This system variable is deprecated in Automation 360. The migration process creates a user-defined variable type Number and modifies the bot to ensure it provides the same output as the 11.x bot. If you have used the <code>\$Counter\$</code> variable in a loop, the migration process replaces the variable with the <code>\$Condition-Counter\$</code> variable in the migrated bot and sets its value to 1.
\$Dataset Column\$	This system variable is now part of the For each row in a SQL query dataset iterator in Loop . The system creates a new variable in the loop and uses it inside the loop wherever <code>\$Dataset Column\$</code> is present. If the variable is used outside a loop, it is converted to a record type user-defined variable and assigned to a Record action, which enables you to assign the value of the source record variable to the destination record variable. Therefore, when you run migrated bots that contain this variable, data from the last row is displayed.

System variable	How they are migrated to Automation 360
\$Excel Column\$	<p>This system variable is now part of the For each row in worksheet iterator in Loop. The system creates a new variable in the loop and uses it inside the loop wherever \$Excel Column\$ is present.</p> <p>If the variable is used outside a loop, it is converted to a record type user defined variable and assigned to a Record action, which enables you to assign the value of the source record variable to the destination record variable. Therefore, when you run migrated bots that contain this variable, data from the last row is displayed.</p>
\$Extension\$ and \$FileName\$	<p>These system variables were used in the For each file in a folder iterator of Loop. However, in Automation 360, a dictionary type variable is used to capture the extension and file name, which can be retrieved with "extension" and "name" key name respectively.</p> <p><i>Loop package.</i></p>
\$Email\$ \$Email From\$ \$Email Message\$ \$Email Received Date\$ \$Email Received Time\$ \$Email Subject\$ \$Email To\$ \$Email Sent date\$ \$Email Sent time\$	<p>These system variables were used inside the For each mail in mail box iterator of Loop. In Automation 360, a dictionary type variable is used to capture all email values that can be retrieve with the respective keys.</p> <p>See <i>Using dictionary variable for email properties.</i></p>
\$Filedata Column\$	<p>This system variable is now part of the For each row in CSV/TXT iterator in Loop. The system creates a new variable in the loop and uses it inside the loop wherever \$Filedata Column\$ is present.</p> <p>If the variable is used outside a loop, it is converted to a record type user defined variable and assigned to a Record action, which enables you to assign the value of the source record variable to the destination record variable. Therefore, when you run migrated bots that contain this variable, data from the last row is displayed.</p>
\$FolderName\$	<p>This system variable is used inside the For each folder in a folder iterator of Loop. In Automation 360, the value is returned to the string variable specified in the loop.</p>

System variable	How they are migrated to Automation 360
\$Excel Cell Row\$	<p>This system variable is migrated to the Get row number action of the Excel package in Automation 360 and added just above the action in which it is used.</p> <p>In Enterprise 11, the last executed Excel session is used as a Session Name value in the Excel Cell Row variable. However, in Automation 360, the Excel Cell Row variable is not present. So, the last executed Excel session used before Excel Cell Row is taken as a value for Get row number during migration.</p> <p>Workaround: Create a string variable, assign a name to it, and add it after the Excel command in the migrated bot. Use the newly created string variable in Get row number.</p>
\$Excel Cell Column\$	<p>This system variable is migrated to the Get column name action of the Excel package in Automation 360 and added just above the action in which it is used.</p> <p>Enterprise 10/Enterprise 11 returns the first column (for example column A) for the \$Excel Cell Column\$ even if the active cell is not column A (for example column F10) inside a loop. In Automation 360, the same configuration returns the active cell (for example column F10). Below are the use cases that result in the above behavior change:</p> <ul style="list-style-type: none"> • Excel is opened with or without <code>contains header checked</code> containing 10 rows. • Set active cell as F10 • A loop is performed to row read • Put a Message Box with \$Excel Cell Column\$ in it • Run the bot <hr/> <p>Action required: Considering the behavior differences, you might have to change some bots.</p>
\$Excel Cell\$	<p>This system variable is migrated to the Get cell address action of the Excel package in Automation 360 and added just above the action in which it is used.</p>

System variable	How they are migrated to Automation 360
\$AATaskExecutor\$	<p>This system variable becomes \$AATaskExecutor\$ and \$AATaskInvoker\$ in Automation 360.</p> <p>In Enterprise 11, this variables return various values about the task invoker and executor (for example, the invoker's and executor's first name, last name, email address, and username). In Automation 360, the \$AATaskInvoker\$ variable returns the following values:</p> <ul style="list-style-type: none"> • Invoker_Username • Invoker_Firstname • Invoker_Lastname • Invoker_Email <p>The \$AATaskExecutor\$ variable returns the following values:</p> <ul style="list-style-type: none"> • Executor_Username • Executor_Firstname • Executor_Lastname • Executor_Email • Executor_Type
\$AATaskName\$	<p>This system variable becomes \$System.AATaskName\$ in Automation 360.</p> <p>In Enterprise 10/Enterprise 11, this variable returns the value to your computer path directory (for example <code>Automation Anywhere\My Tasks\My Folder\My Folder2\AATaskName.atmx</code>). In Automation 360, in returns the value to the bot path relative to the Control Room (for example <code>Bots/AATaskName</code>).</p> <hr/> <p>Action required: Considering the values returned are different between the versions, you might have to change some bots.</p> <hr/>

System variable	How they are migrated to Automation 360
\$AAApplicationPath\$	<p>Enterprise 11 specific: This Enterprise 11 system variable returns the path set by users in the Tool > Option setting of what is known as the “client application”. In Automation 360, the variable becomes a global value. The migration process maps this change automatically and the value set of each user in Enterprise 11 is copied to the global value variable @AAApplicationPath.</p> <hr/> <p>Note: No action is required by a user for Enterprise 11 because the system variable is automatically mapped as a global value during migration if you have used the restored Enterprise 11 database when installing Automation 360.</p> <hr/> <p>Enterprise 10 specific: This Enterprise 10 system variable does not automatically migrate to Automation 360 as a global value, so some action is required after migration.</p> <hr/> <p>Action required:</p> <ul style="list-style-type: none"> Enterprise 10 users must create the AAApplicationPath global value in Automation 360 and update it with the Enterprise 10 path. This update ensures that when you run the bot in Automation 360, the AAApplicationPath folder value is uniquely resolved for each user. <p>Example: If the Enterprise 10 path value for AAApplicationPath is <code>D:\John.Doe\My Documents\Automation Anywhere Files</code>, then you must create the AAApplicationPath global value in Automation 360 and update with this path.</p> <ul style="list-style-type: none"> Ensure that the CAN be changed option is selected when creating the AAApplicationPath global value. Bot Creators and Bot Runners must set the value for the AAApplicationPath global value before they run the migrated bots. <hr/> <p>See Global values.</p>
\$AAInstallationPath\$	<p>This system variable becomes \$System:AAInstallationPath\$ in Automation 360.</p> <p>Enterprise 10/Enterprise 11 behavior: Returns the Enterprise Client installation path (for example <code>C:\Program Files (x86)\Automation Anywhere\Enterprise\Client</code>).</p> <p>Automation 360 behavior: Returns the Bot Agent installation path (for example <code>C:\Program Files\Automation Anywhere\Bot Agent</code>).</p> <hr/> <p>Action required: Considering the values returned are different between the versions, you might have to change some bots.</p>
\$Current Directory\$	<p>This system variable is deprecated in Automation 360 and automatically converted to a user-defined variable during migration. The value of the variable is set per the value defined in Loop > For each file in a folder and For each folder in a folder.</p>

System variable	How they are migrated to Automation 360
\$Date\$	<p>This system variable becomes \$System:Date\$ in Automation 360.</p> <p>Enterprise 10 and Enterprise 11 behavior: The \$Date\$ variable returns the current date and time in a format specified in the <code>AA.Settings.XML</code> file.</p> <p>Automation 360 behavior: The \$System:Date\$ variable returns values of type Datetime and users must use an action to change it in to String. To minimize disruption to users, the migration process does the following to each \$Date\$ instance:</p> <ul style="list-style-type: none"> • Creates a temp variable \$SystemDateInString\$ of type String. • Adds a ToString action of Datetime package to convert \$System:Date\$ to string with customer format as "MM/dd/yyyy HH:mm:ss" and store the output into above string variable. • Uses this string variable where ever \$Date\$ is used. • The above steps are repeated for each occurrence of \$Date\$. <p>Depending on how your bot is configured, you might have to update the date/time configuration.</p> <hr/> <p>Action required: Change the bot if the date format is not <code>MM/dd/yyyy HH:mm:ss</code>.</p>
\$Error Line Number\$ \$Error Description\$	<p>In Enterprise 10 or Enterprise 11, these system variables are used after the Error Handling command. In Automation 360, the value is returned to the user defined variables specified in the Catch action.</p>
\$PDFFileName\$ \$PDFTitle\$ \$PDFAuthor\$ \$PDFSubject\$	<p>In Enterprise 10 or Enterprise 11, these system variables were used after any PDF command. In Automation 360, a Dictionary type variable is used to capture all PDF values that can be retrieve with the respective keys. Every PDF action returns this Dictionary variable with corresponding PDF values.</p> <p>See Using a dictionary variable for PDF properties.</p>
\$System\$	<p>In Enterprise 11 or Enterprise 10, this system variable is used to retrieve information about a device's settings and its performance. In Automation 360, the Get environment variable action of the System package is used.</p> <p>See Environment variables for System package.</p>
\$WorkItem\$	<ul style="list-style-type: none"> • \$WorkItem\$ is String: Migrated as is. • \$WorkItem\$ is Number <ul style="list-style-type: none"> • If it is displaying or logging a Number, the number is changed to a String • If it is displaying as a Number, migrate as a Number type • \$WorkItem\$ is DateTime: Migrated as is, but the migrated package results in an error, so you cannot migrate the package. <hr/> <p>Note: For the DateTime type, you cannot migrate the package yet, so the associated bot must be migrated at another time.</p>

System variable	How they are migrated to Automation 360
\$Trigger Value\$	<p>Becomes \$TriggerValue\$ in Automation 360. For Enterprise 11 bots that use this variable, perform the following tasks to run the migrated bots successfully:</p> <ul style="list-style-type: none"> • Create the equivalent triggers in Automation 360 for all the triggers that were used in Enterprise 11 bots. <p>The output of triggers in Automation 360 is stored in a record type variable.</p> <ul style="list-style-type: none"> • Update the migrated bots to use the appropriate actions to assign the values from the record variable that contains output from triggers to the \$TriggerValue\$ variable. <p>For example, if you want to assign a host and port key from the record variable of an email trigger to the \$TriggerValue\$ variable, use the \$EmailTriggerData(host)\$ \$EmailTriggerData(port)\$ expression. Similarly, to retrieve location of a file use \$FileTriggerData(file)\$ expression and to retrieve location of a folder use \$FolderTriggerData(fromFolder)\$ expressions.</p>
\$Table Column\$	<p>This system variable is now part of the For each row in table iterator in Loop. The system creates a new variable in the loop and uses it inside the loop wherever \$Table Column\$ is present.</p> <p>If the variable is used outside a loop, it is converted to a record type user defined variable and assigned to a Record action, which enables you to assign the value of the source record variable to the destination record variable. Therefore, when you run migrated bots that contain this variable, data from the last row is displayed.</p>
\$XML Data Node\$	<p>This system variable is used inside the For each node in XML dataset iterator of Loop. In Automation 360, the value is returned to the string variable specified in the loop.</p> <p>If the variable is used outside a loop, it is converted to a string type user defined variable and assigned to a Record action, which enables you to assign the value of the source record variable to the destination record variable. Therefore, when you run migrated bots that contain this variable, data from the last row is displayed.</p>

Credential variables

The credential variables used for the **Username** and **Password** fields in Enterprise 10 and Enterprise 11 are migrated as **Credential variables** in Automation 360.

The method of migration differs for Enterprise 10 and Enterprise 11.

To learn how Enterprise 10 credentials are migrated, see the section on credentials in [How Enterprise 10 data is copied to Automation 360](#).

The credential variables used in fields other than the **Username** and **Password** fields are migrated as **Global Values**. These fields include hostname, port number, and so on. The migrated global values have the following syntax: <credentialname>_<attributename>. For example in Enterprise 11, a credential FTPConnection with an attribute hostname is migrated as FTPConnection_hostname.

The following table provides information about the packages and actions that support the migration of credential variables from Enterprise 11 to Automation 360:

Package	Actions
Active Directory	<ul style="list-style-type: none"> • Create and Modify User • Create and Modify Group • Create and Modify Object • Search • Get Property
Database	<ul style="list-style-type: none"> • Connect with connection string • Username • Password
Email Automation	<ul style="list-style-type: none"> • Hostname • Username • Password
Excel	Open Spreadsheet
FTP / SFTP	Connect
Insert Keystrokes	All keystrokes that require use of credentials
Legacy Automation	Set Text in Manage Web Controls action
Manage Window Controls	<ul style="list-style-type: none"> • Set Text • Append Text
PDF	<ul style="list-style-type: none"> • PDF to Image • Extract Form Fields • Extract Text • Split, Encrypt, and Decrypt Document
PGP	<ul style="list-style-type: none"> • Encrypt and Decrypt Files • Create Keys
Recorder	<ul style="list-style-type: none"> • Set Text • Append Text <hr/> <p>Note: Migrated from Object Cloning command as Capture action.</p> <hr/>

Package	Actions
REST Web Service	<ul style="list-style-type: none"> • URI • Username • Password • Headers • Operation parameters <hr/> <p>Note: Domain name is migrated as a global value.</p>
SOAP Web Service	<ul style="list-style-type: none"> • Username • Password • Headers • Operation parameters • Raw data parameters
Terminal Emulator	<ul style="list-style-type: none"> • Connect command for SSH2 with User and Key file authentication options • Send Text • Set Field
Web Recorder	Manage Web Controls with Set Text and Append Text functions

Global values in migrated bots

After migration, bots use various global values to support different capabilities provided in Enterprise 11 or Enterprise 10. You must create or update these global values in Automation 360 to ensure that the migrated bots run successfully.

Note: Global values are created when you migrate bots for the first time using the Bot Migration Wizard or migration APIs. If you are using the Migration package to migrate bots, you must create the global values manually.

The following table lists the various global values that are used by the migrated bots to run successfully:

Global value	Description
AAApplicationPath	<p>Use this global value to specify the physical path of a bot or file that is used in the current bot.</p> <ul style="list-style-type: none"> • Enterprise 11: This global variable is automatically created by the system if you have used the restored the Enterprise 11 database when installing Automation 360. • Enterprise 10: You must create this global value in Automation 360 and update all the Enterprise 10 bots that have used the AAApplicationPath system variable to the AAApplicationPath global value in Automation 360 with the same value as Enterprise 10. <p><i>How AAApplicationPath variable is migrated</i></p>
AABasePath	<p>This global value is equivalent to the Start In Path of Task option in Enterprise 11 or Enterprise 10.</p> <p>In Enterprise 11 or Enterprise 10, this option is used to specify the location of new files or folders when a relative path for that file or folder is specified in a command. When you migrate Enterprise 11 or Enterprise 10 bots, keep in mind the following:</p> <ul style="list-style-type: none"> • If the path in the Enterprise 11 or Enterprise 10 bot is an absolute path, the migration process does not make any change in the migrated bot. • If the path in the Enterprise 11 or Enterprise 10 bot is a relative path and does not contain any variable, the migration process prefixes the path with the AABasePath global value. • If the path in the Enterprise 11 or Enterprise 10 bot is a relative path and contains variables: <ul style="list-style-type: none"> • If the variable contains an absolute path, the runtime execution process does not make any change in the migrate bot. • If the variable contains a relative path, the runtime execution process prefixes the path with the AABasePath global value.
AADefaultDateFormat	Use this global value to change the default date and time format for Date variables.
AAE_EmailSettings_auth	Use this global value to enable or disable authentication for the email server.

Global value	Description
AAE_EmailSettings_clientId	Use this global value to specify the client ID that is generated when you registered the application in the Microsoft Azure portal.
AAE_EmailSettings_domainName	Use this global value to specify a domain name for the email server.
AAE_EmailSettings_host	Use this global value to specify the host name of the email server that you want to use to send email notifications about the status of a bot.
AAE_EmailSettings_port	Use this global value to specify the port that you want to use to connect to the email server.
AAE_EmailSettings_ssl	Use this global value to specify whether the email account uses the secure connection.
AAE_EmailSettings_tenantId	Use this global value to specify the tenant ID that is generated when you registered the application in the Microsoft Azure portal.
AAProxyHost	Use this global value to specify the proxy host that will primarily be used by the REST Web Service and SOAP Web Service actions.
AAProxyPort	Use this global value to specify the proxy port that will primarily be used by the REST Web Service action.
AARestTimeOut	Use this global value to specify the timeout value, in milliseconds, for the REST Web Service action. This value can be used when the REST server takes a long time to respond.
AASoapTimeOut	Use this global value to specify the timeout value, in milliseconds, for the SOAP Web Service action. This value can be used when the SOAP server takes a long time to respond.
AAWaitForControl	Use this global value to specify the maximum wait time, in seconds, for the Control Room.
JcoDllPath	Use this global value to specify the DLL path for the Java connector used in SAP Business Application Programming Interface (BAPI).
JcoJarPath	Use this global value to specify the JAR path for the Java connector used in SAP BAPI.

Verify the bot migration

It is important that you verify that the migration is complete and the migrated bot runs successfully in the Automation 360 environment. The bot might have been converted, but it might contain errors that prevent it from running successfully.

1. Log in to your Automation 360 environment from a machine with the Bot Agent installed using a Bot Creator account and the "View Migration" permission.

2. Verify that the migration completed successfully by clicking **Administration > Migration**.
3. Confirm that your migration instance has the `successful` status (green check mark) and the **Migrated Item** column shows 1 to indicate that 1 bot was migrated.
If the **Migrated Item** column shows 0, your bot has not migrated successfully and will not be available on the **Automation** page.
4. Verify that the bot runs successfully by clicking **Activity > In progress**.
5. Navigate to the migrated bot.
For example, if you migrated a bot from the `My Tasks` folder, then navigate to the same folder to find your migrated bot.
6. Click the bot and fix any errors.
7. Run the bot to confirm that all errors have been fixed.

Related concepts

[Migrate to Automation 360](#)

Related tasks

[View changes to migrated bots using Bot Assistant](#)

The Bot Assistant provides a comprehensive view of all the lines in a bot that require your review or action, or which have errors and therefore require you to address them. You can quickly identify areas of bots that require your attention and view changes in an Enterprise 11 or Enterprise 10 bot after migration Automation 360.

View migration reports

Use the reports to analyze the status of individual bot migration, data migration, and audit log migration and identify the status and summary of the individual migration.

You must have the **View migration** permission to access these reports.

The migration reports provide summary and status based on following type of migration:

- The bot migration that includes details about the conversion of Enterprise 10 or Enterprise 11 bots to Automation 360.
- The data migration that include details about copying Enterprise 10 data to Automation 360.
- The audit migration includes details about migrated Enterprise 11 audit log data to Automation 360.

Access the reports from the **Administration > Migrations > View migration** icon associated with the migration instance for which you want to view the report.

- **Bot migration reports:** Applies to both Enterprise 10 and Enterprise 11.

View the following information:

- Migration details such as name of the migration instance, its description, and status.
- Migration results such as the start and end time of the migration process, status of the migration, and the number of items migrated.
- Settings: Whether the option to overwrite files was selected.
- Bot Runners: Information about the run-as user selected for the migration instance.
- Bot migration results such as all the bots (parent bots and their child bots) that are migrated and their status.

The bot migration result separately lists the bots that might require action or review after migration. Navigate to the each tab to view the list of bots that will require action or review and plan the post migration steps accordingly.

Click the View migration issues icon associated with an unsuccessfully migrated bot to see the unsupported commands or attributes.

- General details about the user who created the migration instance, last modification date, and its object type.
- Bot Insight Migration Results: Applies to Enterprise 11 only.

View Bot Insight results if you have migrated Enterprise 11 analytics bots. This tab displays information such as the status of the Bot Insight migration, number of Bot Insight dashboards, and data rows that are migrated, not migrated, or skipped.

- **Data migration reports:** Applies to Enterprise 10 only.

View the following information:

- Migration details such as name of the migration instance, its description, and status.
- Data migration results such as the start and end time of the migration process, status of migration, and number of items migrated.
- Roles that are copied and their status.
- Users that are copied and their status.
- Auto-login credentials that are copied and their status.
- Bots that are copied and their status.
- Schedules that are copied and their status. The copied schedules are disabled in Automation 360 because migration of the associated devices is not supported and therefore they are not available.
- General details about the user who created the migration instance, last modification date, and its object type.

- **Audit log migration reports:** Applies to Enterprise 11 only.

View the following information:

- Migration details such as name of the migration instance, its description, and overall status of migration such as in progress, successful, or unsuccessful.
- Migration results such as the start and end time of the migration process, duration, and number of items skipped, not migrated, or migrated.
- Audit log migration results such as file path of audit log JSON files, status of each `es_export.json` file if it was skipped, not migrated, migrated, or is pending for migration. It also displays the reasons because of which a particular `es_export.json` file was skipped or unsuccessful when migrating audit logs.
- General details about the user who created the migration instance, last modification date, and its object type.

View the following video on how to review the bot migration report:

<https://fast.wistia.net/embed/iframe/sd2ars8ph0>

Export to CSV

You can export two sets of data to a CSV file: the migration instances on the **All migrations** page and bot migration results data, including any action mapping for each bot. Exported data can be used for offline analysis and to identify bots that failed the migration and their associated failed actions.

For migration instance data, the export process exports all data (including hidden data columns), but only for the current page. If you have migration instances on additional pages, you must navigate to those pages to export that data. For migration result data, all pages are exported, even if the data is paginated.

Users with the "View migration" permission can perform the export.

1. Click **Administration > Migrations**.
2. **Export migration instances:**
 - a) Use the checkboxes to select the migration instances you want to export.
 - b) Click the **Export checked items to CSV** icon.
3. **Export migration results data:**
 - a) Select the migration instance where **Type** is "Bot migration" that you want to export.
Only bot migration results can be exported.
 - b) Click the **Export bot migration results** option to export the data.
You can also export from inside the Migration report.
4. Open the CSV file to see the exported data.

View changes to migrated bots using Bot Assistant

The Bot Assistant provides a comprehensive view of all the lines in a bot that require your review or action, or which have errors and therefore require you to address them. You can quickly identify areas of bots that require your attention and view changes in an Enterprise 11 or Enterprise 10 bot after migration Automation 360.

- Enterprise 11 or Enterprise 10 bots must be migrated to Automation 360.
- The user reviewing the migration review and action messages must have the Bot Creator or Bot Runner license assigned to them.
- Bot Creators must have the **View migration** permission to view the migration review and action messages in the Bot Assistant.

Review messages are available for bots that are successfully migrated to Automation 360 but with some changes in the migrated bots. These review messages indicate changes in the behavior of the Enterprise 11 or Enterprise 10 commands after they are migrated to Automation 360.

You can open the Bot Assistant for a migrated bot that is listed in the **Messages** tab of the **Bot Scanner** report. Review the messages about the changes in the commands after migration and mark these messages as reviewed after analyzing the change. The Bot Assistant also enables you to review all the changes made in a bot from the Bot editor.

1. On the left pane, click **Automation**.
A list of available and forms is displayed.

2. Open the migrated bot for which you want to review the messages.
3. Click the Bot Assistant icon on the toolbar to open the Bot Assistant.
4. Click **Get started**.
5. On the Bot Assistant screen, click the **Need review** tab to list the messages that require review.
6. Click a message in the **Need review** tab to view detailed information about the change.
7. Click the **Mark as reviewed** option to mark the message as reviewed.

The messages that are marked as reviewed are available in the **Reviewed** tab.

Note: You can mark a message as reviewed only for the migrated bots that are available in your private repository.

See the following video on how to use the Bot Assistant to review changes to migrated bots

<https://fast.wistia.net/embed/iframe/ox8708f301>

Migration messages

Migration messages might display at any stage of the migration or Internet Explorer bot conversion. You can review or act on migration messages from these possible sources: Bot Scanner report, Bot Assistant or Bot migration report.

Note:

- Some messages described on this page do not include a cause or action when the cause is provided as part of the message and do not require any further action.
 - This page also includes Internet Explorer conversion messages that are applicable only for customers impacted by the Internet Explorer end-of-life (EOL) and have chosen to convert IE bots.
-

Action required messages

These messages in the Bot Scanner report, Bot Migration Wizard, and Migration Assistant after you migrate the bots. You must perform certain actions to successfully run the bots. We recommend that you review the cause and action required to update and run these bots.

Code	A101
Message	<p>For the migrated bot to run, update the <name> variable if the variable is used as an index position and not a column name.</p> <p>If the variable is used as a column name, no further action is needed. If it is used as an index position create a new number type variable. Also note that Automation 360 starts index position from 0 instead of 1.</p>

Cause	If you used the <code>FileData Column[\$variable\$]</code> or <code>Excel Column[\$variable\$]</code> system variables in the Enterprise 11 or Enterprise 10 bot, it is assumed that you have used the column name in the <code>\$variable\$</code> . In such cases, the migrated bot contains the <code>FileData Column{\$variable\$}</code> expression.
Action	If the <code>\$variable\$</code> in the Enterprise 11 or Enterprise 10 bot contains the column number, update the expression in the migrated bot to <code>FileDataColumn[\$var.String:toNumber()\$]</code> .

Code	A103
Message	For the migrated bot to run, update the Task bot: Run action in the <i>migrated bot</i> by specifying the credential variable for input parameter . A Credential Vault variable cannot be passed in an insecure manner .
Cause	The fields in the migrated Enterprise 11 or Enterprise 10 bot display the value as plain text, so to prevent the risk of a security breach in Automation 360, the Credential Vault variable is restricted from passing it in a nonsecure (or insecure) manner. <i>Unsupported features with workaround</i>

Code	A108
Message	For the migrated bot to run, update the action in the <i>migrated bot</i> by specifying an appropriate Credential Vault Value . An Automation 360 Credential Vault Value needs to match version 10.x / 11.x Credential Vault value .
Cause	The migrated bot does not have the Credential Vault value assigned to the corresponding action.
Action	To run the migrated bot, create or update the Credential Vault value and assign it to the corresponding action. Ensure that the Credential Vault value in Automation 360 is same as the Enterprise 10 or Enterprise 11 Credential Vault value.

Code	A109
Message	Referenced variables are missing in the V10/11 bot. For the migrated bot to run, update the corresponding actions in the migrated bot by providing missing required variables.
Cause	Enterprise 11 or Enterprise 10 bot references a non-existent variable in the Variable Operation command.

Action	Either create a variable with the same name and type, or remove the command that references the non-existent variable.
---------------	--

Code	A110
Message	Referenced variables are missing in the V10/11 bot. For the migrated bot to run, update the IF action in the migrated bot by providing missing required variables.
Cause	The Enterprise 11 or Enterprise 10 bot references a non-existent variable in the If command.
Action	Create a variable with the same name and type, or remove the command that references the non-existent variable.

Code	A111
Message	Referenced variables are missing in the V10/11 bot. For the migrated bot to run, update the Assign To Clipboard action in the <i>migrated bot</i> by providing missing required variables.
Cause	The Enterprise 11 or Enterprise 10 bot references a non-existent variable in the Assign To Clipboard command.
Action	Update the Assign To Clipboard action with the required missing variable in the migrated bot so that the referenced variables are of the same type.

Code	A112
Message	Referenced variables are missing in the V10/11 bot. For the migrated bot to run, update the ElseIF action in the <i>migrated bot</i> by providing missing required variables.
Cause	Enterprise 11 or Enterprise 10 bot references a non-existent variable in the ElseIF command.
Action	Either create a variable with the same name and type, or remove the command that references the non-existent variable.

Code	A113
Message	Referenced variables are missing in the V10/11 bot. For the migrated bot to run, update the Loop action in the <i>migrated bot</i> by providing missing required variables.

Cause	The Enterprise 11 or Enterprise 10 bot references a non-existent variable in the Loop command.
Action	Create a variable with the same name and type, or remove the command that references the non-existent variable.

Code	A116
Message	The MetaBot Logic referenced in the TaskBot is missing. For the migrated bot to run, ensure the referenced MetaBot logic bot is available at the required path in A360. Message code: A116
Cause	The Enterprise 11 or Enterprise 10 bot references a non-existent Taskbot.
Action	Ensure that the MetaBot Logic bot exists in Automation 360.

Code	A117
Message	The MetaBot Logic referenced in the parent MetaBot Logic is missing. For the migrated bot to run, ensure the referenced MetaBot Logic bot is available at the required path in A360. Message code: A117
Cause	The Enterprise 11 or Enterprise 10 parent MetaBot Logic references are missing.
Action	Ensure that the MetaBot Logic bot exists in Automation 360.

Code	A118
Message	For the migrated bot to run, ensure the child bot is available at the required path. A child metabot is required for the parent bot to run.
Cause	When migrating a parent bot, if you have not migrated the child bot or you migrated the child bot at a different location.
Action	Verify that you have successfully migrated the child bot. After your verification, perform one of the following actions: <ul style="list-style-type: none"> • Update the link within the parent bot so that it points to the correct location of the migrated child bot. • Move the child bot to the same location as the parent bot location.

Code	A119
-------------	------

Message	<p>A referenced DLL file is missing in the V10/11 bot.</p> <p>For the migrated bot to run, ensure the referenced DLL file is available at the required path.</p>
Cause	<p>When migrating a parent bot, if you have not migrated the DLL file or you migrated the DLL file to a different location, then this issue occurs.</p>
Action	<p>Verify that you have successfully migrated the reference DLL file. After your verification, perform one of the following actions:</p> <ul style="list-style-type: none"> • Update the link within the migrated bot so that it points to the right location of the migrated DLL file. • Move the DLL file to the same location as the migrated bot location.

Code	A124
Message	<p>'Play Sound' action has been migrated. File formats .mid, .wma and .avi formats are not supported.</p> <p>Update the files to .mp3 or .wav format to run the migrated bot.</p>

Code	A125
Message	<p>Credential value of non string type is not supported for DLL Run function in the migrated bot.</p> <p>For the migrated bot to run, update the "DLL - Run function" with a string type credential variable or a Global value of appropriate variable type and corresponding mapping.</p> <p>Refer documentation for more details.</p>
Cause	<p>For the DLL Run action, the credential value of only string type is supported. If the credential value is deleted from the DLL Run command in the Enterprise 10 or Enterprise 11 bot, then this issue occurs.</p>
Action	<p>Update the DLL Run action in the migrated bot by specifying the string type credential value and map it to the corresponding parameters in the migrated bot for it to run. If you want to pass a variable type other than string, create a global value of the required variable and map it to the DLL Run action.</p>

Code	A126
Message	<p>Referenced variables are missing in the V10/11 bot.</p> <p>For the migrated bot to run, update the 'String-BeforeAfter' action in the migrated bot by providing missing required variables.</p>

Cause	In the Enterprise 10 or Enterprise 11 bot, if the referenced variable is deleted from the String-BeforeAfter command, there are no issues. However, after migration, the missing variable causes an issue because the reference variable is required to run the bot in Automation 360.
Action	Because the reference variable is required for the bot to run, create the missing variable and assign it to the String-BeforeAfter action.

Code	A127
Message	Referenced variables are missing in the V10/11 bot. For the migrated bot to run, update the 'String-Compare' action in the migrated bot by providing missing required variables.
Cause	In the Enterprise 10 or Enterprise 11 bot, if the referenced variable is deleted from the String-Compare command, there are no issues. However, after migration, the missing variable causes an issue because the reference variable is required to run the bot in Automation 360.
Action	Because the reference variable is required for bot to run, create the missing variable and assign it to the String-Compare action.

Code	A128
Message	Referenced variables are missing in the V10/11 bot. For the migrated bot to run, update the 'String-Find' action in the migrated bot by providing missing required variables.
Cause	In the Enterprise 10 or Enterprise 11 bot, if the referenced variable is deleted from the String-Find command, there are no issues. However, after migration, the missing variable causes an issue because the reference variable is required to run the bot in Automation 360.
Action	Because the reference variable is required for bot to run, create the missing variable and assign it to the String-Find action.

Code	A129
Message	Referenced variables are missing in the V10/11 bot. For the migrated bot to run, update the 'String-Join' action in the migrated bot by providing missing required variables.
Cause	In the Enterprise 10 or Enterprise 11 bot, if the referenced variable is deleted from the String-Join command, there are no issues. However, after migration, the missing variable causes an issue because the reference variable is required to run the bot in Automation 360.

Action	Because the reference variable is required for bot to run, create the missing variable and assign it to the String-Join action.
---------------	--

Code	A130
Message	Referenced variables are missing in the V10/11 bot. For the migrated bot to run, update the 'String-Length' action in the migrated bot by providing missing required variables.
Cause	In the Enterprise 10 or Enterprise 11 bot, if the referenced variable is deleted from the String-Length command, there are no issues. However, after migration, the missing variable causes an issue because the reference variable is required to run the bot in Automation 360.
Action	Because the reference variable is required for the bot to run, create the missing variable and assign it to the String-Length action.

Code	A131
Message	Referenced variables are missing in the V10/11 bot. For the migrated bot to run, update the 'String-Lowercase' action in the migrated bot by providing missing required variables.
Cause	In the Enterprise 10 or Enterprise 11 bot, if the referenced variable is deleted from the String-Lowercase command, there are no issues. However, after migration, the missing variable causes an issue because the reference variable is required to run the bot in Automation 360.
Action	Because the reference variable is required for the bot to run, create the missing variable and assign it to the String-Lowercase action.

Code	A132
Message	Referenced variables are missing in the V10/11 bot. For the migrated bot to run, update the 'String-Replace' action in the migrated bot by providing missing required variables.
Cause	In the Enterprise 10 or Enterprise 11 bot, if the referenced variable is deleted from the String-Replace command, there are no issues. However, after migration, the missing variable causes an issue because the reference variable is required to run the bot in Automation 360.
Action	Because the reference variable is required for the bot to run, create the missing variable and assign it to the String-Replace action.

Code	A133
Message	Referenced variables are missing in the V10/11 bot. For the migrated bot to run, update the 'String-Reverse' action in the migrated bot by providing missing required variables.
Cause	In the Enterprise 10 or Enterprise 11 bot, if the referenced variable is deleted from the String-Reverse command,, there are no issues. However, after migration, the missing variable causes an issue because the reference variable is required to run the bot in Automation 360.
Action	Because the reference variable is required for the bot to run, create the missing variable and assign it to the String-Reverse action.

Code	A134
Message	Referenced variables are missing in the V10/11 bot. For the migrated bot to run, update the 'String-Substring' action in the migrated bot by providing missing required variables.
Cause	In the Enterprise 10 or Enterprise 11 bot, if the referenced variable is deleted from the String-Substring command, there are no issues. However, migration, the missing variable causes an issue because the reference variable is required to run the bot in Automation 360.
Action	Because the reference variable is required for the bot to run, create the missing variable and assign it to the String-Substring action.

Code	A135
Message	Referenced variables are missing in the V10/11 bot. For the migrated bot to run, update the 'String-Trim' action in the migrated bot by providing missing required variables.
Cause	In the Enterprise 10 or Enterprise 11 bot, if the referenced variable is deleted from the String-Trim command, there are no issues. However, after migration, the missing variable causes an issue because the reference variable is required to run the bot in Automation 360.
Action	Because the reference variable is required for the bot to run, create the missing variable and assign it to the String-Trim action.

Code	A136
-------------	------

Message	Referenced variables are missing in the V10/11 bot. For the migrated bot to run, update the 'String-Uppercase' action in the migrated bot by providing missing required variables.
Cause	In the Enterprise 10 or Enterprise 11 bot, if the referenced variable is deleted from the String-Uppercase command, there are no issues. However, after migration, the missing variable causes an issue because the reference variable is required to run the bot in Automation 360.
Action	Because the reference variable is required for the bot to run, create the missing variable and assign it to the String-Uppercase action.

Code	A137
Message	A variable is missing in the V10/11 bot. For the migrated bot to run, update the 'String-BeforeAfter' action in the migrated bot by providing a valid variable.
Cause	The unsupported variable type is assigned to the String-BeforeAfter action in the migrated Enterprise 10 or Enterprise 11 bot.
Action	To run the migrated bot, create a valid string variable type and assign it to the String-BeforeAfter action.

Code	A138
Message	A variable is missing in the V10/11 bot. For the migrated bot to run, update the 'String-Compare' action in the migrated bot by providing a valid variable.
Cause	The unsupported variable type is assigned to the action in the migrated Enterprise 10 or Enterprise 11 bot.
Action	To run the migrated bot, create a string variable type and assign it to the action.

Code	A139
Message	A variable is missing in the V10/11 bot. For the migrated bot to run, update the 'String-Find' action in the migrated bot by providing a valid variable.
Cause	The unsupported variable type is assigned to the action in the migrated Enterprise 10 or Enterprise 11 bot.
Action	To run the migrated bot, create a string variable type and assign it to the action.

Code	A140
Message	A variable is missing in the V10/11 bot. For the migrated bot to run, update the 'String-Join' action in the migrated bot by providing a valid variable.
Cause	The unsupported variable type is assigned to the action in the migrated Enterprise 10 or Enterprise 11 bot.
Action	To run the migrated bot, create a string variable type and assign it to the action.

Code	A141
Message	A variable is missing in the V10/11 bot. For the migrated bot to run, update the 'String-Length' action in the migrated bot by providing a valid variable.
Cause	The unsupported variable type is assigned to the action in the migrated Enterprise 10 or Enterprise 11 bot.
Action	To run the migrated bot, create a string variable type and assign it to the action.

Code	A142
Message	A variable is missing in the V10/11 bot. For the migrated bot to run, update the 'String-LowerCase' action in the migrated bot by providing a valid variable.
Cause	The unsupported variable type is assigned to the action in the migrated Enterprise 10 or Enterprise 11 bot.
Action	To run the migrated bot, create a string variable type and assign it to the action.

Code	A143
Message	A variable is missing in the V10/11 bot. For the migrated bot to run, update the 'String-Replace' action in the migrated bot by providing a valid variable.
Cause	The unsupported variable type is assigned to the action in the migrated Enterprise 10 or Enterprise 11 bot.
Action	To run the migrated bot, create a string variable type and assign it to the action.

Code	A144
-------------	------

Message	A variable is missing in the V10/11 bot. For the migrated bot to run, update the 'String-Reverse' action in the migrated bot by providing a valid variable.
Cause	The unsupported variable type is assigned to the action in the migrated Enterprise 10 or Enterprise 11 bot.
Action	To run the migrated bot, create a string variable type and assign it to the action.

Code	A145
Message	A variable is missing in the V10/11 bot. For the migrated bot to run, update the 'String-SubString' action in the migrated bot by providing a valid variable.
Cause	The unsupported variable type is assigned to the action in the migrated Enterprise 10 or Enterprise 11 bot.
Action	To run the migrated bot, create a string variable type and assign it to the action.

Code	A146
Message	A variable is missing in the V10/11 bot. For the migrated bot to run, update the 'String-Trim' action in the migrated bot by providing a valid variable.
Cause	The unsupported variable type is assigned to the action in the migrated Enterprise 10 or Enterprise 11 bot.
Action	To run the migrated bot, create a valid string variable type and assign it to the action.

Code	A147
Message	A variable is missing in the V10/11 bot. For the migrated bot to run, update the 'String-UpperCase' action in the migrated bot by providing a valid variable.
Cause	The unsupported variable type is assigned to the action in the migrated Enterprise 10 or Enterprise 11 bot.
Action	To run the migrated bot, create a valid string variable type and assign it to the action.

Code	A149
-------------	------

Message	MetaBot screen that is referenced in the Logic is not present in the MetaBot. For the migrated bot to run, update the object details in the Recorder action. Message code: A149
Cause	Screen details are missing in the Recorder package of the migrated bot. These screen details are required in Automation 360.
Action	You must manually capture the screen details in the migrated bot for it to run successfully.

Code	<p>A151</p> <hr/> <p>Note: As of v.27, bots that contain non-referenced variables are not flagged as Action Required or Review Required in the Bot Scanner utility for the following variables:</p> <ul style="list-style-type: none"> • \$Excel Column\$ • \$Filedata Column\$ • \$Dataset Column\$ • \$Table Column\$ • \$XML Data Node\$ • \$PDFTitle\$ • \$PDFSubject\$ • \$PDFFileName\$ • \$PDFAuthor\$ <hr/> <p>Note: As of v.25, bots that contain non-referenced variables are not flagged as Action Required in the Bot Scanner utility for the following variables:</p> <ul style="list-style-type: none"> • '\$Error Description\$' • '\$Error Line Number\$' • '\$FileName\$' • '\$Extension\$' • \$FolderName\$' <hr/>
-------------	---

Messages

- 1. '\$Error Description\$' variable name has been migrated as '\$Error-Description\$'.**

The '\$Error Description\$' variable used in version 10.x/ 11.x is not created in the A360 due to the absence of actions from corresponding packages.

For the migrated bot to run, create a variable with the same name '\$Error-Description\$' or remove the variable from the respective action.

- 2. '\$Error Line Number\$' variable name has been migrated as '\$Error-LineNumber\$'.**

The '\$Error Line Number\$' variable used in version 10.x/ 11.x is not created in the A360 due to the absence of actions from corresponding packages.

For the migrated bot to run, create a variable with the same name '\$Error-LineNumber\$' or remove the variable from the respective action.

- 3. '\$FileName\$' variable name has been migrated as '\$Loop-Files\$'.**

The '\$FileName\$' variable used in version 10.x/ 11.x is not created in the A360 due to the absence of actions from corresponding packages.

For the migrated bot to run, create a variable with the same name '\$Loop-Files\$' or remove the variable from the respective action.

- 4. '\$Extension\$' variable name has been migrated as '\$Loop-Files\$'.**

The '\$Extension\$' variable used in version 10.x/ 11.x is not created in the A360 due to the absence of actions from corresponding packages.

For the migrated bot to run, create a variable with the same name '\$Loop-Files\$' or remove the variable from the respective action.

- 5. '\$FolderName\$' variable name has been migrated as '\$Loop-FolderName\$'.**

The '\$FolderName\$' variable used in version 10.x/ 11.x is not created in the A360 due to the absence of actions from corresponding packages.

For the migrated bot to run, create a variable with the same name '\$Loop-FolderName\$' or remove the variable from the respective action.

- 6. '\$PDFAuthor\$' variable name has been migrated as '\$PDF-Metadata-Dictionary\$'.**

The '\$PDFAuthor\$' variable used in version 10.x/ 11.x is not created in the A360 due to the absence of actions from corresponding packages.

For the migrated bot to run, create a variable with the same name '\$PDF-Metadata-Dictionary\$' or remove the variable from the respective action.

- 7. '\$PDFFileName\$' variable name has been migrated as '\$PDF-**

Cause	(Applies to all A151 messages): This issue occurs if a certain variable is not created in Automation 360 because actions are not present from the corresponding package.
Action	(Applies to all A151 messages): You must create a variable of the relevant variable type (string, number, dictionary, and so on) with the same name in Automation 360, or remove the variable from the respective action to run the migrated bot successfully.

Code	A152
Message	<p>This bot has been migrated.</p> <p>The size of Array type variables exceeds 160,000. Some of the Array type variables are migrated as Table type variables in A360 without the default values.</p> <p>Default value for the Table type variable may be required for the bot to give same results.</p>

Code	A154
Message	For the migrated bot to run, update the 'Simulate keystrokes' action. The excel paste special behavior in A360 is different from the version 10.x/11.x. Message Code: A154
Cause	The Paste Special dialog box varies between Automation 360, Enterprise 11, and Enterprise 10. As a result, the Simulate keystrokes command functions differently.
Action	Update the Simulate keystrokes command in the migrated bot.

Code	A155
Message	For the migrated bot to run update the bot name in the Run Task command. The Metabot logic has been migrated by suffixing '-bot' to the file name
Cause	When a Logic and a folder in the MetaBot have the same name in Enterprise 11, after migration the name of the Logic name is suffixed with <i>-bot</i> so that the Logic can be migrated.
Action	Update the bot name in the Run Task command.

Review required messages

These messages are displayed in the Bot Scanner report, Bot Migration Wizard, and Migration Assistant after you migrate the bots. In such cases, the bot is successfully migrated but you still have to manually verify the migrated bots as described in the following messages.

Code	R101
Messages	<ol style="list-style-type: none">1. Excel: Switch to sheet action has been migrated. Review the action session name and type to ensure the shared session name is correct.2. Excel: Close action has been migrated. Review the action session name and type to ensure the shared session name is correct.3. Excel: Delete cells action has been migrated. Review the action session name and type to ensure the shared session name is correct.4. Excel: Find action has been migrated. Review the action session name and type to ensure the shared session name is correct.5. Excel: Get multiple cells action has been migrated. Review the action session name and type to ensure the shared session name is correct.6. Excel: Get single cells action has been migrated. Review the action session name and type to ensure the shared session name is correct.7. Excel: Get cell address action has been migrated. Review the action session name and type to ensure the shared session name is correct.8. Excel: Get column name action has been migrated. Review the action session name and type to ensure the shared session name is correct.9. Excel: Get row number action has been migrated. Review the action session name and type to ensure the shared session name is correct.10. Excel: Replace action has been migrated. Review the action session name and type to ensure the shared session name is correct.11. Excel: Run macro action has been migrated. Review the action session name and type to ensure the shared session name is correct.12. Excel: Save workbook action has been migrated. Review the action session name and type to ensure the shared session name is correct.13. Excel: Set cell action has been migrated. Review the action session name and type to ensure the shared session name is correct.

Code	R102
Message	<p>System variable OS Name has been migrated. Review the value returned for the system variable OS Name in the <i>migrated</i> bot.</p> <p>The value returned by system variable OS Name may be different from version 10.x/11.x.</p>

Code	R103
Message	<p>Object Cloning has been migrated. Review the Image Recognition LeftClick action in the migrated bot.</p> <p>Migration of Object Cloning configured with play mode Image with action MiddleClick has been migrated with Image Recognition LeftClick action.</p>

Code	R104
Message	<p>String operation - Split action has been migrated. Review the String operation - Split action in the migrated bot.</p> <p>The Limit field is now divided into 2 fields: All Options and Only. Limit has been migrated to Only since it has a variable.</p>

Code	R105
Message	<p>App Integration action has been migrated. Review the application type Other in the migrated bot.</p> <p>Migration of App Integration action with application type Other is supported.</p>

Code	R106
Message	<p>OCR action has been migrated. Read the Automation 360 OCR package documentation for details.</p> <p>ABBYY is the only OCR engine supported.</p>
Cause	<p>Only the ABBYY OCR engine is supported with Automation 360. Irrespective of which OCR engine you have been using in Enterprise 11, after migration your bots will run using only the ABBYY OCR engine.</p>
Action	<p>To learn more about the OCR package, see OCR package.</p>

Code	R107
Message	<p>Email - Connect with Exchange server action has been migrated.</p> <p>The exchange server version 'Exchange 2013_SP1' is migrated as 'Exchange 2013'. Ensure this version of the Exchange server will work with your system.</p>

Code	R114
Message	<p>Terminal Emulator - Connect action has been migrated.</p> <p>The connection type is configured as SSH2 since SSH1 is not supported in A360.</p> <p>No further action required.</p>
Cause	<p>Enterprise 11 and Enterprise 10 support both the SSH1 and SSH2 connection types. Automation 360 is upgraded to support only the SSH2 connection type. However, your migrated bots that were configured with SSH1 will work in Automation 360 and will be configured with the SSH2 connection type by default.</p>

Code	R115
Message	<p>Terminal Emulator - Connect action has been migrated.</p> <p>All bots now use the Advanced Technology setting. Please test and validate the bot.</p>
Cause	<p>In Enterprise 10 and Enterprise 11, you can choose whether to use the Advanced Technology for the Terminal Emulator - Connect command. Because Automation 360 is upgraded to support only Advanced Technology, all the migrated bots will be configured with Advanced technology for the Terminal Emulator Connect action by default.</p>

Code	R116
Message	<p>The value of the Error Description variable in the <i>migrated bot</i> may be different from version 10.x / 11.x.</p> <p>Review any action that uses the value of the Error Description variable.</p>

Code	R117
-------------	------

Message	Workload: Insert work item action has been migrated. The date format needs to be the same in version 10.x / 11.x and Automation 360.
Cause	The date format field in the Workload: Insert work item action uses a default date format.
Action	If the date format is different from the global value <code>AADefaultDateFormat</code> , update the required format in the Workload: Insert work item action.

Code	R118
Message	Assign To Clipboard action has been migrated. The referenced variable does not exist in version 10.x / 11.x and has been migrated as a string to Automation 360. The bot may not run as expected.

Code	R119
Message	The Variable Operation action has been migrated. Variable types do not match. The variable has been disabled in the <i>migrated bot</i> . No further action required.
Cause	In Enterprise 11 if you change the variable type (for example, from string to dictionary), the bot ignores the change and moves to the next line. However, in Automation 360, the change in the variable is not supported. So if there is a change in variable type in the migrated bot, the variable is disabled to maintain consistent behavior with Enterprise 11. .

Code	R120
Message	'Wait for Window' action has been migrated. The negative value of the X1 coordinate has been set to 0. No further action required.
Cause	In Enterprise 10 and Enterprise 11, the negative value for the X1 coordinate is supported for the Wait for Window action. In Automation 360, the negative value is not supported, so the negative value of the migrated bot is set to 0 by default.

Code	R121
-------------	------

Message	'Wait for Window' action has been migrated. The negative value of the X2 coordinate has been set to 0. No further action required.
Cause	In the Enterprise 10 and Enterprise 11, the negative value for X2 coordinate was supported for Wait for Window action. In Automation 360, the negative value is not supported, so, negative value of the migrated bot is set to 0 by default.

Code	R122
Message	'Wait for Window' action has been migrated. The negative value of the Y1 coordinate has been set to 0. No further action required.
Cause	In Enterprise 10 and Enterprise 11, the negative value for Y1 coordinate is supported for the Wait for Window action. In Automation 360, the negative value is not supported and so the negative value of the migrated bot is set to 0 by default.

Code	R123
Message	'Wait for Window' action has been migrated. The negative value of the Y2 coordinate has been set to 0. No further action required.
Cause	In Enterprise 10 and Enterprise 11, the negative value for Y2 coordinate is supported for the Wait for Window action. In Automation 360, the negative value is not supported and so the negative value of the migrated bot is set to 0 by default.

Code	R124
Message	'Terminal Emulator' action has been migrated. Review the action session name to ensure the shared session name is correct.

Code	R125
Message	Recorder action has been migrated. The object properties with value greater than 64kb have been truncated. Review the object properties value in the 'Recorder' action of the migrated bot. No action is required if those properties are not used in the search criteria. Message code: R125

Code	R126
-------------	------

Message	<code>'Window title regex has been migrated.</code> <code>Review the Window title regex in the migrated bot if the</code> <code>window is not found during Bot run.</code>
----------------	--

Code	<code>R127</code>
-------------	-------------------

Message	<code>IfImageReco-FileInFile Command has been migrated.</code> <code>'.jpg, .jpeg, .jpe. .jfif, .bmp, .gif, .png' are the</code> <code>supported file formats for the field 'ImageFile1' action.</code>
----------------	---

Code	<code>R128</code>
-------------	-------------------

Message	<code>Variable with default value greater than 64kb is not</code> <code>supported. The value is stored in a text file and assigned</code> <code>to the variable during bot run.</code>
----------------	--

Code	<code>R129</code>
-------------	-------------------

Message	<code>This bot has been migrated.</code> <code>For the migrated bot to run, a dictionary variable is</code> <code>required in the input variable mapping of run task action.</code> <code>Review the temp dictionary variable created in the parent</code> <code>and mapped in the input variable.</code>
----------------	---

Code	<code>R130</code>
-------------	-------------------

Message	<code>'Run Task' action has been migrated.</code> <code>A credential variable is passed to a non-credential type</code> <code>variable in an unsecured manner. For enhanced security pass</code> <code>the credential variable to a credential type variable.</code> <code>No further action required.</code>
----------------	---

Code	<code>R133</code>
-------------	-------------------

Message	<code>Action with 'AAInstallationPath' has been migrated.</code> <code>The value of the 'AAInstallationPath' in the migrated bot</code> <code>may be different from version 10.x / 11.x.</code> <code>Review any action that uses the value of the</code> <code>'AAInstallationPath' action.</code>
----------------	---

Code	<code>R134</code>
-------------	-------------------

Message	<p>Run Task action has been migrated.</p> <p>The child bot path in the Run Task action is passed through a variable during run time. The value of the variable should pass the correct path of the child bot during the bot run.</p>
----------------	--

Code	R135
-------------	------

Message	<p>Screen Capture action has been migrated along with Log to file action to capture the image and the error description.</p> <p>The file path in the Screen capture action is passed through a variable during run time. The file path in the Log to File action is set to \$AAAApplicationPath\$/Temp/Error Handling/ErrorMessage.txt. \</p> <p>No further action required.</p>
----------------	--

Code	R136
-------------	------

Message	<p>Metabot with logic has been migrated.</p> <p>The same name is used for the Metabot asset folder or logic folder in version 10.x/11.x. The Metabot logic has been migrated by suffixing '-bot' to its name. If any other existing bot matches this new name, the bot will be overridden.</p> <p>Review the migrated bot.</p>
----------------	--

Code	R137
-------------	------

Message	<p>Metabot with logic has been migrated.</p> <p>This bot has been migrated. The migrated bot has a circular dependency with another bot. Review the bot dependencies in the migrated bot and update the missing dependencies.</p> <p>Review the migrated bot.</p>
----------------	---

Code	R140
-------------	------

Message	<p>The Value of the Error Line Number in the migrated bot may be different from the one in version 10.x/11.x. Review any action that uses the value of the Error Line Number in the migrated bot. Message code:R140</p>
----------------	---

Error messages

These messages are displayed in the Bot Scanner report and Bot Migration Wizard. These messages are displayed when the bot migration is not successful.

Code	E101
Message	This bot cannot be migrated because it has a child bot that uses an unsupported action or system variable.
Cause	A child bot that uses a command that is currently unsupported for migration cannot be migrated. As a result, parent bots that use this child bot also cannot be migrated.
Action	To migrate these parent bots, remove references to the child bot from the parent bot and then migrate that parent bot. To view unsupported commands that are used in the child bots, go to the list of bots that cannot be migrated and click the child bot name.

Code	E104
Message	This bot cannot be migrated. The Object Cloning command which automates Flash application is not supported in Automation 360. Delete the Object Cloning command which automates Flash application in Enterprise 10.x/Enterprise 11.x bot and then migrate. Message code: E104

Code	E106
Message	This bot cannot be migrated. The migration of MetaBot with Screens having play mode as Text is not yet supported. <hr/> Note: This message is applicable only for Automation 360 v.25 and earlier releases. <hr/>

Code	E109
Message	This bot cannot be migrated. The migration of REST API call using SOAP web service with authentication through client certificate is not yet supported.

Code	E110
-------------	------

Message	<p>This bot cannot be migrated.</p> <p>The migration of OCTET DECIMAL BYTE STRING data type is not yet supported.</p>
Code	E112
Message	<p>This bot cannot be migrated.</p> <p>The migration of REST API call using SOAP web service action with Outer XML is not yet supported.</p>
Code	E113
Message	<p>This bot cannot be migrated.</p> <p>The migration of REST API call using SOAP web service action with Inner XML is not yet supported.</p>
Code	E114
Messages	<ol style="list-style-type: none"> 1. This bot cannot be migrated. The migration of VariableOperation - ResetSysVariable action is not yet supported. 2. This bot cannot be migrated. The migration of Internet - IntCon action is not yet supported.
Code	E115
Message	<p>This bot cannot be migrated.</p> <p>The migration of Variable Operation action resetting system variable \$WorkItem\$ is not supported.</p>
	<p>Resetting the system variable \$WorkItem\$ is not supported for Variable Operation command.</p>
	<p>Use the String > Assign operation and assign an empty string to the \$WorkItem\$ system variable instead of resetting it.</p>
Code	E116

Message	<p>This bot cannot be migrated.</p> <p>The migration of Variable Operation action resetting system variable \$WorkItemResult\$ is not supported.</p>
Cause	Resetting the system variable \$WorkItemResult\$ is not supported for Variable Operation command.
Action	Use the String > Assign operation and assign an empty string to the \$WorkItemResult\$ system variable instead of resetting it.

Code	E118
Message	<p>Create the Credential or Locker in Automation 360 before migrating this version 10.x / 11.x bot.</p> <p>The credential variables for MetaBot-DLL cannot be migrated because the corresponding Credential or Locker is not present in the Control Room.</p>
Cause	The associated Credential variable is not migrated for the Metabot-DLL because the associated credential or locker is not present in the Enterprise 11 Control Room.
Action	Manually create the credential or locker in the Automation 360 and then migrate the bot.

Code	E119
Message	<p>This bot has an invalid path.</p> <p>Modify the bot path in version 10.x / 11.x and ensure that the bot runs before migrating.</p> <p>The path defined in the Run Task action using \$AAApplicationPath\$ is not in a valid repository folder.</p>
Cause	The Enterprise 11 or Enterprise 10 bot uses an invalid path in the Run Task command of the child bot.
Action	To migrate this bot, modify the Enterprise 11 bot to ensure a valid child bot path is provided after AAApplicationPath .

Code	E120
Message	<p>This bot has an invalid path.</p> <p>Modify the bot path in version 10.x / 11.x and ensure that the bot runs before migrating.</p> <p>The path defined in the If - TaskSuccessful action using \$AAApplicationPath\$ is not in a valid repository folder.</p>

Cause	The Enterprise 11 or Enterprise 10 bot uses an invalid path in the If - TaskSuccessful command of the child bot.
Action	To migrate this bot, modify the Enterprise 11 bot to ensure a valid child bot path is provided after AAApplicationPath .

Code	E121
Message	<p>This bot has an invalid path.</p> <p>Modify the bot path in version 10.x / 11.x and ensure that the bot runs before migrating.</p> <p>The path defined in the If - TaskUnsuccessful action using \$AAApplicationPath\$ is not in a valid repository folder.</p>
Cause	The Enterprise 11 or Enterprise 10 bot uses an invalid path in the If - TaskUnsuccessful command of the child bot.
Action	To migrate this bot, modify the Enterprise 11 bot to ensure a valid child bot path is provided after AAApplicationPath .

Code	E122
Message	<p>This bot has an invalid path.</p> <p>Modify the bot path in version 10.x / 11.x and ensure that the bot runs before migrating.</p> <p>The path defined in the ElseIf - TaskUnsuccessful action using \$AAApplicationPath\$ is not in a valid repository folder.</p>
Cause	The Enterprise 11 or Enterprise 10 bot uses an invalid path in the ElseIf - TaskUnsuccessful command of the child bot.
Action	To migrate this bot, modify the Enterprise 11 bot to ensure a valid child bot path is provided after AAApplicationPath .

Code	E123
Message	<p>This bot has an invalid path.</p> <p>Modify the bot path in version 10.x / 11.x and ensure that the bot runs before migrating.</p> <p>The path defined in the ElseIf - TaskSuccessful action using \$AAApplicationPath\$ is not in a valid repository folder.</p>
Cause	The Enterprise 11 or Enterprise 10 bot uses an invalid path in the ElseIf - TaskSuccessful command of the child bot.

Action	To migrate this bot, modify the Enterprise 11 bot to ensure a valid child bot path is provided after AAApplicationPath .
Code	E124
Message	<p>The value being passed to the DLL function is in an invalid format.</p> <p>Modify bot in version 10.x / 11.x before migrating.</p> <p>Validate the array/list variable and the column/index value passed in the DLL function and update the 10.x/11.x bot.</p>
Code	E125
Message	<p>Modify bot in version 10.x / 11.x before migrating.</p> <p>Update the version 10.x / 11.x bot to include referenced variables for the Assign From Clipboard action. A referenced variable was not found.</p>
Code	E127
Message	<p>Modify bot in version 10.x / 11.x before migrating.</p> <p>Variable types do not match or have been changed.</p> <p>Update the variable type in the Variable Operation action in the version 10.x/11.x bot.</p>
Code	E128
Message	<p>This bot cannot be migrated.</p> <p>The migration of 'MetaBot with Screens' using Silverlight technology is not yet supported.</p>
Code	E129
Message	<p>This bot cannot be migrated.</p> <p>The migration of 'MetaBot with Screens' captured using Edge browser is not yet supported.</p>
Code	E130

Message	This bot cannot be migrated. The migration of 'MetaBot with Screens' captured using Firefox browser is not yet supported.
----------------	--

Code	E131
-------------	------

Message	This bot cannot be migrated. The migration of 'MetaBot with Screens' with the 'GetAllChildrenData' action is not yet supported.
----------------	--

Code	E132
-------------	------

Message	This bot cannot be migrated. The migration of 'MetaBot with Screens' with the 'GetVisibility' action is not yet supported.
----------------	---

Code	E133
-------------	------

Message	This bot cannot be migrated. The migration of 'MetaBot with Screens' with linked objects is not yet supported.
----------------	---

Code	E134
-------------	------

Message	This bot cannot be migrated. The migration of 'MetaBot with Screens' with 'play mode as coordinate for linked objects' is not yet supported.
----------------	---

Code	E135
-------------	------

Message	This bot cannot be migrated. The migration of 'MetaBot with Screens' with 'play mode as image for linked objects' is not yet supported.
----------------	--

Code	E136
-------------	------

Message	<p>This bot cannot be migrated.</p> <p>The migration of 'Object Cloning' action with the Edge browser is not yet supported.</p> <p>This bot cannot be migrated. The Object Cloning command which automates Legacy Edge browser is not supported in Automation 360 . Delete the object cloning command which automates Edge Legacy browser in 10.x/11/x bot and then migrate. Message code: E136</p>
Code	E137
Message	<p>This bot cannot be migrated.</p> <p>The migration of 'Object Cloning' action with the Firefox browser is not yet supported.</p>
Code	E138
Message	<p>This bot cannot be migrated.</p> <p>The migration of 'Object Cloning' action with Silverlight is not yet supported.</p>
Code	E139
Message	<p>This bot cannot be migrated.</p> <p>The migration of 'Object Cloning' action with the 'GetDataofAllchildren' action is not yet supported.</p>
Code	E140
Message	<p>This bot cannot be migrated.</p> <p>The migration of 'Terminal Emulator - Connect' action with 'Japanese (50939) Codepage' is not yet supported.</p>
Code	E141
Message	<p>This bot cannot be migrated.</p> <p>The migration of 'Terminal Emulator - Connect action with 'Japanese (51932) Codepage' is not yet supported.</p>
Code	E142

Message	This bot cannot be migrated. The migration of 'Terminal Emulator - Connect' action with 'Japanese JIS (20932) Codepage' is not yet supported.
Code	E143
Message	This bot cannot be migrated. The migration of 'Terminal Emulator - Connect' action with 'Japanese JIS (50220) Codepage' is not yet supported.
Code	E144
Message	This bot cannot be migrated. The migration of 'Terminal Emulator - Connect' action with 'Japanese JIS (50221) Codepage' is not yet supported.
Code	E145
Message	This bot cannot be migrated. The migration of 'Terminal Emulator - Connect' action with 'Japanese JIS (50222) Codepage' is not yet supported.
Code	E146
Message	This bot cannot be migrated. The migration of 'Terminal Emulator - Connect' action with 'Japanese Katakana (50930) Codepage' is not yet supported.
Code	E147
Message	This bot cannot be migrated. The migration of 'Terminal Emulator - Connect' action with 'Japanese Katakana Extended (20290) Codepage' is not yet supported.
Code	E148
Message	This bot cannot be migrated. The migration of 'Terminal Emulator - Connect' action with 'US-Canada and Japanese (50931)' is not yet supported.

Code	E149
Message	<p>This bot cannot be migrated.</p> <p>The migration of Walk command with type All is not supported.</p>

Code	E150
Message	<p>This bot cannot be migrated.</p> <p>The referenced Meta Bot is not available in the provided location. Provide the valid Meta Bot or location in version 10.x / 11.x and try again.</p>

Code	E151
Message	<p>This bot cannot be migrated.</p> <p>The migration of \$IsCognitiveCaptureSuccess\$ action is not supported.</p>

Code	E152
Message	<p>This bot cannot be migrated.</p> <p>Modify the password type variable in version 10.x/11.x bot before migrating.</p> <p>The migration of command with Password type variable is not supported. This action does not support credential vault variable.</p>

Code	E153
Message	<p>This bot cannot be migrated.</p> <p>Modify the SMARTWndCtrl action field variable type in version 10.x/11.x bot before migrating.</p> <p>The migration of SMARTRecorder action SMARTWndCtrl with field 'SetDateRange_NotSupportedAction' of type 'String' is not supported.</p>

Code	E155
-------------	------

Message	<p>This bot cannot be migrated.</p> <p>The migration of 'MetaBot with Screens' with 'play mode as image for linked objects' and 'play mode as text for main objects' is not yet supported.</p>
----------------	--

Code	E159
Message	<p>This bot cannot be migrated.</p> <p>The migration of 'MetaBot with Screens' with 'play mode as text for linked objects' and 'play mode as object for main objects' is not yet supported.</p>

Code	E164
Message	<p>This bot cannot be migrated.</p> <p>The migration of 'MetaBot with Screens' with 'play mode as text' and having Import Dataset command with action other than GetText, SetText, DoubleClick, LeftClick and RightClick is not yet supported.</p>

Code	E165
Message	<p>This bot cannot be migrated.</p> <p>The migration of 'MetaBot with Screens' with 'play mode as text' and having any OCR engine other than 'Abbyy' or 'Tesseract' will use 'Abbyy' OCR engine after migration.</p>

Internet Explorer conversion or scanning messages

These messages are displayed in the Bot Scanner report when bots that use Internet Explorer is run or scanned and are not migrated successfully to other supported browsers.

Code	R1001
Message	<p>A variable is used in the 'Location of the program/file' property of this bot. If the variable is pointing to Internet Explorer, update it such that it points to Chromium based Microsoft Edge browser instead. If not, no further action required.</p>

Code	R1002
-------------	-------

Message	Browser components such as Menu bar, Status bar, Favorites bar, Command bar and other non-webpage components differ in each browser, and this can potentially have impact on the captured screens in <PACKAGE_NAME - ACTION_NAME>. You are advised to review and recapture the screen if required.
----------------	---

Code	R1003
-------------	-------

Message	RegEx variable used in the window title seems to have partial text corresponding to 'Internet Explorer' hence the title may not get converted as per 'Microsoft Edge' text that is used in the Edge browser window. You are advised to use 'Internet Explorer' text as a whole in the RegEx variable.
----------------	--

Differences while migrating APIs from Enterprise 11/Enterprise 10 to Automation 360

When you migrate from Enterprise 11 to Automation 360, review any Control Room APIs migration issues and their workarounds.

One difference between the Enterprise 11 and Automation 360 versions occurs in the **Credential Value API - Get attributevalues**.

```
GET https://{ControlRoomURL}/v2/credentialvault/credentials/{credentialId}/attributevalues
```

In Automation 360, the `CredentialAttribute` object is not available in the response of `GET attributevalues` API. If you are using any parameters in this object in your bot logic then you must modify your response parsing logic and use `GET /v2/credentials/{id}` (See [Configure a credential with attribute values using API](#)) to consume those parameters.

Sample responses for the GET `attributevalues` for both Enterprise 11 and Automation 360 versions:

Enterprise 11	Automation 360
<pre>{ { "list": [{ "id": "2221", "credentialAttributeId": "9271", "value": "LNC2021132D", "createdBy": "21", "createdOn": "2021-09-29T12:37:48.765Z", "updatedBy": "131", "updatedOn": "2021-10-18T20:47:58.027Z", "version": "3", "credentialAttribute": { "id": "2277", "name": "ABCD Account", "description": "", "userProvided": false, "masked": false, "createdBy": "77", "createdOn": "2021-09-29T12:37:48.638Z", "updatedBy": "77", "updatedOn": "2021-09-29T12:37:48.638Z", "version": "0", "passwordFlag": false } }] }</pre>	<pre>{ "list": [{ "id": "4008", "credentialAttributeId": "1622", "value": "LNC2021132D", "createdBy": "21", "createdOn": "2021-09-29T12:37:48.765Z", "updatedBy": "274", "updatedOn": "2021-10-18T20:47:58.027Z", "version": "3", "password": false }]</pre>

Migrate Community Edition bots

Bots created in the Enterprise 11 Community Edition environment must be migrated to the Automation 360 Community Edition to allow users to use these bots in Automation 360. You use the Bot Migration package available in the Automation 360 Community Edition to manually migrate the bots.

Before you start migrating bots, do the following:

- Use the Bot Scanner utility to determine if your Enterprise 11 bots can be migrated successfully.
 - [Bot Scanner overview](#)
- Get access to Automation 360 Community Edition.
- Register a device in Automation 360 Community Edition to run bots.

[Install Bot Agent and register device](#)

This procedure migrates one bot at a time. To migrate all bots within the same folder, you can create a complex bot by iterating files in a folder in a loop or add multiple **Migrate bot** actions for each `.atmx` file you want to migrate.

Important: If a bot has dependencies on other bots, you must migrate the dependent bots first and then the parent bot. For example, the `main.atmx` parent bot has a dependency on `child1.atmx`,

which also has a dependency to `child2.atmx`, then add the **Migrate bot** actions in the following order: `child2.atmx`, followed by `{{child1.atmx}}` and then `{{main.atmx}}`.

1. Log in to Automation 360 Community Edition.
2. Use the Bot Migration package to migrate your bots.
 - a) Click **Automation** on the left pane.
 - b) Click **Create New > Bot**, specify the required details, and click **Create & edit**.
 - c) Expand the **Bot Migration** package and double-click the **Migrate bot** action.
 - d) Select **Desktop file** within the **Bot file path** section.
 - e) Enter the complete path of the Enterprise 11 `.atmx` file you want to migrate.
 - f) Optional: Enter the output folder path into the **Output folder path** field to specify where you want package conversion information and errors to be stored.

A report showing relevant information is generated for each migrated bot.
 - g) Leave the **Overwrite the file if exists** option selected (default setting) if you want this migrated bot to overwrite any bots of the same name in the Automation 360 Community Edition environment.
 - h) Save the bot.
 - i) Run the bot on the connected device to perform the migration.

Successfully migrated bots are uploaded to the Automation 360 private repository of the user who performed the migration. Only **successfully** migrated bots are migrated. Use the reports in the specified **Output folder path** to see the migration errors.

Related tasks

[Scan Enterprise 11 or 10 bots using Bot Scanner](#)

Before you migrate to Automation 360, it is important to verify the migration readiness of your bots. Scan the bots using Bot Scanner and analyze the generated report for information about the commands and variables used in these bots and how many of these commands and variables are supported for migration.

Related reference

[Bot migration package](#)

The **Bot migration** package enables you to migrate Enterprise 10 and Enterprise 11 bots to Automation 360 format. The package also enables you to convert Enterprise 10, Enterprise 11, or Automation 360 bots that use Internet Explorer to Microsoft Edge with IE mode. This package is used internally by the Bot Migration Wizard and the Update Bot wizard.

Migrate to Automation 360 IQ Bot

Migration is the process of upgrading from earlier versions of IQ Bot (Enterprise 11.x, 6.x, or 5.x) to the latest Automation 360 IQ Bot version. This includes replicating your existing database and repository, converting your bots to Automation 360 format, and migrating all the learning instances.

Check migration readiness

Automation 360 IQ Bot features and functionality are the same as IQ Bot Enterprise 11. The existing Enterprise 11 content also applies to Automation 360 IQ Bot.

- You can upgrade to any version of Automation 360 IQ Bot without any restrictions. However, ensure that you use the Database Migration Assistant of the target version to migrate.

For example, if you want to migrate to Automation 360 IQ Bot (Build 11513), you must use the Database Migration Assistant for Automation 360 IQ Bot (Build 11513), which is available as a separate utility in the Automation 360 IQ Bot installation folder.

- Compare some of the key features of Automation 360 IQ Bot deployment models with IQ Bot release.

[Automation 360 IQ Bot feature comparison matrix](#)

- Review the IQ Bot version compatibility information.

[Automation 360 IQ Bot version compatibility](#)

- Obtain the migration license: [Get migration license](#)
- Before migrating from IQ Bot 11.x to Automation 360 IQ Bot On-Premises, ensure you have downloaded the latest version of the Database Migration Assistant from Automation Anywhere Support site.

This tool enables you to migrate data and is supported on the following Microsoft SQL Server versions:

- Microsoft SQL Server 2019 15.0 Developer Edition and Express Edition
- Microsoft SQL Server 2016 13.0 Express Edition
- Microsoft SQL Server 2012 Express Edition

Note: Database Migration Assistant does not support Azure PaaS Database Service. If you are using Azure PaaS Database Service, you must copy all IQ Bot databases to any of the versions supported above, and run the Database Migration Assistant. Unified databases created using the Database Migration Assistant can then be uploaded back to Azure PaaS Database Service.

- If you are migrating from IQ Bot 11.x to Automation 360 IQ Bot On-Premises, we recommend that you have a 3-node cluster to ensure high availability (HA) for IQ Bot.

[High availability and disaster recovery overview](#)

- For RabbitMQ v3.8.18 disaster recovery (DR), we recommend that you have the same number of nodes in the primary and secondary sites to achieve same load handling capability.

Similarly, the RabbitMQ v3.8.18 cluster setup of the secondary site must replicate the cluster setup of the primary site.

[Disaster recovery deployment model](#)

For RabbitMQ v3.8.18 cluster configuration with auto-recovery, see [RabbitMQ Cluster Configuration with Auto-recovery \(A-People login required\)](#)

Choose your migration path

Choose your migration path based on the IQ Bot version you are currently using and the Automation 360 IQ Bot deployment model that meets your business requirements.

Important: In earlier IQ Bot versions, five databases were created, and in Automation 360 IQ Bot a single unified database is created. So ensure you back up your existing IQ Bot databases before you start the migration.

If you are on this version	Perform this migration procedure
IQ Bot 11.3.4 (or later)	Migrate to Automation 360 IQ Bot On-Premises or Cloud: <ol style="list-style-type: none"> 1. Migrate earlier IQ Bot versions to Automation 360 IQ Bot On-Premises 2. Migrate from Automation 360 IQ Bot On-Premises to Cloud Install the latest version of Automation 360 IQ Bot On-Premises before you migrate to IQ Bot Cloud.
IQ Bot 6.5.x	You can migrate to Automation 360 IQ Bot On-Premises only from IQ Bot Version 11.3.4. <ol style="list-style-type: none"> 1. Update IQ Bot Version 6.5 to IQ Bot Version 11.3.4 Update IQ Bot from 6.5 or earlier to 11.3.4 2. Migrate earlier IQ Bot versions to Automation 360 IQ Bot On-Premises 3. Migrate from Automation 360 IQ Bot On-Premises to Cloud Install the latest version of Automation 360 IQ Bot On-Premises before you migrate to IQ Bot Cloud.
IQ Bot 5.3.x (or earlier)	<ol style="list-style-type: none"> 1. Update to IQ Bot Version 6.5 Update IQ Bot from 5.3.x or 6.0 to 6.5 2. Update IQ Bot Version 6.5 to Version 11.3.4 Update IQ Bot from 6.5 or earlier to 11.3.4 3. Migrate earlier IQ Bot versions to Automation 360 IQ Bot On-Premises 4. Migrate from Automation 360 IQ Bot On-Premises to Cloud Install the latest version of Automation 360 IQ Bot On-Premises before you migrate to IQ Bot Cloud.

Related concepts

[Install and update Automation 360 IQ Bot](#)

This collection of topics guide you through the process of installing or setting up Automation 360 IQ Bot On-Premises and Cloud.

Prepare for IQ Bot migration

Perform these tasks before you migrate to Automation 360 IQ Bot (On-Premises) from an earlier IQ Bot version (from Enterprise 6.x through 11.x).

- 1.** If you are currently using any of the earlier versions of Automation Anywhere Enterprise (10.x or 11.x), ensure you migrate to the latest Automation 360 version.
Migrate to Automation 360
- 2.** Ensure the Automation 360 version corresponds to the Automation 360 IQ Bot that you are installing.
Automation 360 IQ Bot version compatibility
- 3.** Migrate to the latest Automation 360 IQ Bot On-Premises from IQ Bot Version 11.3.4 or later versions. If you are currently using any of the earlier IQ Bot versions (5.3.x), you must first perform these tasks:
 - a) Update to IQ Bot Version 6.5.
See *Update IQ Bot from 5.3.x or 6.0 to 6.5*
 - b) Update IQ Bot Version 6.5 to IQ Bot Version 11.3.4 before migrating to Automation 360 IQ Bot On-Premises.
See *Update IQ Bot from 6.5 or earlier to 11.3.4*
- 4.** Back up your existing IQ Bot databases.
In the earlier IQ Bot versions, five databases were created. With Automation 360 IQ Bot On-Premises Build 2545, a single unified database is created.
 - a) Ensure you back up all five databases:
 - AliasData
 - ClassifierData
 - Configurations
 - FileManager
 - MLData
 - b) Uninstall any earlier IQ Bot versions.
Uninstalling an existing IQ Bot build does not delete the databases.

5. Install Database Migration Assistant.

- a) Log into Automation Anywhere support site and download the Database Migration Assistant:
A-People Downloads page (Login required)

Note: Ensure that **ODBC Driver version 17.0 for SQL Server** is available on your system before you run the Database Migration Assistant.

- b) Double-click the file to run Database Migration Assistant.
 c) Click **Next** to continue.
 d) Accept the license agreement. and click **Next**.
 e) In the **Database Configuration** screen, enter your existing IQ Bot database host name and credentials, and click **Next**.

Note: The SQL Server Browser service must be running if you want to use the full name of the SQL Server as the host name.

- f) (Optional) Click **Browse** to change the default installation folder for the Database Migration Assistant.
 g) Click **Install**.

After a successful installation, a new database called **IQBot** is created. You can use the following path to review the log files:

```
C:\Users\Public\Documents\Migration_Assistant_Logs
```

Note: After migration to Automation 360 IQ Bot completes, output files processed in IQ Bot 11x will not be available for download through the IQ Bot package in the Control Room.

Migrate earlier IQ Bot versions to Automation 360 IQ Bot On-Premises

Migrate from an earlier IQ Bot version (from Enterprise 6.x through 11.x) to Automation 360 IQ Bot (On-Premises) for the latest features and enhancements.

1. Download Automation 360 IQ Bot

- a) Log into Automation Anywhere support site to download the latest Automation 360 IQ Bot build:
A-People Downloads page (Login required)
- b) Extract (unzip) the `Automation_Anywhere_IQ_Bot_A2019_(Build number)` folder and run the following `.bat` files:
1. `CleanupRabbitMQandErlang.bat`
 2. `CleanupRabbitMQErlangPython.bat`
 3. `UninstallPython.bat`
 4. `UninstallPython385.bat`

These files remove the registry entries of RabbitMQ v3.8.18, Erlang/OTP relevant IQ Bot Python. No other Python versions are affected.

- c) Restart your machine.

2. Install Automation 360 IQ Bot

- a) Open `Automation_Anywhere_IQ_Bot_A2019_(Build number)` folder and run the following files again:
 1. `CleanupRabbitMQandErlang.bat`
 2. `CleanupRabbitMQErlangPython.bat`
 3. `UninstallPython.bat`
 4. `UninstallPython385.bat`

This procedure removes any empty folders from RabbitMQ v3.8.18, Erlang, and Python.

- b) Install the Automation 360 IQ Bot build.
- c) During installation, specify the same host name where the **IQBot** database was created. Automation 360 IQ Bot automatically connects to the **IQBot** database that was created by the Database Migration Assistant before migrating the data.
- d) When the installation completes, unregister IQ Bot Enterprise 11.
Unregistering IQ Bot from the Control Room
Automation 360 IQ Bot automatically connects to the **IQBot** database that was created by the Database Migration Assistant before migrating the data.
- e) Clear the browser cache.
- f) (Optional) Restart the **Cognitive Console** service if IQ Bot fails to load.

3. Register Automation 360 IQ Bot

- a) Register IQ Bot A360.x with the Control Room.
× refers to the latest version of Automation 360 IQ Bot.
Registering IQ Bot with the Control Room
Troubleshooting:
 - If the login page is not displayed after registering IQ Bot A360.x, restart the Control Room services (Control Room and Control Room Reverse proxy).
 - If none of the domains or dashboards are displayed when you log in to Automation 360 IQ Bot after a successful migration, perform the following steps:
 - Press the F12 key and click the **Network** tab to view the APIs.
If the APIs are unauthorized or display an error message, restart the IQ Bot service.
 - If the bots are not displayed in the learning instances, clear the browser cache.
- b) After the registration, restart the Automation Anywhere Cognitive Application service.

4. Modify the output file name

- a) After the data is migrated, ensure you modify the name of the output `.csv` file.
The output `.csv` file in Automation 360 IQ Bot contains additional characters. If you are using the `download` command, use the following instructions to edit the output `.csv` filename:
- Remove the brackets [].
 - Replace the underscore (`_`) character with a hyphen (`-`).
 - Replace spaces with underscore (`_`).
- For example, if the output `.csv` filename is `[sales-7d6 961f3d28]_Invoice.tiff`, rename it as `sales-7d6_961f3d28-Invoice.tiff`.

5. Verify the migrated data

- a) Log in to the Automation 360 IQ Bot as a newly created IQ Bot user.
- b) Review the data displayed on the **Dashboard** to ensure that the IQ Bot 11.3.x data has been migrated.
- c) You can also verify the migrated data by checking the following pages:
- Learning Instances
 - Domains
 - Bot Pages

Ensure that the current OCR version is supported in Automation 360 IQ Bot.

- ABBYY FineReader Engine - 12.2, 12.3, or 12.4 (use the version provided in the installation folder)

Note: To upgrade the OCR version, download the OCR package to the installation folder.

- Tesseract OCR - 4
- Google Vision API - version is updated automatically to match current release
- Microsoft Azure Computer Vision OCR engine - 2.0 or 3.2
- Tegaki API - check with your Cogent Labs sales representative

Related information

[IQ Bot migration with keys stored in external vault \(Login required\)](#)

Migrate from Automation 360 IQ Bot On-Premises to Cloud

IQ Bot Cloud offers all the Automation 360 IQ Bot On-Premises features through a browser-based interface.

- Migrate Control Room before migrating to IQ Bot Cloud. If you have Control Room available on Cloud, you can migrate to IQ Bot Cloud.
 - Install the latest version of Automation 360 IQ Bot On-Premises before migrating to IQ Bot Cloud.
- See [Migrate earlier IQ Bot versions to Automation 360 IQ Bot On-Premises](#) .
- Ensure that an active IQ Bot Cloud instance with the same version is available.
 - If there is an incorrect IQ Bot registration data, ensure that you remove it before creating the correct registration data.

Keep in mind the following considerations when migrating from Automation 360 IQ Bot On-Premises to IQ Bot Cloud:

- IQ Bot Cloud is a single-node instance.

Before you start the migration, ensure that you review the document processing and concurrency requirements. Cluster setup is not supported on IQ Bot Cloud.

- Configuration files cannot be accessed in the IQ Bot Cloud.

Custom OCR settings in configuration files have to be uploaded into Automation 360 IQ Bot On-Premises database before migration.

How to change OCR Settings in IQ Bot (A-People login required)

- Python scripting is restricted to specific libraries on IQ Bot Cloud.

Customer-specific Python files, specific libraries, and methods are not allowed in IQ Bot Cloud.

List of supported Pandas Libraries in Automation 360 IQ Bot (A-People login required)

- Role-Based Access Control (RBAC) setup that you have configured on the Automation 360 IQ Bot On-Premises is not migrated to IQ Bot Cloud.

See *RBAC in Control Room* .

- Transfer the .iqba files to IQ Bot Cloud.

Any custom roles that you have created are removed before .iqba files are created. Ensure that you add these roles after transferring the .iqba files to IQ Bot Cloud.

Users have the following options to upload the .iqba file to IQ Bot Cloud:

- Click **Migration Utility** > **Export/Import** in Automation 360 IQ Bot On-Premises (starting from Build 5931).

Migrate learning instances

- Migrate learning instance in IQ Bot Cloud through API. Use the Migration Utility feature to generate .iqba learning instance files, transfer them between systems, and import them into new IQ Bot databases.

Migrate Learning Instances in IQ Bot Cloud through API (A-People login required)

1. Export custom domains from Automation 360 IQ Bot On-Premises to IQ Bot Cloud.

Custom domains in IQ Bot

2. Use the Migration Utility feature to export learning instances from the Automation 360 IQ Bot On-Premises version.
3. Use the IQ Bot UI or API to upload the .iqba file to IQ Bot Cloud.
4. Open IQ Bot Cloud and import learning instances by using Migration Utility.

All your learning instances from Automation 360 IQ Bot On-Premises are imported and available on IQ Bot Cloud.

Important: Review the following points:

- If the learning instances are large, migrate them one at a time to avoid timeouts.
 - If you use custom domains, migrate them.
 - Import the custom domains in the same order as they were in in the Automation 360 IQ Bot On-Premises version.
-

Migrate learning instances

Use the Automation 360 IQ Bot Migration Utility feature to migrate (export and import) learning instances between environments to avoid recreating similar learning instances and easily manage the lifecycle of the associated bots.

The learning instances can be migrated by the IQ Bot administrator or a user associated with custom role that has migration permissions. View a list of available learning instances by using **IQ Bot > Administrator > Migration** to go to the Migration Utility page.

What is transferred across environments

When you export a learning instance, an IQBA file is created with the following assets:

- Document groups
- Training documents (one per document group)
- RPA bots (one per document group)
- Custom domain (contact Automation Anywhere Enterprise support for assistance with transferring this type of asset)

Note: Production documents cannot be exported.

Transferring learning instances between IQ Bot environments

To move a learning instance from one environment to another, perform the following steps:

1. Ensure that the source and destination systems are running the same IQ Bot version. Learning instances from different IQ Bot versions cannot be imported because their database schemas will not match.
2. Back up your database and export the learning instances from the source IQ Bot environment: [Backup and export learning instance](#)
3. Import the IQBA file into the destination IQ Bot environment: [Import learning instance](#)

Backup and export learning instance

Ensure you backup your existing learning instance before exporting it. A learning instance is exported as IQ Bot archive (IQBA) file. Groups, bots, and learnings associated with the learning instance are also exported.

When you export a learning instance, only a single document associated with every available bot (Group) training is exported. However, the production documents do not get exported.

Note: Ensure that you do not export a learning instance that has only unclassified groups.

1. Log into IQ Bot as an administrator.
2. Click **Administration > Migration**.
3. Click **Create Backup**.
4. Select the learning instances you want to back up and then click **Backup**.

- Enter an appropriate name for the IQBA file and click **Backup** to begin the export process.
The exported data file with the .iqba extension is available in the BackupData folder in your IQ Bot output directory. For example, C:\Users\Public\Documents\Automation Anywhere IQBot Platform\Output\BackupData.

Import learning instance

Import a learning instance to use the associated groups and bots in a different Automation 360 IQ Bot environment.

You can only import a learning instance into a similar or equivalent IQ Bot version. For example, you can only import an IQ Bot On-Premises (Build 9642) learning instance into an equivalent version of IQ Bot On-Premises or Cloud.

- Log into IQ Bot as an administrator.
- Click **Administration > Migration**.
- Click **Upload**.
- Select the .iqba file you want to upload from your file system.

Exported learning instances are stored as .iqba files. Ensure you select the correct file to import your learning instances into your new IQ Bot environment.

- Select from the following import options:

Import option	Result
Option 1: Append imported groups and trained bots to duplicate existing learning instances:	Merges new document groups and bots in existing learning instances. Note: When you import the .iqba file using this option, a trained group in the imported file overwrites an untrained group in the destination environment.
Option 2: Import learning instances, and ignore duplicate learning instances:	Appends only new learning instances, where the learning instance ID in the .iqba file differs from the ID in the destination environment. If a learning instance ID in the .iqba file is the same as an ID in the destination environment, the learning instance from the file is not appended.
Option 3: Overwrite duplicate existing learning instances with imported learning instances:	All documents groups and bots in the existing learning instance in the destination environment are replaced with the ones from the imported file. This does not impact the dashboard metrics. Note: You must use this option if the learning instance in the .iqba file was edited (for example, if fields or table columns were added).
Option 4: Remove all existing learning instances and replace with imported learning instances:	Only use this option if it is okay to lose all the work done so far in an IQ Bot environment.

Additional considerations

- If the `.iqba` file contains a document group that was previously deleted from the learning instance in the destination environment and you import it using Options 1,3, or 4, IQ Bot restores the deleted version of that group.
- Document groups in the `.iqba` file are imported in the same state as they were exported. For example, if you select Option 3 to overwrite a learning instance with a group in production mode with an imported learning instance that has a group in staging mode, that imported group remains in staging mode and incoming documents will not be automatically processed.

For more information on how each option impacts the groups, see [Example: Import options results](#).

6. Click **Open**.

After your file is uploaded, click **Refresh** to manually refresh the page and use the uploaded file from the list.

7. Click the import icon next to the backup entry in the list.

The imported learning instances are restored in the destination environment.

Example: Import options results

If the destination IQ Bot environment contains a learning instance with the same ID as the one in the IQBA file, you must select an import option to instruct IQ Bot how to handle the document groups in the learning instance. This page walks you through the most-common scenarios.

Scenario 1: Destination environment is empty

In this scenario, the destination environment is empty, such as in the case of a new installation of a testing environment. For the simplicity of this example, the IQBA file contains one learning instance with two groups. The fourth column of the table shows the outcome of each import option.

G = group

Import option	Environment before importing IQBA file	IQBA file	Environment after importing the IQBA file
Option 1: Append imported groups and trained bots to duplicate existing learning instances:		G1, G2	G1, G2
Option 2: Import learning instances, and ignore duplicate learning instances:			G1, G2
Option 3: Overwrite duplicate existing learning instances with imported learning instances:			G1, G2

Import option	Environment before importing IQBA file	IQBA file	Environment after importing the IQBA file
Option 4: Remove all existing learning instances and replace with imported learning instances:			<i>G1, G2</i>

Scenario 2: Import a learning instance with new groups

In this scenario, the learning instance in the IQBA file has document groups which are not present in the learning instance in the destination environment. The fourth column of the table shows the outcome of each import option, with the groups already present in the environment italicized for emphasis.

Note that in option 3, the imported learning instance (IQBA file) overwrites the duplicate existing learning instance. To determine whether a learning instance is a duplicate, **the system compares the IDs of the learning instances in the two environments, not the groups**. As a result, the environment after the import only contains G3.

Import option	Environment before importing IQBA file	IQBA file	Environment after importing the IQBA file
Option 1: Append imported groups and trained bots to duplicate existing learning instances:	<i>G1, G2</i>	G3	<i>G1, G2, G3</i>
Option 2: Import learning instances, and ignore duplicate learning instances:			<i>G1, G2</i>
Option 3: Overwrite duplicate existing learning instances with imported learning instances:			G3
Option 4: Remove all existing learning instances and replace with imported learning instances:			G3

Scenario 3: Import a learning instance with duplicate groups

In this scenario, the learning instance in the IQBA file has the same groups as the learning instance in the destination environment, for example, the groups were retrained. The fourth column of the table shows the outcome of each import option, with the groups already present in the environment italicized for emphasis.

Import option	Environment before importing IQBA file	IQBA file	Environment after importing the IQBA file
Option 1: Append imported groups and trained bots to duplicate existing learning instances:	<i>G1, G2, G3</i>	<i>G3</i>	<i>G1, G2, G3</i>
Option 2: Import learning instances, and ignore duplicate learning instances:			<i>G1, G2, G3</i>
Option 3: Overwrite duplicate existing learning instances with imported learning instances:			<i>G3</i>
Option 4: Remove all existing learning instances and replace with imported learning instances:			<i>G3</i>

Migration Utility enhancements

Starting from the Automation 360 IQ Bot.14 release, enhancements for importing learning instances (that were created using a custom domain) to the production server are available.

Migrating learning instances (that were created using a custom domain) from one system to another does not automatically import the associated domain to the target system. Therefore, when you run the imported learning instances on the production documents, the documents do not get classified because the associated field names and IDs for the custom domain do not work in the imported learning instance.

Migrating single or multiple learning instances

Prerequisite: The same version of the custom domain must exist in the staging (source) and production (target) servers.

IQ Bot includes some checks for importing a learning instance to the production environment to ensure the custom domain associated with a learning instance is migrated to the production server first, so the learning instances do not fail after migration.

- You can import the same learning instance to the production server multiple times.

However if you import a learning instance with an edited or updated domain and if the updated domain does not exist in the production server, the system will not allow you to import the learning instance.

- In this scenario, if the **Import** option is used (**IQ Bot** > **Migration** tab) to import the learning instance, a system-generated error message is displayed stating that the learning instance version is incompatible, and the import process is canceled.

- IQ Bot checks for the following when importing a learning instance to the production server:
 - Does the domain exist in the production server?
 - Do the same fields exist in the production server?
 - Do the same field aliases (available variations for a specific field in the documents) exist in the production server?
- Learning instance import fails if the system detects an issue with any of the checks.
- An import is successful when the user has maintained the same version of the custom domains, associated with the learning instance, in the staging and production servers.

If the learning instance import fails, the user can find the reason for the migration failure in the following locations:

- In the IQ Bot `Project service log` files, which will show an inconsistency in any of the following parameters:
 - domain name
 - field names
 - project or learning instance name
 - field alias names
- In the **Control Room > Audit logs**

Custom domains in IQ Bot

Migrating RBAC in IQ Bot

When you migrate learning instances that are associated with custom roles, you must also migrate the roles to enable users in the destination environment to access the learning instances. Before you start your migration, review the comparison matrix for in RBAC IQ Bot 11.3.5.x with Automation 360 IQ Bot.

Comparing RBAC

The following table compares RBAC provided in IQ Bot 11.3.5.x with Automation 360 IQ Bot:

Feature	Supported in IQ Bot 11.3.5.x	Supported in Automation 360 IQ Bot
Separation of permissions to learning instances by departments using custom roles	Yes	Yes
Assigning roles to learning instances on creation	Yes	Yes
Support for system roles: <ul style="list-style-type: none"> • Automation 360 IQ Bot administrator • IQ Bot services • IQ Bot Validator 	Yes	Yes
Changing assigned role for learning instances	Yes	No

Feature	Supported in IQ Bot 11.3.5.x	Supported in Automation 360 IQ Bot
User can have different access levels to different learning instances	Yes	No
Transfer of roles when learning instances are moved from one environment to another	No However, you can use the Assign Roles functionality to assign roles to the learning instance.	No
All permissions of IQ Bot are implemented	Yes	No The following permissions are not implemented: <ul style="list-style-type: none"> • Edit learning instance • Delete learning instance • Send learning instance to production • Import domain

Requirements before migrating RBAC

- Ensure that you do not associate the role of a user who can create a learning instance with any of the IQ Bot system roles. Instead, associate these users with a custom role.
- If a user who can create a learning instance has a custom role, a correct role corresponding to the department must be assigned to ensure a seamless RBAC operation on the learning instance. However, ensure that these users do not have any other role assigned other than the custom role for creating a learning instance and the corresponding department role.
- User who can create a learning instance must not be associated with any non IQ Bot roles. This restriction is not applicable to other users with custom roles.
- All users who can create a learning instance must not be assigned to one custom role (for creating learning instance). Instead, these users must be assigned to department-specific custom role (for creating learning instance).
- Ensure that the **View ALL learning instances** permission is not used in the custom role because it provides users with access to IQ Bot services.
- Ensure that any role other than the department role is not assigned to a learning instance, as this can increase the risk of unauthorized users accessing the learning instance.
- Users with the **Launch validator** permission in the custom role can only view IQ Bot if there is at least one learning instance with documents to validate.

Plan your migration

RBAC functionality such as setup and features for custom roles differ between IQ Bot 11.3.5.x and Automation 360 IQ Bot. So keep the following in mind for migration:

- You can migrate RBAC to Automation 360 IQ Bot only from IQ Bot 11.3.5 or later versions.
- You can migrate IQ Bot 11.3.5.x to both Automation 360 IQ Bot On-Premises and Cloud.

- When you migrate RBAC, all the custom and user roles are also migrated from Control Room 11.3.5.x to Automation 360.
- Ensure you segregate the learning instances for RBAC use cases between departments, organization units, and so on.

Choose your RBAC migration path

Choose your RBAC migration path based on the IQ Bot version you are currently using and the Automation 360 IQ Bot deployment model that meets your business requirements:

- [Migrate RBAC to On-Premises](#)
- [Migrate RBAC to Cloud](#)

If you are performing the migration steps using APIs, see [IQ Bot roles migration APIs \(A-People login required\)](#)

Migrate RBAC to Automation 360 IQ Bot On-Premises

Migrate RBAC from an earlier IQ Bot version (11.3.5.x or later) to Automation 360 IQ Bot On-Premises for the latest features and enhancements.

1. Create new custom roles (department roles) corresponding to each department or organizational unit in Control Room.

Consider a scenario where you have setup the RBAC across various departments in your organization with HR_Dept, Finance_Dept and Sales_Dept as the department roles. For sub-divisions within these departments, the roles can be Finance_AP_Payments, Finance_Cash_Payments, and so on.

2. Ensure you give the following permissions for each department role that you create:

- **View IQ Bot**
- **View learning Instances**
- **View learning instances for same role in Control Room**

3. Add the respective department roles to all of the IQ Bot users in Control Room.

For example, Sam from the Human Resource department is assigned the HR_Dept role and Susan from the Finance department is assigned the Finance_Dept role.

4. Associate users who create learning instances with the corresponding roles.

Users creating learning instances for a department can only be associated with IQ Bot roles. For example, these users cannot be associated with roles such as AA Basic, AA Bot Developer, and so on.

Additionally, only the IQ Bot custom role with **Create learning instance** permission must be assigned along with the corresponding department role.

5. Backup the `LearningInstanceRoles` table in the Automation 360 IQ Bot database.

The database schema name is `IQBot`.

6. Use the following database query to get the list of learning instances and the roles from the migrated Automation 360 IQ Bot database:

```
SELECT p.name as LearningInstance,
       r.projectid as LearningInstanceID,
       r.role as Role FROM [IQBot].[dbo].LearningInstanceRoles r inner join
       [IQBot].[dbo].ProjectDetail p on r.projectid=p.id;
```

7. Download the output query of the database to a local CSV file.

For example, `learninginstanceroles.csv`

8. Remove all the role entries against the learning instances in the local CSV file.

For example, `learninginstanceroles.csv`. After removing the role entries, duplicate rows for each learning instance must be removed to keep just **1 row per learning instance** in the CSV file.

Note: If there are learning instances which are not RBAC controlled, then role entries must not be changed

9. Assign the department role (Step 3) to each of the learning instance in the local CSV file and save your changes.

10. Remove all the entries from the `LearningInstanceRoles` table in `IQBot` database scheme.

You can use the following SQL command to remove the entries:

```
DELETE from [IQBot].[dbo].LearningInstanceRoles;
```

11. Insert the modified learning instance role association defined in local CSV file (Step 8) into the `LearningInstanceRoles` table.

For example, use the following SQL statement:

```
INSERT INTO [IQBot].[dbo].LearningInstanceRoles
(projectid, role) values
('i13454546erty', 'HR_Dept');
```

12. Verify the RBAC setup in Automation 360 IQ Bot and ensure that only the correct users have the access to the learning instances.

Migrate RBAC to Automation 360 IQ Bot Cloud

Migrate RBAC from an earlier IQ Bot version (11.3.5.x or later) to Automation 360 IQ Bot Cloud for the latest features and enhancements.

1. Create new custom roles (department roles) corresponding to each department or organizational unit in Cloud Control Room.

Consider a scenario where you have setup the RBAC across various departments in your organization with `HR_Dept`, `Finance_Dept` and `Sales_Dept` as the department roles. For sub-divisions within these departments, the roles can be `Finance_AP_Payments`, `Finance_Cash_Payments`, and so on.

2. Ensure you give the following permissions for each department role that you create:

- **View IQ Bot**
- **View learning Instances**
- **View learning instances for same role in Control Room**

3. Add the respective department roles to all of the IQ Bot users in Control Room.

For example, Sam from the Human Resource department is assigned the `HR_Dept` role and Susan from the Finance department is assigned the `Finance_Dept` role.

4. Associate users who create learning instances with the corresponding roles.

Users creating learning instances for a department can only be associated with IQ Bot roles. For example, these users cannot be associated with roles such as `AA Basic`, `AA Bot Developer`, and so on.

Additionally, only the IQ Bot custom role with **Create learning instance** permission must be assigned along with the corresponding department role.

5. Backup the `LearningInstanceRoles` table in the Automation 360 IQ Bot database.

The database schema name is `IQBot`.

6. Use the following database query to get the list of learning instances and the roles from the migrated Automation 360 IQ Bot database:

```
SELECT p.name as LearningInstance,
r.projectid as LearningInstanceID,
r.role as Role FROM [IQBot].[dbo].LearningInstanceRoles r inner join
[IQBot].[dbo].ProjectDetail p on r.projectid=p.id;
```

7. Download the output query of the database to a local CSV file.

For example, `learninginstanceroles.csv`

8. Remove all the role entries against the learning instances in the local CSV file.

For example, `learninginstanceroles.csv`. After removing the role entries, duplicate rows for each learning instance must be removed to keep just **1 row per learning instance** in the CSV file.

Note: If there are learning instances which are not RBAC controlled, then role entries must not be changed

9. Assign the department role (Step 3) to each of the learning instance in the local CSV file and save your changes.
10. As the `LearningInstanceRoles` table in IQBot Cloud will be empty, provide the CSV file (Step 9) to Automation Anywhere support so that they can update the Cloud database.
11. Insert the modified learning instance role association defined in local CSV file (Step 9) into the `LearningInstanceRoles` table.

For example, use the following SQL statement:

```
INSERT INTO [IQBot].[dbo].LearningInstanceRoles
(projectid, role) values
('i13454546erty', 'HR_Dept');
```

Note: Ensure you perform this step for all the entries in the local CSV file.

12. Verify the RBAC setup in Automation 360 IQ Bot and ensure that only the correct users have the access to the learning instances.

Build

Automation 360 provides a browser-based, intuitive experience for users to easily automate tasks and powerful tools for developers to build process automation, delivering security, and governance.

Overview

Our RPA Workspace is a web-based workspace that provides the tools and capabilities to create, upload, and deploy bots to automate repetitive tasks and processes. It includes the Control Room, Bot editor, Bot Runners, Bot Creators, and Credential Vault.

RPA Workspace provides the following capabilities:

- Automate fast and customize with an actions library for the complicated processes
- Get full visibility and orchestration, from scheduling to automating workloads, with the Control Room
- Assign and manage role-based access with full control and audit trail of every event
- Multi-layered security from cloud to platform to bots ensures granular, privileged access to data.

Build bots

Use our Bot editor to create and edit bots on any device and from a web browser. See [Bot editor for creating bots](#).

Watch the following videos to get started on building bots:

- Short video on building your first bot:
- Detailed video with a step-by-step guide toward becoming an RPA developer:

For RPA courses, tutorials, certificates and more, visit: [Automation Anywhere University: RPA Training and Certification \(A-People login required\)](#).

Related reference

[Actions palette for bot creation](#)

Use actions to build an automation workflow and to instruct a bot what to do. The available actions are located in the Actions palette of the Bot editor in the Control Room.

[Variables overview](#)

Automation 360 offers a variety of variables, each designed to hold specific types of data and is intended for specific use. Use the topics below to learn more about each variable and how to use them.

Related information

[Training - Getting Started with RPA](#)

Bot editor for creating bots

The Bot editor enables users to create and edit bots on any device and from anywhere the user can access a web browser.

Overview

Because Automation 360 is web-based, there is no separate client to download. Access the Bot editor by logging in to Automation 360, navigating to **Automation** on the left panel, and then creating or opening a bot.

The Bot editor is a web-based environment and includes the following features:

- Universal Recorder to simplify capturing processes
- Search for a bot from the public workspace and your private workspace and add that bot to the current bot.

The location of the selected bot in the public and private workspaces is also displayed.

Note: An error occurs if you add a bot from a folder in the public workspace for which you do not have the **Clone** permission for that folder.

- Powerful bot code management
- Python and JavaScript actions support inline scripting without linking, with drag-and-drop integration
- Rich variable passing, with no cross-language mapping required

Bot editor

Use the Bot editor to create and edit any bot through a web browser, regardless of the device or location. When you create a bot or modify an existing bot, the Bot editor is displayed.

You can create a bot by using the following options:

- On the **Home** page, click **Create a bot**.
- On the **Automation** page, click **Create new** > **Bot** in the top-right corner.
- In the **Files and folders** table, click **Create a bot** (🔗).

You can modify a bot by using the following options:

- On the **Automation** page, select the bot to modify, click the actions menu (vertical ellipses) and click **Edit Task Bot**.
- Select and open the bot you want modify.

See also the video at the end of this page on how to get started with the Bot editor.

There are three view options for bot creation:

Note: You can use the search box in the **Flow**, **List**, or **Dual** view to search for text, variables, or actions in a bot. This feature can be helpful when you view or edit a bot with longer code lines.

- **Flow:** Displays actions used in an automation as a flow diagram (Default)

Note: The **Flow** view is not available when you create or edit a bot and the bot exceeds 500 lines of code. Use the **Show list view** option to navigate to the list view.

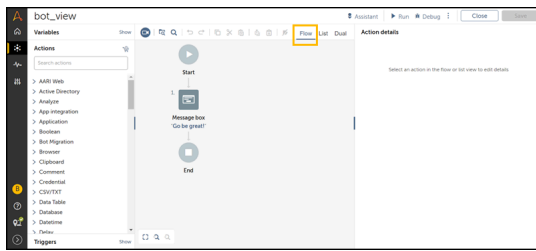

- **List:** Displays the actions used in an automation as a list

Note: Drag the selected actions within the task logic.

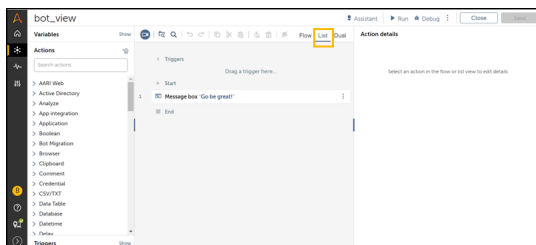

- **Dual:** Displays the actions used in an automation from both **Flow** and **List** view aspects

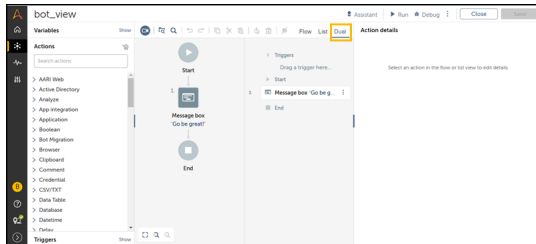

The **Flow**, **List**, and **Dual** views display the following properties of actions:

- The value that you enter for actions such as **Set text** for all the supported technologies
- Names of the objects on which actions such as **Set text**, **Click**, **Left click**, **Get property**, and **Select item by index** are performed
- Name of the object property mentioned in the action
- Name of the return variable if some value is assigned to a variable
- List of properties for the **Get property** action

Bot Assistant

When you create a bot, use the feature Bot Assistant to get a comprehensive view of line numbers of the bots that require your action.

The Bot Assistant displays the name of the packages or action and line number on which action is required by you. When you click the line number, it directly takes you to the line where the error occurs.

For migrated bots, the Bot Assistant displays a comprehensive view of the package or action and line numbers of the bots that require review or action by you.

<https://aa2019packagesdkfordocumentation.s3-us-west-2.amazonaws.com/videos/about-bot-editor.mp4>

More resources

- Free Automation 360 bots and command packages from Bot Store: [Automation 360 and AARI pre-built automation](#)
- [Create your first bots](#)

Related tasks

[Run a bot](#)

You can run a bot to test an automated process.

Related reference

[Edit a bot](#)

Edit bot logic using the Bot editor to add, modify, or delete actions and automation steps.

Keyboard shortcuts to expand or collapse elements in bot logic

When you are creating a large bot, you can expand or collapse sections using keyboard shortcuts in both **Flow** and **List** views.

By using this feature, you can improve your productivity as a Bot Creator. It enables you to use keyboard shortcuts in a specific section or all sections, and you can move quickly through the process of developing a bot.

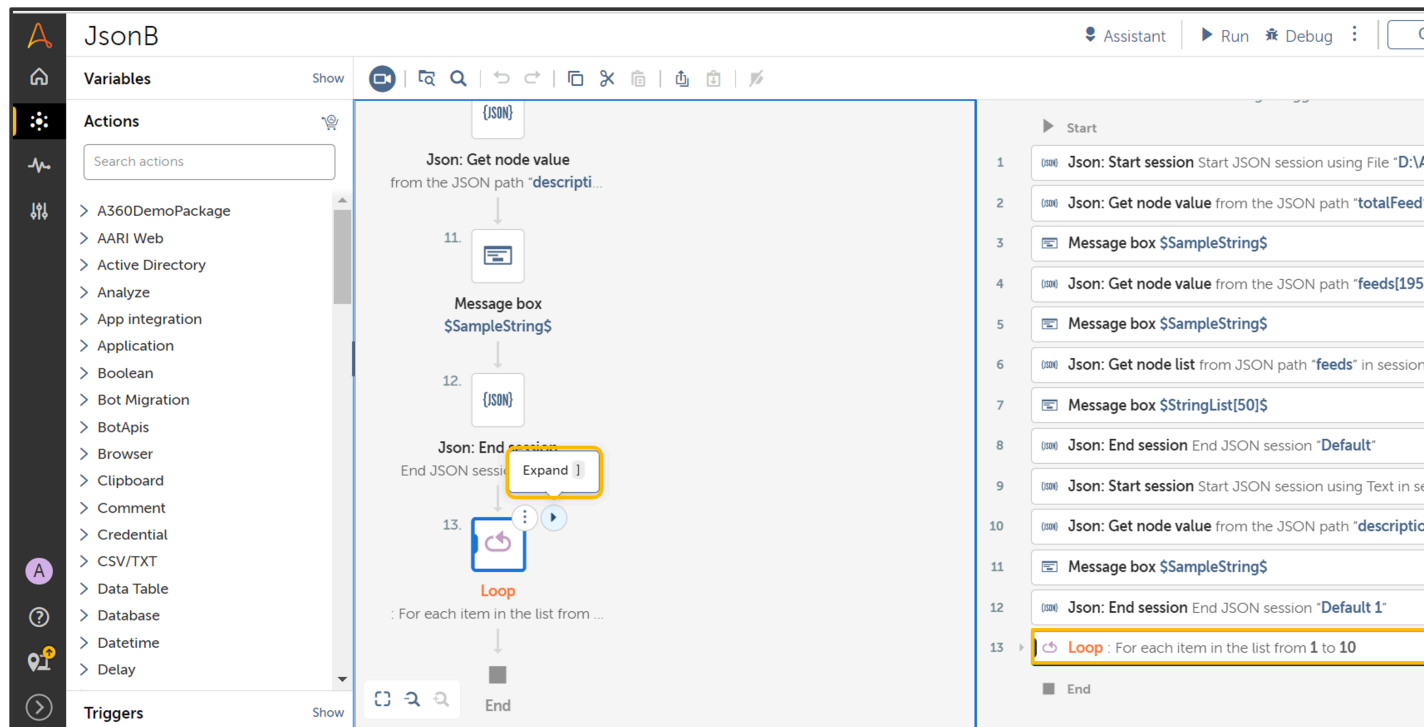

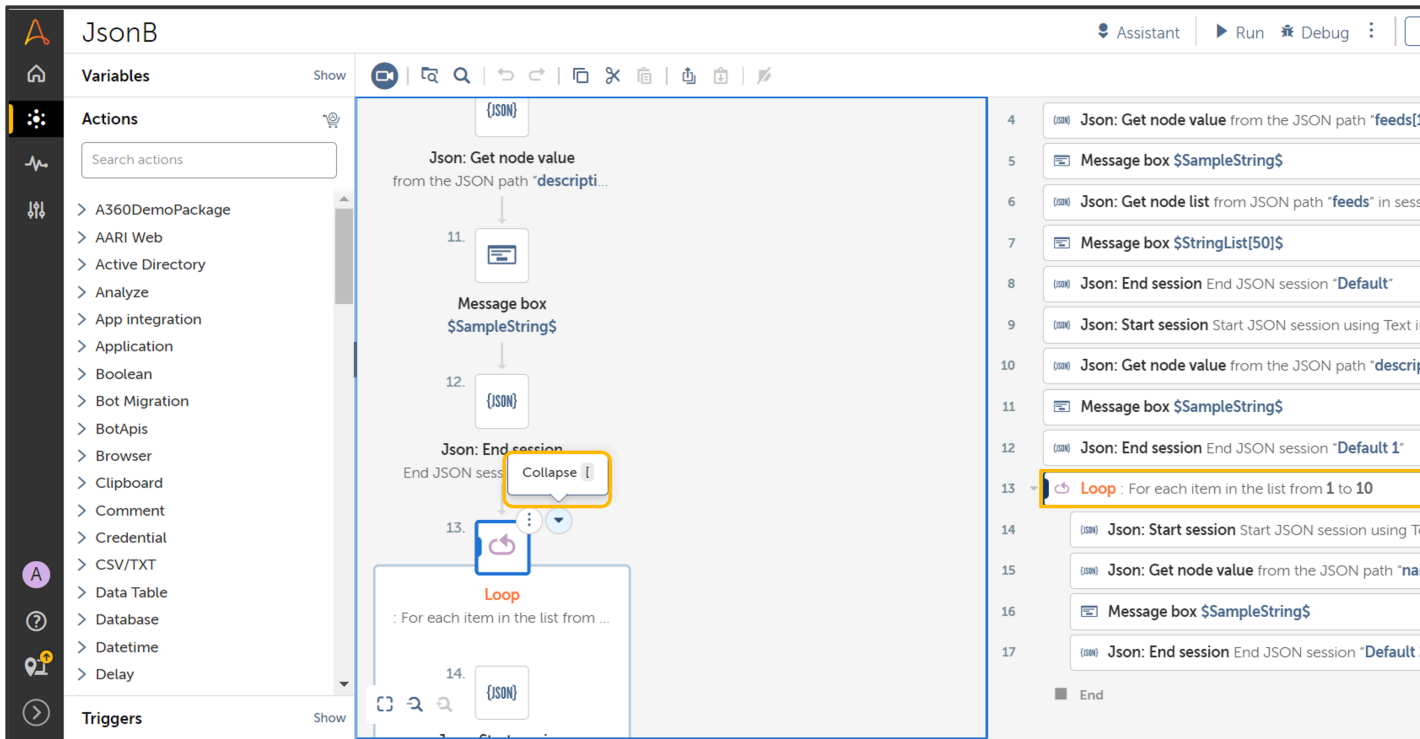

Shortcuts to expand or collapse an action is applicable only when the section is selected. You can use the following list of keyboard shortcuts in your bots.

Shortcut	Action
[Collapses the current node
Ctrl+[Collapses all the nodes
]	Expands the current node
Ctrl+]	Expands all the nodes
←	Collapses the current node or collapses to parent if already collapsed
→	Expands the current node

These keyboard shortcuts to expand and collapse nodes are supported in the following packages and actions:

- Loop package
- If package> **If**, **Else if**, and **Else** actions
- Error handler package> **Try**, **Catch**, and **Finally** actions
- Step package
- Trigger Loop package> **Trigger Loop** and **Handle** actions

Actions palette for bot creation

Use actions to build an automation workflow and to instruct a bot what to do. The available actions are located in the Actions palette of the Bot editor in the Control Room.

Actions, packages, and dependencies

Actions are grouped into packages based on the technology they automate. For example, the Excel advanced package contains Excel-related actions, such as **Open workbook**, **Go to cell**, and **Delete cell**, which you can insert in the Bot editor to automate a spreadsheet process.

Each package is upgraded and enabled individually to support new functionality. New bots are built with the default version. Existing bots are not automatically updated. They run using the same package version that they were built with until the Bot Creator manually upgrades to the new version.

When the Control Room deploys a bot, the packages used to create the automation are collected and sent to the Bot Agent on the destination device. The Bot Agent caches the packages so that it does not require updates each time the bot runs.

To shorten the runtime the first time a bot runs on a device, preload the packages using the **Preload packages** option in the Bot editor. The system loads the packages to `\ProgramData\AutomationAnywhere\GlobalCache` on the local machine for quick access at runtime.

After an action from a package is used in a bot, that package becomes a dependent file of that bot.

- Learn more about managing packages in [Packages](#).
- Developers can learn more about creating packages in [Package SDK](#).
- Learn more about managing bots and package dependencies in [Bot dependencies](#).

Packages and exe files

Packages	exe process files
DLL	Automation.CSharpDLLWrapper.exe
Database	Automation.DatabasePlayer.exe

Working with actions

Important: Each action in a package provides minimum compatible Control Room and Bot Agent version information when you create bots. So you can update your bots and reduce runtime errors caused by an incompatible Control Room or Bot Agent version.

You can configure actions in the Bot editor. Double-click the action to view the fields and features that you can configure, and double-click or drag an action to insert it into the automation.

Move the mouse over the vertical ellipsis at the top right of an action icon to access the following features:

Copy action	Duplicate the action.
Cut action	Copy the action and remove it from the bot code.
Paste after action	Paste the copied action below the selected action.

Delete action

Note: This option only appears when there is an action in the clipboard.

Disable action

Remove the action from the bot code.

Enable breakpoint

At run time, bot ignores the action until you enable it.

Step over

Pauses the bot for debugging purposes.

Debugger features

Use the Step over icon to go to the next action in debug mode. By default, it starts from the first action in debug mode.

You can edit multiple actions at a time, using the toolbar at the top of the Bot editor.

Find in this bot (Search box)

Search for any text or action such as a package name, actions name, string name, or variable name in the Flow, List, or Dual view of the TaskBot. You can search text across multiple pages of the bot and do not require the pages to be loaded manually. This feature is useful for viewing or editing a bot with longer code lines to determine where the searched text, such as variables, strings, or actions is used and in which line.

- You can search only within the lines of the code in the Bot editor.
- The search is not case-sensitive.

Copy items

Copy actions to a clipboard so they can be duplicated within the bot.

Cut items

Copy the actions and remove them from the bot code.

Paste items

Paste one or more actions after the highlighted action. If you have not highlighted an action, the actions are appended to the end of the automation sequence.

Note: This icon is only enabled when there are actions in the clipboard.

Copy to shared clipboard

Copy actions, triggers, and metadata to a clipboard that is shared between bots.

Paste from shared clipboard

Paste actions, triggers, and metadata from another bot.

Note: This icon is only enabled when there are actions in the shared clipboard.

Auto-save functionality of events in Bot editor

In the Bot editor, when you use actions to build an automation, when a bot is not manually saved, an auto-save is performed and the bot now automatically saves the changes for specific events.

Note: The auto-save functionality is currently available only for specific events.

Some of the events that support auto-save functionality are as follows:

- Recorder: When you create a bot with certain actions and click **Recorder**, the event is saved, and when the recording is complete, the event is automatically saved.
- Variable manager: When you create or edit a variable to insert it in an action, the changes are saved.

Note: The auto-save functionality is not supported when you delete a variable or insert it by pressing F2 to open the variable list.

- Actions menu (vertical ellipsis): When you select any action from this menu, for example **Packages**, the event is saved automatically. When you make any change to the **Packages** page and return to the Bot editor, the event is saved.
- Find a file: When you click the **Find a file** icon, the bot is saved if it is not manually saved. Also, after you click the **Add** option, the bot is automatically saved.
- Dialog boxes: When a dialog box is opened, it is automatically saved if any changes are made.

Note: Auto-save is triggered only for top-level dialog boxes and not for nested dialog boxes.

- Deleting variables: When you delete unused variables, the event is saved.
- Bot name change: If you edit the name of a bot, the event is saved.

Resources

Related reference

[Bot editor for creating bots](#)

The Bot editor enables users to create and edit bots on any device and from anywhere the user can access a web browser.

Advanced search feature in the Bot editor

Search for any text value or variable name within action details across a bot by using the **Advanced search** feature.

You can access **Advanced search** in the Bot editor in one of the following ways:

- In the search box (**Search in this bot**), click the **Advanced search** icon before the close button. When you click the **Advanced search** icon, a new **Advanced search** page is opened within **Assistant**.
- Use the following shortcut key to open the **Advanced search** page: Ctrl + Shift + F
- Open the **Assistant** and select the **Advanced search** option.

If you enter the search text first in the simple search box and then click the **Advanced search** option, the exact search text is carried over and displayed on the **Advanced search** page.

Advanced search

When you edit or view a bot, you can use the advanced search feature to find the exact line of action and the corresponding action details where the search text appears, select the search filter criteria, and navigate through the search results. The **Advanced search** feature comprises three components: search text, search filters, and search results

Search text

In the **Advanced search** page, you can enter a search text in the search box. You can search for a text value, variable name, or long text that has multiple matches.

Note: **Advanced search** is not case sensitive.

Search filters

You can use filter criteria to narrow down the search results and quickly locate the search text. The search filters can include the following search criteria:

- Canvas (Flow and List views): to search for any text within the canvas that is displayed in the flow and list views.
- Text value: to search for any text value within the action details.
- Variable name: to search for any variable name within the action details.

You can select or clear one or all the filter check boxes depending on the search criteria.

Search result

When you enter the search text and select the filter criteria, the **Advanced search** page displays the search results based on action names across the different lines of the bot.

The **Results** header displays the total count of matched action names and the count of selected action or line item in a bot. For each action name listed, the line number containing the action and the total matching results found within the action details are displayed as **Action or Trigger | Line number | Number of matches**.

Note: The count displayed in the **Results** header displays only the count of matching line items (or actions) within the bot. However, each line item can have multiple matches and is not counted in the total matching line items. For individual line items, the count of multiple matches is displayed within the particular line item in the **Results** tab.

When you select a specific line item against the action name, the action detail page opens within **Results** tab displaying a list of all matching results within that action.

When there is more than one search result, you can use the **Back** button to go to the previous line and the **Next** button to go to the next item. When you select the **Back** or **Next** button, the action is highlighted in the canvas, and the detail of the corresponding item is displayed in the properties panel.

The following example shows how **Advanced search** works. You are editing a bot with lengthy lines of code. Now you want to search with the text `botname` in the **Assistant** window. The **Results** header shows the total count of 10 matched action names and line numbers with the count of matching line items, such as `If | Line 6 | 2 matches`.

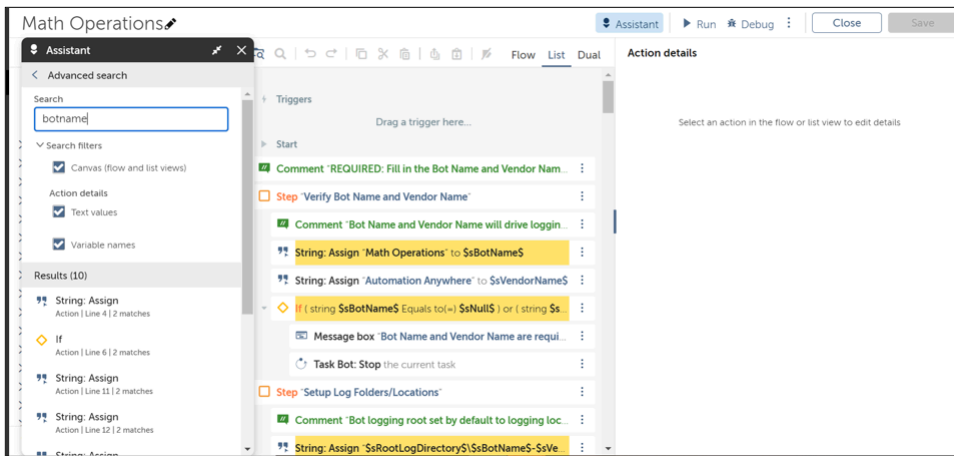

Figure 2: Search text

You can also select the search filter criteria and navigate through the search results.

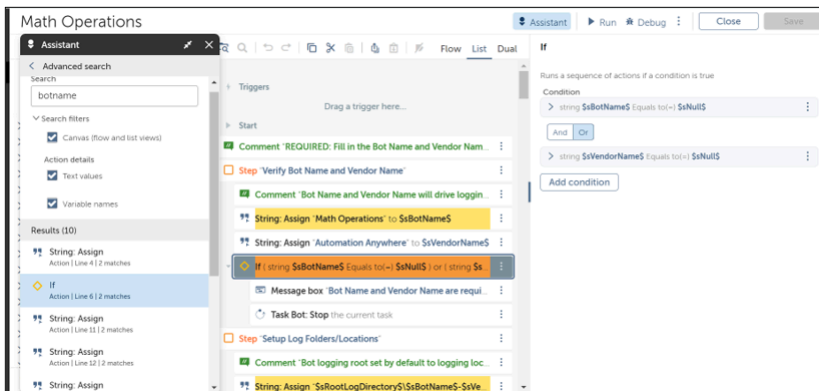

Figure 3: Search filter

When you click a matching item from the action details, for example, if you select the second search result If | Line 6 | 2 matches in the **Results** tab, you will see the complete line of action that contains the search text highlighted in the canvas, and the details of the selected action are displayed on the properties panel. You can see that the searched text `botname` is appearing in the if condition, as shown in the properties panel.

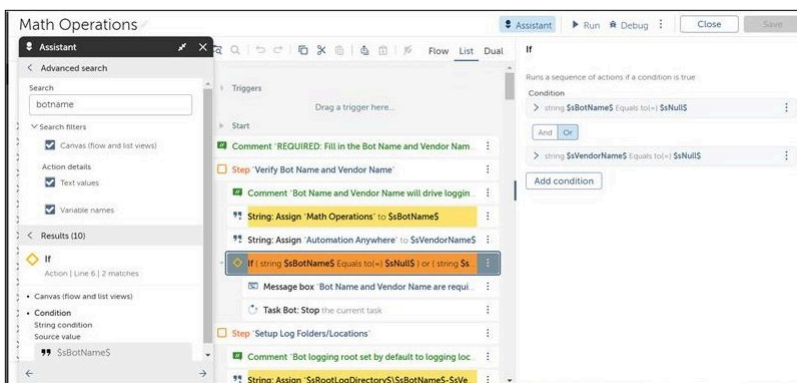

Figure 4: Search results

AARI Web package

The **AARI on the web** package contains actions that enable Control Room users to configure their bots to work on requests, tasks, and team members.

Before you start

Ensure you have met one of the following conditions in order to run this package:

Condition 1

- Access to a process in an assigned team.
- Access to an AARI User license.
- A system-created **AAE_Robotic_Interface User** role for the AARI user.

Condition 2

- Access to a Bot Runner license (Attended or Unattended) or Bot Creator license.
- A user-created role with the **View My Bots** and **Run My Bots** permissions.

Actions in the AARI on the web package

The **AARI on the web** package includes the following actions:

Action	Description
Assign Task	<p>Assigns options to a task.</p> <ul style="list-style-type: none"> • In the Task ID to be assigned field, specify a value. • In the User ID to assign to task field, specify a value. <p>For the task and user ID, you can select a value from the Variable or Global value options. The variable option enables you to add predefined variables ranging from time (minute, hour, day, month, year, etc) or system usages (CPU and RAM).</p> <ul style="list-style-type: none"> • Optional: In the Assign the result to variable field, assign a variable to store as an output. <p>The output is stored as a string value.</p>
Cancel Task	<p>Cancels a task.</p> <ul style="list-style-type: none"> • In the Task ID to cancel field, specify a value. <p>For the task, you can select a value from the Variable or Global value options. The variable option enables you to add predefined variables ranging from time (minute, hour, day, month, year, etc) or system usages (CPU and RAM).</p> <ul style="list-style-type: none"> • Optional: In the Assign the result to variable field, assign a variable to store as an output. <p>The output is stored as a string value.</p>

Action	Description												
Create a Request	<p>Creates a request.</p> <ul style="list-style-type: none"> In the Actions palette, double-click or drag the Create a Request action from the AARI Web package. In the Public Process field, browse and select the public process. The initial form fields from the process are displayed in the Input values field. These fields are from supported interactive form elements. In the Input values field, enter the values or variables to complete the required information to the initial form. <hr/> <p>Note: For passing the values through variables, create a custom variable of any type: String, Number, Datetime, Boolean, Dictionary, Table, or File. Use the Dictionary variable for completing the check box information in the initial form. Enter the variable information in the Type, Subtype, Key, and Value fields. In the Subtype field, choose Boolean. Follow the format convention while creating Dictionary variables.</p> <p>For example, consider the check box attributes as San Jose, Atlanta, and Sacramento, and we want to select the value Atlanta in the initial form field. Create a Dictionary variable of subtype Boolean in the format as follows:</p> <p>Name: CheckBoxGroup0</p> <table border="1" data-bbox="623 951 1463 1152"> <thead> <tr> <th>Attributes</th> <th>Key</th> <th>Value</th> </tr> </thead> <tbody> <tr> <td>San Jose</td> <td>CheckBoxGroup0_0</td> <td>false</td> </tr> <tr> <td>Atlanta</td> <td>CheckBoxGroup0_1</td> <td>true</td> </tr> <tr> <td>Sacramento</td> <td>CheckBoxGroup0_2</td> <td>false</td> </tr> </tbody> </table> <hr/> <ul style="list-style-type: none"> Optional: In the Assign the Request ID to field, assign a variable to store as output. This returns the ID of the created request. Optional: In the Assign the Request Reference to field, assign a variable to store as output. This returns the ID of the request that was created. Click Save. 	Attributes	Key	Value	San Jose	CheckBoxGroup0_0	false	Atlanta	CheckBoxGroup0_1	true	Sacramento	CheckBoxGroup0_2	false
Attributes	Key	Value											
San Jose	CheckBoxGroup0_0	false											
Atlanta	CheckBoxGroup0_1	true											
Sacramento	CheckBoxGroup0_2	false											

Action	Description
Get Storage file	<p data-bbox="581 205 1073 237">Download the storage file to a bot device.</p> <hr/> <p data-bbox="581 268 1461 426">Important: The Get Storage file action requires the matching of versions between the process version and the package version. Processes created before Automation 360 v.25 must be used with package versions from before Automation 360 v.25. Similarly, processes created after Automation 360 v.25 must be used with package versions after Automation 360 v.25.</p> <hr/> <ul data-bbox="581 464 1198 495" style="list-style-type: none"> <li data-bbox="581 464 1198 495">• Specify the storage file URI in the Variable field. <p data-bbox="618 510 959 541">Enter your file input variable.</p> <hr/> <p data-bbox="618 562 683 625"> Attention: You must only use the Variable option and the variable must be a file input that is populated from the process (Select File in Human Task). Do not use the Control Room file and Desktop file options.</p> <hr/> <ul data-bbox="581 720 1438 783" style="list-style-type: none"> <li data-bbox="581 720 1438 783">• In the Full path of file in local device to be saved to, specify the path to store your file. <p data-bbox="618 800 1461 957">You can select from Variable or Global value option. The variable option enables you to add a user-defined value, clipboard, string (enter, newline, separate, etc), system (task name, control room URL, etc), predefined variable package (date, minute, day, time, IP address, operating system, etc), or table analytic value.</p> <ul data-bbox="581 961 1190 993" style="list-style-type: none"> <li data-bbox="581 961 1190 993">• Optional In the Result field, choose a variable. <p data-bbox="618 1010 1019 1041">The output is stored as a variable.</p>

Action	Description
Query Requests	<p>Enables the user to query requests with custom filters.</p> <ul style="list-style-type: none"> • Select a filter. <hr/> <p>Note: The filters for process and request titles, tags, IDs, team name, and PII tags have the same list of options.</p> <hr/> <ul style="list-style-type: none"> • Specify the string value in the List or Variable field. <ul style="list-style-type: none"> • Specify your type in the List or Variable field. • List: Input your value information in the Type and Value at 0 fields. • Optional: In the Add field, add more values. • Variable: Enter your custom variable. • In the Request Status field, select a status. You can choose OPENED, SUCCESS, ERROR, and CANCELLED • In the Page field, specify a value. <ul style="list-style-type: none"> • In the Table start at offset of data field, enter a value. • In the Number of rows per page field, enter a value. The default value is set 200 for number of rows. • In the Sort field, specify the option. <ul style="list-style-type: none"> • In the Direction field, select Descending or Ascending. The default value is set to Descending for the direction. • In the Select sort column field, select an option. You can choose between process title or the request creation, ID, title, status, or PII tag. • Select the Enable 2nd degree sort and specify the Direction and Select sort column fields. • In the Assign the result to variable field, assign a variable to store as an output. The output is stored as a table value.

Action	Description
Query Tasks	<p>Enables a user to query tasks with custom filters.</p> <ul style="list-style-type: none"> • Select a filter. <hr/> <p>Note: The filter for process and request titles, tags, IDs, status, team name, and PII tags provide the same list of options.</p> <hr/> <ul style="list-style-type: none"> • Specify the string value in the List or Variable field. <ul style="list-style-type: none"> • Specify your type in the List or Variable field. • List: Input the value information in the Type and Value at 0 fields. • Optional: In the Add field, add more values. • Variable: Enter your custom variable. • In the Request Status field, select a status. You can choose OPENED, SUCCESS, ERROR, and CANCELLED • In the Task State field, select a status. You can choose IN_PROGRESS and COMPLETED. • In the Page field, specify a value. <ul style="list-style-type: none"> • In the Table start at offset of data field, enter a value. • In the Number of rows per page field, update the value. The default value is set to 200 for number of rows. • In the Sort field, specify the following options. <ul style="list-style-type: none"> • In the Direction field, select Descending or Ascending. The default is Descending for the direction. • In the Select sort column field, select an option. You can choose from the request and tasks IDs, titles, creation, status, or PII tags. You can choose from the request reference and task IDs, titles, creation, status, or PII tags. • Select the Enable 2nd degree sort and specify the Direction and Select sort column fields. • In the Assign the result to variable field, assign a variable to store as an output. The output is stored as a table value.

Action	Description
Team Members	<p>Retrieves the list of members of a team.</p> <ul style="list-style-type: none"> In the Supply team ID to query it's members field, specify a value. For the supply team ID, you can select a value from the Variable or Global value options. The variable option enables you to add predefined variables ranging from time (minute, hour, day, month, year, etc) or system usages (CPU and RAM). In the Supply team reference to query its members field, specify a value. For the supply team reference, you can select a value from the Variable or Global value options. With the variable option, you can add predefined variables ranging from time (minute, hour, day, month, year, and so on) or system usages (CPU and RAM). In the Assign the result to variable field, assign a variable to store as an output. The output is stored as a table value.

Example of using **Create a Request** action

The **Create a Request** action from the AARI Web package enables you to create a new request in AARI on the web through a bot. In this example, use the **Create a Request** action to pass data through bot variables to initial form of the AARI process.

- You must have a Bot Creator license and be assigned a custom role with the following permissions:
 - Check-in and check-out permission
 - Create folder permission
- Create a process and check-in the process to the public workspace
- Assign at least one team to the process with the default team selected
- Select the **by bot** option in the **Request creation** field

In this example, we will create a process to register new employee details in the company database. The initial form contains basic information such as Name, ID, Date of Birth, Gender, and Location. We will pass the initial form data through bot variables.

- Log in to the Control Room as a Bot Creator user.
- Create the initial form.

Create an AARI form.

- On the left plane, click **Automation**.
- Click **Create new > Form**.
- Enter the form name `employee_register_initial_form`.
- Enter the folder location `Bots\Employee Registration`.
To change where your form is stored, click **Choose** and follow the prompts.
- Click **Create & edit**.
- Use the following **Elements** and **Element label** in the form.

Elements	Element label
TextBox	Full Name

Elements	Element label
Number	ID
Date	Date of Joining
Dropdown	Gender
Checkbox	Location
Select File	Resume

- For the **Dropdown** element, enter `Male, Female` in the **Enter list items separated by commas** field.
- For the **Checkbox** element, click the **plus** icon in **Checkbox content** field and add the locations `San Jose, Tokyo, India`.
- For the **Select File** element, you can limit the file type which can be uploaded by specifying it in the **Enter supported file format separated by commas** field. For example; `doc, gif, pdf, png, txt, xls`.

- g) Click **Save**.
- h) Click **Close**.

3. Create a new process.

- a) In the same folder location, click **Create new > Process**.
Create an AARI process.
- b) Enter the process name `employee_register`.
- c) Click **Create & edit**.
- d) Click **Start** to add an initial form to the process.
- e) In the **Select initial data form** field, browse and select the initial form, `employee_register_initial_form`.
- f) Select `AARI Storage` in the **File upload storage** dropdown.
- g) Provide **Request title** as `Employee Registration`.
- h) Click **Save**.
- i) Click **Close**.
- j) Check in this process to the public workspace.

4. Create a new bot.

- a) In the same folder location, click **Create new > Bot**.
- b) Enter the bot name `employee_register_request_bot`.
- c) Click **Create & edit**.

5. Create the following variables:

- *emp_name*: String type; use as input.
- *emp_id*: Number type; use as input.
- *emp_date_of_joining*: Datetime type; use as input.
- *emp_gender*: String type; use as input.
- *emp_location*: Dictionary type, Boolean subtype; use as input. From the check box attributes given above, if you want to select the value San Jose for the location attribute in the initial form field, click the **plus** and create the dictionary variable in the format as given below:

Name: emp_location

Attributes	Key	Value
San Jose	CheckBoxGroup0_0	True
Tokyo	CheckBoxGroup0_1	False
India	CheckBoxGroup0_2	False

- *emp_resume*: File type; use as input, select **Desktop folder or file** for the **Default value** and browse and select the file you want to upload.
- *employee_registration_request_id*: Number type; use as output.

6. Use the **Create a Request action from AARI Web package.**

- In the **Actions** palette, double-click or drag the **Create a Request** action from the **AARI Web** package.
- In the **Public Process** field, browse and select the public process *employee_register*. The initial form fields from the process are displayed in the **Input values** field. These fields are from supported interactive form elements.
- In the **Input values** field, enter the values or variables to complete the required information to the initial form as given below:

- *emp_name*: \$emp_name\$
- *emp_id*: \$emp_id\$
- *emp_date_of_joining*: \$emp_date_of_joining\$
- *emp_gender*: \$emp_genders\$
- *emp_location*: \$emp_location\$. To select the location San Jose in the initial form field, add the key and value pair for the attributes as given below:

Attributes	Key	Value
San Jose	CheckBoxGroup0_0	True
Tokyo	CheckBoxGroup0_1	False
India	CheckBoxGroup0_2	False

- *emp_resume*: \$emp_resume\$
- *employee_registration_request_id*: \$employee_registration_request_id\$

- Click **Save**.
- Click **Close**.

7. Deploy the bot.
 - a) Click **Run**.
 - b) In the **Set input variables** field, enter the values for the input variable.
 - c) Click **Confirm**.

The bot deploys successfully and a new request is created through the default team assigned to the process. The initial form fields are filled with the input provided through the bot. In the web interface, an AARI admin can verify that a new request is created, and the data has been selected properly.

Active Directory package

Use the **Active Directory** package to automate actions in the Active Directory. An Active Directory is a directory service provided by Microsoft to assist the admin in managing users across a group or organization.

RPA Workspace uses Lightweight Directory Access Protocol (LDAP) to read from and edit users in the Active Directory. The server and domain names are combined to create an LDAP path, which is used to connect to the Active Directory.

Before you start

Perform the following actions within the **Active Directory** package as part of using the set of available actions:

1. Establish a connection with the Active Directory using the **Connect** action. Use this same session name for the other actions. *Using Connect action for Active Directory*
2. Use the actions to automate a task.
3. After you have automated all the Active Directory-related tasks, terminate the connection to the server using the **Disconnect** action.

Operations in the Active Directory package

The **Active Directory** package includes the following operations:

Operation	Description
Computer operations	See <i>Computer operations</i> .
Group operations	See <i>Group operations</i> .
LDAP operations	See <i>LDAP operations</i> .
Organizational unit operations	See <i>Organizational unit operations</i> .
User account operations	See <i>User account operations</i> .

Computer operations

The computer operations in the Active Directory package contain various actions to automate tasks related to computers, including create, delete, get property, rename, and set property.

Actions in the Active Directory package

The **Active Directory** package includes the following actions for computer operations:

Action	Description
Create computer	Creates a new object for the computer. <ul style="list-style-type: none"> Enter the same session name as the one you used in the Connect action. Enter a name for the computer. Optional: Enter a description of the computer.
Delete computer	Deletes an existing computer. <ul style="list-style-type: none"> .Enter the same session name as the one you used in the Connect action. Enter a name for the computer.
Get computer property	Retrieves a specific property value for a computer. <ul style="list-style-type: none"> Enter the same session name as the one you used in the Connect action. Enter the computer name. Enter the property. Assign the value to a string variable.
Move computer	<i>Using the Move computer action</i>
Rename computer	Renames an existing computer. <ul style="list-style-type: none"> Enter the same session name as the one you used in the Connect action. Enter a name for the computer. Enter a new name for the computer.
Set computer property	Assigns a value to a computer property. <ul style="list-style-type: none"> Enter the same session name as the one you used in the Connect action. Enter the computer name. Enter the property to update. Enter the new value.

Using the Move computer action

Use the Move computer action to move the computer from an existing location to a new location.

Ensure there is an existing computer.

Computer operations

1. In the **Actions** palette, double-click or drag the **Move computer** action from the **Active Directory** package.

2. Add the computer name:
 - Select the name from the server:
 - a. Click **Add computer from server**.
 - b. Enter the host and domain credentials in the **Connect to server** window and click **Connect**.
 - c. In the **Select computer** window, select the computer name from the **Domain Objects** panel and click **Apply**.
 - Enter the name in the **Computer name** field.
3. Add the LDAP path: or perform the following steps if you choose the option :
 - Enter the path in the **Move to** field.
 - Click **Select computer object** and perform these steps:
 - a. Enter the host and domain credentials in the **Connect to server** window and click **Connect**.
 - b. In the **Select computer** window, select the destination server path from the **Domain Objects** panel and click **Apply**.
4. Enter the same session name in the **Active Directory session** that you used in the **Connect** action.
5. Click **Save** and **Apply**.

Group operations

The group operations in the Active Directory package contain various actions to automate tasks related to groups, including create, delete, get property, and set property.

Actions in the Active Directory package

The **Active Directory** package includes the following actions for group operations:

Action	Description
Create group	<p>Creates a new group.</p> <ul style="list-style-type: none"> • Enter the same session name as the one you used in the Connect action. • Enter a unique name for the group. • Optional: Enter a description for the group. • Select the group scope from the following options: <ul style="list-style-type: none"> • Domain Local • Global • Universal <p><i>Group scope</i></p> <ul style="list-style-type: none"> • Select the group type from the following options: <ul style="list-style-type: none"> • Security: Provides users with access rights to folders. • Distribution: Sends emails to a group of users.

Action	Description
Delete group	<p>Deletes an existing group.</p> <ul style="list-style-type: none"> • Enter the same session name as the one you used in the Connect action. • Enter the name of the group to delete.
Get group property	<p>Retrieves a specific property value for the group.</p> <ul style="list-style-type: none"> • Enter the same session name as the one you used in the Connect action. • Enter the group name. • Enter the property. • Assign the value to a string variable.
Rename group	<p>Renames an existing group.</p> <ul style="list-style-type: none"> • Enter the same session name as the one you used in the Connect action. • Enter the group name. • Enter a new name for the group.
Set group property	<p>Assigns a value to a group property.</p> <ul style="list-style-type: none"> • Enter the same session name as the one you used in the Connect action. • Enter the group name. • Enter the property to update. • Enter the new value.

LDAP operations

The Lightweight Directory Access Protocol (LDAP) operations in the Active Directory package contain various actions to automate tasks related to LDAP, including connect, disconnect, and run query.

Actions in the Active Directory package

The **Active Directory** package includes the following actions for LDAP operations:

Action	Description
Connect	<i>Using Connect action for Active Directory</i>
Disconnect	Closes the connection with the LDAP server.

Action	Description
Run query	<p>Runs a specified Active Directory query. The query results are stored in a list variable, either for object names or LDAP paths, depending on the option selected. You must:</p> <ul style="list-style-type: none"> • Enter the same session name as the one you used in the Connect action. • Input the query. For example: (&(objectCategory=person)(objectClass=user)(name=A*)) • Specify the return type. Select either the Object Name or LDAP Path option. • Assign the value to a string variable.

Using Connect action for Active Directory

Use the **Connect** action to establish a connection with an Active Directory server. This is the first action you must use to automate an Active Directory related task.

This action enables you to provide the server credentials and details, and associate this information with a session name. Use this same session name for the other Active Directory actions so that you have to provide the server information only once.

To establish a connection with an Active Directory server, follow these steps:

1. In the **Actions** palette, double-click or drag the **Connect** action from the **Active Directory** package.
2. Enter a session name.
3. Enter or create the LDAP URL:
 - **Parent path:** Enter the LDAP URL that identifies the server that hosts the Active Directory services.
For example, `LDAP://192.168.2.60/DC=corporate,DC=com`
 - **Build parent path:** Create the LDAP URL:
 - a. Click the **Build parent path** option to connect to the Active Directory server.
 - b. In the **Connect to server** window, enter the host and domain credentials, and click **Connect**.
 - c. In the **Object Explorer** window, select the specific path from the **Objects** panel.
 - d. Verify the selected LDAP URL path in the **Preview** field and click **Apply**.
4. In the **Login user** field, provide your username with one of the following options:
 - **Credential:** Select a credential from the Credential Vault. *Credentials and credential variables in the Bot editor*
 - **Variable:** Select a variable holding a credential data type value. *Your variables (user-defined)*
 - **Insecure string:** Enter a value or select a variable.



Attention: Values entered using this option are not encrypted.

5. In the **Login password** field, provide your password with one of the following options:

- **Credential:** Select a credential from the Credential Vault. *Credentials and credential variables in the Bot editor*
- **Variable:** Select a variable holding a credential data type value. *Your variables (user-defined)*
- **Insecure string:** Enter a value or select a variable.



Attention: Values entered using this option are not encrypted.

6. Click **Save**.

Organizational unit operations

The organizational unit operations in the Active Directory package contain various actions to automate tasks related to organizational units, including create, delete, and rename organizational units, and get and set property.

Actions in the Active Directory package

The **Active Directory** package includes the following actions for organizational unit operations:

Action	Description
Create organizational unit	Creates a new object for the organizational unit. <ul style="list-style-type: none"> • Enter the same session name as the one you used in the Connect action. • Enter a name for the organizational unit. • Optional: Enter a description of the organizational unit.
Delete organizational unit	Deletes an existing organizational unit. <ul style="list-style-type: none"> • Enter the same session name as the one you used in the Connect action. • Enter the name of the organizational unit to delete.
Get organizational unit property	Retrieves a specific property value for an organization and assigns the results to a variable. <ul style="list-style-type: none"> • Enter the same session name as the one you used in the Connect action. • Enter the organizational unit name. • Enter the property. • Assign the retrieved value to a string variable.
Move organizational unit	<i>Using the Move organizational unit action</i>
Rename organizational unit	Renames an existing organizational unit. <ul style="list-style-type: none"> • Enter the same session name as the one you used in the Connect action. • Enter the name of the organizational unit to rename. • Enter the new name.

Action	Description
Set organizational unit property	<p>Assigns a value to an organizational property.</p> <ul style="list-style-type: none"> • Enter the same session name as the one you used in the Connect action. • Enter the organizational unit name. • Enter the property to update. • Enter the new value.

Using the Move organizational unit action

Use the Move organizational unit action to move an organizational unit from an existing location to a new location.

Ensure there is an existing organizational unit.

Organizational unit operations

1. In the **Actions** palette, double-click or drag the **Move organizational unit** action from the **Active Directory** package.
2. Add the organizational unit name:
 - Add the name from the server by performing these steps:
 - a. Click **Add organizational units from server**.
 - b. Enter the host and domain credentials in the **Connect to server** window and click **Connect**.
 - c. In the **Select organizational unit** window, select the organizational unit name from the **Domain Objects** panel and click **Apply**.
 - Enter the name in the **Organizational unit name** field.
3. Add the LDAP path: or perform the following steps if you choose the option **Select organizational unit object**
 - Enter the path in the **Move to** field.
 - **Select organizational unit object** and perform these steps:
 - a. Enter the host and domain credentials in the **Connect to server** window and click **Connect**.
 - b. In the **Select organizational unit** window, select the destination server path from the **Domain Objects** panel and click **Apply**.
4. Enter the same session name in the **Active Directory session** that you used in the **Connect** action.
5. Click **Save** and **Apply**.

User account operations

The Active Directory package contains various actions to automate tasks related to user account management, including create, delete, get property, remove, rename, and set property.

Actions in the Active Directory package

The **Active Directory** package includes the following actions for user account operations:

Note: We now support Active Directory user operations by logon name with domain and can provide the domain name to extract the user details. When you retrieve user property or perform any user operation based on the logon name (userPrincipalName), and if the user domain name differs from the domain specified in the LDAP path, the user properties are now successfully retrieved regardless of whether it contains a domain name or not.

For example, LDAP Path: LDAP://ADServer/DC=automation, DC=net

User	Logon name
userPrincipalName: kim@aaengg.net	User can provide logon name as kim@aaengg.net.
userPrincipalName: shaun@aasales.net	User can provide logon name as shaun@aasales.net.
userPrincipalName:sarah@automation.net	user can provide a logon name as either sarah or sarah@automation.net.

When you perform any user action on the logon name, and if the logon name has a duplicate user under subDomain and subDomain@rootDomain, the user property is retrieved for the user with the root domain.

For example, LDAP Path: LDAP://ADServer/DC=automation, DC=net

- User 1: userPrincipalName (logon name) is kim@aaengg.net.
- User 2: userPrincipalName (logon name) is kim@aaengg.net@automation.net.

If you enter the logon name as kim@aaengg.net or kim@aaengg.net@automation.net, the operations will be performed on the second user that is kim@aaengg.net@automation.net.

Action	Description
Add users to group	See Using the Add users to group action.
Create user	See Using the Create user action.
Change user password	Changes the user password. <ul style="list-style-type: none"> • Enter the user name. You can select Credential to use a value available in the Credential Vault, Variable to use a credential variable, or Insecure string to manually enter a user name. • Enter the new password. You can select Credential to use a value available in the Credential Vault, Variable to use a credential variable, or Insecure string to manually enter a password. • Enter the same session name in the Active Directory session that you used in the Connect action.
Delete user	Deletes the user. <ul style="list-style-type: none"> • Enter the same session name as the one you used in the Connect action. • Select whether to search for the user by User name or Logon name. <hr/> <p>Note: Before removing a user, make certain all unfinished development of bots are checked-in.</p> <hr/>

Action	Description
Disable user account	<p>Disables a user account.</p> <ul style="list-style-type: none"> • Enter the same session name as the one you used in the Connect action. • Select whether to search for the user by User name or Logon name.
Enable user account	<p>Enables a user account.</p> <ul style="list-style-type: none"> • Enter the same session name as the one you used in the Connect action. • Select whether to search for the user by User name or Logon name.
Get all users of a group	<p>Retrieves a list of all the users of a group, and assigns the results to a variable.</p> <ul style="list-style-type: none"> • Enter the same session name as the one you used in the Connect action. • Enter the group name. • Specify the return type. Select either the Object Name or LDAP Path option. • Assign the value to a string variable.
Get user property	<p>Retrieves a specific property value for a user and assigns the results to a variable.</p> <ul style="list-style-type: none"> • Enter the same session name as the one you used in the Connect action. • Select whether to search for the user by User name or Logon name. • Enter the property. • Assign value to a string variable.
Remove users from group	<p><i>Using the Remove users from group action.</i></p>
Rename user	<p>Renames the user logon name or the user account name.</p> <ul style="list-style-type: none"> • Enter the same session name as the one you used in the Connect action. • Select whether to search for the user by User name or Logon name. • Enter the name to search for. • In the New name field, enter the updated name. • Select from the following options to specify what to update: <ul style="list-style-type: none"> • Rename user name • Rename logon name • Rename user and logon name

Action	Description
Set user property	<p>Enables you to assign a value to a user property, view the current details, and update it.</p> <ul style="list-style-type: none"> • Enter the same session name as the one you used in the Connect action. • Select whether to search for the user by User name or Logon name. • Enter the property to update. • Enter the new value.
Update account options	<p>Sets account attributes for the user.</p> <ul style="list-style-type: none"> • Specify the user name. You can select Credential to use a value from the Credential Vault, Variable to use a credential variable, or Insecure string to manually enter a user name. • Select the status of the user as Active or Inactive. • Select an option indicating whether the user can change their password at the next login or not. <p>If you choose the Don't require password change at next login option, you have additional options to select.</p> <ul style="list-style-type: none"> • User can't change password • Password doesn't expire <ul style="list-style-type: none"> • Enter the same session name in the Active Directory session that you used in the Connect action.
Update user details	See Using the Update user details action

Using the Create user action

Use the **Create user** action to configure and activate a new user.

Connect to the Active Directory server.

Using Connect action for Active Directory

1. In the **Actions** palette, double-click or drag the **Create user** action from the **Active Directory** package.
2. In the **Session name** field, enter the session name that you provided in the **Connect** action.
3. Enter a user name.
For example, John Smith.
4. Enter the logon name.
The user will use this value to log in to the account.
For example, john.smith.
5. Enter the user's first name.
6. Optional: Enter these user details: last name, display name, initials, email address, description, department, and title.
7. Select **Active user** to activate the user.
8. Select the **Password settings** check box to set the password for the user.
9. Enter the password.
You can select **Credential** to use a value from the Credential Vault, **Variable** to use a credential variable, or **Insecure string** to manually enter a password.

10. Select the option that enables the user to either change or not change their password at the next login.

If you choose the **Don't require password change at next login** option, you have additional options to select.

- **User can't change password**
- **Password doesn't expire**

11. Click **Save**.

Using the Add users to group action

Use the **Add user to group** action to add an existing user to a user-created group.

Ensure there is an existing user and group.

User account operations | Group operations

- 1.** In the **Actions** palette, double-click or drag the **Add users to group** action from the **Active Directory** package.
- 2.** From the **Select user** field, select one of the following options:
 - **Add user manually:** Enter the **Name** and **Ldap path** of the user in the **Add user** window and click **Add**.
 - **Add users from server:** Add an existing user from the server:
 - a.** Enter the host and domain credentials in the **Connect to server** window and click **Connect**.
 - b.** In the **Select user** window, select the user from the **Objects** panel and click **Add user**.

The user name and LDAP path of the user is added in the **Select user** table.

- 3.** Add the user to the specified group by choosing one of the following options:
 - **Group name:** Enter the group name to add the existing user to a specific group.
 - **Select user group:** Add an existing user to a group:
 - a.** Enter the host and domain credentials in the **Connect to server** window and click **Connect**.
 - b.** In the **Select user** window, select the group from the **Objects** panel to add user to the destination group and click **Apply**.
- 4.** Enter the same session name in the **Active Directory session** that you used in the **Connect** action.
- 5.** Click **Save** and **Apply**.

Using the Remove users from group action

Use the Remove users from group action to remove a user from a group.

Ensure there is an existing user assigned to a group.

Using the Add users to group action

- 1.** In the **Actions** palette, double-click or drag the **Remove users from group** action from the **Active Directory** package.

2. From the **Select user** field, select one of the following options:
 - **Add user manually:** Enter the **Name** and **Ldap path** of the user in the **Add user** window and click **Add**.
 - **Add users from server:** Add an existing user from the server:
 - a. Enter the host and domain credentials in the **Connect to server** window and click **Connect**.
 - b. In the **Select user** window, select the user from the **Objects** panel and click **Add user**.

The user name and LDAP path of the user is added in the **Select user** table.

3. To remove the user from a group, select one of the following options:
 - **Group name:** Enter the group name to remove the existing user from a group.
 - **Select user group:** Remove an existing user from a group.
 - a. Enter the host and domain credentials in the **Connect to server** window and click **Connect**.
 - b. In the **Select user** window, select the group from the **Objects** panel to remove user from the group and click **Apply**.
4. Enter the same session name in the **Active Directory session** as you used in the **Connect** action.
5. Click **Save** and **Apply**

Using the Update user details action

Use this action to update the details of a user.

Connect to the Active Directory server.

Using Connect action for Active Directory

1. In the **Actions** palette, double-click or drag the **Update user details** action from the **Active Directory** package.
2. In the **Session name** field, enter the session name that you provided in the **Connect** action.
3. Select whether to search for the user by **User name** or **Logon name**.
4. Enter the user's first name.
5. Optional: Enter the following user details: last name, display name, initials, email address, description, department, and title.
6. Click **Save**.

Analyze package

Use the actions in the **Analyze** package to specify the actions and variables to use in the Bot Insight dashboard and widgets. The **Analyze** package enables you to perform transactional analytics for the data that is logged by the variables when the bot runs.

Note: The proxy configuration with authentication is currently not supported.

Actions in the **Analyze** package

The **Analyze** package includes the following actions:

Action	Description
Close	<p>Closes a transaction.</p> <ul style="list-style-type: none"> In the Transaction name field, enter the transaction name that you provided in the Open action. In Dictionary variable, select the following options: <ul style="list-style-type: none"> All user-defined variables: Include all the user-defined string, numeric, and datetime variables from the bot to populate the Bot Insight dashboards. Manually select the variables to include in the Bot Insight dashboards.
Open	<p>Opens a transaction. Insert the actions that you want to include for analysis between the Open and Close actions. In the Transaction name field, enter a transaction name.</p>

Using the **Open** and **Close** actions with the **Loop** package

- If you want to capture all the data within the loop in the Bot Insight dashboard, use the **Open** and **Close** actions inside the loop.

Example: If you are using the **For each row in CSV/TXT** iterator in the **Loop** action to read values from each row in a Microsoft Excel sheet, use the **Open** and **Close** actions inside this loop to analyze and capture the data of each row in the Bot Insight dashboard.

- If you want to capture only the last interpreted data of the loop in the Bot Insight dashboard, use the **Open** and **Close** actions outside the loop.

Example: If you are using the **For each row in CSV/TXT** iterator in the **Loop** action to read values from each row in a Microsoft Excel sheet, use the **Open** and **Close** actions outside this loop to capture only the data in the last row of the Excel sheet in the Bot Insight dashboard.

Using the **Open** and **Close** actions with the **Error handler** and **If** packages

- If you want to analyze and capture error messages during bot execution in the Bot Insight dashboard, use the **Open** and **Close** actions with an **Error handler** package.

Example:

- Create a bot with multiple **If** actions within a loop.
- To capture errors, within every **If** action, add an **Error Handler > Catch** action.
- Inside the loop, after every **If** action, add the **Analyze > Close** action to capture the errors inside every **If** condition on the Bot Insight dashboard for analysis.

Example task: See the following topic for an example of building a bot to retrieve data from a website to create visualizations in Bot Insight: [Build a Bot Insight dashboard bot](#). The example includes using the **Open** and **Close** actions inside a loop when using the **For each row in CSV/TXT** iterator in the **Loop** action.

Apigee action package

With Apigee package you can connect to an Apigee instance to run integration and collaborate efficiently to function as one unit.

Note: The Apigee package is only available via the Bot Store ([Apigee Command Package](#)) and is not yet generally available in Automation 360. This package is currently undergoing final testing, after which it is anticipated to be generally released as part of Automation 360.

Apigee Integration offers business organizations of all sizes the tools needed to connect and manage the multitude of software applications required to support business operations in a digital world. With Apigee Integration's out-of-the-box triggers, configurable tasks, and friendly user interface, you can create enterprise-level integrations with ease. All the Automation 360 can configured to an API trigger to invoke executions for Apigee integrations.

The sections describes you how to use Automation 360 to run integrations in Apigee. The following actions are used to connect to an Apigee instance and execute integrations:

Apigee Connect

With Apigee Connect action you can enter all the credentials to connect to a Google Cloud Platform (GCP) instance. The GCP manages access to the Apigee instance.

Create a GCP account ([GCP Cloud](#)) and create a GCloud project. Login to your GCloud account at GCloud account at [Google Cloud Project](#) and create a project. If you already have access to a project, you will see your project here. Create an OAuth 2.0 Client IDs. A client ID is used to identify a single app to Google's OAuth Servers. For more information on creating an OAuth 2.0 Client IDs, see [Apigee Connect](#).

In this topic you will learn how to use the Apigee Connect action to connect to an Apigee instance from Automation 360.

1. Open the [Google Cloud console](#).
2. At the top-left, click Menu **APIs & Services** > **Credentials**.
3. Click on an application under OAuth 2.0 Client IDs that you want to connect.

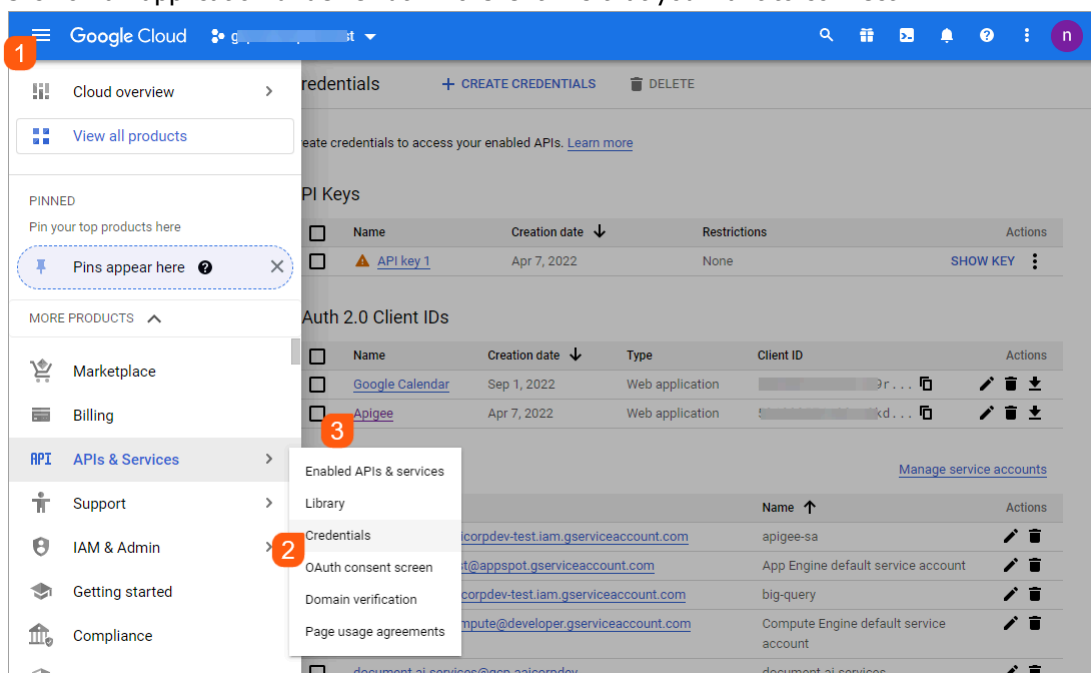

4. Copy the **Client ID**, **Client secret**, and **URI**.
5. Create a new .

- a) Log in to your instance of the .
- b) On the left panel, click **Automation**.
- c) Click **Create new > Bot**.
- d) In the **Create Task Bot** window, enter the name.
- e) Accept the default folder location: `\Bots\`
To change the default storage location, click **Choose** and follow the prompts.
- f) Click **Create and edit**.

6. From the Actions pane, select **Apigee > Connect** and place it under the **Start** of the bot flow.

Option	Steps
User Email Address/Client ID/Client secret/Redirect URI	Select one of the following options to specify the User Email Address/Client ID/Client secret/Redirect URI : <ul style="list-style-type: none"> • Credential: Enables you to use a value available in the Credential Vault that contains information about the User Email Address/Client ID/Client secret/Redirect URI. • Variable: Enables you to use a credential variable that contains information about the User Email Address/Client ID/Client secret/Redirect URI.. • Insecure string: Enables you to enter the User Email Address/Client ID/Client secret/Redirect URI.

- a) In the **User Email Address** provide the email address used to login to the GCloud account.
- b) In the **Client ID** field, paste the **Client ID** copied from the GCloud. In this illustration **Insecure string** is used, while you can use **Credential** or **Variable** options for better security.
- c) In the **Client Secret** field, paste the **Client Secret** copied from the GCloud.

Google Cloud

Search Products, resources, docs (/)

API APIs & Services

Client ID for Web application

DOWNLOAD JSON RESET SECRET DELETE

Enabled APIs & services

Library

Credentials

OAuth consent screen

Domain verification

Page usage agreements

Name *

Apigee

The name of your OAuth 2.0 client. This name is only used to identify the client in the console and will not be shown to end users.

Client ID 52499357

Client secret GOC

Creation date April 7, 2022 at 3:44:27 PM GMT-5

The domains of the URIs you add below will be automatically added to your [OAuth consent screen](#) as [authorized domains](#).

Authorized JavaScript origins

For use with requests from a browser

+ ADD URI

Authorized redirect URIs

For use with requests from a web server

URIs 1 *

http://localhost:8888/Callback

URIs 2 *

https://www.getpostman.com/oauth2/callback

URIs 3 *

https://oauth.pstmn.io/v1/callback

- d) In the **Redirect URI** provide an redirect URI from the GCloud account.
- e) Enter **Default** as the Session name.

Apigee Execute Integration

You can configure and execute an integration in Apigee using the Apigee Execute Integration action.

Create a GCP account ([GCP Cloud](#)) and create a GCloud project. Log in to your GCloud account at [Google Cloud Project](#) and create a project. If you already have access to a project, you will see your project here. Create an OAuth 2.0 client ID. A client ID is used to identify a single app to Google's OAuth servers. For more information about creating an OAuth 2.0 client IDs, see [Create OAuth 2.0 credentials](#).

Use the Apigee Execute action to execute an integration in an Apigee instance from Automation 360.

1. Open the *Google Cloud console*.
2. At the top-left corner, click **Menu > APIs & Services > Credentials**.
3. Select the application under OAuth 2.0 client IDs that you want to connect.

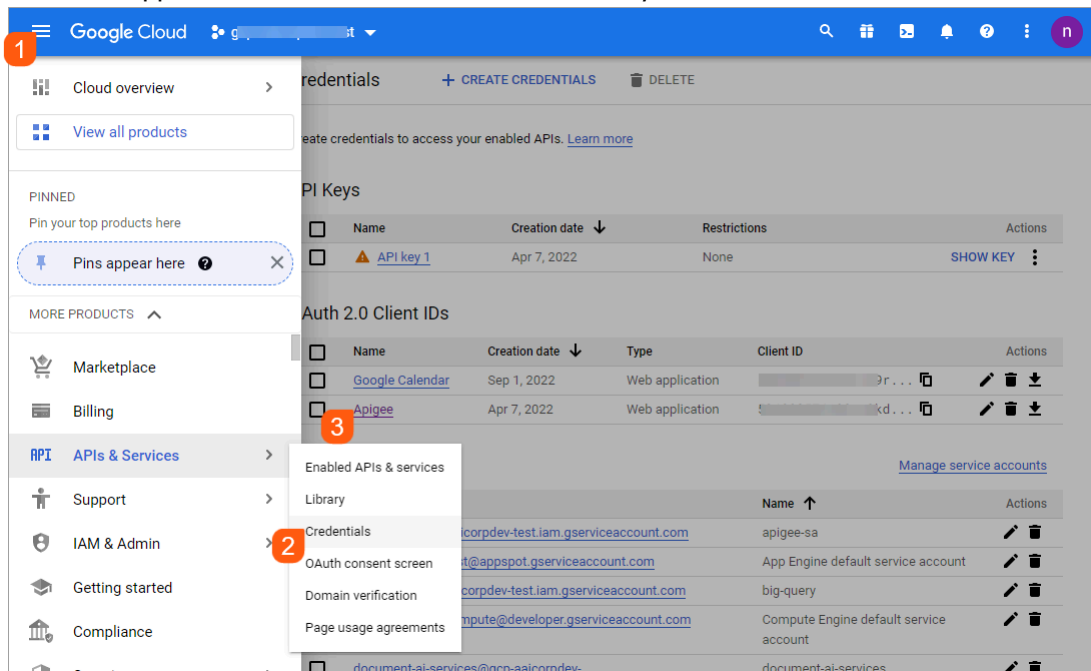

4. Copy the **Client ID**, **Client secret**, and **URI**.
5. Log in to the Control Room.
6. Create a new .
 - a) Log in to your instance of the .
 - b) On the left panel, click **Automation**.
 - c) Click **Create new > Bot**.
 - d) In the **Create Task Bot** window, enter the name.
 - e) Accept the default folder location: `\Bots\`
To change the default storage location, click **Choose** and follow the prompts.
 - f) Click **Create and edit**.
7. From the **Actions** pane, select **Apigee > Execute integration** and place it under the **Start** of the bot flow.

8. Click **Discover integrations to configure**. **Step 1/4: Connect to Apigee X** appears. Enter the following:

Option	Steps
User Email Address/Client ID/Client secret/Redirect URI	Select one of the following options to specify the User Email Address/Client ID/Client secret/Redirect URI : <ul style="list-style-type: none"> • Credential: Enables you to use a value available in the Credential Vault that contains information about the User Email Address/Client ID/Client secret/Redirect URI. • Variable: Enables you to use a credential variable that contains information about the User Email Address/Client ID/Client secret/Redirect URI.. • Insecure string: Enables you to enter the User Email Address/Client ID/Client secret/Redirect URI.

- a) In **User Email Address**, provide the email address used to log in to the GCloud account.
- b) In the **Client ID** field, paste the **Client ID** copied from GCloud. In this illustration, **Insecure string** is used, while you can use **Credential** or **Variable** options for better security.
- c) In the **Client Secret** field, paste the **Client Secret** copied from GCloud.

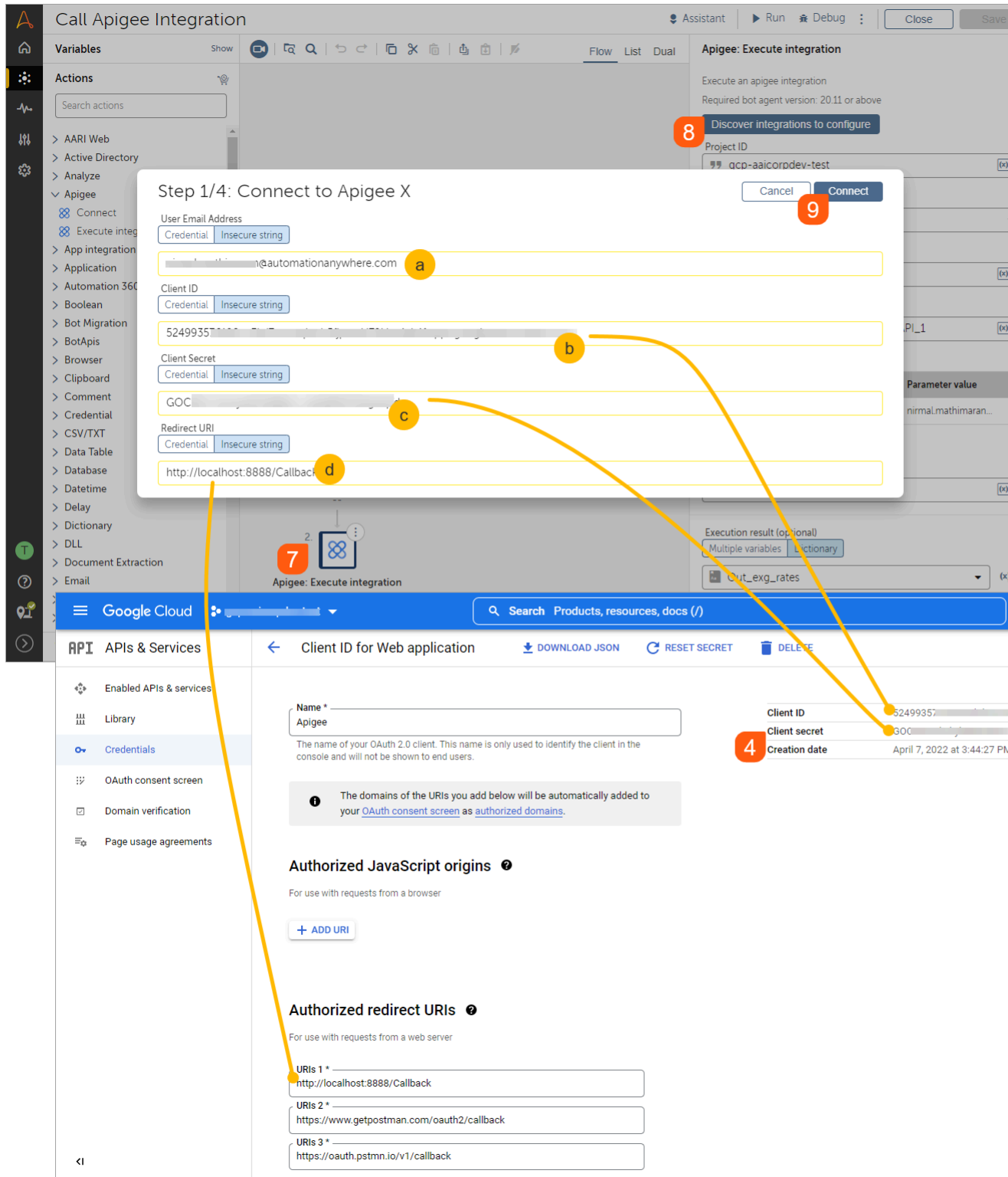

d) In **Redirect URI**, provide a redirect URI from the GCloud account.

9. Click Connect.

If the credentials are correct, it gets connected to GCloud and the **Step 2/4: Load Integration** screen appears.

10. Select the following in the **Step 2/4: Load Integrations** screen.

- a) Click the **Project ID** drop-down and select the project ID from where you want to load the integration.
- b) Click the **Location** drop-down and select the location from where you want to load the integration.

Step 2/4: Load Integrations

Project ID
gcp... **a**

Location
us-central1 **b**

11. Click **Next**.

Step 3/4: Select an Integration screen appears with all the available integrations.

12. Select an integration from the list.

Step 3/4: Select an Integration

Select an Integration

Name	Description	Location	Active	Update Time
aaa-apigee-discovery	Launch a bot for Mone...	us-central1	true	2022-09-06T15:34:27...
aaa-launch-sfdc-bot	Launch a bot on Autom...	us-central1	true	2022-09-02T17:58:31...

13. Click **Next**.

Step 4/4: Configure my Integration screen appears with all the configuration options.

14. In the **Step 4/4: Configure my Integration** screen, click the **API Trigger** drop-down and select the trigger you want to invoke.

Step 4/4: Configure my Integration

API Trigger
api_trigger/aaa-apigee-discovery_API_1

Input parameters (optional)

Name	Type	Value
in_email_address	String	

The input parameters are the parameters retrieved from Apigee.

15. Click **Done**.

All the selected options are displayed as parameters in the **Apigee: Execute integration** action.

16. Enter **Default** as the session name.

Apigee: Execute integration

Execute an apigee integration
Required bot agent version: 20.11 or above

[Discover integrations to configure](#)

Project ID
gcp-aaicorpdev-test

Location
us-central1

Name of the integration you want to execute
aaa-apigee-discovery

Trigger ID
api_trigger/aaa-apigee-discovery_API_1

Input parameters (1) (optional)

Parameter name	Parameter type	Parameter value
in_email_address	String	--

Session
Default

Execution result (optional)
Multiple variables | Dictionary

Out_exg_rates

17. To verify the response from the Apigee integration, you can store the response to a variable. For example: *Out_exg_rates*

App Integration package

Extract text from a window and save it to a string variable by using the actions in the App Integration package.

The App Integration package supports the following technologies:

- UNIX shells, such as Cygwin, PowerShell, and GIT shell
- Windows applications, such as Calculator, Command Prompt, and Notepad
- Java applications that are based on the Standard Widget Toolkit and Abstract Window Toolkit, which can draw text using Windows text-drawing APIs

The actions in the App Integration package are based on legacy technology and have certain limitations on specific applications. To seamlessly obtain data from applications and browsers, use the [Recorder package](#).

Building bots with actions from the App Integration package

1. Open the application or file from which you want to capture the text using the **Application > Open program/file** action.

[Application package](#)

2. Extract the text using one of the actions from the App Integration package.

3. Use any of the following actions from the String package to manipulate the captured text:
- **Extract text:** Extracts text from the source string using logical operators.
 - **Split:** Splits the string into multiple strings and stores the output in a list variable.
 - **Trim:** Trims blanks and white spaces from a string.

String package

Actions in the App Integration package

The **App Integration** package includes the following actions:

Action	Description
Capture area	<p>Extracts text from within the captured area of a window and saves it to a string variable.</p> <ul style="list-style-type: none"> In the Window field, select an option: Choose from the Application, Browser, or Variable tab. <ul style="list-style-type: none"> Application: Select from a list of windows, including browser windows, that are currently open on the Bot Creator device. Browser: Select from a list of supported browser tabs. <hr/> <p>Note: This option supports , Chromium-based , and browsers.</p> <hr/> Variable: Select an existing window variable to specify the title of the application window title. <ul style="list-style-type: none"> Insert a wildcard character (*) in the Window title field to search for window titles that can change. <p>You can use a regular expression (regex) to identify a window title. Select the regular expression condition as either String or a Pattern and then enter the value. By default, the Window title field is case-sensitive.</p> <p>To identify a browser title, you can enable the Case sensitive option to match the letter case, or disable the option to identify a window title where the letter case does not match.</p> <hr/> <p>Note: Ensure that the minimum version installed on your system is the version that was released with v.26. If you have a version released with v.25 or earlier, then by default, the window title will be identified only with matching letter case (case-sensitive).</p> <hr/> <p>For example, you can enter the String value as <code>((\w*)-Notepad</code> for all window title names starting with <code>((\w*)-Notepad</code>, or use Pattern value as <code>((\w)\s)*document-Notepad</code> for only those window titles that match this pattern.</p> <hr/> <p>Note:</p> <ul style="list-style-type: none"> When you use a regular expression of type String with <code>-title</code> as the input value for a window title in any , the might encounter a run time error. To prevent the run time error, ensure that when you add the string input as <code>*-title</code>, the application with the specific title is open. The asterisk (*) is just a character, not a wild card character. When you use a regular expression of type Pattern with <code>-title</code> as the input value for a window title in any , the might encounter a run time error because the input value <code>*-title</code> is incorrect. <p>Ensure that you use valid regex patterns.</p> <hr/> Optional: Select the Resize window option to specify the window dimensions. <p>This option delivers a more reliable bot. It resizes the window to the dimensions at which the task was recorded, which enhances the bot's ability to identify the target object.</p> Click Capture region and select the area to capture. In the Save captured text to a variable field, select a string variable.

Action	Description
Capture scrollable text	<p>Captures scrollable text from the specified window.</p> <ul style="list-style-type: none"> In the Window field, select an option: Choose from the Application, Browser, or Variable tab. <ul style="list-style-type: none"> Application: Select from a list of windows, including browser windows, that are currently open on the Bot Creator device. Browser: Select from a list of supported browser tabs. <hr/> <p>Note: This option supports , Chromium-based , and browsers.</p> Variable: Select an existing window variable to specify the title of the application window title. <ul style="list-style-type: none"> Insert a wildcard character (*) in the Window title field to search for window titles that can change. <p>You can use a regular expression (regex) to identify a window title. Select the regular expression condition as either String or a Pattern and then enter the value. By default, the Window title field is case-sensitive.</p> <p>To identify a browser title, you can enable the Case sensitive option to match the letter case, or disable the option to identify a window title where the letter case does not match.</p> <hr/> <p>Note: Ensure that the minimum version installed on your system is the version that was released with v.26. If you have a version released with v.25 or earlier, then by default, the window title will be identified only with matching letter case (case-sensitive).</p> <hr/> <p>For example, you can enter the String value as <code>((\w*)-Notepad</code> for all window title names starting with <code>((\w*)-Notepad</code>, or use Pattern value as <code>((\w)\s)*document-Notepad</code> for only those window titles that match this pattern.</p> <hr/> <p>Note:</p> <ul style="list-style-type: none"> When you use a regular expression of type String with <code>-title</code> as the input value for a window title in any , the might encounter a run time error. To prevent the run time error, ensure that when you add the string input as <code>*-title</code>, the application with the specific title is open. The asterisk (*) is just a character, not a wild card character. When you use a regular expression of type Pattern with <code>-title</code> as the input value for a window title in any , the might encounter a run time error because the input value <code>*-title</code> is incorrect. <p>Ensure that you use valid regex patterns.</p> <hr/> <ul style="list-style-type: none"> Optional: Select the Resize window option to specify the window dimensions. <p>This option delivers a more reliable bot. It resizes the window to the dimensions at which the task was recorded, which enhances the bot's ability to identify the target object.</p> <ul style="list-style-type: none"> Click Capture coordinate to capture the coordinates of the window or a specific control within the window. In the Save captured text to a variable field, select a string variable.

Action	Description
Capture text of window	<p>Extracts all the text from a window and saves it to a string variable.</p> <ul style="list-style-type: none"> In the Window field, select an option: Choose from the Application, Browser, or Variable tab. Application: Select from a list of windows, including browser windows, that are currently open on the Bot Creator device. Browser: Select from a list of supported browser tabs. <hr/> <p>Note: This option supports , Chromium-based , and browsers.</p> <hr/> <ul style="list-style-type: none"> Variable: Select an existing window variable to specify the title of the application window title. Optional: Select the Resize window option to specify the window dimensions. This option delivers a more reliable bot. It resizes the window to the dimensions at which the task was recorded, which enhances the bot's ability to identify the target object. In the Save captured text to a variable field, select a string variable.

Related reference

[Screen resolution dependent packages](#)

The screen resolution between the Bot Runner and Bot Creator device should be consistent as when resolution-dependent packages are used to build bots, any screen resolution difference between the Bot Creator and Bot Runner device will impact the bots during runtime.

Application package

Use the **Open Program/File** action in the **Application** package to launch an application or a file. This action supports .exe, .bat, script files, or shortcut paths.

Actions in the Application package

The **Application** package includes the following action:

Action	Description
Open program/file	See Open program/file action .

Open program/file action

The Open Program/File action in the Application enables you to launch an application or a file.

Settings

Opens an application or file.

- Enter the name of the application or file, or insert a variable. For example, `chrome.exe`.

Note: You can also enter the full file path in this field.

- **Optional:** Enter the location of the file that you want to use to open the application in the **Start in path** field.

For example, C:\Program Files (x86)\Google\Chrome\Application\

- **Optional:** In the **Parameters** field, specify the parameters or arguments you want to pass to the program.

For example, if you are using the command line, enter the arguments in this field.

Note: When you enter a file path in the **Location of the program/file** field or **Start in path** field wherein the file path is separated by the \ character and save the bot, the \ character is changed to / as the bot uses / to separate file paths. Your bots continue to run successfully even if the \ is changed to / during bot execution.

AWS Comprehend NLP package

The **AWS Comprehend NLP** package contains actions that enable you to connect to and consume the Amazon Comprehend API to identify the language, sentiment, key phrases, and entities.

Important: This is a beta package and is currently not available with the Automation 360 Enterprise and Cloud editions.

Before you start

You require the following information for an existing AWS account to use these actions:

- **Access key** and **Secret key:** Credentials that authenticate Automation 360 with your AWS account.
See [Access Keys \(Access Key ID and Secret Access Key\)](#).
- **Region:** Specifies the AWS service endpoint.
See [AWS Service Endpoints](#).

Actions in the AWS Comprehend NLP package

Action	Description
Detect language	Identifies the language of the provided content and returns it in ISO 639-1 language code. The output is stored in a string variable. This action supports over 100 languages. For the full list, see Detect the Dominant Language .
Get key phrases	Identifies the main points and returns a list of key phrases. For example, if the input text is about a basketball game, this action returns the names of teams, the name of the venue, and the final score.
Get named entities	Identifies the entities in the provided content such as people, places, organizations, date/time, quantities, branded products, and book titles. The output is stored in a dictionary variable, where each name is a key, and the corresponding entity is the value.

Action	Description
Get sentiment	<p>Analyzes the provided content and returns the overall sentiment and scores for all possible sentiments. An example output of the dictionary values:</p> <pre>POSITIVE {Positive: 0.66238534,Negative: 0.0013064129,Neutral: 0.33621928,Mixed: 8.892125E-5}</pre> <p>The output is stored in a dictionary variable containing two keys and their corresponding values: <code>sentiment</code> and <code>score</code>.</p>

Boomi action package

Boomi Atomsphere is a leading industry on-demand integration service available as a platform-as-a-service (iPaaS) offering. With the Boomi actions package, you can start a session in Boomi from Automation 360 and perform general tasks in Boomi.

Note: The Boomi package is only available via the Bot Store and is not yet generally available in Automation 360. This package is currently undergoing final testing, after which it is anticipated to be generally released as part of Automation 360.

Without extensive training or specialized technical skills, you can build integration flows in Boomi using drag-and-drop. A multitude of connectors to external systems are available out of the box. It simplifies typical integration functions such as transforming between various data formats (EDI, CSV, XML, JSON, and so on) and handling different transport mechanisms (file, FTP, HTTP, and so on). The Boomi action package uses the Boomi APIs to integrate Automation 360 with Boomi.

To perform any action in Boomi using Automation 360,RPA developers need to establish a session with Boomi. After you establish a session is established, you can execute a process from the Automation 360. Additionally, you can list the Atoms and Processes.

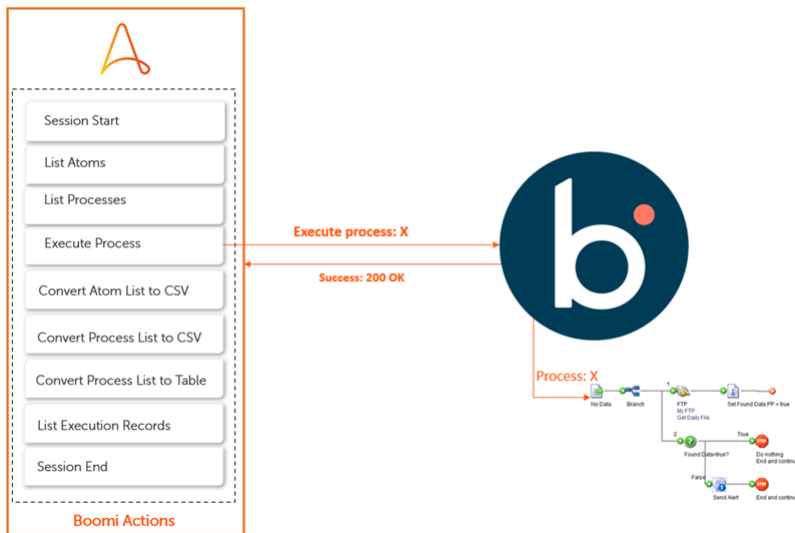

Boomi Session Start action

With the **Boomi Session Start** action, you can connect to a particular Boomi instance using a valid Account ID to begin a session.

Make sure you have an account to log in to the **Boomi AtomSphere Platform**. If you are new to Boomi, go to the Boomi website at [Boomi Platform](#) and click the **Free Trial** link on the banner at the top of the page.

1. Log in to the **Boomi AtomSphere Platform** ([Boomi Platform](#)).
2. Navigate to **Settings > Account Information and Setup**.

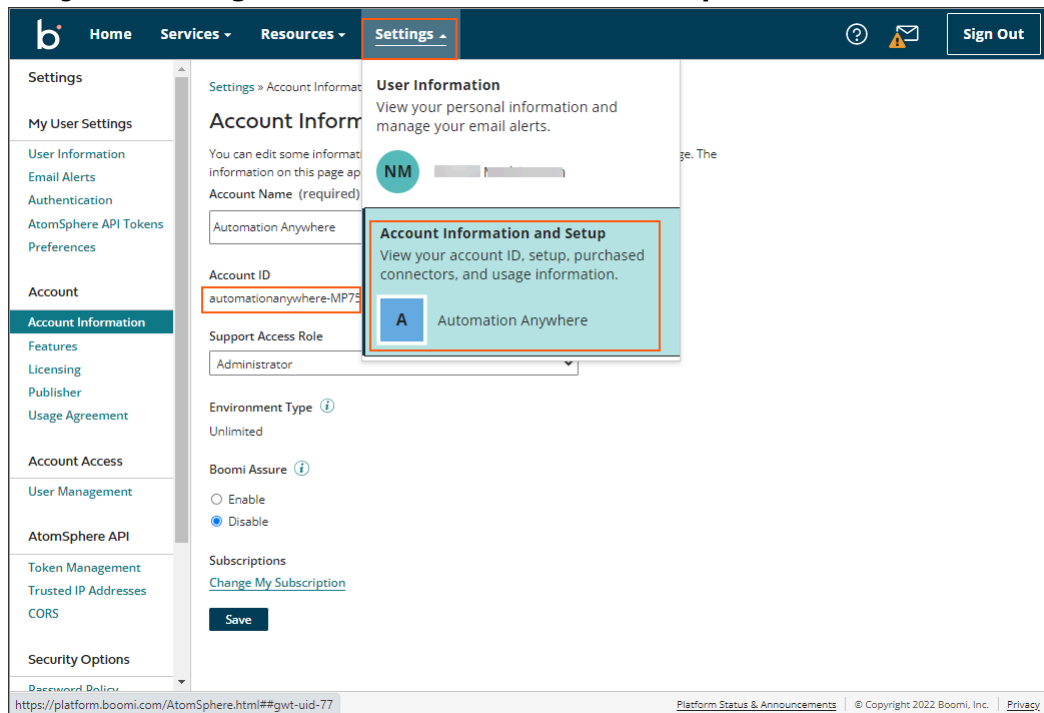

You will notice the **Account ID**.

3. Copy the **Account ID**.
4. Log in to the Automation 360 Control Room.
5. Create a new .
 - a) Log in to your instance of the .
 - b) On the left panel, click **Automation**.
 - c) Click **Create new > Bot**.
 - d) In the **Create Task Bot** window, enter the name.
 - e) Accept the default folder location: `\Bots\`
To change the default storage location, click **Choose** and follow the prompts.
 - f) Click **Create and edit**.

6. From the Actions pane, select **Boomi > Session Start** and place it under the **Start** of the bot flow.

Boomi information	Option
<p>Boomi Account ID/Boomi Login/ Boomi password</p>	<p>Select one of the following options to specify the Boomi Account ID/Boomi Login/Boomi password:</p> <ul style="list-style-type: none"> • Credential: Enables you to use a value available in the Credential Vault that contains information about the Boomi Account ID/ Boomi Login/Boomi password. • Variable: Enables you to use a credential variable that contains information about the Boomi Account ID/Boomi Login/Boomi password. • Insecure string: Enables you to enter the Boomi Account ID/Boomi Login/Boomi password for the Boomi Session Start.

- In the **Boomi Account ID** field, paste the **Account ID** copied from the Boomi Atomsphere Platform.
- In the **Boomi Login** field, enter the Email Address used to log in to the Boomi Atomsphere Platform.
- In the **Boomi Password** field, enter the Password used to log in to the Boomi Atomsphere Platform.

The following example shows how **Insecure string** is used for the Session Start information. For better security, you can use either the **Credential** or **Variable** options.

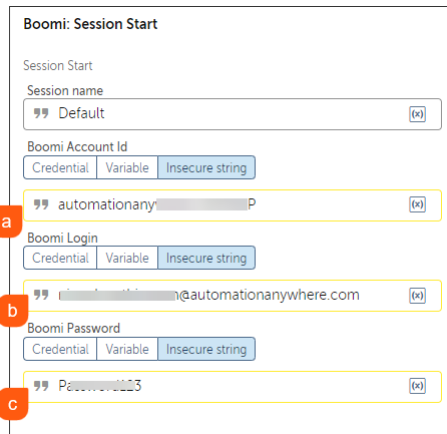

Boomi List Atoms action

With the **Boomi List Atoms** action, you can list all the Atoms associated with a Boomi instance.

Note: Ensure that you have started a Boomi session before initiating any Boomi action. For more details, see [Boomi Session Start action](#).

An *Atom* is a single tenant runtime engine and cannot be used by multiple accounts. It is a light-weight Java application that runs on a single node only and does not provide high availability. The following procedure describes how to list all the Atoms of a Boomi instance:

- From the **Actions** pane, select **Boomi > List Atoms** and place it in the canvas.

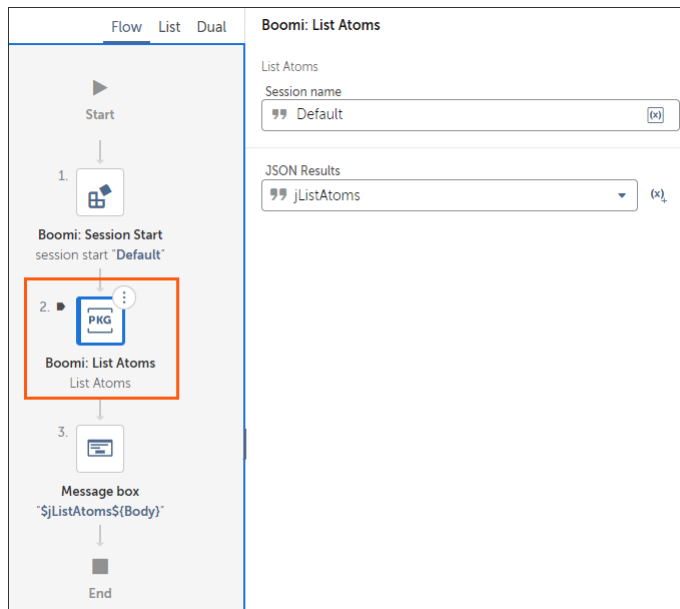

2. Make sure the **Session name** field is set to **Default**. Default uses the current session that has been established using the *Boomi Session Start* action.
3. Create a variable to store the response. In this example, the response is saved in a variable named `jListAtoms`.

You can use a message box action to view the list of Atoms. The message box displays the list of Atoms similar to the following image:

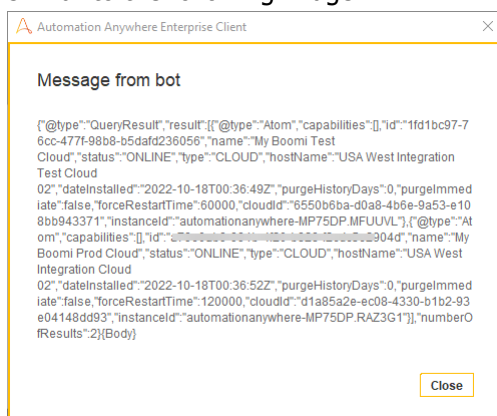

Boomi Convert Atom list to CSV action

With the **Boomi Convert Atom List to CSV** action, you can convert an Atom list associated with a Boomi instance into a CSV format.

Note: Ensure that you have started a Boomi session before initiating any Boomi action. For more details, see *Boomi Session Start* action.

The following procedure describes how to convert an Atom list to CSV in a Boomi instance:

1. From the **Actions** pane, select **Boomi > Convert Atom List to CSV** and place it in the canvas.

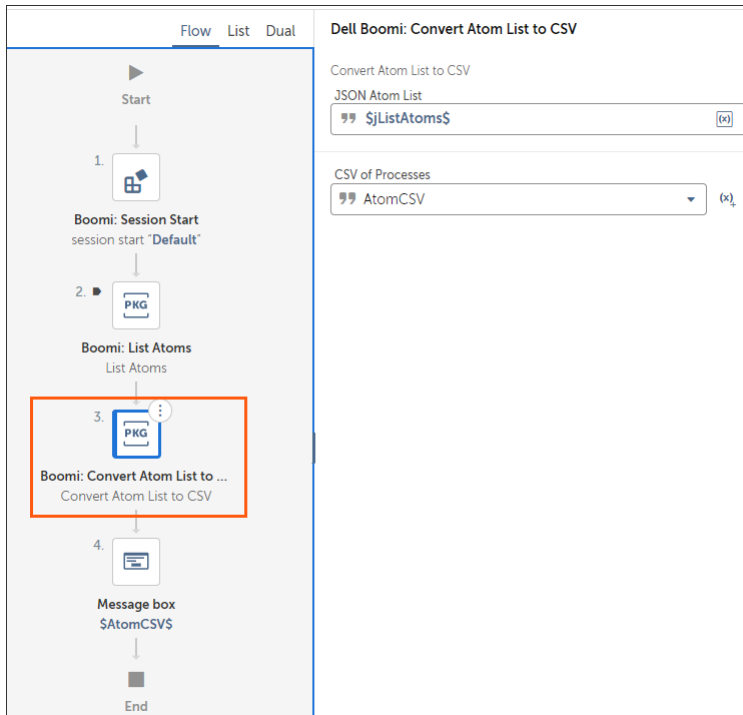

2. Enter a JSON Atom List stored in a variable. For more information on storing a JSON Atom List, see [Boomi List Atoms action](#).
3. Create a variable to store the response. In this example, the response is saved in a variable named `AtomCSV`.

You can use a message box action, to view the CSV. The message box displays the list of Atoms converted into a CSV similar to the following image:

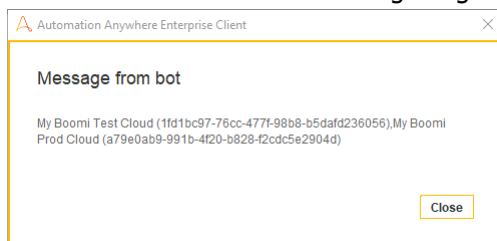

Boomi List Processes action

With the **Boomi List Processes** action, you can list all the Processes associated with a Boomi instance. The process is the central component in Boomi Integration.

Note: Ensure that you have started a Boomi session before initiating any Boomi action. For more details, see [Boomi Session Start action](#).

A *process* is a graphical representation of the path that a document takes from the point at which it is received or retrieved to the point at which it is sent to one or more destinations. Processes in Boomi are depicted with a left-to-right series of shapes and connected together similar to a flow chart. It illustrates the steps required to transform, route, or manipulate the data from the source to the destination. Processes use connectors to retrieve and send data. Processes are deployed to the atom (a dynamic runtime engine). Once processes have been deployed, the atom contains all the components required to execute the integration processes from start to finish including:

- Connectors
- Transformation rules
- Decision handling
- Processing logic

The following procedure describes how to list all the Processes of a Boomi instance:

1. From the **Actions** pane, select **Boomi > List Processes** and place it in the canvas.

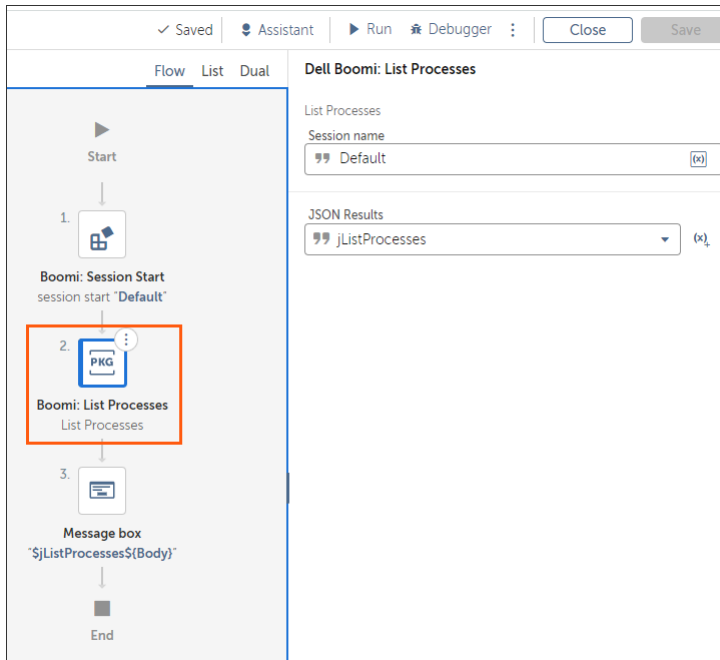

2. Make sure the **Session name** field is set to **Default**. Default uses the current session that has been established using the *Boomi Session Start action*.
3. Create a variable to store the response. In this example, the response is saved in a variable named `jListProcesses`.

You can use a message box action, to view the list of Processes. The message box displays the list of Processes similar to the following image:

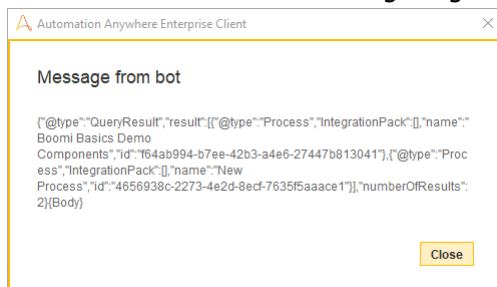

Boomi Convert Process List to CSV action

With the **Boomi Convert Process List to CSV** action, you can convert a Process list associated with a Boomi instance into a CSV format.

Note: Ensure that you have started a Boomi session before initiating any Boomi action. For more details, see *Boomi Session Start action*.

The following procedure describes how to convert a Process list to CSV in a Boomi instance:

1. From the **Actions** pane, select **Boomi > Convert Process List to CSV** and place it in the canvas.

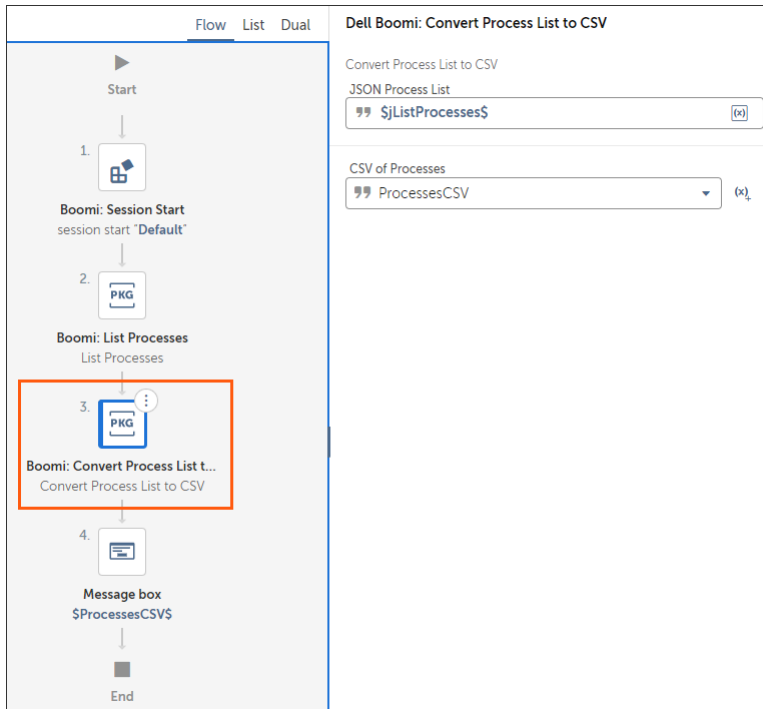

2. Enter a JSON Process List stored in a variable. For more information on storing a JSON Processes List, see [Boomi List Processes action](#).
3. Create a variable to store the response. In this example, the response is saved in a variable named `ProcessesCSV`.

You can use a message box action, to view the CSV. The message box displays the list of Processes converted into a CSV similar to the following image:

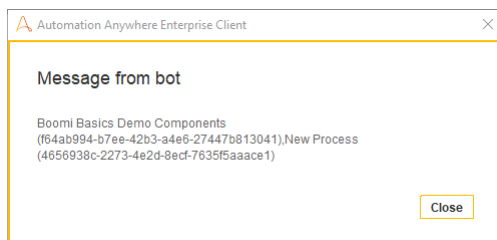

Boomi Convert Process List to Table action

With the **Boomi Convert Process List to Table** action, you can convert a Process list associated with a Boomi instance into a Table format.

Note: Ensure that you have started a Boomi session before initiating any Boomi action. For more details, see [Boomi Session Start action](#).

The following procedure describes how to convert a Process list to table in a Boomi instance:

1. From the **Actions** pane, select **Boomi > Convert Process List to Table** and place it in the canvas.

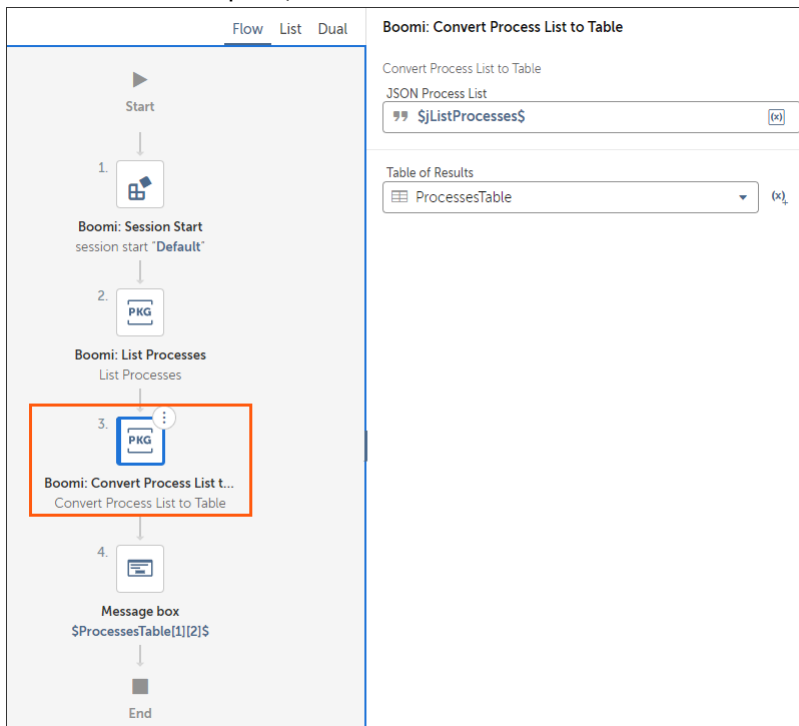

2. Enter a JSON Process List stored in a variable. For more information on storing a JSON Process List, see [Boomi List Processes action](#)
3. Create a variable to store the response. In this example, the response is saved in a variable named `ProcessesTable`.

You can use a message box action, to view the CSV. The message box displays a cell from the list of Processes converted into a Table similar to the following image:

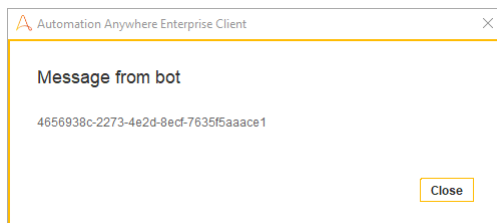

Boomi Execute Process action

With the **Boomi Execute Process** action, you can execute a process associated with a Boomi Atom.

Note: Ensure that you have started a Boomi session before initiating any Boomi action. For more details, see [Boomi Session Start action](#).

The following procedure describes how to execute a process associated to a Boomi atom:

1. From the **Actions** pane, select **Boomi > Execute Process** and place it in the canvas.

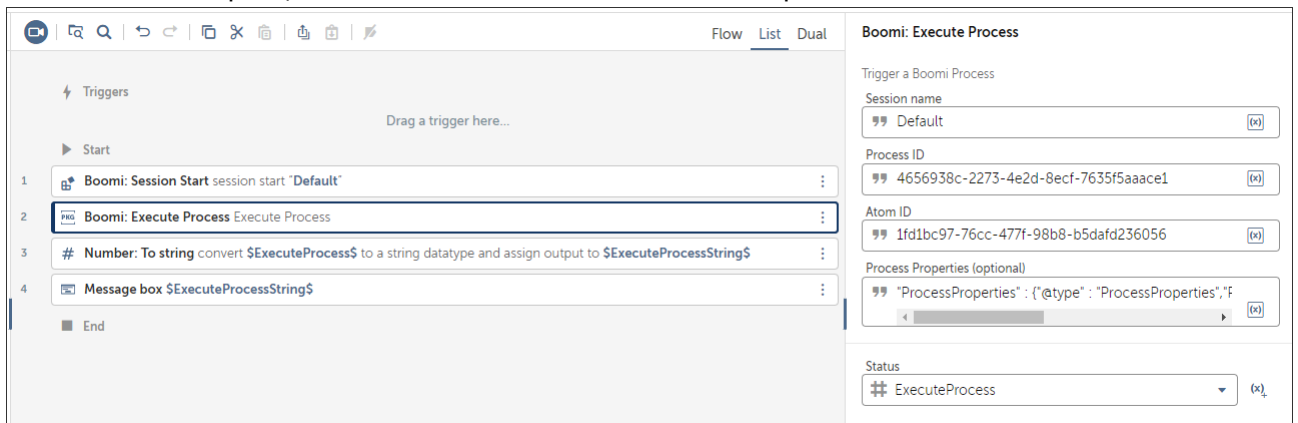

2. Make sure the **Session name** field is set to **Default**. Default uses the current session that has been established using the [Boomi Session Start action](#).
3. In the **Process ID** field, enter a process ID that you want to execute. For more information on retrieving the process ID, see [Boomi List Processes action](#).
4. In the **Atom ID** field, enter an atom ID to which the process is associated. For more details, see [Boomi List Atoms action](#).
5. In the **Process Properties field (optional)**, enter the process properties you want to edit.

You can save the response into a variable. In this example, the response is saved in a variable named `ExecuteProcess`. Use a message box to view the content of the variable. The API response is converted into a string before it is passed to the message box. The message box displays the execute process response of the similar to the following image:

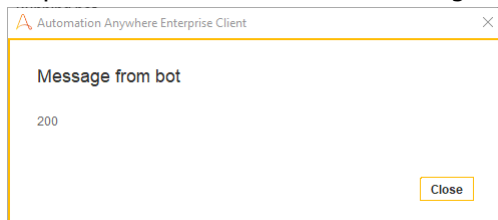

Boomi List Execution Records action

With the **Boomi List Execution Records** action, you can list all the execution records associated with a Boomi instance.

Note: Ensure that you have started a Boomi session before initiating any Boomi action. For more details, see [Boomi Session Start action](#).

The following procedure describes how to list the execution records of a Boomi instance:

1. From the **Actions** pane, select **Boomi > List Execution Records** and place it in the canvas.

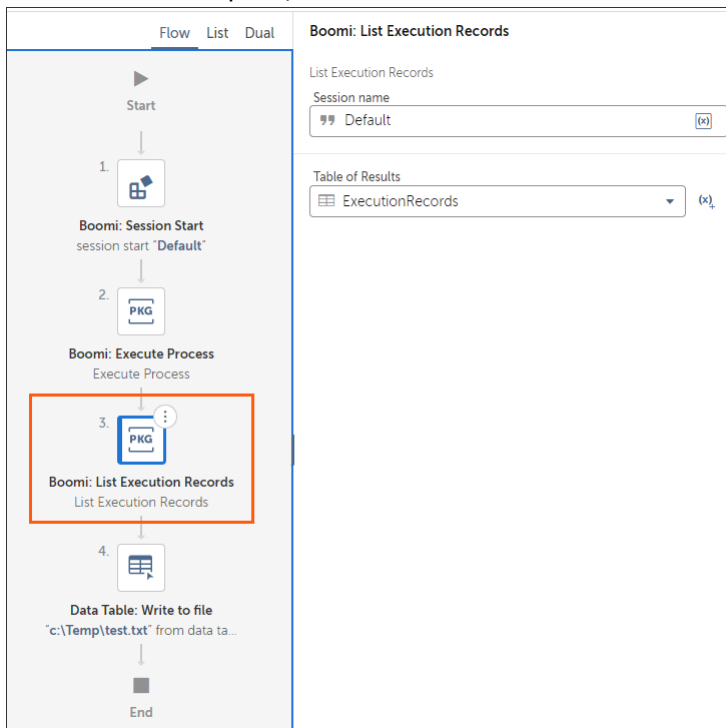

2. Make sure the **Session name** field is set to **Default**. Default uses the current session that has been established using the *Boomi Session Start action*.
3. Create a variable to store the response. In this example, the response is saved in a variable named ExecutionRecords.

You can use a **Data Table: Write to file** action, to view the execution records.

Boomi Session End

With the **Boomi Session End** action, you can end an established Boomi session.

Note: Ensure that you have started a Boomi session before initiating any Boomi action. For more details, see *Boomi Session Start action*.

The following procedure describes how to end an existing session of a Boomi instance:

1. From the Actions pane, select **Boomi > Session End** and place it at the end of the bot flow.

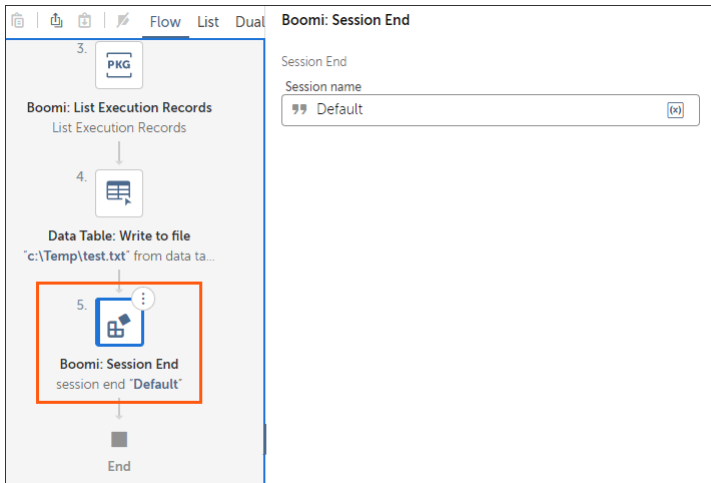

2. Make sure the **Session name** field is set to **Default**. Default uses the current session that has been established using the *Boomi Session Start* action.

Boolean package

The **Boolean** package contains actions that enable you to do various operations on Boolean values.

Actions in the Boolean package

The actions in the **Boolean** package accept a variable as an input and assign the output to a variable. These actions enable you to compare two Boolean values, convert a Boolean value to a string or numeric value, and convert a string value to a Boolean value.

The **Boolean** package includes the following actions:

Action	Description
Assign	<p>Assigns a constant value (True or False) or a user-defined value to a Boolean value.</p> <ul style="list-style-type: none"> • Select the source Boolean variable or value. • Select the variable to use to store the output from the Destination Boolean variable list. <p>The output is stored in a Boolean variable.</p>
Compare to	<p>Compares two Boolean values and assigns the output to a numeric variable.</p> <ul style="list-style-type: none"> • Select the Boolean variables to compare from the Select the first Boolean variable and Select the second Boolean variable lists. • Select the variable to use to store the output from the Assign the output to number variable list. <p>The output is stored in a number variable.</p>

Action	Description
Equal to	<p>Verifies whether the two Boolean values are equal or not, and assigns the output to a Boolean variable.</p> <ul style="list-style-type: none"> Select the variables that contain the Boolean values to verify from the Select the first Boolean variable and Select the second Boolean variable lists. Select the variable to use to store the output from the Assign the output to number variable list. <p>The output is stored in a Boolean variable.</p>
Invert	<p>Converts a Boolean value to the opposite value (True to False and False to True), and assigns the output to a variable.</p> <ul style="list-style-type: none"> Select the Boolean value to convert. Choose from False, True, or a Variable. Select the Boolean variable to use to store the converted value from the Assign the output to variable list.
To number	<p>Converts a Boolean value to a numeric value. This action converts True to 1 and False to 0.</p> <ul style="list-style-type: none"> Select the Boolean variable to convert from the Select Boolean variable list. Select the numeric variable to use to store the converted value from the Assign the output to variable list.
To string	<p>Converts a Boolean value to a string value.</p> <ul style="list-style-type: none"> Select the Boolean variable to convert from the Select Boolean variable list. Select the string variable to use to store the converted value from the Select the string variable to store the result list.

Compare results for the Compare to action

The following table illustrates how two Boolean values are compared using the **Compare to** action and their output:

Boolean value 1	Boolean value 2	Compare result
True	True	0
True	False	1
False	True	-1
False	False	0

Compare results for the Equal to action

The following table illustrates how two Boolean values are compared using the **Equal to** action and their output:

Boolean value 1	Boolean value 2	Equal result
True	True	True
True	False	False
False	True	False
False	False	True

Bot migration package

The **Bot migration** package enables you to migrate Enterprise 10 and Enterprise 11 bots to Automation 360 format. The package also enables you to convert Enterprise 10, Enterprise 11, or Automation 360 bots that use Internet Explorer to Microsoft Edge with IE mode. This package is used internally by the Bot Migration Wizard and the Update Bot wizard.

See [Supported Control Room versions for migration](#).

Important: We recommend that you use the Bot Migration Wizard to migrate Enterprise 11 or Enterprise 10 bots to Automation 360.

The **Bot migration** package does not migrate dependencies and other entities such as credential variables, **AAApplicationPath** system variable, and global values that are required to run the migrated bot.

Action in the **Bot migration** package

The **Bot migration** package includes the following action:

Action	Description
Migrate legacy bot	<p>Starting from Automation 360 v.24R2 release for IE EOL, the Migrate bot action is renamed as Migrate legacy bot.</p> <p>Migrates the Enterprise 11 and Enterprise 10 and bot file to Automation 360 format and uploads the migrated file to the specified location in your private repository with the same name as .atmx and .mbot file. This action only migrates the bot you specify, but does not migrate its dependencies. Dependencies are the bots and other files that are required to run the bot. You must migrate the dependent bots separately and upload other files manually to Control Room.</p> <p>All the bots migrated using the Bot migration package are stored in the <code>Bots</code> folder in Automation 360. If you have to migrate a parent bot and its child bots separately using the Bot migration package, you must create the same folder structure as in Enterprise 11 or Enterprise 10 and move the dependent bots to these folders for the parent bot to run successfully.</p> <ul style="list-style-type: none"> • Use the Control Room file, Desktop file, or Variable tab to specify the location of the bot you want to migrate. • In the Output folder path field, specify the location where you want to save the log files generated for the bot migration. <hr/> <p>Note: Ensure that the location you have specified exists on the device.</p> <hr/> <p>The system does not upload the bot if it fails during the migration process. The system creates an XML report at the same location that provides information that helps you to troubleshoot if the system encounters an error during migrating the bot file.</p> <ul style="list-style-type: none"> • Select the Overwrite the file if exists check box to overwrite an existing bot file. • Set a time-out value for migrating the bots within the range of 3 through 90 minutes (default value is 90 minutes). <p>If the migration of any specific bot is not completed within the set time, the bot will display a timeout message with the reason for the failure and the migration process will move on to the next bot.</p> <ul style="list-style-type: none"> • If you are migrating Enterprise 10 and Enterprise 11 bots that are built using Internet Explorer, select the Convert bots built using Internet Explorer to Edge with Internet Explorer mode option to convert them to Microsoft Edge with IE mode.
Update bot	<p>This action converts Automation 360 bots that are built using Internet Explorer browser to Microsoft Edge Chromium with IE mode. This action is internally used by the Update Bot wizard to convert the bots.</p> <hr/> <p>Note: This action cannot be used manually in a new or an existing bot for bot conversion.</p> <hr/>

Related concepts

[Migrate to Automation 360](#)

Browser package

The **Browser** package contains actions that enable you to download files, find broken links, and launch a website. This package supports Google Chrome, Chromium-based Microsoft Edge, and Internet Explorer browsers.

Actions in the Browser package

The **Browser** package includes the following actions:

Action	Description
Call a JavaScript function	See Call a JavaScript function action
Close	Close action
Download files	Download files action
Find broken links	Using Find broken links action.
Get source code	Get source code action
Go back	Go back action
Open	Open action
Run JavaScript	Run JavaScript action

Note:

- When you perform any action from the Browser package on the Internet Explorer browser tab, if multiple tabs with the same tab title are opened in the same browser window, the matching title is not searched in sequence starting from the first tab. The tab activation and browser action might be performed on different matching tabs in this case.
 - If the same tab title occurs on different windows, then the action is executed on a tab with a matching title in any window.
-

Call a JavaScript function action

The Call a JavaScript function action in the Browser package enables you to call an existing JavaScript function directly in a webpage or in an iFrame within a webpage.

Configure the settings

Note: This action supports Google Chrome and Chromium-based Microsoft Edge browsers.

1. Select the browser tab from the list of active supported browser tabs or insert a window variable.

You can use a regular expression (regex) to identify a window title. Select the regular expression condition as either **String** or a **Pattern** and then enter the value. By default, the **Window title** field is case-sensitive.

To identify a browser title, you can enable the **Case sensitive** option to match the letter case, or disable the option to identify a window title where the letter case does not match.

Note: Ensure that the minimum version installed on your system is the version that was released with v.26. If you have a version released with v.25 or earlier, then by default, the window title will be identified only with matching letter case (case-sensitive).

For example, you can enter the **String** value as `((\w*)-Notepad` for all window title names starting with `((\w*)-Notepad`, or use **Pattern** value as `((\w)\s)*document-Notepad` for only those window titles that match this pattern.

Note:

- When you use a regular expression of type **String** with `-title` as the input value for a window title in any , the might encounter a run time error. To prevent the run time error, ensure that when you add the string input as `*-title`, the application with the specific title is open. The asterisk (*) is just a character, not a wild card character.
 - When you use a regular expression of type **Pattern** with `-title` as the input value for a window title in any , the might encounter a run time error because the input value `*-title` is incorrect. Ensure that you use valid regex patterns.
-

2. **Optional:** Use the **Capture object** option to capture the iFrames.

Note: You can use the **Capture object** feature to call and run an existing JavaScript function inside an iFrame.

3. In the **Function name** field, specify the name of the existing JavaScript function that you want to call.
4. **Optional:** In the **Arguments** section, click **Add argument** to add arguments that must be passed to call the JavaScript function.
 - a. In the **Argument details** dialog box, select the **Argument type** required for the specific argument.
 - b. In the **value** field, enter the corresponding value or variable of the selected type that you want to pass.

Note: All string values in arguments are passed as is without any character being converted or escaped.

5. **Optional:** In the **Time out after** field, enter the number of seconds the bot must wait for the browser action to complete.

Recommended: Enter a timeout value of at least 9 seconds.

6. In the **Return Type** field, select the type of value returned by the JavaScript function.

Note: If the function does not return anything, in the **Return Type** field, select **None**.

7. For any **Return type** except **None**, in the **Save the outcome to a variable** field, select a variable for selected **Return type** to hold the JavaScript function output.

Create variable

To create a variable for selected **Return type**, perform the following steps:

1. Click the Create variable symbol next to the **Save the outcome to a variable** field.
A **Create variable** dialog opens with default variable name for the type of variable selected.
2. **Optional:** Specify the variable information in the **Description** field.
3. **Optional:** Specify a value in the **Default value** field.
4. Click **Create & select** to select the newly created variable.

Supported JavaScript types in Argument and Return type fields

The following JavaScript types are supported:

- String, Number, and Boolean JavaScript types which correspond to the same variable types in bot variables.
- Array JavaScript type which corresponds to the *List* variable type in bot variables.
- Object JavaScript type which corresponds to the *Dictionary* variable type in bot variables.

Close action

Use the Close action in the Browser package to close a browser window or tab.

Settings

Note: This supports , Chromium-based , and browsers.

- Select to close the tab, window, or all browsers:
 - **Tab:** Closes the selected tab. Select the browser tab from the list of active supported browser tabs or insert a window variable.

You can use a regular expression (regex) to identify a window title. Select the regular expression condition as either **String** or a **Pattern** and then enter the value. By default, the **Window title** field is case-sensitive.

To identify a browser title, you can enable the **Case sensitive** option to match the letter case, or disable the option to identify a window title where the letter case does not match.

Note: Ensure that the minimum version installed on your system is the version that was released with v.26. If you have a version released with v.25 or earlier, then by default, the window title will be identified only with matching letter case (case-sensitive).

For example, you can enter the **String** value as `((\w*)-Notepad` for all window title names starting with `((\w*)-Notepad`, or use **Pattern** value as `((\w)\s)*document-Notepad` for only those window titles that match this pattern.

Note:

- When you use a regular expression of type **String** with `-title` as the input value for a window title in any , the might encounter a run time error. To prevent the run time error, ensure that when you add the string input as `*-title`, the application with the specific title is open. The asterisk (*) is just a character, not a wild card character.
- When you use a regular expression of type **Pattern** with `-title` as the input value for a window title in any , the might encounter a run time error because the input value `*-title` is incorrect.

Ensure that you use valid regex patterns.

- **Window:** Closes the window of the selected tab. Select the window from the list of active supported windows or insert a window variable.

You can use a regular expression (regex) to identify a window title. Select the regular expression condition as either **String** or a **Pattern** and then enter the value. By default, the **Window title** field is case-sensitive.

To identify a browser title, you can enable the **Case sensitive** option to match the letter case, or disable the option to identify a window title where the letter case does not match.

Note: Ensure that the minimum version installed on your system is the version that was released with v.26. If you have a version released with v.25 or earlier, then by default, the window title will be identified only with matching letter case (case-sensitive).

For example, you can enter the **String** value as `((\w*)-Notepad` for all window title names starting with `((\w*)-Notepad`, or use **Pattern** value as `((\w)\s)*document-Notepad` for only those window titles that match this pattern.

Note:

- When you use a regular expression of type **String** with `-title` as the input value for a window title in any , the might encounter a run time error. To prevent the run time error, ensure that

when you add the string input as `*-title`, the application with the specific title is open. The asterisk (*) is just a character, not a wild card character.

- When you use a regular expression of type **Pattern** with `-title` as the input value for a window title in any , the might encounter a run time error because the input value `*-title` is incorrect.

Ensure that you use valid regex patterns.

-
- **All browsers:** Closes all open browser windows for supported browsers.
 - **Optional:** In the **Time out after** field, enter the number of seconds the bot must wait for the browser window or tab to close before the bot fails.
-

Recommended: Enter a timeout value of at least 9 seconds.

Download files action

The Download files action in the Browser package downloads and saves files from specified URLs and URLs that require NTLM authentication.

Settings

Downloads and saves files from specified URLs and URLs that require NTLM authentication.

- Specify the **URL of the file** you want to download.
- In the **Save to location** field, enter the location where you want to save the file.

Using Find broken links action

The **Find broken links** action finds broken links on a specific page or website, stores the output to a CSV file. Optionally, you can specify encoding for the output data.

Follow these steps to find broken links:

1. In the **Actions** palette, double-click or drag the **Find broken links** action from the **Browser** package.
2. In the **Page or URL** field, enter the URL of the page or website.
3. In the **Scope** option, choose either **check only this page** or **check the whole site**.
4. In the **Save list to location** field, specify the location of the CSV file.
5. Select the **Append to already existing csv file** check box if you want to append the data to an existing CSV file.
6. Select an option from the **Encoding** list to specify the encoding that you want to apply on the file.
 - **ANSI**
 - **Unicode**
 - **UTF-8**
7. In the **Number of parallel threads** field, enter the number of parallel threads you want to run simultaneously.

Parallel threads means multiple processes running simultaneously to perform the same task which results in faster execution. Higher the number of parallel threads faster the execution of a task execution. For example, if 10 threads complete a task in two minutes, 20 threads compete a task in one minute.

Note: The maximum value you can provide in the field is 99.

8. In the **Time out** field, specify the maximum time the system must wait to receive a response from each URL link.
9. Click **Save**.

Get source code action

The **Get source code** action retrieves the source code of a web page and an iFrame on a web page and saves the output to a string variable.

Settings

Note: This supports , Chromium-based , and browsers.

- Select the browser tab from the list of active supported browser tabs or insert a window variable.
 - **Optional:** Use the **Capture object** option to capture the iFrames.
-

Note:

- The **Capture object** feature is used only to retrieve the source code of an iFrame. If you do not capture anything on the window, the source code of the entire window is retrieved.
 - Retrieving the source code of an iFrame is currently supported only on the Google Chrome browser.
-
- **Optional:** In the **Time out after** field, enter the number of seconds the must wait for the browser action to complete.
-
- Recommended:** Enter a timeout value of at least 9 seconds.
-
- **Optional:** Select a variable to hold the output. The shows a descriptive default variable name. If you create several output variables, subsequent variable names are appended with a -1, -2, -3, and so on to avoid duplication.

Go back action

The **Go back** action returns to a web page previously visited in the current tab. This action simulates clicking the browser **Back** option.

Settings

Note: This supports , Chromium-based , and browsers.

- Select the browser tab from the list of active supported browser tabs or insert a window variable.

Note: When you select the Internet Explorer tab from the list of active tabs, and if the selected tab title or any intermediate tab title while performing the **Go back** action has more than 60 characters, then the first 60 characters are used for comparison to find the matching tab title.

Recommendation: When you perform the action on the browser tab, ensure that only a single tab is open in the browser window with the matching tab title. This setting ensures that when the action is executed, there is no intermediate tab title that matches another tab title in the same window.

- In the **Number of steps back** field, enter the number of pages to go back to.
- **Optional:** Select the **Throw an error if steps exceed history** option so that the bot will fail if the number entered in the previous step is greater than the number of pages visited.

If this option is not selected, when the bot runs, it will return the tab to the first web page it opened.

- **Optional:** In the **Time out after** field, enter the number of seconds the must wait for the browser action to complete.
-

Recommended: Enter a timeout value of at least 9 seconds.

Open action

The **Open** action opens the browser to a specific web page.

Settings

- Select to open the web page in an existing tab, new tab, or new window:
 - **Existing tab:** Opens the web page on a currently open tab. Select the tab from the list of active supported browser tabs, the **Last used browser tab** option, or insert a window variable.

Note: This option supports , Chromium-based , and browsers.

You can use a regular expression (regex) to identify a window title. Select the regular expression condition as either **String** or a **Pattern** and then enter the value. By default, the **Window title** field is case-sensitive.

To identify a browser title, you can enable the **Case sensitive** option to match the letter case, or disable the option to identify a window title where the letter case does not match.

Note: Ensure that the minimum version installed on your system is the version that was released with v.26. If you have a version released with v.25 or earlier, then by default, the window title will be identified only with matching letter case (case-sensitive).

For example, you can enter the **String** value as `((\w*)-Notepad` for all window title names starting with `((\w*)-Notepad`, or use **Pattern** value as `((\w)\s)*document-Notepad` for only those window titles that match this pattern.

Note:

- When you use a regular expression of type **String** with `-title` as the input value for a window title in any , the might encounter a run time error. To prevent the run time error, ensure that

when you add the string input as `*-title`, the application with the specific title is open. The asterisk (*) is just a character, not a wild card character.

- When you use a regular expression of type **Pattern** with `-title` as the input value for a window title in any , the might encounter a run time error because the input value `*-title` is incorrect.

Ensure that you use valid regex patterns.

-
- **New tab:** Opens the web page on a new tab. Select the tab from the list of active supported browser tabs or insert a window variable.
-

Note:

- This option supports Google Chrome, Chromium-based Microsoft Edge, and the Internet Explorer browsers.
 - When you perform the action on the Internet Explorer tab, the action is executed in the matching tab only when it is in ready state.
-

You can use a regular expression (regex) to identify a window title. Select the regular expression condition as either **String** or a **Pattern** and then enter the value. By default, the **Window title** field is case-sensitive.

To identify a browser title, you can enable the **Case sensitive** option to match the letter case, or disable the option to identify a window title where the letter case does not match.

Note: Ensure that the minimum version installed on your system is the version that was released with v.26. If you have a version released with v.25 or earlier, then by default, the window title will be identified only with matching letter case (case-sensitive).

For example, you can enter the **String** value as `((\w*)-Notepad` for all window title names starting with `((\w*)-Notepad`, or use **Pattern** value as `((\w)\s)*document-Notepad` for only those window titles that match this pattern.

Note:

- When you use a regular expression of type **String** with `-title` as the input value for a window title in any , the might encounter a run time error. To prevent the run time error, ensure that

when you add the string input as `*-title`, the application with the specific title is open. The asterisk (*) is just a character, not a wild card character.

- When you use a regular expression of type **Pattern** with `-title` as the input value for a window title in any , the might encounter a run time error because the input value `*-title` is incorrect.

Ensure that you use valid regex patterns.

-
- **New window:** Opens the web page on a new window of a specific browser.

Select the browser from the following options:

- Default Browser

Ensure that Google Chrome, Microsoft Edge or Internet Explorer is set as the default browser.

Note: If any browser that is not listed is set as the default browser for the device, the bot might encounter an error.

-
- Google Chrome
 - Internet Explorer
 - Microsoft Edge
 - Mozilla Firefox

- Enter the link to the web page to open.

Note: For web pages to open properly, we recommend that you specify a URL with the protocol information, such as `http`, `https`, or `file`.

-
- Optional: In the **Time out after** field, enter the number of seconds the bot must wait for the specified webpage to load before the bot fails.

Recommended: Enter a timeout value of at least 9 seconds.

Note:

- Timeout is applicable only for the **New tab** and **Existing tab** options.
 - For the Internet Explorer browser, the bot executes even if the webpage is not loaded completely after waiting till timeout.
-

Run JavaScript action

The **Run JavaScript** action in the Browser package executes JavaScript on a web page and on web pages that have iFrames.

Settings

Note: This supports , Chromium-based , and browsers.

-
- Select the browser tab from the list of active supported browser tabs or insert a window variable.

You can use a regular expression (regex) to identify a window title. Select the regular expression condition as either **String** or a **Pattern** and then enter the value. By default, the **Window title** field is case-sensitive.

To identify a browser title, you can enable the **Case sensitive** option to match the letter case, or disable the option to identify a window title where the letter case does not match.

Note: Ensure that the minimum version installed on your system is the version that was released with v.26. If you have a version released with v.25 or earlier, then by default, the window title will be identified only with matching letter case (case-sensitive).

For example, you can enter the **String** value as `((\w*)-Notepad` for all window title names starting with `((\w*)-Notepad`, or use **Pattern** value as `((\w)\s)*document-Notepad` for only those window titles that match this pattern.

Note:

- When you use a regular expression of type **String** with `-title` as the input value for a window title in any , the might encounter a run time error. To prevent the run time error, ensure that when you add the string input as `*-title`, the application with the specific title is open. The asterisk (*) is just a character, not a wild card character.
 - When you use a regular expression of type **Pattern** with `-title` as the input value for a window title in any , the might encounter a run time error because the input value `*-title` is incorrect. Ensure that you use valid regex patterns.
-

- Choose one of the following options:

- In the **Import existing file** option, select an existing file.

Note: If you are uploading a script from a file on your desktop, the file and any dependencies must be in a standalone folder. When you select a file for upload, all files and folders at the same folder level are uploaded.

- In the **Manual input** option, enter the .

- **Optional:** Use the **Capture object** option to capture the iFrames.
-

Note:

- The **Capture object** feature is used only to run JavaScript inside an iFrame.
 - Support to run JavaScript inside an iFrame is available only for the Google Chrome browser.
-

- **Optional:** In the **Time out after** field, enter the number of seconds the must wait for the browser action to complete.
-

Recommended: Enter a timeout value of at least 9 seconds.

- **Optional:** Select a variable to hold the action output. The Control Room shows a descriptive default variable name. If you create several output variables, subsequent variable names are appended with a -1, -2, -3, and so on to avoid duplication.
-

Recommendation:

- Do not use JQuery with the JavaScript package.
 - Use the **Try/Catch** actions from the Error handler in the JavaScript function.
 - Call a JavaScript function before declaring it.
-

Clipboard package

The Clipboard package contains actions that enable you to automate using the Windows clipboard. Use the actions to copy a string value to the clipboard, copy the clipboard value to a string variable, and clear the clipboard.

Actions in the Clipboard package

The Clipboard package includes the following actions:

Action	Description
Clear	Clears the clipboard. This action will remove any value that is stored in the clipboard.
Copy from	Retrieves the values stored in the clipboard and stores it in the string variable that you select from the Assign the output to variable list. This action enables you to pass the value from the clipboard to other actions.
Copy to	Stores values in the clipboard. You can either enter the value or specify the string variable that contains the value in the Value field.

Credential package

In the Credential package, use the **Assign** action to assign an insecure string or a variable value directly to the credential variable.

Actions in the Credential package

The Credential package includes the following action:

Note:

- The credential variables support the retry mechanism. When you create a bot that uses credential variables, if the bot fails during run time to retrieve those variables from the Credential Vault because the Control Room is disconnected or the Control Room services stop intermittently, then the bot tries three times to retrieve the credential variables from the Credential Vault.
- While the **Convert credential to string** action is listed on the Credential package details page, it is not available for use from the actions list in the Bot editor. This is because the action should be used only for migration and not for other scenarios because it introduces a security risk.

Action	Description
Assign	<p>Sets the value of a credential variable.</p> <ul style="list-style-type: none"> • You can select Credential to use a value from the Credential Vault, Variable to use a credential variable, or Insecure string to manually enter a variable. • In the Save the outcome to a variable field, select a variable to hold the returned value.

CSV/TXT package

The **CSV/TXT** package contains actions that enable you to open a CSV or text file, read data from that file, and assign the data to a Table variable. This package supports files encoded in ANSI, Unicode, UTF-8, or Windows-1251, and can process up to one million records.

Perform the following actions within the **CSV/TXT** package as part of using the set of available actions:

1. Open the file to be used in the automation. See [Using the Open action for CSV/TXT file](#).

Note: For files containing large data sets, use actions from the Database package to automate create, read, and update operations. See [Using Connect action for database](#).

2. Use the **Read** action to retrieve values from a CSV or TXT file and store them in a Table variable. See [Using Read action](#).

To retrieve values row by row, use the **For each row in CSV/TXT** iterator in the Loop action to read values from each row in the file and assign it to a record variable. See [Using the For each row in CSV/TXT iterator](#).

Note: The **Read** action and **For each row in CSV/TXT** iterator only support CSV/TXT files that conform to the RFC 4180 standard. For more information about the standard, see [Common format and MIME type for CSV files](#).

3. After you have automated the CSV/TXT-related tasks, close the file using the **Close** action. Enter the session name that was used to open the file with the **Open** action.

Related reference

[Loop package](#)

Use the Loop package to run a sequence of actions repeatedly for a specific number of times or until a specific condition is met.

[Your variables \(user-defined\)](#)

Users and some actions create user-defined variables to temporarily hold values. Use this kind of variable to input values into an action (window title, login credential, or file path) or to accept the output of an action (values read from a file or a Boolean return).

Using the Open action for CSV/TXT file

This action enables you to specify the delimiter used in the file, whether to trim the spaces, and the encoding applied on the file.

Note: If there is a double quotation mark (") in the last element of the last line of the CSV/TXT file, at runtime the bot will encounter an error.

To open a CSV or text file, do the following:

1. Double-click or drag the **Open** action from the **CSV/TXT** package in the **Actions** palette.
2. Select any of the following options to specify the location of the CSV or text file to open:
 - **Control Room file:** Enables you to open a file from the .
 - **Desktop file:** Enables you to open a file from the device. This field also accepts the file path input as a string variable or global value.

Note: When you enter a file path in the **Desktop file** field or browse a particular file from the system, wherein the file path is separated by the \ character and save the , the \ character is changed to / as the uses / to separate file paths. Your continue to run successfully even if the \ is changed to / during execution.

- **Variable:** Enables you to open a file by specifying a file variable.
3. Select the **Contains header** check box if the file contains a header row and you want to retrieve values from that row.
 4. Select any of the following options to specify the **Delimiter** used in the file:
 - **Comma**
 - **Tab**
 - **Regional list separator:** Enables you to specify the delimiter as configured in the regional settings of the Windows operating system. If the **List Separator** in the Windows regional settings is modified, then the CSV file should also contain that character as a delimiter.
 - **Newline**
 - **Other:** Enables you to specify a delimiter other than the options listed above.
 5. Select the **Trim leading** and **Trim trailing** check boxes to remove the leading and trailing spaces from the data extracted from the CSV/TXT file
 6. Select an option from the **Encoding** list to specify the encoding that is applied on the file. Data from the CSV/TXT file will be retrieved based on the selected encoding option even if the input file has a different encoding.
 - **ANSI:** Used to encode Latin alphabet.
 - **UTF8:** Can encode all possible characters.
 - **UNICODE**
 - **Win1251:** used to encode languages that use the Cyrillic script, including Bulgarian, Russian, and Serbian.
 - **UTF-16LE:** ignores the byte order mark (BOM) Unicode character at the beginning of file.
 - **Default:** identifies file encoding. This option supports UTF-8, UTF-16LE, and UTF-16BE file encoding.

Note: Shift-JIS files must use **ANSI** as encoding to read text file content.

7. Click **Save**.

Use the **Read** action to retrieve the data from CSV/TXT file and assign them to a table variable. You can use the loop action to retrieve each row of data from the file or table variable and assign them to the record variable for further operations.

- [Using Read action](#)
- [Using the For each row in CSV/TXT iterator](#)

Using Read action

Use the **Read** action to retrieve values from a CSV or TXT file and insert them into a Table variable in order to perform operations with the data values.

Note: The **Read** action only support CSV/TXT files that conform to the RFC 4180 standard. For more information about the standard, see [Common format and MIME type for CSV files](#).

To retrieve values from a CSV/TXT file, do the following:

1. Double-click or drag the **Read** action from the **CSV/TXT** node in the **Actions** palette.
2. Enter the name of the session that you have used to open the CSV or text file in the **Open** action.

3. Select a Table variable from the **Assign value to the variable** list.

Create a variable if it does not already exist. The shows a descriptive default variable name. If you create several output variables, subsequent variable names are appended with a -1, -2, -3, and so on to avoid duplication.

Note: A bot can return only a maximum of 3 MB to an output variable.

Workaround: Store the bot output on the device, such as in a .txt file. If the output must be shared across multiple Bot Runners, store the output in a shared drive.

Perform operations with the values in the Table variable using the [Data Table package](#).

Comment package

Use the **Comment** package to insert a user-specified comment into your bot logic.

Action in the Comment package

The **Comment** package includes the following action:

Action	Description
Comment	Inserts a comment. Note: A comment is saved and displayed as a single line. A comment with multiple lines is displayed as a single line, followed by an ellipsis when the comment is saved. Comments are ignored when the bot runs.

Data Table package

The Data Table package contains actions that enable you to perform various operations on the values of table variables. Use these actions to join or merge content, search for specific values, insert rows and columns, remove duplicate rows, and write values to a file.

Actions in the Data Table package

The Data Table package includes the following actions:

Note: If you built a bot using actions from the Data Table package from Build 5322 or earlier, the actions will be missing when you open the bot with the default package version. You must reinsert the actions and repopulate the fields.

Action	Description
Assign	Assign action .
Change column type	Change column type action .
Clear content	Clear content action .
Delete column	Delete column action .

Action	Description
Delete row	Delete row action .
Get number of columns	Get number of columns action .
Get number of rows	Get number of rows action .
Insert column	Insert column action .
Insert row	Insert row action .
Join	<p>Using Join action.</p> <p>Use the Join type output examples to help you decide whether to use the Join or Merge action.</p> <hr/> <p>Note: If you built a bot using this action from package version 2.0.0-20200624-042148 or earlier, the action will be missing when you open the bot with the default package version. You must reinsert the action and repopulate the fields.</p> <hr/>
Merge	<p>Using the Merge action.</p> <p>Use the Merge output example to help you decide whether to use the Join or Merge action.</p> <hr/> <p>Note: If you built a bot using this action from package version 2.0.0-20200624-042148 or earlier, the action will be missing when you open the bot with the default package version. You must reinsert the action and repopulate the fields.</p> <hr/>
Remove duplicate rows	Remove duplicate rows action .
Search for a value	Search for a value action .
Set value of a single cell	Set value of a single cell action .
Sort	Sort action .
Write to file	Using Write to file action .

Example: [Example of extracting data from a web table](#)

Assign action

The Assign action in the Data Table package enables you to assign values to a table variable.

Settings

You can use this action to manually enter the table data.

- Select whether to create a table with or without values.
 - If you select to create a table with values, either manually enter the values or select a source table variable.
 - If you select to create a table without values, specify the number of rows and columns.

- Select a table variable to hold the output. You can either select the source table variable to overwrite the values, or select a different table variable.

Change column type action

The Change column type action in the Data Table package enables you to change the data type of a column.

Settings

- Select the data table name from the drop-down list.
- Select whether to specify the column by **Name** or **Index**.
 - If you select to specify by name, enter the column name.
 - If you select to specify by index, enter the column index. For example, to set a value to the first column, enter 0.
- Select the new column data type from the drop-down list to **Number**, **Boolean**, **String**, or **Datetime**.
 - If you select **Datetime**, you can format the values by selecting a predefined format or specifying a custom format.
 - To specify the format applied on the input data table variable, select an option either from the predefined format list or enter the value in a custom format.
- Select a table variable to include the output.

You can either select the source table variable to overwrite the values or select a different table variable.

Clear content action

The Clear content action in the Data Table package enables you to clear the contents of the specified table variable.

Settings

This action clears the content until the execution of the bot is completed. After the bot execution is completed, the original values of the table variables are restored.

This action enables you to reuse an existing table variable to store values that are used only during the bot execution.

Note: The data type of the values must be same as the data type of the columns in the table variable.

Delete column action

The Delete column action in the Data Table package enables you to delete a specific column.

Settings

- Select the Table variable name from the drop-down list.
- Specify the column name or column index to delete.

Note: The index count starts from 0.

Delete row action

The Delete row action in the Data Table package enables you to delete a specific row.

Settings

Note: If the data table values were read from an Excel sheet, and you selected the **Sheet contains a header** option in the **Open** action, you cannot delete cells from the first row.

- Select the Table variable name from the drop-down list.
 - Specify the row name or row index to delete.
-

Note: The index count starts from 0.

Get number of columns action

The Get number of columns action in the Data Table package enables you to retrieve the number of columns from a table.

Settings

Retrieves the number of columns and assigns it to a Number variable. You have the option to select the non-empty columns or include all the columns in the selection.

Get number of rows action

The Get number of rows action in the Data Table package enables you to retrieve the number of rows from a table.

Settings

Retrieves the number of rows and assigns it to a Number variable. You have the option to select the non-empty rows or include all the rows in the selection.

Insert column action

The Insert column action in the Data Table package enables you to insert a column from one table to another table.

Settings

For destination table:

- Select the destination table variable from the **Enter into data table** list.
 - Select where to insert the column: first index, last index, or enter the column index number.
-

Note: The index count starts from 0.

For source table:

- Select the source table variable from the **Insert from table** list.
- Enter the name or index number of the column to insert.

Insert row action

The Insert row action in the Data Table package enables you to insert a row into the table.

Settings

- In the **Data table name** field, select the name of the table variable from the drop-down list or create a new variable of type **Table**.
- Select where you want to insert the row: **first position**, **last position**, or at a **specific index** position.
- In the **Row record name** field, create a record variable or choose an existing record variable to hold the values for the new row that you want to insert.
- In the **Create variable** tab, enter the name of the variable and under the **Default value** section, enter the name, value, and the type of value that you want to add to the new row as per the specified index values.

Note: The index count start from 0.

Using Join action

Use the **Join** action to combine content from two table variables. This action enables you to combine content based on the shared values of a specific column in the tables and store the content into a third Table variable or one of the two source tables.

To join the content from two Table variables, do the following:

1. Double-click or drag **Data table > Join**.
2. Select the first Table variable to use from the **Enter first data table name** list.
3. Enter the name of the column from the first Table variable that contains the data to join.
4. Select the second Table variable to use from the **Enter second data table name** list.
5. Enter the name of the column from the second Table variable that contains the data to join.
6. Select an option to specify the type of join. For more information, see [Join type output examples](#).
 - **inner join:** Returns only the records that have matching values in the selected columns in both tables.
 - **left outer join:** Returns all records from the first table, and the matched records from the second table.
 - **right outer join:** Returns all records from the second table, and the matched records from the first table.
 - **full outer join:** Returns all records when there is a match in either left or right table.
7. In the **Enter name of data table in which to join** field, select the table variable to store the combined values.

Note:

- Starting from Automation 360 v.27 if you are using 4.6.0-20220920-155212 version of the Data Table package, the **Enter name of data table in which to join** field is mandatory and you must specify a third data table in the field to save the result of the Join action.

- When you upgrade from a previous version to Automation 360, and if you have not updated the package version to 4.6.0-20220920-155212, your bots will continue to run as is. In case you have updated both your bots and the package to the latest version, your bots will continue to run successfully if you have selected a table variable to store the output. If the field is empty, then the bot will encounter an error.

Join type output examples

Select a join type option based on your desired output. Use the examples below to guide your selection.

Inner join

Returns only the records that have matching values in the selected columns in both tables.

For example, if you have a table of employees and their departments, and a table of employees and their pay rates, this option will return a table of the employees that exist in both tables, and their departments and pay rates.

Table 1: Employees and Departments

Employee	Department
John	101
Jill	102
Mike	103
Betty	104
Cindy	105

Table 2: Employees and Pay rates

Employee	Pay rate
John	50
Betty	50
Mike	40
Jill	35
Dan	45

Table 3: Employees, Departments, and Pay rates

Employee	Department	Pay rate
John	101	50
Jill	102	35
Mike	103	40
Betty	104	50

Left outer join

Returns all records from the first table, and the matched records from the second table.

Using the example Tables 1 and 2, this option returns the following table:

Table 3: Employees, Departments, and Pay rates

Employee	Department	Pay rate
John	101	50
Jill	102	35
Mike	103	40
Betty	104	50
Cindy	105	

Right outer join

Returns all records from the second table, and the matched records from the first table.

This option returns the following table:

Table 3: Employees, Departments, and Pay rates

Employee	Department	Pay rate
John	101	50
Betty	104	50
Mike	103	40
Jill	102	35
Dan		45

Full outer join

Returns all records when there is a match in either left or right table.

This option returns the following table:

Table 3: Employees, Departments, and Pay rates

Employee	Department	Pay rate
John	101	50
Jill	102	35
Mike	103	40
Betty	104	50
Cindy	105	

Employee	Department	Pay rate
Dan		45

Using the Merge action

Use the **Merge** action to combine the contents of two tables when both source tables contain identical column headers. To combine tables that contain different column headers, use the **Join** action.

If one of the tables contains non-identical headers, then the merged table will contain the columns from the first source table with data from the second source table under the identical column headers, followed by the non-identical columns and data from the second source table.

To merge the content, perform these steps:

1. Double-click or drag **Data table > Merge**.
2. Select the first table variable you want to use from the **Enter first data table name** list.
3. Select the second table variable you want to use from the **Enter second data table name** list.
4. Select the table variable that you want to use to store the merged data from the **Enter name of data table in which to merge** list.
5. Click **Save**.

For more information, see [Merge output example](#).

Merge output example

The **Merge** action combines data from two tables with identical column headers, and stores the merged content in a third table or one of the two source tables. These examples demonstrate the output of two tables with identical column headers and the output of two tables with differing column headers.

Output of tables with identical column headers

For example, if you have a table of employees hired in September and a table of employees that were hired in October, this option will return a table of all the employees, with the October hires merged below the September hires.

Table 1: Employees hired in September

Employee	Department	Pay rate
John	101	50
Jill	102	35

Table 2: Employees hired in October

Employee	Department	Pay rate
Mike	103	40
Betty	104	50

Table 3: All employees

Note: The column headers in the output table are always lowercase.

employee	department	pay rate
John	101	50
Jill	102	35
Mike	103	40
Betty	104	50

Output of tables with differing column headers

In this example, the second table has a different column header. As a result, the third table contains the columns from the first source table with data from the second source table under the identical column headers, followed by the non-identical columns and data from the second source table.

Table 1: Employees hired in September

Employee	Department	Pay rate
John	101	50
Jill	102	35

Table 2: Employees hired in October

Employee	Department	Salary
Mike	103	40
Betty	104	50

Table 3: All employees

employee	department	pay rate	salary
John	101	50	
Jill	102	35	
Mike	103		40
Betty	104		50

Remove duplicate rows action

The Remove duplicate rows action in the Data Table package enables you to delete any duplicate rows from a table.

Settings

Select the Table variable name from the drop-down list.

Search for a value action

The Search for a value action in the Data Table package enables you to search for a specific value in a table and returns the row or column numbers in which the entry occurs and assigns the values to a List variable.

Settings

For example, if you search for the entry

abc

that is available at the fourth row and third column of a table variable, the action returns

3,2

as output. As the index number for the row and column starts with zero, the values in the output indicates the fourth row and third column.

- Select the Table variable name from the drop-down list.
- Enter the text to search for.
- Select **Match case** to ensure the case matches the text searched.

Set value of a single cell action

The Set value of a single cell action in the Data Table package enables you to update the value of a specific cell.

Settings

- Select the Table variable name from the drop-down list.
- Enter the row index. For example, to set a value to the first row, enter 0.
- Select whether to specify the column by **Name** or **Index**.
 - If you select to specify by name, enter the column name. Capitalization is not important.
 - If you select to specify by index, enter the column index. For example, to set a value to the first column, enter 0.
- Enter the value to set.

Sort action

The Sort action in the Data Table package enables you to sort the table data by column.

Settings

This action enables you to sort the data by column data format (string, number, datetime, or Boolean).

- Select the Table variable name from the drop-down list.
- Specify the column name or column index to sort by.
- Select the order in which to sort: **ascending order** or **descending order**.

Note: If you built a using this from version 2.0.0-20200624-042148 or earlier, the will be missing when you open the with the default version. You must reinsert the and repopulate the fields.

Using Write to file action

Use the **Write to file** action to write the data from a Table type variable to a CSV or TXT file.

To write data into a file, do the following:

1. Double-click or drag **Data table** > **Write to file**.
2. Select the Table variable that contains the data to write from the **Data table name** list.
3. Specify the location of the file in which to write the data in the **Enter file name** field.
4. Select the **Create folders/files if it doesn't exist** check box to create the file or folder that you specified in the **Enter file name** field.
5. Select an option to specify what to do when writing data in an existing file:
 - **Append to the existing file**
 - **Override existing file**
6. Select an option from the **Row delimiter** list to specify the delimiter to use for rows.
7. Select an option from the **Column delimiter** list to specify the delimiter to use for columns.
8. Select an option from the **Encoding** list to specify the encoding that you want to apply on the file.

The default encoding is set to ANSI

- **ANSI**
 - **UTF-8**
 - **Unicode**
 - **Win1251**
 - **UTF-8 with BOM**
 - **UTF-16LE**
 - **Shift-JIS (Japanese encoding)**
9. In the **Assign value to variable** list, select a string variable.

Database package

Databases support internal operations of an enterprise by storing a variety of data, such as sales transactions, product catalogs, inventories, and customer profiles. Use the Database package to connect to a database, begin a transaction, and manipulate the stored data by retrieving, inserting, updating, deleting, and exporting it to a CSV file.

Before you start

Perform the following actions within the Database package as part of using the set of available actions:

Note: When you use actions such as **Read from**, **Run stored procedure**, or **Export to data table** to retrieve records from a MS SQL Server table which has a bit type column or an Excel column (with `TRUE` or `FALSE` values), then the retrieved data will be referred to `0` and `1`, not `TRUE` and `FALSE`.

1. Establish a connection with the database server using the **Connect** action.

See [Using Connect action for database](#).

2. Choose from the following:

- Use the **Read from** action to retrieve records from the database. See [Using the Read from action](#).
- If you are automating a task that involves making changes to the database, insert the **Begin database transaction** action, followed by the actions that automate the changes.

This action ensures that all records are updated or deleted in their entirety, and prevents accidental updates or deletions of incomplete data if the bot encounters an error during run time.

3. If you used the **Begin database transaction** action in this session, insert the **End database transaction** to commit the changes.

4. Every set of database actions ends with the **Disconnect** action to terminate the connection to the database server.

Actions in the Database package

The Database package includes the following actions:

Action	Description
Begin database transaction	See Begin database transaction action .
End database transaction	See End database transaction action .
Connect	See Using Connect action for database . The Snowflake database using the ODBC driver is supported.
Disconnect	See Disconnect action .
Read from	See Using the Read from action . The Snowflake database using the ODBC driver is supported.
Run stored procedure	See Using the Run stored procedure action .
Export to data table	See Using the Export to data table action . The Snowflake database using the ODBC driver is supported.
Manage stored procedure	See Manage stored procedure action .
Insert/Update/Delete	See Insert/Update/Delete action .

Related reference

[Loop package](#)

Use the Loop package to run a sequence of actions repeatedly for a specific number of times or until a specific condition is met.

[Variables overview](#)

Automation 360 offers a variety of variables, each designed to hold specific types of data and is intended for specific use. Use the topics below to learn more about each variable and how to use them.

Begin database transaction action

Use the Begin database transaction action in the Database package to starts a database transaction to commit all database actions till the end database transaction.

Settings

- The actions that you insert between the **Begin database transaction** and **End database transaction** actions are treated as a single unit. The bot must run all of the actions successfully in order to update the database. This prevents a partial entry in the event that one of the actions fail.
For example, in double-entry accounting every debit requires the recording of a credit. If a company receives \$5000 of products, the accountant must debit \$5000 to inventory and credit \$5000 to accounts payable.
- Insert the actions that record these entries between the **Begin database transaction** and **End database transaction** actions to ensure that either both entries are recorded or neither is recorded in the database.
- In the **Session name** field, enter the name of the session that you used to connect to the database server in the **Connect** action.

Note: **Begin** and **End database transaction** actions do not support ODBC connectivity.

End database transaction action

Use the End database transaction action Database package to commits all the database operations that were performed with the actions that followed the **Begin database transaction** action.

Settings

- All the database operations that were performed with the actions that followed the **Begin database transaction** action are committed, under the condition that the bot successfully ran those actions.
- In the **Session name** field, enter the name of the session that you used to connect to the database server in the **Connect** action.

Note: **Begin** and **End database transaction** actions do not support ODBC connectivity.

Using Connect action for database

Use the **Connect** action to establish a connection with the database server that you want to use to automate database-related tasks. This action supports Microsoft Access, Microsoft SQL Server, MySQL, Oracle, PostgreSQL Server, and SQLite database servers, as well as the use of CSV, Microsoft Excel, and TXT files as databases.

Note: If your current office installation is any of the following:

- Microsoft 365 Apps for Enterprise
- Office 2016, 2019, or 2021 (Consumer Version 2009 or later)

Then you do not need to install the Microsoft Access Database Engine as an additional component in your system.

However, if you have both Microsoft 365 Apps and the Microsoft Access Database Engine are installed on your system, then you can uninstall the Microsoft Access Database Engine and repair Microsoft 365 Apps.

Microsoft recommends that you do not install the Microsoft Access Database Engine driver separately because both the Microsoft Access Database Engine 2016 and Microsoft 365 Apps use the same major version identifier (16.0). To learn more about the Microsoft Access Database Engine driver installation requirement, see [Unable to use the Access ODBC or OLEDB provider](#)

Specify the details of a database server and associate it with a session name. Use the session name provided in this action in the other actions so that you do not have to provide the details of the database server in those actions.

To establish a connection with a database server, follow these steps:

1. Double-click or drag the **Connect** action from the Database package in the **Actions** palette.
2. Enter a unique name for the session in the **Session name** field.

3. Select the **Default** or **User defined** connection option.

When you select **User defined** connection mode and use action **Read from** with encoding ANSI to save the retrieved data in a CSV file, you will see that the retrieved records from the Oracle database display garbled character.

To know more about this issue, see [Fullwidth hyphen is garbled when exporting data to csv by Database: Read from action with encoding ANSI \(A-people login required\)](#)

- If you select the **Default** option, you can directly enter the connection string for any of the supported database types.

If you have configured your database and shared repository in the secondary site, use the JDBC connection to connect to the replica database. For example, `jdbc:sqlserver://AGL-ADDRESS:1433;databaseName=DB_NAME;user=username;password=password;applicationIntent`

You can establish a connection with the Snowflake database using ODBC drivers. For more information about downloading the ODBC driver, see [Snowflake using ODBC Driver](#)

You can enter the connection string to connect to the database. For example, `Driver={SnowflakeDSIIDriver};Server={account}.aws.snowflakecomputing.com;Database=D`

Use this option to connect to an Excel, CSV, or TXT file. See [Connection Strings by database type](#).

Note: To access any database through ODBC, you must first install a 32-bit ODBC driver on your device.

To ensure a more secure automation, use a Credential Vault variable for the connection string.

- Select the **Use ODBC 64-bit driver for connection** option to connect to the database.

Note:

- Ensure that 64-bit access ODBC driver is installed on your system to access any database and perform operations by using database actions.
- The following action does not support the 32-bit or 64-bit ODBC drivers because the listed actions are for database transactions that are carried out after making a connection with the database:
 - Begin database transaction
 - End database transaction
 - Manage stored procedure
- Using Excel as a database, you can process more rows with 64-bit drivers compared to 32-bit ones.

-
- If you select the **User defined** option, select the database type from the available options and complete the following fields based on the selection:

Database Type	Options
Microsoft SQL Server, PostgreSQL Server	<ul style="list-style-type: none"> • Server name: Enter the name of the database server you want to connect to. • Database name: Enter the database name. • Username: Enter the username you want to use to access the database server. To ensure a secure user name, select a Credential Vault variable. Otherwise, enter a value. • Password: Enter the password for the username you have provided. To ensure a secure password, select a Credential Vault variable. Otherwise, enter a value. • Instance name: Enter a name for this connection instance. <p><i>Connect to Microsoft SQL Server with Windows authentication</i></p>
MySQL	Enter the same options as in the Microsoft SQL Server database type. Also, enter the port number. The default port number is 3306.
Microsoft Access, SQLite	Select the database file path from: <ul style="list-style-type: none"> • Bots folder • local device • existing file variable

Database Type	Options
Oracle	<ul style="list-style-type: none"> • Server name (Optional): Enter the name of the Oracle server you want to connect to. • Optional:Select an option to specify the Oracle instance you want to use: <ul style="list-style-type: none"> • System id (SID): Enter the system ID. • Service name: Enter the service name. • TNS Name: Enter the TNS Name available in the <code>tnsname.ora</code> configuration file. Specify the file path of the <code>tnsname.ora</code> configuration file, if you have not set the system property with environment variable. <hr/> <p>Note: You can connect to the Oracle Database with the Server name or Oracle instance. If you are connecting using the server name, you must specify the System id (SID) or Service name in the Oracle instance field to identify the Oracle database and its instance. However, if you are connecting using the TNS name, you do not require to enter any value in the Server name field. You should only enter the value of the TNS name and file path.</p> <hr/> • Username: Enter the username you want to use to access the Oracle server. To ensure a secure user name, select a Credential Vault variable. Otherwise, enter a value. • Password: Enter the password for the username you have provided. To ensure a secure password, select a Credential Vault variable. Otherwise, enter a value. • Port: Enter the port number. The default port number is 1521.

Note: If you establish a connection by using a JDBC driver, for Microsoft SQL Server, the Database package already includes the JDBC driver. However, for other database servers, you must provide the corresponding JDBC driver jar file after downloading it from the appropriate resources.

If you establish a connection by using an ODBC driver, you need not provide a jar file.

4. Select a driver file from the **Bots** folder, the local device, or a file variable.
5. Click **Save**.

Choose from the following:

- Use the **Read from** action to retrieve records from the database.

Using the Read from action

- If you are automating a task that involves making changes to the database, insert the **Begin database transaction** action.

This action ensures that all records are updated or deleted in their entirety, and prevents accidental updates or deletions of incomplete data if the bot encounters an error during run time.

Database package

Connect to Microsoft SQL Server with Windows authentication

Configure your device and the Connect action from the Database package to automate connecting to a Microsoft SQL Server with Windows NT authentication.

This task is applicable only for releases prior to Build 9664. Starting from Build 9664, you no longer have to add DLL files manually to connect to the Microsoft SQL Server.

To use Windows NT authentication for connecting to the Microsoft SQL Server, perform the following steps:

1. Download the JDBC driver for Microsoft SQL Server.

Download the JDBC Driver from Microsoft

2. In the unzipped folder, locate the .dll file in the `auth\x64\` file path.
3. If the .dll file has a different name, rename the file to `sqljdbc_auth.dll`.
4. On the Bot Creator or Bot Runner devices, copy the `sqljdbc_auth.dll` file to one of the following paths, depending on where you installed the Bot Agent and the option that you selected at the time of installation:

Note: If you are on Build 9664 or later, you do not have to copy the file to the location in which Bot Agent was installed.

- If you installed the Bot Agent at the user level and selected the **Only for me (username)** option, copy to `C:\Users\User Name\AppData\Local\Programs\Automation Anywhere\Bot Agent\jre\bin`.
- If you installed the Bot Agent at the system level and selected the **Anyone who uses this computer (all users)** option, copy to `C:\Program Files\Automation Anywhere\Bot Agent\jre\bin`.

This enables Windows authentication because the JDBC driver cannot perform the authentication by default.

5. Select the **Default** connection option.
6. Enter the connection string: `jdbc:sqlserver://localhost;databaseName=Test;integratedSecurity=true;`
7. Click **Save**.

Choose from the following:

- Use the **Read from** action to retrieve records from the database.

Using the Read from action

- If you are automating a task that involves making changes to the database, insert the **Begin database transaction** action.

This action ensures that all records are updated or deleted in their entirety, and prevents accidental updates or deletions of incomplete data if the bot encounters an error during run time.

Database package

Disconnect action

Use the Disconnect action in the Database package to disconnect from a database.

Settings

In the **Session name** field, enter the name of the session that you used to connect to the database server in the **Connect** action.

A record set is returned when you run a stored procedure or a query. To use the record set stored in the memory even if the session is disconnected, select **Keep database schema in cache until bot finishes running**. By using this option, you can enable the **Loop** action to iterate the record set by using cached schema after disconnecting from the database.

The Snowflake database using the ODBC driver is supported.

Using the Read from action

Use the **Read from** action to retrieve records from the database and save the retrieved data in a CSV file. This action enables you to retrieve up to one million records from the database.

To automate the task of selecting and saving a set of records, follow these steps:

1. Enter the name of the session you used to connect to the database server in the **Connect** action. You do not have to provide the details of the database server here because you have already associated those details with the session name when using the **Connect** action.
2. Enter the SELECT statement to specify the column and table names.

This field supports SQL syntax. For example, `SELECT CustomerName, City FROM Customers`

Note: CTE (Common Table Expression) is supported using `WITH` keyword in the SQL compliant databases such as Oracle and MySQL. For example,

```
WITH customers_in_usa AS (SELECT CustomerName, state FROM customers WHERE
country = 'USA')
SELECT cName FROM customers_in_usa WHERE state = 'LA' ORDER BY
CustomerName
```

3. Enter the maximum number of records to retrieve.
4. Optional: Enter a timeout value. When the specified time expires, the statement execution stops even if the execution is not completed.
5. Select the **Export data to CSV** option to save the retrieved data.
 - a) Select the file path from the **Bots** folder, the local device, or an existing file variable.
 - b) Select the CSV file encoding to be either **ANSI**, **UNICODE**, or **UTF8**.
 - c) Select whether to export the CSV file with or without the column headers.

With column headers

CustomerName	City
Manny	Pittsburgh
Kate	Los Angeles
John	Boston

Without column headers

Manny	Pittsburgh
Kate	Los Angeles
John	Boston

- d) Select this check box if you do not want a CSV file to be created when the SQL query does not return any data.
- e) Specify whether to overwrite the file or append the data to the existing file if a CSV file with the same name exists.

6. Click Save.

Using the Run stored procedure action

Stored procedures are a set of SQL statements that are created and stored in the database. These SQL statements might be complex and have to run multiple times. Use the **Run stored procedure** action to execute existing stored procedures.

Note:

- This action does not support Microsoft Access or SQLite database types.
- Starting from Automation 360 v.22 (Build 10526), for stored procedures, the limit of 32 characters for input and output parameters has been removed.

To automate the task of executing a stored procedure, follow these steps:

- 1.** Enter the name of the session you used to connect to the database server in the **Connect** action.
You do not have to provide the details of the database server here because you have already associated those details with the session name when using the **Connect** action.
- 2.** Enter the name of the stored procedure.

3. Optional: Click **Add parameter** to provide an input parameter or configure an output parameter. Select from the following parameter options:

Option	Steps
Input	<p>Parameter is passed from the bot to the stored procedure.</p> <ul style="list-style-type: none"> • Name: Enter the name of the parameter from the stored procedure. • Value (optional): Enter a value or select a variable. • Type: Select the data type from the following options <ul style="list-style-type: none"> • BIGINT (number) • BINARY (Boolean) • BIT (number) • CHAR (string) • DATE (date time) <p>Supported format yyyy-mm-dd</p> • DECIMAL (number) • DOUBLE (number) <p>Default choice for decimal values.</p> • FLOAT (number) • INTEGER (number) <p>Uses 4 bytes to store an integer with a value from -2,147,483,648 to 2,147,483,647</p> • LONGVARBINARY (Boolean) • LONGVARCHAR (string) • NUMERIC (number) • REAL (number) • SMALLINT (number) <p>Uses 2 bytes to store an integer with a value from -32,768 to 32,767</p> • TIME (date time) <p>Supported format hh:mm:ss</p> • TIMESTAMP (date time) <p>Supported format yyyy-mm-dd hh:mm:ss.f, where f is fractional seconds</p> • TINYINT (number) <p>Uses 1 byte to store an integer with a value from 0 to 255</p> • VARBINARY (Boolean) • VARCHAR (string) <p>For example, if running the example function from the Manage stored procedure action, configure the following two input parameters and values for the <code>sum_of_two</code> function to add:</p> <ul style="list-style-type: none"> • Parameter 1: num1, 5, TINYINT • Parameter 2: num2, 10, TINYINT

Option	Steps
Output	<p>Parameter is passed from the stored procedure to the bot.</p> <ul style="list-style-type: none"> • Name: Enter the name of the parameter from the stored procedure. • Type: Select the data type from the following options <ul style="list-style-type: none"> • BIGINT (number) • BINARY (Boolean) • BIT (number) • CHAR (string) • DATE (date time) <p>Supported format yyyy-mm-dd</p> • DECIMAL (number) • DOUBLE (number) <p>Default choice for decimal values.</p> • FLOAT (number) • INTEGER (number) <p>Uses 4 bytes to store an integer with a value from -2,147,483,648 to 2,147,483,647</p> • LONGVARBINARY (Boolean) • LONGVARCHAR (string) • NUMERIC (number) • REAL (number) • SMALLINT (number) <p>Uses 2 bytes to store an integer with a value from -32,768 to 32,767</p> • TIME (date time) <p>Supported format hh:mm:ss</p> • TIMESTAMP (date time) <p>Supported format yyyy-mm-dd hh:mm:ss.f, where f is fractional seconds</p> • TINYINT (number) <p>Uses 1 byte to store an integer with a value from 0 to 255</p> • VARBINARY (Boolean) • VARCHAR (string) <p>When the bot runs, the action converts the database data type to an Automation 360-supported data type.</p> <p>For example, if running the example <code>sum_of_two</code> function from the Manage stored procedure action, configure the output parameter: <code>sum, TINYINT</code>.</p>

Option	Steps
InputOutput	<p>Parameter can be used for both input and output.</p> <ul style="list-style-type: none"> • Name: Enter the name of the parameter from the stored procedure. • Value (optional): Enter a value or select a variable. • Type: Select the data type from the following options <ul style="list-style-type: none"> • BIGINT (number) • BINARY (Boolean) • BIT (number) • CHAR (string) • DATE (date time) Supported format yyyy-mm-dd • DECIMAL (number) • DOUBLE (number) Default choice for decimal values. • FLOAT (number) • INTEGER (number) Uses 4 bytes to store an integer with a value from -2,147,483,648 to 2,147,483,647 • LONGVARBINARY (Boolean) • LONGVARCHAR (string) • NUMERIC (number) • REAL (number) • SMALLINT (number) Uses 2 bytes to store an integer with a value from -32,768 to 32,767 • TIME (date time) Supported format hh:mm:ss • TIMESTAMP (date time) Supported format yyyy-mm-dd hh:mm:ss.f, where f is fractional seconds • TINYINT (number) Uses 1 byte to store an integer with a value from 0 to 255 • VARBINARY (Boolean) • VARCHAR (string)

4. Enter the maximum number of records to retrieve.

You can limit the results of the execution.

5. Optional: Enter a timeout value.

When the specified time expires, the statement execution stops even if the execution is not completed.

6. Optional: Select the **Export data to CSV** option to save the retrieved data.

Note: The **Export data to CSV** option does not support Oracle Database or PostgreSQL Server database types. Use output parameters to retrieve values.

- Select the file path from the **Bots** folder, the local device, or an existing file variable.
- Select the CSV file encoding to be either **ANSI**, **UNICODE**, or **UTF8**.
- Select whether to export the CSV file with or without the column headers.

With column headers

CustomerName	City
Manny	Pittsburgh
Kate	Los Angeles
John	Boston

Without column headers

Manny	Pittsburgh
Kate	Los Angeles
John	Boston

- Specify whether to overwrite the file or append the data to the existing file if a CSV file with the same name exists.

7. Optional: Select a dictionary variable to hold the output if the stored procedure returns a value. Each output parameter name is a dictionary key which holds the corresponding parameter value. For example, if you assign the `sum_of_two` function output to `$Output$`, when the bot calls `$Output{sum}$`, the variable returns 15.

Note: If you do not know the output parameter name, use the default key `Output` appended by the parameter index number.

8. Click **Save**.

Using the Export to data table action

Use the **Export to data table** action to retrieve records from the database and store the retrieved data in a table variable.

To automate the task of selecting and saving a set of records, follow these steps:

- Enter the name of the session you used to connect to the database server in the **Connect** action. You do not have to provide the details of the database server here because you have already associated those details with the session name when using the **Connect** action.
- Enter the SELECT statement to specify the column and table names.

This field supports SQL syntax. For example, `SELECT CustomerName, City FROM Customers`

Note: CTE (Common Table Expression) is supported using `WITH` keyword in the SQL compliant databases. For example, `WITH customers_in_usa AS (SELECT CustomerName, state FROM`

```
customers WHERE country = 'USA') SELECT cName FROM customers_in_usa WHERE
state = 'LA' ORDER BY CustomerName
```

3. Enter the maximum number of records to retrieve.
4. Optional: Enter a timeout value.
When the specified time expires, the statement execution stops even if the execution is not completed.
5. In the **Assign to** option, select the table variable to store the retrieved data.
6. Click **Save**.

Manage stored procedure action

Use the Manage stored procedure action in the Database package to create, update, and delete a stored procedure within the specified database. A stored procedure is SQL code saved to the database, enabling you to run it repeatedly.

Settings

- In the **Session name** field, enter the name of the session that you used to connect to the database server in the **Connect** action.
- In the **Enter full command** field, enter the command to create, update, or delete the stored procedure. You can specify input and output parameters for the command; you provide values or variables holding the values in the **Run stored procedure** action.

Recommended: Declare a delimiter and use it to close the SQL statement.

MySQL example: In this example, the bot checks if there is a procedure in the database named `sum_of_two`. If not, the bot creates a procedure that accepts two input parameters (`num1` and `num2`), adds them together, and produces the sum as the output parameter:

```
DROP PROCEDURE IF EXISTS sum_of_two;
DELIMITER $$
CREATE PROCEDURE sum_of_two(IN num1 INT,IN num2 INT,OUT sum INT)
BEGIN
SET sum := num1 + num2;
END
$$
```

- In the **Timeout for the query in seconds** field, specify the time within which the statement execution should stop, even if the execution is not completed.

Insert/Update/Delete action

Use the Insert/Update/Delete action in the Database package to execute an INSERT, UPDATE, or DELETE statement from the database.

Settings

- In the **Session name** field, enter the name of the session that you used to connect to the database server in the **Connect** action.

- In the **Statement** field, enter the SQL statement to insert, update, or delete the records.
 - Use an INSERT statement to create new records in a table:

```
INSERT INTO table_name (column1, column2, column3, ...)
VALUES (value1, value2, value3, ...)
```

- Use an UPDATE statement to modify a record:

```
UPDATE table_name
SET column1 = value1, column2 = value2, ...
WHERE condition
```

- Use a DELETE statement to remove a record:

```
DELETE FROM table_name WHERE condition
Example: DELETE FROM Persons WHERE LastName='Smith'
```

- In the **Timeout for the query in seconds** field, specify the time within which the statement execution should stop, even if the execution is not completed.

Example of migrating data from Excel to a database

In this example, you build a bot to transfer values from an Excel spreadsheet to a database using actions from the Database, Excel advanced, and Loop packages.

Before you start building your bot, create the following:

- Create an Excel spreadsheet with the following values and save it (For example: *Test_migration_db.xlsx*)

John	Williams	jwilliams@cmail.com
Sam	Li	sam.li@xyz.org
Carl	Miller	carl@carlmillerllc.com

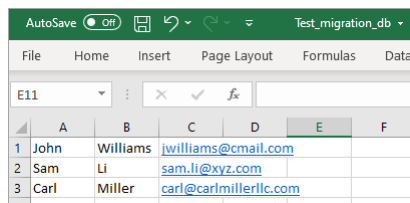

The screenshot shows an Excel spreadsheet with the following data:

	A	B	C	D	E	F
1	John	Williams	jwilliams@cmail.com			
2	Sam	Li	sam.li@xyz.com			
3	Carl	Miller	carl@carlmillerllc.com			

- Create an Access database table named *CustomerT* with the following columns: (create a database similar to the image below and save it - for example: save it as *Test_Migration_db.accdb*)
 - FirstName
 - LastName
 - Email

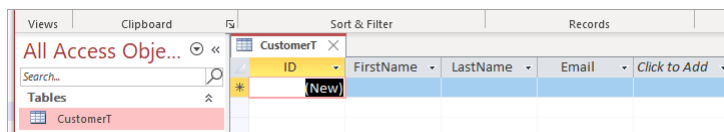

The screenshot shows the Microsoft Access interface with the following table structure:

ID	FirstName	LastName	Email	Click to Add
(New)				

To migrate values from a spreadsheet to a table in a database, perform the following steps:

1. Create a new bot:
 - a) On the left panel, click **Automation**.
 - b) Click **Create new > Bot**.
 - c) In the **Create Task Bot** window, enter the bot name.
 - d) Accept the default folder location: `\Bots\`
To change the default bot storage location, click **Choose** and follow the prompts.
 - e) Click **Create and edit**.
2. Open the spreadsheet:
 - a) Double-click or drag the **Excel advanced > Open** action .
 - b) Click **Browse** to provide the file path.

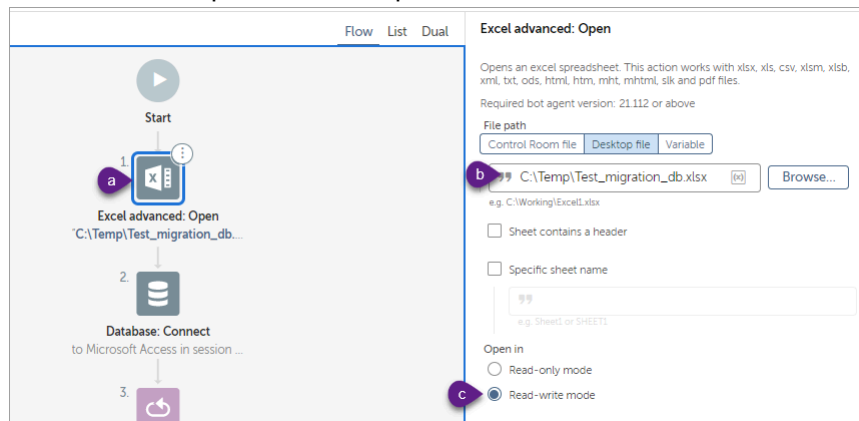

- c) Select the option to open the file in **Read-write**.
3. Connect to the database:
 - a) Double-click or drag the **Database > Connect** action.
 - b) Select the **User defined** connection mode.

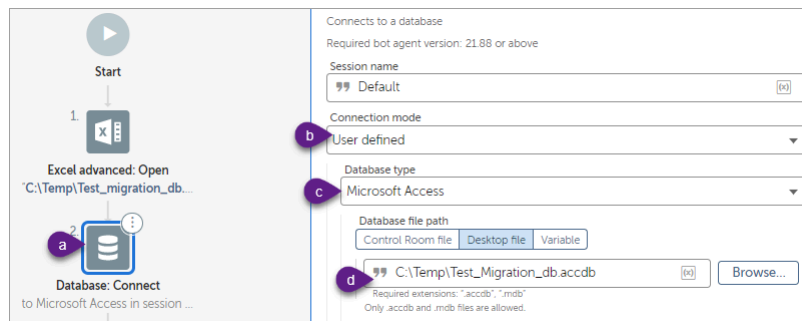

- c) Select the **Microsoft Access** database type.
 - d) Click **Browse** to provide the file path.

4. Insert the Excel values into the database, row by row:
 - a) Double-click or drag the **Loop** action.
 - b) Select the **Excel advanced > For each row in worksheet** iterator.
 - c) Select **All rows** from the **Loop through** drop-down.

The screenshot displays the configuration for a Loop action in Automation Anywhere. On the left, a workflow diagram shows a sequence of actions: a Loop action (3) containing a Database action (4) and an Excel advanced action (6). The right pane shows the configuration for the Loop action, including the Loop Type (Iterator), Loop through (All rows), Read option (Read visible text in cell), Session name (Default), and Assign the current value to this variable (rExcelCurrentRow).

- d) In the Assign the current value to this variable, create the record variable `rExcelCurrentRow`.
- e) Drag the **Database > Insert/Update/Delete** action into the Loop container.
- f) Enter the following SQL statement:

```
INSERT INTO CustomerT (FirstName,LastName,Email) values
('{$rExcelCurrentRow[0]}','{$rExcelCurrentRow[1]}','{$rExcelCurrentRow[2]}');
```

The screenshot displays the configuration for a Database action in Automation Anywhere. The left pane shows a workflow diagram with a Loop action (3) containing a Database action (4) and an Excel advanced action (6). The right pane shows the configuration for the Database action, including the Statement (INSERT INTO CustomerT (FirstName,LastName,Email) values ({\$rExcelCurrentRow[0]}, {\$rExcelCurrentRow[1]}, {\$rExcelCurrentRow[2]});) and Timeout for the query in seconds (optional).

5. Disconnect from the database. Drag the **Database > Disconnect** action below the Loop container.
6. Close the spreadsheet. Double-click or drag **Excel advanced > Close Spreadsheet** action.
7. Click **Save**.

Related reference

[Database package](#)

Databases support internal operations of an enterprise by storing a variety of data, such as sales transactions, product catalogs, inventories, and customer profiles. Use the Database package to connect to a database, begin a transaction, and manipulate the stored data by retrieving, inserting, updating, deleting, and exporting it to a CSV file.

Excel advanced package

The Excel advanced package contains actions that enable you to automate many of the repetitive tasks when working with Microsoft Excel spreadsheets.

Loop package

Use the Loop package to run a sequence of actions repeatedly for a specific number of times or until a specific condition is met.

Database server support matrix

Refer to the list of databases supported in Automation 360

Following is the list of supported database server with **JDBC** connectivity.

Databas action	MS SQL server	MS access	Postgre! Server	My SQL	Excel	Text	CSV	Oracle	AWS RDS	Microsoft Azure
Connect	Y	Y	Y	Y	N	N	N	Y	Y	Y
Disconnect	Y	Y	Y	Y	N	N	N	Y	Y	Y
Read from	Y	Y	Y	Y	N	N	N	Y	Y	Y
Run stored procedure	Y	n/a	Y	Y	n/a	n/a	n/a	Y	Y	Y
Export to data table	Y	Y	Y	Y	N	N	N	Y	Y	Y
Managed stored procedure	Y	n/a	Y	Y	n/a	n/a	n/a	Y	Y	Y
Insert/ Update / Delete	Y	Y	Y	Y	N	N	N	Y	Y	Y
Begin database transaction	Y	n/a	Y	Y	n/a	n/a	n/a	Y	Y	Y
End database transaction	Y	n/a	Y	Y	n/a	n/a	n/a	Y	Y	Y

Following is the list of supported database server with **ODBC** connectivity.

Databa action	MS SQL server	MS access	Postgre! Server	My SQL	Excel	Text	CSV	Snowfl!	Oracle	AWS RDS	Microsoft Azure
Connect	Y	Y	Y	Y	Y	Y	Y	Y	Y	Y	Y
Disconnect	Y	Y	Y	Y	Y	Y	Y	Y	Y	Y	Y

Database action	MS SQL server	MS access	PostgreSQL	MySQL	Excel	Text	CSV	Snowflake	Oracle	AWS RDS	Microsoft Azure
Read from	Y	Y	Y	Y	Y	Y	Y	Y	Y	Y	Y
Run stored procedure	Y	n/a	Y	Y	n/a	n/a	n/a	n/a	Y	Y	Y
Export to data table	Y	Y	Y	Y	N	N	N	-	Y	Y	Y
Managed stored procedure	N	n/a	N	N	n/a	n/a	n/a	n/a	N	N	N
Insert/Update/Delete	Y	Y	Y	Y	Y	Y	Y	Y	Y	Y	Y
Begin database transaction	N	n/a	N	N	n/a	n/a	n/a	N	N	N	N
End database transaction	N	n/a	N	N	n/a	n/a	n/a	N	N	N	N

- Y: Supported
- N: Not supported
- n/a: Not applicable

Datetime package

A datetime value consists of a date, time, and time zone. RPA Workspace stores datetime values in a Datetime variable. The **Datetime** package contains actions that enable you to perform various operations on datetime values. You can use these actions to manipulate and compare values in the Datetime variables.

Actions in the Datetime package

You can enter either a **String** or a **Global** variable for any of the actions in the Datetime package. The actions then assign the output to a variable.

The actions in the **Datetime** package accept a variable as an input and assign the output to a variable. These actions enable you to compare two Datetime values, add to or subtract from a Datetime value, and convert a Datetime value to a string value.

The **Datetime** package includes the following actions:

Action	Description
Add	See Using the Add action .

Action	Description
Assign	See <i>Using the Assign action</i> .
Is after	<p>Compares two Datetime variables and verifies if the value of the source variable is after the value available in the comparison variable, and stores the output to a Boolean variable.</p> <ul style="list-style-type: none"> • Select the Variable option and from the Source date and time variable and then select either the Datetime or Variable option. Use the Datetime option to enter the Date and Time. Use the Variable option to select the global value. • Select the source variable from the Source date and time variable list, and select the variable you want to compare with from the Date and time variable to be compared to list. • Select the Datetime variable from the Assign the output to a variable list to specify the variable you want to use to assign the output. <p>For example, if the value in the source variable is after the value in the comparison variable, the system stores <code>True</code> as the output in the Boolean variable. If the value in the source variable is not after the value in the comparison variable, the system stores <code>False</code> as the output in the Boolean variable.</p>
Is before	<p>Compares two Datetime variables and verifies if the value of source variable is before the value available in the comparison variable, and stores the output to a Boolean variable.</p> <ul style="list-style-type: none"> • Select the source variable from the Source date and time variable list, and select the variable you want to compare with from the Date and time variable to be compared to list. • Select the Datetime variable from the Assign the output to a variable list to specify the variable you want to use to assign the output. <p>For example, if the value in the source variable is before the value in the comparison variable, the system stores <code>True</code> as the output in the Boolean variable. If the value in the source variable is not before the value in the comparison variable, the system stores <code>False</code> as the output in the Boolean variable.</p>

Action	Description
Is equal	<p>Compares two Datetime variables and verifies if the value of the source variable is equal to the value available in the comparison variable, and stores the output to a Boolean variable.</p> <ul style="list-style-type: none"> • Select the source variable from the Source date and time variable list, and select the variable you want to compare with from the Date and time variable to be compared to list. • Select the Datetime variable from the Assign the output to a variable list to specify the variable you want to use to assign the output. <p>For example, if the value in the source variable is equal to the value in the comparison variable, the system stores <code>True</code> as the output in the Boolean variable. If the value in the source variable is not equal to the value in the comparison variable, the system stores <code>False</code> as the output in the Boolean variable.</p>
Subtract	See Using the Subtract action .
To string	See Using the To string action .

Related reference

[Datetime formats](#)

Specify a custom format when you convert a datetime value to a string value by using the predefined formats available in RPA Workspace.

Using the Add action

Use the **Add** action to increase the value in the Datetime variable by a specified time value and unit. For example, you can use this action to increase the Datetime variable value by three hours or by three days.

To add a value to a Datetime variable, do the following:

1. Double-click or drag the **Add** action from the **Datetime** node in the **Actions** palette.
2. Select an option from the **Source date and time variable** list to specify the variable that contains the value to which you want to add the time unit.
3. Enter the value you want to add in the **Time value to add** field.

4. Select an option from the **Time unit to add** list to specify the time unit you want to add.

Choose from the following time unit options:

- Milliseconds
- Seconds
- Minutes
- Hours
- Days
- Weeks
- Months
- Years

Note: This action accounts for leap years. For example, if the action adds 28 days to February 1, 2020, the action output is February 29, 2020. Whereas, if the action adds 28 days to February 1, 2019, the action output is March 1, 2019.

5. Select the Datetime variable from the **Assign the output to a variable** list to specify the variable to which you want to assign the output.
6. Click **Save**.

To see the output value, convert the value in the Datetime variable to a String variable, then print the value with the **Message Box** action. For more information, see [Using the To string action](#) and [Using the Message box action](#).

Using the Assign action

Use the **Assign** action to assign a String variable with a selected datetime format, assign a datetime value manually, or assign an existing Datetime variable into a Datetime variable.

To assign values to a Datetime variable, perform the following steps:

1. Double-click or drag the **To string** action from the **Datetime** node in the **Actions** palette.
2. Select either the **Enter the date time** or **Variable** option.

- If you selected the **Enter the date time** option, perform the following steps:
 - a. Enter the date time values or select a String variable.

Note: To enter multiple variables, separate them with single quotation marks. For example, to input the variables *date1* and *time1*, enter the following: 'date1"time1'

- b. Select the date time format.

Choose from the prebuilt formats or provide a custom format. For more information about the prebuilt formats, see [Datetime formats](#).

- If you selected the **Variable** option, choose either the **Datetime** option or the **Variable** option.
 - Use the **Datetime** option if you want to select the date, time, and timezone manually.
 - Use the **Variable** option if you want to select the Datetime variable or other variables that can have Datetime as a subtype, such as the Dictionary, Record, and list variables.
3. Select the variable to use to store the output from the **Destination Datetime variable** list.
 4. Click **Save**.

Using the Subtract action

Use the **Subtract** action to decrease the value in the Datetime variable by a specified time value and unit. For example, you can use this action to decrease the Datetime variable value by three hours or by three days.

To subtract a value from a Datetime variable, do the following:

1. Double-click or drag the **Subtract** action from the **Datetime** node in the **Actions** palette.
2. Select an option from the **Source date and time variable** list to specify the variable that contains the value from which you want to subtract the time unit.
3. Enter the value you want to subtract in the **Time value to add** field.
4. Select an option from the **Time unit to add** list to specify the time unit you want to subtract.

Choose from the following time unit options:

- Milliseconds
- Seconds
- Minutes
- Hours
- Days
- Weeks
- Months
- Years

Note: This action accounts for leap years. For example, if the action subtracts 31 days from March 31, 2020, the action output is February 29, 2020. Whereas, if the action subtracts 31 days from March 31, 2019, the action output is February 28, 2019.

5. Select the Datetime variable from the **Assign the output to a variable** list to specify the variable to which you want to assign the output.
6. Click **Save**.

To see the output value, convert the value in the Datetime variable to a String variable, then print the value with the **Message Box** action. For more information, see [Using the To string action](#) and [Using the Message box action](#).

Using the To string action

Use the **To string** action to convert a datetime value to a string value. This action enables you to select a predefined format or specify a custom format for the output value.

You can select a predefined format for datetime or provide a custom format based on your requirements. See [Datetime formats](#).

To convert a datetime value to string, do the following:

1. Double-click or drag the **To string** action from the **Datetime** node in the **Actions** palette.
2. Select an option from the **Source date and time variable** list to specify the variable that contains the datetime value that you want to convert to a string value.
3. Select an option from the **Formats** list to specify the predefined format in which you want to store the string value.
4. Select the **Custom format** to specify a custom format based on your requirement.

[Datetime formats](#)

5. Select the string variable that you want to use to store the converted value from the **Assign the output to a variable** list.

6. Click **Save**.

Datetime formats

Specify a custom format when you convert a datetime value to a string value by using the predefined formats available in RPA Workspace.

The **To string** action enables you to convert a datetime value to a string value. This action also enables you to select a predefined datetime format or specify a custom format.

Predefined datetime format

When you convert a datetime value to a string value, the predefined datetime formats are available in the **Formats** list. The following predefined datetime formats are available:

- **BASIC_ISO_DATE**: Converts the datetime value to a `yyyymmdd+offset value` string value.
- **ISO_LOCAL_DATE**: Converts the datetime value to a `yyyy-mm-dd` string value.
- **ISO_OFFSET_DATE**: Converts the datetime value to a `yyyy-mm-dd+offset value` string value. The offset value indicates the difference between the local time and UTC in hours and minutes.
- **ISO_DATE**: Converts the datetime value to a `yyyy-mm-dd+offset value` or `yyyy-mm-dd` string value. The system adds an offset value if it is available.
- **ISO_LOCAL_TIME**: Converts the datetime value to a `hh:mm:ss.SSS` string value.
- **ISO_OFFSET_TIME**: Converts the datetime value to a `hh:mm:ss.SSS+offset value` string value. The offset value indicates the difference between the local time and UTC in hours and minutes.
- **ISO_TIME**: Converts the datetime value to a `hh:mm:ss.SSS`, or `hh:mm:ss.SSS+offset value` string value. The offset value indicates the difference between the local time and UTC in hours and minutes.
- **ISO_LOCAL_DATE_TIME**: Converts the datetime value to a `yyyy-mm-ddThh:mm:ss.SSS` string value.
- **ISO_OFFSET_DATE_TIME**: Converts the datetime value to a `yyyy-mm-ddThh:mm:ss.SSS+offset value` string value. The offset value indicates the difference between the local time and UTC in hours and minutes.
- **ISO_ZONED_DATE_TIME**: Converts the datetime value to a `yyyy-mm-ddThh:mm:ss.SSS+offset value[zone id]` string value. The offset value indicates the difference between the local time and UTC in hours and minutes. The 'zone id' in the format represents the time zone.
- **ISO_DATE_TIME**: Converts the datetime value to a `yyyy-mm-ddThh:mm:ss.SSS`, `yyyy-mm-ddThh:mm:ss.SSS+offset value`, or `yyyy-mm-ddThh:mm:ss.SSS+offset value[zone id]` string value.
- **ISO_ORDINAL_DATE**: Converts the datetime value to a `yyyy-[day of the year]`, or `yyyy-[day of the year]+offset value` string value. For example, if the datetime value is 'January 25, 2018', it is formatted as '2018-25' where '25' indicates the day of the year.
- **ISO_WEEK_DATE**: Converts the datetime value to a `yyyy-[week of the year]-[day of the week]`, or `yyyy-[week of the year]-[day of the week]+offset value` string value. For example, if the datetime value is 'January 25, 2018', it is formatted as '2018-W4-4' where 'W4' indicates that it is the fourth week of the year and '4' indicates the day of that week.
- **ISO_INSTANT**: Converts the datetime value to a `yyyy-mm-ddThh:mm:ss.SSSZ` string value.
- **RFC_1123_DATE_TIME**: Converts the datetime value to a `[day of the week], [day of the month] [month in 'MMM' format] [year in 'YYYY' format] hh:mm:ss`, or `[day of the week], [day of the month] [month in 'MMM' format] [year in 'YYYY' format] hh:mm:ss+offset value` string value. For example, if the datetime value is '2018-01-25 10:15', it is formatted as 'Thu, 25 December 2018 10:15:00GMT'. The 'GMT' indicates that there is no offset available.

Custom datetime format

Use predefined conventions to specify a custom datetime format. The following conventions are available:

Note: All predefined conventions that are used to specify a custom datetime format are case-sensitive.

- 'y': Specify a year as 'yy' or 'yyyy'.
- 'M': Specify a month as 'M', 'MM', 'MMM' (abbreviated name of the month, for example, Jan, Feb), or 'MMMM' (full name of the month, for example, January, February).

Note: The 'MMM' and 'MMMM' datetime formats work depending on the operating system on which the Bot Agent runs and your location setting.

- 'd': Specify a day as 'd' or 'dd'.
- 'D': Specify a day in a year as 'D' or 'DD'.
- 'E': Specify day of the week as 'EEE' (Sun-Sat) or 'EEEE' (Sunday-Saturday).

Note: The 'EEE' and 'EEEE' datetime formats work depending on the operating system on which the Bot Agent runs and your location setting.

- 'h' or 'H': Specify an hour as 'hh' or 'HH'.

Note: HH is a 24-hour time format, and hh is a 12-hour time format with AM or PM. When you use the hh format, add *a* at the end of the datetime format. For example, if the system locale language is English, the input will be 2018-12-25 10:50:55.999 AM and the format will be yyyy-MM-dd hh:mm:ss.SSS *a* where *a* indicates AM or PM. However, on computers that use operating systems in languages other than English, use AM or PM marker accordingly. For example, on a Japanese language operating system, the input must have AM or PM marker in Japanese, such as 2018-12-25 10:50:55.999 午前, where 午前 means AM in Japanese, and the format must be yyyy-MM-dd hh:mm:ss.SSS *a*.

- 'a': Specify an AM/PM marker for the 12-hour time format
- 'm': Specify a minute in an hour as 'mm'.
- 's': Specify a second in a minute as 'ss'.
- 'S': Specify a millisecond as 'SSS'.
- 'z': Specify a timezone, such as 'Pacific Standard Time' and 'Indian Standard Time'.
- 'Z': Specify an offset time for a timezone, such as '+0550' for 'Indian Standard Time'.

Important: On computers where the display language is set to Simplified Chinese or Traditional Chinese, when you use the dd-MMM-yyyy custom datetime format to convert a datetime value to a string value, the output might show incorrectly.

You can use the preceding convention to specify the custom format that you want to use for converting a datetime value. Some examples that use the preceding convention are as follows:

Format	Sample output
yyyy-MM-dd	2018-09-30
yyyy-M-d	2020-9-8
dd-MM-yyyy	25-12-2018
yyyy-MM-dd HH:mm:ss	2018-25-12 23:50:55
hh:mm:ss.SSS a	10:15:35.889 AM / 10:15:35.889 PM

yyyy-MM-dd HH:mm:ss.SSS	2018-12-25 23:50:55.999
yyyy-MM-dd HH:mm:ss.SSS Z	2018-12-25 23:50:55.999 +0530
h.mm a	4.10 PM
D 'days', yyyy	365 days, 2019

Delay package

Use the **Delay** package to add a timed delay to the logic.

You can use timed delay to add the amount of time a bot waits before moving to the next task. You can specify the amount of time in milliseconds or seconds.

Note: You can specify a maximum time delay of 9999999 milliseconds or seconds.

Example: If we give a timed delay of 5 seconds, the bot will wait for 5 seconds and then execute the action following the delay.

The **Delay** package includes the following action:

Action	Description
Delay	<p>Adds a timed delay.</p> <ul style="list-style-type: none"> • Select the delay type as Regular or Random. • Select the Regular option to delay the operation for a fixed period of time. • If you select Random, specify the time range in the From and To fields for the system to select a random delay within the specified range. <p>You can add Random delay with different waiting time for each bot run at a given command level without having to change the bot.</p> <p>Example: Use Random delay when running bots simultaneously on several machines through a workload management queue before executing a database or recorder, or the FTP action. This would reduce the number of concurrent requests made to a database or the FTP server and the performance of the systems will not be adversely impacted.</p> <ul style="list-style-type: none"> • Select the time units in seconds or milliseconds.

Dictionary package

The **Dictionary** package contains actions that enable you to do various operations on dictionary-type values.

Dictionary data type

A dictionary is a collection of key-value pairs, in which each key has a value. It is similar to an entry in a dictionary, where each word has a corresponding definition or explanation. The key is similar to the word, and the definition or explanation is similar to its value. The properties of dictionary entries are as follows:

- Keys are unique within each dictionary variable. If you try to duplicate a key, you will overwrite its value.
- Key names cannot be changed.
- Keys are case-sensitive.
- Keys can contain leading and trailing whitespaces.

Each key-value pair in a dictionary is separated by a colon. The key-value pairs are separated from each other by commas. An example of a dictionary is as follows:

```
invoice = {'CustomerID': 9876, 'Location': 'XYZ', 'Amount': 12,34,567}
```

In the example, 'CustomerID', 'Location', and 'Amount' are keys, and the corresponding value assigned to each key is separated by a colon.

Working with variables of dictionary data type

A dictionary variable can hold values of boolean, number, or string data subtype. When initializing a dictionary variable, you can select the **Any** data subtype in order to hold any of the three data subtypes. You can manually enter values by creating a new variable or selecting an existing one from the Variables menu, and then clicking **Add**.

Use a dictionary variable to hold *email* or *PDF* properties.

Actions in the Dictionary package

The following actions are available:

Action	Description
Assign	<p>Assigns the value of the source dictionary to the destination dictionary variable.</p> <ul style="list-style-type: none"> • Select the source dictionary variable from the drop-down list or create a new dictionary variable. • Select a variable or create one to hold the output.
Get	<p>Verifies whether a key exists in a dictionary variable and returns the corresponding value.</p> <ul style="list-style-type: none"> • Select the dictionary variable from the drop-down list. • Enter the key name. • Select a dictionary variable or create one to hold the output.

Action	Description
Put	<p>Assigns a value to a key in the dictionary. If the key is already associated with a value, the value can be updated.</p> <ul style="list-style-type: none"> • Select the dictionary variable from the drop-down list. • Enter the key name. • Assign a value to the key. <p>You can choose the Static value tab to add the values manually or the Variable tab to add the existing variables.</p> <hr/> <p>Note: If you choose the Static value option, ensure that the data type of static value matches the subtype of the dictionary variable. Otherwise, you might encounter type cast errors when you use the dictionary variables.</p> <hr/> <ul style="list-style-type: none"> • Select the variable to hold the previous value.
Remove	<p>Removes a value from the specified key. The removed value is assigned to a variable selected from the Assign removed item to variable list.</p> <p>Removes a value from the specified key and optionally assigns it to a variable selected from the Assign removed item to variable list.</p> <ul style="list-style-type: none"> • Select the dictionary variable from the drop-down list. • Enter the key name. • Select the variable to hold the removed value.
Size	<p>Retrieves the number of entries in the dictionary specified in the Dictionary variable field and assigns the output to a number variable selected from the Assign the output to variable list.</p>

Related tasks

[Example of passing a value between bots](#)

Learn how to pass a value from one TaskBot to another by using a dictionary variable.

DLL package

A dynamic-link library (DLL) file contains a shared library of functions that can be used by Windows programs. The **DLL** package uses a `.dll` file as reference and calls functions from the bot.

Before you start

Perform the following actions within the **DLL** package as part of using the set of available actions:

Note:

- Only the DLLs built using the Microsoft .NET Framework are supported.
- The Run DLL package is compatible with the following versions of Microsoft .NET: 4.6, 4.7, and 4.8.
- When you create a bot and use the local session with loop, ensure that you use the close session action in the bot. If you do not use the close session command, then the local session will open

AutomationAnywhere.ManagedDLLWrapper.exe with each iteration of the loop. As a result, you will run out of memory space and the bot will fail.

Important: If you use different versions of the DLL package in a parent bot and a child bot, the capability to share a session across bots is currently not supported. To share a session across parent and child bots, ensure that you use the same version of the package in both the parent and child bots.

1. Use the **Open** action to specify the location of the .dll file you want to use and session name. Use this same session name for the other actions. The .dll referenced is automatically added as a bot dependency.
2. Use the **Run function** action to run a function from the .dll and save its output value as a variable.
3. After running the required functions, close the .dll reference. It is important to close the .dll reference to free the memory of the operating system.

Windows and appropriate versions of Microsoft .NET Framework are available on the devices running the DLLs.

To review the bot launcher logs, navigate to C:\ProgramData\AutomationAnywhere\BotRunner\Logs\\Bot_Launcher-<today's date>.log.zip. Each zipped folder contains a file with data on the code execution, which is useful for debugging.

Note: If the .dll file uses .NET functions or classes from another .dll file, you must add the second .dll file as a manual dependency of the bot.

Bot dependencies

When you import multiple DLLs that have one main DLL and other DLLs are referenced from it, ensure you have all the DLLs in one folder. Also, the referenced DLLs must be called using a session name that is different from the name used in the main DLL. Your bot execution will fail if the same session name is used in both the main and the referenced DLLs.

Actions in the DLL package

The **DLL** package includes the following actions:

Action	Description
Close	See Close action
Open	See Open action

Action	Description
Run function (Legacy)	<p>See Using the Run function action.</p> <hr/> <p>Note:</p> <ul style="list-style-type: none"> The Run function (Legacy) action is no longer available in the Run DLL package. We recommend that you use the Run Function action from the Run DLL package because this action is an improved version of the Run function (Legacy) action. <p>Note that existing bots that use the Run function (Legacy) will continue to run successfully without any issues.</p> <ul style="list-style-type: none"> This action is called Run function (Legacy) starting from Enterprise A2019.16. The action is called Run function in Enterprise A2019.15 and previous releases. <hr/>
Run function	See Using the Run function action .

Supported data types in DLL functions

The following table list the variables and data types that you can use as an input or output parameter in DLL functions.

Note: The **Run function** and **Run function (Legacy)** actions do not support any user-defined data types in the **Parameter to the function** or **Assign output to variable** field.

Variable type as input or output parameters	Supported data types in .NET
String	<ul style="list-style-type: none"> Char Byte String string SByte
Number	<ul style="list-style-type: none"> UInt16 Int16 UInt32 Int32 UInt64 Int64 Int Single Decimal Float Double
Boolean	<ul style="list-style-type: none"> Boolean bool

Variable type as input or output parameters	Supported data types in .NET
Datetime	<ul style="list-style-type: none"> • Datetime
List	<ul style="list-style-type: none"> • UInt16[] • Int16[] • Int32[] • Int64[] • Int[] • Char[] • Single[] • Decimal[] • Float[] • Double[] • Boolean[] • bool[] • Byte[] • String[] • Datetime[] • List<UInt16> • List<Int16> • List<Int32> • List<Int64> • List<Int> • List<Char> • List<Single> • List<Decimal> • List<Float> • List<Double> • List<Boolean> • List<bool> • List<Byte> • List<String> • List<Datetime> • List<SByte> • List<UInt32> • List<UInt64> <hr/> <p>Note: The C# IList data type is not supported and does not work with the Automation 360 List data type.</p> <hr/>

Variable type as input or output parameters	Supported data types in .NET
Table	<ul style="list-style-type: none">• UInt16[,]• Int16[,]• Int32[,]• Int64[,]• Int[,]• Char[,]• Single[,]• Decimal[,]• Float[,]• Double[,]• Boolean[,]• bool[,]• Byte[,]• String[,]• Datetime[,]• Byte[,]• UInt32[,]• UInt64[,] <hr/> <p>Note: The Table type variable is equivalent to a two-dimensional array type variable in .NET.</p> <hr/>

Variable type as input or output parameters	Supported data types in .NET
Dictionary	<ul style="list-style-type: none"> • Dictionary<String,UInt16> • Dictionary<String,Int16> • Dictionary<String,Int32> • Dictionary<String,Int64> • Dictionary<String,Int> • Dictionary<String,Char> • Dictionary<String,Single> • Dictionary<String,Decimal> • Dictionary<String,Float> • Dictionary<String,Double> • Dictionary<String,Boolean> • Dictionary<String,bool> • Dictionary<String,Byte> • Dictionary<String,String> • Dictionary<String,Datetime> • Dictionary<Int,String> • Dictionary<Decimal,String> • Dictionary<Boolean,String> • Dictionary<String,SByte> • Dictionary<String,UInt32> • Dictionary<String,UInt64> <hr/> <p>Note: When creating the .Net DLL function, use the IDictionary data type instead of the Dictionary data type.</p>

Related tasks

[Example of using the DLL package](#)

Build a very simple DLL that will generate a message. Create a bot to run the DLL.

Close action

The Close action in the DLL package enables you to close the DLL reference.

Settings

Closes the current session. In the **Session name** field, enter the name of the session.

Open action

The Open action in the DLL package enables you to open the reference file.

Settings

- In the **File path** field, specify the location of the path.
- Select any of the following tabs to specify the location of the DLL you want to use:
 - **Control Room file:** Use a DLL that is available in the Control Room.

- **Desktop file:** Use a DLL that is available on a device.
- **Variable:** Use a file variable to specify the location of the DLL.
- Select any of the following tabs to create a DLL session:
 - **Local session:** Specify a session name that can be used only in the current bot.
 - **Global session:** Specify a session name that can be used across multiple bots such as parent bots, child bots, and other child bots of the parent bots.
See [Sharing sessions across bots](#).
 - **Variable:** Specify a session variable that can be used to share that session with other child bots.
When you run the bot, it passes the session variable to the child bot, which enables the child bot to use the DLL opened in the parent bot.

Note: The DLL package supports only DLLs written in C#.

Sharing sessions across bots

You can share a session across multiple bots so that you can use the same DLL, Microsoft Excel worksheet, and terminal across these bots. You can share a session across child bots, parent bots, and other child bots of the parent bots.

Use the **Global session** option in the **Open** action of the DLL package to pass on the exact state of an application or DLL from one bot to another bot and vice versa.

Sharing a session eliminates the need to repeatedly open and close a session when using the same file across multiple bots. When you share a session across bots, all subsequent actions in that bot, child bots, parent bots, and other child bots of the parent bots can use that DLL session without any additional steps by using the same global session name in these bots.

For example, consider you have added the **Open** action with the **Global session** selected at the eighth line of a bot. All the actions that are executed after the eighth line in the current bot, child bots, and parent bots can use that DLL session without any additional step.

Recommendation: Use the **Open** action to open a global session as the first action in your bots.

Using the Run function (Legacy) action

Use the **Run function (Legacy)** action to run a function within the `.dll` file and specify the parameters to pass a function and store the output as a variable.

- Use a dictionary variable to pass the parameters to a function. The dictionary key contains the parameter name to pass to a function.
- If the `.dll` file uses `.NET` functions or classes from another `.dll` file, you must add the second `.dll` file as a manual dependency of the bot.

Bot dependencies

- When you use **Run function** or the **Run function (Legacy)** action, ensure that you use the supported data types for DLL functions.

See [DLL package](#).

Follow these steps to run a function:

1. In the **Actions** palette, double-click or drag the **Run function (Legacy)** action from the **DLL** package.
2. In the **Session name** field, enter the name of the session.
3. In the **Enter the namespace** field, specify the namespace.

You can specify any of the namespaces defined in the DLL file.

Note: Ensure that the value you have provided in the field is correct.

Important: This field is case-sensitive.

4. In the **Enter the class name** field, specify the name of the class.
You can specify the name of any classes available in the namespace.

Important: This field is case-sensitive.

5. In the **Enter the name of function to be executed** field, specify the name of the function to execute.
Ensure that the name you have provided is correct and available in the class specified in the previous step.

Important: This field is case-sensitive.

6. Optional: In the **Parameters to the function** list, select the variable that contains all the parameters needed by the function.
You can use Boolean, datetime, dictionary, list, number, string, or table variable types to pass parameters to the function.

Note: Use the dictionary subtype Any to enable the bot to pass parameters of different data types to the function including Boolean, numeric, and string.

Specify the dictionary key as the parameter name to provide the dictionary value as the parameter value. For example, you have a function `ReturnSum` that returns the sum of two numeric values and want to pass `Param1` and `Param2` as its parameters. Configure a dictionary variable with two keys: `Param1` and `Param2`, each with the value that you want to pass.

7. Optional: In the **Assign output to variable** list, select a variable to use to store the output of the function.
You can use Boolean, datetime, dictionary, list, number, string, or table variable types to store the output based on the type of output the function returns.
8. Click **Save**.

Using the Run function action

Use the **Run function** action to run a function within a `.dll` file and specify the parameters to pass a function and store the output as a variable.

- This action enables you to pass a parameter of any type. If you want to use a dictionary variable to pass the parameters to a function, use the **Run function (Legacy)** action.

Using the Run function (Legacy) action

- The **Run function** action does not support the use of Windows Forms.
- If the `.dll` file uses .NET functions or classes from another `.dll` file, you must add the second `.dll` file as a manual dependency of the bot.

Bot dependencies

- This action supports overloaded functions starting from Enterprise A2019.17. The action can handle `.dll` files that contain multiple functions of the same name. It calls the function based on the number of parameters passed.
- When you use **Run function** or the **Run function (Legacy)** actions, ensure that you use the supported data types for DLL functions.

DLL package

Perform the follow steps to run a function:

1. In the **Actions** palette, double-click or drag the **Run function** action from the **DLL** package.
2. In the **Session name** field, enter the name of the session.
3. In the **Enter the namespace (Optional)** field, specify the namespace.
You can specify any of the namespaces defined in the DLL file.

Note: Ensure that the value you have provided in the field is correct.

Important: This field is case-sensitive.

4. In the **Enter the class name** field, specify the name of the class.
You can specify the name of any of the classes available in the namespace.

Important: This field is case-sensitive.

5. In the **Enter the name of function to be executed** field, specify the name of the function to execute.
Ensure that the name you have provided is correct and available in the class specified in the previous step.

Important: This field is case-sensitive.

6. Optional: In the **Input parameters** section, click the **Add Parameters** button.
 - a) In the **DLL parameter details** dialog box, in the **Parameter name** field, enter the name of the parameter.
 - b) From the **Parameter type** list, select a data type.
For Integer data type (UInt16, Int16, Int32, Int64, Int, Single, Float, Decimal, Double, UInt32, or UInt64), you can use a value from a credential vault or a credential variable as input parameter.
 - c) In the **value** field, enter the value that you want to pass .
If you select the Integer data type, you can choose from the following options:

- **Number:** In the number field, enter the value that you want to pass.
- **Credential:** To use a value from a credential vault, select **Credential**. To use a credential variable, select **Variable**.

For more information about credential vaults and how to use them, see [Credentials and lockers in the Credential Vault](#).

Repeat Step 6 to add multiple parameters.

Important: The names of the parameters you add and their order must be the same as in the DLL function.

7. Use the **Run function in background** option when no Windows system-related operations, such as such as keystroke, mouse click, or window switching, are called under the C# DLL. You can select the **Run function in background** check box to bypass the intermediate window (AAZeroSizeForm) and run the C# DLL under the console application without the form. We recommend that you select this check box if the DLL function is not interacting with the Windows API to perform operations such as keystroke, mouse click, or window switching. This feature also helps to improve the performance of the DLL execution if the **Run function in background** check box is selected.

8. Optional: In the **Assign output to variable** list, select a variable to use to store the output of the function.
You can use Boolean, datetime, dictionary, list, number, string, or table variable types to store the output based on the type of output the function returns.
9. Click **Save**.

Document Extraction package

The Document Extraction package enables you to extract data from documents and download that data. This package is for processing documents in Document Automation.

When a new learning instance is created, the Control Room automatically creates a folder with the same name as the learning instance in the **Automation > Document Workspace** folder. Within that folder, the Control Room creates the following two bots:

- **Extraction bot:** Extracts data from defined fields in uploaded documents.
- **Download bot:** Downloads the extracted data to a specific folder on the device or shared network.

Actions in the Document Extraction package

This package includes the following actions:

Action	Description
Download data	See Using Download data action
Extract data	See Using Extract data action

Related concepts

[Document Automation](#)

Document Automation is the new Cloud-native intelligent document processing solution that business users can set up to automatically read and process documents quickly using pretrained models and validation feedback.

Related tasks

[Create a learning instance in Document Automation](#)

Begin processing documents by creating a learning instance to extract data from invoices, utility bills, or receipts. A learning instance is a structure that holds information such as document type, language, and the fields to be extracted.

Using Extract data action

TaskBots use the Extract data action to process documents uploaded to Document Automation.

When you create a learning instance in Document Automation, the Control Room automatically creates the **extractionbot**. To edit this bot, navigate to **Automation > Document Workspace**, select the folder with the same name as the learning instance, and open the **extractionbot**.

The following table describes the action fields.

Note: We do not recommend changing the variables in these fields as that might break the process.

Field	Description
Document to extract	File path to the uploaded document

Field	Description
Learning instance name	Name of the learning instance associated with this bot
Output results	<p>Specify where to hold Document Automation data:</p> <ul style="list-style-type: none"> • Uploaded to Document Automation server: Data generated during extraction is uploaded to the server for further processing (such as validation) and later downloaded by a bot running the Download data action. • Saved to local folder: Data generated by Document Automation is not sent to the server and is saved to the specified folder path. <hr/> <p>Note: If you select this option, Document Automation does not send files for validation, since that requires the use of the Document Automation server. In addition, you can remove the bot running the Download data action from the process, since selecting this option makes that bot redundant.</p> <hr/>
Service account	If the learning instance associated with this bot will process documents in Google Document AI, click Pick to select the credential that contains your Google Document AI security token.
Document AI endpoint URL	If the learning instance associated with this bot will process documents in Google Document AI, provide the URL to your service account.
GroupLabel (optional)	If the learning instance was created in Automation 360 IQ Bot and connected to Document Automation, this field is auto-filled with the applicable document group name.

Related tasks

[Create a learning instance in Document Automation](#)

Begin processing documents by creating a learning instance to extract data from invoices, utility bills, or receipts. A learning instance is a structure that holds information such as document type, language, and the fields to be extracted.

Configure Extract action to process documents in Google Document AI

Provide the credential that is holding the Google Document AI API key to the **Extraction bot**.

- [Configure key for Google Document AI](#)
- [Create a learning instance in Document Automation](#)
- Login to your Google Document AI account, navigate to the processor, and set the default version to pretrained-invoice-v1.1-2021-04-09

- Copy the Google Document AI prediction endpoint
1. Navigate to **Automation > Private tab > Document Workspace** and click the folder with the same name as the learning instance to configure the bot.
 2. Open the **Extraction bot** and click the Document Extraction action to edit it.
 3. In the **Service account** field, click **Pick** to select the `doc-ai-credential` credential.
 4. Provide the Google Document AI prediction endpoint URL.
 5. Click **Save**.

Using Download data action

TaskBots use the Download data action to download data from successfully processed documents in Document Automation.

When you create a learning instance in Document Automation, the Control Room automatically creates the **downloadbot**. To edit this bot, navigate to **Automation > Document Workspace**, select the folder with the same name as the learning instance, and open the process. By default, the process contains four `downloadbots`. You can edit the output format in the bots: [Change output format from CSV to JSON](#)



Warning: Only edit the bots in the process. We do not recommend editing the **downloadbot** in the folder with the same name as the learning instance.

The following table describes the **Download data** action fields:

Field	Description
Document Id	The document to download
Document type	The output file type: <ul style="list-style-type: none"> • Output file (CSV): Used for downloading successfully processed documents to CSV format. • Output file (JSON): Used for downloading successfully processed documents to JSON format. • Input file: Used for downloading failed documents in the file type that they were uploaded.
Output folder path	Specifies the file path where to download the document
Delete files	Removes files from the Document Automation server after they are downloaded

Related reference

[About the AARI process in Document Automation](#)

Document Automation uses Automation Anywhere Robotic Interface technology to manage the end-to-end document extraction process. When you create a learning instance in Document Automation, the system also creates an AARI process. Review the following guide to understand the logic.

Email package

The **Email** package contains actions to automate email-related tasks through Exchange Web Services (EWS), Microsoft Outlook, and other email servers. You can use these actions for sending, receiving, and modifying messages, folders, and the status of messages.

Note:

- The **Email** package supports the email automation of a shared mailbox in Outlook for Office 365/ Microsoft 365 using IMAP/EWS protocols, and OAuth 2.0 authentication using Client Credentials and Authorization Code with PKCE grant flows. You can automate emails retrieved from a shared mailbox and perform all email-related tasks by accessing each folder(s) and its subfolder(s) in the shared mailbox. Ensure that you have set up the shared mailbox in your Outlook application.
- Proxy is supported for EWS OAuth 2.0. When you create a bot that uses EWS OAuth2 for authentication and the Bot Runner machine is configured behind the firewall, then all outbound requests are routed through the proxy server configured on the Bot Runner machine.

The **Email** package supports EWS, POP3, SMTP, and IMAP protocols and enables you to perform the following tasks:

- Manage and organize email messages and folders.
- Download attachments from emails to specific folders on devices.
- Extract data from emails to variables, to use as extracted data in other applications. For example, you can extract data from a sender's email and store it in a Microsoft Excel spreadsheet.

Note: If you want to automate an email-related task on a device using Microsoft Outlook, ensure that the Outlook application is open.

Note:

- If your current office installation is any of the following:
 - Microsoft 365 Apps for Enterprise
 - Office 2016, 2019, or 2021 (Consumer Version 2009 or later)

Then you do not need to install the Microsoft Access Database Engine as an additional component in your system.

However, if you have both Microsoft 365 Apps and the Microsoft Access Database Engine are installed on your system, then you can uninstall the Microsoft Access Database Engine and repair Microsoft 365 Apps.

Microsoft recommends that you do not install the Microsoft Access Database Engine driver separately because both the Microsoft Access Database Engine 2016 and Microsoft 365 Apps use the same major version identifier (16.0). To learn more about the Microsoft Access Database Engine driver installation requirement, see [Unable to use the Access ODBC or OLEDB provider](#)

- When you send an email, reply, or forward, the attachment size allowed in the email depends on your internet speed (timeout of 120 seconds) and the email server restrictions. If sending an attachment takes more than 120 seconds, the system displays an error due to timeout.

Considerations

Note: Some of the actions must be used within a **Loop** action. See [Using the For each mail in mail box iterator](#).

Emails are retrieved based on the sequence of the folders listed in the inbox field. Within each folder, emails are retrieved based on received date and time in the last in, first out (LIFO) order. Additionally, you can apply filters on the following fields:

- Types of emails: **All**, **Read**, and **Unread**
- Subject
- From a specific folder
- From specific sender
- Before, on, or after received date

Adhere to the following best practices when you filter and loop through folders that contain a large number of email messages:

- After you have processed email messages, move them to another folder so that their duplicate email messages are not processed again during a subsequent run.
- Try to reduce the number of messages in the mailbox.
- The filtration works on the filter parameters provided by the user, such as type of email: All, Read, and Unread; Subject; from a specific folder; from a specific sender; or before, on, or after received date). Following are the types of filter mechanisms:
 - **Email server-side:** The filtration that takes place on the server-side is much faster.
 - **Client-side:** Filtration is performed on the local machine and is comparatively slow because the mail messages are first retrieved from the remote server and then filtered in the local machine.
 - **Hybrid:** Some parameters are filtered on the server side and some on the client side.
- Here is an explanation of how the filtration process works for various server types:
 - **EWS:** All filtration is done on the server side and is hence much faster.
 - **Outlook client:** Nothing is filtered on the server side, but the filtration process is faster because email messages are already present on the local machine.
 - **IMAP:** Filtration for the **Subject** field is performed on the local machine and is slower. For the **Before, on, or after received date** parameter, the filtration for `date` is performed on the remote server, and for `hour/min/second`, it is performed on the local machine. For example, for the date `01/12/2022`, filtration is performed on the remote server whereas for the time (hour/min/sec) `21:10:56`, filtration is performed on the local machine.
 - **POP3:** This server is the slowest of all because mails are retrieved from the remote server, and filtration is done in the local machine.

We recommend connecting using the EWS server and Outlook client as the filtration process is much faster when compared to IMAP and POP3 protocols.

- Always use the **Disconnect** action if the **Connect** action is used to release a resource.

Before you start

Perform the following actions within the **Email** package as part of using the set of available actions:

1. Establish a connection with an email server using the **Connect** action.

While establishing the connection, specify the details and session name of the email server. Use this same session name for the other actions.

You do not have to establish a connection for the **Forward**, **Reply**, and **Send** actions because you will add the sender and email server details when you use these actions.

2. Use the actions to automate a task.
3. After you have automated all the email-related tasks, terminate the connection to the mail server using the **Disconnect** action.

Important: You must enable POP settings to automate an email-related task on the Gmail server using the POP3 protocol. See [Read Gmail messages using POP](#).

Actions in the Email package

The **Email** package includes the following actions:

Action	Description
Change status	See Change status action .
Check if folder exists	See Check if folder exists action .
Delete all	See Delete all action .
Delete	See Delete action .
Disconnect	See Disconnect action .
Connect	See Using Connect action for Email .
Forward	See Using the Forward action .
Move all	See Move all action .
Move	See Move action .
Reply	See Using Reply action .
Save all attachments	See Save all attachments action .
Save attachments	See Save attachment action .
Save email	See Save email action .
Send	See Using the Send action .

Related reference

[Loop package](#)

Use the Loop package to run a sequence of actions repeatedly for a specific number of times or until a specific condition is met.

[Email server settings](#)

The details about the mail server you provide when establishing a connection varies based on the email server to which you are connecting.

Using dictionary variable for email properties

When you automate an email-related task, RPA Workspace retrieves various properties of an email and stores the values of these properties in a dictionary variable. These properties are stored in a dictionary variable when you use an email action within a loop action.

Change status action

The Change status action in the Email package enables you to change the statuses of emails to read or unread. Use this action within a **Loop** action.

Settings

- In the **Session name** field, enter the name of the session that you used to connect to the email server in the **Connect** .
- **Change status to:** Select the **Read** or **Unread** option to change the status of the email.

Note:

- Microsoft Outlook supports this action.
- POP3 servers do not support and maintain the read or unread status of emails.

Check if folder exists action

Use the Check if folder exists action in the Email package to verify whether a folder with the name you specified exists in the email server.

Settings

- In the **Session name** field, enter the name of the session that you used to connect to the email server in the **Connect** .
- In the **Folder name** field, enter the name of the folder you want to check.

Note: This field is not case-sensitive.

- In the **Select the destination boolean variable** list, select a Boolean variable to store the output of the result. The output is either True (folder exists) or False (does not exist). The shows a descriptive default variable name. If you create several output variables, subsequent variable names are appended with a -1, -2, -3, and so on to avoid duplication.

Delete all action

Use the Delete all action in Email package to delete read, unread, or all emails from the mail server.

Settings

- In the **Session name** field, enter the name of the session that you used to connect to the email server in the **Connect** .

- Select the **All**, **Read**, or **Unread** option to specify the type of email you want to delete.

Note:

- For an email server using the POP3 protocol, this action deletes all the email messages.
 - Microsoft Outlook does not currently support this action.
-

Delete action

Use the Delete action in Email package to delete the specified email from the inbox. Use this action within a Loop action.

Settings

In the **Session name** field, enter the name of the session that you used to connect to the email server in the **Connect** .

Note: Microsoft Outlook supports this action.

Disconnect action

Use the Disconnect action in Email package to terminate the connection established with the email server.

Settings

In the **Session name** field, enter the name of the session that you used to connect to the email server in the **Connect** .

Using Connect action for Email

Use the **Connect** action to establish a connection with an email server. This is the first action you must use to automate an email-related task.

You can use OAuth 2.0 to authenticate with the email server for email automation. Based on your email service provider, perform the relevant steps:

- **Outlook/Office 365**
 - If you use **Client credentials flow** authentication mode, then perform the following steps:
 1. Log in to the Microsoft [Azure portal](#).
 2. Register an application with the Microsoft identity platform to obtain the client ID and tenant ID. See [Register an application](#).
 3. Add a Client secret. See [Add a client secret](#).
 4. Based on which mail server you connect to, perform the relevant steps:
 - **IMAP/POP3**
Add the POP and IMAP permissions to your AAD application . See [Authenticate an IMAP, POP or SMTP connection using OAuth](#).
 - **EWS**
 - Configure for app-only authentication. See [Configure for app-only authentication](#).

- Configure an application access policy and limit the scope of application permissions. See [Configure application access policy](#).
- If you use the **Authorization code with PKCE** authentication mode, then perform the following steps:
 1. Log in to the Microsoft [Azure portal](#).
 2. Register an application with the Microsoft identity platform to obtain the client ID and tenant ID. See [Register an application](#).
 3. When registering the application, set the redirect URI to `http://localhost:9999/callback`.
 4. Add permissions with type delegated for IMAP, POP3, and SMTP and grant the application the required permission for Microsoft Graph to the application.
- **Gmail**

To authorize your application with Gmail using the **Authorization code with PKCE** authentication method, perform the following steps:

1. Configure the OAuth2.0 settings in the Google Cloud Platform (GCP) and retrieve the necessary credentials to connect Automation 360 with your G Suite applications.
2. If you have not already done so, [create a project](#).
3. To generate the Client ID and Client secret, complete the steps in [Setting up OAuth 2.0](#).

Note:

- Select the **Web application** option.
- Add this authorized redirect URI: `http://localhost:8888/Callback`.

-
4. Complete the steps to set up [user consent](#) for the username that you will use to connect to the Automation 360.

Note:

- Client Credentials flow does not support Gmail.
- The Client Credentials and Authorization code with PKCE authentication modes do not support Yahoo and MSN mail servers.

Important: If you want to use both the authentication mode (Client credentials and Authorization code with PKCE), you must register on two separate applications.

Note: When connecting to an Exchange Web Services server, multi-factor authentication must be disabled, including in all organizational level security policies where multi-factor authentication might be enabled. If multi-factor is not disabled completely, users can encounter connection or authorization errors.

This action enables you to provide the email server credentials and details, and associate this information with a session name. Use this same session name for the other Email actions, so you only have to provide the server information once.

To establish a connection with an email server, follow these steps:

1. In the **Actions** palette, double-click or drag the **Connect** action from the **Email** package.
2. Enter a session name.

3. In the **Outlook**, **Email server**, or **EWS** option, specify whether you want to establish a connection with Microsoft Outlook or a mail server.

When you establish a connection with Microsoft Outlook, email messages are processed from the shared mailbox. Ensure that you have set up the shared mailbox in your Outlook application.

Note:

- This feature is supported only for Outlook.
- You can select only one mailbox from the list of mailboxes in the shared mailbox.
- The meeting invitation is not read in Outlook because the bot does not select calendar invites as email objects. This feature is not currently supported.

-
- If you have selected the **Outlook** option, you do not need to provide any additional details.
 - If you have selected the **Email server** option, complete the following fields:

Note: For information about the host and port to be used for the various mail servers, see [Email server settings](#).

-
- **Use secure connection (SSL/TLS):** Select this option if you want to use a secure connection with the mail server.
 - **Host:** Enter the name of the mail server.

Note: This field is not case-sensitive.

-
- **Port:** Enter the port number of the server.
 - **Protocol:** Select either **IMAP** or **POP3** protocol.
 - **Authentication mode:** Choose from the following authentication modes:
 - **Basic:** Uses the username and password.
 - **OAuth2 – Authorization code with PKCE:** See [Microsoft identity platform and OAuth 2.0 authorization code flow](#)
 - **OAuth2 – Client credentials:** See [Microsoft identity platform and the OAuth 2.0 client credentials flow](#)

Depending on the authentication mode that you selected, you must specify the details in the following fields as applicable.

- **Username:** Enter the username that you want to use to access the mail server.
For example, john.smith@myCompanyName.com
- **Password:** Enter the password for the username you provided.
- For **Client ID**, **Tenant ID**, **Redirect URI**, and **Client secret** fields, enter the information that is provided for your account on your [Azure portal](#).
- **Email provider:** Select your email service provider from the drop-down list.
 - Outlook/Office365
If you select this option, then provide the **Tenant ID**.
 - Gmail

For **Username**, **Password**, **Tenant ID**, **Client ID**, and **Client secret** fields, choose from **Credential**, **Variable**, or **Insecure string** tab:

- **Credential:** Use a value available in the credential vault.
- **Variable:** Use a user-defined variable that stores the values.

- **Insecure string:** Manually enter a value.
- If you have selected the **EWS** option, complete the following fields:
 - **Exchange Version:** Select the version that your organization is using:
 - Exchange Server 2013
 - Exchange2010_SP2
 - Exchange2010_SP1
 - Exchange2010
 - Exchange2007_SP1
 - **Azure cloud:** Select the product that your organization is using:
 - **Azure Global:** For customers of Microsoft 365 Commercial version (login.microsoftonline.com)
 - **Azure US GCC High:** For customers of Microsoft 365 Government version (login.microsoftonline.us)
 - **Optional: Domain name:**
 - If you are an Office 365 customer and you leave this field blank, RPA Workspace uses smtp.office365.com to connect to the server.
 - If you are an Office 365 customer and you have entered a domain name in the **username** field, you **must** enter `smtp.office365.com` in this field.
 - If you are not an Office 365 customer, enter the domain name of your organization. Otherwise, RPA Workspace uses the domain name you provided in the **Username** field.
 - **Authentication mode:** Choose from the following authentication modes:

Note: From Automation 360v.27 or later, the authorization type **OAuth2-Silent authentication mode** is renamed to **OAuth2-ROPC**, and the **OAuth2-Interactive authentication mode** is renamed to **OAuth2-Implicit**.

- **Basic:** Uses the username and password.
- **OAuth2-ROPC:** See *Microsoft identity platform and OAuth 2.0 Resource Owner Password Credentials*
- **OAuth2-Implicit:** See *Microsoft identity platform and implicit grant flow*
- **OAuth2 – Authorization code with PKCE:** See *Microsoft identity platform and OAuth 2.0 authorization code flow*
- **OAuth2 – Client credentials:** See *Microsoft identity platform and the OAuth 2.0 client credentials flow*

Depending on the authentication mode that you selected, you must specify the details in the following fields as applicable.

- **Username:** Enter the username that you want to use to access the mail server.
For example, `john.smith@myCompanyName.com`
- **Password:** Enter the password for the username you provided.
- For **Client ID**, **Tenant ID**, **Redirect URI**, and **Client secret** fields, enter the information that is provided for your account on your [Azure portal](#).
- **Test connection:** Click **Test connection** to sign in to your account, accept the permissions requested to authenticate, and establish a connection with the server.

Note: When you perform desktop operation and click **Test connection** to sign in to your account, then add this redirect URI: <https://outlook.office365.com>.

For **Username, Password, Tenant ID, Client ID**, and **Client secret** fields, choose from **Credential, Variable**, or **Insecure string** tab:

- **Credential:** Use a value available in the credential vault.
- **Variable:** Use a user-defined variable that stores the values.
- **Insecure string:** Manually enter a value.

4. Click **Save**.

Email server settings

The details about the mail server you provide when establishing a connection varies based on the email server to which you are connecting.

The following table provides information about the host name and the port you must use when establishing a connection to the specified mail server:

Server	For reading or retrieving emails	For sending emails
Microsoft Outlook/Microsoft Office 365	Host: outlook.office365.com Port: 993	Host: outlook.office365.com, Port: 993 Host: smtp.office365.com Port: 587
Gmail	Host: imap.gmail.com Port: 993	Host: smtp.gmail.com Port: 587
Yahoo	Host: imap.mail.yahoo.com Port: 993	Host: smtp.mail.yahoo.com Port: 465 or 587
MSN	Host: imap-mail.outlook.com Port: 993 For POP3: Host: pop-mail.outlook.com Port: 993	Host: smtp-mail.outlook.com Port: 465 or 587

The Email package supports nonstandard ports in the range of 1 through 65535 for the SMTP server.

Additional configuration for Gmail and Yahoo

If you are using a Gmail account to automate an email-related task, ensure that the option to allow access for less secured apps is enabled and IMAP must be enabled to access Gmail from other clients using IMAP . This is required to enable a TaskBot to send email using a Gmail account.

To enable access for less secure apps:

1. Log in to your Gmail or Yahoo account.
2. Go to account settings.
3. Enable the option to allow less secure apps.

Note: You can use App password if the application does not support Sign in with Google to connect apps to your Google Account. App passwords can only be used with accounts that have 2-Step Verification turned on.

If you are using a Yahoo account to automate an email-related task, ensure that you generate the app password from the Yahoo account security page. Use the app password and the email address to log in to your email account.

Using the Forward action

Use the **Forward** action to forward emails and attachments to one or more recipients. To forward emails as plain text or HTML through Exchange Web Services (EWS), Microsoft Outlook, or other email servers, use this action within a **Loop** action.

To forward emails, follow these steps:

1. In the **Actions** palette, double-click or drag the **Forward** action from the **Email** package.
2. In the **To address** field and the optional **Cc** and **Bcc** fields, enter the email addresses of the recipients.

Note: The **To address**, **Cc**, and **Bcc** fields are not case-sensitive.

3. Optional: To specify whether to attach multiple files as a list or create a variable to hold the list values of the file object, select the **List** or **Variable** tab from **Attachment**.

Option	Description
List	<ul style="list-style-type: none"> • Select the attachment from a location: <ul style="list-style-type: none"> • Control Room file: Enables you to select an attachment that is available in a folder. • Desktop profile: Enables you to select an attachment that is available on your device. <p>You can provide a combination of static path or string variable. To use it as a string variable, copy the static path from your desktop and create a variable of type string. Enter the Variable name and paste the file path in the Default value field. Press F2 to insert the value of the filepath.</p> • Variable: Enables you to specify the file variable that contains the location of the attachment. <ul style="list-style-type: none"> • Specify the path that you want to attach in the Value field. Click Add to attach multiple files.

Option	Description
Variable	Enables you to specify the list of file objects that contain the location of the attachments. Create a new variable of type List with subtype File , and add the filepath in the Default value field (optional). You can choose the file from the Desktop or Control room .

When you are attaching multiple files to an email, to separate the file paths, if you are connected with EWS, use a comma (,), and if you are connected to an email server or Microsoft Outlook, use a semicolon (;).

4. Optional: Select the **Raise error if attachments are missing (desktop only)** check box to verify that you have attached a file and the attached file exists.

Option	Result
The Raise error if attachments are missing (desktop only) check box is selected	If a file is not attached, the email is not sent and the bot encounters an error.
The Raise error if attachments are missing (desktop only) check box is not selected	The email is sent even if a file is not attached.

5. Select the format that you want to use from the following options:

Option	Description
Plain text	Use regular text in your email body, with no formatting effects, such as bold, italic, or underline, or special layout options.
HTML code	Use HTML script in your mail body when you want your content to be displayed in a certain layout every time. You can also include interactive elements, such as links.
HTML design editor	Use this option to create and customize your email layout and body. Use the editor toolbar to make various changes to your text, such as applying bold, italic, and other formatting effects, inserting links, and changing the font and size of the text. You can copy the content from the design editor and paste it to other windows.

6. Optional: Enter the content you want to send along with the email in the **Message** field. The email will be appended to the message you have specified.
7. Optional: Select the **Include Go Green message at the end of the email** check box. The Go Green message appends the following text to the bottom of the email body: `Please consider the environment before printing. Let's Go Green!`

8. Select the **Email server**, **EWS** or **Outlook** option from the **Send email via** list to specify whether to send the emails using Microsoft Outlook or a mail server.
- If you have selected the **Outlook** option, you do not need to provide any additional details.
 - If you have selected the **Email server** option, complete the following fields:

Note: For information about the host and port to be used for the various mail servers, see [Email server settings](#).

- **Email server host:** Enter the host you want to connect.

Note: If you use the host Outlook.office365.com, there is a limit of 30 messages sent per minute and 10,000 recipients per day.

- **Email server port:** Enter the port you want to use to establish the connection.
- **Use secure connection (SSL/TLS):** Select this option if you want to use a secure connection with the mail server.
- **My server requires authentication:** Select this option if the server requires credentials for access.
- **Authentication mode:** Select the authentication modes:
 - **Basic**
 - **OAuth2 – Authorization code with PKCE**

Depending on the authentication mode that you selected, you must specify the details in the following fields as applicable.

- **Username:** Enter the username that you want to use to access the mail server.

For example, john.smith@myCompanyName.com

- **Password:** Enter the password for the username you provided.
- For **Client ID**, **Tenant ID**, **Redirect URI**, and **Client secret** fields, enter the information that is provided for your account on your [Azure portal](#).
- **Email provider:** Select your email service provider from the drop-down list.
 - Outlook/Office365
 - If you select this option, then provide the **Tenant ID**.
 - Gmail

For **Username**, **Password**, **Tenant ID**, **Client ID**, and **Client secret** fields, choose from **Credential**, **Variable**, or **Insecure string** tab:

- **Credential:** Use a value available in the credential vault.
 - **Variable:** Use a user-defined variable that stores the values.
 - **Insecure string:** Manually enter a value.
- If you have selected the **EWS** option, you do not need to provide any additional details.

9. Click **Save**.

Move all action

The Move all action in the Email package enables you to move all emails from one folder to another in the email server.

Settings

- In the **Session name** field, enter the name of the session that you used to connect to the email server in the **Connect** .
- In the **Destination folder path in mailbox** field, provide the path to the location where you want to move the email.
- Select which emails to move: **All**, **Read**, or **Unread**
- In the **From a specific folder** field, specify the folder from which to move the emails. For example, `Inbox/project1`.

Note: For an email server using the POP3 protocol, you can retrieve emails only from the inbox.

- **Optional:** Specify any of the following conditions:
 - **When subject contains:** Enter keywords separated by semicolons.

How subject filter works when moving emails

Note: The **When subject contains** field is case sensitive. If you have established a connection with the EWS server and when you enter text inside a pair of double quotation marks (""") in the **When subject contains** field, the bot retrieves all the email messages whose subject exactly matches the text and the case that you entered inside a pair of double quotation marks.

- **From specific senders:** Enter senders' email addresses separated by semicolons.
- **When received date is on or after** or **When received date is before:** Select a datetime variable from the list.

Note: Because folders are not supported in Gmail, this action is not supported for Gmail.

Note: You cannot use the **Move all** action within a loop. The **Move all** action is designed to be used with conditions outside a loop.

For more information, see [Can Move all action be used within a loop? \(A-People login required\)](#)

Move action

The Move action in the Email package enables you to move an email from one folder to another in the mailbox. Use this action within a **Loop** action.

Settings

- In the **Session name** field, enter the name of the session that you used to connect to the email server in the **Connect** .
- In the **Destination folder path in the mailbox** field, provide the path to the destination folder where you want to move the email. For example, `Inbox/finance/1`
- Keep the following considerations in mind when you use the **Move** action:
 - You must use this action inside a loop.

- When you connect with an **Email server** and use the **IMAP** protocol, ensure that you use the **Move** action as the last action in the email loop.
- This action is not supported for **POP3** connections.
- The bot encounters an error if the **Delete** action is used before the **Move** action.
- If you are connecting to Outlook, we recommend that you to use a **Delay** action after the **Move** action. (Specify a maximum delay of more than 2 seconds). Delay is based on Outlook client performance.
- For improved performance when moving a large number of emails, considering latency issues with the Outlook client, we recommend using the **Move all** action instead of **Move** action when you want to move more than 500 emails.

Using Reply action

Use the **Reply** action to send a response to an email with the same subject.

To send a reply to emails as plain text or HTML through Exchange Web Services (EWS), Microsoft Outlook, or other email servers, use this action within a **Loop** action. This action does not include any files attached to the original email.

Follow these to reply to an email:

1. In the **Actions** palette, double-click or drag the **Reply** action from the **Email** package.
2. In the **Cc** and **Bcc** fields, enter the email address of additional recipients.

Note: The **Cc** and **Bcc** fields are not case sensitive.

3. Optional: To specify whether to attach multiple files as a list or create a variable to hold the list values of the file object, select the **List** or **Variable** tab from **Attachment**.

Option	Description
List	<ul style="list-style-type: none"> • Select the attachment from a location: <ul style="list-style-type: none"> • Control Room file: Enables you to select an attachment that is available in a folder. • Desktop profile: Enables you to select an attachment that is available on your device. <p>You can provide a combination of static path or string variable. To use it as a string variable, copy the static path from your desktop and create a variable of type string. Enter the Variable name and paste the file path in the Default value field. Press F2 to insert the value of the filepath.</p> • Variable: Enables you to specify the file variable that contains the location of the attachment. <ul style="list-style-type: none"> • Specify the path that you want to attach in the Value field. Click Add to attach multiple files.

Option	Description
Variable	Enables you to specify the list of file objects that contain the location of the attachments. Create a new variable of type List with subtype File , and add the filepath in the Default value field (optional). You can choose the file from the Desktop or Control room .

When you are attaching multiple files to an email, to separate the file paths, if you are connected with EWS, use a comma (,), and if you are connected to an email server or Microsoft Outlook, use a semicolon (;).

4. Optional: Select the **Raise error if attachments are missing (desktop only)** check box to verify that you have attached a file and the attached file exists.

Option	Result
The Raise error if attachments are missing (desktop only) check box is selected	If a file is not attached, the email is not sent and the bot encounters an error.
The Raise error if attachments are missing (desktop only) check box is not selected	The email is sent even if a file is not attached.

5. Select the format that you want to use from the following options:

Option	Description
Plain text	Use regular text in your email body, with no formatting effects, such as bold, italic, or underline, or special layout options.
HTML code	Use HTML script in your mail body when you want your content to be displayed in a certain layout every time. You can also include interactive elements, such as links.
HTML design editor	Use this option to create and customize your email layout and body. Use the editor toolbar to make various changes to your text, such as applying bold, italic, and other formatting effects, inserting links, and changing the font and size of the text. You can copy the content from the design editor and paste it to other windows.

6. Enter the content you want to send along with the email in the **Message** field.
The email will be appended to the message you have specified.
7. Optional: Select the **Include Go Green message at the end of the email** check box.
The Go Green message appends the following text to the bottom of the email body: `Please consider the environment before printing. Let's Go Green!`

8. Select the **Email server**, **EWS** or **Outlook** option from the **Send email via** list to specify whether to send the emails using Microsoft Outlook or a mail server.
- If you have selected the **Outlook** option, you do not need to provide any additional details.
 - If you have selected the **Email server** option, complete the following fields:

Note: For information about the host and port to be used for the various mail servers, see [Email server settings](#).

- **Email server host:** Enter the host you want to connect.

Note: If you use the host Outlook.office365.com, there is a limit of 30 messages sent per minute and 10,000 recipients per day.

- **Email server port:** Enter the port you want to use to establish the connection.
- **Use secure connection (SSL/TLS):** Select this option if you want to use a secure connection with the mail server.
- **My server requires authentication:** Select this option if the server requires credentials for access.
- **Authentication mode:** Select the authentication modes:
 - **Basic**
 - **OAuth2 – Authorization code with PKCE**

Depending on the authentication mode that you selected, you must specify the details in the following fields as applicable.

- **Username:** Enter the username that you want to use to access the mail server.

For example, john.smith@myCompanyName.com

- **Password:** Enter the password for the username you provided.
- For **Client ID**, **Tenant ID**, **Redirect URI**, and **Client secret** fields, enter the information that is provided for your account on your [Azure portal](#).
- **Email provider:** Select your email service provider from the drop-down list.
 - Outlook/Office365
 - If you select this option, then provide the **Tenant ID**.
 - Gmail

For **Username**, **Password**, **Tenant ID**, **Client ID**, and **Client secret** fields, choose from **Credential**, **Variable**, or **Insecure string** tab:

- **Credential:** Use a value available in the credential vault.
 - **Variable:** Use a user-defined variable that stores the values.
 - **Insecure string:** Manually enter a value.
- If you have selected the **EWS** option, you do not need to provide any additional details.

9. Click **Save**.

Save all attachments action

Use the **Save all attachments** action to save attachments from all emails on the email server to a specified folder.

Settings

- In the **Session name** field, enter the name of the session that you used to connect to the email server in the **Connect** .
- Select which emails to save: **All**, **Read**, or **Unread**.
- In the **Save attachments to folder** field, specify the location to save the attachments.

Note: This field is not case-sensitive.

- **Overwrite file(s):** Select this option to overwrite an existing file with the same name. If this option is not selected, the downloaded attachment is saved with the same filename suffixed with a numeric value; it does not overwrite the existing file.

Note:

- You can save attachments with a filename that contains a TAB character.
- If connected to an Outlook server, images embedded in the emails are downloaded along with attachments.

Save attachment action

Use the **Save attachment** action to save attachments from one email to a specified folder. Use this action within a **Loop** action.

Settings

- In the **Save attachments to folder** field, specify the location to save the attachments.

Note: This field is not case-sensitive.

- **Overwrite file(s):** Select this option to overwrite an existing file with the same name. If this option is not selected, the downloaded attachment is saved with the same filename suffixed with a numeric value; it does not overwrite the existing file.

Note: If connected to an Outlook server, images embedded in the emails are downloaded along with attachments.

Save email action

Use the Save email action in the Email package to save an email message as an EML file to a folder. Use this action within a **Loop** action.

Settings

- In the **Session name** field, enter the name of the session that you used to connect to the email server in the **Connect** .

- In the **Save emails to folder** field, specify the location to save the email.

Note: This field is not case-sensitive.

- **Overwrite file(s):** select this option to overwrite the existing file with the same name. If this option is not selected, the email message is saved with the same filename suffixed with a numeric value; it does not overwrite the existing file.

Note: Microsoft Outlook supports this action.

Using the Send action

Use the **Send** action to send an email. This action enables you to send an email to one or more recipients from Microsoft Outlook or a mail server, attach files, and select to send the email in plain text or HTML format.

The **Send** action enables you to attach multiple files of various formats to an email. There is no restriction on the type of file you can attach or its size. However, restrictions implemented by the mail server you are using to send an email apply. For example, a task will fail if the files you have attached to the email you are sending do not adhere to the restrictions applied by the mail server.

Note: Attachments sent as part of email automation are subject to the policies and rules set at the level of the proxy server, firewall, antivirus, email server, customer environment, and so on.

To send an email from a Gmail or Yahoo account, enable access to a less secure app for that account. See [Email server settings](#).

1. In the **Actions** palette, double-click or drag the **Send** action from the **Email** package.
2. In the **To address** field and the optional **Cc** and **Bcc** fields, enter the email addresses of the recipients.

Note: The **To address**, **Cc**, and **Bcc** fields are not case-sensitive.

3. In the **Subject** field, enter the subject for the email.

4. Optional: To specify whether to attach multiple files as a list or create a variable to hold the list values of the file object, select the **List** or **Variable** tab from **Attachment**.

Note: When you create a bot, if the attachment includes the less-than symbol (<) as a special character in the filepath, the special character will be removed after bot execution because the Windows operating system does not support this special character.

Option	Description
List	<ul style="list-style-type: none"> Select the attachment from a location: <ul style="list-style-type: none"> Control Room file: Enables you to select an attachment that is available in a folder. Desktop profile: Enables you to select an attachment that is available on your device. <p>You can provide a combination of static path or string variable. To use it as a string variable, copy the static path from your desktop and create a variable of type string. Enter the Variable name and paste the file path in the Default value field. Press F2 to insert the value of the filepath.</p> Variable: Enables you to specify the file variable that contains the location of the attachment. Specify the path that you want to attach in the Value field. Click Add to attach multiple files.
Variable	<p>Enables you to specify the list of file objects that contain the location of the attachments.</p> <p>Create a new variable of type List with subtype File, and add the filepath in the Default value field (optional). You can choose the file from the Desktop or Control room.</p>

5. Optional: Select the **Raise error if attachments are missing (desktop only)** check box to verify that you have attached a file and the attached file exists.

Option	Result
The Raise error if attachments are missing (desktop only) check box is selected	If a file is not attached, the email is not sent and the bot encounters an error.
The Raise error if attachments are missing (desktop only) check box is not selected	The email is sent even if a file is not attached.

6. Select the format that you want to use from the following options:

Option	Description
Plain text	Use regular text in your email body, with no formatting effects, such as bold, italic, or underline, or special layout options.
HTML code	Use HTML script in your mail body when you want your content to be displayed in a certain layout every time. You can also include interactive elements, such as links.
HTML design editor	Use this option to create and customize your email layout and body. Use the editor toolbar to make various changes to your text, such as applying bold, italic, and other formatting effects, inserting links, and changing the font and size of the text. You can copy the content from the design editor and paste it to other windows.

7. Enter the content you want to send along with the email in the **Message** field.
The email will be appended to the message you have specified.
8. Optional: Select the **Include Go Green message at the end of the email** check box.
The Go Green message appends the following text to the bottom of the email body: `Please consider the environment before printing. Let's Go Green!`

9. Select the **Email server**, **EWS** or **Outlook** option from the **Send email via** list to specify whether to send the emails using Exchange Web Services (EWS), Microsoft Outlook, or a mail server.
- If you selected the **Outlook** option, you do not have to provide any additional details.

Note: Multiple accounts are not supported on the local system. Set up only one account to access mails using bots.

- **Email server:** For information about the host and port to be used for the various mail servers, see [Email server settings](#).
- **From address** Enter the email address.

Note: If the mail server does not support sending an email using an alias email address, use the same email ID in the **From address** as provided in the **Username** field while configuring the mail server.

- **Use secure connection (SSL/TLS):** Select **True** or **False**, or insert a Boolean variable.
- **Email server host:** Enter the host you want to connect.

Note: If you use the host Outlook.office365.com, there is a limit of 30 messages sent per minute and 10,000 recipients per day.

- **Email server port:** Enter the port you want to use to establish the connection.
- **My server requires authentication:** Select **True** or **False**, or insert a Boolean variable.
- **Authentication mode:** Select the authentication type:
 - **Basic**
 - **OAuth2 – Authorization code with PKCE**

Depending on the authentication mode that you selected, you must specify the details in the following fields as applicable.

- **Username:** Enter the username that you want to use to access the mail server.
For example, john.smith@myCompanyName.com
- **Password:** Enter the password for the username you provided.
- For **Client ID**, **Tenant ID**, **Redirect URI**, and **Client secret** fields, enter the information that is provided for your account on your [Azure portal](#).
- **Email provider:** Select your email service provider from the drop-down list.
 - Outlook/Office365
If you select this option, then provide the **Tenant ID**.
 - Gmail

For **Username**, **Password**, **Tenant ID**, **Client ID**, and **Client secret** fields, choose from **Credential**, **Variable**, or **Insecure string** tab:

- **Credential:** Use a value available in the credential vault.
- **Variable:** Use a user-defined variable that stores the values.
- **Insecure string:** Manually enter a value.
- **EWS Server:**
 - **Exchange Version:** Select the version that your organization is using:
 - Exchange Server 2013
 - Exchange2010_SP2

- Exchange2010_SP1
- Exchange2010
- Exchange2007_SP1
- **Azure cloud:** Select the product that your organization is using:
 - **Azure Global:** For customers of Microsoft 365 Commercial version (login.microsoftonline.com)
 - **Azure US GCC High:** For customers of Microsoft 365 Government version (login.microsoftonline.us)
- **Optional: Domain name:**
 - If you are an Office 365 customer and you leave this field blank, RPA Workspace uses smtp.office365.com to connect to the server.
 - If you are an Office 365 customer and you have entered a domain name in the **username** field, you **must** enter `smtp.office365.com` in this field.
 - If you are not an Office 365 customer, enter the domain name of your organization. Otherwise, RPA Workspace uses the domain name you provided in the **Username** field.
- **Authentication mode:** Select the authentication types:

Note: From Automation 360 v.27 or later, the authorization type **OAuth2-Silent authentication mode** is renamed to **OAuth2-ROPC**, and the **OAuth2-Interactive authentication mode** is renamed to **OAuth2-Implicit**.

- **Basic**
- **OAuth2-ROPC**
- **OAuth2-Implicit**
- **OAuth2 – Authorization code with PKCE**
- **OAuth2 – Client credentials**

Depending on the authentication mode that you selected, you must specify the details in the following fields as applicable.

- **Username:** Enter the username that you want to use to access the mail server.
For example, `john.smith@myCompanyName.com`
- **Password:** Enter the password for the username you provided.
- For **Client ID**, **Tenant ID**, **Redirect URI**, and **Client secret** fields, enter the information that is provided for your account on your [Azure portal](#).
- **Test connection:** Click **Test connection** to sign in to your account, accept the permissions requested to authenticate, and establish a connection with the server.

Note: When you perform desktop operation and click **Test connection** to sign in to your account, then add this redirect URI: `https://outlook.office365.com`.

For **Username**, **Password**, **Tenant ID**, **Client ID**, and **Client secret** fields, choose from **Credential**, **Variable**, or **Insecure string** tab:

- **Credential:** Use a value available in the credential vault.
- **Variable:** Use a user-defined variable that stores the values.
- **Insecure string:** Manually enter a value.

10. Click Save.

Using the For each mail in mail box iterator

You must use certain **Email** actions within a **Loop** action. Use the **For each mail in mail box** iterator to repeat a set of actions on all the emails within the specific parameters.

First, connect to the email server. *Using Connect action for Email*

When you establish a connection with Microsoft Outlook, email messages are processed from the shared mailbox. Ensure that you have set up the shared mailbox in your Outlook application.

Note: This feature is supported only for Outlook.

You must use the following Email actions within a loop:

- **Change status**
- **Delete**
- **Save attachments**
- **Save email**

Emails are retrieved based on the sequence of the folders listed in the inbox field. Within each folder, emails are retrieved based on received date and time in the last in, first out (LIFO) order. Additionally, you can apply filters on the following fields:

- Types of emails: **All**, **Read**, and **Unread**
- Subject
- From a specific folder
- From specific sender
- Before, on, or after received date

To use an Email action within a loop, follow these steps:

1. Double-click or drag the **Loop** action from the **Loop** package in the **Actions** palette.
2. Select the **For each mail in mail box** option from the **Iterator** list.
3. In the **Session name** field, enter the name of the session that you used to connect to the email server in the **Connect** action.
4. In the **ALL**, **READ**, or **UNREAD** options, specify the type of email to retrieve from the email server.

Note: For an email server that uses the POP3 protocol, all emails are retrieved.

5. Optional: Specify the folder from which you want to retrieve the emails.

- **Microsoft Outlook** and **Yahoo**: You can specify the name of the folder.

For example, `Inbox`, `Sent`, `Inbox/Sales`, `Inbox/IT` and so on. The `Sales` and `IT` folders in this example are user-created folders and not available by default.

- **Gmail**:

- To retrieve emails from the default folders, you must use `[Gmail]/FOLDER`, except for the `Inbox` folder.

For example, `[Gmail]/Draft`, `[Gmail]/Important`, `[Gmail]/Trash`, and so on.

- To retrieve emails from the folders you have created or the `Inbox` folder, you must specify the folder names as they are.

For example, if you have created folders called `Bank` and `Sports` in your Gmail, specify `Bank` and `Sports` without the `[Gmail]` prefix to retrieve emails from these folders.

- 6.** Optional: In the **When subject contains** field, specify a value to retrieve emails containing the value you specified in their subject.

You can enter multiple text separated by semi-colon. When you specify multiple text separated by semi-colon, the emails are retrieved with any text or combination of text. For example, `[Subject]=[Automation Anywhere]`: The filter searches and retrieves emails where subject text includes Automation or Automation Anywhere.

To know about the behavior of the subject filter for package version 3.13.1-20220713-173156 and later using Microsoft Outlook server or Email server, see [How subject filter works when moving emails](#).

- 7.** Optional: In the **From specific senders** field, specify the email addresses to retrieve the emails.
- 8.** Optional: In the **When received date is on or after** list, select an option to retrieve specific emails on or after a certain date.
- 9.** Optional: In the **When received date is on or before** list, select an option to retrieve specific emails on or before a certain date.

If you have specified values for Steps 6 through 9, the system retrieves only those emails that meet all the criteria. For example, if you specify `Bank` in Step 5, `Statement` in Step 6, and `abcbank@xyz.com` in Step 7, the system retrieves emails from the `Bank` folder that contain `Statement` in the subject and were received from the `abcbank@xyz.com` email address.

- 10.** Choose one of the following options from **Use local timezone**

- True: The email received date and time is displayed in the local time zone.
- False: The email received date and time is displayed in the UTC time zone.
- Variable: Enter a Boolean variable.

- 11.** Optional: In the **Assign the current value to variable** list, select or create a dictionary variable.

The dictionary variable stores the properties of each email. [Using dictionary variable for email properties](#).

- 12.** Click **Save**.

Insert a **Message Box** action into the **Loop** container to print the subject of each email. Use the following message body, substituting the generic variable name for the one you used in Step 10:

```
$dictionaryVar{emailSubject}$
```

Using dictionary variable for email properties

When you automate an email-related task, RPA Workspace retrieves various properties of an email and stores the values of these properties in a dictionary variable. These properties are stored in a dictionary variable when you use an email action within a loop action.

Some of the email properties that RPA Workspace retrieves are its subject, recipients, senders, message, and received date and time. The email properties are stored in a dictionary variable within the following dictionary keys:

Email property	Data type	Description
emailSubject	String	Retrieves the value of the email subject.
emailFrom	String	Retrieves the email ID which is received from. The from address is what your recipients will see.
emailTo	String	Retrieves the recipient's email ID.
emailCc	String	Retrieves the recipient mail id from the CC list.

Email property	Data type	Description
emailBcc	String	Retrieves the recipient mail id from the BCC list.
emailMessage	String	Retrieves the text from the email body.
emailReceivedTime	String	Retrieves the time when the email was received.
emailReceivedDate	String	Retrieves the date when the email was received.
emailSentTime	String	Retrieves the time when the email was sent.
emailSentDate	String	Retrieves the date when the email was sent.

Note: The email received and sent date and time are retrieved in the following format:

- **Date:** dd/MM/yyyy HH:mm:ss
Sample output: 22/09/2022 17:07:13
- **Time:** HH:mm:ss Z
Sample output: 17:07:13 +0900

The system automatically associates the properties of an email with the appropriate dictionary keys. You can use the values stored in these dictionary keys in another task, store them in a database, or for any other purpose. These keys are available in the system and you must use them as specified above. For example, if you have created a dictionary variable 'Test' and want to display the subject and sender of an email in a message prompt, you must enter `Test{emailSubject}` and `Test{emailFrom}` in the appropriate fields.

If you press F2 to use a variable in a field, you must select `Test` from the **Choose a variable** list and enter `emailSubject` in the **Dictionary key** field in the **Insert a variable** dialog box to store the subject of an email in that field. Similarly, you can enter `emailFrom` in the **Dictionary key** field to use the email address of the sender of an email in a field.

The dictionary key variable is required for all email-related tasks you automate from Microsoft Outlook and any mail server if you want to use the email properties. You can use the dictionary key variable for the following **Email** actions:

- **Change status**
- **Delete**
- **Forward**
- **Reply**
- **Save attachments**
- **Save email**

Note: The time required to save an email varies based on the size of the attachments available in that email.

How subject filter works when moving emails

In the **Move all** action and the **Loop** action in the Email package, learn how the subject filter works in order to move your emails from one folder to another in the email or Microsoft Outlook server.

You can use the keywords in the email subject field to filter emails. If keywords are added within quotes, the bot will look for an exact match of keywords in the subject field to filter and retrieve emails.

Outlook server

The following table explains how the subject filter works when the subject field contains single, multiple texts, or multiple subjects separated by semi-colon.

- Single text

Result	Example
With double quotes: Retrieves emails with the exact subject text and is case-sensitive.	Example: [Subject]=["Automation"]: The filter retrieves emails where the subject text includes "Automation" as an exact word.
Without double quotes: Retrieves emails that have the similar text and is not case-sensitive.	Example: [Subject]=[Automation]: The filter searches and retrieves emails where the subject text includes Automation.

- Multiple text

Result	Example
With double quotes: Retrieves emails with the exact subject text and is case-sensitive.	Example: [Subject]=["Automation Anywhere"]: The filter retrieves emails where subject text includes "Automation Anywhere" as an exact phrase.
Without double quotes: Retrieve emails with any text or combination of text and is not case-sensitive.	Example: [Subject]=[Automation Anywhere]: The filter searches and retrieves emails where subject text includes Automation OR Automation Anywhere.

- Multiple subjects separated by semi-colon

Result	Example
With double quotes: Retrieves emails with the complete subject line that is an exact match including the semicolon and double quotation marks.	Example: [Subject 1] =["Delivery Failure"]; [Subject 2] =["Mail server not found"], separated by a semicolon. The filter retrieves emails with the subject line as one string that is an exact match with the semicolon, such as "Delivery Failure ; Mail server not found".

Result	Example
Without double quotes: Retrieve emails with the complete subject line including the semicolon.	<p>Example: [Subject 1]= ["Delivery Failure"];[Subject 2]= ["Mail server not found"], separated by a semicolon.</p> <p>The filter retrieves emails with the subject line that includes text as one string with the semicolon but is not an exact match, such as: Delivery Failure ; Mail server not found or delivery failure ; mail server not found.</p>
Some with double quotes and some without double quotes: Retrieve emails with the complete subject line that is an exact match including the semicolon.	<p>Example: [Subject 1]= [Delivery Failure];[Subject 2]= ["Mail server not found"], separated by a semicolon.</p> <p>The filter retrieves emails with the subject line as one string that is an exact match with the semicolon, such as: Delivery Failure ; Mail server not found.</p>

Email server

The following table explains how the subject filter works when the subject field contains single, multiple texts, or multiple subjects separated by semi-colon.

- Single text

Result	Example
With double quotes: Retrieves emails with the exact subject text and is case-sensitive.	Example: [Subject]=["Automation"]: The filter retrieves emails where the subject text includes "Automation" as an exact word.
Without double quotes: Retrieves emails that have the similar text and is not case-sensitive.	Example: [Subject]=[Automation]: The filter searches and retrieves emails where the subject text includes Automation.

- Multiple text

Result	Example
With double quotes: Retrieves emails with the exact subject text and is case-sensitive.	Example: [Subject]=["Automation Anywhere"]: The filter retrieves emails where subject text includes "Automation Anywhere" as an exact phrase.
Without double quotes: Retrieve emails with any text or combination of text and is not case-sensitive.	Example: [Subject]=[Automation Anywhere]: The filter searches and retrieves emails where subject text includes Automation OR Automation Anywhere.

- Multiple subjects separated by semi-colon

Result	Example
With double quotes: Retrieve emails for each subject that is an exact match and is case-sensitive.	<p>Example: [Subject 1] =["Delivery Failure"];[Subject 2] =["Mail server not found"]</p> <p>Individual subjects separated by a semicolon with an exact match are searched. The filter retrieves emails with the subject line "Delivery Failure" and/or "Mail server not found".</p>
Without double quotes: Retrieve emails for each subject and is not case-sensitive.	<p>Example: [Subject 1]= [Delivery Failure];[Subject 2]= [Mail server not found]</p> <p>The filter retrieves emails that include the subject line with text as Delivery Failure or Mail server not found.</p>
Some with double quotes and some without double quotes: Retrieve emails for each subject. Subjects within double quotation marks are an exact match. Subjects without double quotes are not case-sensitive.	<p>Example: [Subject 1]= [Delivery Failure];[Subject 2] = ["Mail server not found"]</p> <ul style="list-style-type: none"> • For Subject 1, the filter searches and retrieves emails that include the text in the subject line. • For Subject 2, the filter searches and retrieve emails with the exact text in the subject line.

Error handler package

If a bot encounters an error due to an abnormal condition or exceptions during execution, the normal execution of the bot is hindered, and the bot fails to complete the task. The Error handler package contains actions that enable you to easily handle exceptions a bot encounters and transfers control to the other actions within that bot.

The actions in the package enable you to separate the actions you want to use to perform a task from the actions you want to use to handle an exception. Handling exceptions ensures that a bot completes a task when it encounters an error and defines actions when an error occurs.

The following image illustrates how bot execution works when you use and do not use error handling in your task.

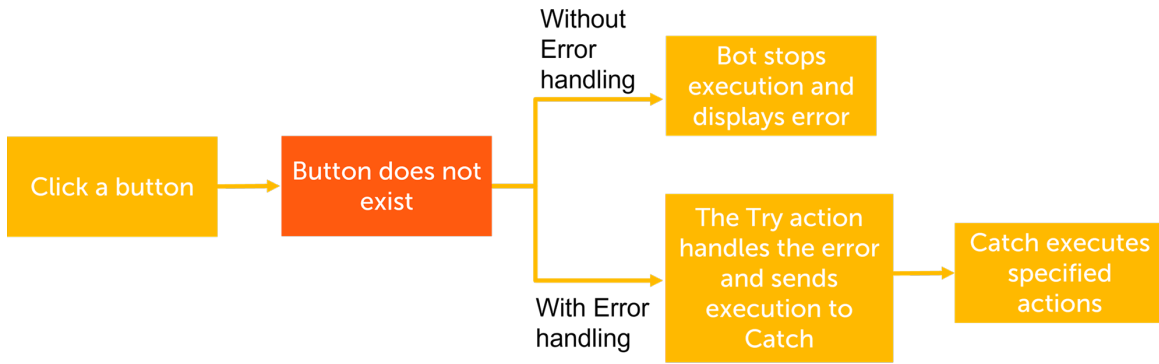

Actions in the Error handler package

The Error handler package includes the following actions:

Action	Description
Try	You can add actions within the Try action and the bot executes these actions as usual. If the bot does not encounter any errors, execution continues to the Finally action if it exists. However, if an error occurs, bot execution moves directly to the Catch action and does not complete the rest of the actions inside the Try action.
Catch	<p>If an error occurs within a Try action, the bot execution transfers control directly to the Catch action. You can assign values for the error description and the line number to variables within the Catch action. You can add additional actions within the Catch action to handle the error condition. These actions can include an Email Send action (sending an email about the error), a Log to file action (logging the error condition to a file), or a Screen Capture window to capture a screenshot of the window or application when the error occurs.</p> <p>If a Catch action is not present, the Try action, upon experiencing an error, will continue processing actions listed after the Try action.</p> <p>You can use the Try and Catch actions multiple times in a bot to handle various exceptions. This enables you to run a different set of actions based on the exception encountered.</p> <p>You can now ignore errors from actions inside the Catch block by using the Catch > On error, continue with next action option. When you select the On error, continue with next action check box, even if there is an error from an action in the Catch block, no exception is thrown and the bot ignores the error and continues to the next action.</p> <hr/> <p>Note: This enhancement applies to all nested actions in the Catch block. For example, if you have a Try/Catch action inside a main Catch action, if the check box is selected on the main Catch action, any error from actions within the nested block will also be ignored.</p> <hr/>
Finally	The Finally action enables you to execute actions after Try and Catch , regardless of whether an exception occurs or not. The Finally action is most useful in logging audit information or any action that must follow the end of the Try and Catch actions.

Action	Description
Throw	If a logical error occurs within a Try action, you can use the Throw action to create an error condition, which will immediately shift the bot execution to the Catch action. You can edit the Throw action properties to set the error message to be sent to the Catch action. Outside of a Try action, the Throw action causes a standard error dialog box to be displayed, requiring a user to manually click the Close button to dismiss it.

How Error handler handles exceptions

The following image illustrates the flow of actions of the Error handler package when an external error is encountered during bot execution.

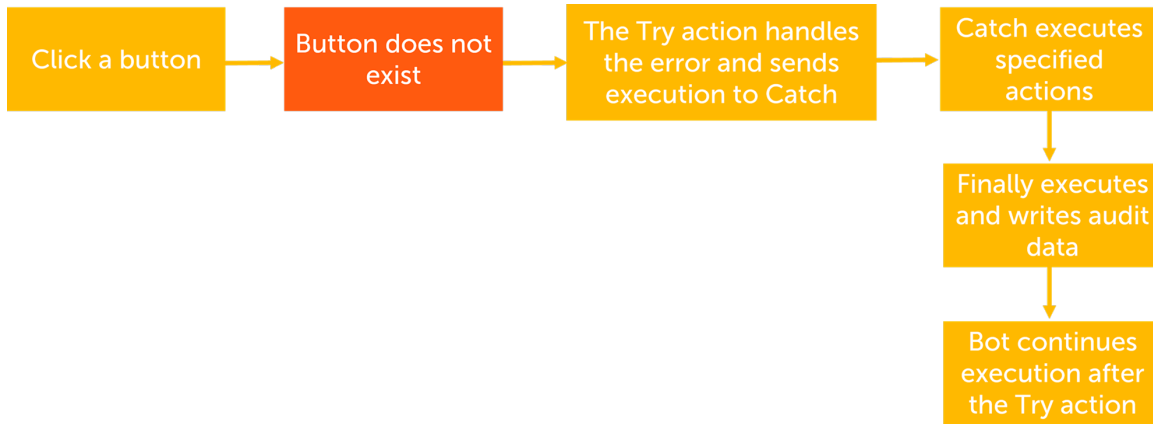

The following image illustrates the flow of actions of the Error handler package when an internal error is encountered during bot execution.

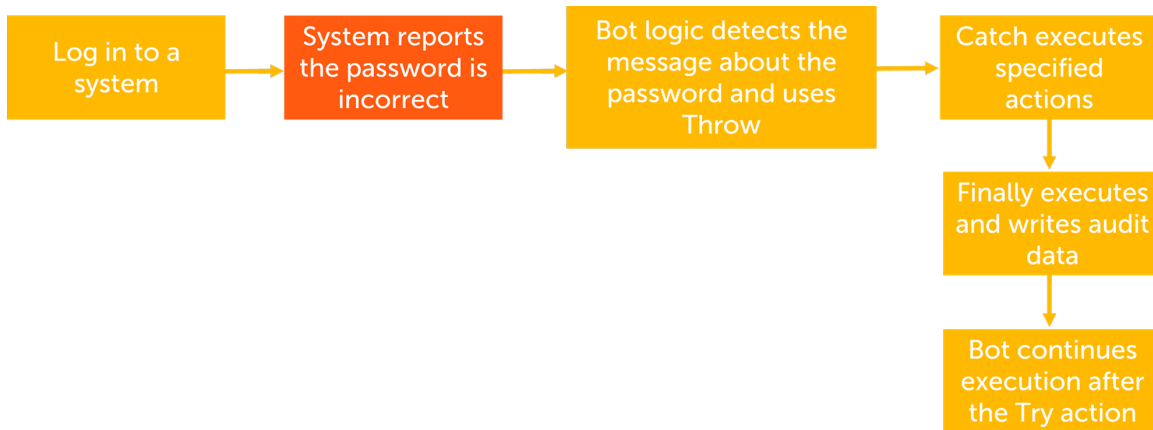

Example: Using the actions in the Error handler package

For example, if you have a bot that reads data from a Microsoft Excel file and stores it in a database. The bot might encounter an error if the required file is not available or while updating a table in the database. Use the following methods to handle the errors:

- Exception 1:
 - The Microsoft Excel spreadsheet from which you want to extract data is not available.
 - **How to handle:** Use another file that contains the same data.
- Exception 2:
 - The table that you want to use to store the data is not available in the database.
 - **How to handle:** Display a message that the required table is not available.

Based on this example, perform the following to handle the mentioned exceptions:

1. Place all the actions that are for reading the data from the Microsoft Excel spreadsheet and storing the extracted data into a table in the database within the **Try** action.
2. Place the actions to run for the following exceptions within the **Catch** action:
 - a. Exception 1: Place the actions to use the alternate file that contains the same data.
 - b. Exception 2: Place the **Message box** action to display a relevant message.
3. Place the **Database > Disconnect** action to terminate the connection with the database within the **Finally** action, which occurs regardless of the **Try** outcome.

Excel basic package

The Excel basic package contains actions that enable you to automate many of the repetitive tasks in XLSX workbooks. You use these actions when Microsoft Excel is not available on the device that you want to use to automate Microsoft Excel-related tasks.

Note: The XLS and CSV formats are not supported and you cannot set a value in the XFD column of a spreadsheet.

Important: If you use different versions of the Excel basic package in a parent bot and a child bot, the capability to share a session across bots is currently not supported. To share a session across parent and child bots, ensure that you use the same version of the package in both the parent and child bots.

Choosing the Excel package in Automation 360

Automation 360 includes packages to support three types of Microsoft Excel usage. For optimal results, use the package that corresponds to the type of Excel that is available on the device you are running bots on.

- **No Excel installed:** If you do not have Microsoft Excel installed on the device on which you are running bots to automate Excel-related processes, use the Excel basic package.
- **Desktop Excel installed:** If you have a desktop version of Microsoft Excel installed on your computer, use the Excel advanced package in your bots.

- **Online Office 365 Excel only:** If you are using Microsoft Excel 365 on a web browser, use the Office 365 Excel package for automating tasks related to Excel.

Recommendation: For any bot automation use case that cannot be fulfilled by the Excel basic package, we recommend that you use the Excel advanced package. When you use that Excel basic package, you might experience limitations because of the Apache POI API that the package uses. Because of this, the Excel basic package has limited capability when compared to the Excel advanced package that uses the MS API.

To learn more, search for the *Automating Excel Workbooks* course in [Automation Anywhere University: RPA Training and Certification \(A-People login required\)](#).

Before you start

Perform the following actions within the Excel basic package as part of using the set of available actions:

1. Open the Microsoft Excel spreadsheet that you want to read data from using the **Open** action.

Note: The Excel basic package supports files that are a maximum size of 30 MB.

You must associate the details of the file you want to use with a session name, and use the session name in the other actions in the Excel basic package, so that you do not have to provide the details of the file in those actions again.

2. Use the different actions available in the Excel basic package to automate the Microsoft Excel-related tasks.
3. After you have automated all the Microsoft Excel-related tasks, close the spreadsheet using the **Close** action.

Actions in the Excel basic package

The Excel basic package includes the following actions:

Action	Description
Close	See Close action .
Delete cells	. See Delete cells action .
Find	See Using Find action in Excel .
Get cell address	See Get cell address action .
Get column name	See Get column name action .
Get multiple cells	See Get multiple cells action .
Get row number	See Get row number action .

Action	Description
Get single cell	. See Get single cell action .
Go to cell	. See Go to cell action .
Open	See Using the Open action .
Replace	See Using the Replace action .
Save workbook	See Save workbook action .
Set cell	See Set cell action .
Switch to sheet	See Switch to sheet action .

Close action

The Close action in the Excel basic package enables you to close an excel spreadsheet and **Save changes** when closing the file.

Settings

Closes the current workbook and provides an option to **Save changes** when closing the file. Enter the name of the session used to open the workbook with the **Open** .

Note: This action terminates the process for the session.

Delete cells action

The Delete cells action in the Excel basic package enables you to delete the **Active cell** or a **Specific cell** from the current worksheet.

Settings

- Select the **Active cell** or **Specific cell** option to specify whether to retrieve the values from the active cell or a specific cell.
- Select the **Shift cells left** or **Shift cells up** option to specify whether to shift the cell one position to the left or up after the cell is deleted.
- Select the **Entire row** or **Entire column** option to specify whether to delete the entire row or column of the cell.
- Enter the name of the session used to open the workbook with the **Open** .

Get multiple cells action

The Get multiple cells action in the Excel basic package enables you to retrieve the values from cells in a Microsoft Excel spreadsheet and stores them in a table variable.

Settings

This action retrieves cell values as string data types. It supports Excel cell formats, including Number, Percentage, Currency, Scientific, and Date. For example, a value from a cell of Currency formatting retains the currency symbol when passed to a table or record variable.

Note: You must convert the values to perform non-string operations.

- Select any of the following options from the **Loop through** field:

Option	Action
All rows:	Enables you to retrieve the values from all the rows.
Specific row:	Enables you to retrieve the values from the row you have specified in the From row and to row fields.
Cell range:	Enables you to retrieve the values from the range of cells you have specified in the From cell and to cell field.

- Enter the name of the session used to open the workbook with the **Open** .
- In the **Get value to the variable (optional)** field, create or insert an existing string variable.

Get single cell action

The Get single cell action in the Excel basic package enables you to retrieve the values from a single cell in a Microsoft Excel spreadsheet and stores them in a string variable .

Settings

This retrieves cell values as string data types. It supports Excel cell formats, including Number, Percentage, Currency, Scientific, and Date. For example, a value from a cell of Currency formatting retains the currency symbol when passed to a table or record variable.

Note: You must convert the values to perform non-string operations.

- Select the **Active cell** or **Specific cell** option to specify whether to retrieve the values from the active cell or a specific cell.
- Enter the name of the session used to open the workbook with the **Open** .
- In the **Store cell contents to** field, create or insert an existing string variable.

You can use the output value to

[Example of using a conditional statement](#)

.

Get cell address action

The Get cell address action in the Excel basic package enables you to retrieve the location of the active cell and stores it to a string variable.

Settings

- Enter the name of the session used to open the workbook with the **Open** .
- In the **Save the active cell address in local variable** field, create or insert an existing string variable.

Get column name action

The Get column name action in the Excel basic package enables you to retrieve the letter value of the column of the active or specific cell and store it to a string variable.

Settings

- Select the **Active cell** or **Specific cell** option to specify whether to retrieve the column name from the active cell or a specific cell.
- Enter the name of the session used to open the workbook with the **Open** .
- In the **Save the column name into local variable** field, create or insert an existing string variable.

Get row number action

The Get row number action in the Excel basic package enables you to retrieve the row number of the active or specific cell and stores it to a string variable.

Settings

- Select the **Active cell** or **Specific cell** option to specify whether to retrieve the row number from the active cell or a specific cell.
- Enter the name of the session used to open the workbook with the **Open** .
- In the **Save the row number into local variable** field, create or insert an existing string variable.

Go to cell action

The Go to cell action in the Excel basic package enables you to select a specific cell in a Microsoft Excel spreadsheet.

Settings

- Select the **Active cell** or **Specific cell** option to specify which cell to select.
- Enter the name of the session used to open the workbook with the **Open** .

Using the Open action for Excel basic

Use the **Open** action to open a Microsoft Excel spreadsheet with `.xlsx` extension. This action enables you to specify whether to open the spreadsheet in read-only mode or read-write mode, a password to open the spreadsheet, and so on.

To open a Microsoft Excel spreadsheet, do the following:

1. Double-click or drag the **Open** action from the **Excel basic** package in the **Actions** palette.
2. Select from where you want to open the Microsoft Excel spreadsheet:

Note: The Excel basic package supports files that are a maximum size of 30 MB.

- **Control Room file:** Enables you to open a file from the Control Room.
 - **Desktop file:** Enables you to open a file from the device. This field also accepts the file path input as a string variable or global value.
 - **Variable:** Enables you to open a file by specifying a file variable.
3. Select the **Sheet contains a header** check box if the Microsoft Excel spreadsheet contains a header row.
 4. Select the **Specific sheet name** option and specify the name of the sheet to activate when the Microsoft Excel spreadsheet opens.
 5. Select **Read-only mode** or **Read-write mode** to open the Microsoft Excel spreadsheet in read-only or edit mode, respectively.
 6. Select the **Password is required** check box if a password is required to open the Microsoft Excel spreadsheet.
 7. Select any of the following tabs to create an Excel session:
 - **Local session:** Specify a session name that can be used only in the current bot.
 - **Global session:** Specify a session name that can be used across multiple bots, such as parent bots, child bots, and other child bots of the parent bots.

You can also use the **Global session** option to loop through each row in an Excel advanced worksheet.

Note: You can open an Excel worksheet by using the **Global session** option and use it across multiple bots without having to share the session by using the **Set session variable** action.

You can also close the session from the child bot when you are using the **Global session** option and sharing the session across child bots.

Important: If you close the session from the child bot and run the parent bot, then in the parent bot, the actions that come after the child bot are not run, and the bot fails with an error because the session has already been closed from the child bot.

- **Variable:** Specify a session variable that can be used to share that session with other child bots.

Note: When you use more than one spreadsheet to automate an operation, you must use different session names for each spreadsheet. If you want to use the same session name to automate all the spreadsheets, you must first close the session of one spreadsheet before using the same session name for another spreadsheet.

8. Enter the name of the session in the **Session name** field.
9. Click **Save**.

Save workbook action

The Save workbook action in the Excel basic package enables you to save a Microsoft Excel spreadsheet to a specified location.

Settings

Enter the name of the session used to open the workbook with the **Open** .

Note: When you open an excel file from the Control Room and make changes in the file, the updated file does not save in the Control Room This action is supported only for Excel files opened from the desktop.

Set cell action

The Set cell action in the Excel basic package enables you to set the value you have specified in a cell in a Microsoft Excel spreadsheet.

Settings

- Select the **Active cell** or **Specific cell** option to specify whether to set the value in the active cell or a specific cell.
- Enter the cell value to set in the **Value to set** field.
- Enter the name of the session or variable used to open the workbook with the **Open** action.

Switch to sheet action

The Switch to sheet action in the Excel basic package enables you to activate a specific worksheet.

Settings

- Select to activate the worksheet by the **Index** value or worksheet **Name**.
The index is the numeric value assigned to the worksheet.
- Enter the name of the session used to open the workbook with the **Open** .

Excel advanced package

The Excel advanced package contains actions that enable you to automate many of the repetitive tasks when working with Microsoft Excel spreadsheets.

You can automate tasks related to the workbook, worksheet, rows, columns, and cell operations. You can use these actions when Microsoft Excel is installed on the device that you want to use to automate the Microsoft Excel-related tasks.

Note: If your current office installation is any of the following:

- Microsoft 365 Apps for Enterprise
- Office 2016, 2019, or 2021 (Consumer Version 2009 or later)

Then you do not need to install the Microsoft Access Database Engine as an additional component in your system.

However, if you have both Microsoft 365 Apps and the Microsoft Access Database Engine are installed on your system, then you can uninstall the Microsoft Access Database Engine and repair Microsoft 365 Apps.

Microsoft recommends that you do not install the Microsoft Access Database Engine driver separately because both the Microsoft Access Database Engine 2016 and Microsoft 365 Apps use the same major version identifier (16.0). To learn more about the Microsoft Access Database Engine driver installation requirement, see [Unable to use the Access ODBC or OLEDB provider](#)

Important: If you use different versions of the Excel advanced package in a parent bot and a child bot, the capability to share a session across bots is currently not supported. To share a session across parent and child bots, ensure that you use the same version of the package in both the parent and child bots.

Note: The Excel file that you use from the Control Room is applicable only for the current bot session. If you modify the file during bot execution, the updated file cannot be uploaded back to the Control Room.

Actions in the Excel advanced package support Microsoft Office 2016 through Microsoft Office 2019, Microsoft Office 365, and the following file formats:

- .xls
- .xlsx
- .xlsb
- .xml
- .xlsm
- .txt
- .ods
- .htm
- .html
- .mht
- .mhtml
- .slk
- .pdf

Important:

- For files with .ods extension, unless you specify the sheet name in the **Specify sheet name** field of the **Open** action, the action always opens the .ods file with the first sheet as active, by default. If the sheet name contains a space character, after you save and close the Excel sheet, the space character is displayed as underscore.
- Files with the .htm, .html, .mht, and .mhtml extensions cannot be converted into PDF.
- Files with the .slk and .pdf extensions contain only a single sheet. The sheet cannot be renamed. If you rename the sheet and save the Excel sheet, the sheet does not retain the new name.
- Files with .htm, .html, .mht, .mhtml, .slk, and .pdf extensions cannot retain passwords.
- You cannot run a macro in files with the .pdf extension.
- **Note:** Macro-enabled Excel applications with VBA using 32-bit and 64-bit code are not supported. If you encounter a `Compile error in hidden module` error message when

running a macro, then see the following image to add the VBA code manually in the Excel file

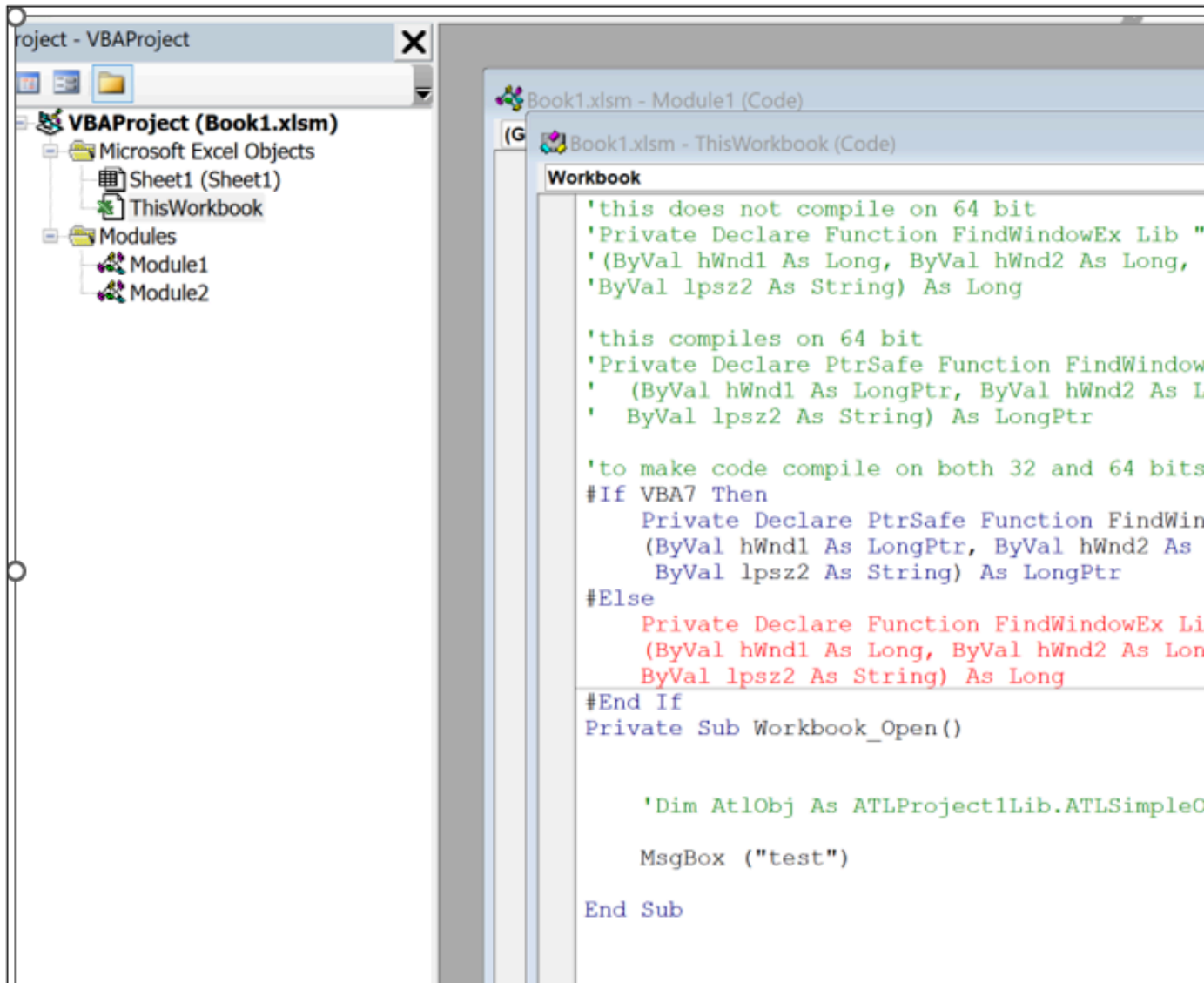

You can also use some of the actions with the .csv format. See [CSV operations in Excel advanced](#).

See [Example of migrating data from Excel to a database](#).

Choosing the Excel package in Automation 360

Automation 360 includes packages to support three types of Microsoft Excel usage. For optimal results, use the package that corresponds to the type of Excel that is available on the device you are running bots on.

- **No Excel installed:** If you do not have Microsoft Excel installed on the device on which you are running bots to automate Excel-related processes, use the Excel basic package.
- **Desktop Excel installed:** If you have a desktop version of Microsoft Excel installed on your computer, use the Excel advanced package in your bots.
- **Online Office 365 Excel only:** If you are using Microsoft Excel 365 on a web browser, use the Office 365 Excel package for automating tasks related to Excel.

Before you start

Perform the following actions within the Excel advanced package as part of using the set of available actions:

1. Open the Microsoft Excel spreadsheet that you want to use to automate the Microsoft Excel-related tasks. Use the **Open** action to open the spreadsheet. See [Using the Open action for Excel advanced](#).

Note: For files containing large data sets, use actions from the Database package to automate create, read, and update operations. See [Using Connect action for database](#).

2. Use the different actions available in the Excel advanced package to automate the Microsoft Excel-related tasks.
3. After you have automated all the Microsoft Excel-related tasks, close the spreadsheet using the **Close** action.

Actions in the Excel advanced package

The actions in the Excel advanced package enable you to perform the following operations:

Action	Description
Cell operations	Perform operations such as extracting data from cells, deleting values from a cell, moving a cursor to a specific cell, and finding and replacing content. See Cell operations in Excel advanced .
Row and column operations	Perform operations such as inserting new rows and columns, and hiding and unhiding rows and columns. See Row and column operations in Excel advanced .
Table operations	Perform operations such as sorting and filtering data in a table, inserting and deleting columns, and getting the table range. See Table operations in Excel advanced .
Workbook operations	Perform operations such as opening a workbook, appending data, protecting and unprotecting a workbook, and converting a Microsoft Excel workbook to a PDF file. See Workbook operations in Excel advanced .
Worksheet operations	Perform operations such as creating and deleting a worksheet, appending data, and hiding and unhiding a worksheet. See Worksheet operations in Excel advanced .

Example tasks:

- [Example of transferring data from CSV file to Excel worksheet](#)
 - [Example of using a conditional statement](#)
-

More resources

- Free Automation 360 bot examples for Excel from Bot Store:
 - [Merge Excel Sheets Example](#)
 - [Convert XML to Excel](#)
 - [Convert multiple Excel files to CSV files](#)
- Tutorial on using Excel packages: [Work with large Excel datasets in a bot](#)
- Training course [Automating Excel Workbooks - Automation Anywhere University: RPA Training and Certification \(A-People login required\)](#)

Related tasks

Using Find action in Excel

Use the **Find** action to find a particular string in a Microsoft Excel spreadsheet or a CSV file.

Workbook operations in Excel advanced

A workbook is a file that contains one or more worksheets. The **Excel advanced** package contains various actions that you can use to automate workbook-related tasks.

Workbook actions in the Excel advanced package

The **Excel advanced** package includes the following actions:

Action	Description
Append workbook	See Append workbook action
Close	See Close action
Convert excel to PDF	See Convert excel to PDF action
Create workbook	See Create workbook action
Open	See Using the Open action for Excel advanced.
Protect workbook	See Protect workbook action
Save workbook	See Save workbook action
Unprotect workbook	See Unprotect workbook action

Append workbook action

The Append workbook action in the Excel advanced package enables you to add all the worksheets from the specified workbook to the end of the currently open workbook.

Settings

- Enter the name of the session used to open the workbook with the **Open** .
- Specify the workbook from which you want to append the worksheets in the **Append from workbook** field.
- If the workbook is protected, select the **Password is required** check box and enter the password in the **To open** field.
- In the **To open** field, provide your password with one of the following options:

- **Credential:** Select a credential from the . [Credentials and credential variables in the Bot editor](#)
- **Variable:** Select a variable holding a credential data type value. [Your variables \(user-defined\)](#)
- **Insecure string:** Enter a value or select a variable.



Attention: Values entered using this option are not encrypted.

Close action

The Close action in the Excel advanced package enables you to close the current workbook and provide an option to save changes when closing the file.

Settings

Enter the name of the session used to open the workbook with the **Open** .

Convert excel to PDF action

The Convert excel to PDF action of the Excel advanced package enables you to convert the entire workbook, specific worksheets in a workbook, or a CSV file to a PDF file.

Settings

- Enter the name of the session used to open the workbook with the **Open** .
- Specify whether you want to convert the **Entire excel file**, **Active sheet**, or **Specific sheet** to a PDF file.
- Enter a name for the PDF file in the **Select PDF file name** field.
- Specify the location where you want to save the file in the **Select PDF storage location** field.

Create workbook action

The Create workbook action of the Excel advanced package enables you to create a Microsoft Excel workbook or a CSV file.

Settings

- Enter the name of the session used to open the workbook with the **Open** .
- Specify the location where you want to save the workbook in the **File path** field.
- Specify the name of the worksheet in the **Sheet name** field.
- Specify the passwords to open and edit the workbook in the **Password to open** and **Password to edit** fields. Provide your password with one of the following options:
 - **Credential:** Select a credential from the . [Credentials and credential variables in the Bot editor](#)
 - **Variable:** Select a variable holding a credential data type value. [Your variables \(user-defined\)](#)
 - **Insecure string:** Enter a value or select a variable.



Attention: Values entered using this option are not encrypted.

- Select any of the following tabs to create an Excel session:
 - **Local session:** Specify a session name that can be used only in the current bot.
 - **Global session:** Specify a session name that can be used across multiple bots, such as parent bots, child bots, and other child bots of the parent bots.

You can also use the **Global session** option to loop through each row in an Excel advanced worksheet.

Note: You can open an Excel worksheet by using the **Global session** option and use it across multiple bots without having to share the session by using the **Set session variable** action.

You can also close the session from the child bot when you are using the **Global session** option and sharing the session across child bots.

Important: If you close the session from the child bot and run the parent bot, then in the parent bot, the actions that come after the child bot are not run, and the bot fails with an error because the session has already been closed from the child bot.

- **Variable:** Specify a session variable that can be used to share that session with other child bots.

Note: If the Microsoft sensitivity label feature is enabled for Office 365 Excel application, see [Automation Anywhere interaction with Microsoft Labels \(A-people login required\)](#)

Using the Open action for Excel advanced

Use the **Open** action to open a Microsoft Excel spreadsheet or a CSV file. This action enables you to specify whether to open the spreadsheet in read-only mode or read-write mode, a password to open the spreadsheet, and so on.

When you use the Open action to open a macro-enabled Excel workbook of `.xlsm` format, the `Auto_Open` VBA procedure does not run automatically because the VBA procedure runs only when the Excel workbook is opened manually. This is a default behavior of Microsoft Excel. See [Behavior difference between Workbook_Open and Auto_Open procedure](#).

Note: You can use wildcard pattern based search to open an existing excel file that matches the search criteria. For example, if you have multiple files with similar names such as `table1.xlsx`, `table2.xlsx`, `table3.xlsx`, you can open the file by specifying the (*) wildcards in the file path as `table*.xlsx` to open the first file that matches the pattern.

1. Double-click or drag the **Open** action from the **Excel advanced** package in the **Actions** palette.
2. Select from where you want to open the Microsoft Excel spreadsheet:
 - **File:** Select one of the following options to open a Microsoft Excel spreadsheet:
 - **Control Room file:** Enables you to open a file from the Control Room.
 - **Desktop file:** Enables you to open a file from the device. This field also accepts the file path input as a string variable or global value.

Note: In the **Desktop file** field, if you enter a file path or browse to a particular file from the system and if the file path is separated by the backslash (\) characters, when you save the bot, the backslash characters are changed to slash (/) characters because the bot uses slash

characters to separate file paths. Your bots continue to run successfully even if the backslash characters are is changed to slash characters during bot run.

- **Variable:** Enables you to open a file by specifying a file variable.
- **SharePoint:** In the **File path** field, enter the exact file path of the Excel spreadsheet on SharePoint. To copy the URL of the Excel spreadsheet from SharePoint, perform the following steps:
 - Open the Microsoft Excel spreadsheet on SharePoint.
 - In the Microsoft Excel spreadsheet, navigate to **File > Info**.
 - Click **Copy path**.

<https://aa2019packagesdkfordocumentation.s3-us-west-2.amazonaws.com/videos/copy-url-excel-sharepoint.mp4>

3. Select the **Sheet contains a header** check box if the Microsoft Excel spreadsheet contains a header row.
4. Select the **Specific sheet name** option and specify the name of the sheet to activate when the Microsoft Excel spreadsheet opens.
5. Select **Read-only mode** or **Read-write mode** to open the Microsoft Excel spreadsheet in read-only or edit mode respectively.
6. Select the **Password is required** check box if a password is required to open or edit the Microsoft Excel spreadsheet.
7. Select the **Load Add-ins** check box if you want to load the add-ins available in the Microsoft Excel spreadsheet.
8. Select the **Exclude hidden sheets** check box if you want to ignore the excel sheets that are hidden and do not want to perform any operation on those hidden sheets.
9. Select any of the following tabs to create an Excel session:
 - **Local session:** Specify a session name that can be used only in the current bot.
 - **Global session:** Specify a session name that can be used across multiple bots, such as parent bots, child bots, and other child bots of the parent bots.

You can also use the **Global session** option to loop through each row in an Excel advanced worksheet.

Note: You can open an Excel worksheet by using the **Global session** option and use it across multiple bots without having to share the session by using the **Set session variable** action.

You can also close the session from the child bot when you are using the **Global session** option and sharing the session across child bots.

Important: If you close the session from the child bot and run the parent bot, then in the parent bot, the actions that come after the child bot are not run, and the bot fails with an error because the session has already been closed from the child bot.

- **Variable:** Specify a session variable that can be used to share that session with other child bots.

Note: When you use more than one spreadsheet to automate an operation, you must use different session names for each spreadsheet. If you want to use the same session name to automate all the spreadsheets, you must first close the session of one spreadsheet before using the same session name for another spreadsheet.

10. Click **Save**.

Protect workbook action

The Protect workbook action of the Excel advanced package enables you to protect the workbook and its structure using a password. Protecting a workbook prevents other users from opening the workbook without the password, and protecting the structure of a workbook prevents other users from adding, moving, deleting, hiding, and renaming worksheets within that workbook.

Settings

- Enter the name of the session used to open the workbook with the **Open** .
- Select the **Protect workbook** and **Protect workbook structure** check boxes and provide a password in the respective fields.

Save workbook action

The Save workbook action of the Excel advanced package enables you to save the current workbook.

Settings

Enter the name of the session used to open the current workbook with the **Open** action.

Note: When you open an Excel file from the Control Room and make changes to the file, the updated file is not saved in the Control Room. This action is supported only for Excel files opened from the desktop.

Unprotect workbook action

The Unprotect workbook action of the Excel advanced package enables you to unprotect a workbook and its structure. Unprotecting a workbook removes the restriction applied on opening the workbook, and unprotecting the structure of a workbook removes the restriction applied on modifying the structure of the workbook. Unprotecting allows other users to open the workbook, add, move, delete, hide, and rename worksheets within the workbook.

Settings

- Enter the name of the session used to open the workbook with the **Open** .
- Select the **Unprotect workbook** and **Unprotect workbook structure** check boxes and provide a password to unprotect the workbook structure.

Worksheet operations in Excel advanced

The **Excel advanced** package contains various actions that you can use to automate worksheet-related tasks.

Worksheet actions in the Excel advanced package

The **Excel advanced** package includes the following actions:

Action	Description
Access password protected worksheet	See Access password protected worksheet action
Append worksheet	See Using Append worksheet action.
Create worksheet	See Create worksheet action

Action	Description
Delete worksheet	See Delete worksheet action
Disable or enable real-time screen update	See Disable or enable real-time screen update action
Get current worksheet name	See Get current worksheet name action
Get worksheet as data table	See Get worksheet as data table action
Get worksheet names	See Get worksheet names action
Hide worksheet	See Hide worksheet action
Password protect worksheet	See Password protect worksheet action
Rename worksheet	See Rename worksheet action
Retrieve sheets count	See Retrieve sheets count action
Run macro	See Run macro action
Switch to sheet	See Switch to sheet action
Unhide all worksheets	See Unhide all worksheets action
Unhide worksheet	See Unhide worksheet action
Write from data table	See Write from data table action

Access password protected worksheet action

The Access password protected worksheet action of the Excel advanced package enables you to access a password-protected worksheet in the current workbook.

Settings

- Enter the name of the session used to open the workbook with the **Open** .
- Enter the password to access the worksheet.

Using Append worksheet action

Use the **Append worksheet** action to append a worksheet from another workbook to the current workbook.

Note: If the current workbook already has a worksheet with the same name, you must rename the worksheet being appended.

To append a worksheet, do the following:

1. Double-click or drag the **Append worksheet** action from the **Excel** node in the **Actions** palette.

2. Select an option to specify the location of the spreadsheet from which you want to append the worksheet:
 - **From 'My bots'**: Enables you to open a Microsoft Excel spreadsheet from an existing bot.
 - **From local device**: Enables you to open a Microsoft Excel spreadsheet from a local device.
 - **Select an existing file variable**: Enables you to open a Microsoft Excel spreadsheet using a file variable.
3. Select the **Password is required** option if the Microsoft Excel spreadsheet requires a password to open it.
4. Optional: In the **User password** or **Owner password** field, enter a password to restrict access to the encrypted PDF file.
 - **User password**: Allow users to perform specific operations on the encrypted PDF file.
 - **Owner password**: Allow users to use a password to open the file.
5. Select the **Enter worksheet name** or **Enter worksheet index** option to specify the name or number of the worksheet that you want to append.
6. Enter the name of the session used to open the workbook with the **Open** .
7. Click **Save**.

Create worksheet action

The Create worksheet action of the Excel advanced package enables you to create a worksheet in the current workbook.

Settings

- Enter the name of the session used to open the workbook with the **Open** .
- Specify either an index number in the **Sheet by Index** field or a name in the **Sheet by Name** field for the worksheet. The index number is the number assigned to a worksheet. For example, if you want to perform an operation on the worksheet at the third position in the workbook, enter 3 in the field.

Delete worksheet action

The Delete worksheet action of the Excel advanced package enables you to delete a spreadsheet from the current workbook.

Settings

- Enter the name of the session used to open the workbook with the **Open** .
- Specify either an index number in the **Sheet by Index** field or a name in the **Sheet by Name** field for the worksheet. The index number is the number assigned to a worksheet. For example, if you want to perform an operation on the worksheet at the third position in the workbook, enter 3 in the field.

Note: You can delete a worksheet only if the workbook contains more than one worksheet.

Disable or enable real-time screen update action

The Disable or enable real-time screen update action of the Excel advanced package enables you to disable the real-time screen update.

Settings

- Select the **Disable** option to disable real-time screen update when you perform actions in a Microsoft Excel worksheet with large data sets.
- Select the **Enable** option to re-enable real-time screen update for other, subsequent actions.
- Enclose the action that has performance issues within the **Disable or enable real-time screen update** action.

For example, if you are using the **Run macro** action to run a macro on a worksheet that has large data sets and if you are facing performance issues, use the **Disable or enable real-time screen update** action before the **Run macro** action and select the **Disable** option to disable real-time screen update for enhanced performance. Use the **Disable or enable real-time screen update** action again after the **Run macro** action and select the **Enable** option to re-enable real-time screen update for other, subsequent actions.

Important: We recommend using this action only if you face performance issues when you run actions with large data sets.

Get current worksheet name action

The Get current worksheet name action of the Excel advanced package enables you to get the name of the current worksheet and assign it to a string variable.

Settings

- Enter the name of the session used to open the workbook with the **Open** .
- Select a string variable that you want to use to store the name of the worksheet from the **Assign the output to variable** list. The shows a descriptive default variable name. If you create several output variables, subsequent variable names are appended with a -1 , -2 , -3 , and so on to avoid duplication.

Get worksheet as data table action

The Get worksheet as data table action of the Excel advanced package enables you to get data from a worksheet and save it to a table variable.

Settings

- Specify either an index number in the **Sheet by Index** field or a name in the **Sheet by Name** field for the worksheet. The index number is the number assigned to a worksheet. For example, if you want to perform an operation on the worksheet at the third position in the workbook, enter 3 in the field.
- Choose from the **Read** option to read either the visible text or value of the cell.

For example, if the cell has 70% as cell content, **Read cell value** option will read the value as 70 ignoring the % format whereas **Read visible text** option will read the content as 70%.

Recommendation: Use option **Read cell value** as reading value from a cell gives better performance than reading a visible text.

- Enter the name of the session used to open the workbook with the **Open** .
- Select a table variable that you want to use to store the data from the worksheet from the **Assign value to the variable** list. The shows a descriptive default variable name. If you create several

output variables, subsequent variable names are appended with a -1, -2, -3, and so on to avoid duplication.

Get worksheet names action

The Get worksheet names action of the Excel advanced package enables you to get the names of all the worksheets and assign them to a list variable of string data type.

Settings

- Enter the name of the session used to open the workbook with the **Open** .
- Select a string variable that you want to use to store the name of the worksheet from the **Assign the output to variable** list. The shows a descriptive default variable name. If you create several output variables, subsequent variable names are appended with a -1, -2, -3, and so on to avoid duplication.

Hide worksheet action

The Hide worksheet action of the Excel advanced package enables you to hide a worksheet from the current workbook.

Settings

- Specify the name of the worksheet to hide in the **Enter worksheet name to hide** field.

Note: You can hide a worksheet only if the workbook contains more than one worksheet.

- Enter the name of the session used to open the workbook with the **Open** .

Password protect worksheet action

The Password protect worksheet action of the Excel advanced package enables you to protect a worksheet with a password. You can also specify the operations to restrict on the worksheet.

Settings

- Specify the password you want to use to protect the worksheet and select the check boxes for the operation that you want to restrict on the worksheet. For example, select the **Delete row** and **Delete column** check boxes to restrict a user from deleting a row or column from the worksheet.
- Enter the name of the session used to open the workbook with the **Open** .

Rename worksheet action

The Rename worksheet action of the Excel advanced package enables you to rename a worksheet in the current workbook.

Settings

- Specify the index number or name of the worksheet to rename in the **Sheet by Index** or **Sheet by Name** field.

The index number is the number assigned to a worksheet. For example, if you want to perform an operation on the worksheet at the third position in the workbook, enter 3 in the field.

Note: You cannot rename the worksheet if a worksheet with the same name already exists in the workbook.

- Enter the new worksheet name that is under 31 characters.
- Enter the name of the session used to open the workbook with the **Open** .

Retrieve sheets count action

The Retrieve sheets count action of the Excel advanced package enables you to get the number of sheets available in the current workbook and store it in a number variable.

Settings

- Select the appropriate option to specify whether to include the hidden worksheet or not and assign the count to a variable.
- Enter the name of the session used to open the workbook with the **Open** .
- Select a number variable that you want to use to store the name of the worksheet from the **Select the variable to assign to** list. The shows a descriptive default variable name. If you create several output variables, subsequent variable names are appended with a -1, -2, -3, and so on to avoid duplication.

Run macro action

The Run macro action in the Excel advanced package enables you to run macros in a worksheet.

Settings

- Specify the name of the macro you want to run and its arguments.
- Enter the name of the session used to open the workbook with the **Open** .

Note:

- When you write a macro code, always end the code by adding `Exit Sub`.
- If you add `End` to terminate the macro, then on execution, the bot can fail with an error.
- Ensure that a macro code contains only one instance of the `End` or `End Sub` statement in the macro code to terminate the macro. If there is more than one instance of the statement, then on execution, the bot might fail with an error.

Example:

```
Public Sub main()
MsgBox "Hello"
MsgBox "Hello2"
End Sub
```

Switch to sheet action

The Switch to sheet action in the Excel advanced package activates a particular sheet in a Microsoft Excel file.

Settings

- Specify whether to activate the **Sheet by Index** (numerical value) or **Sheet by Name**.
- Enter the name of the session used to open the workbook with the **Open** .

Note: The bot containing the **Switch to sheet** action switches to the hidden worksheet and performs operations on it. After the operations are completed, the worksheet remains hidden and is not activated.

Unhide all worksheets action

The Unhides all worksheets action in the Excel advanced package unhides all the worksheets in the current workbook.

Settings

Unhides all worksheets in the current workbook. Enter the name of the session used to open the current workbook with the **Open** action.

Unhide worksheet action

The Unhide worksheet action in the Excel advanced package unhides a specific worksheet in the current workbook.

Settings

- Enter the name of the worksheet you want to unhide.
- Enter the name of the session used to open the workbook with the **Open** .

Write from data table action

The Write from data table action in the Excel advanced package enables you to write values from a data table into a worksheet.

Settings

- Specify the data table variable that contains the data you want to write in a worksheet.
- Specify whether you want to write data in the currently **Active worksheet** or **Specific worksheet**.
- Specify the address of the cell that you want to use as the starting point of the data in the **Specify the first cell** field.
- Enter the name of the session used to open the workbook with the **Open** .

Row and column operations in Excel advanced

The **Excel advanced** package contains various actions that you can use to automate tasks related to the row and column operations in a Microsoft Excel spreadsheet.

Row and column actions in the Excel advanced package

The **Excel advanced** package includes the following actions:

Action	Description
Get column name	See Get column name action
Get row number	See Get row number action
Hide rows/columns in selection	See Hide rows/columns in selection action
Insert/Delete Rows/Columns	See Using Insert or Delete actions for rows and columns .
Read column	See Read column action
Read row	See Read row action

Action	Description
Remove blank rows	See Remove blank rows action
Select cell(s)/row(s)/column(s)	See Using Select action for cells, rows, and columns.
Unhides rows/columns in selection	See Unhides rows/columns in selection action

Get column name action

The Get column name in the Excel advanced package enables you to retrieve the column name that contains the specific cell and stores it to a string variable. This action supports .xlsx and .xlsm files.

Settings

- Select the **Active cell** or **Specific cell** option to specify the cell location.
- Enter the name of the session used to open the workbook with the **Open** .
- Select a string variable from the **Save the column name to variable** list. The shows a descriptive default variable name. If you create several output variables, subsequent variable names are appended with a -1, -2, -3, and so on to avoid duplication.

Get row number action

The Get row number action in the Excel advanced package enables you to retrieve the row number that contains the specific cell and stores it to a string variable. This action supports .xlsx and .xlsm files.

Settings

This action supports .xlsx and .xlsm files.

- Select the **Active cell** or **Specific cell** option to specify the cell location.
- Enter the name of the session used to open the workbook with the **Open** .
- Select a string variable from the **Save the row number to variable** list. The shows a descriptive default variable name. If you create several output variables, subsequent variable names are appended with a -1, -2, -3, and so on to avoid duplication.

Hide rows/columns in selection action

The Hide row/columns in selection action in the Excel advanced package enables you to hide rows or columns in the current worksheet.

Settings

- Select the appropriate option to specify whether to hide one or more rows and columns.
- Enter the name of the session used to open the workbook with the **Open** .

Using Insert or Delete actions for rows and columns

Use the **Insert** or **Delete** actions to create or remove rows or columns from the current worksheet or CSV file.

To insert or delete rows or columns in a worksheet, do the following:

1. Double-click or drag the **Insert** or **Delete** action from the **Excel** node in the **Actions** palette.

2. Select the **Row operations** if you want to insert or delete rows from the spreadsheet.
 - a) Select the **Insert Row at** option to insert a row and specify the location where you want to insert the row in the field.
 - b) Select the **Delete Row(s) at** option to delete rows. You must specify the row number you want to delete in the field. For example, if you want to delete the tenth row in the worksheet, you must enter 10 in the field. If you want to delete the first five rows, you must enter 1 : 5 in the field.
3. Select the **Column operations** if you want to insert or delete columns from the spreadsheet.
 - a) Select the **Insert Column at** option to insert a column and specify the location where you want to insert the column in the field.
 - b) Select the **Delete Column(s) at** option to delete columns. You must specify the address of the column you want to delete in the field. For example, if you want to delete column 'D' in the worksheet, you must enter D in the field. If you want to delete the first five columns, you must enter A : E in the field.
4. Enter the name of the session used to open the workbook with the **Open** .
5. Click **Save**.

Read column action

The Read column action in the Excel advanced package enables you to extract data from a column and stores it in a list variable of string data type.

Settings

- Select the **From active cell** or **From specific cell** option to specify the starting point. You can also select the **Read full column** option to extract data for the entire column.
- Choose from the **Read** option to read either the visible text or value of the cell.

For example, if the cell has 70% as cell content, **Read cell value** option will read the value as 70 ignoring the % format whereas **Read visible text** option will read the content as 70%.

Recommendation: Use the **Read cell value** option as reading value from a cell for better performance than reading visible text.

- Enter the name of the session used to open the workbook with the **Open** .
 - Select a table variable to store the extracted values.
-

Note: This action overwrites any existing values in the selected table.

The shows a descriptive default variable name. If you create several output variables, subsequent variable names are appended with a -1, -2, -3, and so on to avoid duplication.

Read row action

The Read row action in the Excel advanced package enables you to extract data from a row and stores it in a list variable of string data type.

Settings

Extracts data from a row and stores it in a list variable of string data type.

- Select the **From active cell** or **From specific cell** option to specify the starting point. You can also select the **Read full row** option to extract data for the entire row.

- Choose from the **Read** option to read either the visible text or value of the cell.

For example, if the cell has 70% as cell content, **Read cell value** option will read the value as 70 ignoring the % format whereas **Read visible text** option will read the content as 70%.

Recommendation: Use option **Read cell value** as reading value from a cell gives better performance than reading a visible text.

- Enter the name of the session used to open the workbook with the **Open** .
- Select a list variable of string data type that you want to use to store the extracted values. The shows a descriptive default variable name. If you create several output variables, subsequent variable names are appended with a -1, -2, -3, and so on to avoid duplication.

Remove blank rows action

The Remove blank rows action in the Excel advanced package enables you to remove blank rows from the current worksheet.

Settings

You can specify the range from which you want to delete the blank rows.

Using Select action for cells, rows, and columns

Use the **Select** action to select cells, rows, or columns.

To select cells, rows, or columns do the following:

1. Double-click or drag the **Select** cell, row, or column action from the **Excel** node in the **Actions** palette.
2. Select an option from the **Select** list to specify whether you want to select a cell, row, or column.
 - a) If you have selected the **Cell** option, select any of the following options:
 - **Active cell:** Enables you to select the active cell from the worksheet.
 - **Specific cell:** Enables you to select the cell you have specified in the field.
 - **Cell range:** Enables you to select all the cells in the range you have specified in the field.
 - **All cells in the sheet:** Enables you to select all the cells in the worksheet.
 - b) If you have selected the **Column** option, select any of the following options:
 - **Column of active cell:** Selects the column of the current active cell in the worksheet.
 - **Specific column:** Enables you to select the column you have specified in the field.
 - **Column range:** Enables you to select all the columns in the range you have specified in the field.
 - c) If you have selected the **Row** option, select any of the following options:
 - **Row of active cell:** Selects the row of the current active cell in the worksheet.
 - **Specific row:** Enables you to select the row you have specified in the field.
 - **Row range:** Enables you to select all the rows in the range you have specified in the field.
3. Enter the name of the session used to open the workbook with the **Open** .
4. Click **Save**.

Unhides rows/columns in selection action

The Unhide rows/columns in selection action in Excel advanced package enables you to unhide the hidden rows or columns in the current worksheet.

Settings

- Select the appropriate option to specify whether you want to unhide a row or column and which row or column to unhide.
- Enter the name of the session used to open the workbook with the **Open** .

Cell operations in Excel advanced

The **Excel advanced** package contains various actions that you can use to automate tasks related to cell operations.

Cell actions in the Excel advanced package

The **Excel advanced** package includes the following actions:

Action	Description
Delete cells	See Delete cells action
Find next empty cell	See Using Find next empty cell action.
Find	See Using Find action in Excel.
Get cell address	See Using the Get cell address action
Get cell color	See Using Get cell color action.
Get multiple cells	See Get multiple cells action
Get number of rows	See Using Get number of rows action.
Get single cell	See Get single cell action
Go to cell	See Go to cell action
Go to next empty cell	See Go to next empty cell action
Read cell formula	See Read cell formula action
Replace	See Using the Replace action.
Set cell	See Set cell action
Set cell formula	See Set cell formula action

Delete cells action

The Delete cell action in the Excel advanced package enables you to delete the Active cell or a Specific cell from the current worksheet or a CSV file.

Settings

Note: You can enter a cell range in the **Specific - cell** field using the `starting - cell:ending cell` format. For example, to perform this operation on all cells in the second row and from the first through third column, enter `A2:C2`.

After deleting the cell, you can:

- **Shift cells left:** Deletes the specified cell and shifts the cell one position to the left.
- **Shift cells up:** Deletes the specified cell and shifts the cell one position up.
- **Entire row:** Deletes the entire row that contains the cell you have specified to delete.
- **Entire column:** Deletes the entire column that contains the cell you have specified to delete.

Using Find next empty cell action

Use the **Find next empty cell** action to find the next empty cell in the current worksheet.

To find the next empty cell, do the following:

1. Double-click or drag the **Find next empty cell** action from the **Excel** node in the **Actions** palette.
2. Select the **row** or **column** option from the **Traverse by** section to specify whether you want to find the empty cell in a row or column.
3. Select the **active cell** or **specific cell** option from the **Start from** section to specify the point from where you want to start the search.
4. Select the string variable you want to use to store the address of the empty cell from the **Assign the output to variable** list.

The shows a descriptive default variable name. If you create several output variables, subsequent variable names are appended with a `-1`, `-2`, `-3`, and so on to avoid duplication.

5. Enter the name of the session used to open the workbook with the **Open** .
6. Click **Save**.

Using Find action in Excel

Use the **Find** action to find a particular string in a Microsoft Excel spreadsheet or a CSV file.

To find a value in a Microsoft Excel spreadsheet, do the following:

1. Double-click or drag the **Find** action from the **Excel** node in the **Actions** palette.
2. Select an option from the **From** list to specify a starting point of the cell range for search:
 - **Beginning:** Starts the search from the beginning of the spreadsheet.
 - **End:** Starts the search from the end of the spreadsheet.
 - **Active cell:** Starts the search from the active cell in the spreadsheet.
 - **Specific cell:** Enables you to specify the address of the cell from where you want to start the search.
3. Select an option from the **Till** list to specify an end point of the cell range for search:
 - **Beginning:** Ends the search at the beginning of the spreadsheet.
 - **End:** Ends the search at the end of the spreadsheet.
 - **Active cell:** Ends the search at the active cell in the spreadsheet.
 - **Specific cell:** Enables you to specify the address of the cell where you want to end the search.

4. Specify the string you want to search for in the **Find** field.
5. Select from the following search options:
 - **By rows:** Enables you to search by rows.
 - **By columns:** Enables you to search by columns.
 - **Match case:** Only performs this action on cells that contain a string that matches the uppercase and lowercase characters of the string you specified in the **Find** field.
 - **Match entire cell contents:** Enables you to find only those cells that contain the entire string you have specified in the **Find** field.
6. Enter the name of the session used to open the workbook with the **Open** .
7. Select the list variable of string data type that you want to use to store the output from the **Assign cell addresses to variable** list.
8. Click **Save**.

When you search for a value using the **Find** action, it will either return a list of cell addresses that contain the value or will return an empty list if the value is not found.

Using the Get cell address action

Use the Get cell address action to retrieve the location of the active cell and store it to a string variable. This action supports .xlsx and .xlsm files.

Open a worksheet using the **Open** action. You must select the **Contains header** option when configuring the **Open** action in order to use this action to retrieve the cell address based on the column title name.

1. Double-click or drag the **Get cell address** action from the Excel advanced node in the **Actions** palette.
2. Select whether to retrieve the cell address from the **Active cell** or **Based on header**:

Option	Steps
Active cell	If you select this option, the bot will retrieve the cell address of the currently active cell. Skip to Step 5.

Option	Steps
<p>Based on header</p>	<p>If you select this option, the bot will retrieve the cell address of the cell specified by the column title name and cell position. Complete the following fields:</p> <p>a. Enter the column title: If you selected the Sheet contains header option when you opened this sheet using the Open action, enter the column name. For example, <i>First Name</i>.</p> <p>If you did not select that option, enter the default column name. For example, <i>A</i>.</p> <hr/> <p>Note: This field is not case-sensitive.</p> <hr/> <p>b. Enter cell position from column title: Enter the number of cells between the header cell and the cell from which you want to retrieve the address. Enter up to three digits.</p> <p>For example, if the header cell is located at B1 and you specify 2 as the cell position, the action will return B3.</p>

3. Select whether to retrieve the cell address from the **Active cell** or a **Specific cell**.

- If you have selected the **Active cell** option, the bot will retrieve the cell address of the currently active cell. Skip to Step 5.
- If you have selected the **Specific cell** option, the bot will retrieve the cell address of the cell specified by the column title name and cell position. Complete the following fields:

- **Enter the column title:** Enter the column name. For example, *Name*.

Note: This field is not case-sensitive.

- **Enter cell position from column title:** Enter the number of cells between the header cell and the cell from which you want to retrieve the address. Enter up to three digits.

For example, if the header cell is located at B1 and you specify 2 as the cell position, the action will return B3.

4. In the **Save active or user specified cell address in local variable** field, create or insert an existing string variable.

The shows a descriptive default variable name. If you create several output variables, subsequent variable names are appended with a -1, -2, -3, and so on to avoid duplication.

- 5.** Enter the name of the session used to open the workbook with the **Open** .
- 6.** Click **Save**.

Next, you can insert the string variable containing the cell address into the **Specific cell** field of actions related to cell operations. See [Cell operations in Excel advanced](#).

Using Get cell color action

Use the **Get cell color** action to get the color of the background or text in a cell.

This action retrieves the color of a cell as RGB values. For example, if the background or text in a cell is of red color, the value retrieved is 255,0,0.

1. Double-click or drag the **Get cell color** action from the **Excel** node in the **Actions** palette.
2. Select the **Background color** option to get the background color of the cell or the **Text color** option to get the color of the text.
3. Select the **Active cell** option to get the color from the current active cell or the **Specific cell** option to get the color from the address of the cell you have specified.
4. Select a variable from the **Assign the output to variable** list to assign the address of the empty cell to the variable you have selected from the list.
5. Select the string variable you want to use to store the address of the empty cell from the **Assign the output to variable** list.
The shows a descriptive default variable name. If you create several output variables, subsequent variable names are appended with a `-1`, `-2`, `-3`, and so on to avoid duplication.
6. Enter the name of the session used to open the workbook with the **Open** .
7. Click **Save**.

Get multiple cells action

The Get multiple cells action in the Excel advanced package enables you to retrieve the values from the cells in a Microsoft Excel spreadsheet and stores them in a table variable.

Settings

This retrieves cell values as string data types. It supports Excel cell formats, including Number, Percentage, Currency, Scientific, and Date. For example, a value from a cell of Currency formatting retains the currency symbol when passed to a table or record variable.

Note: You must convert the values to perform non-string operations.

- Select the **Multiple cells** option to retrieve values from a range of cells, or select **All cells** to retrieve values from all the cells.
- Choose from the **Read** option to read either the visible text or value of the cell.

For example, if the cell has 70% as cell content, **Read cell value** option will read the value as 70 ignoring the % format whereas **Read visible text** option will read the content as 70%.

Note: When you use the **Read visible text** option to process large data sets in Microsoft Excel spreadsheets, the action consumes more time to process the data.

Recommendation: Use the **Read cell value** option as the reading value for a better performance than reading visible text.

- Enter the name of the session used to open the workbook with the **Open** .
- Select a table variable to store the retrieved values in the **Assign value to variable** list. The shows a descriptive default variable name. If you create several output variables, subsequent variable names are appended with a `-1`, `-2`, `-3`, and so on to avoid duplication.

Using Get number of rows action

Use the **Get number of rows** action to get the number of rows that contain data.

To get the number of rows that are not empty or contain data, do the following:

1. Double-click or drag the **Get number of rows** action from the **Excel** node in the **Actions** palette.
2. Select the **Index** option to specify the number of the worksheet or the **Name** option to specify the name of the worksheet from which you want to get the number or rows.
3. Select the **Non-empty rows** option to get the number of rows that are not empty or the **Total rows with data** option to get the number of rows that contain data.
4. Enter the name of the session used to open the workbook with the **Open** .
5. Select the number variable you want to use to store the output from the **Assign to variable** list.
6. Click **Save**.

Get single cell action

The Get single cell action in the Excel advanced package enables you to retrieve the values from a single cell in a Microsoft Excel spreadsheet or a CSV file and store them in a string variable.

Settings

This retrieves cell values as string data types. It supports Excel cell formats, including Number, Percentage, Currency, Scientific, and Date. For example, a value from a cell of Currency formatting retains the currency symbol when passed to a table or record variable.

Note: You must convert the values to perform non-string operations.

- Select the **Active cell** option to retrieve the value from the active cell, or select **Specific cell** to retrieve the value from a specific cell in a Microsoft Excel spreadsheet.
- Choose from the **Read** option to read either the visible text or value of the cell.

For example, if the cell has 70% as cell content, **Read cell value** option will read the value as 70 ignoring the % format whereas **Read visible text** option will read the content as 70%.

Recommendation: Use the **Read cell value** option as the reading value from a cell for a better performance than reading visible text.

- Enter the name of the session used to open the workbook with the **Open** .
- Select a string variable to store the retrieved values in the **Store cell contents to** list. The shows a descriptive default variable name. If you create several output variables, subsequent variable names are appended with a -1, -2, -3, and so on to avoid duplication.

Note: If the character limit in a single cell of a Microsoft Excel spreadsheet exceeds 8200, then the bot reads only the first 8200 characters. This behaviour is specific only to Microsoft Excel spreadsheet.

Example of using a conditional statement

.

Go to cell action

The Go to cell action in the Excel advanced package enables you to move the cursor to a specific cell in a Microsoft Excel spreadsheet or a CSV file.

Settings

- Select the **Specific cell** option to specify the cell to which the cursor should be moved, or select an option from the **Active cell** list.

Note: You can enter a cell range in the **Specific cell** field to select the entire range of cells. For example, to select all the cells in the second row and from the first through third column, enter `A2:C2`.

- Enter the name of the session used to open the workbook with the **Open** .

Go to next empty cell action

The Go to next empty cell action in the Excel advanced package enables you to find the next empty cell in the current worksheet. You can specify whether to find the empty cell toward the left, right, up, or down.

Settings

- Select the **Active cell** or **Specified cell** option to specify the cell from which to start searching for the empty cell. If you have selected the **Specified cell** option, specify the address of the cell in the field.
- Select the **left**, **right**, **up**, or **down** option to specify the direction in which to search for the next empty cell.
- Enter the name of the session used to open the workbook with the **Open** .

Read cell formula action

The Read cell formula action in the Excel advanced package enables you to retrieve the formula available in the **Active cell** or **Specified cell** and assign the output to a string variable. This action returns a blank value if the specified cell does not contain a formula.

Settings

- Enter the name of the session used to open the workbook with the **Open** .
- Select the **Active cell** or **Specified cell** option to specify the cell from which to read the formula. If you have selected the **Specified cell** option, specify the address of the cell in the field.
- Select a string variable to store the name of the formula from the **Assign the output to variable** list. The shows a descriptive default variable name. If you create several output variables, subsequent variable names are appended with a `-1`, `-2`, `-3`, and so on to avoid duplication.

Using the Replace action

Use the **Replace** action to find cells that contain a specific string and replace it with another string. This action supports .xlsx, .xlsm, and .csv files.

1. Double-click or drag the **Replace** action from the Excel advanced node in the **Actions** palette.
2. Select an option from the **From** list to specify a starting point of the cell range for search:
 - **Beginning:** Starts the search from the beginning of the spreadsheet.
 - **End:** Starts the search from the end of the spreadsheet.
 - **Active cell:** Starts the search from the active cell in the spreadsheet.
 - **Specific cell:** Enables you to specify the address of the cell from where you want to start the search.

3. Select an option from the **Till** list to specify an end point of the cell range for search:
 - **Beginning**: Ends the search at the beginning of the spreadsheet.
 - **End**: Ends the search at the end of the spreadsheet.
 - **Active cell**: Ends the search at the active cell in the spreadsheet.
 - **Specific cell**: Enables you to specify the address of the cell where you want to end the search.
4. Specify the string you want to search for in the **Find** field.
5. Select from the following search options:
 - **By rows**: Enables you to search by rows.
 - **By columns**: Enables you to search by columns.
 - **Match case**: Only performs this action on cells that contain a string that matches the uppercase and lowercase characters of the string you specified in the **Find** field.
 - **Match entire cell contents**: Enables you to find only those cells that contain the entire string you have specified in the **Find** field.
6. Select **Replace with** and specify the replacement string, or leave the field blank to replace the matching cells with an empty character.
7. Enter the name of the session used to open the workbook with the **Open** .
8. Click **Save**.

Set cell action

The Set cell action in the Excel advanced package enables you to set a value in the Active cell or Specific cell in a Microsoft Excel spreadsheet or a CSV file. You can also use this action to set a formula.

Settings

- Select the **Active cell** or **Specified cell** option to specify the cell in which to set the value. If you have selected the **Specified cell** option, specify the address of the cell in the field.

Note: You can enter a cell range in the **Specific cell** field to set a particular value in all the cells of the range. For example, to set a value of 5 on all cells in the second row and from the first through third column, enter `A2:C2`.

- Enter the value to set in the **Cell value** field.
- Enter the name of the session used to open the workbook with the **Open** .

Set cell formula action

The Set cell formula action in the Excel advanced package enables you to set a formula in the active cell or a specific cell in a Microsoft Excel spreadsheet or a CSV file.

To generate a random number, use the **Number > Random** action. See [Random action](#).

Settings

- Select the **Set formula for active cell** or **Set formula for specified cell** option to specify the cell in which to set the formula. If you have selected the **Set formula for specified cell** option, specify the address of the cell in the field.
- Enter the formula to set in the **Enter formula for specific cell** field.
- Enter the name of the session used to open the workbook with the **Open** .

Table operations in Excel advanced

The **Excel advanced** package contains various actions that you can use to automate tasks related to table operations in a Microsoft Excel spreadsheet.

Table actions in the Excel advanced package

Note: Ensure that a table is available in the workbook. A worksheet that contains data in various rows and columns is not considered as a table.

The **Excel advanced** package includes the following actions:

Action	Description
Delete table column	See Delete table column action
Filter table	See Using Filter table action.
Get table range	See Get table range action
Insert table column	See Insert table column action
Sort table	See Sort table action

Delete table column action

The Delete table column action in the Excel advanced package enables you to delete a column in a table.

Settings

- Specify the **Table name** from which you want to delete a column.

Note: The table name is a string value. It is NOT a data table name. For information on how to retrieve the Excel table name, see [Rename an Excel table](#).

- Select the **Name** or **Position** to specify the name or position of the column to delete.
- Enter the name of the session used to open the workbook with the **Open** .

Using Filter table action

Use the **Filter table** action to filter data from a column in a table.

To filter data in a table, do the following:

- Double-click or drag the **Filter table** action from the **Excel** node in the **Actions** palette.
- Specify the name of the table from which you want to filter data in the **Table name** field.

Note: The table name is a string value. It is NOT a data table name. For information on how to retrieve the Excel table name, see .

- Select the **Column name** to specify the name of the column or the **Column position** to specify the position of the column that contains the data you want to filter.

4. Select the **Number** option if the column you have specified contains number data.
 - a) Select an option from the list to specify the operator you want to use to filter the data.

The following options are available:

 - **Equals:** Filters the data that is equal to the value you have specified.
 - **Does not equal:** Filters the data that is not equal to the value you have specified.
 - **Greater than:** Filters the data that is greater than the value you have specified.
 - **Greater than or equal to:** Filters the data that is greater than or equal to the value you have specified.
 - **Less than:** Filters the data that is less than the value you have specified.
 - **Less than or equal to:** Filters the data that is less than or equal to the value you have specified.
 - **Between:** Filters the data that is between the two values you have specified.

Note: Apart from the **Between** option, you do not have to provide a value in the second field. If you have provided a value in the second field, the system ignores that value when filtering the data.

5. Select the **Text** option if the column you have specified contains textual data.
 - a) Select an option from the list to specify the operator you want to use to filter the data.

The following options are available:

 - **Equals:** Filters the data that is equal to the value you have specified.
 - **Does not equal:** Filters the data that is not equal to the value you have specified.
 - **Begins with:** Filters the data that begins with the value you have specified.
 - **Ends with:** Filters the data that ends with the value you have specified.
 - **Contains:** Filters the data that contains the value you have specified.
 - **Does not contain:** Filters the data that does not contain the value you have specified.
6. Enter the name of the session used to open the workbook with the **Open** .
7. Click **Save**.

Get table range action

The Get table range action in the Excel advanced package enables you to get the range of a table available in a worksheet and store the output in a string variable.

Settings

- Specify the **Table name** for which you want to get the range.

Note: The table name is a string value. It is NOT a data table name. For information on how to retrieve the Excel table name, see .

- Select the options to specify whether you want to include a header and pivot table in the range and a variable to store the output. The shows a descriptive default variable name. If you create several output variables, subsequent variable names are appended with a -1 , -2 , -3 , and so on to avoid duplication.
- Enter the name of the session used to open the workbook with the **Open** .

Insert table column action

The Insert table column action in the Excel advanced package enables you to insert a column in a table.

Settings

- Specify the **Table name** in which you want to insert a column.

Note: The table name is a string value. It is NOT a data table name. For information on how to retrieve the Excel table name, see .

- Specify the name of the column in the **Column name** field and the position where you want to insert the column in the **Column position** field.
- Enter the name of the session used to open the workbook with the **Open** .

Sort table action

The Sort table action in the Excel advanced package enables you to sort the data in a column of a table. This action enables you to sort numeric and text data.

Settings

Sorts the data in a column of a table. This action enables you to sort numeric and text data.

- Specify the **Table name** for which you want to sort the data.

Note: The table name is a string value. It is NOT a data table name. For information on how to retrieve the Excel table name, see .

- Select the **Column name** or **Column position** to specify the name or position of the column.
- Select an appropriate option from the **Number** or **Text** list to specify the sort order.
- Enter the name of the session used to open the workbook with the **Open** .

Important: Ensure that Microsoft Excel is set to the same language as that of the computer operating system.

CSV operations in Excel advanced

You can use some of the actions available in the **Excel advanced** package to perform various operations on a CSV file.

CSV actions in the Excel advanced package

The following table lists the actions that you can use with a CSV file:

Supported	Not Supported
Open	Find next empty cell
Set cell	Get cell colour
Go to cell	Go to next empty cell
Insert/Delete row column	Run macro
Insert/Delete row column	Unhide all worksheets

Get cell	Hide row/column in selection
Find/Replace	Unhide row/column in selection
Convert excel to pdf	Access password protected worksheet
Delete cells	Protect/Unprotect workbook
Set cell formula	Table related commands
Create workbook	Create worksheet

You can use the **Loop** action to retrieve data from each row in a CSV file. You can also use any of the above action that supports the use of a CSV file within a **Loop** action.

Note: All the other actions available in the **Excel advanced** package that are not listed in the above table cannot be used with a CSV file.

File package

Automate various file-related operations, such as creating, opening, copying, renaming, and deleting a file, by using the actions available in the **File** package.

You can use the actions in the **File** package either individually, to perform an action one time, or in a **Loop** action, to perform that action for each file available in a folder.

Actions in the File package

Note: You can use the **Zip** action available in the **Folder** package to compress a file. See [Using the Zip action](#).

The **File** package includes the following actions:

Action	Description
Assign	See Assign action
Copy Desktop file	See Using Copy Desktop file action for file .
Create	See Create action
Copy Control Room file	See Copy Control Room file action
Create shortcut	. See Create shortcut action
Create symbolic link	See Create symbolic link action
Delete	See Using Delete action for file .
Get name	See Get name action
Get path	See Get path action
Open	See Open action

Action	Description
Print	See Using Print action for file.
Print multiple files	See Using Print multiple files action .
Rename	See Using Rename action for file.

Related reference

[If package](#)

Use the actions in the **If** package to control the sequence of execution based on one or more conditions of a task.

[Loop package](#)

Use the Loop package to run a sequence of actions repeatedly for a specific number of times or until a specific condition is met.

[Variables overview](#)

Automation 360 offers a variety of variables, each designed to hold specific types of data and is intended for specific use. Use the topics below to learn more about each variable and how to use them.

Assign action

The Assign action in the File package enables you to assign a file from the Control Room , Desktop, or an existing File variable to a user-defined File variable.

Settings

Assigns a file from the Control Room , Desktop, or an existing File variable to a user-defined File variable.

Using Copy Desktop file action for file

Use the **Copy Desktop file** action to copy an existing file from Desktop to another location. This action enables you to copy a file based on its size and the date it was created or modified.

To copy an existing file, follow these steps:

1. In the **Actions** palette, from the **File** package, double-click or drag the **Copy Desktop file** action.
2. From the **Source file** field select one of the following options:
 - **Specific:** Specify the name and location of the file.
 - For **Regex:** Specify the source folder path.

You can use a regular expression (regex) in your source file or folder path to support a pattern-based search. Select the regular expression either as a **String** or **Pattern** for each regular expression condition and enter the value.

For example, if want to copy, delete, rename or print multiple files from your source folder using pattern based search, use regular expressions either as a **String** and enter the value as `My_` for all file name starting with `My_` or as a **Pattern** such as `[a-z]{3}(.txt|xlsx)` to retrieve files that matches this pattern.

3. In the **Destination file/folder** field, specify the name of the file and location.
4. Select the **Overwrite existing files** check box to overwrite an existing file with the same name at the specified location.
 - If the **Overwrite existing files** option is not selected, the system appends the name of the copied file with a numeric value. For example, if you have copied a file named `June_Quarter_report.pdf` and a file with the same name exists in the location

where you want to save the copied file, the system saves the copied file as `Copy of June_Quarter_report.pdf` for the first time. When you copy the same file in the same folder for the second time, it saves the copied file as `Copy (2) of June_Quarter_report.pdf`. The numeric value is incremented each time you copy a file with the same name when the overwrite check box is not selected.

- If you want to copy a file that is already available in the destination folder where the source and the destination folders are different and the **Overwrite existing files** check box is not selected, then the system shows the following error message: `Unable to copy file(s) <path \filename> as the specified file(s) exists.`

5. Select the **Size** check box to copy a file based on its size.

a) Select any of the following options from the list:

- **Atleast:** Copies a file only if the file size is more than the size you have specified.
- **Atmost:** Copies a file only if the file size is less than the size you have specified.
- **Exact:** Copies a file only if the file size is the same as the size you have specified.

b) Specify a value in the **Size** field.

6. Select the **Date** check box to copy a file based on the date it was created or modified.

a) Select one of the options from the list:

- **Created:** Enables you to copy a file based on the date it was created.
- **Modified:** Enables you to copy a file based on the date it was modified.

b) Select the **Is within last** option and specify a value in the field.

This option enables you to perform the operation on the file if it was created or modified within the number of days you have specified. For example, if you specify 7 in the field, the system performs the operation on the file if it was created or modified in the last 7 days.

c) Select the **Is between** option to specify a period.

This option enables you to specify a **Start date** and an **End date** for the period. For example, if you specify 01/01/19 as the start date and 01/31/19 as the end date of the period, the system performs the operation on the file if it was created or modified between this period.

Note: The **Start date** and **End date** are included in the period.

d) Select the **Is before** option and specify a value in the field.

This option enables you to perform the operation on the file if it was created or modified on or before the date you have specified.

e) Select the **On a date** option and specify a date in the field.

This option enables you to perform the operation on a file if it was created or modified on the date that you specified.

7. Click **Save**.

Create action

The Create action in the File package enables you to create a new file.

Settings

- In the **File** field, specify the name including the location to store the file.

- In the **Overwrite an existing file** option, select an existing file with the same name to overwrite it. If existing files are not overwritten, the Control Room appends the name of the new file with a numeric value.

Using Delete action for file

Use the **Delete** action to delete a file. This action enables you to delete a file based on its size and the date it was created or modified.

Follow these steps to delete a file:

1. In the **Actions** palette, double-click or drag the **Delete** action from the **File** package.
2. From the **Source file** field select one of the following options:
 - **Specific:** Specify the name and location of the file.
 - For **Regex:** Specify the source folder path.

You can use a regular expression (regex) in your source file or folder path to support a pattern-based search. Select the regular expression either as a **String** or **Pattern** for each regular expression condition and enter the value.

For example, if want to copy, delete, rename or print multiple files from your source folder using pattern based search, use regular expressions either as a **String** and enter the value as `My_` for all file name starting with `My_` or as a **Pattern** such as `[a-z]{3}(.txt|xlsx)` to retrieve files that matches this pattern.

3. Select the **Size** check box to delete a file based on its size.
 - a) Select any of the following options from the list:
 - **Atleast:** Deletes a file only if the file size is more than the size you have specified.
 - **Atmost:** Deletes a file only if the file size is less than the size you have specified.
 - **Exact:** Deletes a file only if the file size is the same as the size you have specified.
 - b) Specify a value in the **Size** field.
4. Select the **Date** check box to delete a file based on the date it was created or modified.
 - a) Select one of the options from the list:
 - **Created:** Enables you to delete a file based on the date it was created.
 - **Modified:** Enables you to delete a file based on the date it was modified.
 - b) Select the **Is within last** option and specify a value in the field.

This option enables you to perform the operation on the file if it was created or modified within the number of days you have specified. For example, if you specify 7 in the field, the system performs the operation on the file if it was created or modified in the last 7 days.
 - c) Select the **Is between** option to specify a period.

This option enables you to specify a **Start date** and an **End date** for the period. For example, if you specify 01/01/19 as the start date and 01/31/19 as the end date of the period, the system performs the operation on the file if it was created or modified between this period.

Note: The **Start date** and **End date** are included in the period.

 - d) Select the **Is before** option and specify a value in the field.

This option enables you to perform the operation on the file if it was created or modified on or before the date you have specified.
 - e) Select the **On a date** option and specify a date in the field.

This option enables you to perform the operation on a file if it was created or modified on the date that you specified.

5. Click **Save**.

Copy Control Room file action

The Copy Control Room file action in the File package enables you to copy a Control Room file to a specific location.

Settings

- In the **Control Room file** field, specify the file to copy. Select one of the following options to copy a file from the Control Room repository:
 - **Static file path:** Enables you to browse the Control Room repository and select the file. Use this option when the file path is static.

Note: When you browse the Control Room repository using **Static file path**, files with the `.bot` extension are not displayed.

- **Dynamic file path:** Enables you to browse the Control Room repository and select the file. In addition, it also enables you to insert variables in a file path to copy a file from the Control Room repository where the file path is dynamic. You can insert a variable that holds the entire file path or part of the file path.

For example, `C:\user\My Docs\test.csv` or `C:\user\My Docs\${fileName}`

- In the **Target file path** field, specify the path to the location where you want to save the file. You can insert a variable that holds the entire file path or part of the file path.

For example, `C:\user\My Docs\test.csv` or `C:\user\My Docs\${fileName}`

Note: If the folder structure does not exist, the bot creates all the folders as needed.

- Select **True** or **False**, or insert a Boolean variable to specify whether to overwrite the existing file.

Get name action

The Get name action in the File package enables you to get the name of the file.

Settings

Retrieves the file name from the Control Room, desktop, or an existing file variable and stores the file name in a selected output string variable.

Get path action

The Get path action in the File package enables you to get the path of the file.

Settings

Retrieves the file path from the Control Room, desktop, or an existing file variable and stores the file path in a selected output string variable.

Note: When you select the Control Room option to retrieve the file path, the bot displays the local file path of the downloaded Control Room file.

Open action

The Open action in the File package enables you to open an existing file.

Settings

In the **File** field, specify the name including the location to store the file.

You can use a regular expression (regex) or a pattern-based search to open an existing file that matches the search criteria. Select the regular expression either as a **String** or **Pattern** for each regular expression condition and enter the value.

Using Print action for file

Use the **Print** action to print a file. This action enables you to print a file based on its size and the date it was created or modified.

Follow these steps to print a file:

1. In the **Actions** palette, double-click or drag the **Print** action from the **File** package.
2. In the **File** field, specify the name and location of the file.
3. Select the **Size** check box to print a file based on its size.
 - a) Select one of the options from the list:
 - **Atleast:** Prints a file only if the file size is more than the size you have specified.
 - **Atmost:** Prints a file only if the file size is less than the size you have specified.
 - **Exact:** Prints a file only if the file size is the same as the size you have specified.
 - b) Specify a value in the **Size** field.
4. Select the **Date** check box to print a file based on the date it was created or modified.
 - a) Select any of the following options from the list:
 - **Created:** Enables you to print a file based on the date it was created.
 - **Modified:** Enables you to print a file based on the date it was modified.
 - b) Select the **Is within last** option and specify a value in the field.

This option enables you to perform the operation on the file if it was created or modified within the number of days you have specified. For example, if you specify 7 in the field, the system performs the operation on the file if it was created or modified in the last 7 days.
 - c) Select the **Is between** option to specify a period.

This option enables you to specify a **Start date** and an **End date** for the period. For example, if you specify 01/01/19 as the start date and 01/31/19 as the end date of the period, the system performs the operation on the file if it was created or modified between this period.

Note: The **Start date** and **End date** are included in the period.

 - d) Select the **Is before** option and specify a value in the field.

This option enables you to perform the operation on the file if it was created or modified on or before the date you have specified.
 - e) Select the **On a date** option and specify a date in the field.

This option enables you to perform the operation on a file if it was created or modified on the date that you specified.

5. Click **Save**.

Using Print multiple files action

Use **Print multiple files** to print multiple files based on the size and the date they were created or modified.

Follow these steps to print multiple files:

1. In the **Actions** palette, double-click or drag the **Print multiple files** action from the **File** package.
2. In the **Folder** field, specify the name and location of the folder.
3. From the **File type** field, select **String** to specify the file type of your files or **Regex**

Use the regular expression in your source file or folder path to support pattern based search. Select the regular expression (Regex) either as a **String** or **Pattern** for each regex condition and input the regex value.

For example, you can use regular expressions either as a **String** and enter the value as `MY_` for all file name starting with `MY_` or as a **Pattern** such as `[a-z]{3}(.txt|xlsx)` to retrieve files that matches this pattern.

4. Select the **Include subfolders** check box to include all the subfolders in your selected folder.
5. Select the **Size** check box to print multiple files based on their size.
 - a) Select any of the following options from the list:
 - **Atleast:** Prints multiple files only if the file size is more than the size you have specified.
 - **Atmost:** Prints multiple files only if the file size is less than the size you have specified.
 - **Exact:** Prints multiple files only if the file size is the same as the size you have specified.
 - b) Specify a value in the **Size** field.

6. Select the **Date** check box to print multiple files based on the date they were created or modified.
- a) Select one of the options from the list:
 - **Created:** Enables you to print multiple files based on the date they were created.
 - **Modified:** Enables you to print multiple files based on the date they were modified.
 - b) Select the **Is within last** option and specify a value in the field.
This option enables you to perform the operation on the files if they were created or modified within the number of days you have specified. For example, if you specify 7 in the field, the system performs the operation on the files if they were created or modified in the last 7 days.
 - c) Select the **Is between** option to specify a period.
This option enables you to specify a **Start date** and an **End date** for the period. For example, if you specify 01/01/19 as the start date and 01/31/19 as the end date of the period, the system performs the operation on the files if they were created or modified between this period.
-
- Note:** The **Start date** and **End date** are included in the period.
-
- d) Select the **Is before** option and specify a value in the field.
This option enables you to perform the operation on the files if they were created or modified on or before the date you have specified.
 - e) Select the **On a date** option and specify a date in the field.
This option enables you to perform the operation on a file if it was created or modified on the date that you specified.
7. Click **Save**.

Using Rename action for file

Use the **Rename** action to rename a file. This action enables you to rename a file based on its size and the date it was created or modified.

To rename a file, follow these steps:

1. In the **Actions** palette, double-click or drag the **Rename** action from the **File** package.
2. From the **Source file** field select one of the following options:
 - **Specific:** Specify the name and location of the file.
 - For **Regex:** Specify the source folder path.

You can use a regular expression (regex) in your source file or folder path to support a pattern-based search. Select the regular expression either as a **String** or **Pattern** for each regular expression condition and enter the value.

For example, if want to copy, delete, rename or print multiple files from your source folder using pattern based search, use regular expressions either as a **String** and enter the value as `My_` for all file name starting with `My_` or as a **Pattern** such as `[a-z]{3}(.txt|xlsx)` to retrieve files that matches this pattern.

3. In the **New file name** field, specify a new name for the file.
4. Select the **Size** check box to rename a file based on its size.
 - a) Select one of the options from the list:
 - **Atleast:** Renames a file only if the file size is more than the size you have specified.
 - **Atmost:** Renames a file only if the file size is less than the size you have specified.
 - **Exact:** Renames a file only if the file size is the same as the size you have specified.

- b) Specify a value in the **Size** field.
5. Select the **Date** check box to rename a file based on the date it was created or modified.
- a) Select any of the following options from the list:
- **Created:** Enables you to rename a file based on the date it was created.
 - **Modified:** Enables you to rename a file based on the date it was modified.
- b) Select the **Is within last** option and specify a value in the field.
This option enables you to perform the operation on the file if it was created or modified within the number of days you have specified. For example, if you specify 7 in the field, the system performs the operation on the file if it was created or modified in the last 7 days.
- c) Select the **Is between** option to specify a period.
This option enables you to specify a **Start date** and an **End date** for the period. For example, if you specify 01/01/19 as the start date and 01/31/19 as the end date of the period, the system performs the operation on the file if it was created or modified between this period.
-
- Note:** The **Start date** and **End date** are included in the period.
-
- d) Select the **Is before** option and specify a value in the field.
This option enables you to perform the operation on the file if it was created or modified on or before the date you have specified.
- e) Select the **On a date** option and specify a date in the field.
This option enables you to perform the operation on a file if it was created or modified on the date that you specified.
6. Click **Save**.

Create shortcut action

The Create shortcut action in the File package enables you to create a shortcut to a target file.

Settings

Creates a shortcut to a file at a user-specified location. The shortcut is dependent on the source file, so any changes you make to the source file will also apply to the shortcut.

- In the **Target location** field, specify the name and location.
- In the **Shortcut location** field, specify the name and location.

Note: Users with a valid role and required permission can create a shortcut to a file at a specified location.

Create symbolic link action

The Create a symbolic link action in the File package enables you to create a symbolic link to a target file.

Settings

Creates a symbolic link to a file at a user-specified location. The shortcut is dependent on the source file, so any changes you make to the source file will also apply to the shortcut.

- In the **Target location** field, specify the name and location.
- In the **Symbolic link location** field, specify the name and location.

Note: Users with only admin access can create a shortcut to a file at a specified location.

Folder package

Automate folder-related operations by using the actions available in the **Folder** package.

Actions in the Folder package

The **Folder** package includes the following actions:

Action	Description
Copy	See Using Copy action .
Create	<p>Creates a new folder.</p> <ul style="list-style-type: none"> • In the Folder field, specify the name and location. <hr/> <p>Note: Folder names cannot include system actions or device references such as AUX, CON, LPT, NUL, and PRN.</p> <ul style="list-style-type: none"> • Select the Overwrite an existing folder check box to overwrite an existing folder. <hr/> <p>Note: If this option is not selected, the system appends the name of the new folder with a numeric value.</p> <hr/>
Create shortcut	<p>Creates a shortcut to the specific folder at a user-specified location. The shortcut is dependent on the source folder. If you make changes to the source folder, they will also apply to the shortcut.</p> <ul style="list-style-type: none"> • In the Target location field, specify the name and location. • In the Shortcut location field, specify the name and location. <hr/> <p>Note: Users with a valid role and required permission can create a shortcut for a selected source file at a specified location.</p> <hr/>

Action	Description
Create symbolic link	<p>Creates a symbolic link to a file at a user-specified location. The shortcut is dependent on the source file, so any changes you make to the source file will also apply to the shortcut.</p> <ul style="list-style-type: none"> In the Target location field, specify the name and location. In the Shortcut location field, specify the name and location. <hr/> <p>Note: Users with only admin access can create a shortcut to a file at a specified location.</p> <hr/>
Delete	See Using Delete action .
Open	<p>Opens a folder at a specific location.</p> <p>In the Folder field, specify the name and location.</p>
Rename	See Using Rename action .
Unzip	See Using Unzip action .
Zip	See Using the Zip action .

Using Copy action

Use the **Copy** action to copy an existing folder.

- In the **Actions** palette, double-click or drag the **Copy** action from the **Folder** package.
- In the **Source folder** field, specify the name and location.
- In the **Destination folder** field, specify the folder name and location to save the copied folder.
- Select the **Overwrite existing files/folders** check box to overwrite existing folders with the same name.

Note: If this option is not selected, the system appends a numeric value at the end of the file name. For example, if you save the `June_Quarter_report` file in a location that has a file with the same name, the system saves the file as `June_Quarter_report_(1).pdf`. The numeric value is incremented each time you save the file as long as the option is selected.

- Select the **Size** check box to copy a folder based on its size.
 - Select any of the following options from the list:
 - Atleast:** Copies a folder only if the folder size is more than the size you have specified.
 - Atmost:** Copies a folder only if the folder size is less than the size you have specified.
 - Exact:** Copies a folder only if the folder size is the same as the size you have specified.
 - In the **Size** field, specify the folder size.

6. Select the **Date** check box to copy a folder based on the date.
 - a) Select any of the following options from the list:
 - **Created**: Enables you to copy a folder based on the date it was created.
 - **Modified**: Enables you to copy a folder based on the date it was modified.
 - b) In the **Is within last**, specify the value.

This option enables you to perform the operation on the folder if it was created or modified within the last number of days you have specified. For example, if you specify 7 in the field, the system performs the operation on the folder if it was created or modified in the last 7 days.
 - c) In the **Is between**, specify the period.

This option enables you to specify a **Start date** and an **End date** of the period. For example, if you specify 01/01/19 and 01/31/19 as the start date and end date of the period, the system performs the operation on the folder if it was created or modified between this period.

Note: The **Start date** and **End date** are included in the period.

 - d) In the **Is before**, specify the value.

This option enables you to perform the operation on the folder if it was created or modified on or before the date you have specified.
 - e) Select the **On a date** option and specify a value in the field.

This option enables you to perform the operation on a file if it was created or modified on the date you have specified.
7. Click **Save**.

Using Delete action

Use the **Delete** action to delete a folder.

1. In the **Actions** palette, double-click or drag the **Delete** action from the **Folder** package.
2. In the **Folder** field, specify the name and location.
3. Select the **Size** check box to delete a folder based on its size.
 - a) Select any of the following options from the list:
 - **Atleast**: Deletes a folder only if the folder size is more than the size you have specified.
 - **Atmost**: Deletes a folder only if the folder size is less than the size you have specified.
 - **Exact**: Deletes a folder only if the folder size is the same as the size you have specified.
 - b) In the **Size** field, specify the folder size.

4. Select the **Date** check box to delete a folder based on the date it was created or modified.
 - a) Select any of the following options from the list:
 - **Created:** Enables you to delete a folder based on the date it was created.
 - **Modified:** Enables you to delete a folder based on the date it was modified.
 - b) In the **Is within last**, specify the value.
This option enables you to perform the operation on the folder if it was created or modified within the last number of days you have specified. For example, if you specify 7 in the field, the system performs the operation on the folder if it was created or modified in the last 7 days.
 - c) In the **Is between**, specify the period.
This option enables you to specify a **Start date** and an **End date** of the period. For example, if you specify 01/01/19 and 01/31/19 as the start date and end date of the period, the system performs the operation on the folder if it was created or modified between this period.

Note: The **Start date** and **End date** are included in the period.

 - d) In the **Is before**, specify the value.
This option enables you to perform the operation on the folder if it was created or modified on or before the date you have specified.
 - e) Select the **On a date** option and specify a value in the field.
This option enables you to perform the operation on a file if it was created or modified on the date you have specified.

5. Click **Save**.

Using Rename action

Use the **Rename** action to rename a folder.

1. In the **Actions** palette, double-click or drag the **Rename** action from the **Folder** package.
2. In the **Folder** field, specify the name and location.
3. In the **New folder name** field, specify a new name.
4. Select the **Size** check box to rename a folder based on its size.
 - a) Select any of the following options from the list:
 - **Atleast:** Renames a folder only if the folder size is more than the size you have specified.
 - **Atmost:** Renames a folder only if the folder size is less than the size you have specified.
 - **Exact:** Renames a folder only if the folder size is the same as the size you have specified.
 - b) In the **Size** field, specify the folder size.
5. Select the **Date** check box to rename a folder based on the date it was created or modified.
 - a) Select any of the following options from the list:
 - **Created:** Enables you to rename a folder based on the date it was created.
 - **Modified:** Enables you to rename a folder based on the date it was modified.
 - b) In the **Is within last**, specify the value.
This option enables you to perform the operation on the folder if it was created or modified within the last number of days you have specified. For example, if you specify 7 in the field, the system performs the operation on the folder if it was created or modified in the last 7 days.
 - c) In the **Is between**, specify the period.

This option enables you to specify a **Start date** and an **End date** of the period. For example, if you specify 01/01/19 and 01/31/19 as the start date and end date of the period, the system performs the operation on the folder if it was created or modified between this period.

Note: The **Start date** and **End date** are included in the period.

d) In the **Is before**, specify the value.

This option enables you to perform the operation on the folder if it was created or modified on or before the date you have specified.

e) Select the **On a date** option and specify a value in the field.

This option enables you to perform the operation on a file if it was created or modified on the date you have specified.

6. Click **Save**.

Using Unzip action

Use the **Unzip** action to extract compressed files and folders from a zip file to a specific location.

1. In the **Actions** palette, double-click or drag the **Unzip** action from the **Folder** package.
2. In the **Zip file name with full path** field, specify the name and location.
3. In the **Extract to path** field, specify the location.
4. Select the **Replace existing file** check box to overwrite the file.
5. Optional: In the **Password to access zip file** field, select either **Credential** to specify a stored password, or select **String** to enter a password manually.
6. Click **Save**.

Using the Zip action

Use the **Zip** action to compress files and folders into a zip file.

1. In the **Actions** palette, double-click or drag the **Zip** action from the **Folder** package.
2. In the **Specify file(s)/folder(s) to compress** field, specify the location.
3. In the **Specify file type(s) to compress** field, select one of the following options:
 - **String:** Specify the file extension.

For example, you can specify .txt and .png to compress only text files and PNG images. The system compresses the entire folder if you do not specify any file type. You can also specify the name of a file to compress a specific file.

- **Regex:** Select the regular expression (regex) either as a **String** or **Pattern** for each regular expression condition and enter the value.

For example, you can use regular expressions either as a **String** and enter the value as `My_` for all file name starting with `My_` or as a **Pattern** such as `[a-z]{3}(.txt|xlsx)` to retrieve files that matches this pattern.

4. In the **Specify destination filename and location** field, specify the zip file name and location.
5. Select the **Update only if newer** check box to compress the files only if one or more files were updated after the last compression.

This option is useful when you are repeatedly compressing the same set of files and storing the output zip file with the same name at the same location. For example, you compress five PDF files from the `Reports` folder on a monthly basis and save the output zip file with the `Monthly Report` name in

the D: drive. When this option is selected, the system compresses the files only if one or more PDF files are updated after the last compression.

6. Select the **Delete original files** check box if you want to delete the original files after they are included in the zip file.
7. In the **Compression** list, select between **Normal**, **Fast**, and **Superfast** to specify the speed for compression.
8. Optional: In the **Password protection** field, select **Credential** to specify a stored password or select **String** to enter a password manually.
9. Click **Save**.

FTP / SFTP package

Use the FTP / SFTP package to automate FTP / SFTP operations.

An FTP/SFTP server hosts the files to share. The client accesses, downloads, or uploads files to the server. The transfer of data between the client and server is done using a TCP/IP network, which is the standard protocol of communication over the internet.

- The following are some forms of authentication for an FTP server:
 - User credentials: Requires an FTP username and password.
 - Anonymous: This form of authentication is enabled on sites where files are available for public access and the users need not identify themselves to the server.
 - Key-based: SFTP authentication is usually done with a private and public key. The key pair is automatically generated by the computer. The private key is kept with the SFTP client and the corresponding public key with the SFTP server. When establishing a connection, the client shares the private key to be matched with the corresponding public key on the server.
- FTP can run in active or passive transfer mode.
 - In the active mode, the client informs the server about the port used for listening and starts listening for incoming data connections from the server.
 - In the passive mode, the client receives a server IP address and server port number from the server. The client opens a data connection to the server IP address and server port number that are received. Most organizations prefer the passive mode because it involves less or no alterations to the firewall settings.
- FTP supports binary and ASCII file transfer types:
 - Use the binary option when transferring executable files.
 - Use the ASCII option when transferring text files.

Before you start

Perform the following actions within the FTP / SFTP package.

1. Establish a connection with the FTP/SFTP server using the **Connect** action. When establishing a connection, associate the FTP/SFTP server details with a session name. Use the same session name for all corresponding actions.
2. Use the FTP/SFTP actions to automate a task. The actions enable you to perform following tasks:
 - Upload, download, delete, or rename files.
 - Upload, download, create, or delete folders.
 - Navigate to the parent folder or a specific folder.

3. After you have automated the tasks related to FTP / SFTP, terminate the connection to the server using the **Disconnect** action.

Note: SFTP with SSH1 protocol is no longer supported by SFTP.

Actions in the FTP / SFTP package

The FTP / SFTP package includes the following actions:

Note: Regarding the use of a semicolon (;) in folder or file names, the following guidelines apply:

- You can use a semicolon (;) in the folder name for the following actions: **Delete** or **Create** folder
- You must not use a semicolon (;) in the folder or file name for other actions, such as the following: **Change folder**, **Delete files**, **Get files**, **Get folder**, **Put files**, **Put folders**, and **Rename files**

Action	Description
Change folder	<p>Navigates to either the parent folder or another specific folder on an FTP/SFTP server.</p> <ul style="list-style-type: none"> Enter the session name. <p>Use the same session name that you have provided when establishing a connection with the FTP/SFTP server using the Connect action.</p> <ul style="list-style-type: none"> Select either Go to parent folder or Specific folder in Navigate to options. <p>If the Specific folder option is selected, enter the complete folder path.</p>
Connect	See Using Connect action for FTP/SFTP .
Create folder	<p>Creates a folder in an existing folder on the FTP/SFTP server.</p> <ul style="list-style-type: none"> Enter the session name. <p>Use the same session name that you have provided when establishing a connection with the FTP/SFTP server using the Connect action.</p> <ul style="list-style-type: none"> Specify the folder name in the Remote folder field with the path to create a folder on the FTP server. <hr/> <p>Note: The system encounters an error if a folder with the same name exists in the parent folder.</p> <hr/>
Delete files	<p>Deletes files from an FTP/SFTP folder.</p> <ul style="list-style-type: none"> Enter the session name. <p>Use the same session name that you have provided when establishing a connection with the FTP/SFTP server using the Connect action.</p> <ul style="list-style-type: none"> Specify file names in the Remote files field along with the complete path, separated by a semicolon.

Action	Description
Delete folder	<p>Deletes a folder (including all the subfolders and files within it) from an FTP/SFTP server.</p> <ul style="list-style-type: none"> • Enter the session name. <p>Use the same session name that you have provided when establishing a connection with the FTP/SFTP server using the Connect action.</p> <ul style="list-style-type: none"> • Specify the folder name in the Remote folder field.
Disconnect	<p>Terminates the connection to the FTP/SFTP server.</p> <p>Enter the session name – Use the same session name that you have provided when establishing a connection with the FTP/SFTP server using the Connect action.</p>
Get files	<p>Downloads files from a remote FTP/SFTP folder to a specific folder on the client machine.</p> <ul style="list-style-type: none"> • Enter the session name. <p>Use the same session name that you have provided when establishing a connection with the FTP/SFTP server using the Connect action.</p> <ul style="list-style-type: none"> • Select files on the remote FTP server that you want to download on the local system. • In the Local folder field, enter the name of the folder where you want to download files from the FTP/SFTP server. • Select the Transfer Type as Binary or ASCII. • You can also specify folders based on the date they are created or modified.
Get folders	<p>Downloads a folder from an FTP/SFTP server to a client machine.</p> <ul style="list-style-type: none"> • Enter the session name. <p>Use the same session name that you have provided when establishing a connection with the FTP/SFTP server using the Connect action.</p> <ul style="list-style-type: none"> • Select folders on the remote FTP server that you want to download on the local system. <p>Specify filters using wildcard characters to download only specific types of files.</p> <ul style="list-style-type: none"> • In the Local folder field, enter the name of the folder where you want to download files from the FTP/SFTP server. • You can also specify folders based on the date they are created or modified.
Put files	<p>Uploads one or more files from the client machine to the FTP/SFTP server.</p> <ul style="list-style-type: none"> • Enter the session name. Use the same session name that you have provided when establishing a connection with the FTP/SFTP server using the Connect action. • Enter all the file names along with their location, separated by a semicolon. • Select the Transfer type to be either Binary or ASCII

Action	Description
Put folders	<p>Uploads a folder from the client machine to the FTP/SFTP server.</p> <ul style="list-style-type: none"> • Enter the session name. Use the same session name that you have provided when establishing a connection with the FTP/SFTP server using the Connect action. • Enter the folder name in the Local folder field which you want to upload on FTP/SFTP server. • Specify filters using wild card characters to restrict uploads to specific types of files.
Rename files	<p>Renames files in an FTP/SFTP folder.</p> <ul style="list-style-type: none"> • Enter the session name. <p>Use the same session name that you have provided when establishing a connection with the FTP/SFTP server using the Connect action.</p> <ul style="list-style-type: none"> • In the Remote file field, enter the name of the file that you want to rename. • Enter the new name in the New remote file field.

Using Connect action for FTP/SFTP

Use the **Connect** action to establish a connection with the FTP/SFTP server that you want to use to automate tasks. This must be the first action you use to automate an FTP/SFTP-related task.

Specify details of the FTP/SFTP server and associate it with a session name. Use the session name provided in this action in the other actions so that you do not have to provide details of the server in those actions.

To establish a connection with an FTP/SFTP server, perform these steps:

1. Double-click or drag the **Connect** action from the **FTP/SFTP** node in the **Actions** palette.
2. Enter a name for the session in the **Session name** field.
3. Enter the FTP/SFTP server name in the **Server name** field.
4. Specify the port number.
5. Select one of the following options to specify the server type:

Option	Steps
FTP	<p>Authentication type: You can choose to authenticate by either using Username & password or logging in as Anonymous. If you choose Username & password, complete the following fields:</p> <ul style="list-style-type: none"> • In Username & password, select Credential, variable, or Insecure string. • Enter values in the Username and Password fields. <p>If you choose to authenticate using the user credentials (username and password), insert a Credential Vault for enhanced security or enter the value directly in the Insecure string field.</p> <p>Transfer Mode: Select the transfer mode to be Active or Passive.</p> <p>Transfer type: Select the type to be either Binary or ASCII for transferring files between server and client.</p> <p>Optional: Enter the default directory path on the FTP server.</p>

Option	Steps
FTP Secure	<p>Authentication type: You can choose to authenticate by either using Username & password or logging in as Anonymous. If you choose Username & password, complete the following fields:</p> <ul style="list-style-type: none"> • In Username & password, select Credential, variable, or Insecure string. • Enter values in the Username and Password fields. <p>If you choose to authenticate using the user credentials (username and password), insert a Credential Vault for enhanced security or enter the value directly in the Insecure string field.</p>
Secure FTP	<p>Choose Key and username, Key and credentials, or Credentials to authenticate the user:</p> <ul style="list-style-type: none"> • Key and username: Select the Private Key File from Control Room file, Desktop file, or Variable. To enter the Username, select from the following options: Credential, variable, , and Insecure string. • Key and credentials: Select the Private Key File from Control Room file, Desktop file, or Variable. To enter the Username, select from the following options: Credential, variable, , and Insecure string. <hr/> <ul style="list-style-type: none"> • Note: Ensure that the SFTP server has a corresponding public key file. <hr/> <ul style="list-style-type: none"> • Credentials: Select Credential, Variable, or Insecure string to enter the value in the Username and Password fields. <p>If you choose to authenticate using the user credentials (username and password), insert a Credential Vault for enhanced security or enter the value directly in the Insecure string field.</p>

6. Select **Reconnect if connection fails** if you want to automatically reconnect:

Note: If the connection fails due to incorrect credentials, the action will not attempt to reconnect.

- Specify the number of attempts in the **Attempts** field.
- Select the time lapse in the **Time between attempts** field.

7. Click **Save**.

Fuzzy match package

Use the **Fuzzy match** action to compare the values of two strings or files for similarity. This action returns a decimal value; the closer the value to 1.0, the greater the similarity between the two strings.

Important: This is a beta package and is currently not available with the Automation 360 Enterprise and Cloud editions.

Use this action to automate the process of evaluating strings of data for similarity. For example, you have an automation sequence in which a bot extracts data from invoices, searches a database for the company record, and updates the record with data from the invoice. Use the **Fuzzy match** action to handle two possible scenarios:

- A mistake occurs at the extraction step where a letter is incorrectly extracted. Instead of Apple, the bot extracts App1e, with a numerical one instead of the letter l.
- There is a small variation between the company name on the invoice and in the database. The invoice contains the company name Apple Inc, but the database has a record for the company name Apple.

Genesys package

Automate the repetitive tasks related to onboarding and updating the details of contacts by using the actions in the Genesys package.

Intended use

The actions in the Genesys package are intended for use with the Automation Anywhere for Genesys integration. Currently, data cannot be passed directly from the integration to Genesys. These actions require a source data file to call from. You can then choose to manipulate the data by using variables or another worksheet before passing the final changes back to the Genesys source file. The actions included in this package are intended to offer automated solutions for common tasks.

Actions in the Genesys package

Use the following actions in the Genesys package to automate common onboarding and updating tasks.

Action	Description
Authentication	<p>The OAuth authenticate action calls your Genesys credential token and is required for the bot to connect with the API.</p> <ul style="list-style-type: none"> • Enter the URL for the Genesys cloud environment. • Select how you would like your credentials passed. <ul style="list-style-type: none"> • Use Credential to pick a preconfigured credential locker. • Use Variable to select a preconfigured credential variable. • Use Insecure string to enter your credential in the field without encryption. • Enter the credential required to access the environment for the Client ID. • Select how you would like your secret passed. <ul style="list-style-type: none"> • Use Credential to pick a preconfigured credential locker. • Use Variable to select an established variable. • Use Insecure string to enter your secret in the field without encryption. • Enter the secret code for the OAuth client used in credential grants for the Client secret. • Enter the Session name for your changes to the repository.
Division	Perform actions related to division details, such as adding and removing roles to a division. <i>Division actions</i>
External contact	Perform actions such as adding and updating contact details. <i>External contact actions</i>

Action	Description
Group	Perform actions such as adding and deleting members from a group. <i>Group actions</i>
Language	Perform actions such as adding, listing, and removing routing languages. <i>Language actions</i>
External organization	Perform actions such as creating, updating, and deleting organizations. <i>External organization actions</i>
Phone	Perform actions such as assigning, creating, and removing phone records. <i>Phone actions</i>
Queues	Perform actions such as adding and removing selections from queues. <i>Queues actions</i>
Role	Perform actions such as adding, setting, and removing roles for users. <i>Role actions</i>
Skill	Perform actions such as adding, replacing, and removing skills. <i>Skill actions</i>
User	Perform actions such as creating, deleting, and getting users. <i>User actions</i>

Division actions

The Genesys command package offers a palette of actions to detail and access the role of divisions.

Division action palette for Genesys

A division is a way to group and segregate objects while keeping them inside the same organization. For example, you can organize divisions by business unit, country, and office location and then assign respective objects that are configured for each individual division. After you organize and configure divisions, you can use roles to grant user access to division configurations and thus the objects within the respective division.

The Genesys package includes the following division actions:

Action	Description
Add role into division	<p>Detail a role for a division.</p> <ul style="list-style-type: none"> • Enter the ID of the user account for Internal user ID. • Enter the ID of the division for Division ID. • Enter the role of the division for Role ID. • Enter the Session name for your changes to the repository.

Action	Description
Bulk-add roles into division	<p>Detail multiple roles in a division.</p> <ul style="list-style-type: none"> • Select how data is organized within your Division dataset. <ul style="list-style-type: none"> • If using a Table: <ul style="list-style-type: none"> • Click Edit table to create your table. • Enter the data into the cells of your table. • If using Variable, then select the established variable of the data to be added to the division. • Select the proper ID of the first, second, and third columns. These must correspond with the User, Role, and Division IDs of your dataset. • Enter the Session name for your changes to the repository. • Optionally, Choose a variable where the data will be saved.
Bulk-remove roles for division	<p>Delete multiple roles from a division.</p> <ul style="list-style-type: none"> • Select how data is organized within your Division dataset. <ul style="list-style-type: none"> • If using a Table: <ul style="list-style-type: none"> • Click Edit table to create your table. • Enter the data into the cells of your table. • If using Variable, then select the established variable of the data to be removed from the division. • Select the proper ID of the first, second, and third columns. These must correspond with the User, Role, and Division IDs of your dataset. • Enter the Session name for your changes to the repository. • Optionally, Choose a variable where the data will be saved.
Bulk-replace roles in division	<p>Replace multiple roles in a division.</p> <ul style="list-style-type: none"> • Select how data is organized within your Division dataset. <ul style="list-style-type: none"> • If using a Table: <ul style="list-style-type: none"> • Click Edit table to create your table. • Enter the data into the cells of your table. • If using Variable, then select the established variable of the data to replace in the division. • Select the proper ID of the first, second, and third columns to map the corresponding User, Role, and Division IDs of your dataset. • Enter the Session name for your changes to the repository. • Optionally, Choose a variable where the data will be saved.

Action	Description
Get the home division	<p>Retrieve the home division for the organization.</p> <ul style="list-style-type: none"> • Enter the Session name for your changes to the repository. • Select how the outcome data will be saved. <ul style="list-style-type: none"> • If using Multiple variables, use the following steps for each variable: <ul style="list-style-type: none"> • Click Add variable mapping. • Enter the Key of the variable. • Choose a variable where the data will be saved. • Click Add for this division to be saved to the configured variable. • If using a Dictionary variable, then select the established variable.
List/search divisions	<p>Retrieve the home division for the organization.</p> <ul style="list-style-type: none"> • Optionally, enter the Division name. • Enter the Session name for your changes to the repository. • Choose a variable where the data will be saved.
Remove role from division	<p>Delete a grant of a role in a division.</p> <ul style="list-style-type: none"> • Enter the ID of the user account for Internal user ID. • Enter the ID of the division for Division ID. • Enter the role of the division for Role ID. • Enter the Session name for your changes to the repository.

External contact actions

The Genesys package offers a palette of actions to detail and access data for external contact records.

External Contact action palette for Genesys

An external contact includes a comprehensive repository of data relevant to making contact with an individual or external organization. From an external contact record, you have a streamlined view of all contact and organization data.

Detail as much or as little relevant data beyond the first and last name of the contact. Optional data can include salutation, title, external organization ID, multiple phones, addresses, and an external system URL.

Note: When providing the organization ID that represents an external organization in Genesys, the contact will be linked to that org.

The Genesys package includes the following external contact actions:

Action	Description
Create contact	<p>Add details of a new contact.</p> <ul style="list-style-type: none"> • Enter the first name. • Enter the last name. • Enter optional data. • Select Yes or No for the Survey opt out. • Enter the Session name for your changes to the repository. • Optionally, Choose a variable where the external contact ID will be saved.
Delete contact	<p>Delete an external contact.</p> <ul style="list-style-type: none"> • Enter the External contact ID. • Enter the Session name for your changes to the repository.
List/search contacts	<p>Find and view specific contacts that match your search query.</p> <ul style="list-style-type: none"> • Optionally, enter the External contact ID. • Optionally, enter keywords for your Search query. • Enter the Session name for your changes to the repository. • Choose a variable where the outcome data will be saved.
Update contact	<p>Update the details for an external contact.</p> <ul style="list-style-type: none"> • Enter the External contact ID of the record that you want to update. • Enter the first name • Enter the last name • Enter optional data. • Select Yes or No for Survey opt out. • Enter the Session name for your changes to the repository.

Group actions

The Genesys package offers a palette of actions to detail and access data for grouping records.

Group action palette for Genesys

Groups organize people with similar traits. For example, users that share skills, locations, or other information maintained in Genesys Cloud can be grouped for organizational functions.

Groups can be work-related or social to assist in project and priorities. Examples of groups include the following:

- **Subject Matter Experts (SMEs):** A group of SMEs can let others in the organization know the most current information.
- **Projects:** Groups related to projects streamline information to the team and expedite updates and planning.
- **Locations:** Groups can simplify communication for geographical updates and events.

The Genesys package includes the following group actions:

Action	Description
Bulk-add members into group	<p>Add multiple members into a group.</p> <ul style="list-style-type: none"> • Enter the Group ID. • Select how the data will be entered to begin adding user data. <ul style="list-style-type: none"> • If using a List: <ul style="list-style-type: none"> • Select the data Type. • Enter the Value of the data in the list. • If using Variable, then select the established variable of the data to be entered in the group. • Enter the Session name for your changes to the repository.
Delete member	<p>Delete a member from a group.</p> <ul style="list-style-type: none"> • Enter the Group ID. • Select how the data will be entered to begin deleting user data from the group. <ul style="list-style-type: none"> • If using a List: <ul style="list-style-type: none"> • Select the data Type. • Enter the Value of the data in the list. • If using Variable, then select the established variable of the data to be deleted from the group. • Enter the Session name for your changes to the repository.
List groups	<p>View all groups.</p> <ul style="list-style-type: none"> • Enter the Session name for your changes to the repository. • Choose a variable where the outcome data will be saved.
List members	<p>List all the members in a specific group.</p> <ul style="list-style-type: none"> • Enter the Group ID. • Enter the Session name for your changes to the repository. • Choose a variable where the outcome data will be saved.

Language actions

The Genesys package offers a palette of actions to detail languages for call-routing purposes.

Language actions for Genesys

Languages are separate from Automatic Call Distribution (ACD) skills. For example, Genesys Cloud will prioritize an agent that speaks the language requested by the customer over an agent who is more skilled but cannot speak the requested language. An agent that cannot speak the language of the customer does not receive that interaction regardless of ACD skill.

Attributing users with languages empowers your team to handle diverse calls with effective communication. The Genesys package includes the following language actions:

Action	Description
Add routing language	<p>Add a routing language to a user.</p> <ul style="list-style-type: none"> • Enter a unique user ID for the Internal user ID. • Enter the Language ID that is to be added to the user. • Enter the user's language Proficiency with a value of 0-5. Zero is low proficiency. • Enter the Session name for your changes to the repository.
Bulk-add routing languages to user	<p>Attribute multiple users with languages.</p> <ul style="list-style-type: none"> • Select how the dataset will be entered. <ul style="list-style-type: none"> • If using a Table: <ul style="list-style-type: none"> • Click Edit table to create your table. • Enter the data of the cells for your table. • If using Variable, then select the established variable of the data to be added to the user. • Select the proper ID of the first, second, and third columns to map the corresponding User, Role, and Division IDs of your dataset. • Enter the Session name for your changes to the repository. • Optionally, Choose a variable where the outcome data will be saved.
List user's routing languages	<p>List the languages attributed to a user.</p> <ul style="list-style-type: none"> • Enter the unique user ID for the Internal user ID. • Enter the Session name for your changes to the repository. • Choose a variable where the outcome data will be saved.
List all routing languages	<p>List all the supported languages.</p> <ul style="list-style-type: none"> • Enter the Session name for your changes to the repository. • Choose a variable where the outcome data will be saved.
Remove routing language from user	<p>Remove an attributed language from a user.</p> <ul style="list-style-type: none"> • Enter the unique user ID for the Internal user ID. • Enter the Language ID to be removed. • Enter the Session name for your changes to the repository.

External organization actions

The Genesys package offers a palette of actions to detail and access data for external organization records.

External organization action palette for Genesys

External organizations are your customers, partners, and other businesses that you interact with. An organization (org) can also be considered an account and is related to External Contacts in that contacts

belong to an org. Simply put, contacts are customers and the relationship defines what business a contact might be calling about. Allowing an agent to view customer information and the org of the customer help the agent to quickly understand the relevant business details to best serve their needs. Therefore, having the org details available to bots can enable workflows, such as automatically importing account data into Genesys from other systems, using Genesys Org details to look up open cases for the account from an external case management tool, and so on.

Similar to contacts, you can detail as much or as little relevant data beyond the name of the org. Optional data can include company type, industry, multiple phones, addresses, tags, and websites. The Genesys package includes the following external organization actions:

Action	Description
Create organization	<p>Create the initial external organization record.</p> <ul style="list-style-type: none"> • Enter the Name of the org. • Enter the optional data. • Select whether the org approved to be contacted through Phone SMS. • Select whether the org approved to be contacted through Fax SMS. • Enter the Session name for your changes to the repository. • Optionally, Choose a variable where the org ID can be saved.
Delete organization	<p>Delete a record of an external organization.</p> <ul style="list-style-type: none"> • Enter the ID for the external organization. • Enter the Session name for your changes to the repository.
Get organization	<p>Call the details of an external organization record.</p> <ul style="list-style-type: none"> • Enter the ID for the external organization. • Enter the Session name for your changes to the repository. • Select how the outcome data will be saved. <ul style="list-style-type: none"> • If using Multiple variables, use the following steps for each variable: <ul style="list-style-type: none"> • Click Add variable mapping. • Enter the Key of the variable. • Choose a variable where the data will be saved. • Click Add for this data to be saved to the configured variable. • If using a Dictionary variable, then select the established variable where the outcome data can be saved.
List/search organizations	<p>Call a list of external organizations that match your search query.</p> <ul style="list-style-type: none"> • Optionally, enter keywords for your Search query. • Enter the Session name for your changes to the repository. • Choose a variable where the outcome data will be saved.

Action	Description
Update organization	<p>Update an external organization record with new or additional data.</p> <ul style="list-style-type: none"> • Enter the ID of the external organization record. • Enter the Name of the org. • Enter the optional data. • Select whether the org approved contact through Phone SMS. • Select whether the org approved contact through Fax SMS. • Enter the Session name for your changes to the repository.

Phone actions

The Genesys package offers a palette of actions to detail and access data for phone records.

Phone action palette for Genesys

Genesys Cloud supports the WebRTC technology with the Genesys Cloud WebRTC phone. The Genesys Cloud WebRTC phone runs from a browser, that is, there are no special hardware requirements or software to download. When the Genesys Cloud WebRTC phone is enabled, you can immediately use it to make and receive calls. It is an important part of the onboarding process that phones be created and assigned to agents so that calls are effectively routed from the queue to agents.

Configuring a Genesys Cloud WebRTC phone is a two-step operation. First, base settings must be created and configured by the admin and must already be established. Second, the phone is created and configured to retrieve established base settings. These secondary tasks can be automated. The Genesys package includes the following phone actions:

Action	Description
Assign phone	<p>Assign a phone line to a user.</p> <ul style="list-style-type: none"> • Enter a unique user ID for the Internal user ID. • Enter a line ID to assign the Phone's line ID to the user. • Enter the Session name for your changes to the repository.
Create a phone	<p>Create a phone record.</p> <ul style="list-style-type: none"> • Enter a Name for the phone. • Enter the Phone base setting ID to route the preconfigured base settings. • Enter the Site ID where the phone is located. • Enter the Web rtc user ID of the WebRTC user. • Enter the Session name for your changes to the repository. • Optionally, Choose a variable for the Phone ID. • Optionally, Choose a variable for the Phone's line ID.
List phone base settings	<p>Get a list of phone base settings.</p> <ul style="list-style-type: none"> • Optionally, enter a Name for the list. • Enter the Session name for your changes to the repository. • Choose a variable where the outcome data can be saved.

Action	Description
List/search phones	<p>Get a list of phones.</p> <ul style="list-style-type: none"> Optionally, enter a Name for the list. Enter the Session name for your changes to the repository. Choose a variable where the outcome data can be saved.
List/search sites	<p>Get a list of sites.</p> <ul style="list-style-type: none"> Optionally, enter a Name for the list. Enter the Session name for your changes to the repository. Choose a variable where the outcome data can be saved.
Remove a phone	<p>Remove a phone record.</p> <ul style="list-style-type: none"> Enter the Phone ID to be removed. Enter the Session name for your changes to the repository.

Queues actions

The Genesys command package offers a palette of actions to detail and access data for grouping records.

Queues action palette for Genesys

Queues are the waiting lines of interactions. Agents select the **On Queue** status to enter their predefined queues. Contact center queue settings include creating and managing queues for voice and chat channels for the entire organization. The Genesys package includes the following queues actions:

Action	Description
Add to queue	<p>Add selection to queue.</p> <ul style="list-style-type: none"> Enter the Session name for your changes to the repository. Enter the Queue ID of the queue that you want to add. Select how the data will be entered to begin adding user data to the queue. <ul style="list-style-type: none"> If using a List: <ul style="list-style-type: none"> Select the data Type. Enter the Value of the data in the list. If using Variable, then select the established variable of the data to be entered in the queue.
List members	<p>List the members of a queue.</p> <ul style="list-style-type: none"> Enter the Session name for your changes to the repository. Enter the Queue ID of the queue that you want to add. Choose a variable where the outcome data can be saved.

Action	Description
List/search queues	<p>Retrieve a list of queues that match your input criteria.</p> <ul style="list-style-type: none"> Optionally, enter a Name for the list. Enter the Session name for your changes to the repository. Choose a variable where the outcome data can be saved.
Remove from queue	<p>Remove selected users from a queue.</p> <ul style="list-style-type: none"> Enter the Session name for your changes to the repository. Enter the Queue ID for the queue that you want to remove users from. Select how the data will be entered to begin adding user data to the queue. <ul style="list-style-type: none"> If using a List: <ul style="list-style-type: none"> Select the data Type. Enter the Value of the data in the list. If using Variable, then select the established variable of the data to be entered in the queue.

Role actions

The Genesys package offers a palette of actions to detail and access data for the roles of users.

Role action palette for Genesys

Because permissions are based on the assigned role, the role of users is important in the on-boarding process. Tasks are then assigned based on the permissions that a user has. The Genesys package includes the following role actions:

Action	Description
Add users to role	<p>Add a list of users to a role.</p> <ul style="list-style-type: none"> Enter the Role ID of the role that you want to add users to. Select how the data will be entered to begin adding user data to the role. <ul style="list-style-type: none"> If using a List: <ul style="list-style-type: none"> Select the data Type. Enter the Value of the data in the list. If using Variable, then select the established variable of the data to be added to the role. Enter the Session name for your changes to the repository.

Action	Description
List/search roles	<p>Retrieve a list of roles for the organization.</p> <ul style="list-style-type: none"> Optionally, enter the Role name for the list. Enter the Session name for your changes to the repository. Choose a variable where the outcome data can be saved.
List user's roles	<p>Retrieve a list of roles and permissions for a user.</p> <ul style="list-style-type: none"> Enter the unique ID of the user for the Internal user ID. Enter the Session name for your changes to the repository. Select how the outcome data will be saved. <ul style="list-style-type: none"> If using Multiple variables, use the following steps for each variable: <ul style="list-style-type: none"> Click Add variable mapping. Enter the Key of the variable. Choose a variable where the data will be saved. Click Add for this list to be saved to the configured variable. If using a Dictionary variable, then select the established variable where the outcome data can be saved.
List users in a role	<p>Retrieve a list of the unique user IDs of the users in the specified role.</p> <ul style="list-style-type: none"> Enter the Role ID for the list. Enter the Session name for your changes to the repository. Choose a variable where the outcome data can be saved.
Remove users from role	<p>Remove a list of users from a specific role.</p> <ul style="list-style-type: none"> Enter the Role ID that you want to remove users from. Select how the data will be entered to begin adding user data that will be removed from the role. <ul style="list-style-type: none"> If using a List: <ul style="list-style-type: none"> Select the data Type. Enter the Value of the data in the list. If using Variable, then select the established variable of the data to be removed from the role. Enter the Session name for your changes to the repository.

Action	Description
Set the user's roles	<p>Set the roles for a specific user.</p> <ul style="list-style-type: none"> • Enter the unique ID of the user for the Internal user ID. • Select how the data will be entered to begin adding role data that will be attributed to the user. <ul style="list-style-type: none"> • If using a List: <ul style="list-style-type: none"> • Select the data Type. • Enter the Value of the data in the list. • If using Variable, then select the established variable of the data to be attributed to the user. • Enter the Session name for your changes to the repository.

Skill actions

The Genesys package offers a palette of actions to detail and access the skills of agents.

Skill action palette for Genesys

Genesys allows for defining Automatic Call Distribution (ACD) and profile-based skills for agents. An ACD skill routes each contact to the available agents who can best meet the contact's needs. Profile skill data becomes keywords for advanced searches and parameters for creating groups and can also be used by the Workforce Management capabilities to create schedule scenarios. The Genesys package includes the following skill actions:

Action	Description
Add user routing skills	<p>Attribute routing skills to a user.</p> <ul style="list-style-type: none"> • Enter a unique user ID for the Internal user ID. • Enter the Skill ID that is to be added to the user. • Enter the user's skill Proficiency with a value of 0-5. Zero is low proficiency. • Enter the Session name for your changes to the repository.

Action	Description
Bulk-add routing skills	<p>Add multiple routing skills to a single user.</p> <ul style="list-style-type: none"> • Select how the skill dataset will be entered. <ul style="list-style-type: none"> • If using a Table: <ul style="list-style-type: none"> • Click Edit table to create your table. • Enter the data in the cells for your table. • If using Variable, then select the established variable of the data to be added to the user. • Select the proper data of the first, second, and third columns to map the corresponding User ID, Skill ID, and Skill proficiency of your dataset. • Enter the Session name for your changes to the repository. • Optionally, Choose a variable where the outcome data will be saved.
Bulk-replace routing skills	<p>Replace multiple routing skills for a single user.</p> <ul style="list-style-type: none"> • Select how the skill dataset will be entered. <ul style="list-style-type: none"> • If using a Table: <ul style="list-style-type: none"> • Click Edit table to create your table. • Enter the data in the cells for your table. • If using Variable, then select the established variable of the data to be replaced. • Select the proper data of the first, second, and third columns to map the corresponding User ID, Skill ID, and Skill proficiency of your dataset. • Enter the Session name for your changes to the repository. • Optionally, Choose a variable where the outcome data will be saved.
List/search routing skills	<p>Retrieve a list of routing skills.</p> <ul style="list-style-type: none"> • Optionally, enter a Skill name for the list. • Enter the Session name for your changes to the repository. • Choose a variable where the outcome data will be saved.
List user's routing skills	<p>Retrieve a list of user's routing skills.</p> <ul style="list-style-type: none"> • Enter a unique user ID for the Internal user ID. • Enter the Session name for your changes to the repository. • Choose a variable where the outcome data will be saved.

Action	Description
Remove user routing skills	<p>Remove routing skills for a user.</p> <ul style="list-style-type: none"> • Enter a unique user ID for the Internal user ID. • Enter the Skill ID that you want to remove. • Enter the Session name for your changes to the repository.

User actions

The Genesys package offers a palette of actions to detail and access user records.

User action palette for Genesys

A person is on-boarded as a user. User records can then be assigned with different attributes and roles. The user record begins the process of building out a fully organized work force. The Genesys package includes the following user actions:

Action	Description
Create user	<p>Create a new user.</p> <ul style="list-style-type: none"> • Enter the user's Email (login ID). • Select how you would like your password entered. <ul style="list-style-type: none"> • Use Credential to pick a preconfigured credential locker. • Use Variable to select an established credential variable. • Use Insecure string to enter your credential in the field. • Enter the Password required for the user to sign in. • Enter the Full name of the user. • Enter a Division ID for the user. • Select whether the user State is active or inactive in the repository. • Optionally, enter the user's Title and Department. • Enter the Session name for your changes to the repository.
Delete user	<p>Delete an existing user.</p> <ul style="list-style-type: none"> • Enter the unique user ID for the Internal user ID that you want to delete. • Enter the Session name for your changes to the repository.

Action	Description
Get user	<p>Retrieve the details of a user.</p> <ul style="list-style-type: none"> • Enter a unique user ID for Internal user ID. • Enter the Session name for your changes to the repository. • Select how the outcome data will be saved. <ul style="list-style-type: none"> • If using Multiple variables, use the following steps for each variable: <ul style="list-style-type: none"> • Click Add variable mapping. • Enter the Key of the variable. • Choose a variable where the data will be saved. • Click Add for this data to be saved to the configured variable. • If using a Dictionary variable, then select the established variable where outcome data can be saved.
List/search users	<p>Retrieve a list of users that match your input criteria.</p> <ul style="list-style-type: none"> • Select how the data will be entered to begin adding user data to the search. <ul style="list-style-type: none"> • If using a List: <ul style="list-style-type: none"> • Select the data Type. • Enter the Value of the data in the list. • If using Variable, then select the established variable of the data to be added to the list. • Optionally, select whether the State of the user is active or inactive. • Enter the Session name for your changes to the repository. • Choose a variable where the outcome data can be saved.
Update user	<p>Update the details of a user. Leave any field blank if no update is needed.</p> <ul style="list-style-type: none"> • Enter a unique user ID for the Internal user ID. • Enter the data that you want to update, such as the following: <ul style="list-style-type: none"> • Email (login ID) • Department • Manager • Date hired • Employee type • Biography, Interests, or Hobbies • Spouse • Select to turn Auto answer on or off for connecting calls to the user. • Enter the Session name for your changes to the repository.

Google Calendar package

The **Google Calendar** package contains actions that enable you to automate creating and deleting events.

Before you start

Use the actions in the Google Calendar package in the following order:

1. Use the **Connect** to establish a connection to the Google server.

See [Using the Connect action for Google packages](#).

2. Use a combination of available in this to automate tasks.

Note: To use from other Google , establish a connection using the **Connect** from that .

3. Use the **Disconnect** to terminate the connection.

Actions in the Google Calendar package

The **Google Calendar** package includes the following actions:

Action	Description
Create event	See Using the Create new calendar event action .
Delete event	Removes the event from the calendar. <ul style="list-style-type: none"> • Enter the same session name that you provided in the Connect . • Enter the Event Id. This is the string in the URL that appears after <code>/eventedit/</code> when you open an event for editing. • Optional: Assign the event to a String variable.

Using the Create new calendar event action

Use the **Create new calendar event** action to specify event attendees, duration, location, recurrence, and title. During run time, this action triggers an email notification to meeting attendees.

To create a new calendar event, do the following:

1. Enter the session name you used to connect to the G-Suite server in the **Connect** action.

See [Using the Connect action for Google packages](#).

2. Enter the event title.
3. Optional: Enter the location.
4. Optional: Enter the attendees' email addresses, separated with commas.
5. Enter the start date.
Use the format yyyy-MM-dd.
6. Enter the end date.
Use the format yyyy-MM-dd.

7. Select the **All Day** or **Specify Time** option from the **Event Time** option.
 - If you select the **All Day** option, you do not need to provide any additional details.
 - If you select the **Specify Time** option, complete the following fields:
 - Specify the **Start Time** using the HH:mm:ss format.
 - Specify the **End Time** using the HH:mm:ss format.
8. Select the **Use System Timezone** or **Specify Timezone** option from the **Timezone** option.
 - If you select the **Use System Timezone** option, you do not need to provide any additional details.
 - If you select the **Specify Timezone** option, complete the following fields:
 - Specify the **Start Timezone**.
 - Specify the **End Timezone**.
9. Optional: Mark the **Recurring** option to make this event repeat.
10. Select a Visibility option from the drop-down list.
Select from **Default**, **Public**, or **Private**.
11. Optional: Enter an event description.
12. Optional: Select a string variable from the drop-down list to store the id of the created event.
13. Click **Save**.

Using the Connect action for Google packages

Use the **Connect** action to establish a connection with the Google server in order to use other actions from that same package to automate tasks. All of the fields in this action accept a credential from the Credential Vault, variable, or a user-input value.

Configure the OAuth settings in the Google Cloud Platform and retrieve the credentials necessary to connect Automation Anywhere Enterprise with your Google G Suite applications.

1. If you have not already done so, [create a project](#).
2. [Enable the APIs](#) for the Google G Suite applications you want to automate, such as the Google Drive API, Google Calendar API, and Google Sheets API.
3. Do the steps in [Setting up OAuth 2.0](#) to generate the Client ID and Secret.

Note:

- Select the **Web application** option.
- Add this authorized redirect URI: `http://localhost:8888/Callback`

-
4. Do these steps to set up [user consent](#) for the username that you will use to connect to the Automation Anywhere Enterprise.
 1. In the **Actions** palette, double-click or drag the **Connect** action from the package you want to use.
 2. In the **Username** field, you can provide a valid username or select the credential or credential variable that contains your Google username. To enter a value, click **Insecure string**.
 3. If you are configuring the **Connect** action for the Google Calendar or Google Sheets package, enter a session name.
 4. In the **Client Id** field, select the credential or credential variable that contains the client ID. To enter a value, click **Insecure string**.

5. In the **Redirect URI** field, enter `http://localhost:8888/Callback`

Note: For the Google Sheets package, the **Redirect URI** attribute is not supported. Enter the fixed redirect URL directly in Google Cloud Platform: `http://localhost:8888/Callback`

6. In the **Client secret** field, select the credential or credential variable that contains the access token. To enter a value, click **Insecure string**.
7. For Google Sheets, you can specify the wait time (in minutes) in the **Wait for action to complete (In minutes)** field when performing actions such as **Get**, **Set**, or **Delete**. By default, the wait time is 10 minutes.
If the Google sheet does not open within the time you specify, the task proceeds to execute the next set of actions.

Note: When you use **Connect** action to connect to the Google server, the option **Wait for action to complete (In minutes)** is only supported in Google Sheets package.

8. Click **Save**.

The first time the bot runs, the Google login window is displayed. You must select the Google account and approve the requested access permissions.

The token file gets generated for the first time after you provide the access permissions when the bot gets deployed. It is created based on values that you provide in the **Username**, **Client Id** and **Client secret** field, and asks for credentials only the first time to provide the access permission. Next time it uses the same token file to connect to the Google Sheets.

- If there is any change in the **Client Id** and **Client secret** or if you enter a wrong password while providing the access permissions for the first time, then you must delete the existing token file to make it work.
- If you enter the correct credentials when providing access permissions for the first time and can connect to the Google Sheets successfully, then next time if there is a change in only the password, you need not delete the token file as it will work as expected.

Use other the actions from the same Google package to automate tasks. To use actions from another Google packages, establish a connection using the **Connect** action from that package.

Related reference

[Google Calendar package](#)

The **Google Calendar** package contains actions that enable you to automate creating and deleting events.

[Google Drive package](#)

Automate tasks related to files and folders by using the actions in the **Google Drive** package.

[Google Sheets package](#)

The **Google Sheets** package contains actions that enable you to automate tasks involving cells, columns, rows, and sheets.

Google Drive package

Automate tasks related to files and folders by using the actions in the **Google Drive** package.

Before you start

Use the actions in the Google Drive package in the following order:

1. Use the **Connect** to establish a connection to the Google server.

See [Using the Connect action for Google packages](#).

2. Use a combination of available in this to automate tasks.

Note: To use from other Google , establish a connection using the **Connect** from that .

3. Use the **Disconnect** to terminate the connection.

Actions in the **Google Drive** package

The **Google Drive** package includes the following actions:

Action	Description
Check permissions	<p>Checks for a file or folder permissions and returns <code>read</code>, <code>write</code>, or <code>delete</code> to a list variable.</p> <ul style="list-style-type: none"> • Enter the same username that you provided in the Connect . • Select whether to check permissions for a file or a folder. Select File or Folder and enter the name and path to the file or folder. To check the permissions of files shared with you in Google Drive, select File ID to enter the file id. You can extract the file id from the URL of the file name and enter it in the File ID field. <hr/> <p>Note: If you select the File ID option, the user with a Commenter role with the write access will observe that the bot does not check the write permission and returns the value as false.</p> <hr/> <ul style="list-style-type: none"> • To check the various kinds of permissions, select Read, Write, or Delete. This returns <code>read</code>, <code>write</code>, or <code>delete</code> to a Boolean variable. • Select or create a Boolean variable to hold the permissions.

Action	Description
Copy file	<p>Copies a file from one folder to another in the Google Drive.</p> <ul style="list-style-type: none"> • Enter the same username that you provided in the Connect . • Select whether to identify the source file by file path and name, or by ID. <hr/> <p>Note: The ID is the value in the URL after the last forward slash. For example, if the URL is <code>https://docs.google.com/spreadsheets/d/12dlAwvrEA4JeLysfFky9</code>, the ID is <code>12dlAwvrEA4JeLysfFky9</code>.</p> <hr/> <ul style="list-style-type: none"> • Select whether to identify the destination folder by directory path and name, or by ID. • Optional: Mark the Rename file option and enter the new file name.
Copy folder	<p>Copies a folder from one location to another.</p> <ul style="list-style-type: none"> • Enter the same username that you provided in the Connect . • Select whether to identify the source file by folder path and name, or by ID. If this is a shared folder, you must use the Folder ID option. <hr/> <p>Note: The ID is the value in the URL after the last forward slash. For example, if the URL is <code>https://docs.google.com/spreadsheets/d/12dlAwvrEA4JeLysfFky9</code>, the ID is <code>12dlAwvrEA4JeLysfFky9</code>.</p> <hr/> <ul style="list-style-type: none"> • Select whether to identify the destination folder by directory path and name, or by ID.

Action	Description
Create file permission	<p>Creates a new permission for a file.</p> <ul style="list-style-type: none"> • Enter the same username that you provided in the Connect . • Select whether to identify the file by file path and name, or by ID. <hr/> <p>Note: The ID is the value in the URL after the last forward slash. For example, if the URL is <code>https://docs.google.com/spreadsheets/d/12dlAwvrEA4JeLysfFky9</code>, the ID is <code>12dlAwvrEA4JeLysfFky9</code>.</p> <hr/> <ul style="list-style-type: none"> • Select a role. For more information, see Google Drive Roles. • Select the grantee type. Choose from: <ul style="list-style-type: none"> • User • Group • Domain • Anyone • If you select User or Group, enter the email address. If you select domain, enter the domain. • Optional: Select or create a variable to hold the permission ID.
Create folder	<p>Creates a folder.</p> <ul style="list-style-type: none"> • Enter the same username that you provided in the Connect . • Enter the parent folder where to create the folder. To create the folder in the root folder enter <code>root</code>. • Enter the folder name. • Optional: Select or create a string variable to hold the ID of the new folder.

Action	Description
Delete file	<p>Deletes a file on your Google Drive.</p> <ul style="list-style-type: none"> • Enter the same username that you provided in the Connect . • Select whether to identify the file by file path and name, or by ID. <hr/> <p>Note: The ID is the value in the URL after the last forward slash. For example, if the URL is <code>https://docs.google.com/spreadsheets/d/12dlAwvrEA4JeLysfFky9</code>, the ID is <code>12dlAwvrEA4JeLysfFky9</code>.</p> <hr/> <ul style="list-style-type: none"> • Optional: Select or create a boolean variable to hold the file delete status.
Delete file permission	<p>Deletes a file permission for a file.</p> <ul style="list-style-type: none"> • Enter the same username that you provided in the Connect . • Select whether to identify the file by file path and name, or by ID. <hr/> <p>Note: The ID is the value in the URL after the last forward slash. For example, if the URL is <code>https://docs.google.com/spreadsheets/d/12dlAwvrEA4JeLysfFky9</code>, the ID is <code>12dlAwvrEA4JeLysfFky9</code>.</p> <hr/> <ul style="list-style-type: none"> • In the Permission id field, enter the permission ID. • Optional: Select or create a variable to hold the permission ID.
Delete folder	<p>Deletes a folder from the Google Drive.</p> <ul style="list-style-type: none"> • Enter the same username that you provided in the Connect . • Select whether to identify the folder by path and name, or by ID. <hr/> <p>Note: The ID is the value in the URL after the last forward slash. For example, if the URL is <code>https://drive.google.com/drive/folders/0B0MqCb--3Y8QQz1JcVRJb3UxcTg</code>, the ID is <code>0B0MqCb--3Y8QQz1JcVRJb3UxcTg</code>.</p> <hr/> <ul style="list-style-type: none"> • Optional: Select or create a boolean variable to hold the folder delete status.

Action	Description
Download file	<p>Downloads a file from your Google Drive to a specific location on your desktop.</p> <ul style="list-style-type: none"> • Enter the same username that you provided in the Connect . • Select whether to identify the file by file path and name, or by ID. <hr/> <p>Note: The ID is the value in the URL after the last forward slash. For example, if the URL is <code>https://docs.google.com/spreadsheets/d/12dlAwvrEA4JeLysfFky9</code>, the ID is <code>12dlAwvrEA4JeLysfFky9</code>.</p> <hr/> <ul style="list-style-type: none"> • Specify the download file path. For example, <code>C:/Users/Downloads</code>. • Optional: Mark the Overwrite existing file option to overwrite the file of the same name. • Optional: Mark the Rename file option to enter a new name for the downloaded file. • Optional: Select or create a variable to hold the ID of the downloaded file.
Find file/folder	<p>Finds files or folders in a specific directory in your Google Drive.</p> <ul style="list-style-type: none"> • Enter the same username that you provided in the Connect . • Select whether to search for files or folders. • Enter the source folder to search in. For example, <code>/Home/Accounts/</code>. • Specify whether to return exact matches or • Enter the file or folder name to search for. • Select or create a variable to hold the list of files or folders.

Action	Description
Get file information	<p data-bbox="883 205 1224 233">Gets file information of a file.</p> <ul data-bbox="883 254 1451 415" style="list-style-type: none"> <li data-bbox="883 254 1451 310">• Enter the same username that you provided in the Connect . <li data-bbox="883 321 1451 415">• Select whether to identify the file by file path and name, or by ID. If this is a shared folder, you must use the FILE ID option. <hr data-bbox="922 436 1461 443"/> <p data-bbox="922 449 1409 638">Note: The ID is the value in the URL after the last forward slash. For example, if the URL is <code>https://docs.google.com/spreadsheets/d/12dlAwvrEA4JeLysfFky9</code>, the ID is <code>12dlAwvrEA4JeLysfFky9</code></p> <hr data-bbox="922 653 1461 659"/> <ul data-bbox="883 659 1451 783" style="list-style-type: none"> <li data-bbox="883 659 1451 783">• Select or create a dictionary variable to hold the file information which is stored in two keys: the <code>name</code> key holds the file name and the <code>extension</code> key holds the file extension.
Get file permission	<p data-bbox="883 833 1461 890">Retrieves file information for specific file or folder from Google Drive.</p> <ul data-bbox="883 911 1451 1035" style="list-style-type: none"> <li data-bbox="883 911 1451 968">• Enter the same username that you provided in the Connect . <li data-bbox="883 978 1451 1035">• Select whether to identify the file by file path and name, or by ID. <hr data-bbox="922 1056 1461 1062"/> <p data-bbox="922 1073 1409 1262">Note: The ID is the value in the URL after the last forward slash. For example, if the URL is <code>https://docs.google.com/spreadsheets/d/12dlAwvrEA4JeLysfFky9</code>, the ID is <code>12dlAwvrEA4JeLysfFky9</code>.</p> <hr data-bbox="922 1276 1461 1283"/> <ul data-bbox="883 1283 1451 1344" style="list-style-type: none"> <li data-bbox="883 1283 1451 1344">• Select or create a list variable to hold the file permissions.

Action	Description
Move file	<p>Moves a file from one folder to another.</p> <ul style="list-style-type: none"> • Enter the same username that you provided in the Connect . • Select whether to identify the file by file path and name, or by ID. <hr/> <p>Note: The ID is the value in the URL after the last forward slash. For example, if the URL is <code>https://docs.google.com/spreadsheets/d/12dlAwvrEA4JeLysfFky9</code>, the ID is <code>12dlAwvrEA4JeLysfFky9</code>.</p> <hr/> <ul style="list-style-type: none"> • Select whether to identify the destination folder by directory path and name, or by ID. <hr/> <p>Note: The ID is the value in the URL after the last forward slash. For example, if the URL is <code>https://docs.google.com/spreadsheets/d/12dlAwvrEA4JeLysfFky9</code>, the ID is <code>12dlAwvrEA4JeLysfFky9</code>.</p> <hr/>
Move folder	<p>Moves a folder from one location to another.</p> <ul style="list-style-type: none"> • Enter the same username that you provided in the Connect . • Select whether to identify the source file by folder path and name, or by ID. If this is a shared folder, you must use the Folder ID option. <hr/> <p>Note: The ID is the value in the URL after the last forward slash. For example, if the URL is <code>https://docs.google.com/spreadsheets/d/12dlAwvrEA4JeLysfFky9</code>, the ID is <code>12dlAwvrEA4JeLysfFky9</code>.</p> <hr/> <ul style="list-style-type: none"> • Select whether to identify the destination folder by directory path and name, or by ID.

Action	Description
Open file	<p>Opens a file from the specified directory in Google Drive.</p> <ul style="list-style-type: none"> • Enter the same username that you provided in the Connect . • Select whether to identify the file by file path and name, or by ID. <hr/> <p>Note: The ID is the value in the URL after the last forward slash. For example, if the URL is <code>https://docs.google.com/spreadsheets/d/12dlAwvrEA4JeLysfFky9</code>, the ID is <code>12dlAwvrEA4JeLysfFky9</code>.</p> <hr/>
Open folder	<p>Opens a folder from the specified directory in Google Drive.</p> <ul style="list-style-type: none"> • Enter the same username that you provided in the Connect . • Select whether to identify the folder by directory path and name, or by ID. <hr/> <p>Note: The ID is the value in the URL after the last forward slash. For example, if the URL is <code>https://docs.google.com/spreadsheets/d/12dlAwvrEA4JeLysfFky9</code>, the ID is <code>12dlAwvrEA4JeLysfFky9</code>.</p> <hr/>
Rename file	<p>Renames a file in the Google Drive.</p> <ul style="list-style-type: none"> • Enter the same username that you provided in the Connect . • Select whether to identify the file by file path and name, or by ID. <hr/> <p>Note: The ID is the value in the URL after the last forward slash. For example, if the URL is <code>https://docs.google.com/spreadsheets/d/12dlAwvrEA4JeLysfFky9</code>, the ID is <code>12dlAwvrEA4JeLysfFky9</code>.</p> <hr/> <ul style="list-style-type: none"> • Enter the new file name.

Action	Description
Rename folder	<p>Renames a folder in a specific directory in Google Drive.</p> <ul style="list-style-type: none"> • Enter the same username that you provided in the Connect . • Select whether to identify the folder by directory path and name, or by ID. <hr/> <p>Note: The ID is the value in the URL after the last forward slash. For example, if the URL is <code>https://docs.google.com/spreadsheets/d/12dlAwvrEA4JeLysfFky9</code>, the ID is <code>12dlAwvrEA4JeLysfFky9</code>.</p> <hr/> <ul style="list-style-type: none"> • Enter the new folder name.
Upload file	<p>Uploads a file from the desktop to your Google Drive.</p> <ul style="list-style-type: none"> • Enter the same username that you provided in the Connect . • Enter the file path and name. • Select whether to identify the folder where to upload the file by directory path and name, or by ID. <hr/> <p>Note: The ID is the value in the URL after the last forward slash. For example, if the URL is <code>https://docs.google.com/spreadsheets/d/12dlAwvrEA4JeLysfFky9</code>, the ID is <code>12dlAwvrEA4JeLysfFky9</code>.</p> <hr/> <ul style="list-style-type: none"> • Optional: Mark the Overwrite existing file option to overwrite the file of the same name. • Optional: Select or create a variable to hold the ID of the uploaded file.

Action	Description
Update file permission	<p>Update the permissions for a file.</p> <ul style="list-style-type: none"> Select whether to identify the file by file path and name, or by ID. <hr/> <p>Note: The ID is the value in the URL after the last forward slash. For example, if the URL is <code>https://docs.google.com/spreadsheets/d/12dlAwvrEA4JeLysfFky9</code>, the ID is <code>12dlAwvrEA4JeLysfFky9</code>.</p> <hr/> <ul style="list-style-type: none"> In the Permission id field, enter your user ID. Select a role. For more information, see Google Drive Roles. Optional: Select or create a variable to hold the permission ID.

Google Document AI package

Extract data from documents by using the Google Document AI capabilities of the Google Document AI package in your bots.

Before you start

Create a processor in Google Document AI. [Create a processor](#).

Use the actions in the Google Drive package in the following order:

1. Use the **Connect** action to establish a connection with your Google Cloud service account.
2. Configure the **Extract** action to specify the location of the documents to be extracted and provide the processor details.
3. Use the **Disconnect** action to terminate the connection.

Actions in the Google Document AI package

The Google Document AI package includes the following actions:

Action	Description
Connect	<p>Establishes a connection with the Google Cloud service account.</p> <p>Provide the following:</p> <ul style="list-style-type: none"> Key file path: Select the JSON file that contains your Google Cloud service account key. Google Cloud service session: Enter a unique name for the session.

Action	Description
Extract	Sends documents to Google Document AI for data extraction. <i>Using the Extract action for Google Document AI</i>
Disconnect	Disconnects from the Google service account. In the Session name field, enter the name of the session that you used to connect to the Google service account in the Connect action.

Using the Extract action for Google Document AI

Configure the **Extract** action to enable your bot to send documents to Google Document AI for data extraction and retrieve the output in JSON format.

Login to your Google Cloud account and go to the Processors page to retrieve your custom endpoint. See [Use your processor endpoint](#).

Your custom endpoint should follow this format: `https://LOCATION-documentai.googleapis.com/API_VERSION/projects/PROJECT_ID/locations/LOCATION/processors/PROCESSOR_ID`. You will need the parameters in bold to configure this action.

1. Double-click or drag the **Google Document AI > Extract** action.
2. In the **Document file path** field, provide the file path to the document you want to process.

Note: If using this action within a **Loop** action to process all the documents in a folder, be sure to include a period between the variable holding the file name and the one holding the extension. For example, `C:\Documents\${dictFile (name)}$.${dictFile (extension)}`.

3. Provide the following information, which is found in your custom endpoint.
 - Project id
 - Processor id
 - Location
4. In the **Session name** field, enter the name of the session you used to connect to the Google service account in the **Connect** action.
5. Optional: Select or create a string variable to hold the output.
The action returns data in JSON format.
6. Click **Save**.

You can use the actions in the **JSON** package to parse the data and extract values from specific nodes. For an overview of how to do this, refer to the following steps:

1. Initiate the JSON session with the **Start session** action. In the **JSON text** field, insert the string variable holding the output of the **Extract** action.
2. Use the **Get node value** action to parse the output of the **Google Document AI > Extract** action and assign the node values to a list variable.

You can insert a **Loop** action after the **Get node value** action to iterate through each list item to perform an operation on each node value.
3. Terminate the JSON session with the **End session** action.

Google Sheets package

The **Google Sheets** package contains actions that enable you to automate tasks involving cells, columns, rows, and sheets.

Before you start

Use the actions in the Google Sheets package in the following order:

1. Use the **Connect** to establish a connection to the Google server.
See [Using the Connect action for Google packages](#).
2. Use a combination of available in this to automate tasks.

Note: To use from other Google , establish a connection using the **Connect** from that .

3. Use the **Disconnect** to terminate the connection.

Actions in the **Google Sheets** package

The actions in the **Google Sheets** package enable you to perform the following operations:

Action	Description
Activate sheet	<p>Activates a specific sheet in the open spreadsheet.</p> <ul style="list-style-type: none"> • Enter the name of the session used to open the current spreadsheet with the Open spreadsheet action. • Specify whether to activate the sheet by index or name. <hr/> <p>Note: The sheet index count begins at 1.</p> <hr/>
Autofit columns	Resizes the columns that contain data to accommodate the data. Enter the name of the session used to open the current spreadsheet with the Open spreadsheet action.
Autofit rows	Resizes the rows that contain data to accommodate the data. Enter the name of the session used to open the current spreadsheet with the Open spreadsheet action.
Close	Saves and closes the current spreadsheet. Enter the name of the session used to open the current spreadsheet with the Open spreadsheet action.

Action	Description
Create sheet	<p>Creates a new sheet in the open workbook.</p> <ul style="list-style-type: none"> • Enter the name of the session used to open the current spreadsheet with the Open spreadsheet action. • Specify whether to create the sheet by index or name. <hr/> <p>Note: The sheet index count begins at 1.</p>
Create workbook	<p>Creates a new workbook in your Google Drive.</p> <ul style="list-style-type: none"> • Enter the username you used in the Connect action. • Enter the name of the session used to open the current spreadsheet with the Open spreadsheet action. • Enter the workbook name with one of the following file extensions: .xlsx, .xls, or .xism • Enter the file path for the new workbook or select a file variable.
Delete cell	<p>Deletes cells within a worksheet.</p> <ul style="list-style-type: none"> • Enter the name of the session used to open the current spreadsheet with the Open spreadsheet action. • Select either the Active cell or Specific cell option. If you have selected the Specific cell, enter the cell address. • Select from the following delete options: <ul style="list-style-type: none"> • Shift cells left • Shift cells up • Entire row • Entire column
Delete range	<p>Delete a range of cells.</p> <ul style="list-style-type: none"> • Enter the name of the session used to open the current spreadsheet with the Open spreadsheet action. • Enter the range address. For example A1 :B4. • Select the direction in which to shift the remaining active cells: Up or Left.

Action	Description
Delete row/column	<p>Deletes a row or column in a worksheet.</p> <ul style="list-style-type: none"> Enter the name of the session used to open the current spreadsheet with the Open spreadsheet action. Select whether to perform a row or column operation. Specify whether to delete the sheet by index or name. Specify whether to delete by index, active cell, or range. <ul style="list-style-type: none"> If you select index, enter the row/column index <hr/> <p>Note: The index count begins at 1.</p> <hr/> <ul style="list-style-type: none"> If you select range, specify the range of the rows/columns to delete. For example 1 : 10 to delete the first ten rows.
Delete sheet	<p>Deletes a sheet from the workbook.</p> <ul style="list-style-type: none"> Enter the name of the session used to open the current spreadsheet with the Open spreadsheet action. Specify whether to delete the sheet by index or name.
Get multiple cells	<p>Retrieves the values from the cells in a Google sheet and stores them in a table variable.</p> <ul style="list-style-type: none"> Enter the name of the session used to open the current spreadsheet with the Open spreadsheet action. Select the Multiple cells option to retrieve values from a range of cells, or select All cells to retrieve values from all the cells. Select or create a table variable to hold the output.
Get single cell	<p>Retrieves the value from the specific cell in a Google sheet and stores it in a string variable.</p> <ul style="list-style-type: none"> Enter the name of the session used to open the current spreadsheet with the Open spreadsheet action. Select either the Active cell or Specific cell option. If you have selected the Specific cell, enter the cell address. Select or create a string variable to hold the output.

Action	Description
Go to cell	<p>Goes to the specified cell.</p> <ul style="list-style-type: none"> • Enter the name of the session used to open the current spreadsheet with the Open spreadsheet action. • Select either the Specific cell or Active cell option. <ul style="list-style-type: none"> • If you have selected the Specific cell option, enter the cell address. For example, B4. • If you have selected the Active cell option, select the direction in which to move from the active cell.
Insert row/column	<p>Inserts a blank row or column into a spreadsheet.</p> <ul style="list-style-type: none"> • Enter the name of the session used to open the current spreadsheet with the Open spreadsheet action. • Select whether to insert a row or column. <ul style="list-style-type: none"> • If you chose row, select whether to insert the row at a specific index, above the active cell, or in a range. <hr/> <p>Note: The index count begins at 1.</p> <hr/> • If you chose column, select whether to insert the column at a specific address, to the left of the active cell, or in a range.

Action	Description
Open spreadsheet	<p>Opens an existing spreadsheet.</p> <ul style="list-style-type: none"> • Enter a session name. Use this session name in subsequent actions to associate them with this spreadsheet. • In the Username field, enter the same username that you provided in the Connect action. • Select whether to open the spreadsheet by name, URL, or spreadsheet ID: <ul style="list-style-type: none"> • Name: Enter the file name. • URL: Enter the entire URL. • Spreadsheet ID: The ID is the value in the URL after the last forward slash. For example, if the URL is <code>https://docs.google.com/spreadsheets/d/12dlAwvrEA4JeLysfFky9</code>, the ID is <code>12dlAwvrEA4JeLysfFky9</code>. • If the spreadsheet contains multiple sheets, select the Specific sheet name option and enter the sheet name.
Read column	<p>Retrieves data from a column and stores it in a list variable.</p> <ul style="list-style-type: none"> • Enter the name of the session used to open the current spreadsheet with the Open spreadsheet action. • In the Cell name field, specify the cell location from which to read the values. For example, enter <code>A5</code> to retrieve all the values located in the first column, below the fifth row. • You can also select the Read full column option to extract values from the entire column. • Select or create a list variable to hold the output.

Action	Description
Read row	<p>Retrieves data from a row and stores it in a list variable.</p> <ul style="list-style-type: none"> • Enter the name of the session used to open the current spreadsheet with the Open spreadsheet action. • In the Cell name field, specify the cell location from which to read the values. For example, enter D5 to retrieve the values located in the fifth row and right of the fourth column. • You can also select the Read full row option to extract values from the entire row. • Select or create a list variable to hold the output.
Set cell	<p>Sets the value of a specific cell.</p> <ul style="list-style-type: none"> • Enter the name of the session used to open the current spreadsheet with the Open spreadsheet action. • Enter the address of the cell. For example A5. • Enter the value to set. • Select or create a string variable to hold the value of the cell.
Write from data table	<p>Writes the contents of a data table variable to a specific spreadsheet.</p> <ul style="list-style-type: none"> • Enter the name of the session used to open the current spreadsheet with the Open spreadsheet action. • Select whether to write to the currently active sheet or to specify a sheet name. • Select the data table variable. • Enter the cell address where to start writing the data.

IBM Watson Authentication package

The **IBM Watson Authentication** package contains actions that enable you to authenticate the API token and location URL for each service, while connecting to and disconnecting from your IBM Cloud account. With this package, you only have to provide your credentials once.

Important: This is a beta package and is currently not available with the Automation 360 Enterprise and Cloud editions.

Before you start

Each service requires a unique API key and location URL. Log in to your IBM Cloud account to create an instance of the service to obtain the API Key and location URL. Automation 360 currently includes *Speech to Text*.

Actions in the IBM Watson Authentication package

Action	Description
Connect	Establishes a connection with the IBM Cloud account. Insert this action at the beginning of automation sequences that use IBM Watson packages so that you have to input the credentials only once. To use this action, select the services to connect with, then provide the API Key and URL for each service you will use.
Disconnect	Terminates the connection with the IBM Cloud account. Insert this action at the end of automation sequences that use IBM Watson packages.

IBM Watson Speech to Text package

This package supports the following audio file formats: flac, mpeg, mp3, ogg, pcm, wav, and webm. The following languages are supported: Arabic, Brazilian Portuguese, Chinese (Mandarin), English (United Kingdom and United States), French, German, Japanese, Korean, Spanish (Argentinian, Castilian, Chilean, Colombian, Mexican, and Peruvian).

Important: This is a beta package and is currently not available with the Automation 360 Enterprise and Cloud editions.

Feature	Description
Detect speakers	<p>Identifies the individuals in a conversation between multiple people.</p> <ul style="list-style-type: none"> • Supports English, Japanese, and Spanish. • Use for conversation between two people; maximum six people. • For best results, use an audio file at least a minute long. <p>The output contains the words spoken by each speaker and the timestamp.</p>
Keyword spotting	Detects specific strings in the transcript. The output contains the timestamp(s) for each keyword and a confidence score.

Feature	Description
Smart formatting	<p>Converts the following types of strings into more conventional representations to make the transcript easier to read:</p> <ul style="list-style-type: none"> • Dates • Times • Series of digits and numbers • Phone numbers • Currency values • Email and web addresses <p>For examples, see Smart formatting results. This feature supports English, Japanese, and Spanish.</p>
Profanity filter	Obscures profanity by replacing it with asterisks in the transcript.

If package

Use the actions in the **If** package to control the sequence of execution based on one or more conditions of a task.

Use the actions in the **If** package to check whether an application is running, a folder or file exists, a variable matches the specified value, an application window exists, or a machine or server is running before executing a set of actions.

Actions in the If package

The **If** package includes the following actions:

Action	Description
If	See If package
Else if (optional)	See Else if (optional) action
Else	See Else action

Conditions in the If action

Use the following conditions in the **If** action to control the flow of execution in an automation task:

Condition	Description
Application	<p>Use the Application is running or Application is not running condition to run actions based on whether an application is running or not running.</p> <p>Enter the application path or specify the path using a variable along with the amount of time to wait (in seconds) for the condition to be true.</p> <hr/> <p>Note: The Application is running and Application is not running conditions are not applicable for Internet Explorer bots because its corresponding process <code>iexplore.exe</code> runs in the background when Microsoft Edge is launched in IE mode.</p> <hr/>
Boolean	<p>Use the Boolean variable condition to execute actions based on whether a Boolean variable contains the value True or False.</p> <p>You can also use this condition to compare the values of two Boolean variables by selecting the second variable from the Insert a Variable window.</p>
Data table	<p>Use the Data table is empty condition to execute actions based on whether the specified table contains values.</p> <p>Use the Number of rows and Number of columns conditions to execute actions based on whether the number of columns or rows is Equal to, Greater than, or Less than the specified value.</p>
Datetime	<p>Use the Datetime variable condition to execute actions based on whether the value of the source datetime variable is Equal to or Not Equal to, is Greater than or Equal to, or is Lesser than or Equal to the value of the target datetime variable.</p>
Dictionary	<p>Use the Check key condition to execute actions based on whether the value of the specified key is Equal to or Not equal to, or Contains or Does not contain the target value.</p> <hr/> <p>Note: The key comparison is case-sensitive.</p> <hr/> <p>Use the Check for a single value condition to execute actions based on whether a specific key contains the target value.</p>
DLL	<p>Use the Dll session exists and Dll session does not exist condition to execute actions based on whether a Dll session is open or closed in a bot.</p>

Condition	Description
File	<p>Use the following conditions to execute the action:</p> <ul style="list-style-type: none"> File date Use this condition to verify the date and time when a file was created or modified. Specify a date or date range using the On a date, Is within last, Is between, or Is before options. For the On a date option, specify a date to verify whether the file was created or modified on that date. For the Is within last option, specify the number of days or time (in hours, minutes, and seconds). Enter the amount of time (in seconds) to wait for this condition to be true. File exists and File does not exist Use these conditions to execute an action based on whether a file exists. For example, if a data file exists, format the file and upload it to a database. File extension Use this condition to check the file extension of a selected file and then execute actions based on the results. Use the File path field to select a file. File size This condition verifies if the specified file is larger, smaller, not the same, or the same as the size you specify. Enter the amount of time (in seconds) to wait for this condition to be true.
Folder	<p>Use the Folder exists or Folder does not exist condition to execute an action based on whether a folder exists.</p>
Image Recognition	<p>Use these conditions to verify whether:</p> <ul style="list-style-type: none"> Image file is found in the Image file or not. Image file is found in the Window or not. Window is found in the Image file or not. Window is found in the Window or not. <p>For the Window conditions, you can use the Resize window option to specify the window dimensions. This option delivers a more reliable bot. It resizes the window to the dimensions at which the task was recorded, which enhances the bot's ability to identify the target object.</p> <hr/> <p>Note: This option is only available for windows that can be resized. It is not available for Desktop or Taskbar options.</p> <hr/> <p>For the Window conditions, you can use the Preview option to select a specific captured occurrence and position your click location relative to the image.</p>
JavaScript	<p>Use the Script is successful or Script is unsuccessful condition to execute actions based the status of the specified JavaScript. Select the file that contains the script and optionally specify the parameters by selecting a list variable.</p>

Condition	Description
Legacy automation	<p>The Legacy automation conditions are only used in migrated bots to ensure that they run seamlessly in Automation 360. We do not recommend using these conditions for new bot development. The following conditions to verify the following:</p> <ul style="list-style-type: none"> • Whether Web control exists or not. • Whether Window control exists or not. • Whether Window control is active or not. • Whether Script is successful or not. • Whether Child window exists or not. <p>For the Window control conditions, you can use the Resize window option to specify the window dimensions. This option delivers a more reliable bot. It resizes the window to the dimensions at which the task was recorded, which enhances the bot's ability to identify the target object.</p>
List	Use the List variable condition to execute actions based on whether the specified list variable contains a particular value. The value can be of Number , String , or Boolean data type.
Number	Use the Number variable condition to execute actions based on whether the specified number variable is Equal to or Not Equal to , or is Greater than or Equal to , or is Lesser than or Equal to a particular value.
Ping	Use the Ping is successful or Ping is unsuccessful condition to verify if a machine or server is running, and execute actions based on the result. Enter the amount of time (in seconds) to wait for the condition to be true.
Recorder	<ul style="list-style-type: none"> • Use the Object exists condition to detect an object in a window. Select a window or variable to capture the object. Enter the amount of time (in seconds) to wait for this condition to be true, that is, for the object to be detected. • Use the Object does not exist condition to verify whether a specific object exists in a window, and then based on the result, execute actions. Enter the amount of time (in seconds) to wait for this condition to be true. For example, you can use the Object does not exist condition inside the Loop > While condition to make sure that the bot does not execute the next action until the object on the business application is loaded. <hr/> <p>Note: The Object exists and Object does not exist Recorder conditions support Chromium-based Microsoft Edge with Internet Explorer mode.</p> <hr/>
Service	Use the Service is running or Service is not running condition to execute actions based on whether a service is running or not. Select Service list to choose a service from the list of available services.

Condition	Description
String	<p>Use the String variable condition to execute actions based on whether the specified source string value is Equal to or Not equal to, or Includes or Does not include the target value.</p> <p>You can select the Match case option to only execute actions if the two strings have matching uppercase and lowercase letters.</p> <p>When you extract text from a Microsoft application, the extracted text contains the <code>/r/n</code> special characters which indicate a new line. Select the Ignore Carriage return option if you want to ignore the <code>/r</code> special character when you compare the text.</p> <p>To create a condition based on whether a string is empty or not empty, compare the source value to an empty target field using the Equal to operator.</p> <p>See Example of using a conditional statement.</p>
Task Bot	<p>Use the Task successful or Task unsuccessful condition to execute actions based on the status of the specified Task Bot.</p>
VBScript	<p>Use the Script is successful or Script is unsuccessful condition to execute actions based on the status of the specified Visual Basic script. Select the file that contains the script and optionally specify the parameters by selecting a variable.</p>
Window	<p>Use the Window exists or Window does not exist condition to verify if a specific application window is open by entering the Window title or using a variable. Enter the amount of time (in seconds) to wait for the condition to be true. These conditions are used when the window title remains constant and to verify if the specific window is open and execute further actions based on the output.</p> <p>Use the Window with same title does not exist or Window with same title exist condition to verify whether a window with the same title exists or whether the window title has changed. Enter the amount of time (in seconds) to keep verifying if the condition is true. These conditions are used for window titles that are dynamic. For example, when you open a Google account webpage, enter your username and password to log into your account, the window title changes. If you want to compose a new email as a next action, you can use these conditions before you execute the next action to verify if the window with the same title exists or if the title has changed.</p>

Example

Build a basic bot that uses a desktop application

An example of how to build a basic TaskBot that uses the If package.

If action

The If action in the If package enables you to specify a condition and hold a sequence of actions to run if the condition is true.

Settings

You can configure multiple conditions within a single **If** action.

1. Click **Add condition**.
2. Select either of the following options:
 - **And**: Both of the conditions must be met for the to run.
 - **Or**: Either of the conditions must be met for the to run.
3. Select the condition from the drop-down list.

See [Using If action](#).

Using If action

Use the **If Else If** and **If Else** actions to change the flow of execution in an automation task based on certain conditions.

To use the actions in the **If** package, do the following:

1. Double-click or drag the **If** action from the **If** package in the **Actions** palette.
2. Select the required condition from the **Condition** list.
See [If package](#) for a list of available conditions.
3. Drag the actions to be executed if the condition is satisfied within the **If** condition.
4. Double-click or drag the **Else If** action from the **If** package in the **Actions** palette to include alternative actions to run if the condition for the **If** action is false, and if the condition for the **Else If** action is true.
5. Drag the actions to be executed if the condition is satisfied within the **Else If** condition.
6. Double-click or drag the **Else** action from the **If** package in the **Actions** palette to include actions to run if the conditions for the **If** and **Else If** actions are false.
7. Drag the actions to be executed if the condition is satisfied within the **Else** condition.
8. Click **Save**.

Else if (optional) action

The Else if (optional) action in the If package enables you to specify an alternative condition to test if the condition specified in the If action is false.

Settings

If this alternative condition is true, the bot runs the sequence of actions contained within the **Else if** action.

You can configure multiple conditions within a single **Else if** action.

1. Click **Add condition**.

2. Select either of the following options:
 - **And:** Both of the conditions must be met for the to run.
 - **Or:** Either of the conditions must be met for the to run.
3. Select the condition from the drop-down list.

Else action

The Else action in the If package enables you to specify the alternative sequence of actions.

Settings

Specifies the alternative sequence of actions if the condition specified in the If action and **Else if** action (if used) is false.

Image Recognition package

The **Image Recognition** package contains actions that enable you to search for a user interface (UI) element in an application based on an image to automate a task in that application.

Actions in the **Image Recognition** package

Use these actions to automate a task when it is not possible to capture UI elements of applications that are:

- Exposed over Citrix
- Accessed using the Remote Desktop Protocol (RDP)
- Developed using legacy technology

Image recognition is also useful when object-based recognition does not work or is unreliable. For example, you can use an image to search for the **Close** button in an application and perform a left-click operation.

The **Image Recognition** package contains the following actions:

Action	Description
Find image in window	See Using Find image in window action.
Find window in window	See Using the Find window in window action.

Secure recording

When secure recording mode is enabled, bots display only the target image but not the source image. This ensures that sensitive data is not shown. To see a preview of the source image in the **Preview** window, click the **Preview** button.

Note: The target images are still stored in the Control Room because they are required to run the bots.

A user with admin privileges must enable this setting. See [Settings](#).

Secure recording

When secure recording mode is enabled, bots do not display the target object images after capture. This ensures that sensitive data is not shown.

Note: Although the bots do not display the target images after capture, the images are still stored in the Control Room because they are required to run the bots.

When you record a task in secure recording mode, the **Preview** window temporarily shows an image of the captured area. This image is hidden after you navigate away from the Bot editor window or refresh it.

A user with admin privileges must enable this setting. See [Settings](#).

Related reference

[Screen resolution dependent packages](#)

The screen resolution between the Bot Runner and Bot Creator device should be consistent as when resolution-dependent packages are used to build bots, any screen resolution difference between the Bot Creator and Bot Runner device will impact the bots during runtime.

Using Find image in window action

Use the **Find image in window** action to search for a UI element in an application window (haystack) using a target image (needle). The target image is an existing image that you can use to search for a UI element.

To find an image inside an application window, follow these steps:

1. Double-click or drag the **Find image in window** action from the **Image Recognition** package in the **Actions** palette.
2. Specify the target image (needle) that you want to find in the application window.
 - **Control Room file:** Uses an image file that is available on the Control Room.
 - **Desktop file:** Uses an image file that is available on your device.
 - **Variable:** Uses a file variable to specify the location of the image file you want to use.

Note: Images of .jpeg, .jpg, .jpe, .jfif, .bmp, .png, and .gif formats are supported.

3. Specify the window in which you want to find the source image (haystack):
Choose from the **Application**, **Browser**, or **Variable** tab.

Option	Description
Application	Select from a list of currently active windows. This option shows a list of all the application and browser windows that are open on the Bot Creator device.
Browser	Select from a list of supported browser tabs. Note: This option supports , Chromium-based , and browsers. For all other browsers, use the Application option.
Variable	Select an existing window variable to specify the title of the application window title.

Insert a wildcard character (*) in the **Window title** field to search for window titles that can change. You can specify one or more wildcards (*) at the start, middle, or end of the value. For example, to

perform an operation on any window that has `Microsoft` in the title, use a wildcard to indicate any string by adding it before or after the value: `*Microsoft*`. The first searches for the exact window title (`Microsoft`), and if it does not find a match, it searches for windows with the term `Microsoft` anywhere in the title.

You can use a regular expression (regex) to identify a window title. Select the regular expression condition as either **String** or a **Pattern** and then enter the value. By default, the **Window title** field is case-sensitive.

To identify a browser title, you can enable the **Case sensitive** option to match the letter case, or disable the option to identify a window title where the letter case does not match.

Note: Ensure that the minimum version installed on your system is the version that was released with v.26. If you have a version released with v.25 or earlier, then by default, the window title will be identified only with matching letter case (case-sensitive).

For example, you can enter the **String** value as `((\w*)-Notepad` for all window title names starting with `((\w*)-Notepad`, or use **Pattern** value as `((\w)\s)*document-Notepad` for only those window titles that match this pattern.

Note:

- When you use a regular expression of type **String** with `-title` as the input value for a window title in any , the might encounter a run time error. To prevent the run time error, ensure that when you add the string input as `*-title`, the application with the specific title is open. The asterisk (*) is just a character, not a wild card character.
 - When you use a regular expression of type **Pattern** with `-title` as the input value for a window title in any , the might encounter a run time error because the input value `*-title` is incorrect. Ensure that you use valid regex patterns.
-

4. Optional: Select the **Resize window option to specify the window dimensions.**

This option delivers a more reliable bot. It resizes the window to the dimensions at which the task was recorded, which enhances the ability of the bot to identify the target object.

- If the window is maximized when you record the task, this option is not selected.
 - If the window is not at the maximum size when you record the task, this option is selected, by default, and the width and height fields are automatically filled with the dimensions of the window.
-

Note: This option is available only for windows that can be resized. It is not available for the **Desktop** or **Taskbar** options.

5. Click **Capture region.**

The selected window appears.

6. Drag the mouse to select the area and right-click when done.

The captured area appears in the **Preview** section with the image coordinates underneath.

7. In the **Wait in ms before capturing the image field, specify the delay (in milliseconds) before searching for the image.**

8. Select the **Repeat if image not found check box if you want the system to retry searching for the target image if it is not found.**

- In the **Times** field, specify the number of times the system must repeat the process to find the target image.
- In the **Wait between repeats (ms)** field, specify the time period the system must wait before repeating the process of finding the target image.

9. In the **Match percentage** field, specify the acceptable percentage of matching pixels between the two images.
For example, if you specify 20 in the field as the match percentage, the system considers the images as matching even if there is up to 80% of pixel mismatch between the two images.
10. In the **Selected match number** field, enter a value to specify the occurrence of the target image on which you want to perform this action.
You can insert a variable when you do not know the number of times the image might appear on the screen. Ensure you assign variables that support numeric values.
11. Use the **Preview** option if you want to select an image that is relative (offset) to the existing target image you are searching on the application screen, or you want to select a specific occurrence if there are multiple occurrences of the target image.
12. Click **Preview**.
If a target image occurs multiple times in the **Preview** window, each occurrence is highlighted in a rectangular box and displays a number against each occurrence.
13. Select the specific highlighted occurrence, and you can position your click location relative to an existing image.

Note: If there are multiple images on an application screen that you are automating and when the target image is not easily searchable; in that case, you can select an easily identifiable image in the captured region and position your click relative to it.

14. If the target image is found multiple times in the captured region. In that case, you can select the occurrence of a particular target image or select the occurrence number from the drop-down in the **Match number (optional)** field on the right pane.
The **Match number (optional)** and the **Target Offset** fields on the right pane display the image occurrence you selected and its offset coordinates of the target image.
15. Click **Submit**.
16. In the **Target coordinate selections** field, the coordinate options **Center of match** or **Offset from match** will be selected automatically based on the action you performed in the **Preview** window.
 - **Center of match:** The image is selected based on the coordinates at the center of the matched image.
 - **Offset from match:** The image is selected based on the coordinates relative to that of the matched image.

Note: The offset coordinates measure the number of pixels from the top left corner of the image.

17. Select an option from the **Action to take on target coordinates** list to specify the action you want to perform on the matched image in the application window.
18. Click **Save**.

Using the Find window in window action

Use the **Find window in window** action to search for a UI element in an application window using a screenshot of a window. This action enables you to capture an image of a UI element in an application and use the captured image to search for that UI element in another window.

To use an image available in an application window to find an image in another application window, follow these steps:

1. Double-click or drag the **Find image in window** action from the **Image Recognition** package in the **Actions** palette.
2. Specify the target image (needle) that you want to find in the application window.

Option	Description
Browser	Select from a list of supported browser tabs. Note: This option supports , Chromium-based , and browsers. For all other browsers, use the Application option.
Application	Select from a list of currently active windows. This option shows a list of all the application and browser windows that are open on the Bot Creator device.

You can use a regular expression (regex) to identify a window title. Select the regular expression either as a **String** or **Pattern** for each regular expression condition and enter the value. By default, the **Window title** field is case-sensitive. You can enable **Case insensitive** regex flag to identify a window title that is not case-sensitive.

To identify a browser title, you can enable the **Case sensitive** option to match the letter case, or disable the option to identify a window title where the letter case does not match.

Note: Ensure that the minimum version installed on your system is the version that was released with v.26. If you have a version released with v.25 or earlier, then by default, the window title will be identified only with matching letter case (case-sensitive).

3. Click **Capture image** to capture the target image.
4. Drag the mouse pointer over an area of the application window.
The captured area appears in the **Preview** section.
5. Specify the window in which you want to find the source image (haystack):
Choose from the **Application**, **Browser**, or **Variable** tab.

Option	Description
Application	Select from a list of currently active windows. This option shows a list of all the application and browser windows that are open on the Bot Creator device.
Browser	Select from a list of Google Chrome tabs that are currently open on the Bot Creator device. Note: Currently, this option only supports Google Chrome tabs. For all other browsers, use the Application option.
Variable	Select an existing window variable to specify the title of the application window title.

Insert a wildcard character (*) in the **Window title** field to search for window titles that can change. You can specify one or more wildcards (*) at the start, middle, or end of the value.

For example, to perform an operation on any window that has `Microsoft` in the title, use a wildcard to indicate any string by adding it before or after the value: `*Microsoft*`. The bot first searches for the exact window title (`Microsoft`), and if it does not find a match, it searches for windows with the term `Microsoft` anywhere in the title.

You can use a regular expression (regex) to identify a window title. Select the regular expression either as a **String** or **Pattern** for each regular expression condition and enter the value. By default,

the **Window title** field is case-sensitive. You can enable **Case insensitive** regex flag to identify a window title that is not case-sensitive. You can enable the **Case sensitive** option to identify a static window or browser title and a title with a wildcard character that is case-sensitive and disable the option to identify a window title that is not case-sensitive.

For example, you can enter the **String** value as `((\w*)-Notepad)` for all the window title names starting with `((\w*)-Notepad)`, or use **Pattern** such as `((\w)\s)*document-Notepad` for only those window titles that match this pattern.

6. Select the **Resize window** option to specify the window dimensions.

This option delivers a more reliable bot. It resizes the window to the dimensions at which the task was recorded, which enhances the bot's ability to identify the target object.

- If the window is maximized when you record the task, this option is unselected.
- If the window is not at the maximum size when you record the task, this option is selected by default and the width and height fields auto-fill with the window dimensions.

Note: This option is only available for windows that can be resized. It is not available for the **Desktop** or **Taskbar** options.

7. Click **Capture region**.

The selected window appears.

8. Drag the mouse to select the area and right-click when done.

The captured area appears in the **Preview** section with the image coordinates underneath.

9. In the **Wait in ms before capturing window** field, specify the delay (in milliseconds) before searching for the image.

10. Select the **Repeat if image not found** check box if you want the system to retry searching for the target image if it is not found.

- a) In the **Times** field, specify the number of times the system must repeat the process to find the target image.
- b) In the **Wait between repeats (ms)** field, specify the time period the system must wait before repeating the process of finding the target image.

11. In the **Match percentage** field, specify the acceptable percentage of matching pixels between the two images.

For example, if you specify 20 in the field as the match percentage, the system considers the images as matching even if there is up to 80% of pixel mismatch between the two images.

12. In the **Selected match number** field, enter a value to specify the occurrence of the target image on which you want to perform this action.

You can insert a variable when you do not know the number of times the image might appear on the screen. Ensure you assign variables that support numeric values.

13. Use the **Preview** option if you want to select an image that is relative (offset) to the existing target image you are searching on the application screen, or you want to select a specific occurrence if there are multiple occurrences of the target image.

14. Click **Preview**.

If a target image occurs multiple times in the **Preview** window, each occurrence is highlighted in a rectangular box and displays a number against each occurrence.

15. Select the specific highlighted occurrence, and you can position your click location relative to an existing image.

Note: If there are multiple images on an application screen that you are automating and when the target image is not easily searchable; in that case, you can select an easily identifiable image in the captured region and position your click relative to it.

16. If the target image is found multiple times in the captured region. In that case, you can select the occurrence of a particular target image or select the occurrence number from the drop-down in the **Match number (optional)** field on the right pane.

The **Match number (optional)** and the **Target Offset** fields on the right pane display the image occurrence you selected and its offset coordinates of the target image.

17. Click **Submit**.

18. In the **Target coordinate selections** field, the coordinate options **Center of match** or **Offset from match** will be selected automatically based on the action you performed in the **Preview** window.

- **Center of match:** The image is selected based on the coordinates at the center of the matched image.
- **Offset from match:** The image is selected based on the coordinates relative to that of the matched image.

Note: The offset coordinates measure the number of pixels from the top left corner of the image.

19. Select an option from the **Action to take on target coordinates** list to specify the action you want to perform on the matched image in the application window.

20. Click **Save**.

Interactive forms package

The interactive forms package contains actions that handle exceptions encountered by a bot. All the actions performed by users on the interactive forms can be monitored to execute logic using subtasks.

Interactive forms are first-class citizens within the bot repository and have the same workflows for moving forms between public and private workspaces, and for export or import actions. Handling exceptions ensures that a bot completes a task when it encounters an error.

Actions in the Interactive forms package

The interactive forms package includes form-level and element-level actions.

The following actions are available at the form level:

Action	Description
Display	Load and display the selected form. Select or insert a variable in the Form name field to display the form when an event is triggered. Optionally, select the check box to always display the form window in front.
Close	Closes the selected form.
Show	Loads or displays a hidden form. Select or insert a variable in the Form name field for a hidden form, which is displayed on the desktop when an event is triggered.
Hide	Hides the selected form from the user's view.
Reset	Resets the selected form to its default value. Select or insert a variable in the Form name field for a form. All the values of this specified form are reset when an event is triggered.

Action	Description
Validate form	<p>Validates all the elements within the selected form.</p> <ul style="list-style-type: none"> • Select or insert a variable in the Form name field for a specific form, which is validated when an event is triggered. • Select the next event by creating or selecting a variable using the Assign the return value to a boolean variable field. <hr/> <p>Note: The Validate form action is not applicable to Rich Text Editor elements.</p>
Change Form Title	<p>Changes the title of the selected form.</p> <ul style="list-style-type: none"> • Select or insert a variable in the Form name field for a specific form. • Enter the new title that must appear for the selected form in the New Title (optional) field.

The following actions are available at the element level:

Action	Description
Assign	<p>Assigns dynamic values to the Dropdown element of a form.</p> <ul style="list-style-type: none"> • Select or insert a variable in the Form name field. • Select the Dropdown element of the form from the Form element field, which is enabled when an event is triggered. • Use Assign to set one of the following actions: <ul style="list-style-type: none"> • Append: Specified values or variables are added to the selected Dropdown element. • Overwrite: Specified values or variables replace the existing data in the selected Dropdown element. <hr/> <p>Note: The Assign action is now applicable for the Checkbox and Radio Button elements in interactive forms.</p>
Enable	<p>Enables the specified element of the selected form.</p> <ul style="list-style-type: none"> • Select or insert a variable in the Form name field. • Select a specific element of the form from the Form element field, which is enabled when an event is triggered.
Disable	<p>Disables the specified element of the selected form.</p>
Get	<p>Retrieves the value from the specified element of the selected form.</p> <ul style="list-style-type: none"> • Select or insert a variable in the Form name field and use the Form element to select a specific element of the form. • Use the Returns the value drop-down menu to assign this value to a variable when an event is triggered. <p><i>Create a variable</i></p>

Action	Description
Set	<p>Assigns the user-defined or global variable to the selected element of the specified form.</p> <ul style="list-style-type: none"> • Select or insert a variable in the Form name field and use the Form element to select a specific element of the form. <p>If you select Table as the Form element, use the Set Value Type to enable the following additional options:</p> <ul style="list-style-type: none"> • Table: Sets the variable value to the entire table. • Row: Sets the variable value to the selected row. <ul style="list-style-type: none"> • Use the Input value to assign a user-defined or system variable into this element when an event is triggered.
Set focus	<p>Sets the focus on the selected element of a form.</p> <ul style="list-style-type: none"> • Select or insert a variable in the Form name field. • Use the Form element to select the specific element of the form and set the focus: <ul style="list-style-type: none"> • For form elements such as a text box, text area, number or date, the cursor appears on the element. • For form elements such as a check box or radio button, the emphasis is on the first option.
Highlight	<p>Highlights the specified element of the selected form.</p> <ul style="list-style-type: none"> • Select or insert a variable in the Form name field. • Use the Form element to select the specific element of the form to highlight it when an event is triggered. • Use the Highlight Type drop-down menu to select one of the following: <ul style="list-style-type: none"> • Warning: Displays a warning alert on the specified form element. • Error: Displays an error alert on the specified form element.
Unhighlight	<p>Removes the highlight from the specified element of the selected form.</p>
Change label	<p>Changes the label of the selected form element.</p> <ul style="list-style-type: none"> • Select or insert a variable in the Form name field. • Use the Form element to select the specific element of the form for which the label must change when an event is triggered. • Enter the name in New label field. <hr/> <p>Note: The Change label action is now applicable for Button elements in interactive forms.</p> <hr/>
Dynamic area	

Action	Description
Add row in Dynamic area	<p>Applies only to forms that have a Dynamic element. This action renders the selected form field as a single row when the bot starts.</p> <ul style="list-style-type: none"> • Select or insert a variable in the Form name field. • Use the Dynamic area drop-down menu to select the dynamic element of the form. • Use Append or Overwrite to add a row for the specified dynamic area. • Use Add element to insert elements into the dynamic area. <ul style="list-style-type: none"> • Use the Type drop-down menu to select the element type such as Checkbox group, Drop-down, File, Radio group, Snapshot, Text area, or Textbox. • Use the Label field to enter a name for the element. • Click Add to add the element. <p>You can add up to four elements.</p>
Clear	Clears all the dynamic elements in the specified form.

IQ Bot Classifier package

IQ Bot Classifier package enables you to group or classify documents into appropriate learning instances for content extraction in Automation 360 IQ Bot.

Note: IQ Bot Classifier package is available on demand. Contact your Customer Success Manager (CSM) or Partner Enablement Manager (PEM) for the package. You have to upload this package to Control Room.

[Add packages to the Control Room](#)

To use your existing bots, you must also add the license when prompted. This package has the following requirements:

- User must be assigned the IQ Bot Classifier license.
- A Bot Runner user must be associated with role that has **Administration > View License** permission enabled.

[Create a role](#)

- Ensure that the Bot Agent version is not older than the previous two versions.

For example, if you upgrade to Automation 360 v.23 Build 11513 (On-Premises), ensure that the Bot Agent version is not older than 21.82.10342.

See [Bot Agent compatibility](#).

The IQ Bot Classifier package enables you to segregate different types of documents into respective categories. This output can then be used to build logic to merge pages in a document for enhanced data extraction.

See [How to merge documents in IQ Bot Classifier package \(A-People login required\)](#).

Actions in the IQ Bot Classifier package

The package contains the **Classify**, **Classify documents**, and **Train Classifier** actions. You can use these actions to create a model file, and use the file to classify uploaded documents into different folders. These actions work as a precursor to document processing.

Actions	Description
Classify	<p>IQ Bot Classify action groups the pages of an input document based on the model file that was created using IQ Bot Train Classifier action.</p> <p>See Using Classify action</p>
Classify documents	<p>The IQ Bot Classify document action groups the input documents based on the first page of each document, using the selected model file that is created with the IQ Bot Train Classifier action. Use this action if you are manually creating document groups.</p> <p>See Using the Classify document action</p>
Train Classifier	See Using Train Classifier action

Watch the following video to understand how to use the IQ Bot Classifier package:

To learn more, review the courses in IQ Bot Developer learning trail: [IQ Bot Developer Training \(A-People login required\)](#).

Related concepts

[About the Classifier](#)

Learn about how documents are classified and the factors that affect classification.

Using Classify action

IQ Bot Classify action groups the pages of an input document based on the model file that was created using IQ Bot Train Classifier action.

- If you have not done so already, use the **Train Classifier** action to create a model file. See [Using Train Classifier action](#).
- Ensure the input files are in PDF format. If the input file is an image file (.gif, .jpg, .png, or .tiff), convert the image to a PDF. See [Using ConvertImageToPDF action](#).

Build a bot with the **Classify** action within a **Loop** action to iteratively classify each file in the selected folder.

1. In the **Actions** palette, double-click or drag the **Loop** action from the **Loop** package.
2. In the **Loop Type** field, select the **Iterator** option.
3. In the **Iterator** field, select **For each file in folder** from the drop-down list.
4. In the **Folder path** field, select the path to the folder that contains the input files.
5. In the **Assign file name and extension to this variable** field, create or select a dictionary variable to store the names and extensions of the files in the selected folder path.
For this example, we will use a dictionary variable named dictFile.
6. In the **Actions** palette, double-click or drag the **Classify** action from the **IQ Bot Classifier** package.
7. In the **Input file** field, enter a dynamic file path using a variable.
 - a) Add a file path pointing to the folder, for example C:\input\.

b) Add the dynamic file name string: `dictFile (name) $.dictFile (extension) $`.

Note: Be sure to include a period between the variable holding the file name and the one holding the extension.

The *name* and *extension* keys are predefined. When inserted and run in a loop, the action iterates through the entire folder and calls the files in the folder one at a time. The **Input file** value looks like this: `C:\input\dictFile (name) $.dictFile (extension) $`

8. In the **Classifier** field, provide the file path to the model file.

You can either select the `.zip` folder or extract the `.icmf` file from this folder and select it.

Note: For better classification results and performance, we recommend that you use the `.icmf` file available in the `.zip` folder obtained from the **Train Classifier** action.

9. Use the **Output folder path** option to save the classification output document.

10. Optional: Configure the following **ADVANCED SETTINGS**:

- **Confidence threshold (%):** If the confidence value of the category prediction of a page is less than the confidence threshold, it is moved to the `Unclassified` folder.
- **Save classification output variable:** Save the classification results as a list of dictionaries with the following keys:
 - `fileName`
 - `pageIndex`
 - `category`
 - `confidence`

11. Click **Save** and **Run**.

The pages from the output document are saved in the respective subfolders, based on the categories created in the model file. Any previously-classified documents in the output folder will be overwritten.

You can use each subfolder of similar documents to create and train a learning instance to extract data from the documents. See [Create a learning instance](#).

Using the Classify document action

The IQ Bot Classify document action groups the input documents based on the first page of each document, using the selected model file that is created with the IQ Bot Train Classifier action. **Use this action if you are manually creating document groups.**

- Build and run a bot with the **Train Classifier** action to create a model file. See [Using Train Classifier action](#).
- [Create a new document group](#)

1. In the **Actions** palette, double-click or drag the **Classify document** action from the **IQ Bot Classifier** package.

2. In the Input file field, provide the default filepath for incoming files for classification.

3. In the Classifier field, provide the filepath of the model file.

You can either select the `.zip` folder or extract the `.icmf` file from this folder and select it.

Note: For better classification results and performance, we recommend that you use the `.icmf` file available in the `.zip` folder obtained from the **Train Classifier** action.

4. Use the **Output folder path** option to save the classification output documents.
The pages from the output document are saved in the respective subfolders based on the categories created in the model file.
5. Optional: Configure the **Confidence threshold (%)**.
If the confidence value of the category prediction of a document is less than the confidence threshold, the document is moved to the `Unclassified` folder.
6. Select from **Normal mode** or **Express mode**.
 - **Normal mode:** The Classifier parses the entire document and groups it based on the fields in all the pages.
 - **Express mode:** The Classifier groups the document based on the fields in the first page.
7. Select or create a list variable to hold the output.
The classification results as a list with the following keys:
 - `fileName`
 - `pageIndex`
 - `category`
 - `confidence`

Using Train Classifier action

Use the **Train Classifier** action to create a model file that is used by the **Classify** action to sort the documents into required categories for input.

Before building the bot, collect example documents and categorize them into folders. Ensure the set of example documents meets the following requirements:

- Has at least two categories.
- A minimum of 15 pages per category (20 pages recommended).
- Split input PDF documents that have multiple pages into single-page PDF documents. See [Using the Split document action](#).

For example, if you have a PDF document that has three pages, split it into three single-page PDF documents.

If these minimum requirements are not met, an error message is displayed during bot runtime.

Each folder has a selection of documents that are a sample of the documents that the associated learning instance will process. The **Train Classifier** action will read through the files in the folders, and build a model based on the documents stored inside each folder.

Note: As ABBYY FineReader Engine OCR is now downgraded to version 12.2 from version 12.4, older `.icmf` files cannot be used to retrain models in Automation 360 v.24 of the IQ Bot Classifier package. If you want to add more categories or more files into your existing categories, you must create a new model.

1. In the **Actions** palette, double-click or drag the **Train Classifier** action from the **IQ Bot Classifier** package.
2. Click **Train** to continue creating a new model file.
3. Optional: If you have an existing model file, click **Re-Train**.
 - a) Use the **Training folder path** field to select an existing folder path from the **Desktop folder** tab.
Alternatively, click the **Variable** tab to manually enter an existing training folder path.
 - b) Use the **Existing zip path** field to select the filepath of the `.zip` folder from **Control Room file** or **Desktop file** tab.

Alternatively, click the **Variable** tab to manually enter the path for the `.zip` folder.

Note: When you train documents, a `.zip` folder is created, which contains `.icmf`, `.data` and `.properties` files. Ensure you upload the entire `.zip` folder for retraining an existing model file.

4. Select the input folder path from **Desktop folder** or **Variable**.

The input folder path must have subdirectories with the names that correspond to the category of the documents that you want to train the classifier on. For example, if you have sales-related documents, the input folder path must have subfolders such as `Invoice` and `Purchase Order`.

5. Optional: If you select **Desktop file**, click **Browse** to change the default filepath.

6. Enter a name for the model file in the **Model name** field.

7. Use the **Model output path** field to select the directory for the output model file.

8. Optional: Configure the following **ADVANCED SETTINGS**:

a) **Training Optimization:** Use the drop-down menu to select the type of training optimization.

- **Precision:** select this option when you want your training model to be precise but can miss out on few documents.
- **Recall:** select this option when you want the training model to find all the relevant cases within a dataset.
- **F1 score:** is selected by default and the recommended setting as it combines the training optimization of both **Precision** and **Recall**.

F1 score is the selected by default. **Precision** and **Recall**.

b) **Classification Type:** Use the drop-down menu to select the features you want to include such as text, image, or both.

Text and image is selected by default. If you select **Text** or **Text and image**, list of supported languages is displayed in the **Recognition Language** drop-down menu.

c) **OCR Settings:** The **Extract all text blocks** and **Extract text from images** are enabled by default.

With the **OCR Settings** enabled by default, more time is consumed by OCR in extracting the content. This ensures that relatively lower quality documents are also handled based on the inputs from OCR.

9. Click **Save** and **Run**.

The model is created as a `.icmf` file in the directory specified in the **Model output path** field.

After creating the model, build a bot to classify input documents. See [Using Classify action](#)

IQ Bot [Local Device] package

Avoid having to manage a separate IQ Bot cluster setup by leveraging your existing pool of RPA devices and process documents using multiple Bot Runners.

Note: This package is deprecated from Automation 360 v.22 (Build 10526). IQ Bot Extraction package provides all the capabilities provided by the IQ Bot [Local Device] package along with some improvements.

IQ Bot Extraction package has **Process Documents** action that is similar to IQ Bot [Local Device] package. So before using the IQ Bot Extraction package, ensure that you update the bots associated with the **Process Documents** action of the IQ Bot [Local Device] package by performing the following steps:

1. Open the bot.

2. Copy or save the configured settings for the **Process Documents** action.
3. From the IQ Bot Extraction package, drag the **Process documents** action into the workflow.
4. Apply the settings you copied or saved from the **Process Documents** action of the IQ Bot [Local Device] package.
5. Delete the **Process Documents** action of the IQ Bot [Local Device] package from the workflow.
6. Save the bot.

Additionally, ensure that you update the output folders according to the following folder structure:

- **Success:** Contains the processed CSV files.
- **Validate:** Contains the documents as CSV files that have failed the validation rules.
- **Retrain:** Contains documents that must be retrained because of one of the following conditions:
 - If a bot is not available, the original document is copied in the folder.
 - If the validation fails, the original document is copied in the folder.
- **Unprocessed:** Contains documents that encountered errors during processing.

Before you start

IQ Bot [Local Device] package helps you scale by processing documents on multiple devices simultaneously using a device pool. You can set this up using workload management in the Control Room.

Workload management

- If you are using a device pool, then you have to set up a shared file system so that all the Bot Runners can process and store documents at the same location.
- This command performs parallel processing at the folder level, so you have to set up input files in separate folders.
- You must have the IQ Bot Services role along with the Bot Runner role to run bots in production. This is required so that the Bot Runner can access the IQ Bot server when using a device pool.
- The package does not create new groups and the documents that do not match the existing groups are sent to IQ Bot Validator on the IQ Bot server.

Actions in the IQ Bot [Local Device] package

The package includes the following action:

Action	Description
Process Documents	See Using Process Documents action

Related concepts

[IQ Bot Extraction package](#)

Capability to automatically extract values provides enhanced content extraction from invoices.

Related tasks

[Using IQ Bot Process documents action](#)

Use this action to extract values from invoices using a pretrained model.

Using Process Documents action

Use the action to process documents using TaskBots created in the Control Room.

1. In the **Actions** palette, double-click or drag the **Process Documents** action from the **IQ Bot [Local Device]** package.
2. In the right-side pane, select the learning instance from the drop-down list.
You can click the refresh option to view the updated list.
Only the ABBYY FineReader Engine and Tesseract4 OCR engines are currently supported.
3. Enter the **Input documents folder path**.
 - Enter the folder path as text or choose a folder using the **Browse** option.
 - Either enter a variable name or click **Variable** to select a variable from the list.
4. Enter the **Output folder path** path.
 - Enter the folder path as text or choose a folder using the **Browse** option.
 - Either enter a variable name or click **Variable** to select one from the list.
5. Select the **Validator settings** check box if you want to review documents in the IQ Bot Validator.
When you enable this setting, documents are stored in the IQ Bot server's output path. To download documents back to your local device, use the **Download all documents** action in the IQ Bot package.

Download all documents action

The following types of documents are sent to the IQ Bot Validator:

- Failed documents (exceptions)
- Unclassified documents
- Documents that do not belong to any group

Note: If you do not want to use the IQ Bot Validator, do not enable this setting. You can build your own Validator using Interactive forms and the dashboards on Bot Insight.

Using interactive forms

-
6. Click **Save**.

IQ Bot Pre-processor package

Use the IQ Bot Pre-processor package to extract content from documents or process image files before they are sent to Automation 360 IQ Bot.

Note: This package is not available as part of the standard Automation 360 IQ Bot installation. To download and install this package, perform these steps:

1. Download the package from the Automation Anywhere support site:

[A-People Downloads page \(Login required\)](#)

The package is a .jar file available in the IQ Bot installation folder.

2. Upload the package to Control Room.

Add packages to the Control Room

Note: Ensure that the Bot Agent version is not older than the previous two versions.

For example, if you upgrade to Automation 360 v.23 Build 11513 (On-Premises), ensure that the Bot Agent version is not older than 21.82.10342.

See [Bot Agent compatibility](#).

After installation, administrator can locate the package in Automation 360: **Manage > Packages**.

Windows Media Foundation platform must be installed on your Bot Runner machine in order to use the following actions without any errors.

Actions in the IQ Bot Pre-processor package

The following table lists the actions used for processing image file:

Actions	Description
ConcatenateImages	See Using ConcatenateImages action
ConvertImageToPDF	See Using ConvertImageToPDF action
EditImage	See Using EditImage action
EnhanceImage	See Using EnhanceImage action
OrientImage	See Using OrientImage action

The following table lists the actions used for extracting content from documents:

Actions	Description
GetBarCodes	See Using GetBarCodes action
GetDocumentInfo	See Using GetDocumentInfo action
GetPageContent	See Using Get page content action

To learn more, review the courses in IQ Bot Developer learning trail: [IQ Bot Developer Training \(A-People login required\)](#).

Using ConcatenateImages action

Use the **ConcatenateImages** action in the IQ Bot Pre-processor package to link two image files.

1. Drag the **IQ Bot pre-processor > ConcatenateImages** action into your workflow.
2. Use the **Input file path 1** field to select the first input file from **Control Room file**, **Desktop file** or **Variable**.
3. Optional: If you selected **Control Room file** or **Desktop file**, click **Browse** to change the default filepath.
4. Use the **Input file path 2** field to select the second input file.
5. Select the output folder from the **Output Path** field.

6. Optional: Click **Browse** to change the default output filepath.
7. Use the **Concatenate Type** field to select one of the following options:
 - **Vertical**: To vertically concatenate or link the selected images.
 - **Horizontal**: To horizontally concatenate or link the selected images.
8. Optional: Use the **Assign output status to variable** field to set the output status of action during bot runtime.
9. Click **Save**.
When the bot runs successfully, the combined image file is saved in the specified output folder.

Using ConvertImageToPDF action

Use the **ConvertImageToPDF** action in the IQ Bot Pre-processor package to convert a selected image file to a text-enabled PDF document. The converted PDF file retains the name of the input image file by default.

1. Drag the **IQ Bot pre-processor > ConvertImageToPDF** action into your workflow.
2. Select the input file from **Control Room file**, **Desktop file** or **Variable**.
3. Optional: If you selected **Control Room file** or **Desktop file**, click **Browse** to change the default filepath.
4. Use the **Output Path** field to select the output folder for the PDF document.
5. Optional: Click **Browse** to change the default output filepath.
6. Optional: Choose from the following advance settings:
 - **Input file settings**: Use this field to select various input file settings.
For example, if the input file is a legal document (a bank check), select the **Has MICR** check box.
 - **Process settings**: Use this field for processing the output file.
For example, select the **Process text blocks independently** check box if the OCR engine must process various blocks of the input file as a specific text type.
7. Optional: Use the **Save the output status of the action as boolean** to set the output status.
8. Click **Save**.
When the bot runs successfully, the processed PDF file is saved in the specified output folder.

Using EditImage action

Use the **EditImage** action in the IQ Bot Pre-processor package to resize an image file.

1. Drag the **IQ Bot pre-processor > EditImage** action into your workflow.
2. Select the input file from **Control Room file**, **Desktop file** or **Variable**.
3. Optional: If you selected **Control Room file** or **Desktop file**, click **Browse** to change the default filepath.
4. Use the **Output Path** field to select the output folder.
5. Optional: Click **Browse** to change the default output filepath.
6. Use the **Select Image Edits** drop-down menu to select one of the following options:
 - **Crop**: Use an auto-crop or manual option to crop the image.
 - **Resize**: Change the height and width of the image.
7. Optional: Use the **Assign output status to variable** field to set the output status of action during bot runtime.

8. Click Save.

When the bot runs successfully, the edited image file is saved in the specified output folder and is suffixed by the word *processed*.

For example, if the image filename is `Sales.png`, the processed file is saved as `Sales_processed.png`

Using GetBarCodes action

Use the **GetBarCodes** action in the IQ Bot Pre-processor package to detect and extract all available barcodes from a document.

1. Drag the **IQ Bot pre-processor > GetBarCodes** action into your workflow.
2. Select the input file from **Control Room file**, **Desktop file** or **Variable**.
3. Optional: If you selected **Control Room file** or **Desktop file**, click **Browse** to change the default filepath.
4. Use the **List of dictionaries with 7 keys** drop-down menu to select the output format for the extracted strings.

If the document has multiple barcodes, multiple dictionaries are used as each dictionary corresponds to a single barcode. Each dictionary has the following seven keys that relate to the various attributes of the barcode in a document:

- Page number of the document where a barcode is available
- Type of the barcode
- Value of the barcode
- X coordinate of the barcode
- Y coordinate of the barcode.
- Width of the barcode
- Height of the barcode

5. Click Save.

When the bot runs successfully, the extracted barcodes are assigned to the output variable.

Using GetDocumentInfo action

Use the **GetDocumentInfo** action in the IQ Bot Pre-processor package to extract document information such as the page count and extension type.

1. Drag the **IQ Bot pre-processor > GetDocumentInfo** action into your workflow.
2. Select the input file from **Control Room file**, **Desktop file** or **Variable**.
3. Optional: If you selected **Control Room file** or **Desktop file**, click **Browse** to change the default filepath.
4. Use the **Dictionary object with 5 keys** drop-down menu to select the output format for the extracted information.

Each dictionary has the following five keys that relate to the various attributes of the document:

- Filepath of the document location
- Extension type of the document
- File type of the document
- Total number of pages in the document
- File size of the document

5. Click Save.

When the bot runs successfully, all the extracted information for the selected document is assigned to the output variable.

Using Get page content action

Use the **Get page content** action in the IQ Bot Pre-processor package to extract text from a specific page of a document (PDF, image file) into a list of strings.

1. Drag the **IQ Bot pre-processor > Get page content** action into your workflow.
2. Select the input file from **Control Room file**, **Desktop file** or **Variable**.
3. Optional: If you selected **Control Room file** or **Desktop file**, click **Browse** to change the default filepath.
4. Enter the page number of the selected document from which the content must be extracted.
5. Use the **List of strings extracted from page** drop-down menu to select the output format for the extracted strings.

You can use this menu to create a variable with **Type > List** and **Subtype > String**. Alternatively, you can select an existing variable with **Type > List**, and **Subtype > String** or **Subtype > Any**.

6. Click **Save**.

When the bot runs successfully, the content extracted from the specific page of the selected document assigned to the output variable.

Using EnhanceImage action

Use the **EnhanceImage** action in the IQ Bot Pre-processor package to enhance a selected image file.

1. Drag the **IQ Bot pre-processor > EnhanceImage** action into your workflow.
2. Select the input file from **Control Room file**, **Desktop file** or **Variable**.
3. Optional: If you selected **Control Room file** or **Desktop file**, click **Browse** to change the default filepath.
4. Use the **Output Path** field to select the output folder.
5. Optional: Click **Browse** to change the default filepath.
6. Optional: Click **Add effect** and use **Effect type** drop-down menu for image enhancement options.

For more information on the available options, see [Image enhancement options in EnhanceImage action](#).

Consider a scenario where you have uploaded a low quality image. Use the following options to improve the clarity and increase the brightness:

- Select **Effect type > SHARPEN**.

Additional fields associated with sharpening an image such as Gaussian blur, Alpha, Beta and Gamma are displayed.

- For this example, enter 5 in the **Alpha** field.

Value between 0 to 10 can be used in the additional fields. Optionally, you can also press F2 or click **Insert a value** option to select a system value.

- Select **Effect type > BRIGHTNESS**.
- Enter 7 in the **Brightness factor** field.

The selected enhancement options are listed in the **Effect type** field, and you can edit or delete a specific effect type.

7. Click **Add**.
8. Optional: Use the **Assign output status to variable** field to set the output status of action during bot runtime.
9. Click **Save**.

When the bot runs successfully, the enhanced image file is saved in the specified output folder.

Image enhancement options in EnhanceImage action

Improve the quality of an image that you have uploaded in the **EnhanceImage** action by using additional options available.

Option	Use
Grayscale	<p>Convert the color pixels in an image to grayscale.</p> <p>Recommended: Convert color images to grayscale to improve the OCR extraction accuracy.</p>
Blur	<p>Smoothen out areas that are pixelated and improve image quality.</p> <p>Recommended values: Any odd number (such as 3, 7, and 11), as long as it is less than the pixel size of the uploaded image.</p>
Sharpen	<p>Improve clarity by removing distorted and blurred aspects of the original image.</p> <p>Consider a scenario where you have an image file called ImageA. When you apply Gaussian blur = 5 to this image, a blurred version of this image is created called ImageB. You can then use the following Sharpen parameters:</p> <ul style="list-style-type: none"> • Alpha: 3 • Beta: -1 • Gamma: 0 <p>The following formula is applied for output:</p> <p>Output = ImageA*Alpha + ImageB*Beta + Gamma</p> <p>Where:</p> <ul style="list-style-type: none"> • ImageA: First input array (Input image) • Alpha: Weight of the first array elements • ImageB: Second input array image with the same size and channel number as ImageA • Beta: Weight of the second array elements • Gamma: Scalar added to each sum <hr/> <p>Note: The principal use of the preceding equation is to sharpen an image by removing the blurriness from the original image.</p> <hr/> <p>Recommended values:</p> <ul style="list-style-type: none"> • Gaussian blur: 0 to 10 • Alpha: 1 to 15 • Beta: -0.5 to -5 • Gamma: 0 to 50
Denoise	<p>Smoothen out pixels that are not grayscale to remove distortion or speckling from the image.</p> <p>Recommended value: 21. However, it can be any odd number as long as it is less than the pixel size of the uploaded image.</p>

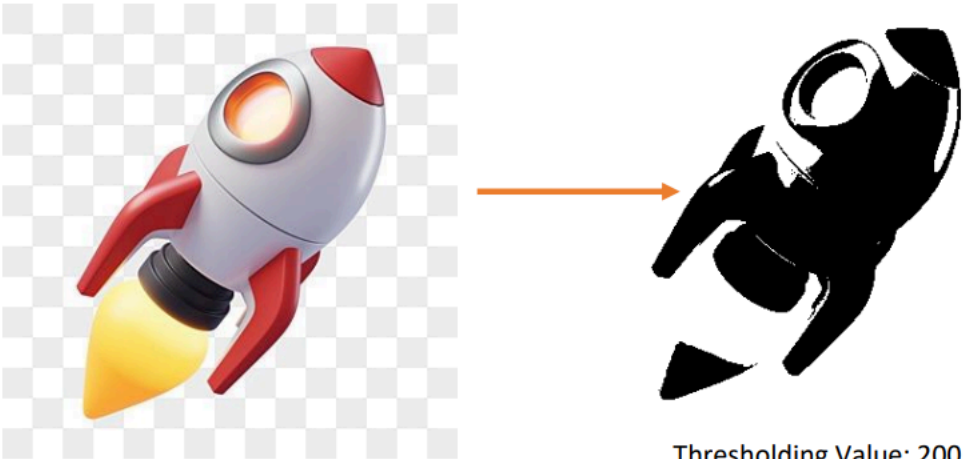
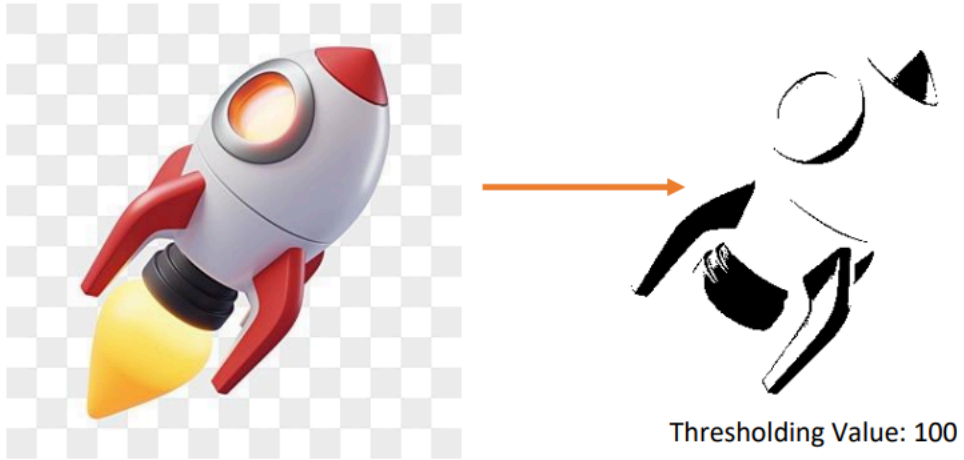
Option	Use
Contrast	Increase or decrease the contrast of the pixels. Values can range from 0 (no change) to 2 (maximum contrast). Recommended values: From 0.8 through 2.
Brightness	Increase or decrease the brightness level of all the pixels in the image. Values can range from -100 (minimum contrast) to 100 (maximum contrast), with 0 representing no change. Recommended values: From 0 through 100
Thresholding	<p>A form of image segmentation. Thresholding is an image processing method that creates a bi-tonal (binary) image by setting a threshold value on the pixel intensity of the original image. In image processing, thresholding is typically used to separate objects or foreground pixels from background. For example, the following image has been processed using Thresholding value as 200 and 100 respectively.</p> <div data-bbox="621 747 1580 1203"><p>Thresholding Value: 200</p></div> <div data-bbox="621 1314 1580 1770"><p>Thresholding Value: 100</p></div> <p>Recommended value: From 0 through 255</p>

Option	Use
Remove RGB	Provide upper and lower bound values to pixels in a color image. Pixels in a color image are represented by three primary color channels: red, green, and blue (RGB). The output of this effect is a binary image with pixels that are black (0) or white (255). Consider a scenario where you want to transform high-intensity red pixels in the range of 200 to 255 to white (255). You can set the lower bound for red to (200,0,0) and upper bound to (255,0,0).

Using OrientImage action

Use the **OrientImage** action in the IQ Bot Pre-processor package to change the orientation of a selected image file.

1. Drag the **IQ Bot pre-processor > OrientImage** action into your workflow.
2. Select the input file from **Control Room file**, **Desktop file** or **Variable**.
3. For the **Control Room file** and **Desktop file** tabs, click **Browse** to change the default filepath.
4. Use the **Apply settings** field to change the following orientation options:
 - **Flip:** Use the drop-down menu to flip the image horizontally, vertically, or horizontally and vertically.
 - **Rotate:** Use the drop-down menu to:
 - Rotate the image clockwise or anti-clockwise.
 - Change the angle of the image.

For example, enter 45 if you want to change the image angle by 45 degrees.
5. Click **Save**.

When the bot runs successfully, the modified image file is saved in the specified output folder.

IQ Bot Extraction package

Capability to automatically extract values provides enhanced content extraction from invoices.

Learning instance is an IQ Bot environment that enables you to train sample documents for content extraction. By constantly refining the learning instance, you can achieve a high content extraction accuracy before deploying the learning instance across a production environment.

IQ Bot Extraction package combines learning instance (new or existing) and a pretrained machine learning model to automatically extract content. The pretrained machine learning model uses data points to extract content from the supported document types. By providing additional training to an existing learning instance, you can extract content from other document types as well.

Note: This package is deprecated from Automation 360 v.26. IQ Bot Document Automation provides all the capabilities provided by the IQ Bot Extractionpackage. To move your bots from the IQ Bot Extraction package to Document Automation, see [Move from IQ Bot Extraction package to Document Automation](#).

The following diagram shows the IQ Bot Extraction package workflow:

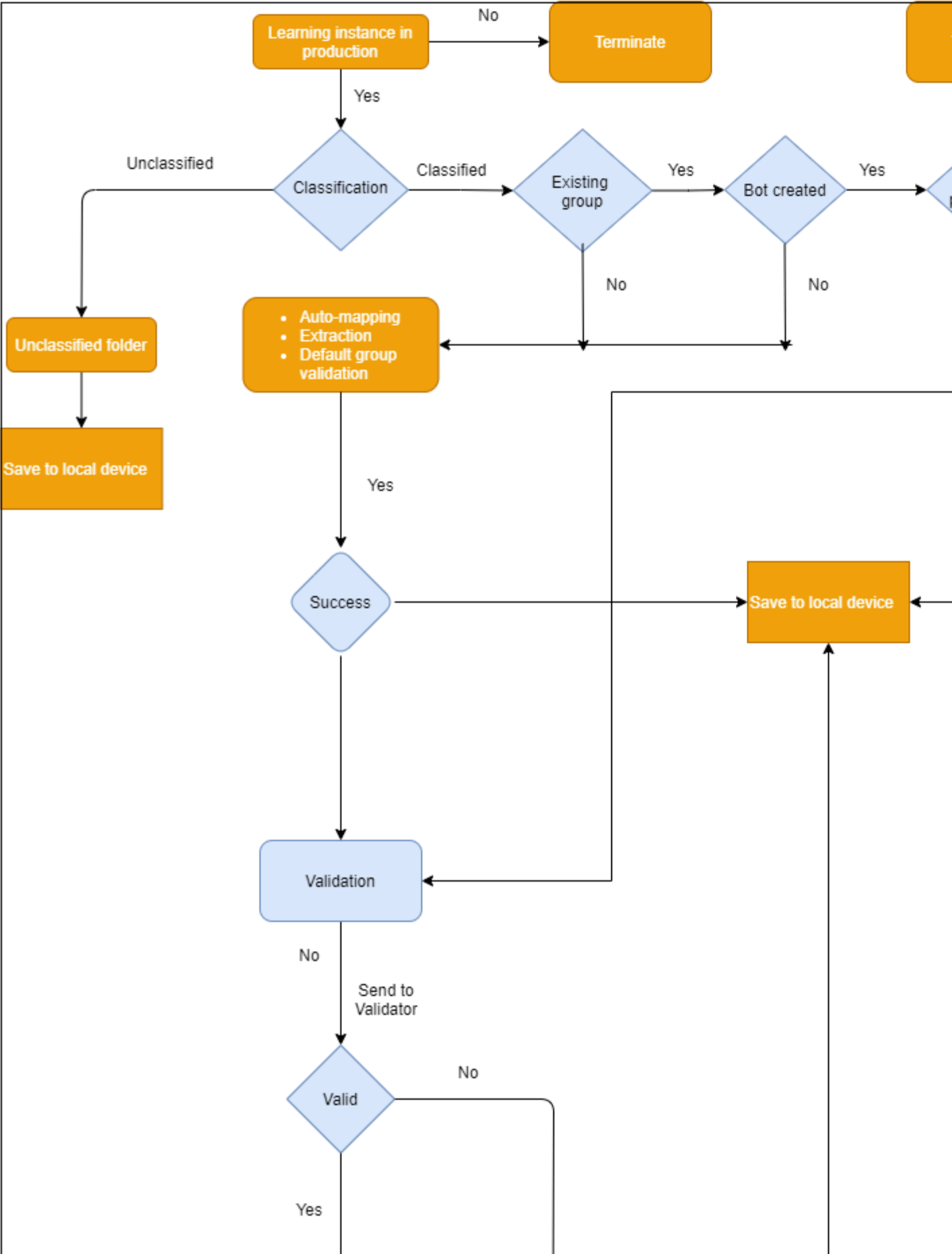

Contact your Customer Success Manager (CSM) or Partner Enablement Manager (PEM) for more information on the high level architecture, design and folder structure.

[High level architecture, design overview, folder structure of IQ Bot Extraction package \(A-People login required\)](#)

IQ Bot Extraction package provides the following extraction methods:

Content extraction with minimum training

The IQ Bot Extraction package is designed to extract values with minimum training from specific document type such as an invoice or purchase order.

Note: For this content extraction method, ensure you always use the ABBYY FineReader Engine OCR 12.4 engine.

Consider a scenario where you want extract sales data from various invoices. Create a learning instance by selecting a pretrained domain or document type used to extract data. In this scenario, you can select the document type as invoice, which provides a set of preset fields for content extraction. Ensure you upload a sample invoice document as a reference. Additional training of the learning instance group is not required. Use the IQ Bot Extraction package to link this learning instance to a bot. You can then run this bot to retrieve sales data based on the preset fields for various invoices.

Enhanced extraction with additional training

The IQ Bot Extraction package uses a combination of backend engine with IQ Bot server for enhanced document extraction. You can use an existing learning instance to provide additional training for all the available document groups. By customizing the various fields and validation settings of the learning instance group, you can use this package content extraction across other document types.

Important: This package is not available as part of the standard Automation 360 IQ Bot installation. To download and install this package, perform these steps:

1. Download the package from the Automation Anywhere support site. The package is a `.jar` file available in the IQ Bot **Installation Setup** folder.

[A-People Downloads page \(Login required\)](#)

2. Upload the package to Control Room.

[Add packages to the Control Room](#)

Before you start

- Ensure you create a learning instance using a supported OCR.
- Select documents with common layouts.

The preset model contains logical group. It is important to select an existing group for default validation rules to avoid documents with errors in the `Success` folder.

- Ensure that the Bot Agent version is not older than the previous two versions.

For example, if you upgrade to Automation 360 v.23 Build 11513 (On-Premises), ensure that the Bot Agent version is not older than 21.82.10342.

See [Bot Agent compatibility](#).

Action in the IQ Bot Extraction package

The following action is available to build a bot for extracting data:

Action	Description
IQ Bot Extraction	See Using IQ Bot Process documents action .

Watch the following video to understand how to use the IQ Bot Extraction package:

Related tasks

[Select an OCR engine](#)

You can select an OCR engines that suits your requirement for data extraction based on your document types. Restarting IQ Bot services is not necessary for implementing an engine change.

Move from IQ Bot Extraction package to Document Automation

As of the Automation 360 v.26 release, the IQ Bot Extraction package will be deprecated. Instead, configure your learning instances from Automation 360 IQ Bot to extract data in the new document processing solution, Document Automation.

Check if any bots in use the IQ Bot Extraction package: Navigate to **Manage > Packages**, and search for the IQ Bot Extraction package. If the status is **Enabled**, you must do steps on this page to identify the bots that contain the Process documents action and the associated learning instances, and configure those learning instances to run in Document Automation.

Packages

 Download free bots and packages from [Bot Store](#) 

Name ▼

Search

Name: extraction ×

Packages (2 of 89)

Status	Name ↑	Vendor	Version	Bot ag
 Enabled	IQ Bot Extraction	Automation Anywhere	1.0.0-20220307-024320	21.98

Set up your [Set up your Document Automation environment](#), which includes creating a custom role and users to perform tasks in Document Automation.

In this page, you connect your learning instances from Automation 360 IQ Bot, build a bot to upload documents to Document Automation, publish the learning instance assets, and deploy them to a Bot Runner.

1. Identify the learning instances that you must connect to Document Automation:
 - a) Navigate to **Automation** page, under the **Public** tab, locate the **Bots** folder.
 - b) Click on a TaskBot to open the Bot editor.
 - c) If the TaskBot contains the **IQ Bot Extraction > Process documents** action, locate the **Learning instance name** field and note the value. This is the name of the learning instance that you must connect to Document Automation.
 - d) Repeat these steps to identify all the learning instances that must be connected to Document Automation.

Connect your learning instances to Document Automation

When you connect a learning instance that was created in Automation 360 IQ Bot, the system creates learning instance assets (RPA bots, AARI process, and form) to enable the learning instance to start processing documents in Document Automation.

Note:

- This feature is available only for Document Automation customers. It is not available in Community Edition.
- The Automation 360 IQ Bot environment must be associated with the Control Room where Document Automation is installed. In addition, Automation 360 IQ Bot must be in a version that is compatible with the Control Room.
- You can connect one learning instance at a time.

-
2. Login to the Control Room as the `Admin` user. Navigate to **Manage > Learning Instances**. Click **Connect learning instance**.
This takes you to **Connect Learning Instances from IQ Bot classic page** which contains a list of Automation 360 IQ Bot learning instances.

3. Select the learning instance from version Automation 360 IQ Bot to connect with. Move it from left to right. Click **Connect**.

Connect Learning Instances from IQ Bot classic

You can edit the Learning Instance only in IQ Bot

▼

🔍

Learning Instances (4) (1 selected) ↻

	Name	Document type
<input checked="" type="radio"/>	multilan_extractionbot	Invoices
<input type="radio"/>	S_MS	Purchase Orders
<input type="radio"/>	Z_T1	Purchase Orders
<input type="radio"/>	INT1	Invoices

Selected (0)

	Name
<input type="radio"/>	

→

←

Click here to move learning instance left to right

The newly-connected learning instance appears in the Learning instances table in private mode.

4. Upload documents to the learning instance that you connected in the previous step to test its extraction capability.

a) Click **Process documents**.

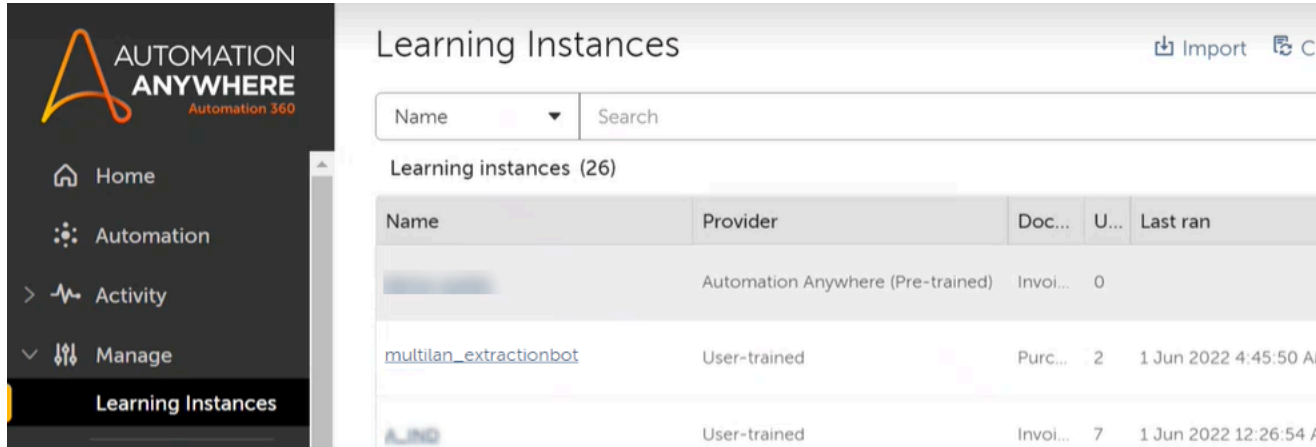

The screenshot shows the Automation Anywhere interface. On the left is a dark sidebar with the Automation Anywhere logo and navigation options: Home, Automation, Activity, Manage, and Learning Instances (highlighted). The main area is titled 'Learning Instances' and features a search bar and a table of 26 learning instances. The table has columns for Name, Provider, Doc..., U..., and Last ran. One instance named 'multilan_extractionbot' is highlighted, showing it is 'User-trained' with 2 documents and a last run time of 1 Jun 2022 4:45:50 A.

b) In the **Process Documents** window, click **Browse** to select the files to upload.

c) In the **Download data to** field, enter the file path that will hold extracted data.

When the process runs, it creates the following three folders in the provided file path:

- **Success:** Contains the extracted data in the specified format (CSV or JSON).
- **Invalid:** Holds documents marked invalid.
- **Failed:** Holds documents that could not be processed.

You can provide an output folder path based on one of the following options:

- **Option 1:** The local device path if you have set up document processing and validation on the same device.
This option is typically used when you are testing the learning instance.
- **Option 2:** The shared folder path if you have set up distributed validation on separate devices.

This option is typically used for published learning instances. For example, `\10.239.192.60\Sharepath\Output`.

d) Click **Process documents**.

The Bot Runner window appears. The window disappears when the documents are done processing. Refresh the **Learning instances** table to see the updated metrics.

If there is a value next to the **Validate documents** link, you must manually validate the document fields. Otherwise, proceed to step 3.

5. Fix the validation errorsa) Click **Validate documents**.

The AARI Task Manager opens in a new tab, with the first failed document in queue. For an introduction to the Validator user interface, see [Using the AARI Task Manager Validator for Document Automation](#).

b) Review each field to verify the data type and extracted value.

Document Automation supports the following data types: text, number, time, and check box

Alternatively, from the drop-down list on the right panel, you can select **Show fields that need validation**.

Note: When documents are awaiting validation, if you edit the learning instance, click **Reprocess** to reattempt extraction.

Reprocessing documents does not affect the uploaded documents metric.

c) Update the fields with errors.

Click the field or draw a box around the values that you want to extract.

For Automation Anywhere pre-trained models, you can configure the learning instance to extract specific values in a field and ignore others. For more information, see [Using validation feedback to extract specific values in a table](#).

<https://aa2019packagesdkfordocumentation.s3-us-west-2.amazonaws.com/videos/validation-iqbot.mp4>

- To skip a document without correcting errors, click **Skip** to proceed to the next document in the validation queue.
- To remove a document that cannot be processed, click **Mark as Invalid**.

d) After you make the necessary corrections, click **Submit** so that the document can finish processing.

The next document in queue appears. When all the documents are corrected, the system displays a message stating that no more tasks are available.

e) Close the tab to return to the **Learning Instances** page.**6. Verify the output results:**a) Open the file in the `Success` folder that contains the extracted data and review the results to ensure that it matches your use case.b) Optional: Review the **Learning Instance** dashboard.

The dashboard displays the total number of uploaded documents and the number of documents pending validation.

Configure the learning instance to process documents in production**7. Build the `Extraction-Scheduler` bot to automate uploading documents to the learning instance:**
[Build a bot to upload documents to Document Automation](#)

8. Publish the process.

- a) Navigate to **Automation > Private tab > Bots > Document Workspace processes** and select the folder with the same name as the learning instance.
- b) Mouse over the vertical ellipses to the right of the process to open the actions menu and click **Check in process**.
The **Check in Process** window opens with the bots and form auto-selected to also be checked in.
- c) In the **Check in Process** window, add your comment and click **Check in**.
The process appears in the same folder structure in the public workspace.

See these steps in a video:

<https://fast.wistia.net/embed/iframe/Iyouw132o4>

9. Publish the `Extraction-Scheduler` bot.

- a) Locate the `Extraction-Scheduler` bot in the private tab.
- b) Mouse over the triple ellipses to the right of the bot to open the menu and click **Check in Task**

Private bots and files cannot be viewed by other people. If a bot or file has been checked out from the Public tab, other people, but cannot be edited.

The screenshot shows the Automation Anywhere interface. On the left, the 'Folders' pane is open, showing a tree view with 'Bots' selected. On the right, the 'Files and folders (10)' pane is open, displaying a list of items. The list has columns for 'Type' and 'Name'. The items listed are:

	Type	Name
<input type="checkbox"/>	Folder	IQ Bot Processes
<input type="checkbox"/>	Folder	Sample bots
<input type="checkbox"/>	Task Bot	multilan_extractionbot

bot.

The **Check in Task bot** page opens with the bot auto-selected.

- c) Add a comment and click **Check in**.

10. Login as the `Document Automation Admin` user to deploy the process and bots to unattended Bot Runner devices: [Deploy the learning instance assets](#)

Build a bot to upload documents to a specific learning instance for processing and extraction: [Build a bot to upload documents to Document Automation](#)

Using IQ Bot Process documents action

Use this action to extract values from invoices using a pretrained model.

1. Drag the **Process documents** action into the workflow.
2. Use the **Learning instance name** drop-down menu to select an existing learning instance.
3. Select one of the following tabs for the input documents:

- **Desktop folder:** Enter the folder path or click **Browse** to choose a folder.
 - **Variable:** Enter a variable name or browse to select a variable from the list.
4. Select the folder (instead of a single document) that has all the documents that must be processed.
 5. Select the output folder from the **Output folder path** field.
 6. Optional: Select the **Send documents to IQ Bot Validator for validation** check box.
Although the documents are processed using Bot Runners on your local machine, you must use this option if you want to validate the documents in the IQ Bot Validator.
 7. Optional: In the **Group Label** field, provide the string variable that holds the name of the folder containing the sorted documents.
This is necessary for defining a user-created document group. For more information, see [Create a new document group](#).
 8. Click **Save**.

After the TaskBot is run, the output folder can have up to four subfolders:

- **Success:** Contains documents that the package successfully extracted all the fields from and appear as `.csv` files.
- **Validate:** Contains documents that require validation.
The documents appear as `.csv` files and IQ Bot extracts the data before you validated it. However, if you select this option, these documents will be available in the Validator and you can download the validated output separately.
- **Retrain:** Contains documents that were sent for validation.
These documents are stored in their original input format and you can train them by uploading them to your existing learning instance. The package does not create new groups. To create new groups and train the failed documents, use the **Upload** option to send the documents from the `Output\Retrain` folder to your learning instance. The groups are created based on the **Groups Creation Threshold** defined in the learning instance.
- **Unprocessed:** Contains documents that were not processed due to runtime errors.
These documents are stored in their original input format and you can process them using the IQ Bot Extraction package.

If you use the IQ Bot Validator, the validated files are stored on the IQ Bot server output folder. Use the **IQ Bot > Download all documents** **IQ Bot: Download all documents** action to download files to your output folder on the local device.

IQ Bot package

The **IQ Bot** package enables you to upload and download documents from an IQ Bot server.

Actions in the IQ Bot package

The **IQ Bot** package includes the following actions:

Action	Description
Download all documents	See Download all documents action .
Upload document	See Upload document action .

To perform these tasks using APIs, see [APIs to upload files, check file status, and downloading CSV file \(A-People login required\)](#)

Download all documents action

Use the **Download all documents** action to download the extracted results from an IQ Bot server that were created by running a Bot with the **Upload Document** action.

Note: To perform this task using an API, see [using APIs to upload files, check file status, and download CSV files \(A-People login required\)](#).

IQ Bot extracts fields from documents and exports them as CSV files. This action can also download any unclassified, untrained, and invalid documents to your local directory.

Follow these steps to download extracted results from the IQ Bot server:

1. In the **Actions** palette, double-click or drag the **Download all documents** action from the **IQ Bot** package.
2. In the **Learning instance name** field, select the name.
3. In the **Document status**, select the appropriate status for the documents.
 - **Success:** Documents have been processed and are in `.csv` format.
 - **Invalid:** Documents were marked as invalid during the validation process.
 - **Unclassified:** Documents could not be classified into any groups.
 - **Untrained:** Documents were classified into new groups during processing and require training.
 - **Fail:** Documents that failed to process and require re-processing. A document reflects **Document status** as **Fail** if an exception occurs during data extraction, validation, or storing of the final output to the database.

Unprocessed documents in **Invalid**, **Unclassified**, **Untrained** and **Fail** folders are available in their original format. For example, if your input documents were in a `.pdf` format, the output in the above folders are obtained in the `.pdf` format as well.

Note: After you upload a document by using the **Upload** action, to retrieve the latest results from the server, you need to run the **Download** action periodically. Ensure to maintain a delay of 30 seconds to 1 minute between the execution of two consecutive IQ Bot **Download** action of the same nature.

4. In the **Local output folder** field, provide the path to the file that will hold the output.
5. In the **Delete files from the server after downloading** check box, select the option to delete documents.

When you choose this option, even if your download fails, a compressed `.zip` file containing the failed documents is available for downloading again. Therefore, you must select this option.

6. Optional: In the **Save the response to a variable** field, add a variable. For example, select **prompt-assignment - string** from the drop-down list.

A variable value in this field provides information on whether the download was successful or failed, and the reason for the failure.

7. Click **Update**.
8. Click **Save**.
9. Click **Run now**.
10. Click **Close**.

Note: If the download fails, verify the variable value using a **Message Box** or **Log to File** action. See the **Save the response to a variable** description.

11. Navigate to the local output folder to review the downloaded files.

Upload document action

The **Upload Document** action enables you to upload a document with IQ Bot. IQ Bot extracts fields from the document and exports them to CSV files.

- Gain access to an Control Room.
- Ensure your local host is a registered device in the Control Room.

Note: To perform these tasks using APIs, see [using APIs to upload files, check file status, and download CSV files \(A-People login required\)](#).

Use the **Upload Document** action to upload a single document to the Control Room.

Note: Azure confidential computing enables organizations to upload encrypted data to secured storage, such as private folders on a virtual machine. If you upload documents from such secured folders to IQ Bot, these are moved to **Unclassified** status as data extraction is not supported for such documents.

Follow these steps to upload a document:

1. In the **Actions** palette, double-click or drag the **Upload Document** action from the **IQ Bot** package.

Note: A file size of 50 MB is supported for the upload action.

Note: The file names of the documents that you upload should not start with special characters, such as the hyphen (-).

2. In the **Learning instance name** field, select the name.

3. In the **File path** field, specify the location or type of the file.

4. Optional: In the **Group Label** field, provide the string variable that holds the name of the folder containing the sorted documents.

This is necessary for defining a user-created document group. .

5. Optional: In the **Save the response to variable** field, add a variable. For example: select **prompt-assignment - string** from the drop-down list.

A variable value in this field provides information about the file upload process: if the upload was successful or failed, and the reason for the failure.

6. Click **Apply**.

7. Click **Save**.

8. Click **Run now**.

9. Click **Close**.

To upload multiple files, insert the **Upload Document** action into a **Loop** action. See the [Loop package](#).

JavaScript package

The **JavaScript** package contains actions to run a JavaScript from a bot. These actions can run JavaScript on Windows, Linux, and UNIX based devices.

Before you start

1. Open a JavaScript file, or specify the script you want to run using the **Open** action. You must associate the details of the file or script you want to run with a session name. Use this same session name for other **JavaScript** actions.
2. Use the **Run JavaScript** action to run a function within a script or an entire script. You must use the same JavaScript session name established in the **Open** action.
3. Close the JavaScript session after running the script.

To review the bot launcher logs, navigate to `C:\ProgramData\AutomationAnywhere\BotRunner\Logs\<current month>\Bot_Launcher-<today's date>.log.zip`. Each zipped folder contains a file with data on the code execution, which is useful for debugging.

Note: Review the following known JavaScript exceptions (other exceptions might exist based on individual scenarios):

- All JavaScript run with JavaScript actions on the terminal.
 - We do not support any JavaScript that requires a browser to run.
-

Actions in the JavaScript package

The **JavaScript** package includes the following actions:

Note: If you built a bot using actions from the JavaScript package from Build 5322 or earlier, the actions will be missing when you open the bot with the default package version. You must reinsert the actions and repopulate the fields.

Action	Description
Close	Closes the session. Specify the same session name from the Open action.

Action	Description
Open	<p>Opens a JavaScript file.</p> <ul style="list-style-type: none"> In the JavaScript session field, specify a session name. Use this same session name for other JavaScript actions. Choose one of the following options: <ul style="list-style-type: none"> In the Import existing file option, select an existing JavaScript file. <hr/> <p>Note: If you are uploading a script from a file on your desktop, the file and any dependencies must be in a standalone folder. When you select a file for upload, all files and folders at the same folder level are uploaded.</p> <hr/> In the Manual input option, enter the JavaScript.
Run JavaScript	<p>Runs a function within the JavaScript.</p> <ul style="list-style-type: none"> In the JavaScript session field, specify a session name. Use the same session name from the Open action. Optional: Specify the function name to run and the arguments to pass to the function. <hr/> <p>Note: You can pass only a list variable as an argument for the function. You can use the list variable to pass multiple arguments of different data types such as Boolean, datetime, number, and string.</p> <hr/> <ul style="list-style-type: none"> Optional: In the Assign the output to variable field, specify the variable. The shows a descriptive default variable name. If you create several output variables, subsequent variable names are appended with a <i>-1, -2, -3</i>, and so on to avoid duplication.

Json package

Extract the required information from Json text or file by using the Json package and use the extracted values in your bots.

Before you start

Use the actions in the Json package in the following order:

1. Start the Json session using the **Start session** action. Use this session name for all corresponding actions.
2. Use the different actions available in the Json package to automate Json-related tasks.
3. End the session using the **End session** action to complete a task.

Actions in the Json package

The Json package includes the following actions:

Action	Description
End session	Closes a Json session. <ul style="list-style-type: none">• Enter the session name or select a variable used in the Start session action.• Save and close the session.
Get node list	Retrieves the list of child nodes for a node path. <ul style="list-style-type: none">• Enter the key or node path to retrieve multiple nodes or select a variable.• Enter the session name or select an existing variable used in the Start session action.• In the Save the outcome to variable field, select a list type variable to hold the output.
Get node value	Retrieves the value of a node. <ul style="list-style-type: none">• Enter the key or node path to retrieve multiple nodes or select an existing variable.• Enter the session name or select a variable used in the Start session action.• In the Save the outcome to variable field, select a string type variable to hold the output.

Action	Description
Start session	<p>Creates a new Json session based on a Json file or specified text.</p> <ul style="list-style-type: none"> Start the Json session. In the Data Source field, select either File or Text: <ul style="list-style-type: none"> File: Select from the Control Room file, Desktop file, or an existing Variable of File type. Text: Specify the text name or select a variable. <hr/> <ul style="list-style-type: none"> Note: <code>json</code> and <code>.txt</code> extensions are supported in the file path for the Desktop option. <hr/> <ul style="list-style-type: none"> Select any of the following tabs from the Json object session to create a Json session: <ul style="list-style-type: none"> Local session: Specify a session name that can be used only in the current bot. Global session: Specify a session name that can be used across multiple bots, such as parent bots, child bots, and other child bots of the parent bots. Variable: Specify a session variable that can be used to share that session with other child bots.

Legacy Automation package

The actions in the Legacy Automation package are only used in migrated bots to ensure that they run seamlessly in Automation 360. We do **not** recommend using this package for new bot development.

Note: If you built a bot using actions from the Legacy Automation package from Build 5322 or earlier, the actions will be missing when you open the bot with the default package version. You must reinsert the actions and repopulate the fields.

Expressions

Expressions appear in action input fields. This package has the following expressions:

Expression	Description	Use example
DictionaryToString	Converts a dictionary variable to a string variable	<pre>{{ \$dictionaryVar.LegacyAutomation:dictionary }}</pre> <p>The output is a string variable with the following value: <code>{key1,value1}, {key2,value2}</code></p>

Expression	Description	Use example
GetAbsolutePath	<p>Provides you the relative path of all (non-Automation Anywhere) files present on your system by having a global variable at the start of the path. In Enterprise 11 or Enterprise 10, the equivalent of GetAbsolutePath is present at Tools > Options > Runtime Settings > Start in path of task.</p> <p>In Enterprise 11 or Enterprise 10, any folder in the repository can be used as a starting path for the GetAbsolutePath value. If the path in the Enterprise 11 or Enterprise 10 bot is an absolute path, the migration process does not make any change to the migrated bot. If the path in the Enterprise 11 or Enterprise 10 bot is a relative path and contains a variable, the migration process adds a global variable at the start of the path as prefix alongside the relative value path.</p>	<ul style="list-style-type: none"> • <code>variable.txt</code>: The input provided in this example is a relative path, and the output will be <code>C:\testing\variable.txt</code>, where, <code>C:\testing\variable.txt</code> is a start-in path. • <code>\\datashare\variable.txt</code>: The input provided in this example is a network path, and the output will be <code>\\datashare\variable.txt</code>. • <code>D:\testing\Automation Anywhere Files\Automation Anywhere\My Docs\mydoc.docx</code>: The input provided in this example is an absolute path, and the output will be <code>D:\testing\Automation Anywhere Files\Automation Anywhere\My Docs\mydoc.docx</code>.
GetBotPath	<p>Modifies the value of the bot path variable in the Enterprise 11 or Enterprise 10 bots and replaces it with the relative bot path according to the Automation 360 repository. The value of the bot path is based on the <code>ApplicationPath</code> of the local path or network path.</p>	<ul style="list-style-type: none"> • <code>D:\testing\Automation Anywhere Files\Automation Anywhere\Bots\My Tasks\test.atmx</code>: The input provided in this example is an absolute path, and in this case, the output path will be <code>My Tasks/test</code>. • <code>\$AAApplicationPath\$\Automation Anywhere Files\Automation Anywhere\Bots\My Tasks\test.atmx</code>: The example provided in this input is related to <code>\$AAApplicationPath\$</code>, and the output will be <code>My Tasks/test</code>. • <code>\\Automation Anywhere Files\Automation Anywhere\Bots\My Tasks\test.atmx</code>: The example provided in this input is a network path, and the output will be <code>My Tasks/test</code>.
GetDecrement	<p>Decrements the value of the respective variable by 1. It is used mostly in the index positions of list, record, array or table variables.</p>	<p><code>\$myArray[\$Loop-Counter-1.LegacyAutomation:getDecrement\$][0]</code></p> <p>The output of <code>myNumber</code> decreases by 1 with each iteration of the loop.</p>

Expression	Description	Use example
GetIncrementedNumber	<p>Increments the value of the respective variable by 1. It is used mostly in the index positions of list, record, array or table variables.</p>	<pre>\$Loop-Counter-1.LegacyAutomation:getIncrementedNumber</pre> <p>The output of myNumber increases by 1 with each iteration of the loop.</p>
GetKeystrokeCount	<p>Calculates the values of keystrokes in a phrase/text</p> <hr/> <p>Note: A special character, such as [TAB], [END], or [PAGE DOWN], is counted as one keystroke.</p>	<pre>\$KeyStroke-CharLength.LegacyAutomation:getKeystrokeCount</pre> <p>The output is the average delay for each keystroke.</p>
GetLegacyIndexValue	<p>Retrieves the value from the specific index position of the list variable in the bots migrated from Enterprise 11 or Enterprise 10. If the index position is greater than the size of the list variable, the system retrieves the value from the first index position of the list in the migrated bots</p>	
ListToString	<p>Converts a list variable to a string variable.</p>	<pre>{{ \$listVar.LegacyAutomation:listToString \$ }}</pre> <p>The output is a string variable with the following value: value1,value2,value3</p>
ListToTable	<p>Converts a list variable to a table variable.</p>	<pre>{{ \$my-list-variable.LegacyAutomation:listToTable \$ }}</pre> <p>The output is a table variable where each list value is cell in a single column.</p>
ParseLegacyKeys	<p>Ensures that the Insert Key Stroke command of the Enterprise 10/Enterprise 11 bots stored in variables is successful upon execution. This expression converts them into equivalent Automation 360 key strokes during the execution.</p> <hr/> <p>Note: The appearance of some special characters differs between Version 11.3 and Automation 360. For example, the Page Up key appears as [PAGE UP] in Version 11.3 and [PAGE-UP] in Automation 360. This difference does not impact bot function.</p>	<pre>\$Test.LegacyAutomation:parseLegacyKeys</pre>

Expression	Description	Use example
ParseVariableOperation	Parses the expression provided in the Enterprise 10/Enterprise 11 Variable Operation command. This expression ensures that Automation 360 returns the same output as Enterprise 10/Enterprise 11 bots upon execution.	<code>\$prompt-assignment.LegacyAutomation:parseVariableOperation</code> \$
TableToString	Converts a table variable to a string variable. You can also use delimiters such as a colon, semicolon, or space to separate the values of the string variable in the output.	<code>{{ \$tableVar.LegacyAutomation:tableToString }}</code> \$}} The output is a string variable with the following value: {value1,value2},{value3,value4} Use a colon, semicolon, or space as <"delimiter">: <code>{{ \$tableVar.LegacyAutomation:tableToString "delimiter" }}</code> For example: <code>{{ \$tableVar.LegacyAutomation:tableToString "value1:value2:value3:value4" }}</code> The output is a string variable with the following value: {value1:value2}:value3:value4}
TableToList	Converts a table variable to a list variable.	<code>{{ \$dataTable.LegacyAutomation:tableToList }}</code> For example: <code>{{ \$dataTable.LegacyAutomation:tableToList "value1,value2,value3" }}</code> The output is a list variable with the following value: [value1,value2,value3]
StringToList	Converts a string type variable to a list type variable	<code>\$sampleString.LegacyAutomation:stringToList</code> \$ The output is a list variable of size 1 with value same as "SampleString"
StringToTable	Converts a string type variable to a data table type variable	<code>\$sampleString.LegacyAutomation:stringToTable</code> \$ The output is a data table variable with size (1*1) and value at index [0,0] same as SampleString

Using legacy Web actions

In Automation 360, all the commands (except Find broken links and Download files) of Web recorder are migrated to their respective actions within the Legacy Automation package. We do not recommend using the Legacy Automation package for new bot development.

Web actions in the Legacy Automation package

The Legacy Automation package includes the following actions:

Action	Description
Close page	Closes the browser session for an opened browser window or tab.
Update window title	<p>Updates the window title during migration of bots, from Internet Explorer to Microsoft Edge with IE mode. On execution of this action, the window title is changed to *Microsoft*Edge format. This action is used only when the window title is determined by a variable and not when the window title is static. The window title is updated when the bot is run and not during the conversion process.</p> <ul style="list-style-type: none"> In the Window field, select an option: Choose the Application, Browser, or Variable tab. <ul style="list-style-type: none"> Application: Select from a list of windows, including browser windows, that are currently open on the Bot Creator device. Browser: Select from a list of supported browser tabs. Variable: Select an existing window variable to specify the title of the application window title. <hr/> <p>Note: Although the property panel contains the Browser and Application options, only the Variable option is used during migration.</p> <hr/> <ul style="list-style-type: none"> Select an option to specify whether the window title is a regular expression or not. When this action is executed, the New window title field displays the changed window title (Microsoft Edge with IE mode).
Execute java script function	<p>Executes JavaScript internally on a web page in Internet Explorer or Microsoft Edge (IE mode).</p> <p>You can run JavaScript inside a web page by providing JavaScript as an action input. When you run a JavaScript function, you can see and edit the properties of the selected iFrame.</p> <ul style="list-style-type: none"> Specify the URL. Specify the function name to run and the arguments to pass to the function. Specify the variable in Assign the output to variable field (optional).

Action	Description
Extract data	<p>Extracts data from a specified URL in Internet Explorer or Microsoft Edge (IE mode).</p> <ul style="list-style-type: none"> • Specify the website URL to extract data from a web page. • Enter the control type and control value. • If you want to reuse an existing tab or window, mark the check boxes and specify the Page Title or Page URL properties to the action. • Specify the time in seconds in Wait for the control to exist. The default time is 30 seconds. • In the Save outcome to a variable field, select either Multiple variables or Dictionary: <ul style="list-style-type: none"> • Multiple variables: Click Add variable mapping to associate each dictionary key with a variable in the parent bot. Use this option if you do not want to use actions to extract the dictionary values. • Dictionary: Insert or create a dictionary variable to hold the output variables and values in key-value pairs.
Extract pattern data	<p>Extracts pattern-based data from an Internet Explorer page. Use pattern-based data extraction when the web entries follow a pattern. This feature recognizes the pattern and extracts the data even if it spans several pages. The extracted data is saved to a CSV file.</p> <ul style="list-style-type: none"> • To extract pattern-based data, enter the website URL and page title. You can preview the extracted captured data and its value. • Specify the location of the CSV file in which you want to write the data. • Select an option to specify what to do when writing data to a file: <ul style="list-style-type: none"> • Append to the file • Override the file • Select an option from the encoding list to specify the encoding that you want to apply on the file. The default encoding is set to ANSI. <ul style="list-style-type: none"> • ANSI • UTF-8 • Unicode
Extract source	<p>Extracts the source of an element on a specified webpage and assigns the value to a variable.</p>

Action	Description
Extract table	<p>Extracts the table from a specified URL and optionally saves to a new CSV file or appends to an existing CSV file.</p> <ul style="list-style-type: none"> Specify the URL to open a web page in an Internet Explorer window. Specify the table number to extract the table data. Specify the location of the CSV file in which you want to write the data. Select the Append to an already existing csv file check box when writing data to an existing file. Select an option from the encoding list to specify the encoding that you want to apply on the file. The default encoding is set to ANSI. <ul style="list-style-type: none"> ANSI UTF-8 Unicode Specify the time in seconds in Wait for the control to exist. The default time is 30 seconds. Enter the session name in the session name field. If you want to reuse an existing tab or window, mark the check boxes and specify the Page Title or Page URL properties to the action. Provide the tag details (Tag name and Attribute name) of the extracted table data and save the result in a CSV file or assign the output to a data table variable.
Go back	Navigates to the previous page.
Manage web controls	<p>Identifies the properties of a UI control from a specified website.</p> <ul style="list-style-type: none"> Select the option to open a new URL or Select page. You can provide the search criteria of the captured object. Search the object by specifying Control name, Value or Index. If you want to reuse an existing tab or window, mark the check boxes and specify the Page Title or Page URL properties to the action. Select the control type from the drop-down menu. Specify the time in seconds in Wait for the control to exist. The default time is 30 seconds. Choose a variable to assign an output to a variable.
Navigate to page	<p>Opens a web page in an existing Internet Explorer window.</p> <ul style="list-style-type: none"> Specify the URL in the Navigate URL field to open a new window with a specified URL. If you want to overwrite an existing tab or window, mark the check boxes and specify the Page Title or Page URL properties to the action.
Open page	<p>Opens a web page in Internet Explorer to a specified URL.</p> <ul style="list-style-type: none"> Specify the URL to open a web page in an Internet Explorer window. If you want to reuse an existing tab or window, mark the check boxes and specify the Page Title or Page URL properties to the action.

Action	Description
Search by caption	Searches the first opened Internet Explorer window for the specified caption and occurrence frequency. You can update the Caption and Occurrence in the bot.
Configure settings	<p>Set the configuration option for the web actions. You can select one of the following options or all:</p> <p>When you configure this action with the following settings, the settings configured will apply to all the actions under the Web group.</p> <ul style="list-style-type: none"> • Launch Internet Explorer as a process. • Open a browser in the background. • Launch Internet Explorer in Edge compatibility mode. <hr/> <p>Note: When you select the Launch Internet Explorer in Edge compatibility mode check box, all the automation you previously built on Internet Explorer 11 using Web actions will run and work in Microsoft Edge with IE mode. The actions within the Web group run seamlessly in Microsoft Edge with IE mode.</p> <hr/>

List package

The **List** package contains actions that enable you to perform various operations on a variable of the list data type.

Working with variables of list data type

A list is a collection of ordered values. The values can be of Boolean, number, or string data subtype. When initializing a list variable, you can select the **Any** data subtype in order to hold any of the three data subtypes. You can manually enter values by creating a new variable or selecting an existing one from the **Variables** menu, and then clicking **Add**.

Common uses of list variables include:

- Sending an email to multiple recipients.
- Searching multiple web addresses.

Actions in the List package

If you are using a **List** action in a **Loop** action, you must use the **For each item in the list** iterator.

The following actions are available in the **List** package:

Action	Description
Add item	<p>Inserts an item into a list variable. You can choose to add the item at the end of the list or specify a position in the list.</p> <ul style="list-style-type: none"> • Select the list variable in which to add an item from the List variable list. • Select the variable that contains the value to add from the Item to be added list. <hr/> <p>Note: The variable must be of the same sub-data type as the other list items.</p> <hr/> <ul style="list-style-type: none"> • Select the To end of list option to insert the item at the end of the list or select At list index to specify the index in the list where to insert the item. <p>The list index starts from 0. The first item in the list is at position 0, the second item at 1, and so on. For example, to add an item at the fourth position in a list, enter 3 in the At list index field.</p>
Append	<p>Adds a list variable into the column index of a data table. You can choose to add the list variable at the start or end, or specify a position in the data table.</p> <ul style="list-style-type: none"> • Select the list variable that contains the value to be added. • In the Assign the outcome to Data Table field, select a table variable that you want to use to store the output. • Choose from the following options to insert a column at index: <ul style="list-style-type: none"> • First index: Sets the value to the first position (0 index) in a data table. • Last index: Sets the value at the end of the data table. • Specific index: Specify the index where you want to enter the column index. For example, to set a value to the first column, enter 0. <p>The index number starts from 0. The first item in the data table is at position 0, the second item at 1, and so on. For example, to add an item at the third position in a data table, enter 2 in the Specific index field.</p>
Assign	<p>Assigns the value of the source list to the destination list variable.</p> <ul style="list-style-type: none"> • Select the source list variable from the drop-down list or create a new list variable. • Select a list variable or create one to hold the output.
Clear	<p>Clears all items from the selected list variable.</p>

Action	Description
Get item	<p>Retrieves a value at the specified position in a list and stores the output to a variable.</p> <ul style="list-style-type: none"> • Select the list variable from which you want to retrieve a value from the List variable list. • Specify the position in the list from where you want to retrieve the value in the Index number field. The list index starts from 0. The first item in the list is at position 0, the second item at 1, and so on. • Select a variable that you want to use to store the output from the Assign the output to variable list.
Join items	<p>Combines all the available values in a list variable and stores the output to a string variable. You can specify the delimiter you want to use as a separator in the output.</p> <ul style="list-style-type: none"> • Select the list variable that you want to use from the List variable list. • Specify the delimiter you want to use to separate values in the output in the Delimiter field. • Select a variable that you want to use to store the output from the Assign the output to variable list.
Remove item	<p>Removes an item from a list and assigns the output to a variable.</p> <ul style="list-style-type: none"> • Select the list variable from which you want to remove an item from the List variable list. • Specify the position in the list from where you want to remove the value in the Index number field. The list index starts from 0. The first item in the list is at position 0, the second item at 1, and so on. • Select a variable that you want to use to store the output from the Assign the output to variable list.
Set item	<p>Sets an item at the specific position in a list and stores the output in a variable.</p> <ul style="list-style-type: none"> • Select the list variable in which you want to set a value from the List variable list. • Specify the position in the list where you want to set the item in the Index number field. The list index starts from 0. The first item in the list is at position 0, the second item at 1, and so on. • Select a variable that you want to use to store the output from the Assign the output to variable list.
Size	<p>Retrieves the number of items in a list and assigns the output to a number variable.</p> <ul style="list-style-type: none"> • Select the list variable for which you want to retrieve the size from the List variable list. • Select a number variable that you want to use to store the output from the Assigns the number of items to variable list.

Example

Create a bot to add items to a list and retrieve data from a list. To achieve this functionality, perform the following steps:

1. Create a bot.
 - a. On the left panel, click **Automation**.
A list of available bots and forms is displayed.
 - b. Click **Create a bot**.
 - c. Enter the bot name: `ListBot`
 - d. Click **Create and Edit**.

2. Create the following variables.
 - Variable: *StringList*
 - **Type:** List
 - **Subtype:** String
 - **Name:** `StringList`
 - **Default value at 0:** `Automation`
 - **Default value at 1:** `Anywhere`
 - Variable: *SampleString*
 - **Name:** `SampleString`
 - **Default value:** `PvtLtd`
 - Variable: *ListOutput*
 - **Type:** Any
 - **Name :** `ListOutput`

3. To insert an item into a list variable, from the Actions pane, double-click or drag the **List > Add item** action.
 - a. In the **List variable** field, select `StringList`.
 - b. In the **Items to be added** field, select `SampleString`.
 - c. To insert the item at the end of the list, select the **To end of list** option.

4. To retrieve a value at a specified position in a list, from the Actions pane, double-click or drag the **List > Get item** action.
 - a. In the **List variable** field, select `StringList`.
 - b. In the **Index number** field, enter 0. This is to specify the position in the list from where you want to retrieve a value.
 - c. To store the output from **Assign the output to variable list**, select `ListOutput`.

5. To print the value of the Index 0, double-click or drag the **Message box** action. Click **Save** and **Run**.
The bot displays the zero index data of the list variable, which is **Automation**.

Related reference[Loop package](#)

Use the Loop package to run a sequence of actions repeatedly for a specific number of times or until a specific condition is met.

[Variables overview](#)

Automation 360 offers a variety of variables, each designed to hold specific types of data and is intended for specific use. Use the topics below to learn more about each variable and how to use them.

Log To File package

Use the **Log To File** package to create a log file with data.

The **Log To File** package enables the following:

- Verify that a bot ran properly.
- Create a new log file.
- Specify custom text to be included in the log file.
- Add a time stamp to the log file.
- Use a log file as a variable.

Note: The package supports ANSI, Unicode, and UTF8. It can save files as .csv and .txt.

Actions in the Log To File package

The **Log To File** package includes the following action:

Action	Description
Log to file	See Using Log To File action .

Using Log To File action

Using the Log To File action, you can create a log file with data about the events that occur when a TaskBot runs.

Follow these steps to log text into a file:

1. In the **Actions** palette, double-click or drag the **Log To File** action from the **Log To File** package.
2. In the **File path** field, specify the file location or variable.
3. In the **Enter text to log** field, enter the text to log in the file.
4. Select the **Append timestamp** check box to add a time stamp.
5. In the **When logging** field, choose **Append to existing file** to append the log file or **Overwrite existing log file** to overwrite the content in the log file.

6. Select the **Encoding** type.

- **ANSI:** Used to encode Latin alphabet.
- **UNICODE**
- **UTF8:** Can encode all possible characters.
- **UTF-16LE:** Inserts a byte order mark (BOM) Unicode character at the beginning of the file.

Note: Shift-JIS files must use **ANSI** as encoding to read text file content.

If you selected the **Append to existing file** option in Step 5, ensure that the selected encoding type matches that of the original file, otherwise some of the characters might not be logged.

7. Click **Save**.

Loop package

Use the Loop package to run a sequence of actions repeatedly for a specific number of times or until a specific condition is met.

The Loop package enables you to repeatedly run specific actions within a bot. For example, repeat the set of actions that read data from each row of a Microsoft Excel file, rename all files in a folder, and save each email in a mailbox. You can also use the **If** action within the Loop action to validate a condition, and based on the outcome of it, skip the current iteration in the loop or even break the loop.

For conditional loops, different actions are taken depending on whether the conditional parameters are met. For loops that have a specified number of iterations, the loop exits on the last iteration and goes to the next step in the bot.

When you run a sequence of actions repeatedly for a specific number of times within a loop, the end condition within the loop is evaluated in every iteration.

For example, when you loop through a Data Table that has 10 columns, enter dynamic values of column count for the end condition in the loop, use the **Data Table > Delete column** action to delete the column of index 0 inside the loop body, and then run the bot, the bot deletes a column in every iteration. Hence it reduces the iteration count because the loop end condition is evaluated in each iteration.

Actions in the Loop package

The following Loop actions are available:

Action	Description
Loop	See Using Loop action .
Continue	See Continue action . See If package .
Break	See Break action . See If package .

Iterator-related conditions within the Loop action

Select the **Iterator** option to specify the number of times the set of actions will be repeated as part of the Loop action:

Iterator	Description
For each row in CSV/ TXT	Repeats the set of actions for each row in the specified CSV or text file and assigns the values in the current row to a record variable. See Using the For each row in CSV/TXT iterator .
For each row in Data Table	Repeats the set of actions for each row in the specified table and assigns the values in the current row to a record variable. See Using the For each row in table iterator .
For each row in a SQL query dataset	Repeats the set of actions for each row in the specified SQL query dataset and assigns the values in the current row to a record variable. Provide the session name that you have used to establish a connection with the database.
For each key in the Dictionary	<p>Repeats the set of actions for each key in the specified Dictionary variable and assigns the name of the current key to a variable.</p> <hr/> <p>Note: When a bot runs a Loop action that contains a Dictionary > Put action, the bot only iterates on the original number of items in a dictionary; it ignores items inserted using the Put action.</p> <hr/>
For each value in the Dictionary	<p>Repeats the set of actions for each value in the specified Dictionary variable and assigns the current value to a variable. Because this variable type can hold various subtypes (String, Number, Boolean, and so on), if you quick-create a variable when configuring the action, the variable is of Any type.</p> <hr/> <p>Note: When a bot runs a Loop action that contains a Dictionary > Put action, the bot only iterates on the original number of items in a dictionary; it ignores items inserted using the Put action.</p> <hr/>
For each mail in mailbox	Repeats the set of actions for each email in the specified mailbox. See Using the For each mail in mail box iterator .

Iterator	Description
For each row in worksheet (Excel basic or Excel advanced)	<p>Repeats the set of actions for each row that contains data in a worksheet and assigns the values in the current row to a record variable. Provide the session name that you have used to open the Excel basic or Excel advanced worksheet. Specify whether to repeat the actions for all the rows, specified rows, or a specified cell range. Select a record variable from the Assign the current row to this variable list or create a new one. See Record variable.</p> <p>This iterator retrieves cell values as string data types. It supports Excel cell formats, including Number, Percentage, Currency, Scientific, and Date. For example, a value from a cell of Currency formatting retains the currency symbol when passed to a table or record variable.</p> <ul style="list-style-type: none"> You must convert the values to perform non-string operations. In Excel advanced, when you choose loop iterator as For each row in worksheet, you have a Read option to read either the visible text or value of the cell. <p>For example, if the cell has 70% as cell content, Read cell value option will read the value as 70 ignoring the % format whereas Read visible text option will read the content as 70%.</p> <hr/> <p>Recommendation: Use the Read cell value option as reading value from a cell for better performance than reading visible text.</p> <hr/> <p>Use of Global session option to share an Microsoft Excel session using the Excel advanced package is not available with this option.</p> <p>Alternate solution: Use the Get multiple cells action and save the data into a datatable variable and then, use the Loop package with the Data Table option selected.</p>
For each file in folder	<p>Repeats the set of actions for each file in the specified folder and assigns the properties of the current file to a Dictionary variable containing two keys: the <code>name</code> key holds the file name and the <code>extension</code> key holds the file extension.</p> <p>To open files with different extensions, use the variable option to assign the folder path, file name, and file extension . First, create a variable for the folder path, <code>\$\$Folder\$</code>. Then, for the files in the folder path, create two variables, one for file name <code>\$name\$</code> and another for file extension <code>\$extension\$</code>. To open a file, combine the variables as a string, such as <code>\$\$Folder\$\\$name\$.\$extension\$</code>. For the extension to work with different file types and different open options, you can add conditional logic.</p>
For each folder in folder	Repeats the set of actions for each folder in the specified folder and assigns the current folder name to a String variable.

Iterator	Description
For each item in the list	Repeats the set of actions for each item in the specified list and assigns the current item to a variable. Specify whether to repeat the action for all items in the list or only for the range of items in the list. Because this variable type can hold various subtypes (String, Number, Boolean, and so on), if you quick-create a variable when configuring the action, the variable is of Any type. Note: The index in a list starts from zero. For example, to repeat the action for items from the third position to the sixth position of the list, specify 2 and 5 in the appropriate fields.
For n times	Repeats the actions in the container the specified number of times. You can assign the iteration count to a Number variable.
For each value in record	Repeats the actions for each value in the specified record and assigns the current value to a variable. Because this variable type can hold various subtypes (String, Number, Boolean, and so on), if you quick-create a variable when configuring the action, the variable is of Any type..
For each meeting in calendar	Use this option to repeat the set of actions for each meeting in the specified calendar. See Using Office 365 Calendar actions in a loop .
For each row in worksheet (Office 365 Excel)	Repeats the set of actions for each row that contains data in a worksheet. <ul style="list-style-type: none"> • Provide the session name that you have used to open the worksheet. • Specify whether to repeat the actions for all the rows or specific rows. • You can assign the values in the current row to a record variable.
For each node in a XML dataset	Repeats the set of actions for each node in an XML dataset and assigns the current node to String variable. Provide the session name that you have used to open the XML file.

While related conditions in the Loop action

You can configure multiple while related conditions within a single Loop action:

1. Click **Add condition**.
2. Select either of the following options:
 - **And:** Both of the conditions must be met for the actions to run.
 - **Or:** Either of the conditions must be met for the actions to run.
3. Select the conditions from the drop-down list.

Select the **While** option to use the following conditions:

While	Description
Application	<p>Use the Application is running or Application is not running condition to run actions based on whether an application is running or not running.</p> <p>Enter the application path or specify the path using a variable along with the amount of time to wait (in seconds) for the condition to be true.</p> <hr/> <p>Note: The Application is running and Application is not running conditions are not applicable for Internet Explorer bots because its corresponding process <code>iexplore.exe</code> runs in the background when Microsoft Edge is launched in IE mode.</p> <hr/>
Boolean	<p>Use this condition to execute actions based on the value of a Boolean variable. Use this condition to compare the values of two Boolean variables or one Boolean variable to a selected Boolean value.</p>
Data table	<p>Use the Data table is empty condition to execute actions based on whether the specified table contains values.</p> <p>Use the Number of rows and Number of columns conditions to execute actions based on whether the number of columns or rows is Equal to, Greater than, or Less than the specified value.</p>
Datetime	<p>Use the Datetime variable condition to execute actions based on whether the value of the source datetime variable is Equal to or Not Equal to, is Greater than or Equal to, or is Lesser than or Equal to the value of the target datetime variable.</p>
Dictionary	<p>Use this condition to repeat the set of actions based on whether the selected dictionary variable contains the specified key.</p> <hr/> <p>Note: The key comparison is case-sensitive.</p> <hr/>

While	Description
File	<p>Use the following conditions to execute the action:</p> <ul style="list-style-type: none"> • File date Use this condition to verify the date and time when a file was created or modified. Specify a date or date range using the On a date, Is within last, Is between, or Is before options. For the On a date option, specify a date to verify whether the file was created or modified on that date. For the Is within last option, specify the number of days or time (in hours, minutes, and seconds). Enter the amount of time (in seconds) to wait for this condition to be true. • File exists and File does not exist Use these conditions to execute an action based on whether a file exists. For example, if a data file exists, format the file and upload it to a database. • File extension Use this condition to check the file extension of a selected file and then execute actions based on the results. Use the File path field to select a file. • File size This condition verifies if the specified file is larger, smaller, not the same, or the same as the size you specify. Enter the amount of time (in seconds) to wait for this condition to be true.
Folder does or does not exist	Use these conditions to repeat the set of actions based on whether a folder exists.
Image Recognition	<p>Use these conditions to verify whether:</p> <ul style="list-style-type: none"> • Image file is found in the Image file or not. • Image file is found in the Window or not. • Window is found in the Image file or not. • Window is found in the Window or not. <p>For the Window conditions, you can use the Resize window option to specify the window dimensions. This option delivers a more reliable bot. It resizes the window to the dimensions at which the task was recorded, which enhances the bot's ability to identify the target object.</p> <hr/> <p>Note: This option is only available for windows that can be resized. It is not available for Desktop or Taskbar options.</p> <hr/> <p>For the Window conditions, you can use the Preview option to select a specific captured occurrence and position your click location relative to the image.</p>
JavaScript	Use the Script is successful or Script is unsuccessful condition to execute actions based the status of the specified JavaScript. Select the file that contains the script and optionally specify the parameters by selecting a list variable.

While	Description
Legacy automation	<p>The Legacy automation conditions are only used in migrated bots to ensure that they run seamlessly in Automation 360. We do not recommend using these conditions for new bot development. The following conditions to verify the following:</p> <ul style="list-style-type: none"> • Whether Web control exists or not. • Whether Window control exists or not. • Whether Window control is active or not. • Whether Script is successful or not. • Whether Child window exists or not. <p>For the Window control conditions, you can use the Resize window option to specify the window dimensions. This option delivers a more reliable bot. It resizes the window to the dimensions at which the task was recorded, which enhances the bot's ability to identify the target object.</p>
List	Use the List variable condition to execute actions based on whether the specified list variable contains a particular value. The value can be of Number , String , or Boolean data type.
Number	Use the Number variable condition to execute actions based on whether the specified number variable is Equal to or Not Equal to , or is Greater than or Equal to , or is Lesser than or Equal to a particular value.
Ping	Use the Ping is successful or Ping is unsuccessful condition to verify if a machine or server is running, and execute actions based on the result. Enter the amount of time (in seconds) to wait for the condition to be true.
Recorder	<ul style="list-style-type: none"> • Use the Object exists condition to detect an object in a window. Select a window or variable to capture the object. Enter the amount of time (in seconds) to wait for this condition to be true, that is, for the object to be detected. • Use the Object does not exist condition to verify whether a specific object exists in a window, and then based on the result, execute actions. Enter the amount of time (in seconds) to wait for this condition to be true. For example, you can use the Object does not exist condition inside the Loop > While condition to make sure that the bot does not execute the next action until the object on the business application is loaded. <hr/> <p>Note: The Object exists and Object does not exist Recorder conditions support Chromium-based Microsoft Edge with Internet Explorer mode.</p> <hr/>
Service	Use the Service is running or Service is not running condition to execute actions based on whether a service is running or not. Select Service list to choose a service from the list of available services.

While	Description
String	<p>Use the String variable condition to execute actions based on whether the specified source string value is Equal to or Not equal to, or Includes or Does not include the target value.</p> <p>You can select the Match case option to only execute actions if the two strings have matching uppercase and lowercase letters.</p> <p>When you extract text from a Microsoft application, the extracted text contains the <code>/r/n</code> special characters which indicate a new line. Select the Ignore Carriage return option if you want to ignore the <code>/r</code> special character when you compare the text.</p> <p>To create a condition based on whether a string is empty or not empty, compare the source value to an empty target field using the Equal to operator.</p> <p>See Example of using a conditional statement.</p>
Task Bot	Use the Task successful or Task unsuccessful condition to execute actions based on the status of the specified Task Bot.
VBScript	Use the Script is successful or Script is unsuccessful condition to execute actions based on the status of the specified Visual Basic script. Select the file that contains the script and optionally specify the parameters by selecting a variable.
Window	<p>Use the Window exists or Window does not exist condition to verify if a specific application window is open by entering the Window title or using a variable. Enter the amount of time (in seconds) to wait for the condition to be true. These conditions are used when the window title remains constant and to verify if the specific window is open and execute further actions based on the output.</p> <p>Use the Window with same title does not exist or Window with same title exist condition to verify whether a window with the same title exists or whether the window title has changed. Enter the amount of time (in seconds) to keep verifying if the condition is true. These conditions are used for window titles that are dynamic. For example, when you open a Google account webpage, enter your username and password to log into your account, the window title changes. If you want to compose a new email as a next action, you can use these conditions before you execute the next action to verify if the window with the same title exists or if the title has changed.</p>

Related tasks

[Example of transferring data from CSV file to Excel worksheet](#)

In this example, you build a bot to update the product inventory in an Excel worksheet with new product names from a CSV file. Use actions from the CSV/TXT, Excel advanced, IF/ELSE, and Loop packages.

[Example of entering data into a web form from a worksheet](#)

In this example, you build a bot to enter multiple rows of data from an XLSX sheet into a web form. Use actions from the Excel advanced, Loop, and Recorder packages.

Related reference

[Record variable](#)

A record variable holds a row of data extracted from a database, spreadsheet, or table in name-field pairs. The fields can store values of Boolean, datetime, number, or string data type.

Related information

[Using loops to control a bot](#)

Continue action

The Continue action in the Loop package enables you to continue the loop in your operation.

Settings

Use the **Continue** action along with the **If** action to skip the current iteration and continue with the next iteration in the loop based on the condition you have specified in the **If** action.

Break action

The Break action in the Loop package enables you to terminate the loop in your operation.

Settings

Use the **Break** action along with the **If** action to terminate the loop based on the condition you have specified in the **If** action. When you terminate the loop, the actions immediately following the **Loop** action run.

Using Loop action

Use the Loop action to repeatedly run a sequence of actions for a specific number of times or until a condition is met.

To repeatedly run a sequence of actions, do the following:

1. Double-click or drag the **Loop** action from the **Actions** palette.
2. Set the desired conditions for the loop.

Option	Action
Select the Iterator option to repeat the sequence of actions for a specific number of times.	Select an option from the Iterator list to specify how many times the sequence of actions is to be repeated. See Loop package for the list of available options.
Select the While option to repeat the sequence of actions until a condition is met.	<ol style="list-style-type: none"> a. Select an option from the Condition list to specify the condition. b. Select the Check the condition at the end of the iteration to validate the condition at the end of each iteration. This option enables you to ensure that the set of actions run at least one time, even if the condition is not met.

3. Double-click or drag the actions to be repeated within the **Loop**.
4. Optional: Double-click or drag the **Continue** action from the **Loop** package to skip the current iteration and continue with the next iteration of the loop.

5. Click **Save**.

Using the For each row in CSV/TXT iterator

Use the **For each row in CSV/TXT** iterator in the Loop action to read the data of each row in a CSV or text file and assign the current row to a record variable. The bot reads the values in each cell as string-type values, even if there are numerical values.

First, open the CSV or text file. [Using the Open action for CSV/TXT file](#)

Note: The **For each row in CSV/TXT** iterator only supports CSV/TXT files that conform to the RFC 4180 standard. For more information about the standard, see [Common format and MIME type for CSV files](#).

To use the **For each row in CSV/TXT** iterator in a **Loop** action, do the following:

1. Double-click or drag the **Loop** action from the **Loop** package in the **Actions** palette.
2. Select the **For each row in CSV/TXT** option from the **Iterator** list.
3. Enter the name of the session that you have used to open the CSV or text file in the **Open** action.
4. Select a record variable from the **Assign the current row to this variable** list or create a new one.

Note: If you select an existing record variable, ensure that the column headers capitalization in the CSV or text file match that of the schema of the record variable. [Schema](#)

Insert actions to use the values from the CSV or text file in your automation. Use the record variable to retrieve the values by index number or column name. For example, if the first column of the file is titled EmployeeID, to retrieve the value of the first cell of each row enter ``${rYourVariableName}[0]`` or ``${rYourVariableName}{EmployeeID}``.

Note: You must select the **Contains header** option in the **CSV/TXT > Open** action to specify the record values by column name.

For an example, see [Build a Bot Insight dashboard bot](#).

Using the For each row in table iterator

Use the **For each row in table** iterator in the Loop action to read the data of each row in a table variable and assign the current row to a record variable.

First, retrieve the table values and store them to a table variable.

Example: [Example of extracting data from a web table](#)

To use the **For each row in table** iterator in a **Loop** action, do the following:

1. Double-click or drag the **Loop** action from the **Loop** package in the **Actions** palette.
2. Select the **For each row in table** option from the **Iterator** list.
3. Select the variable that holds the values from the **Table variable** list.
4. Select a record variable from the **Assign the current row to this variable** list or create a new one.
5. Click **Save**.

Insert actions to use the values from the data table in your automation. Use the record variable to retrieve the values by index number or column name. For example, if the first column of the file is titled EmployeeID, to retrieve the value of the first cell of each row enter ``${rYourVariableName}[0]`` or ``${rYourVariableName}{EmployeeID}``.

Message box package

Use the **Message box** action from the **Message box** package to insert a message box that shows a message when the task runs. For example, you can insert a **Message Box** action to follow a web form so that the action displays the message: `Web Form Filled and Complete`.

For more information, see [Using the Message box action](#).

Use the following examples to learn how to use the **Message box** action when building automations.

- [Build a Go be Great bot](#)
Build a basic TaskBot using a Message Box action and a variable.
- [Build a basic bot that uses a desktop application](#)
An example of how to build a basic TaskBot that uses the calculator application.

Using the Message box action

Use the **Message box** action to insert a message box that shows a message when the task runs.

1. Double-click or drag the **Message box** action from the **Message box** package in the Actions palette.
2. Enter a window title for the message box.
3. Enter the message to display.

This field holds up to 65535 alphanumeric, character, and empty values.

Note: To provide a string that includes a dollar sign (\$), you must enter two dollar signs. For example, if you enter `Pay $$5.00`, the output will be `Pay $5.00`.

4. Specify the number of lines at which to show a scroll bar.
5. Optional: Select the **Close message box after** option and specify the number of seconds after which the message box closes automatically.

Important: Select this check box if the bot will run on an unattended machine.

6. Click **Save**.

Microsoft LUIS NLP package

The **Microsoft LUIS NLP** package contains actions that enable you to connect to and consume the Microsoft Cognitive Services Text Analytics API to identify the language, sentiment, key phrases, and entities. This package supports the following languages: English, Chinese (Simplified), French, German, and Spanish.

Important: This is a beta package and is currently not available with the Automation 360 Enterprise and Cloud editions.

Before you start

You must have an Azure Cognitive Services resource to use these actions. See [Create a Cognitive Services resource using the Azure portal](#).

You also require the following in order to use the actions:

- **Service Endpoint URL:** the endpoint URL that identifies the Azure service.
- **Subscription Key:** the unique key that authenticates Automation Anywhere Enterprise.

Actions in the Microsoft LUIS NLP package

Action	Description
Detect language	Identifies the language of the provided content and returns it in ISO 639-1 language code. The output is stored in a string variable.
Get key phrases	Identifies the main points and returns a list of key phrases. For example, if the input text is about a basketball game, this action returns the names of teams, the name of the venue, and the final score.
Get named entities	Identifies the entities in the provided content such as people, places, organizations, date/time, quantities, branded products, and book titles. The output is stored in a dictionary variable, where each name is a key, and the corresponding entity is the value.
Get sentiment	Analyzes the provided content and returns a sentiment and score. <ul style="list-style-type: none"> • If the score is greater than 0.6, the sentiment is Positive. • If the score is in the 0.2 through 0.6 range, the sentiment is Neutral. • If the score is less than 0.2, the sentiment is Negative. The output is stored in a dictionary variable containing two keys and their corresponding values: <code>sentiment</code> and <code>score</code> .

Mouse package

Use the **Mouse** package to simulate mouse actions.

Actions in the Mouse package

The **Mouse** package includes the following actions:

Action	Description
Click	See Using the Click action .
Move	See Using the Move action .
Scroll	See Using the Scroll action .

Secure recording

When secure recording mode is enabled, bots do not display the target object images after capture. This ensures that sensitive data is not shown.

Note: Although the bots do not display the target images after capture, the images are still stored in the Control Room because they are required to run the bots.

When you record a task in secure recording mode, the **Preview** window temporarily shows an image of the captured area. This image is hidden after you navigate away from the Bot editor window or refresh it.

A user with admin privileges must enable this setting. See [Settings](#).

Related reference

[Screen resolution dependent packages](#)

The screen resolution between the Bot Runner and Bot Creator device should be consistent as when resolution-dependent packages are used to build bots, any screen resolution difference between the Bot Creator and Bot Runner device will impact the bots during runtime.

Using the Click action

Use the **Click** action to enable a bot to simulate mouse clicks. This action enables to capture the UI element such as the screen or window, and to specify the click event and click button.

Ensure that the screen scale and resolution of the Bot Creator device is the same as the Bot Runner device. If the screen scale and resolution are different, the bot might fail when deployed to the Bot Runner device.

If you are using Internet Explorer, the bot waits until the browser is completely rendered and is in a ready state before executing the **Click** action.

Follow these steps to add a **Click** action:

1. In the **Actions** palette, double-click or drag the **Click** action from the **Mouse** package.
2. Specify the window in which to capture the mouse click:

Choose from the **Application**, **Browser**, or **Variable** tab.

Option	Description
Application	Select from a list of currently active windows. Note: You can use the Screen option to capture coordinates on the device screen, however we recommend specifying a window because screen sizes can change, which distorts the captured coordinates.
Browser	Select from a list of supported browser tabs. Note: This option supports , Chromium-based , and browsers.
Variable	Select an existing window variable to specify the title of the application window title. Note: This option deactivates the Capture option. Use this option only after you have completed the capture step.

Insert a wildcard character (*) in the **Window title** field to search for window titles that can change. You can specify one or more wildcards (*) at the start, middle, or end of the value. For example, to perform an operation on any window that has `Microsoft` in the title, use a wildcard to indicate any string by adding it before or after the value: `*Microsoft*`. The first searches for the exact window

title (Microsoft), and if it does not find a match, it searches for windows with the term Microsoft anywhere in the title.

You can use a regular expression (regex) to identify a window title. Select the regular expression condition as either **String** or a **Pattern** and then enter the value. By default, the **Window title** field is case-sensitive.

To identify a browser title, you can enable the **Case sensitive** option to match the letter case, or disable the option to identify a window title where the letter case does not match.

Note: Ensure that the minimum version installed on your system is the version that was released with v.26. If you have a version released with v.25 or earlier, then by default, the window title will be identified only with matching letter case (case-sensitive).

For example, you can enter the **String** value as `((\w*)-Notepad` for all window title names starting with `((\w*)-Notepad`, or use **Pattern** value as `((\w)\s)*document-Notepad` for only those window titles that match this pattern.

Note:

- When you use a regular expression of type **String** with `-title` as the input value for a window title in any , the might encounter a run time error. To prevent the run time error, ensure that when you add the string input as `*-title`, the application with the specific title is open. The asterisk (*) is just a character, not a wild card character.
- When you use a regular expression of type **Pattern** with `-title` as the input value for a window title in any , the might encounter a run time error because the input value `*-title` is incorrect.

Ensure that you use valid regex patterns.

3. Optional: Select the **Resize window** option to specify the window dimensions.

This option delivers a more reliable bot. It resizes the window to the dimensions at which the task was recorded, which enhances the ability of the bot to identify the target object.

- If the window is maximized when you record the task, this option is not selected.
 - If the window is not at the maximum size when you record the task, this option is selected, by default, and the width and height fields are automatically filled with the dimensions of the window.
-

Note: This option is available only for windows that can be resized. It is not available for the **Desktop** or **Taskbar** options.

4. Click **Capture coordinate.**

The selected window appears.

5. Drag the mouse to select the click spot and left-click to capture it.

The captured spot appears in the **Preview** section with the coordinates underneath.

6. In the **Button option, specify the button to click.**

Choose from **Left Button**, **Right Button**, or **Middle Button**.

7. In the **Event option, specify the event.**

Choose from **Click**, **Double click**, **Button up**, or **Button down**.

8. Click **Save.**

Using the Move action

Use the **Move** action to simulate moving the mouse pointer from one location to another.

Follow these steps to add a **Move** action:

1. In the **Actions** palette, double-click or drag the **Move** action from the **Mouse** package.
2. In the **Mouse from** and **Mouse to** fields, specify the **X** and **Y** coordinates.
3. Click **Capture coordinate** to capture the starting point location.
4. Click **Capture coordinate** to capture the end point location.
5. **Optional:** In the **Delay in milliseconds** field, specify the total duration of the movement in milliseconds.
6. Click **Save**.

Using the Scroll action

Use the **Scroll** action to simulate scrolling the mouse wheel up or down.

Follow these steps to add a **Scroll** action:

1. In the **Actions** palette, double-click or drag the **Scroll** action from the **Mouse** package.
2. In the **Select scroll option**, select the **Up** or **Down** option.
3. In the **Number of iterations** field, specify the number of times to scroll.
4. **Optional:** In the **Delay in milliseconds** field, specify the total duration of the scrolling in milliseconds.
5. Click **Save**.

Number package

The Number package contains actions that enable you to perform various operations on a number variable. A number variable holds numeric values, including integers and decimals. It holds values from -9,223,372,036,854,775,808 to 9,223,372,036,854,775,807, and up to 15 decimal digits.

Actions in the Number package

The actions in the Number package accept a variable as an input and assign the output to a variable. These actions enable you to assign a value to a Number variable, decrement or increment a number, or convert a Number variable to a String variable.

You can use large numbers in number variables or in actions to perform mathematical operations. In the bot editor, use the actions menu (vertical ellipsis at the top-right) to select the **Advanced settings > Enable improved number support**.

Note: Ensure you update to the latest version of the package to use this feature.

The Number package includes the following actions:

Action	Description
Assign	<p>Assigns a specified number or result of an expression to a user-defined Number variable. You can use expressions built using the +, -, *, and / operators and use parentheses to group expressions. For example, (3*4)+5 or (\$Variable2*\$Variable3)/\$Variable1.</p> <ul style="list-style-type: none"> • Enter a number or select a predefined Number variable. • Select a predefined number variable or create a new one to hold the output.
Decrement	<p>Decrements (decreases by set intervals) a number by a user-specified value.</p> <ul style="list-style-type: none"> • Enter a number or select a predefined Number variable. • Enter the decrement value or select a predefined Number variable. • Select a predefined number variable or create a new one to hold the output.
Increment	<p>Increments (increases by set intervals) a number by a user-specified value.</p> <ul style="list-style-type: none"> • Enter a number or select a predefined Number variable. • Enter the increment value, the value must be greater than zero or select a predefined Number variable. • Select a predefined number variable or create a new one to hold the output.

Action	Description
Random	<p>Generates a random integer from a user-specified range and assigns it to a number variable.</p> <ul style="list-style-type: none"> In the Beginning of range field, enter a number or select a predefined number variable. <hr/> <p>Note: This field accepts values in the range of -9,223,372,036,854,775,808 through 9,223,372,036,854,775,807, and up to 15 decimal digits.</p> <hr/> <ul style="list-style-type: none"> In the End of range field, enter a number or select a predefined number variable that is greater than the value in the Beginning of range field. <hr/> <p>Note: This field accepts values in the range of -9,223,372,036,854,775,808 through 9,223,372,036,854,775,807, and up to 15 decimal digits.</p> <hr/> <ul style="list-style-type: none"> Enter the number of digits after the decimal by selecting the Specify number of decimals check box. Select a predefined number variable or create a new one to hold the output.
To string	<p>Converts a user-specified number to a string.</p> <ul style="list-style-type: none"> Enter a number or select a predefined Number variable. Enter the amount of digits after the decimal. <p>To remove all the digits after the decimal, leave the default value of 0.</p> <ul style="list-style-type: none"> Assign the output to a String variable. You can use <i>prompt-assignment</i> during building and testing of the bot. <hr/> <p>Important: Ensure that you reassign the values from <i>prompt-assignment</i> to a user-created variable before deploying the bot into production.</p> <hr/>

OCR package

The **OCR** package contains actions that enable you to extract text from images or applications.

The **OCR** package enables you to:

- Extract text from a window or a specific area of an application.
- Extract text from images or files stored on a local machine, a website, or the Control Room folder.

- Filter extracted text and store it as a variable.

Note: You can extract text from images in .jpeg, .jpg, .bmp, .gif, and .png formats.

ABBYY FineReader 12.2.27.12 is installed along with A2019 and does not require any additional setup.

Actions in the OCR package

The **OCR** package includes the following actions:

Action	Description
Capture image by path	See Using Capture image by path action .
Capture image by url	See Using Capture image by URL action .
Capture window	See Using Capture window action from OCR package .
Capture area	See Using Capture area action from OCR package .

Secure recording

When secure recording mode is enabled, bots do not display the target object images after capture. This ensures that sensitive data is not shown.

Note: Although the bots do not display the target images after capture, the images are still stored in the Control Room because they are required to run the bots.

When you record a task in secure recording mode, the **Preview** window temporarily shows an image of the captured area. This image is hidden after you navigate away from the Bot editor window or refresh it.

A user with admin privileges must enable this setting. See [Settings](#).

Related reference

[Screen resolution dependent packages](#)

The screen resolution between the Bot Runner and Bot Creator device should be consistent as when resolution-dependent packages are used to build bots, any screen resolution difference between the Bot Creator and Bot Runner device will impact the bots during runtime.

Using Capture image by path action

Use the **Capture image by path** action to extract text from an image on a device or a folder in the Control Room. The extracted text can assigned as a variable.

Follow these steps to use the **Capture image by path** action:

1. In the **Actions** palette, double-click or drag the **Capture image by path** action from the **OCR** package.
2. In the **Image path** field, select an option:
 - **Control Room file:** Uses a file that is available on the Control Room.
 - **Desktop file:** Uses a file that is available on a device.
 - **Variable:** Uses a file variable to specify the file location.

3. Select the **Filter the captured text** check box to filter the captured text.
Specify the text to filter out in the **Before** and **After** fields. For example, if the extracted text is `Name: ABC Inc. Location:`, to retrieve `ABC Inc.`, you must specify `Location:` in the **Before** field and `Name:` in the **After** field.
4. Select the **Trim the captured text** check box to trim the extra spaces.
5. Select the **Load Profile** check box and select an option to load the locale based on the ABBYY profile:

Note: ABBYY FineReader 12.2.27.12 is installed along with A2019 and does not require any additional setup.

- **Control Room file:** Uses a file that is available on the Control Room.
- **Desktop file:** Uses a file that is available on a device.
- **Variable:** Uses a file variable to specify the file location.

6. In the **Select locale** list, select the language of the device.

Note: Currently, only English and Japanese locales are supported. If you have selected an option from the **Select locale** list and the **Load Profile** option, the system considers the locale based on the **Load Profile** selection.

7. In the **Assign value to variable** list, select a string variable.
8. Click **Save**.

Using Capture image by URL action

Use the **Capture image by url** action to extract text from an online image. You can filter the extracted text and assign it to a string variable.

Follow these steps to use the **Capture image by url** action:

1. In the **Actions** palette, double-click or drag the **Capture image by url** action from the **OCR** package.
2. In the **Image url** field, specify the URL.

Note: A URL of an image on a shared drive or an FTP server is not supported.

3. Select the **Filter the captured text** check box to filter the captured text.
Specify the text to filter out in the **Before** and **After** fields. For example, if the extracted text is `Name: ABC Inc. Location:`, to retrieve `ABC Inc.`, you must specify `Location:` in the **Before** field and `Name:` in the **After** field.
4. Select the **Trim the captured text** check box to trim the extra spaces.
5. Select the **Load Profile** check box and select an option to load the locale based on the ABBYY profile:

Note: ABBYY FineReader 12.2.27.12 is installed along with A2019 and does not require any additional setup.

- **Control Room file:** Uses a file that is available on the Control Room.
- **Desktop file:** Uses a file that is available on a device.
- **Variable:** Uses a file variable to specify the file location.

6. In the **Select locale** list, select the language of the device.

Note: Currently, only English and Japanese locales are supported. If you have selected an option from the **Select locale** list and the **Load Profile** option, the system considers the locale based on the **Load Profile** selection.

7. In the **Assign value to variable** list, select a string variable.
8. Click **Save**.

Using Capture window action from OCR package

Use the **Capture window** action to extract text from an application window. You can filter the extracted text and assign it to a string variable.

Follow these steps to use the **Capture window** action:

1. In the **Actions** palette, double-click or drag the **Capture window** action from the **OCR** package.
2. In the **Window title** field, select an option:
 - **Window**: Captures a window on a desktop. In the **Window title** field, specify the application title.
 - **Variable**: Inserts an existing window variable. Click **Variable** tab to create a new string variable.

Insert a wildcard character (*) in the **Window title** field to search for window titles that can change. You can specify one or more wildcards (*) at the start, middle, or end of the value. For example, to perform an operation on any window that has `Microsoft` in the title, use a wildcard to indicate any string by adding it before or after the value: `*Microsoft*`. The first searches for the exact window title (`Microsoft`), and if it does not find a match, it searches for windows with the term `Microsoft` anywhere in the title.

You can use a regular expression (regex) to identify a window title. Select the regular expression condition as either **String** or a **Pattern** and then enter the value. By default, the **Window title** field is case-sensitive.

To identify a browser title, you can enable the **Case sensitive** option to match the letter case, or disable the option to identify a window title where the letter case does not match.

Note: Ensure that the minimum version installed on your system is the version that was released with v.26. If you have a version released with v.25 or earlier, then by default, the window title will be identified only with matching letter case (case-sensitive).

For example, you can enter the **String** value as `((\w*)-Notepad` for all window title names starting with `((\w*)-Notepad`, or use **Pattern** value as `((\w)\s)*document-Notepad` for only those window titles that match this pattern.

Note:

- When you use a regular expression of type **String** with `-title` as the input value for a window title in any , the might encounter a run time error. To prevent the run time error, ensure that when you add the string input as `*-title`, the application with the specific title is open. The asterisk (*) is just a character, not a wild card character.
- When you use a regular expression of type **Pattern** with `-title` as the input value for a window title in any , the might encounter a run time error because the input value `*-title` is incorrect.

Ensure that you use valid regex patterns.

3. Optional: Select the **Resize window** option to specify the window dimensions.

This option delivers a more reliable bot. It resizes the window to the dimensions at which the task was recorded, which enhances the ability of the bot to identify the target object.

- If the window is maximized when you record the task, this option is not selected.
- If the window is not at the maximum size when you record the task, this option is selected, by default, and the width and height fields are automatically filled with the dimensions of the window.

Note: This option is available only for windows that can be resized. It is not available for the **Desktop** or **Taskbar** options.

4. In the **Wait before capturing the image (ms)** field, specify the delay time.
-

Recommendation: If you are capturing in a window that is accessed using Remote Desktop Protocol (RDP), set a minimum delay time of 1000 milliseconds to give the window time to load.

5. Select the **Filter the captured text** check box to filter the captured text.
Specify the text to filter out in the **Before** and **After** fields. For example, if the extracted text is `Name: ABC Inc. Location:`, to retrieve `ABC Inc.`, you must specify `Location:` in the **Before** field and `Name:` in the **After** field.
 6. Select the **Trim the captured text** check box to trim the extra spaces.
 7. Select the **Load Profile** check box and select an option to load the locale based on the ABBYY profile:
-

Note: ABBYY FineReader 12.2.27.12 is installed along with A2019 and does not require any additional setup.

- **Control Room file:** Uses a file that is available on the Control Room.
- **Desktop file:** Uses a file that is available on a device.
- **Variable:** Uses a file variable to specify the file location.

8. In the **Select locale** list, select the language of the device.
-

Note: Currently, only English and Japanese locales are supported. If you have selected an option from the **Select locale** list and the **Load Profile** option, the system considers the locale based on the **Load Profile** selection.

9. In the **Assign value to variable** list, select a string variable.
10. Click **Save**.

Using Capture area action from OCR package

Use the **Capture area** action to extract text from a specific area in an application window. You can filter the extracted text and assign it as a variable.

Follow these steps to use the **Capture area** action:

1. In the **Actions** palette, double-click or drag the **Capture area** action from the **OCR** package.
2. In the **Window title** field, select an option:
 - **Window:** Captures a window on a desktop. In the **Window title** field, specify the application title.
 - **Variable:** Inserts an existing window variable.

Insert a wildcard character (*) in the **Window title** field to search for window titles that can change. You can specify one or more wildcards (*) at the start, middle, or end of the value. For example, to perform an operation on any window that has `Microsoft` in the title, use a wildcard to indicate any string by adding it before or after the value: `*Microsoft*`. The first searches for the exact window

title (Microsoft), and if it does not find a match, it searches for windows with the term Microsoft anywhere in the title.

You can use a regular expression (regex) to identify a window title. Select the regular expression condition as either **String** or a **Pattern** and then enter the value. By default, the **Window title** field is case-sensitive.

To identify a browser title, you can enable the **Case sensitive** option to match the letter case, or disable the option to identify a window title where the letter case does not match.

Note: Ensure that the minimum version installed on your system is the version that was released with v.26. If you have a version released with v.25 or earlier, then by default, the window title will be identified only with matching letter case (case-sensitive).

For example, you can enter the **String** value as `((\w*)-Notepad` for all window title names starting with `((\w*)-Notepad`, or use **Pattern** value as `((\w)\s)*document-Notepad` for only those window titles that match this pattern.

Note:

- When you use a regular expression of type **String** with `-title` as the input value for a window title in any , the might encounter a run time error. To prevent the run time error, ensure that when you add the string input as `*-title`, the application with the specific title is open. The asterisk (*) is just a character, not a wild card character.
- When you use a regular expression of type **Pattern** with `-title` as the input value for a window title in any , the might encounter a run time error because the input value `*-title` is incorrect.

Ensure that you use valid regex patterns.

3. Optional: Select the **Resize window option to specify the window dimensions.**

This option delivers a more reliable bot. It resizes the window to the dimensions at which the task was recorded, which enhances the ability of the bot to identify the target object.

- If the window is maximized when you record the task, this option is not selected.
 - If the window is not at the maximum size when you record the task, this option is selected, by default, and the width and height fields are automatically filled with the dimensions of the window.
-

Note: This option is available only for windows that can be resized. It is not available for the **Desktop** or **Taskbar** options.

4. Specify the **X, Y, Width, and **Height** coordinates.**

5. Click **Capture region.**

The bot captures text from the visible area of the screen even if the target area is below the visible screen.

6. In the **Wait before capturing the image (ms) field, specify the delay time.**

Recommendation: If you are capturing in a window that is accessed using Remote Desktop Protocol (RDP), set a minimum delay time of 1000 milliseconds to give the window time to load.

7. Select the **Filter the captured text check box to filter the captured text.**

Specify the text to filter out in the **Before** and **After** fields. For example, if the extracted text is Name: ABC Inc. Location:, to retrieve ABC Inc., you must specify Location: in the **Before** field and Name: in the **After** field.

8. Select the **Trim the captured text check box to trim the extra spaces.**

9. Select the **Load Profile** check box and select an option to load the locale based on the ABBYY profile:

Note: ABBYY FineReader 12.2.27.12 is installed along with A2019 and does not require any additional setup.

- **Control Room file:** Uses a file that is available on the Control Room.
- **Desktop file:** Uses a file that is available on a device.
- **Variable:** Uses a file variable to specify the file location.

10. In the **Select locale** list, select the language of the device.

Note: Currently, only English and Japanese locales are supported. If you have selected an option from the **Select locale** list and the **Load Profile** option, the system considers the locale based on the **Load Profile** selection.

11. In the **Assign value to variable** list, select a string variable.

12. Click **Save**.

Office 365 Calendar package

The **Office 365 Calendar** package contains actions that enable you to automate meeting-related tasks in Office 365 Calendar.

Before you start

Perform the following actions within the **Office 365 Calendar** package as part of using the set of available actions:

1. Use the **Connect** action to establish a connection to the Office 365 server.

See [Using Connect action for Office 365 packages](#).

Note: Office 365 packages do not currently support Multi-Factor Authentication or Single Sign-on.

2. Use a combination of actions available in this package to automate tasks.

Note: To use actions from other Office 365 packages, establish a connection using the **Connect** action from that package.

3. Use the **Disconnect** action to terminate the connection.

Actions in the **Office 365 Calendar** package

The **Office 365 Calendar** package includes the following actions:

Note: Some of the actions must be used within a **Loop** action to apply the action to each meeting in the calendar. See [Using Office 365 Calendar actions in a loop](#).

Action	Description
Add attachment	<p>Adds one or more attachments to a meeting. Use this action within a Loop action to repeat this operation for each meeting in the calendar. See Loop package.</p> <ul style="list-style-type: none"> • Provide the session name that you used in the Connect action. • Select the files to attach from the Control Room or your desktop, or insert a file variable. Separate each file path with a comma.
Add attendees	<p>Adds one or more attendees to a meeting and specifies whether attendance is optional or required. During run time, this action triggers an email notification to meeting attendees. Use this action within a Loop action to repeat this operation for each meeting in the calendar. See Loop package.</p> <ul style="list-style-type: none"> • Provide the session name that you used in the Connect action. • Enter the attendee emails into the Required or Optional fields. Separate each email with a comma.
Cancel meeting	<p>Cancels the meeting. During run time, this action triggers an email notification to meeting attendees. Use this action within a Loop action to repeat this operation for each meeting in the calendar. See Loop package.</p>
Connect	<p>Establishes a connection with the Office 365 server using your organization's client ID and tenant ID, and user credentials.</p> <p>See Using Connect action for Office 365 packages.</p>
Create meeting	<p>See Using the Create Meeting action.</p>
Delete attendees	<p>Deletes attendees from a meeting. During run time, this action triggers an email notification to meeting attendees. Use this action within a Loop action to repeat this operation for each meeting in the calendar. See Loop package.</p> <ul style="list-style-type: none"> • Provide the session name that you used in the Connect action. • Select an option to delete: meeting or attendees. To delete attendees, provide the email addresses of the attendees, separated by commas.

Action	Description
Delete meeting information	<p>Deletes information related to a meeting such as the title or location. Use this action within a Loop action to repeat this operation for each meeting in the calendar. See Loop package.</p> <ul style="list-style-type: none"> • Provide the session name that you used in the Connect action. • Select the meeting information to delete. The options are: <ul style="list-style-type: none"> • Title • Location • Agenda • Reminder • Recurrence • Is all day
Disconnect	<p>Terminates the connection with the Office 365 server. Enter the session name that you used in the Connect action. Insert this action at the end of automation sequences that use actions from this Office 365 package.</p>
Get available meeting slot(s)	<p>See Using the Get available meeting slots action.</p>
Modify meeting	<p>Modifies information for a meeting. Use this action within a Loop action to repeat this operation for each meeting in the calendar. See Loop package.</p> <ul style="list-style-type: none"> • Provide the session name that you used in the Connect action. • Modify any of the following: <ul style="list-style-type: none"> • Meeting start or end date. • Convert the meeting to all day. • Revise the meeting title. • Revise the agenda. • Update the location. • Update the reminder. • Update the recurrence, frequency, start date, and end date.
Respond to meeting	<p>Responds to a meeting as accepted, rejected, or tentative. You can also add a message to the response. Use this action within a Loop action to repeat this operation for each meeting in the calendar. See Loop package.</p>

Using the Create Meeting action

Use the **Create Meeting** action to specify a meeting agenda, attachments, attendees, duration, location, recurrence, and title. During run time, this action sends an invitation email to meeting attendees.

This action uses two Datetime variables to set the meeting start and end. Define the values before you start. The recurrence option also uses two Datetime variables to set the start and end. For more information, see [Your variables \(user-defined\)](#).

To create a meeting, do the following:

1. Enter the session name that you used in the **Connect** action.
2. Enter the calendar name.
This field is case-sensitive.
The prepopulated value is Calendar; this is the default Office 365 setting.
3. Specify the meeting start date and time.
Select a DateTime variable from the drop-down list.
4. Specify the meeting end date and time.
Select a DateTime variable with a value that is the same or after the start time.
5. Optional: Mark the **All day meeting** option.
For an all day meeting, ensure that there is a one-day difference between the start and end dates.
6. Enter attendee email addresses, separated by commas.
7. Optional: Enter the following details:
 - Attach a file from the Control Room, Desktop, or insert a File variable.
 - Enter a meeting title.
 - Enter a meeting location.
 - Enter an agenda.
 - Set a reminder.
 - Set a recurrence with the following options:
 - Select the recurrence type: **Daily**, **Weekly**, **Monthly**, or **Yearly**.
 - For **Weekly** recurrence, mark the days of the week on which the meeting takes place.
 - For **Monthly** recurrence, either enter the numerical date or select a day.
For example, to schedule a meeting that takes place on the twenty-fifth day of the month enter 25 in the **Specific date** field.

Note: If you enter 31 in the **Specific date** field, for the months with less than 31 days, the meeting will schedule for the last day of the month.

To schedule it for the last Monday of the month, select **Last** from the **Occurrence** drop-down list and **Monday** from the **Weekday** drop-down list.

- For **Yearly** recurrence, either enter the numerical date and month or select a day and month.

For example, to schedule a meeting that takes place on March 15, enter 15 in the **Specific Date** field and March in the **Month** field. To schedule it for the second Friday in March, select **Second** from the **Occurrence** drop-down list, select **Friday** from the **Weekday** drop-down list, and **March** from the **Month** drop-down list.

- Enter the recurrence frequency.
- Specify the recurrence start by selecting a DateTime variable from the drop-down list.
- If the recurrence has an end date, select a DateTime variable from the drop-down list.

Using the Get available meeting slots action

Use the **Get available meeting slots** action to retrieve available time slots for attendees in a specified date and time range. This action supports scheduling across time zones.

This action considers a time slot as available if it is within an attendee's working hours and if the attendee has not already accepted a meeting for that time. If an attendee tentatively responds or does not respond to an invitation, this action considers them available.

To retrieve available time slots, perform the following steps:

1. Enter the session name that you used in the **Connect** action.
2. Enter the email addresses of the attendees, separated by commas.
3. Enter the duration of the meeting in minutes.
4. Specify the range start date and time by selecting a DateTime variable from the drop-down list.
5. Specify the range end date and time by select a DateTime variable with a value that is the same or after the start time.
6. Optional: Select the **Check for timeslots outside working hours** option.
7. Select a Table variable from the drop-down list.
8. Click **Save**.

Using Office 365 Calendar actions in a loop

You must use certain Office 365 Calendar actions within a **Loop** action.

This action uses two Datetime variables to set the meeting start and end. Define the values before you start. For more information, see [Your variables \(user-defined\)](#).

To use an Office 365 Calendar action within a loop, follow these steps:

1. Double-click or drag the **Loop** action from the **Loop** package in the **Actions** palette.
2. Select the **For each meeting in calendar** iterator.
3. Enter the session name that you used in the **Connect** action.
4. Enter the calendar name.
This field is case-sensitive.
The prepopulated value is Calendar; this is the default Office 365 setting.
5. Select whether to loop through **All meetings in the calendar** or only meetings with the specific title.
6. Specify the meeting start date and time.
Select a DateTime variable from the drop-down list.
7. Specify the meeting end date and time.
Select a DateTime variable with a value that is the same or after the start time.
8. Optional: Enter the location.
9. Optional: Enter the duration in minutes.
10. Optional: Mark the **All day meeting** option.
For an all day meeting, ensure that there is a one-day difference between the start and end dates.
11. Optional: Enter the meeting owner's email address.
12. Select or create a record variable to hold the output.

Using Connect action for Office 365 packages

Use the **Connect** action to establish a connection with the Office 365 server using your organization's (client ID and tenant ID) and user credentials. All of the fields in this action accept a credential from the Credential Vault or a user-input value.

Note:

- The **Connect** action does not currently support Multi-Factor Authentication or Single Sign-on.
- The best practice is for a system administrator to perform the following steps.

1. Log in to the [Azure portal](#) using your Office 365 credentials.
2. Register your application with the Microsoft identity platform to obtain the client ID and tenant ID. See [Register your app](#).
3. Grant the required permissions for **Microsoft Graph** to the application. See [Permissions for application](#).
4. To add a client secret, you must first subscribe to Azure. See [Subscribe to Azure](#).
5. Add a client secret. See [Add a client secret](#).

For an example on how to setup and connect to the Office 365 OneDrive package, see [Working with the Office 365 OneDrive package](#).

To establish a connection to the Office 365 server, follow these steps:

1. In the **Actions** palette, double-click or drag the **Connect** action from the package you want to use.
2. In the **User session** field, enter a name for this session.
Provide this session name in subsequent actions from this package.
3. In the **Username** and **Password** fields, enter your user credentials or insert them from the Credential Vault.
4. In the **Tenant ID** field, enter the unique ID for your Office 365 subscription or insert it from the Credential Vault.
5. In the **Client ID** field, enter the Office 365 client or insert it from the Credential Vault.
6. In the **Client Secret Key** field enter your access token or insert it from the Credential Vault.
7. Click **Save**.

Permissions for application

After registering the Office 365, you must grant certain permissions to the application. These permissions are required to enable Office 365 packages to perform various operations.

To grant permissions to an application, see [Add permissions](#).

Note: You must be the co-owner of the application for which you are configuring permissions.

The following [Delegated permissions](#) for **Microsoft Graph** are required for Office 365 packages:

Common permissions	
	openid
	offline_access
	User.Read
	User.ReadBasic.All
One Drive	
	Files.ReadWrite.All

	Sites.ReadWrite.All
Calendar	
	Calendars.Read
	Calendars.Read.Shared
	Calendars.ReadWrite
Email	
	Mail.Read
	Mail.ReadWrite
	MailboxSettings.Read
	MailboxSettings.ReadWrite
Directory	
	Directory.AccessAsUser.All
	Directory.ReadWriter.All

Apart from the above permissions, you can grant additional permissions based on your requirements. See, [Microsoft Graph permission reference](#).

Office 365 Excel package

The Office 365 Excel package contains actions that enable you to automate tasks in the online version of Microsoft Excel.

Choosing the Excel package in Automation 360

Automation 360 includes packages to support three types of Microsoft Excel usage. For optimal results, use the package that corresponds to the type of Excel that is available on the device you are running bots on.

- **No Excel installed:** If you do not have Microsoft Excel installed on the device on which you are running bots to automate Excel-related processes, use the Excel basic package.
- **Desktop Excel installed:** If you have a desktop version of Microsoft Excel installed on your computer, use the Excel advanced package in your bots.
- **Online Office 365 Excel only:** If you are using Microsoft Excel 365 on a web browser, use the Office 365 Excel package for automating tasks related to Excel.

Before you start

1. Use the **Connect** action to establish a connection to the Office 365 server.

See [Using Connect action for Office 365 packages](#).

Note: Office 365 packages do not currently support Multi-Factor Authentication or Single Sign-on.

2. Use the **Open** action to select a workbook, or the **Create** action to create a new workbook. See [Workbook operations in Office 365 Excel](#).

3. **Optional:** If the workbook contains more than one worksheet, use the **Activate sheet** action to specify which worksheet to use.
4. Use a combination of actions available in this package to automate tasks.

Note: To use actions from other Office 365 packages, establish a connection using the **Connect** action from that package.

5. Use the **Close** action to exit from the workbook.
6. Use the **Disconnect** action to terminate the connection.

Actions in the Office 365 Excel package

The actions in the Office 365 Excel package enable you to perform the following operations:

Operations	Description
Cell	Perform operations related to cell and range operations, such as append, delete, format, get properties, and insert. See Cell operations in Office 365 Excel
Row and column	Perform operations related to column and row operations such as autofit, delete, and read. See Column/Row operations in Office 365 Excel .
Table	Perform operations related to the table operations such as create, delete, filter, get properties, rename, and sort. See Table operations in Office 365 Excel .
Workbook	Automate opening, closing, and creating a workbook. See Workbook operations in Office 365 Excel .
Worksheet	Perform operations related to worksheet operations, such as activate, delete, find, get worksheet names, hide, retrieve worksheet count, and show. See Worksheet operations in Office 365 Excel .

Cell operations in Office 365 Excel

The **Office 365 Excel** package contains actions that you can use to automate tasks related to cell and range operations, such as append, delete, format, get properties, and insert.

The **Office 365 Excel** package includes the following actions:

Action	Description
Delete cell	<p>Deletes the Active cell or a Specific cell from the current worksheet.</p> <ul style="list-style-type: none"> • Enter the name of the session used to open the workbook with the Open action. • If you select Specific cell, enter the cell location. For example A1. • Select one of the following options: <ul style="list-style-type: none"> • Shift cells left: Deletes the specified cell and shifts the cell one position to left. • Shift cells up: Deletes the specified cell and shifts the cell one position up. • Entire row: Deletes the entire row that contains the cell that you have specified to delete. • Entire column: Deletes the entire column that contains the cell that you have specified to delete.
Delete range	<p>Deletes a specific range of cells.</p> <ul style="list-style-type: none"> • Enter the name of the session used to open the workbook with the Open action. • Enter the cell range. For example A1:B4. This deletes an area consisting of the first four rows by the first two columns. • Use the radio buttons to specify whether to shift the cells up or left. <ul style="list-style-type: none"> • Shift cells up: Deletes the specified cells and shifts the cells up by the number of rows deleted. • Shift cells left: Deletes the specified cells and shifts the cells left by the number of columns deleted.
Format cell	See Using the Format cell action.
Get cell	<p>Retrieves the value of a cell.</p> <ul style="list-style-type: none"> • Enter the name of the session used to open the workbook with the Open action. • Select the Active cell or Specific cell option and enter the cell location. • Assign the output to a String variable. To perform mathematical operations, convert the string to a number. See the String > Convert action.
Get cell/text color	See Using the Get cell/text color action.

Action	Description
Get multiple cells	<p>Retrieves the value(s) of multiple cells within a worksheet and assigns the output to a variable.</p> <ul style="list-style-type: none"> • Enter the name of the session used to open the workbook with the Open action. • Select the Multiple cells or All cells option. If you select Multiple cells, enter the cell range, such as <code>A1:D1</code>. This retrieves the values of the first four cells in the top row. • Assign the output to a String variable. To convert the string to a number, see the String > Convert action.
Go to cell	<p>Moves the cursor to a specific cell in the worksheet.</p> <ul style="list-style-type: none"> • Enter the name of the session used to open the workbook with the Open action. • Select from the following options: <ul style="list-style-type: none"> • Specific cell: Moves to the specified cell address. • One cell to the left: Moves one cell left. • One cell to the right: Moves one cell right. • One cell above: Moves one cell up. • One cell below: Moves one cell down. • Beginning of row: Moves to the first cell in the same row. • End of row: Moves to the last cell that contains data in the same row. • Beginning of column: Moves to the first cell in the same column. • End of column: Moves to the last cell that contains data in the same column.
Insert cell	<p>Inserts a value to the Active cell or a Specific cell in the current worksheet without overwriting the existing value.</p> <ul style="list-style-type: none"> • Enter the name of the session used to open the workbook with the Open action. • If you select Specific cell, enter the cell location. For example <code>A1</code>. • After inserting the cell, you can: <ul style="list-style-type: none"> • Shift cells down: Shifts the existing values down by the specified number of rows. • Shift cells right: Shifts the existing values right by the specified number of columns.

Action	Description
Insert range	<p>Inserts the range into the current worksheet without overwriting the existing value.</p> <ul style="list-style-type: none"> • Enter the name of the session used to open the workbook with the Open action. • Enter the cell range. For example A1:B4. This inserts a range of cells consisting of the first four rows by the first two columns. • After inserting the cell, you can: <ul style="list-style-type: none"> • Shift cells down: Shifts the existing values down by the specified number of rows. • Shift cells right: Shifts the existing values right by the specified number of columns.
Paste cell	<p>Copies a value from a cell and pastes to a specified cell. If there is a value in the destination cell, this action will overwrite the value.</p> <ul style="list-style-type: none"> • Enter the name of the session used to open the workbook with the Open action. • Select the Active cell or Specified cell option to specify the cell from which to copy the value. If you have selected the Specified cell option, specify the address of the cell in the field. • Enter the destination cell address to paste the value. For example, B3.
Read cell format	<p>Gets the format of the Active cell or Specified cell and assigns the output to a string variable. This action returns a blank value if the specified cell does not contain a formula.</p> <ul style="list-style-type: none"> • Enter the name of the session used to open the workbook with the Open action. • Select the Active cell or Specified cell option to specify the cell from which to read the format. If you have selected the Specified cell option, specify the address of the cell in the field. • Select a String variable to store the cell format from the Assign the output to variable list.

Action	Description
Read cell formula	<p>Gets the formula available in the Active cell or Specified cell and assigns the output to a string variable. This action returns a blank value if the specified cell does not contain a formula.</p> <ul style="list-style-type: none"> • Enter the name of the session used to open the workbook with the Open . • Select the Active cell or Specified cell option to specify the cell from which to read the formula. If you have selected the Specified cell option, specify the address of the cell in the field. • Select a string variable to store the name of the formula from the Assign the output to variable list. The shows a descriptive default variable name. If you create several output variables, subsequent variable names are appended with a -1, -2, -3, and so on to avoid duplication.
Set cell	<p>Sets a value in the Active cell or Specific cell in a Microsoft Excel spreadsheet or a CSV file. You can also use this action to set a formula.</p> <ul style="list-style-type: none"> • Select the Active cell or Specified cell option to specify the cell in which to set the value. If you have selected the Specified cell option, specify the address of the cell in the field. <hr/> <p>Note: You can enter a cell range in the Specific cell field to set a particular value in all the cells of the range. For example, to set a value of 5 on all cells in the second row and from the first through third column, enter <code>A2 : C2</code>.</p> <hr/> <ul style="list-style-type: none"> • Enter the value to set in the Cell value field. • Enter the name of the session used to open the workbook with the Open .
Set cell color	<p>Sets a color to the background or text of the Active cell or Specific cell.</p> <ul style="list-style-type: none"> • Enter the name of the session used to open the workbook with the Open action. • Select the Active cell, Specified cell, or Cell range option to specify the cell in which to set the color. If you have selected the Specified cell option, specify the address of the cell in the field. • Select which to apply the color to: the Cell or Text within cell. • Enter the value to set in the Cell value field. Use either the color name or the hex value. For a list of color names and corresponding hex values, see Frequently used cell colors.

Action	Description
Set cell formula	<p>Sets the formula of the specified cell.</p> <ul style="list-style-type: none"> Enter the name of the session used to open the workbook with the Open action. Select the Active cell, Specified cell, or Cell range option to specify the cell in which to set the color. If you have selected the Specified cell option, specify the address of the cell in the field. Enter the value to set in the Cell formula field without an "=".

Using the Format cell action

Use the **Format cell** action to set the format of a cell or group of cells.

To format a cell or group of cells, do the following:

- Double-click or drag the **Format cell** action.
- Enter the name of the session used to open the workbook with the **Open**.
- Select the **Active cell**, **Specific cell**, or **Multiple cells** option and provide cell location or cell range, as necessary.
- Mark the **Font** option to modify any of the following:
 - Font name
 - Font size (between 8 and 72)
 - Bold or italicize
 - Underline
 - Font color (accepts color name or hex value). For a list of color names and corresponding hex values, see [Frequently used cell colors](#).
- Mark the **Alignment** option, then use the drop-down lists to modify the vertical or horizontal alignment.
- Mark the **wrap text** option to expand the cell(s) vertically to show long strings of text.
- Mark the **Merge Type** option to select the any of the following operations:
 - Merge and center
 - Merge across
 - Merge cells
 - Unmerge
- Click **Save**.

Frequently used cell colors

The table below contains color names and their corresponding hex values. These are the most frequently used options for formatting worksheets.

Name	Hex
Aqua	#00FFFF
Black	#000000
Blue	#0000FF
Gray	#808080

Name	Hex
Green	#008000
Fuchsia	#FF00FF
Lime	#00FF00
Maroon	#800000
Navy	#000080
Olive	#808000
Purple	#800080
Red	#FF0000
Silver	#C0C0C0
Teal	#008080
White	#FFFFFF
Yellow	#FFFF00

Using the Get cell/text color action

Use the **Get cell/text color** action to get the color of the background or text in a cell. This action retrieves the color of a cell as RGB values. For example, if the background or text in a cell is of red color, the value retrieved is 255,0,0.

To get the color of the background or text in a cell, do the following:

1. Double-click or drag the **Get cell/text color** action.
2. Enter the name of the session used to open the workbook with the **Open** .
3. Select the **Active cell** option to get the color from the current active cell or the **Specific cell** option to get the color from the address of the cell you have specified.
4. Select the **Cell color** option to get the background color of the cell, the **Text color** option to get the color of the text, or both.
5. Specify whether to retrieve the cell color by name or as an RGB value.
6. Select a variable from the **Assign the output to variable** list to assign the cell/text color to a List variable.
7. Click **Save**.

If both cell and text colors are retrieved, the List variable contains the cell color at index 0 and text color at index 1.

Column/Row operations in Office 365 Excel

The **Office 365 Excel** package contains actions that you can use to automate tasks related to column and row operations such as autofit, delete, insert, and read.

The **Office 365 Excel** package includes the following actions:

Actions	Description
Autofit columns	Adjusts the width of the columns in the worksheet in the specified session. Use Enter the name of the session used to open the workbook with the Open .

Actions	Description
Autofit rows	Adjusts the height of the rows in the worksheet in the specified session. Use Enter the name of the session used to open the workbook with the Open .
Delete row/column	See <i>Using Delete action for rows or columns</i> .
Get row count	Retrieves the number of rows that contain data in the worksheet. <ul style="list-style-type: none"> Enter the name of the session used to open the workbook with the Open action. Assign the output value to a Number variable. To convert the variable to a String variable, see the <i>Number > Convert</i> action.
Insert row/column	See <i>Using Insert action for rows or columns</i> .
Read column	Extracts data from a column and stores it in a List variable. <ul style="list-style-type: none"> Enter the name of the session used to open the workbook with the Open action. Select the From active cell or From specific cell option to specify the starting point. You can also select the Read full column option to extract data for the entire column. Assign the output value to a List variable.
Read row	Extracts data from a row and stores it in a Record variable. <ul style="list-style-type: none"> Enter the name of the session used to open the workbook with the Open action. Select the From active cell or From specific cell option to specify the starting point. You can also select the Read full row option to extract data for the entire row. Assign the output value to a Record variable.

Using Delete action for rows or columns

Use the **Delete** action to remove rows or columns from the current worksheet.

To delete rows or columns in a worksheet, do the following:

1. Double-click or drag **Office 365 Excel > Delete**.
2. Enter the name of the session used to open the workbook with the **Open** .

3. Select one of the following:

- Row operations
 - a.** Select the **Delete Row(s) at** option to delete all of the cells in a specific row. Specify the row number to delete in the field. For example, to delete the tenth row in the worksheet, enter 10 in the field.
 - b.** Select the **Delete Row(s) by** option to delete all of the cells in either:
 - the row of the active cell.
 - a specific range of cells. Specify the range to delete. For example, to delete the first five rows, enter 1 : 5 in the field.
- Column operations
 - a.** Select the **Delete Column(s) at** option to delete all of the cells in a specific column. Specify the address of the column to delete in the field. For example, to delete column 'D' in the worksheet, enter D in the field.
 - b.** Select the **Delete Columns(s) by** option to delete all of the cells in either:
 - the column of the active cell.
 - a specific range of cells. Specify the range to delete. For example, to delete the first five columns, enter A : E in the field.

4. Click **Save**.

Using Insert action for rows or columns

Use the **Insert** action to create rows or columns in the current worksheet.

To insert or delete rows or columns in a worksheet, do the following:

- 1.** Double-click or drag **Office 365 Excel > Insert**.
- 2.** Enter the name of the session used to open the workbook with the **Open** .

3. Select one of the following:

- Row operations
 - a. Select the **Insert Row(s) at** option to insert a row and specify the location where to insert the row in the field. For example, to insert a row of cells in the tenth row in the worksheet, enter 10 in the field.
 - b. Select the **Insert Row(s) by** option to insert all of the cells in either:
 - the row of the active cell.
 - a specific range of cells. Specify the range where to insert the row. For example, to insert a row of cells in the first five rows in the worksheet, enter 1:5 in the field.

- Column operations
 - a. Select the **Insert Column(s) at** option to insert a column and specify the location where to insert the row in the field. For example, to insert a column of cells in column 'D' in the worksheet, enter D in the field.
 - b. Select the **Insert Columns(s) by** option to insert all of the cells in either:
 - the column of the active cell.
 - a specific range of cells. Specify the range to insert the column. For example, to insert a row of cells in the first five columns, enter A:E in the field.

4. Click **Save**.

Table operations in Office 365 Excel

The **Office 365 Excel** package contains various actions that you can use to automate tasks related to the table operations such as create, delete, filter, get properties, rename, and sort.

The **Office 365 Excel** package includes the following actions:

Actions	Description
Create table	<p>Creates a new table in the specified table range.</p> <ul style="list-style-type: none"> • Enter the name of the session used to open the workbook with the Open action. • Enter the table name. • Enter the cell range in which to create the table. For example, A1:D4. • Optional: Select the Table has headers option to establish the first row as the header row.
Delete table	<p>Deletes the table in the active worksheet.</p> <ul style="list-style-type: none"> • Enter the name of the session used to open the workbook with the Open action. • Enter the table name.

Actions	Description
Get table column	<p>Retrieves the column values of a specified table and column index, and assigns the values to a List variable.</p> <ul style="list-style-type: none"> • Enter the name of the session used to open the workbook with the Open action. • Enter the table name. • Enter the column index. For example, enter 5 to indicate the fifth column from the left. • Select a List variable to store the values.
Get table names	<p>Retrieves the names of all the tables in a workbook and assigns them to a List variable.</p> <ul style="list-style-type: none"> • Enter the name of the session used to open the workbook with the Open action. • Optional: Select whether to specify a sheet either by index or name. • Select a List variable to store the values.
Get table row	<p>Retrieves the row values of a specified table and row index, and assigns the values to a Record variable.</p> <ul style="list-style-type: none"> • Enter the name of the session used to open the workbook with the Open action. • Enter the table name. • Enter the row index. For example, enter 5 to indicate the fifth row from the top. • Select a Record variable to store the values.
Get table row count	<p>Retrieves the row count of a specified table and assigns the values to a number variable.</p> <ul style="list-style-type: none"> • Enter the name of the session used to open the workbook with the Open action. • Enter the table name. • Select a Number type variable to store the values. To convert the variable to a String type variable, see the Number > Convert action.
Rename table	<p>Renames a table.</p> <ul style="list-style-type: none"> • Enter the name of the session used to open the workbook with the Open action. • Enter the current table name. • Enter a new table name.

Workbook operations in Office 365 Excel

The **Office 365 Excel** package contains actions that you can use to automate opening, closing, or creating a new workbook.

The **Office 365 Excel** package includes the following actions:

Actions	Description
Close	Closes the workbook. Use Enter the name of the session used to open the workbook with the Open .
Create workbook	<p>Creates a new workbook.</p> <ul style="list-style-type: none"> • Enter Enter the name of the session used to open the workbook with the Open . • Provide a File Path containing the new workbook name with one of the following extensions: .xls, .xlsm, .xlsx. Either enter the file path or select a String variable. <p>For example, to perform this action on a file named SalesReport.xlsx, located in the Accounts folder, enter <code>Accounts/SalesReport.xlsx</code>.</p>
Open	See Using the Open action .

Using the Open action

Use this action to open a workbook. Insert this action at the start of your automation sequences.

To open a workbook, do the following:

1. Double-click or drag the **Open** action.
2. Provide the username either by selecting a Credential variable or entering an unencrypted value.
3. Enter a **Session name**.

Use this same session name in subsequent actions to associate them with this workbook.

4. Enter the **File Path** or insert a file variable.

For example, to perform this action on a file named SalesReport.xlsx, located in the Accounts folder, enter the file name `SalesReport.xlsx`.

Note: Ensure that the Microsoft Excel file is placed in the **My Files** folder in OneDrive.

5. If the sheet contains a header row, mark the **Sheet contains header** option.
6. Click **Save**.

Worksheet operations in Office 365 Excel

The **Office 365 Excel** package contains actions that you can use to automate tasks related to worksheet operations, such as delete, find, get worksheet names, hide, retrieve worksheet count, and show.

The **Office 365 Excel** package includes the following actions:

Actions	Description
Copy worksheet	See Using the Copy worksheet action .

Actions	Description
Create worksheet	<p>Adds an empty sheet in the current workbook.</p> <ul style="list-style-type: none"> • Enter the name of the session used to open the workbook with the Open action. • Enter a Worksheet name of up to 31 characters. The name cannot contain the following characters: \ / ? * []
Delete worksheet	<p>Deletes a spreadsheet from the current workbook.</p> <ul style="list-style-type: none"> • Enter the name of the session used to open the workbook with the Open . • Specify either an index number in the Sheet by Index field or a name in the Sheet by Name field for the worksheet. The index number is the number assigned to a worksheet. For example, if you want to perform an operation on the worksheet at the third position in the workbook, enter 3 in the field. <hr/> <p>Note: You can delete a worksheet only if the workbook contains more than one worksheet.</p> <hr/>
Get current worksheet name	<p>Retrieves the name of the currently active worksheet.</p> <ul style="list-style-type: none"> • Enter the name of the session used to open the workbook with the Open . • Select a string variable that you want to use to store the name of the worksheet from the Assign the output to variable list. The shows a descriptive default variable name. If you create several output variables, subsequent variable names are appended with a -1, -2, -3, and so on to avoid duplication.
Get worksheet names	<p>Retrieves the names of all the worksheets in the workbook.</p> <ul style="list-style-type: none"> • Enter the name of the session used to open the workbook with the Open action. • Select a list variable to store the worksheet names from the Assign the output to variable list.

Actions	Description
Hide worksheet	<p>Hides a worksheet from the current workbook.</p> <ul style="list-style-type: none"> Specify the name of the worksheet to hide in the Enter worksheet name to hide field. <hr/> <p>Note: You can hide a worksheet only if the workbook contains more than one worksheet.</p> <hr/> <ul style="list-style-type: none"> Enter the name of the session used to open the workbook with the Open .
Rename worksheet	<p>Renames a worksheet in the current workbook.</p> <ul style="list-style-type: none"> Specify the index number or name of the worksheet to rename in the Sheet by Index or Sheet by Name field. <p>The index number is the number assigned to a worksheet. For example, if you want to perform an operation on the worksheet at the third position in the workbook, enter 3 in the field.</p> <hr/> <p>Note: You cannot rename the worksheet if a worksheet with the same name already exists in the workbook.</p> <hr/> <ul style="list-style-type: none"> Enter the new worksheet name that is under 31 characters. Enter the name of the session used to open the workbook with the Open .
Retrieve sheet count	<p>Gets the number of sheets available in the current workbook and stores it in a number variable.</p> <ul style="list-style-type: none"> Select the appropriate option to specify whether to include the hidden worksheet or not and assign the count to a variable. Enter the name of the session used to open the workbook with the Open . Select a number variable that you want to use to store the name of the worksheet from the Select the variable to assign to list. The shows a descriptive default variable name. If you create several output variables, subsequent variable names are appended with a -1, -2, -3, and so on to avoid duplication.

Actions	Description
Show worksheet	Shows the hidden worksheet. <ul style="list-style-type: none"> • Enter the name of the session used to open the workbook with the Open action. • Enter the Worksheet name.
Switch to sheet	Activates a particular sheet in a Microsoft Excel file. <ul style="list-style-type: none"> • Enter the name of the session used to open the workbook with the Open action. • Specify whether to activate the Sheet by Index (numerical value) or Sheet by Name.

Using the Copy worksheet action

Use the **Copy worksheet** action to copy values of a worksheet from one worksheet to another. This action overwrites any existing values. To move values from one worksheet to another without overwriting existing values, use the **Append worksheet** action.

Open the workbook(s) containing the source and target worksheets. See [Using the Open action](#).

Note: This action identifies the destination and source workbooks by the session names used to open them. If opening two workbooks, enter a session name for the source workbook that is different than the one used to open the destination workbook.

To copy the values of a worksheet into another, do the following:

1. Double-click or drag the **Copy worksheet** action.
2. Enter the name of the session that you used to open the destination workbook in the **Open** action.
3. If the workbook contains more than one worksheet, mark the **Specific Sheet** option, then enter the index number or name of the source worksheet.
 - The index number represents the position of the worksheet in the workbook. For example, to perform an operation on the worksheet at the third position in the workbook, enter 3 in the field.
 - The sheet name field is case insensitive.
4. Enter the name of the session that you used to open the source workbook in the **Open** action.
5. If the workbook contains more than one worksheet, mark the **Specific Sheet** option, then enter the index number or name of the destination worksheet.
6. Click **Save**.

Office 365 One Drive package

The **One Drive** package contains actions that enable you to automate many of the repetitive tasks in Microsoft cloud storage.

How to use the actions in the **One Drive** package

Perform the following actions within the **One Drive** package as part of using the set of available actions:

1. Use the **Connect** action to establish a connection to the Office 365 server.

See [Using Connect action for Office 365 packages](#).

Note: Office 365 packages do not currently support Multi-Factor Authentication or Single Sign-on.

2. Use a combination of actions available in this package to automate tasks.

Note: To use actions from other Office 365 packages, establish a connection using the **Connect** action from that package.

3. Use the **Disconnect** action to terminate the connection.

For an example on how to setup and connect to the Office 365 OneDrive package, see [Working with the Office 365 OneDrive package](#).

Actions in the **One Drive** package

Use the actions in the **One Drive** package to perform an operation on a single file or folder. To perform the operation on every file in a folder, use that action in a loop. See [Using One Drive actions in a loop](#).

The **One Drive** package includes the following actions:

Action	Description
Check permission	Check permission action
Connect	Establishes a connection with the Office 365 server using your organization's client ID and tenant ID, and user credentials. See Using Connect action for Office 365 packages .
Copy file or folder	Copy file or folder action
Create folder	Create folder action
Delete file or folder	Delete file or folder action
Disconnect	Disconnect action
Download file	Download file action
Export as PDF	Export to PDF action
Find files and folders	Find files and folders action

Action	Description
Get file or folder information	<i>Get file or folder information action</i>
Move file or folder	<i>Move file or folder action</i>
Rename file or folder	<i>Rename file or folder action</i>
Restore last version	<i>Restore last version action</i>
Upload file	<i>Upload file action</i>

Using One Drive actions in a loop

Use the **Find files and folder** action to return a table of files and their properties inside of a specified folder, the **Loop** action to loop through each row in the table, and a **One Drive** action to perform an operation on every file in the table.

To perform an action on every file in a folder, do the following steps:

1. Double-click or drag **One Drive > Find files and folders**.
2. Provide your username with either a credential variable or an unencrypted value.
3. Enter the file path of the folder in which to perform the search.
4. Select the **All items in folder** option.
You can alternatively select **Specific file (or folder)** to limit the search to a specific folder on your OneDrive.
5. Select or create a table variable to hold the output.
The table variable holds information on files and folders in rows, under the following columns: name, id, createdBy, creationDate, lastModifiedBy, lastModificationDateTime, parentFolder, and Path.
6. Double-click or drag the **Loop** action.
7. Select the **For each row in table** iterator.
8. Select the table variable holding the output from step 5.
9. Select or create a record variable to temporarily hold each row.

Insert the action inside of the **Loop** container that you want to repeat on every file in the folder. This example uses the **Download file** action.

10. Double-click or drag **Outlook > Download file**.
11. Provide your username with either a credential variable or an unencrypted value.
12. Enter the following in the **File name including path** field, replacing the generic variable names with the names of the record variables from step 10:
`$(RecordVariable[7])/$$(RecordVariable[0])$`
13. Enter the path to the folder where to download the files.
14. Click **Save**.

Check permission action

The Check permission action in the Office 365 OneDrive package checks for read and write permission for a file or folder in your OneDrive.

Settings

- Enter the Office 365 user session that you provided in the **Connect** action.
- Provide the file or folder name for which to check permissions.
- Specify which permission type to verify: **Read** or **Read & Write**.
- Select a predefined Boolean type variable to hold the output, or click the icon on the right to create a new variable.

The Boolean type variable will provide a true (user has permission) or false (user does not have permission) response.

Copy file or folder action

The Copy file or folder action in the Office 365 OneDrive package duplicates a file or folder from one folder to another in your OneDrive.

Settings

- Enter the user session that you provided in the **Connect** .
- Select whether to copy a file or folder.
- Provide the source and destination file/folder names and paths or file/folder link.

To obtain the file or folder link, copy the link generated from [Share OneDrive files and folders](#)

For example, to perform this action on a file named SalesReport.xlsx, located in the Accounts folder, enter `/Accounts/SalesReport.xlsx`.

Note: The forward slash that indicates that a file or folder is located in the root directory is optional.

- **Optional:** If there is file or folder with the same name in the destination folder, select the **Override existing file/folder** option which replaces the existing file or folder with the one being copied.

Create folder action

The Create folder action in the Office 365 OneDrive package creates a new folder in a specific directory in your OneDrive.

Settings

- Enter the user session that you provided in the **Connect** .
- Enter the parent folder name and path, or folder link.

To obtain the folder link, copy the link generated from [Share OneDrive files and folders](#)

For example, to perform this action on a folder named Q1, located in the Survey Results folder, enter `/Survey Results/Q1`.

- Enter the new folder name.

Delete file or folder action

The Delete file or folder action in the Office 365 OneDrive package removes a file or folder from a specific directory in your OneDrive.

Settings

- Enter the user session that you provided in the **Connect** .
- Select whether to delete a file or folder.
- Provide the name and path, or file or folder link.

To obtain the file or folder link, copy the link generated from

For example, to perform this on a file named SalesReport.xlsx, located in the Accounts folder, enter /
Accounts/SalesReport.xlsx.

Note: The forward slash that indicates that a file or folder is located in the root directory is optional.

Disconnect action

The Disconnect action in the Office 365 OneDrive package enables you to terminate the connection from Office 365 OneDrive application.

Settings

Enter the user session that you provided in the **Connect** action.

Download file action

The Download file action in the Office 365 OneDrive package downloads a file from a specific directory in your OneDrive.

Settings

- Enter the user session that you provided in the **Connect** .
- Provide the file name and path, or file link.

To obtain the file link, copy the link generated from [Share OneDrive files and folders](#)

For example, to perform this on a file named SalesReport.xlsx, located in the Accounts folder, enter /
Accounts/SalesReport.xlsx.

Note: The forward slash that indicates that a file or folder is located in the root directory is optional.

- Enter the destination folder path on the local device.
- **Optional:** If there is file or folder with the same name in the destination folder, select the **Override existing file/folder** option which replaces the existing file or folder with the one being copied.

Export to PDF action

The Export to PDF action in the Office 365 OneDrive package exports an existing file in your OneDrive to a PDF on your device. This action supports the following file extensions: doc, docx, oentry, odp, pps, ppt, pptx, tf, xls, and xlsx.

Settings

- Enter the user session that you provided in the **Connect** .
- Provide the file name and path, or file link. Either enter the values or insert a predefined string variable.

To obtain the file link, copy the link generated from *Share OneDrive files and folders*

For example, to perform this on a file named SalesReport.xlsx, located in the Accounts folder, enter / Accounts/SalesReport.xlsx.

Note: The forward slash that indicates that a file or folder is located in the root directory is optional.

- Enter the export folder name and path or select a predefined string variable.
- **Optional:** If there is file or folder with the same name in the destination folder, select the **Override existing file/folder** option which replaces the existing file or folder with the one being copied.

Find files and folders action

The Find files and folders action in the Office 365 OneDrive package returns a table of files and folders in a specific directory in your OneDrive.

Settings

- Enter the user session that you provided in the **Connect** .
- Provide directory details in the **Folder to search** field: enter the folder name and path, or folder link.

To obtain the folder link, copy the link generated from

For example, to perform this on a folder named Q1, located in the Survey Results folder, enter / Survey Results/Q1.

- Specify whether to search for **All items in folder** or a **Specific file (or folder)**.

Note: The **Drive Item Name** field accepts wildcard characters in the file name and extension. For example, to search for all documents with extension docx, enter *.docx in the **Specific file (or folder)** field.

- Assign the output to a table variable.

The variable will hold the following file or folder details: Name, ID, CreatedBy, CreationDate, LastModifiedBy, LastModificationDate, and ParentFolderPath.

Get file or folder information action

The Get file or folder information action in the Office 365 OneDrive package retrieves information for a specific file or folder from OneDrive.

Settings

- Enter the user session that you provided in the **Connect** .
- Provide the file or folder name and path, or file/folder link.

To obtain the file or folder link, copy the link generated from

For example, to perform this on a file named SalesReport.xlsx, located in the Accounts folder, enter / Accounts/SalesReport.xlsx.

Note: The forward slash that indicates that a file or folder is located in the root directory is optional.

- Assign the output to a record variable.

The variable will hold the following file or folder details: Name, ID, CreatedBy, CreationDate, LastModifiedBy, LastModificationDate, and ParentFolderPath.

Move file or folder action

The Move file or folder action in the Office 365 OneDrive package moves a file or folder from one folder to another in OneDrive.

Settings

- Enter the user session that you provided in the **Connect** .
- Select whether to move a file or folder.
- Provide the source and destination file or folder names and paths, or file/folder links.

To obtain the file or folder link, copy the link generated from

For example, to perform this on a file named SalesReport.xlsx, located in the Accounts folder, enter /
Accounts/SalesReport.xlsx.

Note: The forward slash that indicates that a file or folder is located in the root directory is optional.

- **Optional:** If there is file or folder with the same name in the destination folder, select the **Override existing file/folder** option which replaces the existing file or folder with the one being copied.

Rename file or folder action

The Rename file or folder action in the Office 365 OneDrive package renames a file or folder in a specific directory in OneDrive.

Settings

- Enter the user session that you provided in the **Connect** .
- Select whether to rename a file or folder.
- Provide the current and new file or folder names, or file/folder link.
- To obtain the file or folder link, copy the link generated from
- **Optional:** If there is file or folder with the same name in the destination folder, select the **Override existing file/folder** option which replaces the existing file or folder with the one being copied.

Restore last version action

The Restore last version action in the Office 365 OneDrive package restores a file to the last version.

Settings

- Enter the user session that you provided in the **Connect** .
- Provide the file name and path, or file link.

To obtain the file or folder link, copy the link generated from

For example, to perform this on a file named SalesReport.xlsx, located in the Accounts folder, enter /Accounts/SalesReport.xlsx.

Note: The forward slash that indicates that a file or folder is located in the root directory is optional.

Upload file action

The Upload file action in the Office 365 OneDrive package uploads a file to a specific directory in OneDrive.

Settings

- Enter the user session that you provided in the **Connect**.
- Provide the file name and path on the local directory.

For example, D:/Mydata/HR/EmployeeSurvey.xlsx.

- Provide the upload folder name and path, or folder link.

To obtain the folder link, copy the link generated from

For example, to perform this action on a folder named Q1, located in the Survey Results folder in home directory, enter /Survey Results/Q1

Note: You cannot provide the private folder path from one drive as it is not supported.

- **Optional:** If there is file or folder with the same name in the destination folder, select the **Override existing file/folder** option which replaces the existing file or folder with the one being copied.

PDF package

Use the **PDF** package to automate various operations on a PDF file.

The **PDF** package enables you to perform the following tasks:

- Encrypt or decrypt a PDF file.
- Extract text from a PDF file.
- Convert a PDF file to an image.
- Merge several PDF files into a single file.
- Split a single PDF file into multiple files.

It is not necessary to have a PDF reader installed on your device.

Actions in the PDF package

The **PDF** package includes the following actions:

Note: The Extract field, Extract image, and Extract text actions in the PDF package are supported only for PDF files that are editable. These packages are not supported for scanned PDF documents that contain the PDF content as images.

Action	Description
Decrypt document	See Using the Decrypt document action.

Action	Description
Encrypt document	See Using the Encrypt document action .
Extract field	See Using the Extract field action
Extract image	See Using the Extract image action .
Extract text	See Using Extract text action from PDF .
Get property	See Using the Get property action
Merge documents	See Using the Merge documents action .
Split document	See Using the Split document action .

When an operation is performed on a PDF file, the file properties are stored in a dictionary variable. See [Using a dictionary variable for PDF properties](#).

Using the Encrypt document action

Use the **Encrypt document** action to encrypt a PDF file.

To encrypt a PDF file, follow these steps:

- In the **Actions** palette, double-click or drag the **Encrypt document** action from the **PDF** package.
- In the **PDF path**, select one of the following options to specify the location of the PDF:
 - Control Room file:** Enables you to select a PDF file that is available in a folder in the Control Room.
 - Desktop profile:** Enables you to select a PDF file that is available on your device.
 - Variable:** Enables you to specify the file variable that contains the location of the PDF file.
- Optional: In the **User password** or **Owner password** field, enter a password to restrict access to the encrypted PDF file.
 - User password:** Allow users to perform specific operations on the encrypted PDF file.
 - Owner password:** Allow users to use a password to open the file.
- In the **User Permissions to Apply** field, select the following operations:
 - Print:** Allows users to print the document.
 - Modify:** Allows users to edit the document.
 - Copy:** Allows users to copy the document.
 - Form Fill:** Allows users to fill a form in the document.
 - Document Assembly:** Allows users to combine multiple PDF files, attach files, and so on.
 - Annotation:** Allows users to apply annotations in the document.
 - Accessibility:** Allows users to read text from the document using accessibility devices.
- In the **Encryption level**, select the **RC4 40-bit**, **RC4 128-bit**, or **AES 128-bit** option to specify the encryption level.
- In the **Save encrypted PDF as** field, specify a name and location for the encrypted file. You must include the .pdf extension in the name of the encrypted file. For example, if the file name is `June_Quarter_report`, the .pdf extension is `June_Quarter_report.pdf`.
- Select the **Overwrite files with the same name** check box to overwrite existing files with the same name.

Note: If this option is not selected and the bot encounters a file with the same name at the specified location, the bot will fail.

8. Optional: From the **Assign PDF properties to a dictionary variable** list, select a dictionary variable to hold the file properties.
For more information, see [Using a dictionary variable for PDF properties](#).
9. Click **Save**.

Related tasks

[Using the Decrypt document action](#)

Use the **Decrypt document** action to decrypt a PDF file that is encrypted using the **Encrypt document** action.

Using the Extract field action

Use the **Extract field** action to extract fields from a PDF and assign it to variables.

Important: When you extract fields from a PDF that contains 20 form fields, processing time might be 30 to 40 % longer than PDFs without form fields.

To extract fields from a PDF file, follow these steps:

1. In the **Actions** palette, double-click or drag the **Extract field** action from the **PDF** package.
2. In the **PDF path**, select one of the following options to specify the location of the PDF:
 - **Control Room file:** Enables you to select a PDF file that is available in a folder in the Control Room.
 - **Desktop profile:** Enables you to select a PDF file that is available on your device.
 - **Variable:** Enables you to specify the file variable that contains the location of the PDF file.
3. From the **File is protected** field, select **Yes** if the file is encrypted and provide the **User password** or **Owner password**.
4. Click **Open PDF viewer**.
5. In the **Select a PDF file** window, select a PDF file from Control Room file or Desktop file.
6. Optional: Enter the password.
7. Click **Load** to open the **PDF Viewer**.
In the **PDF Viewer** window, the PDF is opened with all the structured fields highlighted in purple dotted rectangles.
8. Select the rectangular area of the field to be extracted and click **Add field** to add the field and its value under the **Extract fields** table.
9. Optional: You can add an unstructured field that are not highlighted in the PDF. Select the **Draw a region** option available at the top of the PDF viewer and draw a rectangle box around the required region.
A red colored dotted rectangle is highlighted with an option **Add custom region**
10. Click **Add custom region** to view the captured coordinates in the **Custom region** window. Enter the **Key name** that can be used in the output variable.
11. Click **Close** to add the field in the **Extract fields** table.
The list of extracted fields appear under the **Extract fields** table on the right panel of **PDF viewer** window.
The extracted fields change to blue dotted rectangles in the PDF viewer. You can edit the extracted fields by selecting the blue rectangle around the field.
Use the vertical ellipse button next to the extracted field in the **Extract fields** table to **Edit**, **Move** or **Delete** the field.
12. Click **Close** to close the PDF viewer .
13. From the **Save the output to a variable** field, choose either a dictionary variable or multiple variables to hold the field values.

14. Click Save.

Using Extract text action from PDF

Extract text from a PDF file and save it as a text file by using the **Extract text** action.

Important: If the correct fonts are not embedded in the PDF file, the **Extract text** action does not extract the text correctly.

Note: When you extract fields from a PDF that contains 20 form fields, processing time might be 30 to 40 % longer than PDFs without form fields.

To extract text from a PDF file, perform the following steps:

1. In the **Actions** palette, double-click or drag the **Extract text** action from the **PDF** package.
2. In the **PDF path**, select one of the following options to specify the location of the PDF:
 - **Control Room file:** Enables you to select a PDF file that is available in a folder in the Control Room.
 - **Desktop profile:** Enables you to select a PDF file that is available on your device.
 - **Variable:** Enables you to specify the file variable that contains the location of the PDF file.
3. Optional: In the **User password** or **Owner password** field, enter a password to restrict access to the encrypted PDF file.
 - **User password:** Allow users to perform specific operations on the encrypted PDF file.
 - **Owner password:** Allow users to use a password to open the file.
4. In the **Text type** field, select one of the following options:
 - **Plain text:** Extract the text and copy it to a text file.
This works similar to copying and pasting text from a PDF file to a text file.
 - **Structured text:** Preserve the original formatting of the text extracted from the PDF file.
You can select the **Reduce Data Loss** option to ensure that the complete text is extracted with minimal overlap of characters. With this functionality, the number of characters overlapped by other characters is reduced.

Note: When you select this option to extract text, the extracted text might contain extra space characters.

5. In the **Page range** field, select one of the following options:
 - **All pages:** Enables you to save all the pages in the PDF file as an image.
 - **Pages:** Enables you to enter the page numbers of the pages that you want to save as an image.
6. In the **Export data to text file** field, specify a name and location for the text file.

Note: You must include the .txt extension in the name of the text file. For example, if the file name is `June_Quarter_report`, the .txt extension is `June_Quarter_report.txt`.

7. Select the **Overwrite files with the same name** check box to overwrite existing files with the same name.

Note: If this option is not selected and the bot encounters a file with the same name at the specified location, the bot will fail.

8. Optional: From the **Assign PDF properties to a dictionary variable** list, select a dictionary variable to hold the file properties.
For more information, see [Using a dictionary variable for PDF properties](#).
9. Click **Save**.

Using the Extract image action

Use the **Using Extract image** action to save a PDF file as an image.

To save a PDF file as an image, follow these steps:

1. In the **Actions** palette, double-click or drag the **Extract image** action from the **PDF** package.
2. In the **PDF path**, select one of the following options to specify the location of the PDF:
 - **Control Room file**: Enables you to select a PDF file that is available in a folder in the Control Room.
 - **Desktop profile**: Enables you to select a PDF file that is available on your device.
 - **Variable**: Enables you to specify the file variable that contains the location of the PDF file.
3. Optional: In the **User password** or **Owner password** field, enter a password to restrict access to the encrypted PDF file.
 - **User password**: Allow users to perform specific operations on the encrypted PDF file.
 - **Owner password**: Allow users to use a password to open the file.
4. In the **Page range** field, select one of the following options:
 - **All pages**: Enables you to save all the pages in the PDF file as an image.
 - **Pages**: Enables you to enter the page numbers of the pages that you want to save as an image.
5. In the **Type of image to be converted to** list, select one of the following options to specify the format:
 - **TIFF**: If you selected this option, select an option from the **TIFF compression type** list.
 - **NONE**
 - **LZE**
 - **RLE**
 - **CCITT Group 3**
 - **CCITT Group 4**
 - **BMP**
 - **JPEG**: If you selected this option, in the **JPEG quality** field, enter a value (between 0 and 100) to specify the quality of the compressed image.
 - **GIF**
 - **PNG**
 - **WMF**
 - **EMF**
 - **EXIF**
6. In the **Folder path** field, specify the location.
7. In the **File prefix** field, enter a value.
The image files are suffixed with index numbers. For example, if you have specified `Report` as the **File prefix**, the name of the image files will be `Report_1`, `Report_2`, and so on.

8. Select the **Overwrite files with the same name** check box to overwrite existing files with the same name.

Note: If this option is not selected and the bot encounters a file with the same name at the specified location, the bot will fail.

9. In the **X Resolution (dpi)** and **Y Resolution (dpi)** fields, specify the resolution.
10. In the **Image output** field, choose **Color** or **Grayscale** to specify the image output type:
- a) In the **Color property** list, select an option.
- **True color (32 bits)**
 - **True color (24 bits)**
 - **High color (16 bits)**
 - **56 color (8 bits)**
 - **16 color (4 bits)**
 - **2 color (1 bit, black/white)**

Note: This option is available only with the **Color** image output type. Select this option only if **RLE**, **CCITT Group 3**, or **CCITT Group 4** compression type is selected for the **TIFF** image format.

11. Optional: From the **Assign PDF properties to a dictionary variable** list, select a dictionary variable to hold the file properties.
For more information, see [Using a dictionary variable for PDF properties](#).
12. Click **Save**.

Using the Decrypt document action

Use the **Decrypt document** action to decrypt a PDF file that is encrypted using the **Encrypt document** action.

To decrypt an encrypted PDF file, follow these steps:

1. In the **Actions** palette, double-click or drag the **Decrypt document** action from the **PDF** package.
2. In the **PDF path**, select one of the following options to specify the location of the PDF:
 - **Control Room file:** Enables you to select a PDF file that is available in a folder in the Control Room.
 - **Desktop profile:** Enables you to select a PDF file that is available on your device.
 - **Variable:** Enables you to specify the file variable that contains the location of the PDF file.
3. Optional: In the **User/Owner password** field, enter a password to restrict access to the decrypted PDF file.
4. In the **Save the decrypted PDF file as** field, specify a name and location for the decrypted file. You must include the .pdf extension in the name of the decrypted file. For example, if the file name is `June_Quarter_report`, the .pdf extension is `June_Quarter_report.pdf`.
5. Select the **Overwrite files with the same name** check box to overwrite existing files with the same name.

Note: If this option is not selected and the bot encounters a file with the same name at the specified location, the bot will fail.

6. Optional: From the **Assign PDF properties to a dictionary variable** list, select a dictionary variable to hold the file properties.

For more information, see [Using a dictionary variable for PDF properties](#).

7. Click **Save**.

Related tasks

[Using the Encrypt document action](#)

Use the **Encrypt document** action to encrypt a PDF file.

Using the Get property action

Use the **Get property** action to obtain the properties of the PDF document.

1. In the **Actions** palette, double-click or drag the **Get property** action from the **PDF** package.
2. In the **PDF path**, select one of the following options to specify the location of the PDF:
 - **Control Room file**: Enables you to select a PDF file that is available in a folder in the Control Room.
 - **Desktop profile**: Enables you to select a PDF file that is available on your device.
 - **Variable**: Enables you to specify the file variable that contains the location of the PDF file.
3. From the **File is protected** field, select **Yes** if the file is encrypted and provide the **User password** or **Owner password**.
4. From the **Assign PDF properties to a dictionary variable** field, choose either a dictionary variable or multiple variables to hold the field values.
To assign the output to a dictionary variable, map the PDF properties such as **File**, **Author**, **Title**, and **Subject** to the corresponding dictionary keys.
5. Click **Save**.

Using the Merge documents action

Use the **Merge documents** action to merge multiple PDF files into a single PDF file.

1. In the **Actions** palette, double-click or drag the **Merge documents** action from the **PDF** package.
2. Click **Add PDF document** to provide details on the first PDF file.
The **Add PDF document** window appears.
3. In the **PDF path**, select one of the following options to specify the location of the PDF:
 - **Control Room file**: Enables you to select a PDF file that is available in a folder in the Control Room.
 - **Desktop profile**: Enables you to select a PDF file that is available on your device.
 - **Variable**: Enables you to specify the file variable that contains the location of the PDF file.
4. Optional: In the **User password** or **Owner password** field, enter a password to restrict access to the encrypted PDF file.
 - **User password**: Allow users to perform specific operations on the encrypted PDF file.
 - **Owner password**: Allow users to use a password to open the file.
5. In the **Page range** field, select one of the following options:
 - **All pages**: Selects all the pages in the PDF file.
 - **Pages**: Enter the page numbers of the pages that you want to merge.

Note: If you entered 1-3, 5-7, 8, 10 or 10, 8, 5-7, 1-3 in Enterprise 11, the output was pages 1,2,3,5,6,7,8,10. In Automation 360, if you enter the input as follows:

- In ascending order 1-3, 5-7, 8, 10, the output of the pages is 1,2,3,5,6,7,8,10

- In descending order 10, 8, 5-7, 1-3, the output of pages is 10,8,5,6,7,1,2,3

-
6. Click **Yes, Add**.
 7. Repeat Steps 2 through 6 to provide details on additional PDF files.
To modify the details of, or delete a PDF file, open the actions menu (the vertical ellipsis to the right of the file).
 8. Place the files in the order that they should appear in the merged file.
To move a file, open the actions menu. Then use the **Move up** or **Move down** options.
 9. In the **Output file path** field, specify a name and location for the merged file.
You must include the .pdf extension in the name of the decrypted file. For example, if the file name is `June_Quarter_report`, the .pdf extension is `June_Quarter_report.pdf`.
 10. Select the **Overwrite files with the same name** check box to overwrite existing files with the same name.

Note: If this option is not selected and the bot encounters a file with the same name at the specified location, the bot will fail.

11. Click **Save**.

Using the Split document action

Use the **Split document** action to split a PDF file into multiple files.

To split a PDF file into multiple files, follow these steps:

1. In the **Actions** palette, double-click or drag the **Split document** action from the **PDF** package.
2. In the **PDF path**, select one of the following options to specify the location of the PDF:
 - **Control Room file:** Enables you to select a PDF file that is available in a folder in the Control Room.
 - **Desktop profile:** Enables you to select a PDF file that is available on your device.
 - **Variable:** Enables you to specify the file variable that contains the location of the PDF file.
3. Optional: In the **User password** or **Owner password** field, enter a password to restrict access to the encrypted PDF file.
 - **User password:** Allow users to perform specific operations on the encrypted PDF file.
 - **Owner password:** Allow users to use a password to open the file.
4. In the **Output file creation options**, select one of the following options to specify how to split the PDF file:
 - **Number of pages per extracted PDF:** Enables you to specify the number of pages each new file will contain. For example, you can enter 8 if you want each output file to contain only 8 pages.
 - **Single file with selected pages:** Enables you to create a single output file that contains the pages you have specified from the original file.
 - **Blank page as a separator:** Creates a new output file whenever a blank page is encountered in the original PDF file.
PDF split separates a blank page from pages with scanned images.
 - **Bookmark level per file:** Enables you to split the PDF file according to the bookmark level available in the file. For example, if a file contains three bookmark levels, you can split the PDF file based on these three levels.

If you selected this option, specify the bookmark level in the **Bookmark Level** field.

5. In the **Folder path** field, specify the location.
6. In the **File prefix** field, enter a value.
The image files are suffixed with index numbers. For example, if you have specified `Report` as the **File prefix**, the name of the image files will be `Report_1`, `Report_2`, and so on.
7. Select the **Overwrite files with the same name** check box to overwrite existing files with the same name.

Note: If this option is not selected and the bot encounters a file with the same name at the specified location, the bot will fail.

8. Optional: From the **Assign PDF properties to a dictionary variable** list, select a dictionary variable to hold the file properties.
For more information, see [Using a dictionary variable for PDF properties](#).
9. Click **Save**.

Using a dictionary variable for PDF properties

When you automate a PDF-related task, RPA Workspace retrieves various properties of the file and stores the values of these properties in a dictionary variable.

RPA Workspace retrieves the PDF file name and extension, title, subject, and author. The file properties are stored in a dictionary variable within the following keys:

- pdfTitle
- pdfFilename
- pdfSubject
- pdfAuthor

The system automatically associates the properties of a PDF with the appropriate dictionary keys.

For example, if you create a dictionary variable `Test` and want to log the file name and author, you must enter `Test{pdfFilename}` and `Test{pdfAuthor}` in the appropriate fields.

PGP package

Use the **PGP** (Pretty Good Privacy) package to automatically encrypt and decrypt files for security.

The PGP package supports two types of encryption, symmetric (single key) and asymmetric (pair of keys) :

- **PGP symmetric** : Requires a single key to encrypt and decrypt files.
- **PGP asymmetric**: Requires PGP public and private key to encrypt and decrypt files.

Note: The system outputs an error when the proper file extension is not present in the path.

- Public key: File name specified for Public Key is not valid.
 - Private key: File name specified for Private Key is not valid.
-

Actions in the PGP package

The **PGP** package includes the following actions:

Action	Description
Create keys	<p>Creates a pair of public and private encryption keys.</p> <ul style="list-style-type: none"> In the Location to save public key file field, specify the path to the text file where to save the public key. In the Location to save private key file field, specify the path to the text file where to save the private key. Optional: In the Password to protect private key file field, select a credential variable or enter a value. Optional: Select the Overwrite Files check box to replace files with the same name.
Decrypt files	Decrypts encrypted files. See Using the Decrypt files action
Encrypt files	Encrypts files to enable users to send them over the internet securely. See Using the Encrypt files action

Using the Decrypt files action

Use the **Decrypt files** action to retrieve the contents of encrypted files and folders.

To decrypt a file or folder, do the following steps:

1. Double-click or drag the **Decrypt** action from the PGP package.
2. Select either the **Passphrase** or **Public key file** encryption type.
 - If you have selected **Passphrase**, enter the value or select a credential variable.
 - If you have selected **Private key file**, provide the private key file path.

Optional: In the **Password to protect private key file** field, select a credential variable or enter a value.
3. In the **Source folder/file(s)** field, specify the folders or files to decrypt.

This field supports wildcard characters in the file name and extension. Use an asterisk (*) to substitute for one or more unknown alphanumeric characters or symbols.
4. In the **Destination folder/file(s)** field, specify the location where to save the decrypted folders and files.

This field supports wildcard characters in the file name and extension. Use an asterisk (*) to substitute for one or more unknown alphanumeric characters or symbols.
5. Select the **Overwrite Files** option to replace files with the same name.
6. Select the **Remove file extension** option and specify the extension name.
7. Click **Save**.

Using the Encrypt files action

Use the **Encrypt files** action to prepare files and folders to be shared securely.

To encrypt the files or folder using a public key, create a public-private key pair using the **Create keys** action.

To encrypt a file or folder, do the following steps:

1. Double-click or drag the **Encrypt** action from the PGP package.
2. Select either the **Passphrase** or **Public key file** encryption type.
 - If you have selected **Passphrase**, enter the value or select a credential variable.

- If you have selected **Public key file**, provide the public key file path.
3. Select the **Encryption algorithm**.
Choose from:
 - AES128
 - AES192
 - AES256
 - Blowfish
 - CAST5
 - Idea
 - TripleDES
 - TwoFish256
 4. In the **Source folder/file(s)** field, specify the folders or files to encrypt.
This field supports wildcard characters in the file name and extension. Use an asterisk (*) to substitute for one or more unknown alphanumeric characters or symbols.
For example:
 - Enter `C:\PGP\encrypt*.csv` to select the .csv files that start with the word encrypt.
 - Enter `C:\PGP*encrypt*.*` to select files of any extension that contain the word encrypt.
 5. In the **Destination folder/file(s)** field, specify the location where to save the encrypted folders and files.
This field supports wildcard characters in the file name and extension. Use an asterisk (*) to substitute for one or more unknown alphanumeric characters or symbols.
 6. Enter a value to append to the extension of the destination file.
 7. Select the **Overwrite Files** check box to replace files with the same name.
 8. Select the **Compression type**.
Choose from:
 - None
 - zip
 - bzip2
 - zlib
 9. Select the **Armor data (text output)** check box to enable ASCII Armor output.
 10. Click **Save**.

Play Sound package

The Play Sound package contains actions that enable you to play a beep sound and media file before or after an action is executed in a bot.

The Play Sound package includes the following actions:

Action	Description
Play beep	Plays a beep sound before or after an action is executed.

Action	Description
Play media file	<p>Plays an audio file before or after an action is executed.</p> <hr/> <p>Note: Only .wav and .mp3 files are supported and do not require any media player installed on the device.</p> <hr/> <p>Select any of the following tabs to specify the location of the media file:</p> <ul style="list-style-type: none"> • Control Room file: Use a file that is available on the Control Room. • Desktop file: Use a file that is available on a device. • Variable: Use a file variable to specify the file location.

Printer package

Use the actions in the Printer package to automate retrieving and setting the default printer and removing a printer from the list of available printers.

Actions in the Printer package

The Printer package includes the following actions:

Action	Description
Get Default	Retrieves the default printer and assigns the value to a string variable.
Remove	<p>Removes a printer.</p> <p>In the Enter the printer name field, from the list of available printers, select a printer to remove it.</p>
Set Default	<p>Sets the default printer.</p> <p>In the Enter the printer name field, from the list of available printers, select a printer to set it as the default printer.</p>

Process package

The **Process** package contains a request action that enables the Control Room user to use this action and configure their bots.

Before you start

Note: The **Process** package is now renamed to the **AARI on the web** package in Enterprise A2019.18 with the **Create a Request** action and additional new actions. See [AARI Web package](#).

Ensure you have met one of the following conditions in order to run this package:

Condition 1

- Access to a process in an assigned team.
- Access to AARI User license.

- A system-created **AAE_Robotic_Interface User** role for the AARI user.
- Access to a Bot Runner license (Attended or Unattended) or Bot Creator license.
- A user-created role with the **View My Bots** and **Run My Bots** permissions.

Condition 2

Actions in the Process package

The **Process** package includes the following action:

Action	Description
Create a Request	<p>Creates a request.</p> <ul style="list-style-type: none"> • In the Select Process field, select or upload your process. • Specify your variable in the Dictionary or Variable field. <ul style="list-style-type: none"> • Dictionary: Input your variable information in the Type, Key, and Value fields. In the Type field, you can choose between Any, String, Number, Datetime, or Boolean. • Optional: In the Add field, add more dictionary variables. • Variable: Enter your custom variable. • Optional: In the Assign the Request ID to field, assign a variable to store as an output. The output is stored as an ID value.

Prompt package

Use the **Prompt** package to accept an input value, a yes/no response, or to open a file or folder.

Actions in the Prompt package

The **Prompt** package includes the following actions:

Action	Description
For file	<p>Prompts the user to input a value.</p> <ul style="list-style-type: none"> • In the Prompt window caption field, enter a window caption. • In the Prompt message field, enter a message. • In the Assign the value to a variable field, specify a list variable.

Action	Description
For folder	<p>Prompts the user to choose a folder.</p> <ul style="list-style-type: none"> In the Prompt window caption field, enter a window caption. In the Prompt message field, enter a message. In the Assign the value to a variable field, specify a variable.
For value	<p>Prompts the user to enter a value.</p> <ul style="list-style-type: none"> In the Prompt window caption field, enter a window caption. In the Prompt message field, enter a message. In the Assign the value to a variable field, specify a variable.
For yes/no	<p>Prompts the user to choose a Yes/No response.</p> <ul style="list-style-type: none"> In the Prompt window caption field, enter a window caption. In the Prompt message field, enter a message. In the Assign the value to a variable field, specify a variable.

Related reference

[Message box package](#)

Use the **Message box** action from the **Message box** package to insert a message box that shows a message when the task runs. For example, you can insert a **Message Box** action to follow a web form so that the action displays the message: `Web Form Filled and Complete`.

Python Script package

The **Python Script** package contains actions that enable Python Script functions in a task.

Before you start

Ensure the following requirements are met before using the **Python Script** package:

- The appropriate version of Python is installed on the device on which you want to execute the script.

Note: Python versions 2.x and 3.x are supported.

- The "PATH" environment variable is updated to the path of the Python folder.

To verify if the Python environment variable is set correctly, enter `python` in the command prompt. If it returns the Python version that is installed, the path environment is set up correctly.

Perform the following actions within the Python Script package as part of using the set of available actions:

- Open a Python Script file, or manually enter the script you want to run using the **Open** action. You must associate the details of the file or script you want to run with a session name.
- Run the script using the **Execute function** or the **Execute script** action. You must use the same Python Script session name established in the **Open** action.
- Close the Python Script session after running the script.

Note: When you run a bot that contains Python Script actions, the script runs in the background.

To review the bot launcher logs, navigate to `C:\ProgramData\AutomationAnywhere\BotRunner\Logs\<current month>\Bot_Launcher-<today's date>.log.zip`. Each zipped folder contains a file with data on the code execution, which is useful for debugging.

Actions in the Python Script package

The **Python Script** package includes the following actions:

Note: The **Open** action must be the first action to use the Python Script in a task. These actions can run a Python Script on Windows, Linux, and UNIX-based devices.

Action	Description
Close	See Close action .
Execute function	See Execute function action . For an example, see Example of using Python script to join a list .
Execute script	See Execute script action . For an example, see Create a PDF using Python script .
Open	See Open action .

More resources

- Free bots that use Python from Bot Store
 - [Python Excel demo](#)
 - [Speech to text using Python](#)
 - [Run Python script](#)
- Developer content on automating with Python: [Automate with Python integration](#)

Close action

The Close action in the Python Script package closes the session.

Settings

Specify the same session name from the **Open** action.

Important: It is mandatory to close the session after the script is executed.

Execute function action

The Execute function action in the Python Script package enables you to execute a function within the Python Script package.

Settings

- In the **Python session** field, specify a session name. Use the same session name from the **Open** action.
- **Optional:** Specify the function name to run and the arguments to pass to the function.
This field supports Boolean, dictionary, list, number, or string variables.

Note: The interface allows you to select only one argument. Use a list variable to concatenate multiple arguments into one variable.

- **Optional:** In the **Assign the output to variable** field, specify the string variable.

Execute script action

The Execute script action in the Python Script package enables you to execute a script within the Python Script package.

Settings

- In the **Python session** field, specify a session name. Use the same session name from the **Open** action.
- **Optional:** In the **Assign the output to variable** field, specify the string variable.
If the bot executes the script successfully, this action returns the string `True`. Otherwise an error message appears.

Open action

The Open action in the Python Script package opens the session.

Settings

- In the **Python session** field, specify a session name. Use this same session name for other **Python Script** actions.
- In the **Python** field, choose one of the following options:
 - In the **Import existing file** option, select an existing Python Script file.

Note: If you are uploading a script from a file on your desktop, the file and any dependencies must be in a standalone folder. When you select a file for upload, all files and folders at the same folder level are uploaded.

- In the **Manual input** option, enter the Python Script.
- In the **Python runtime version** field, select **2** or **3** to specify the runtime version.

Note: Select the runtime version based on the version of Python installed on the device.

Create a PDF using Python script

Build a bot that runs Python script from a file and generates a PDF.

- To run Python script from Automation 360, you must already have the latest version of Python 3.x installed on your device.
- This example uses the FPDF library to generate the PDF. Therefore, install it before you start building this bot by copying and pasting the following line in the Windows command prompt:

```
pip install fpdf
```

See [FPDF project page](#).

1. Create a file in a standalone folder to hold the following Python script:
Insert your device username in the angle brackets.

```
from fpdf import FPDF
pdf = FPDF()
pdf.add_page()
pdf.set_font("Arial", size=12)
pdf.cell(200, 10, txt="Go Be Great!", ln=1, align="C")
pdf.output("C:/Users/<yourusername>/Desktop/sample_demo.pdf")
```

Note: If you are uploading a script from a file on your desktop, the file and any dependencies must be in a standalone folder. When you select a file for upload, all files and folders at the same folder level are uploaded.

2. Create a new bot:
 - a) On the left panel, click **Automation**.
 - b) Click **Create new > Bot**.
 - c) In the **Create Task Bot** window, enter the bot name.
 - d) Accept the default folder location: `\Bots\`
To change the default bot storage location, click **Choose** and follow the prompts.
 - e) Click **Create and edit**.
3. Provide the script with a **Python Script > Open** action:
 - a) Double-click or drag the **Python Script > Open**.
 - b) Select the **Import existing file** option.
 - c) Click **Browse** to select the .py file you created in Step 1.
4. Use a **Python Script > Execute script** action to tell the bot to run the script:
 - a) Double-click or drag **Python Script > Execute script**.
5. Close the script execution session with a **Python Script > Close** action:
 - a) Double-click or drag **Python Script > Close**.
 - b) Click **Save**.

6. Click the **Run** icon.

The bot creates a PDF on the desktop with the text `Go Be Great!`.

To review the bot launcher logs, navigate to `C:\ProgramData\AutomationAnywhere\BotRunner\Logs\<current month>\Bot_Launcher-<today's date>.log.zip`. Each zipped folder contains a file with data on the code execution, which is useful for debugging.

If the bot does not create a file, change the last line in the Python script:

```
pdf.output(r"C:/Users/<yourusername>/Desktop/sample_demo.pdf")
```

Recorder package

Recorder package captures a series of tasks in a process and then automates them. You can automate your business applications (for example, desktop, Web, SAP, and Java applications) using the Recorder to capture actions performed on application objects such as a text box, button, table, radio button, combo box, and list view.

Capture action

Use the **Capture** action to capture an interaction with a user interface (UI) object. This action enables you to add a single interaction when you are building a bot.

Note:

- The Capture action replaces the Object Cloning command from Version 11.3.
- If you open a window in any of the supported browsers with a user account that is different from the one used to log in to the computer, the Recorder might not capture and play the control actions accurately.

Using the Capture action

You can capture and automate objects inside a cross-domain IFrame that has multiple IFrames with same frame source and IFrames that are loaded dynamically during runtime in Google Chrome and Microsoft Edge Chromium browsers. After you have captured an object inside a cross-domain IFrame, the frame path is stored in the **FrameDOMXPath** property, by default.

You can automate the following applications running on Microsoft Edge Chromium with IE mode:

- Java web applications
- Applications that are accessed through the Citrix Workspace app.
- Citrix Virtual Apps

The new **FrameDOMXPath** property identifies the frame in which the object is located. You must select this property to run the bot successfully to automate objects on a cross-domain IFrame.

Note: If you clear the **FrameDOMPath** property from the search criteria, the Recorder fails to identify the frame.

Important: In the Google Chrome browser, you can capture and automate objects inside a cross-domain and use multiple frames with the same frame source.

When you are automating a web page on a Google Chrome, Microsoft Edge Chromium, or Mozilla Firefox browser, you can capture the pop-up windows, alert dialog boxes, confirmation dialog boxes, and prompt dialog boxes that appear.

Recommendations:

- When you want to automate an alert dialog box on a web page, we recommend that you add a delay before the **Recorder > Capture** action because sometimes, the alert dialog box appears after a delay on the application window.
- To accurately capture or automate objects on SAP applications, we recommend that you enable scripting. If scripting is not enabled, the following prompt message is displayed below the bot runtime window:

SAP scripting disabled: Enable scripting for more reliable captures

If you do not enable scripting, instead of using SAP technology, the Recorder uses MSA technology for capturing objects.

Automate applications running as an admin user

You can capture objects on applications that are running as an administrator by selecting the **Capture and run with admin privileges** option from the Bot editor.

<https://aa2019packagesdkfordocumentation.s3.us-west-2.amazonaws.com/videos/run-in-elevated-mode.mp4>

Before you automate applications running as an admin user, ensure the following:

- Bot Agent is installed in system profile.
- Bot Creators and Bot Runners have admin rights on the device to automate the applications.

When you select the **Start recording** option in the Bot editor to record multiple applications, and switch applications running in elevated and non-elevated mode, the bot might not be able to identify the change between modes. In such cases, for all captures on applications in elevated mode, select the **Capture and run with admin privileges** option and then re-capture the object.

Note: Elevated mode gives you permission to run applications as an administrator.

Important: When you try to automate any Java or SAP application that is non-elevated by using the Recorder in elevated mode, the bot encounters an error.

To avoid this error, de-select the **Capture and run with admin privileges** option from the Bot editor and run the Recorder in non-elevated mode to capture Java or SAP applications.

Object properties

When you select an object to capture, the Universal Recorder collects data on the object's properties in order to identify the object during run time. You can do the following with the object properties:

- Verify that the captured object properties match your intended object.

For example, when capturing a table from a website, ensure the **Control Type** and **HTML Tag** values are **TABLE**.

- Retrieve a property value. Use the **Get property** action and enter the name of the property in the **Property name** field or select an object property from the list of available properties. The list includes suggested property values from the search criteria in the **Object Properties** table. To select an object

property from the list of properties, move the mouse pointer to the right of the **Property name** field and click the arrow.

For example, to retrieve the text of a link, use the **Get property** action and enter `HTML InnerText` in the **Property name** field or select `HTML InnerText` from the list of properties.

- You can select a combination of properties for the bot to search the object in your business application window uniquely.

The search algorithm for the Recorder package ensures that when you run a bot an object is captured only if its properties match the exact search criterion that you selected in the **Object properties** table. If the properties of the object do not match the search criterion exactly, then the bot fails with an error message. However, if the search criterion includes a wildcard character, then the bot captures the first object that matches the criterion.

For example, to capture a text box from an application that has three text boxes named **firstname1**, **firstname2**, and **firstname3**, if you select **HTML name** as the search criterion, enter the value `firstname` in the HTML name field, and run the bot, then the bot fails with an error message because a text box with the HTML name `firstname` does not exist. However, in the **HTML name** field, if you enter `firstname*`, and run the bot, then the bot captures the first text box that matches the criterion.

Note: This functionality is available for the bots you create using the 2.4.0-20211016-070100 version of the Recorder package starting from Automation 360 v.23. If you have created bots using a previous version of the Recorder package, you must recapture the objects to use this functionality.

Actions performed on captured objects

After capturing the object, specify the action for the bot to perform on the object at run time. For example, when you capture a hyperlink, you can select to click the link or to retrieve the link text. To see table of all objects and possible actions, see [Actions performed on objects captured with Universal Recorder](#).

Note: If you encounter an error when running a bot that captures an object from Internet Explorer and the error message is about Google Chrome, see [Your Chrome Plug-in is either not installed or disabled \(A- People login required\)](#).

Background processing

Background processing enables an automation that involves interacting with an application in the foreground (such as mouse clicks) to run in the background. We recommend that you use the option to run in background to increase the visibility of the target object and improve bot accuracy. The following actions support background processing:

- Click
- Set Text
- Get Text

Secure recording

When secure recording mode is enabled, bots do not display the target object images after capture. This ensures that sensitive data is not shown.

Note: Although the bots do not display the target images after capture, the images are still stored in the Control Room because they are required to run the bots.

When you record a task in secure recording mode, the **Preview** window temporarily shows an image of the captured area. This image is hidden after you navigate away from the Bot editor window or refresh it.

A user with admin privileges must enable this setting. See [Settings](#).

Proxy support

If your device is configured with a proxy, all outbound requests from this package are routed through the proxy server. See [Connect Bot Agent to a device with a proxy](#).

Use cases on how to use recorder

Use these example tasks to become familiar with the use of the recorder in building bots.

- [Example of entering data into a web form from a worksheet](#)
- [Example of extracting data from a web table](#)

Related reference

[Universal Recorder for object-based automation](#)

Use the Universal Recorder to record interactions, such as click, read (data extraction), and write (data entry), with user interface (UI) objects on the desktop, taskbar, or in an application or browser window.

[AISense for recording tasks from remote applications](#)

AISense is the artificial intelligence (AI) powered capability of Automation 360 that helps you identify objects from an image or an application with a complex user interface (UI) and make automation in all environments faster and more accurate.

Actions performed on objects captured with Universal Recorder

After capturing the object, specify the action for the bot to do to the object at runtime. For example, if you capture a hyperlink, you can select an action to click the link or to retrieve the link text. Refer to the table below for the objects and their possible actions.

Note:

- After you have captured an object and open the **Action** drop-down list, the list might offer actions for an object that are not supported. Only use the actions for an object that are listed in the table below.
 - You can capture any control type which is not yet supported by Microsoft UI Automation (COM) technology as **Client** control. You can perform all actions that are available in **Client** control type but only those actions that are supported for that specific control. For example, if you are capturing a slider control which is not yet supported by Microsoft UI Automation (COM) technology, it is captured as a **Client** control. You can perform only those actions that are supported by the slider control. For example, you can perform the **Click**, **Left click**, **Right click**, and **Double click** actions but you cannot perform the **Set text** action.
-

Object	Actions
Button	<ul style="list-style-type: none"> • Get property: retrieves the value of the specified object property (such as the link text) and optionally saves it to a variable. For more information, see the Object properties section. • Click • Left click: use this action if the Click action does not work during Runtime. • Right click • Double click
Checkbox	<ul style="list-style-type: none"> • Get property: retrieves the value of the specified object property (such as the link text) and optionally saves it to a variable. For more information, see the Object properties section. • Get status: retrieves whether the check box is selected. Returns checked or unchecked. • Check • Uncheck • Set focus • Toggle: switches the check box to the opposite status. For example, if the check box is checked, use the Toggle action to clear it. • Left click: use this action if the Toggle action does not work during Runtime. • Right click • Double click
Client	<ul style="list-style-type: none"> • Get property: retrieves the value of the specified object property (such as the link text) and optionally saves it to a variable. For more information, see the Object properties section. • Get all children names: retrieves the names of all the child elements of the captured control. The child elements are the elements or controls that are available under the parent control and are only visible when you use spy tools like AccChecker. • Get all children values: retrieves the values of all the child elements of the captured control. • Set text: enters text into the UI object. It supports credentials. <i>Credentials and credential variables in the Bot editor</i> • Click • Left click: use this action if the Click action does not work during Runtime. • Right click • Double click

Object	Actions
ComboBox (appears as a drop-down list)	<ul style="list-style-type: none"> • Get property: retrieves the value of the specified object property (such as the link text) and optionally saves it to a variable. For more information, see the Object properties section. • Get total items: retrieves the number of items in the box. • Get selected index: retrieves the item's position in the menu. <hr/> <p>Note: Item index counts start at 1.</p> <hr/> <ul style="list-style-type: none"> • Get selected item key: retrieves the key of the selected item. <hr/> <p>Note: The Microsoft UI Automation (COM) technology does not support this .</p> <hr/> <ul style="list-style-type: none"> • Get selected text: retrieves the data from the selected item. • Select item by index: selects the item that is located at the specified index. <hr/> <p>Note: Item index counts start at 1.</p> <hr/> <ul style="list-style-type: none"> • Select item by text selects the item that matches the specified text. <hr/> <p>Note: The Assign value field is case-sensitive.</p> <hr/> <ul style="list-style-type: none"> • Set focus <hr/> <p>Note: The Microsoft UI Automation (COM) technology does not support this .</p> <hr/> <ul style="list-style-type: none"> • Expand <hr/> <p>Note: The Microsoft UI Automation (COM) technology does not support this .</p> <hr/> <ul style="list-style-type: none"> • Click <hr/> <p>Note: The Microsoft UI Automation (COM) technology does not support this .</p> <hr/> <ul style="list-style-type: none"> • Left click: use this action if the Click action does not work during Runtime. • Right click • Double click

Object	Actions
GridView (SAP only)	<ul style="list-style-type: none"> • Click on cell by index <hr/> <p>Note: Index count starts at 1.</p> <hr/> <ul style="list-style-type: none"> • Double click current cell • Get total rows: retrieves the number of rows that contain values. • Get total columns: retrieves the number of columns that contain values. • Get cell text by index: retrieves the data in the specified cell located at the row and column index. <hr/> <p>Note: Row and column index counts start at 1. For example, to retrieve the data in cell A2, enter 1 in the Row field and 2 in the Column field.</p> <hr/> <ul style="list-style-type: none"> • Get cell index by text: retrieves the index of the cell containing the specified text. <hr/> <p>Note: The Cell Text field is case-sensitive.</p> <hr/> <ul style="list-style-type: none"> • Get property: retrieves the value of the specified object property (such as the link text) and optionally saves it to a variable. For more information, see the Object properties section. • Get table: retrieves the table data and saves it to a Table variable. For more information, see Example of extracting data from a web table • Select all • Set cell by index: enters text into the cell located at the row and column index. <hr/> <p>Note: Row and column index counts start at 1. For example, to enter text into cell A2, enter 1 in the Row field and 2 in the Column field.</p> <hr/> <ul style="list-style-type: none"> • Set cell by text: enters text into the cell containing the specified text. <hr/> <p>Note: The Find Text field is case-sensitive.</p> <hr/> <ul style="list-style-type: none"> • Set current cell • Set current row • Set focus • Left click: use this action if the Click action does not work during Runtime. • Right click • Double click
Label	<ul style="list-style-type: none"> • Get property: retrieves the value of the specified object property (such as the link text) and optionally saves it to a variable. For more information, see the Object properties section. • Set focus • Left click: use this action if the Click action does not work during Runtime. • Right click • Double click

Object	Actions
<p>Link</p> <hr/> <p>Note: The Microsoft UI Automation (COM) technology does not support this control.</p> <hr/>	<ul style="list-style-type: none"> • Get property: retrieves the value of the specified object property (such as the link text) and optionally saves it to a variable. For more information, see the Object properties section. • Click • Left click: use this action if the Click action does not work during Runtime. • Right click • Double click
<p>ListView</p>	<ul style="list-style-type: none"> • Get property: retrieves the value of the specified object property (such as the link text) and optionally saves it to a variable. For more information, see the Object properties section. • Get total items: retrieves the number of items in the list. • Get selected index: retrieves the item's position in the menu. <hr/> <p>Note: Item index counts start at 1.</p> <hr/> <ul style="list-style-type: none"> • Get selected text: retrieves the data from the selected item. • Select item by index: selects the item that is located at the specified index. <hr/> <p>Note: Item index counts start at 1.</p> <hr/> <ul style="list-style-type: none"> • Select item by text selects the item that matches the specified text. <hr/> <p>Note: The Assign value field is case-sensitive.</p> <hr/> <ul style="list-style-type: none"> • Click • Left click: use this action if the Click action does not work during Runtime. • Right click • Double click
<p>Main window</p> <hr/> <p>Note: The Microsoft UI Automation (COM) technology does not support this control.</p> <hr/>	<ul style="list-style-type: none"> • Get focus control id: retrieves the ID of the control that is in focus. • Get property: retrieves the value of the specified object property (such as the link text) and optionally saves it to a variable. For more information, see the Object properties section. • Set focus • Send key • Left click: use this action if the Click action does not work during Runtime. • Right click • Double click

Object	Actions
<p>Menu</p> <hr/> <p>Note: The Microsoft UI Automation (COM) technology does not support this control.</p> <hr/>	<ul style="list-style-type: none"> • Get property: retrieves the value of the specified object property (such as the link text) and optionally saves it to a variable. For more information, see the Object properties section. • Get total items: retrieves the number of items in the menu. • Get selected index: retrieves the item's position in the menu. <hr/> <p>Note: Item index counts start at 1.</p> <hr/> <ul style="list-style-type: none"> • Get selected text: retrieves the data from the selected item. • Select item by index: selects the item that is located at the specified index. <hr/> <p>Note: Item index counts start at 1.</p> <hr/> <ul style="list-style-type: none"> • Select item by text selects the item that matches the specified text. <hr/> <p>Note: The Assign value field is case-sensitive.</p> <hr/> <ul style="list-style-type: none"> • Set focus • Left click: use this action if the Click action does not work during Runtime. • Right click • Double click
<p>Page Tab</p>	<ul style="list-style-type: none"> • Get property: retrieves the value of the specified object property (such as the link text) and optionally saves it to a variable. For more information, see the Object properties section. • Get total items: retrieves the number of items in the tab. • Get selected index: retrieves the item's position in the menu. <hr/> <p>Note: Item index counts start at 1.</p> <hr/> <ul style="list-style-type: none"> • Get selected text: retrieves the data from the selected item. • Select item by index: selects the item that is located at the specified index. <hr/> <p>Note: Item index counts start at 1.</p> <hr/> <ul style="list-style-type: none"> • Select item by text selects the item that matches the specified text. <hr/> <p>Note: The Assign value field is case-sensitive.</p> <hr/> <ul style="list-style-type: none"> • Left click: use this action if the Click action does not work during Runtime. • Right click • Double click <hr/> <p>Note: When you capture a Page Tab control using Microsoft UI Automation (COM) technology and perform Left click, Right click, or Double click actions on the control, the actions will click on the point of capture.</p>

Object	Actions
Password text	<ul style="list-style-type: none"> • Get property: retrieves the value of the specified object property (such as the link text) and optionally saves it to a variable. For more information, see the Object properties section. • Set text: enters text into the UI object. It supports credentials. <i>Credentials and credential variables in the Bot editor</i> • Click • Left click: use this action if the Click action does not work during Runtime. • Right click • Double click
RadioButton	<ul style="list-style-type: none"> • Get property: retrieves the value of the specified object property (such as the link text) and optionally saves it to a variable. For more information, see the Object properties section. • Get status: retrieves whether the radio button is selected. Returns selected or deselected. • Select • Set focus • Left click: use this action if the Click action does not work during Runtime. • Right click • Double click
Shell <hr/> Note: The Microsoft UI Automation (COM) technology does not support this control. <hr/>	<ul style="list-style-type: none"> • Get property: retrieves the value of the specified object property (such as the link text) and optionally saves it to a variable. For more information, see the Object properties section. • Left click: use this action if the Click action does not work during Runtime. • Right click • Double click
Slider <hr/> Note: The Microsoft UI Automation (COM) technology does not support this control. <hr/>	<ul style="list-style-type: none"> • Get property: retrieves the value of the specified object property (such as the link text) and optionally saves it to a variable. For more information, see the Object properties section. • Set position • Right click • Double click

Object	Actions
<p data-bbox="289 205 334 235">Tab</p> <hr data-bbox="289 260 571 264"/> <p data-bbox="289 268 545 394">Note: The Microsoft UI Automation (COM) technology does not support this control.</p> <hr data-bbox="289 411 571 415"/>	<ul data-bbox="587 214 1425 554" style="list-style-type: none"><li data-bbox="587 214 1425 306">• Get property: retrieves the value of the specified object property (such as the link text) and optionally saves it to a variable. For more information, see the Object properties section.<li data-bbox="587 310 753 340">• Scroll left<li data-bbox="587 344 708 373">• Select<li data-bbox="587 378 747 407">• Set focus<li data-bbox="587 411 1409 483">• Left click: use this action if the Click action does not work during Runtime.<li data-bbox="587 487 766 516">• Right click<li data-bbox="587 520 789 550">• Double click

Object	Actions
Table	<ul style="list-style-type: none"> • Deselect all • Get property: retrieves the value of the specified object property (such as the link text) and optionally saves it to a variable. For more information, see the Object properties section. • Get cell text by index: retrieves the data in the specified cell located at the row and column index. <ul style="list-style-type: none"> Note: Row and column index counts start at 1. For example, to retrieve the data in cell A2, enter 1 in the Row field and 2 in the Column field. • Get cell index by text: retrieves the index of the cell containing the specified text. <ul style="list-style-type: none"> Note: The Cell Text field is case-sensitive. • Get table: retrieves the table data and saves it to a Table variable. For more information, see Example of extracting data from a web table. <ul style="list-style-type: none"> • When you use the Microsoft UI Automation (COM) technology to capture the control, the Get table action also extracts the leftmost column and header rows in the table. • Get total rows: retrieves the number of rows that contain values. <ul style="list-style-type: none"> Note: When you use the Microsoft UI Automation (COM) technology to capture the control, the Get total rows action extracts a greater number of rows (including the header in the rows) when compared to the older technologies . • Get total columns: retrieves the number of columns that contain values. <ul style="list-style-type: none"> Note: When you use the Microsoft UI Automation (COM) technology to capture the control, the Get total columns action extracts a greater number of columns (including the leftmost column) when compared to the older technologies . • Select row • Select all • Set cell by index: enters text into the cell located at the row and column index. <ul style="list-style-type: none"> Note: Row and column index counts start at 1. For example, to enter text into cell A2, enter 1 in the Row field and 2 in the Column field. Note: For the Microsoft UI Automation (COM) technology, the row and column index counts start at 1, which includes the header row and the leftmost column. • Set cell by text: enters text into the cell containing the specified text. <ul style="list-style-type: none"> Note: The Find Text field is case-sensitive.

Object	Actions
TextBox	<ul style="list-style-type: none"> • Get property: retrieves the value of the specified object property (such as the link text) and optionally saves it to a variable. For more information, see the Object properties section. • Set focus • Set text: enters text into the UI object. It supports credentials. <i>Credentials and credential variables in the Bot editor</i> • Append text: adds text to the end of existing text in the field, instead of overwriting it. • Click • Left click: use this action if the Click action does not work during Runtime. • Right click • Double click
Toolbar <hr/> Note: The Microsoft UI Automation (COM) technology does not support this control.	<ul style="list-style-type: none"> • Get property: retrieves the value of the specified object property (such as the link text) and optionally saves it to a variable. For more information, see the Object properties section. • Left click: use this action if the Click action does not work during Runtime. • Right click • Double click
Tree (Control is displayed as a ListView) <hr/> Note: The Microsoft UI Automation (COM) technology does not support this control.	<ul style="list-style-type: none"> • Expand node: expands the current node to down to the next level of nodes. • Get property: retrieves the value of the specified object property (such as the link text) and optionally saves it to a variable. For more information, see the Object properties section. • Get total items: retrieves the number of items in the tree. • Get selected index: retrieves the item's position in the menu. <hr/> <p>Note: Item index counts start at 1.</p> <hr/> <ul style="list-style-type: none"> • Get selected text: retrieves the data from the selected item. • Select item by index: selects the item that is located at the specified index. <hr/> <p>Note: Item index counts start at 1.</p> <hr/> <ul style="list-style-type: none"> • Select item by text selects the item that matches the specified text. <hr/> <p>Note: The Assign value field is case-sensitive.</p> <hr/> <ul style="list-style-type: none"> • Set focus • Left click: use this action if the Click action does not work during Runtime. • Right click • Double click

Using the Capture action

Use the **Capture** action to capture a single interaction (click, keystroke, or mouse movement) with an object control including a text box, button, table, menu, radio button, combo box, check box, list view, link, tree, or page tab.

- To use the Recorder, you must already have done the following:
 - [Install Bot Agent and register device](#)
 - [Set user device credentials](#)
- Configure device display and font scale to 100%.

If you are using Recorder package version 2.0.6-20200626-193519 or later, you can record tasks in Google Chrome, Internet Explorer, Java, Microsoft Active Accessibility, and Microsoft UI automation applications on a computer that has display scale configured to 100%, 125%, or 150%.

- If you are automating a task using a browser, configure the zoom level to 100%.

If you are using Recorder package version 2.0.6-20200626-193519 or later, you can record tasks in a Google Chrome browser that does not have a zoom level setting of 100%.

- If you are automating a task using a Google Chrome browser, ensure that the Automation Anywhere plug-in that corresponds with the Automation 360 build version is enabled.

[Browser requirements for RPA Workspace](#)

- To automate web applications running on Microsoft Edge Chromium browser in Internet Explorer mode using the Universal Recorder, ensure that the Internet Explorer compatibility mode is enabled. The objects on the web applications are captured using HTML technology. To enable this mode, perform the following steps:
 1. On the Microsoft Edge Chromium browser page, click **Settings**.
 2. On the left panel, click **Default browser**.
 3. Navigate to the **Allow sites to be reloaded in Internet Explorer mode** option and select **Allow**.
 4. Click **Add** to add the URL of the page that you want to load in Internet Explorer mode.

Note: The pages that you add open in Internet Explorer mode for 30 days from the date when you add the page.

Considerations when recording a task:

- Use clicks when possible rather than shortcut keys.

When you click an object using the Recorder, it retrieves the object's properties that enable the bot to identify the object at runtime. Keyboard shortcuts are less reliable, so use them when it is not possible to automate the task by a clicking an object.
- If you are automating a task using a browser, do not use autofill to enter values into fields.
- Record the task at low speed.
- Avoid dragging windows during the recording process.
- Avoid clicking on applications that are not part of the process you are recording and automating.
- When Internet Explorer is used, the action waits until the browser is completely rendered and is in a ready state before executing the action.

To record a single interaction with an object control, follow these steps:

1. Double-click or drag **Recorder** > **Capture**.

2. Specify the window in which to capture an object.

Choose from the **Application**, **Browser**, or **Variable** tab.

Option	Description
Application	Select from a list of currently active windows. This option shows a list of all the application and browser windows that are open on the Bot Creator device.
Browser	Select from a list of supported browser tabs. Note: This option supports , Chromium-based , and browsers. For all other browsers, use the Application option.
Variable	Select an existing window variable to specify the title of the application window title.

3. Optional: Insert a wildcard character (*) in the **Window title** field to search for window titles that can change. You can specify one or more wildcards (*) at the start, middle, or end of the value.

For example, to perform an operation on any window that has `Microsoft` in the title, use a wildcard to indicate any string by adding it before or after the value: `*Microsoft*`. The first searches for the exact window title (`Microsoft`), and if it does not find a match, it searches for windows with the term `Microsoft` anywhere in the title.

You can use a regular expression (regex) to identify a window title. Select the regular expression condition as either **String** or a **Pattern** and then enter the value. By default, the **Window title** field is case-sensitive.

To identify a browser title, you can enable the **Case sensitive** option to match the letter case, or disable the option to identify a window title where the letter case does not match.

Note: Ensure that the minimum version installed on your system is the version that was released with v.26. If you have a version released with v.25 or earlier, then by default, the window title will be identified only with matching letter case (case-sensitive).

For example, you can enter the **String** value as `((\w*)-Notepad` for all window title names starting with `((\w*)-Notepad`, or use **Pattern** value as `((\w)\s)*document-Notepad` for only those window titles that match this pattern.

Note:

- When you use a regular expression of type **String** with `-title` as the input value for a window title in any , the might encounter a run time error. To prevent the run time error, ensure that when

you add the string input as `*-title`, the application with the specific title is open. The asterisk (*) is just a character, not a wild card character.

- When you use a regular expression of type **Pattern** with `-title` as the input value for a window title in any , the might encounter a run time error because the input value `*-title` is incorrect. Ensure that you use valid regex patterns.

Note: During runtime, verify that the TaskBot identifies the correct window. If it does not, do the following:

- a. Open the application or browser window.
- b. Drag a **Window > Get active window title** action above the **Recorder > Capture** action.
- c. Insert a string variable into the **Assign the window title to variable** field.
- d. Drag a **Window > Set title** action below the **Window > Get active window title** action.
- e. In the **Window** field, insert the window variable generated by the **Recorder > Capture** action.
- f. In the **New window title** field, insert the string variable from the **Get active window title** action.
- g. Click **Save**.

-
4. Optional: Select the **Resize window** option to specify the window dimensions.

This option delivers a more reliable bot. It resizes the window to the dimensions at which the task was recorded, which enhances the ability of the bot to identify the target object.

- If the window is maximized when you record the task, this option is not selected.
- If the window is not at the maximum size when you record the task, this option is selected, by default, and the width and height fields are automatically filled with the dimensions of the window.

Note: This option is available only for windows that can be resized. It is not available for the **Desktop** or **Taskbar** options.

-
5. Click **Capture object**.

The selected window appears.

6. Move the mouse over the object you want to automate, for example, a button, form field, or a table. A red rectangular box appears around the object.

Note: If the box does not appear and you are capturing in either the Google Chrome, Microsoft Edge, or Mozilla Firefox browsers, verify that you have enabled the Automation Anywhere extensions for these browsers. See [Google Chrome browser extension requirements](#) for Google Chrome browser.

-
7. Click the object.

8. Review the Object properties table.

Following are the list of object properties that are selected by default based on the technology type:

Important: The following list does not include all the properties and is restricted to the most commonly used and important properties based on the technology type

Technology type	Object properties	Description
HTML Technology	Control type	This is a read-only property that shows the type of object captured, for example, text box or button.
	DOMXPath	<p>It is the path that is used to locate the control or object that is captured. DOMXPath can be of two types: Relative XPath and Absolute XPath.</p> <ul style="list-style-type: none"> • Absolute XPath: It contains the complete path from the root element to the desired element. For example, an absolute XPath for this topic would be <code>/html/body/div/div[1]/main/div[2]/div/div/div[2]/div/div/div[1]/div/article/main/article/div/p[1]</code> • Relative XPath: This is a shorter path that refers to an element you want to identify. A relative path starts with a <code>//</code> symbol. For example, the relative XPath for this topic would be <code>//*[@id="cloud-using-recorder-action"]/div/p[1]</code> <p>For example, if you want to find the DOMXPath of a particular element on Google Chrome browser, perform these steps:</p> <ol style="list-style-type: none"> Select the element for which you want to extract the XPath. Right-click the element and select Inspect. Right-click the highlighted element in the Element tab. Go to Copy > Copy XPath to copy the relative path and select Copy > Copy full XPath to copy the absolute path.
	Path	It is a numeric representation of the position of a particular control in an application. For web applications, the best practise is to use DOMXPath from the search criteria when compared to Path .
	HTML name and ID	These properties are used to identify an HTML object
	HTML inner text	The DOM innerText Property is used to set or return the text content of a specified node and its descendants

Technology type	Object properties	Description
	HTML tag	HTML tags are like keywords that define the way web browser formats and displays the content. For example, if the captured text has an HTML code: <code><h3 class="search_results-title">Search results for "string package"</h3></code> , then enter h3 in the HTML tag field.
Microsoft Active Accessibility	Control type	This property is used only as a reference to ensure that the correct object is captured
	Path	It is a numeric representation of the position of a particular control in an application
	Name	This specifies a name of an element and works as an identifier
	ID	This specifies the ID of an element and works as an identifier
Java Technology	Control type	This property is used only as a reference to ensure that the correct object is captured
	Path	It is a numeric representation of the position of a particular control in an application
Microsoft UI Automation	Control type	This property is used only as a reference to ensure that the correct object is captured
	Path	It is a numeric representation of the position of a particular control in an application
	Name	This specifies a name of an element and works as an identifier
	ID	This specifies the ID of an element and works as an identifier
Microsoft UI Automation (COM)	Control type	This property is used only as a reference to ensure that the correct object is captured.
	Path	It is a numeric representation of the position of a particular control in an application.
	Name	This specifies a name of an element and works as an identifier.
	ID	This specifies the ID of an element and works as an identifier.

The bot uses the selected properties to identify the object control at runtime.

- a) Verify that the **Control Type** matches your intended object.

For example, when capturing a table from a website, ensure the **Control Type** and **HTML Tag** values are **Table**.

If the **Control Type** does not match your intended object, recapture the object control.

- b) Select and assign values to the object properties that you want to include in the object search.

For a more reliable bot, we recommend that you select only the properties that have static values (such as **Name**, **Class**, **Type**, **HTML ID**, and **DOMXPath**), and deselect the properties that

have dynamic values (such as **HTML Href, Path or Value**), which are subject to change and cause bot errors.

It is a best practice to use the wildcard character (*) or variable in object property values to search for objects whose properties are dynamic and changes frequently.

9. Select the **Action** from the drop-down list.

For a full list of possible actions by object, see [Actions performed on objects captured with Universal Recorder](#).

- If you record a click and keystrokes in a text box with a **Control Type** of `Password text`, the **Recorder** does not capture the keystrokes entered into the field. Instead, the action selects the **Set text** option and offers options to securely input the password. We recommend that you store the password in the Credential Vault and insert it into the action as a credential.

See [Credentials and credential variables in the Bot editor](#).

If you navigate to the text box using the TAB keystroke instead of a click in an MSAA or SAP application, the **Recorder** is able to identify fields with a **Control Type** of `Password text`.

- If the selected **Action** supports background processing, a **Run in the background** option appears.

See [Background processing](#).

10. Optional: Enter a value in the **Keep trying for (seconds)** field to specify the number of seconds the bot must wait for the object control to appear on the application window.

We recommend setting a delay time when using the Set text action to enter keystrokes into a text field.

Note: The timeout specified for the bot to wait for the control to appear on the application window applies only if the window in which the control is present exists. The Recorder first looks for the application window and only then searches for the object inside that window. The default time to search for the window is 30 seconds. Hence, even if you specify the wait time as 5 seconds, it still waits for 30 seconds by default if the window does not exist.

Recommendation: We recommend that you first use a wait time of 0 second and ensure that the application window exists and then specify a wait time of 5 seconds and run the bot to detect the object.

11. Optional: Assign the output to a variable.

The Control Room suggests a descriptive default variable name based on the action you selected in step 8. For example, if you selected **Get property**, the suggested output variable is `PropertyValue`. If you create several output variables, subsequent variable names are appended with a `-1` to avoid duplication.

12. Click **Save**.

The captured images are not added as dependencies and will not be displayed in the dependencies list when you check in your bot.

Link an object to a supporting anchor

Note: You can use object anchoring in Microsoft Active Accessibility, Microsoft UI Automation, or Java applications.

At runtime, if the bot cannot reliably identify an object, link it to a nearby object (such as a link or button) that is easier for the bot to find:

1. Open the **Capture** action.

2. Click the **Anchor** tab.
3. Click **Capture anchor**.

The browser or application window activates with the main object highlighted (the object that you previously captured). A dialog box appears, verifying whether the action has correctly identified the main object.
4. If the correct object is highlighted, click **Yes, Select anchor**.

Otherwise, click **No, I need to correct it** to select the correct object.
5. Select a nearby object to the target object that is easier for the bot to find.

The object is highlighted with an anchor icon on the right of the object.
6. Click **Save**.

Capture using specific technology

In some applications, the **Capture** action might not work accurately if the technology for capturing is selected automatically. In such cases, based on the type of application that you want to automate, you can select a specific technology and use the **Capture** action to capture using that technology.

Using the Capture action

To select a specific technology, click the drop-down next to **Capture object**.

You can select a specific technology and automate the following applications:

- Automate web applications that have nested iFrames with the same frame source or different frame sources.
- Capture and automate objects on applications where automatic selection of technology might not capture accurately.

Note: When you capture using a specific technology, the type and the number of object properties differ.

-
- Automate all objects and controls on the Google Chrome and Microsoft Edge browsers for local setting pages.

Note: This functionality is supported for Google Chrome and Microsoft Edge browsers.

Technology types

You can capture objects with the following technologies:

- Microsoft Active Accessibility (MSAA)
- Microsoft UI Automation
- Microsoft UI Automation (COM)

Microsoft Active Accessibility (MSAA)

Microsoft Active Accessibility is a legacy accessibility technology that was introduced as a platform add-in for Windows 95. MSAA is designed to help Assistive Technology (AT) products interact with standard and custom user interface elements of an application and also to access, identify, and manipulate an application's UI elements. MSAA is based on the Component Object Model (COM), which defines a

mechanism for applications and operating systems to communicate. To know more about the most commonly used properties in this technology, see [Using the Capture action](#).

Microsoft UI Automation

Microsoft UI Automation is an accessibility framework for Microsoft Windows, and it is available on all operating systems that support Windows Presentation Foundation (WPF). UI Automation provides programmatic access to most user interface elements on the desktop, enabling AT products such as screen readers to provide information about the UI to end users and to manipulate the UI by means other than standard input. To know more about the most commonly used properties in this technology, see [Using the Capture action](#).

Microsoft UI Automation (COM)

Microsoft UI Automation (COM) runs on unmanaged code and delivers automation faster than UI Automation. You can capture the following controls using the Microsoft UI Automation (COM) technology:

- Button
- Check box
- Client
- Combo box
- Label
- List view
- Page Tab
- Password text
- Radio button
- Table
- Text box

When you select this technology to capture an object on an application, if that object is not supported for the technology, that is indicated by a gray highlight around the object.

Note: Microsoft UI Automation (COM) provides a search criterion (property) called **Automation ID**, which is unique to this technology.

Recorder actions supported in various SAP versions

Review the information about the various actions of the Recorder package that are supported with Automation 360 and which SAP GUI versions support them.

Control name	Automation 360 supported action	SAP Logon 730 (Patch 15)	SAP Logon 740 (Patch 19)	SAP Logon 750 (Patch 10)	SAP Logon 760 (Patch 5)	SAP Logon 770 (Patch 6)
Text box (It includes controls such as: GuiCTextField, GuiTextField, GuiOkCodeField, GuiShell:TextEdit, GuiTextEdit, and GuiPasswordField)	Set text	Yes	Yes	Yes	Yes	Yes
	Append text	Yes	Yes	Yes	Yes	Yes
	Get property	Yes	Yes	Yes	Yes	Yes
	Set focus	Yes	Yes	Yes	Yes	Yes
	Left-click	Yes	Yes	Yes	Yes	Yes
	Right-click	Yes	Yes	Yes	Yes	Yes
	Double-click	Yes	Yes	Yes	Yes	Yes
Combo box It includes the control: GuiCombobox	Select item by index	Yes	Yes	Yes	Yes	Yes
	Select item by text	Yes	Yes	Yes	Yes	Yes
	Select item by key	Yes	Yes	Yes	Yes	Yes
	Expand	Yes	Yes	Yes	Yes	Yes
	Get total items	Yes	Yes	Yes	Yes	Yes
	Get selected text	Yes	Yes	Yes	Yes	Yes
	Get selected item key	Yes	Yes	Yes	Yes	Yes
	Get selected index	Yes	Yes	Yes	Yes	Yes
	Get property	Yes	Yes	Yes	Yes	Yes
	Set focus	Yes	Yes	Yes	Yes	Yes
	Left-click	Yes	Yes	Yes	Yes	Yes
	Right-click	Yes	Yes	Yes	Yes	Yes
Double-click	Yes	Yes	Yes	Yes	Yes	
Check box It includes the control: GuiCheckBox	Check	Yes	Yes	Yes	Yes	Yes
	Uncheck	Yes	Yes	Yes	Yes	Yes
	Toggle	Yes	Yes	Yes	Yes	Yes
	Get status	Yes	Yes	Yes	Yes	Yes

Control name	Automation 360 supported action	SAP Logon 730 (Patch 15)	SAP Logon 740 (Patch 19)	SAP Logon 750 (Patch 10)	SAP Logon 760 (Patch 5)	SAP Logon 770 (Patch 6)
	Get property	Yes	Yes	Yes	Yes	Yes
	Set focus	Yes	Yes	Yes	Yes	Yes
	Left-click	Yes	Yes	Yes	Yes	Yes
	Right-click	Yes	Yes	Yes	Yes	Yes
	Double-click	Yes	Yes	Yes	Yes	Yes
Button	Click	Yes	Yes	Yes	Yes	Yes
It includes the control: GuiButton	Get property	Yes	Yes	Yes	Yes	Yes
	Set Focus	Yes	Yes	Yes	Yes	Yes
	Left-click	Yes	Yes	Yes	Yes	Yes
	Right-click	Yes	Yes	Yes	Yes	Yes
	Double-click	Yes	Yes	Yes	Yes	Yes
Radio button	Select	Yes	Yes	Yes	Yes	Yes
It includes the control: GuiRadioButton	Get status	Yes	Yes	Yes	Yes	Yes
	Get property	Yes	Yes	Yes	Yes	Yes
	Set focus	Yes	Yes	Yes	Yes	Yes
	Left-click	Yes	Yes	Yes	Yes	Yes
	Right-click	Yes	Yes	Yes	Yes	Yes
	Double-click	Yes	Yes	Yes	Yes	Yes
Table It includes the control: GuiTableControl	Set cell by index	Yes	Yes	Yes	Yes	Yes
	Set cell by text	Yes	Yes	Yes	Yes	Yes
	Get cell text by index	Yes	Yes	Yes	Yes	Yes
	Get cell index by text	Yes	Yes	Yes	Yes	Yes
	Get total rows	Yes	Yes	Yes	Yes	Yes
	Get total columns	Yes	Yes	Yes	Yes	Yes
	Select row	Yes	Yes	Yes	Yes	Yes
	Select all	Yes	Yes	Yes	Yes	Yes
	Deselect all	Yes	Yes	Yes	Yes	Yes
	Get property	Yes	Yes	Yes	Yes	Yes
Set focus	Yes	Yes	Yes	Yes	Yes	

Control name	Automation 360 supported action	SAP Logon 730 (Patch 15)	SAP Logon 740 (Patch 19)	SAP Logon 750 (Patch 10)	SAP Logon 760 (Patch 5)	SAP Logon 770 (Patch 6)
	Left-click	Yes	Yes	Yes	Yes	Yes
	Right-click	Yes	Yes	Yes	Yes	Yes
	Double-click	Yes	Yes	Yes	Yes	Yes
	Get table	Yes	Yes	Yes	Yes	Yes
Menu bar It includes the control: <code>GuiMenuBar</code>	Select item by text	Yes	Yes	Yes	Yes	Yes
	Get property	Yes	Yes	Yes	Yes	Yes
	Set focus	Yes	Yes	Yes	Yes	Yes
	Left-click	Yes	Yes	Yes	Yes	Yes
	Right-click	Yes	Yes	Yes	Yes	Yes
	Double-click	Yes	Yes	Yes	Yes	Yes
	Get total items	Yes	Yes	Yes	Yes	Yes
	Select item by index	Yes	Yes	Yes	Yes	Yes
	Select item by text	Yes	Yes	Yes	Yes	Yes
Tree It includes the control: <code>GuiShell::Tree</code>	Expand node	Yes	Yes	Yes	Yes	Yes
	Get property	Yes	Yes	Yes	Yes	Yes
	Set focus	Yes	Yes	Yes	Yes	Yes
	Get total items	Yes	Yes	Yes	Yes	Yes
	Get selected index	Yes	Yes	Yes	Yes	Yes
	Get selected text	Yes	Yes	Yes	Yes	Yes
	Select item by index	Yes	Yes	Yes	Yes	Yes
	Select item by text	Yes	Yes	Yes	Yes	Yes
	Left-click	Yes	Yes	Yes	Yes	Yes
	Right-click	Yes	Yes	Yes	Yes	Yes
	Double-click	Yes	Yes	Yes	Yes	Yes

Control name	Automation 360 supported action	SAP Logon 730 (Patch 15)	SAP Logon 740 (Patch 19)	SAP Logon 750 (Patch 10)	SAP Logon 760 (Patch 5)	SAP Logon 770 (Patch 6)
Tab	Select	Yes	Yes	Yes	Yes	Yes
It includes the control: GuiTab	Scroll left	Yes	Yes	Yes	Yes	Yes
	Get property	Yes	Yes	Yes	Yes	Yes
	Set focus	Yes	Yes	Yes	Yes	Yes
	Left-click	Yes	Yes	Yes	Yes	Yes
	Right-click	Yes	Yes	Yes	Yes	Yes
	Double-click	Yes	Yes	Yes	Yes	Yes
	Grid view	Select all	Yes	Yes	Yes	Yes
It includes the control: GuiShell::GridView	Select cell by index	Yes	Yes	Yes	Yes	Yes
	Select cell by text	Yes	Yes	Yes	Yes	Yes
	Set current cell row	Yes	Yes	Yes	Yes	Yes
	Select row	Yes	Yes	Yes	Yes	Yes
	Click on cell by index	Yes	Yes	Yes	Yes	Yes
	Double-click current cell	Yes	Yes	Yes	Yes	Yes
	Get total rows	Yes	Yes	Yes	Yes	Yes
	Get total columns	Yes	Yes	Yes	Yes	Yes
	Get cell by index	Yes	Yes	Yes	Yes	Yes
	Get cell index by text	Yes	Yes	Yes	Yes	Yes
	Get property	Yes	Yes	Yes	Yes	Yes
	Set focus	Yes	Yes	Yes	Yes	Yes
	Left-click	Yes	Yes	Yes	Yes	Yes
	Right-click	Yes	Yes	Yes	Yes	Yes
	Double-click	Yes	Yes	Yes	Yes	Yes
	Get table	Yes	Yes	Yes	Yes	Yes

Control name	Automation 360 supported action	SAP Logon 730 (Patch 15)	SAP Logon 740 (Patch 19)	SAP Logon 750 (Patch 10)	SAP Logon 760 (Patch 5)	SAP Logon 770 (Patch 6)
Main window	Send VKey	Yes	Yes	Yes	Yes	Yes
It includes the control: GuiMainWindow	Get focus control ID	Yes	Yes	Yes	Yes	Yes
	Get property	Yes	Yes	Yes	Yes	Yes
	Set focus	Yes	Yes	Yes	Yes	Yes
	Left-click	Yes	Yes	Yes	Yes	Yes
	Right-click	Yes	Yes	Yes	Yes	Yes
	Double-click	Yes	Yes	Yes	Yes	Yes
	Toolbar It includes the control: Toolbar control	Click button by index	Yes	Yes	Yes	Yes
Select content menu item by text		Yes	Yes	Yes	Yes	Yes
Get property		Yes	Yes	Yes	Yes	Yes
Left-click		Yes	Yes	Yes	Yes	Yes
Right-click		Yes	Yes	Yes	Yes	Yes
Double-click		Yes	Yes	Yes	Yes	Yes
Label It includes the control: GuiLabel		Get property	Yes	Yes	Yes	Yes
	Set focus	Yes	Yes	Yes	Yes	Yes
	Left-click	Yes	Yes	Yes	Yes	Yes
	Right-click	Yes	Yes	Yes	Yes	Yes
	Double-click	Yes	Yes	Yes	Yes	Yes
Rest of the control (It includes controls such as: GuiMainWindow, GuiBox, GuiUserArea, GuiTitlebar, and GuiStatusbar)	Get property	Yes	Yes	Yes	Yes	Yes
	Set focus	Yes	Yes	Yes	Yes	Yes
	Left-click	Yes	Yes	Yes	Yes	Yes
	Right-click	Yes	Yes	Yes	Yes	Yes
	Double-click	Yes	Yes	Yes	Yes	Yes

REST Web Service package

Use the actions in the REST Web Service package as methods (DELETE, GET, PATCH, POST, or PUT) to send requests to and receive responses from an API.

Working with REST Web Service actions

Provide the following information to send a REST request and receive a response. Not all parameters are required for all methods.

- **Enter the URI:** A unique address for an API resource.
- **Proxy configuration:** To set the proxy, select the **System** or **Custom** tab from Proxy configuration.

Option	Description
System	System proxy is the proxy configured on the bot runner machine where the bot is running. If this option is selected, the Bot Agent uses the system proxy.

Option	Description
Custom	<p>This option allows you to configure custom proxy settings within the actions of REST Web Service. For example, if a REST API is required to be routed through a different proxy other than the system proxy, you can select the Custom option and provide proxy details within the REST actions.</p> <p>Provide the following details:</p> <p>Provide the following details:</p> <ul style="list-style-type: none"> • Host: The host name or IP address of the proxy • Port: The port number of the proxy • Username (Optional): The username used for the proxy authentication • Password (Optional): The password used for the proxy authentication <hr/> <p>Note: If the proxy to be configured is authenticated proxy, then you must provide authentication credentials in the Username and Password fields.</p> <hr/> <p>For Host, Port, Username, and Password fields, choose from Credential, Variable, or Insecure string tab :</p> <ul style="list-style-type: none"> • Credential: Use a value available in the credential vault. • Variable: Use a variable that stores a credential value in a user-defined variable. • Insecure string: Manually specify the value that you want to use.

- **Authentication Mode:** There are three supported authentication modes:
 - **No Authentication:** Use this option to access the endpoints that does not require authentication to access their servers.
 - **Basic:** Basic is the simplest way to authenticate users. When you select this option, you will enter the *username* and *password*. This technique uses a header called Authorization, with a base64 encoded representation of the *username* and *password* entered.
 - **Logged-in AD User:** Active Directory (AD) users that are authorized to access the related API are authenticated through AD. No credentials are required in the request.
 - **Windows NT LAN Manager (NTLM) Authentication (AD User):** A challenge/response authentication method that allows clients to provide their user name and password as encrypted credentials or plain text. We recommend that you use credentials that are stored in the Automation Anywhere Credential Vault.
- **Header:** Not all methods require a header. Headers represent the metadata associated with the request.

- **Content type:** When a header contains a content type, it defines the content negotiation between the client and the server. REST Web Service actions support the following content types:
 - `application/x-www-form-urlencoded`: Encode the parameters in the URL.
 - `JSON (application/json)`: Enter a JSON request body.
 - `XML (application/xml)`: Enter an XML request body.
 - `Text (text/plain)`
 - `XML (text/xml)`
 - `HTML (text/html)`
 - `multipart/form-data`: Send binary data, in most cases for uploading files to the server.
- **Add substitution:** Allows you to enter variables in the REST request body. A variable is a symbolic representation of data, and it enables you to access a value without having to enter it manually wherever you need it. For example, consider the following REST body request:

```
{
  "name": "{{name}}",
  "email": "{{email}}",
  "status": "Active"
}
```

In the above request body, you can replace the variables enclosed within double braces by clicking **Add substitution** and adding the required values.

- **Advanced options:**
 - **Capture failure response:** Select the check box to capture the failure response except for the `Success/Ok` response. The failure response details are captured in the response body.
 - **Allow insecure connection when using https:** Select the check box to allow insecure connection when using https.
- **Wait for action to complete:** You can set a time-out value when you send a REST request and receive a response. When performing actions such as POST, PUT, DELETE, PATCH, and GET, in the **Wait for action to complete** field, you can specify the wait time (in milliseconds). By default, the wait time is 60000 milliseconds.

- **Output variable:** The response output is captured in a dictionary variable. A dictionary variable is a key-value pair. Use the response header name as key to return the header value, or "Body" as the key to return the response body.

Note: The response key with its value is available in the dictionary variable to display the response status of the REST API.

To obtain a list of the header names for the API resource, perform these steps:

1. Insert a Loop action after the REST Web Service action.
2. Select the **For each key in the dictionary** iterator.
3. In the **Dictionary variable** field, select the variable that holds the REST Web Service action output.
4. Assign the value of each key to `prompt-assignment$`.
5. Insert a Log To File action.
6. Provide the file path to a text file to hold the list of header names.
7. Insert `prompt-assignment$` in the **Enter text to log** field.
8. Select the **Overwrite existing file** option.
9. Click **Save**.

When you run the bot, it prints the header names from the API resource to the selected file.

Passing values securely

You can securely pass values from the Credential Vault to the web service by specifying the locker, credential, and attribute in the following supported action fields:

- URI
- Custom headers
- Body: For the `application/x-www-form-urlencoded` content type, click **Add parameter** to select the value from the Credential Vault.

For all other content types, select the **Select credential as parameters** option and click **Pick**.

Actions in the REST Web Service package

Action	Description
Delete method	Removes the resource that is identified by the URI.

Action	Description
Get method	Retrieves information identified by parameters included in the URI. There is no Content type for the GET method because all the parameters are passed as part of the URI. Limitations and characteristics of the GET method include the following: <ul style="list-style-type: none"> • URI length is limited to 2048 characters. • All parameters are passed in the URI. • The GET method exposes data that is in the URI, making it less secure than the POST method. • GET does not change any data, making it safe for all users regardless of authorization. <p>See Using the Get method.</p>
Patch method	Modifies the resource that is identified by the URI.
Post method	Creates a new resource in the URI. <ul style="list-style-type: none"> • Parameters are passed in request body. • There is no limit on length for a request body. <p>See Using the Post method.</p>
Put method	Updates or replaces a resource based on parameters passed in the URI or body. See Using the Put method .

Proxy support

If your device is configured with a proxy, all outbound requests from this package are routed through the proxy server. See [Connect Bot Agent to a device with a proxy](#).

Related tasks

[Example of building a bot that uses credential variables](#)

Securely pass values to a bot using credential variables to automate the process of logging in to a bank website.

Related reference

[Credentials and credential variables in the Bot editor](#)

Use credentials when building bots to pass sensitive information such as passwords and account numbers. Using credentials separates the sensitive information from the bots and Bot Runners, which reduces the risk of data spillage or unauthorized user access.

Using the Get method

Use the **Get method** actions from the REST Web Service package to retrieve or get the information identified by parameters included in the URI .

This example uses endpoints from the Swagger Petstore sample API ([Petstore](#)) to demonstrate using Get method action to retrieve data from the Petstore database.

Note: GET method action does not take any request body.

1. Create a new .
 - a) Log in to your instance of the .

- b) On the left panel, click **Automation**.
- c) Click **Create new > Bot**.
- d) In the **Create Task Bot** window, enter the name.
- e) Accept the default folder location: `\Bots\`
To change the default storage location, click **Choose** and follow the prompts.
- f) Click **Create and edit**.

2. Use the **Get method** action to retrieve a list of all the available pets.

- a) Double-click or drag the **REST Web Services > Get method** action.

The screenshot shows the Automation Anywhere interface for configuring a REST Web Services action. The left sidebar shows the 'Actions' panel with 'REST Web Services > Get method' selected. The central flowchart shows a sequence: Start -> REST Web Services: Get method (request for URI 'https://petsto...') -> Log to file (\$Output(Body)\$ to 'C:\Temp\...') -> End. The right-hand configuration pane for 'REST Web Services: Get method' includes fields for URI (https://petstore.swagger.io/v2/pet/findByStatus), Authentication Mode (No Authentication), and Assign the output to a variable (Output).

- b) Enter the following URI:

```
https://petstore.swagger.io/v2/pet/findByStatus?status=available
```

- c) Under **Authentication Mode** drop-down, select **No Authentication** as this endpoint does not require authentication.

Note: Typically endpoint requires authentication to ensure that only authorized applications are able to access the data. Select an appropriate authentication mechanism to allow access to the endpoint you want to access.

- d) Create the variable `Output` in the **Assign the output to a variable** field. For more information on creating a variable, see [Create a variable](#).

3. Insert a **Log to file** action to see the response body.
 - a) Double-click or drag the **Log to file** action.
 - b) Provide the file path to a text file.
 - c) In the **Enter text to log** field, enter `$Output{Body}$`.
4. Click **Save** and then click **Run**.

The bot retrieves the response body and saves it to the text file.

See also

- [REST Web Service package](#)
- [Using the Post method](#)
- [Using the Put method](#)
- [Upload file with Put method](#)

Using the Post method

Use the **Post method** actions from the REST Web Service package to create new resources in the URI.

This example uses endpoints from the Swagger Petstore sample API ([Petstore](#)) to demonstrate using Post method action to add data to the Petstore database.

1. Create a new .
 - a) Log in to your instance of the .
 - b) On the left panel, click **Automation**.
 - c) Click **Create new** > **Bot**.
 - d) In the **Create Task Bot** window, enter the name.
 - e) Accept the default folder location: `\Bots\`
To change the default storage location, click **Choose** and follow the prompts.
 - f) Click **Create and edit**.

2. Use the **Post method** action to add a new pet to the store.
 - a) Double-click or drag the **REST Web Services > Post method** action.

The screenshot shows the REST-Web-Service configuration window. On the left, a flowchart is visible with a 'Start' trigger, followed by the 'REST Web Services: Post method' action (labeled 'a'), then a 'Message box \$Output/Body\$' action, and finally an 'End' action. The configuration panel on the right is titled 'REST Web Services: Post method' and includes the following fields:

- URI:** A text field containing 'https://petstore.swagger.io/v2/store/order' (labeled 'b').
- Authentication Mode:** A dropdown menu set to 'No Authentication' (labeled 'c').
- Custom parameters:** A text area containing a JSON object:

```
{
  "id": 0,
  "petId": 0,
  "quantity": 0,
  "shipDate": "2022-04-20T22:08:11.977Z",
  "status": "placed",
  "complete": true
}
```

 (labeled 'd')
- Assign the output to a variable:** A dropdown menu set to 'Output' (labeled 'e').

- b) Enter the following URI:

```
https://petstore.swagger.io/v2/store/order
```

- c) Under **Authentication Mode** drop-down, select **No Authentication** as this endpoint does not require authentication.

Note: Typically endpoint requires authentication to ensure that only authorized applications are able to access the data. Select an appropriate authentication mechanism to allow access to the endpoint you want to access.

- d) Copy and paste the following into the **Custom parameters** field, replacing the text in the angle brackets with the value that you copied from the file:

```
{
  "id": 0,
  "petId": 0,
  "quantity": 0,
  "shipDate": "2022-04-20T22:08:11.977Z",
  "status": "placed",
  "complete": true
}
```

- e) Create the variable `Output` in the **Assign the output to a variable** field. For more information on creating a variable, see [Create a variable](#).

3. Insert a **Message box** action to see the response body.
 - a) Double-click or drag the **Log to file** action.
 - b) In the **Enter the message to display** field, enter `$Output{Body}$`.
4. Click **Save** and then click **Run**.
The bot displays the response in the message box.

See also

- [REST Web Service package](#)
- [Using the Get method](#)
- [Using the Put method](#)
- [Upload file with Put method](#)

Using the Put method

Use the **Put method** actions from the REST Web Service package to update or replace existing resource. This example uses endpoints from the Swagger Petstore sample API ([Petstore](#)) to demonstrate using Put method action to update data to the Petstore database.

1. Use the **Put method** action to update the pet name to "Pluto" and pet status to "sold".
 - a) Double-click or drag the **REST Web Services > Put method** action.
 - b) Enter the following URI:

```
https://petstore.swagger.io/v2/pet
```

- c) Open the log file saved in [Using the Get method](#) and copy the Pet ID of the first entry.
- d) Copy and paste the following into the **Custom parameters** field, replacing the text in the angle brackets with the value that you copied from the file:

```
{
  "petId": 0,
  "name": "Pluto",
  "status": "sold"
}
```

- e) Insert the variable `Output` in the **Assign the output to a variable** field.
2. Move the **Message box** action below the **Put method** action:
 - a) Double-click or drag the **Message box** action.
 - b) In the **Enter text to log** field, enter `$Output{Body}$`.
 3. Click **Save** and then click **Run**.
The bot retrieves the response body and prints it to the Message box. A successful response includes `"name":"Pluto","status":"sold"`.

See also

- [REST Web Service package](#)
- [Using the Post method](#)
- [Using the Get method](#)

- *Upload file with Put method*

Upload file with Put method

Use the **Put method** action in the REST Web Service package to upload a `file` or `text`.

This example uses endpoints from the Petstore sample API (*Petstore*) to demonstrate uploading a new `file` or `text` using a `multipart/form-data`.

1. Use the **Put method** action in conjunction with an API that allows uploading a file.
 - a) Double-click or drag the **REST Web Services > Put method** action.
 - b) Enter the following URI:

```
https://petstore.swagger.io/v2/pet/112/uploadImage
```

- c) From the **Content type** drop-down, select **multipart/form-data**.

Enabled	Name	Type	Value
Yes	file	File	C:\Temp\icon.png
Yes	additionalMetadata	Text	*****

- d) Add the `file` parameter and provide the path of the file to be uploaded.
- e) Add any other required parameters. For instance, this API takes `aditonalMetadata` (for example, "hello"), which is a text input parameter. The additional parameter will also be uploaded.

2. Assign the output to a variable, for example, `Test123`.

3. Print the output in a message box.

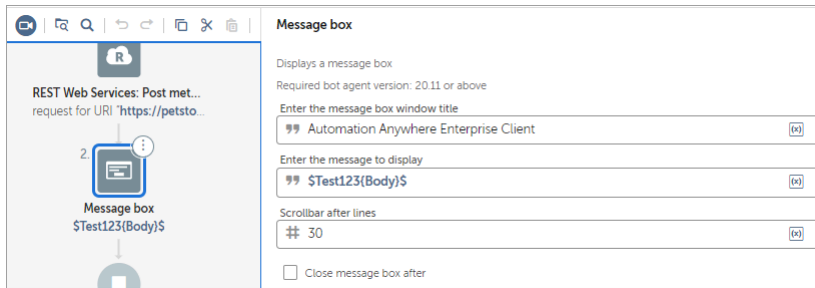

See also

- [REST Web Service package](#)
- [Using the Post method](#)
- [Using the Get method](#)
- [Using the Put method](#)

Delete method

Use the **Delete** method action in the REST Web Service package to remove a resource that is identified by the URI.

Patch method

Use the **Patch** method action in the REST Web Service package to action modify the resource that is identified by the URI.

Salesforce package

Salesforce is a cloud-based platform that provides software and services to create relevant customer experiences. Salesforce is based on a multi-tenant architecture with benefits such as API integration, configuration, scalability, free capacity, platform support, and more. The Salesforce package uses the Lightning Platform APIs to integrate Automation 360 with Salesforce.

RPA developers need to authenticate to build automation processes in Salesforce. After authentication, with the Salesforce Connected App, you can upload or download files, perform CRUD (Create/Insert, Read, Update/Upsert, Delete) operations on Objects (Salesforce stores data as Objects), and query using SQL.

The following video shows the initial authentication and command actions from Automation 360: <https://aa2019packagesdkfordocumentation.s3.us-west-2.amazonaws.com/videos/salesforce-package-title.mp4>

Two types of objects are available in Salesforce, Standard Objects and Custom Objects. Standard Objects include the configuration and default data types. Custom Objects are the objects that are defined according to business requirements. In this topic, sample CRUD operations will be based on the **Case** Object, which is a Standard Object. A *Case Object* is typically used to gather customer data (queries, feedback, or problems). All the samples are based on manipulating the fields of the *Case Object*. For more information on the *Case Object*, see [Salesforce Case object](#). All the CRUD operations are initiated from the Automation 360 side and will update data on the Salesforce side.

Salesforce Authentication action

Salesforce Authentication is the first command action that you need to call to get authenticated with the Salesforce.

Authenticate access to Salesforce by getting the authentication parameters from the Salesforce connected app and using them in Automation 360.

1. Log in to the Salesforce Enterprise Edition (Lightning Experience - *Salesforce Login*), click , and select **Setup** on your connected app. For more information about creating a new connected app, see *Configure RPA Bots for Salesforce callback integration* .
2. In the **Lightning Experience App Manager**, click **App Manager**.

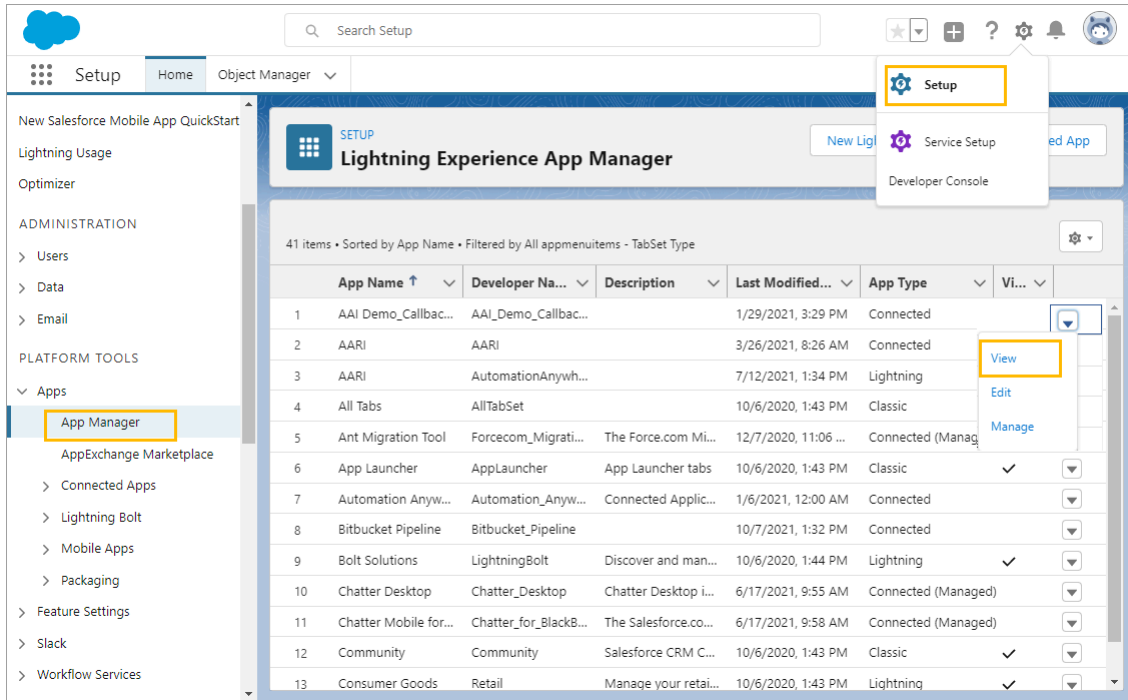

3. Click the down arrow next to app name and select **View**. The **Manage Connected Apps** screen appears. For more information about managing connected apps, see *Salesforce Connected Apps*.
4. Click **Manage Consumer Details**.
 - a) Click **Copy** that corresponds to **Consumer Key**.
 - b) Click **Copy** that corresponds to **Consumer**

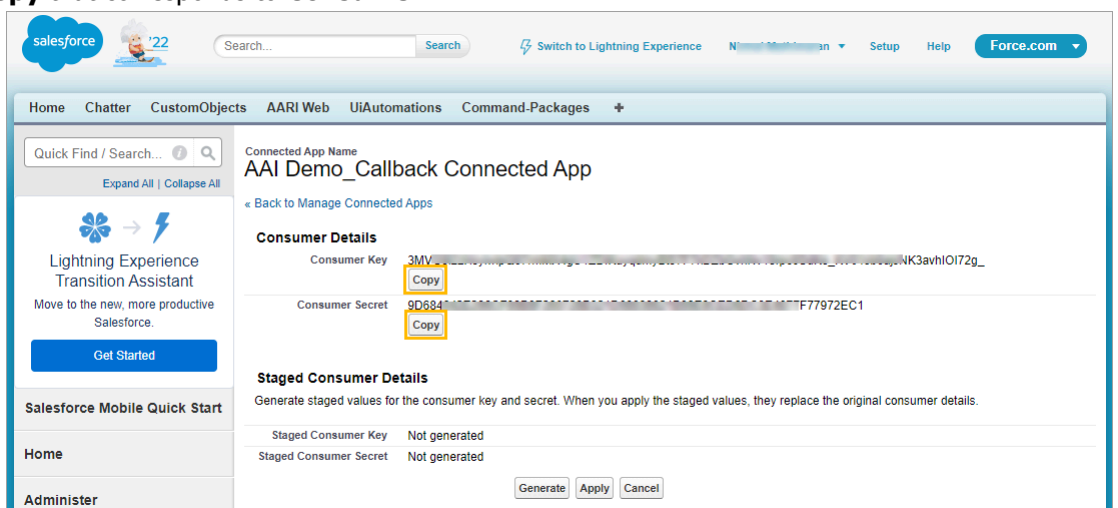

Secret.

5. Log in to the Control Room.

6. Create a new .
 - a) Log in to your instance of the .
 - b) On the left panel, click **Automation**.
 - c) Click **Create new > Bot**.
 - d) In the **Create Task Bot** window, enter the name.
 - e) Accept the default folder location: \Bots\
To change the default storage location, click **Choose** and follow the prompts.
 - f) Click **Create and edit**.

7. From the Actions pane, select **Salesforce > Authentication** and place it under the **Start** of the bot flow.

Option	Steps
<p>Client ID/Client secret/ Salesforce username/Salesforce password</p>	<p>Select one of the following options to specify the Client ID/Client secret/ Salesforce username/Salesforce password:</p> <ul style="list-style-type: none"> • Credential: Enables you to use a value available in the Credential Vault that contains information about the Client ID/Client secret/ Salesforce username/Salesforce password. • Variable: Enables you to use a credential variable that contains information about the Client ID/Client secret/ Salesforce username/Salesforce password. • Insecure string: Enables you to enter the Client ID/Client secret/ Salesforce username/Salesforce password for the Salesforce Authentication.

- a) In the **Client ID** field, paste the **Consumer Key** copied from the Salesforce Connected App. In this illustration **Insecure string** is used, while you can use **Credential** or **Variable** options for better security.
- b) In the **Client Secret** field, paste the **Consumer Key** copied from the Salesforce Connected App.

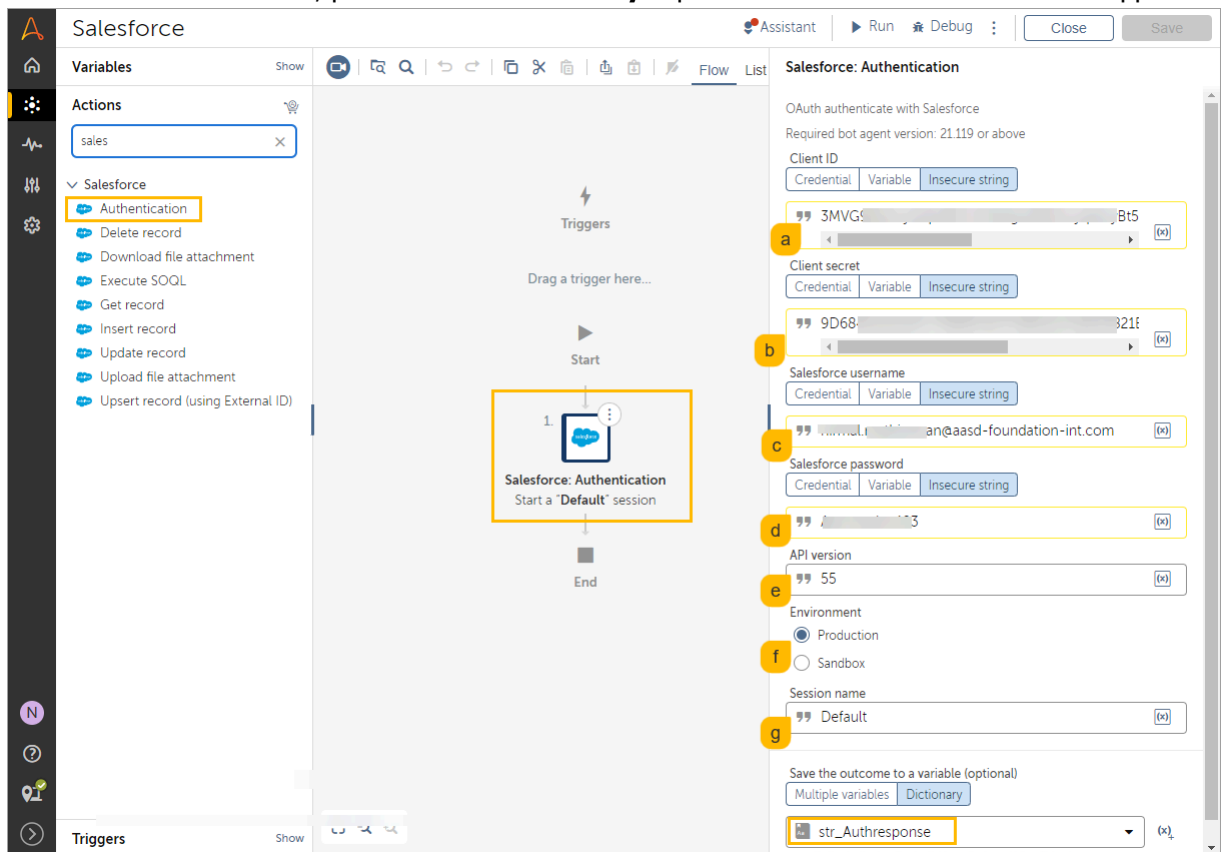

- c) Enter the *Salesforce username*.
- d) Enter the *Salesforce password*.

- e) Enter the API version. You can find the API version using the `https://MyDomainName.my.salesforce.com/services/data/" format="html" scope="external`, replace `MyDomainName` with your Salesforce URL. For more information on obtaining the Salesforce URL, see the below step.
- f) Select **Production** to log into a live environment or **Sandbox** to log into a testing environment.
- g) Enter **Default** as the Session name.

8. Create either a **Multiple** or **Dictionary** variable to store the response. You can do one of the following:

- The authentication command returns a dictionary with 2 key-value pairs. `Authorization` (credential type) and `InstanceUrl` (String type). The `Authorization` is hidden, but you will be able to read the `InstanceUrl`. For example, you can use a message box to print of the value of , ``${str_Authresponse{InstanceUrl}}$`, this returns the Salesforce URL.
- You can select Multiple variable as shown below and map to a credential variable and a string variable as keys.

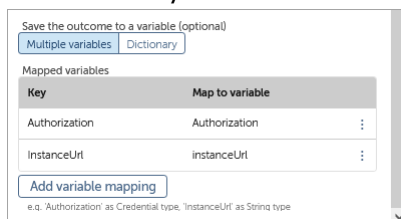

`Authorization` returns a token, which is hidden as it is a credential type, this token can be passed directly in the [Rest Web Services](#) command.

9. Click **Run** to save and run your bot. Once authenticated, you will be able to use the token to call other Salesforce API services.

Salesforce Insert record action

Use the **Salesforce Insert record** action to insert a new record into a Salesforce object along with values of the fields that should be mapped to the object's fields.

Note: Ensure that you are authenticated before calling any Salesforce action. For more information about authentication, see [Salesforce Authentication action](#).

In this tutorial, you will insert a few fields into a Salesforce object by using the **Insert record** action.

1. From the **Actions** pane, select **Salesforce > Insert record** and place it in the canvas.
2. Enter the following fields:
 - a) Enter the **Object name**, for example, **Case**.

Note: For **Salesforce Custom objects**, ensure that you provide the **API name** instead of the **Display name** of the object. For example, provide **API name: `AAIRPA__Salesforce_Connection__c`** and not the display **name: `Salesforce Connection`**

For more information on how to find the API name, see <https://help.salesforce.com/s/articleView?id=000327123&type=1>.

- b) Enter the **Fields and data** that you want to insert. Choose either **Dictionary** or **Entry list**. In this sample, **Dictionary** is selected and a few fields in **Case** object are modified. For example, **Status** is set to *New* and **Origin** is set to *Web*.

The screenshot displays the 'Salesforce: Insert record' configuration window. The workflow editor on the left shows a sequence of steps: Start, Authentication, CRUD operations, and Insert record. The 'Insert record' step is highlighted with a yellow box. The configuration panel on the right is also highlighted with yellow boxes and labeled a, b, c, and d. Label 'a' points to the 'Object name' field set to 'Case'. Label 'b' points to the 'Fields and data' section where 'Dictionary' is selected. Label 'c' points to the 'Session name' field set to 'Default'. Label 'd' points to the 'Save the outcome to a variable (optional)' dropdown set to 'Str_RecordID'.

- c) Enter **Default** as the session name.
- d) Save the outcome to a variable. For example, the object ID is saved to *Str_RecordID*.

3. Verify whether the value is inserted into Salesforce.
 - a) Find the value of the `Str_RecordID` variable in the **Debug** mode.

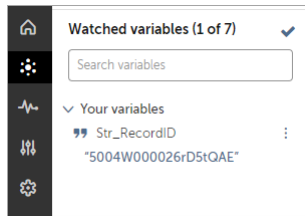

- b) In Salesforce, go to the **Case** object with the *record ID* (for example, `5004W000026rD5tQAE`) that you received as the response.

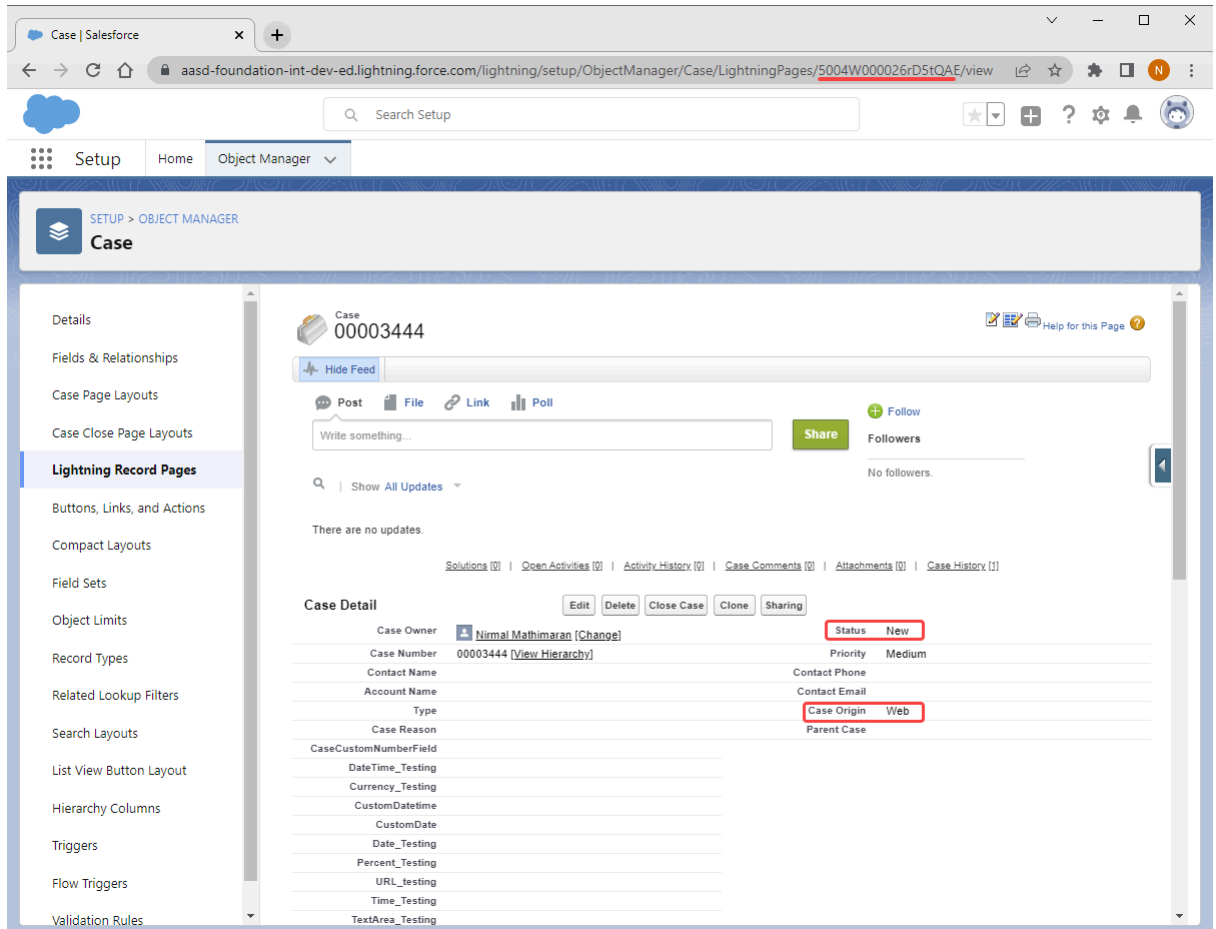

Verify whether the field's values match the input that you sent from Automation 360. For example, in this case, the *Status* is **New** and *Case Origin* is **Web**.

Salesforce Get record action

The **Salesforce Get record** action is used to read the fields of a Salesforce object.

Note: Ensure that you are authenticated before calling any Salesforce action. For more information about authentication, see [Salesforce Authentication action](#).

To read the field of a Salesforce object by using the **Get record** action, perform the following steps:

1. From the **Actions** pane, select **Salesforce > Get record** and place it in the canvas.
2. Enter the following fields:

- a) Enter the **Object name**, for example, **Case**.

Note: For **Salesforce Custom objects**, ensure that you provide the **API name** instead of the **Display name** of the object. For example, provide **API name: AAIRPA__Salesforce_Connection__c** and not the display name: *Salesforce Connection*" For more information on how to find the API name, see <https://help.salesforce.com/s/articleView?id=000327123&type=1>.

- b) Enter the **Record ID** that you want to read. You will also be able to read data using the **External ID**. For more information on **External ID**, see [Salesforce Upsert record action](#).

The screenshot displays the Salesforce bot configuration interface. On the left, the 'Actions' pane shows the 'Get record' action selected. The central canvas shows a workflow starting with 'Start', followed by 'Salesforce: Authentication', then 'Salesforce: Get record' (highlighted with a yellow box and labeled '2'), and finally 'Message box' and 'End'. The right-hand panel shows the configuration for the 'Salesforce: Get record' action. It includes fields for 'Object name' (set to 'Case'), 'Record ID / External ID' (with 'Record ID' selected and a value '5004W000026rD5tQAE' entered), 'Fields and data (optional)' (set to 'List' with 'Status' selected), and 'Save the outcome to a variable' (set to 'SFDC_Res').

- c) Select **List** for the **Fields and data (Optional)** field. Enter all the fields that you want to read. In this sample, the field **Status** is read.
- d) Save the outcome to a variable. For example, the object ID is saved to *SFDC_Res*.

3. Click **Run** to start the bot. You will be able to read the value of the field by simply printing the value in a **Message box** action. For example, in this sample, `$SFDC_Res{Status}$` will print *New*

Salesforce Update record action

Update the fields of Salesforce Objects by using the **Salesforce Update record** action.

Note: Ensure that you are authenticated before calling any Salesforce action. For more information about authentication, see [Salesforce Authentication action](#).

To update a field in a Salesforce Object by using the **Update record** action, perform the following steps:

1. From the **Actions** pane, select **Salesforce > Update record** and place it in the canvas.
2. Enter the following fields:

- a) Enter the **Object name**, for example, **Case**.

Note: For **Salesforce Custom objects**, ensure that you provide the **API name** instead of the **Display name** of the object. For example, provide **API name: AAIRPA__Salesforce_Connection__c** and not the display name: *Salesforce Connection*" For more information on how to find the API name, see <https://help.salesforce.com/s/articleView?id=000327123&type=1>.

- b) Enter the **Record ID** that you want to update.

The screenshot displays the Salesforce Automation Anywhere interface. On the left, the 'Actions' panel shows the 'Update record' action highlighted. The central canvas shows a flow with the following steps:

- Start
- Salesforce: Authentication (Start a "Default" session)
- Salesforce: Get record (Get a "Case" record with ID "5...")
- Salesforce: Update record (Update a "Case" record with I...)
- End

The configuration panel on the right for the 'Salesforce: Update record' action is shown with the following details:

- Object name: Case
- Record ID: 5004W000026rD5tQAE
- Fields and data: Entry list
- Update (1):

Field name	Field value
Status	In progress
- Session name: Default

- c) In the **Fields and data (Optional)** field, select **Entry List**. Click **Add new field/value pair to update** and enter the **Field name** that you want to update and the **Field value (optional)** that you want the field to be updated with. For example, enter Status as **Field name** and In progress as **Field value (optional)** in **Fields and data**. You can also choose **Dictionary** and enter the values as a key/value pair.
- d) Save the outcome to a variable. For example, the object ID is saved to *SFDC_Res*.
- e) Enter the **Record ID** that you want to update.

3. To start the bot, click **Run**. You can verify the update by checking it in the Salesforce side. The following video shows the process:

<https://aa2019packagesdkfordocumentation.s3-us-west-2.amazonaws.com/videos/sfdc-update.mp4>

Salesforce Delete record action

Delete records from Salesforce by using the **Salesforce Delete record** action.

Note: Ensure that you are authenticated before calling any Salesforce action. For more information about authentication, see [Salesforce Authentication action](#).

To delete a field of a Salesforce object, use the **Delete record** action.

1. From the **Actions** pane, select **Salesforce > Delete record** and place it in the canvas.
2. Enter the following fields:
 - a) Enter the **Object name**, for example, **Case**.

Note: For **Salesforce Custom objects**, ensure that you provide the **API name** instead of the **Display name** of the object. For example, provide **API name: AAIRPA__Salesforce_Connection__c** and not the display name: *Salesforce Connection*"
For more information on how to find the API name, see <https://help.salesforce.com/s/articleView?id=000327123&type=1>.

- b) Enter the **Record ID** that you want to delete.

The screenshot displays the Automation Anywhere interface for configuring a bot. On the left, the 'Actions' pane shows the 'Salesforce' category with 'Delete record' highlighted. The central 'Flow' canvas shows a sequence of steps: 'Start', 'Salesforce: Authentication' (Step 1), 'Salesforce: Delete record' (Step 2, highlighted with a yellow box and labeled '2'), and 'End'. The right-hand configuration panel for the 'Salesforce: Delete record' action is visible, showing the following fields: 'Object name for deletion' set to 'Case' (labeled 'a'), 'Record ID' set to '5004W000026rD5tQAE' (labeled 'b'), and 'Session name' set to 'Default'.

3. Click **Run** to start the bot. You will be able to verify the deletion by checking it on the Salesforce side. The following video shows the process:

<https://aa2019packagesdkfordocumentation.s3-us-west-2.amazonaws.com/videos/sfdc-delete.mp4>

Salesforce Upsert record action

Insert or update a record by using the **Salesforce Upsert record** action. The Upsert action uses a custom external ID as the key to identify a record.

Note: Ensure that you are authenticated before calling any Salesforce action. For more information about authentication, see [Salesforce Authentication action](#).

- From the **Actions** pane, select **Salesforce > Upsert record (using External ID)** and place it in the canvas.

- Enter the **Object name**, for example, **Case**.
- Enter the field name that will store the *ExternalID*.

Note: In this sample, the *ExternalID* is generated by using the **Generate random string** action.

- Enter the ExternalID generated.
- Enter the fields that you want to update.
- To verify, you can store the generated recordID in a variable. The following video demonstrates how to inserting fields to a record created in Salesforce.

<https://aa2019packagesdkfordocumentation.s3-us-west-2.amazonaws.com/videos/sfdc-upsert.mp4>

- To update a field by using the Upsert record action, from the **Actions** pane, select **Salesforce > Upsert record (using External ID)** and place it in the canvas.

8. Enter the **Object name**, for example, **Case**.

Note: For **Salesforce Custom objects**, ensure that you provide the **API name** instead of the **Display name** of the object. For example, provide **API name: AAIRPA__Salesforce_Connection__c** and not the display name: *Salesforce Connection*"
For more information on how to find the API name, see <https://help.salesforce.com/s/articleView?id=000327123&type=1>.

9. Enter the same field name that will store the *ExternalID*.

10. Enter the same *ExternalID* to refer to the same record.

11. Enter the **Field Name** and new **Field Value** to update in **Fields and data**. You can also choose **Dictionary** and enter the values as a key/value pair.

The screenshot displays the configuration for the 'Salesforce: Upsert record (using External ID)' action. The configuration panel includes the following fields and values:

- Object name:** Case
- External field name:** AAIRPA__CustomFieldForExternalId__c
- External ID:** \$ExternalID
- Fields and data:** Dictionary
- Upsert field(s) details (1):**

Field Name	Field Value
Status	Working
- Session name:** Default
- Save the outcome to a variable (optional):** Dictionary
- Variable name:** Dict_ExternalId-update

12. To verify, you can store the outcome to a variable, for example, *Dict_ExternalId-update*.

Salesforce Execute SOQL action

To search your Salesforce data for specific information, run the Salesforce Object Query Language (SOQL) command from Automation 360 by using the **Salesforce Execute SOQL** action.

SOQL is similar to Structured Query Language (SQL) but is tailored for Salesforce data. For more information about SOQL, see [Salesforce Execute SOQL](#).

To get specific information from Salesforce data, execute a query from Automation 360.

To send an SOQL query to Salesforce by using the **Execute SOQL** action, perform the following steps:

Note: Ensure that you are authenticated before calling any Salesforce action. For more information about authentication, see [Salesforce Authentication action](#).

1. From the **Actions** pane, select **Salesforce > Execute SOQL** and place it in the canvas.

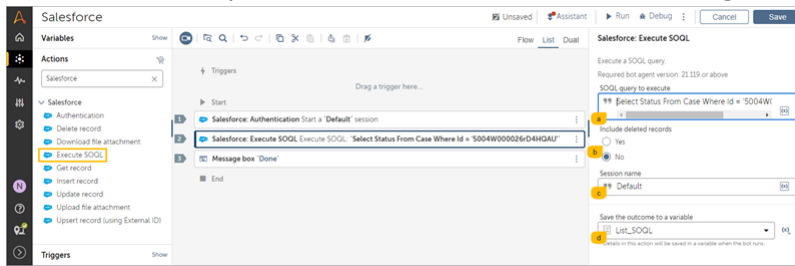

2. Enter the following fields:

- a. Enter the **SOQL query to execute**, for example, **Select Status From Case Where Id = '5004W000026rD4HQAU'**.

Note: For **Salesforce Custom objects**, ensure that you provide the **API name** instead of the **Display name** of the object. For example, provide **API name: AAIRPA__Salesforce_Connection__c** and not the display name: *Salesforce Connection*" For more information on how to find the API name, see <https://help.salesforce.com/s/articleView?id=000327123&type=1>.

- b. Select one of the following options:

1. If you want to include the deleted records, select **Yes**.
2. If you do not want to include the deleted records, select **No**.

- c. Enter **Default** as the session name.

- d. Save the outcome to a variable. For example, all the fields of the records can be stored in a list (*List_SOQL*)

3. Verify that you can run the bot in Debug mode with a breakpoint set to an action next to Execute SOQL. For example, in the sample provided previously, there is a **Message box** action. Open the *List_SOQL* variable to view the results.

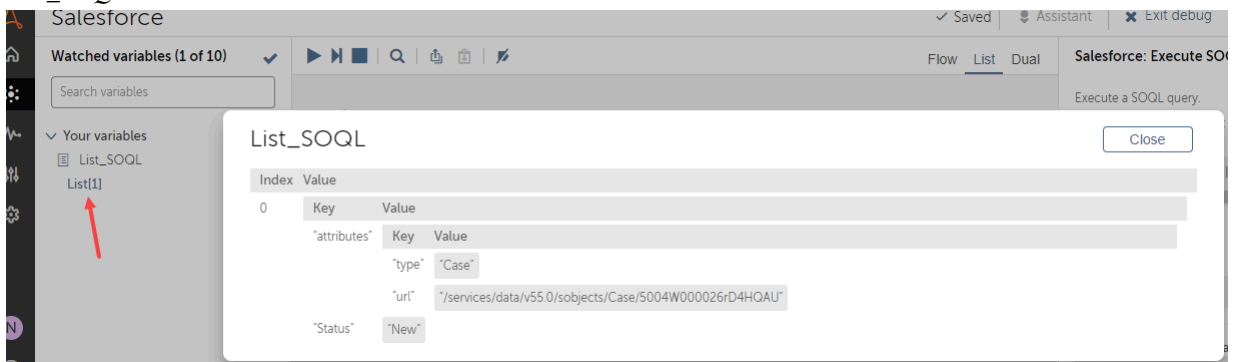

Salesforce Upload file attachment action

You can upload a file to a record in Salesforce with the **Salesforce Upload file attachment** action.

Note: Ensure that you are authenticated before calling any Salesforce action. For more information about authentication, see [Salesforce Authentication action](#).

1. From the **Actions** pane, select **Salesforce** > **Upload file attachment** and place it in the canvas.

2. Enter the following fields:

- Enter the **Object's record ID** to which you want to upload the file. For example: **'5004W000026rD4HQAU'**.
- Enter a **Content document record ID (optional)**.
It is necessary only when you want to upload a newer version of an existing file.
- Select a location from where you want to upload the file. You will be able to select one of the following:

Control Room file: When you select this option, you can select a file from your Control Room.

Desktop file: When you select this option, you can select a file from your computer. In this sample, a file is uploaded from a folder in the computer.

Variable: When you select this option, you can select variable that points to a file.

Note: Make sure that the file path that you are referring to contains the file with the exact name as entered in this field.

- Enter the **Display name (Optional)** to save the uploaded file in this name.
- Set the **Visibility** as required.

- AllUsers:** The file is available to all users who have permission to see the file.
- InternalUsers:** The file is available only to internal users who have permission to see the file.
- SharedUsers:** The file is available to all users who can see the feed to which the file is posted. **SharedUsers** is used only for files shared with users and is available only when an org has private org-wide sharing on by default. The **SharedUsers** value is available in API version 32.0 and later.

- Enter **Default** as the session name.
- Save the outcome to a variable. For example, the version of the saved document can be saved in a variable, such as *DocVersionID*.

- To verify, you can run the bot and see whether the file is uploaded to the record in the Salesforce. The following video demonstrates uploading a file from a computer to Salesforce.

<https://aa2019packagesdkfordocumentation.s3-us-west-2.amazonaws.com/videos/sfdc-upload-file-attachment.mp4>

Salesforce Download file attachment action

You can download a file from a record in Salesforce by using the **Salesforce Download file attachment** action.

Note: Ensure that you are authenticated before calling any Salesforce action. For more information about authentication, see [Salesforce Authentication action](#).

- From the **Actions** pane, select **Salesforce > Download file attachment** and place it in the canvas.
- Enter the following fields:
 - Enter the **Object's record ID** from which you want to download the file. For example: `'5004W000026rD4HQAU'`
 - Enter the **Destination folder** where you want to save the file.

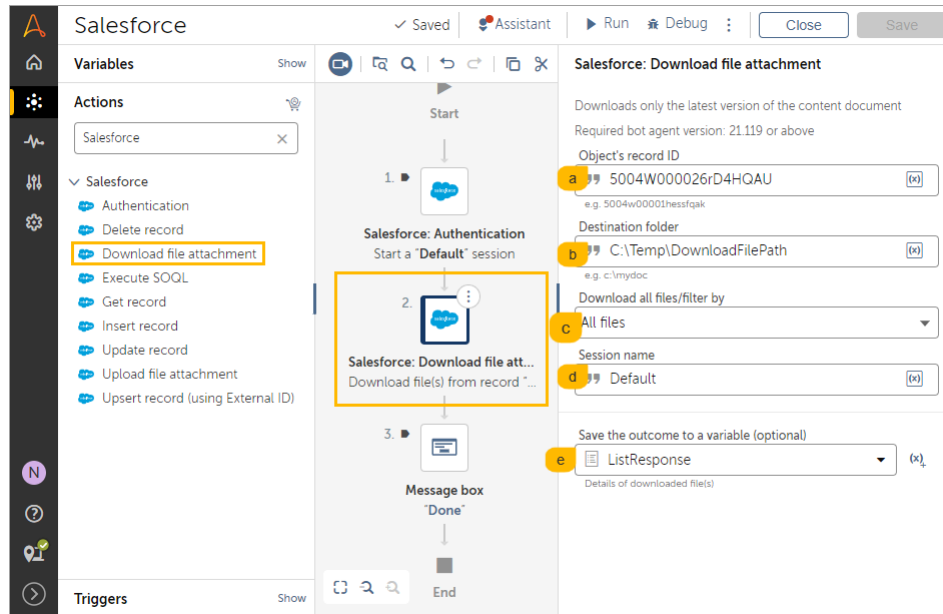

- Set **Download all files/filter by** to one of the following options:
 - All files:** Download all the attached files from a record.
 - File name:** Download a file by entering a file name.
 - File extension:** Download all the files with the same extension that you enter.
 - Content document ID:** Download a particular version of a file.
 - Enter **Default** as the session name.
 - Save the outcome to a variable. For example, the details of the downloaded files can be saved in a variable, such as `ListResponse`
- To verify, you can run the bot and whether the file is downloaded to the specified location. The following video demonstrates how to download a file from Salesforce to a location on a local system.

<https://aa2019packagesdkfordocumentation.s3-us-west-2.amazonaws.com/videos/sfdc-download-file-attachment.mp4>

Note: The file is downloaded from the *ContentDocument* Object.

SAP package

The **SAP** package contains actions to automate tasks and processes on a SAP application.

The **SAP** package enables you to perform the following tasks:

- Reduce the time required to combine data from disparate systems.
- Eliminate human error and increase efficiency.
- Increase the number of transactions processed.
- Deliver real-time information to various stakeholders.
- Enhance decision-making through comprehensive reports.

Note: In SAP **Connect** action, the **Session name** field cannot be shared with TaskBots or any other bots.

Prerequisites

- Log in to the SAP GUI before capturing objects because the SAP Logon screen is not supported for object capture.
- Enable GUI scripting and accessibility.

See [Enabling Scripting on the Client Side](#), [Enabling Scripting on the Server Side](#), and [Enabling Accessibility settings](#).

- Ensure that one of the following SAP GUI for Windows is installed on the devices that you use to automate SAP-related tasks and to run these tasks:
 - SAP GUI 750 with patch 9
 - SAP GUI 760 with patch 0
 - SAP GUI 760 with patch 1
 - SAP GUI 760 with patch 5
 - SAP GUI 770 with patch 6

Note: If SAP GUI 760 with patch 0 is installed on your device, you cannot use the SAP Grid view control **Set Table cell text** and **Get Table Cell Text** actions because of an issue with SAP GUI 760 with patch 0.

- Install a Scripting Tracker or a similar tool to retrieve the field path of the SAP object.

Before you start

Perform the following actions within the **SAP** package as part of using the set of available actions:

1. Establish a connection with the SAP application using the **Connect** action.

Log in to the SAP application using the SAP GUI application. Then use the **Connect** action from the **SAP** package to use this connection and assign a session name. Use this same session name for the other actions.

2. Use the actions to automate a task.

- After you have automated all the SAP-related tasks, terminate the connection to the SAP application using the **Disconnect** action.

Actions in the SAP package

The **SAP** package includes the following actions:

Note: The SAP and the Recorder package can detect SAP elements in the application. However, from a usability standpoint, the Recorder package is preferred over the SAP package as it is more intuitive when compared to the SAP package, such as detecting SAP Object paths automatically.

Action	Description
Check/uncheck checkbox	<i>Check/uncheck check box action</i>
Click	<i>Click action</i>
Click menu	<i>Click menu action</i>
Connect	<i>Using Connect action for SAP.</i>
Disconnect	<i>Disconnect action</i>
Double click	<i>Double click action</i>
Expand	<i>Expand action</i>
Export table	<i>Using Export table action.</i>
Get cell count	<i>Get cell count action</i>
Get children name	<i>Get children names action</i>
Get children text	<i>Get children text action</i>
Get column count	<i>Get column count action</i>
Get row count	<i>Get row count action</i>
Get selected item	<i>Get selected item action</i>
Get status	<i>Get status action</i>
Get table cell index	G <i>Get table cell index action</i>
Get table cell text	<i>Get table cell text action</i>
Get text	<i>Get text action</i>
Get item count	<i>Get item count action</i>

Action	Description
Left click	<i>Left click action</i>
Right click	<i>Right click action</i>
Select item	<i>Select item action</i>
Select radio option	<i>Select radio option action</i>
Send virtual key	<i>Virtual keys in SAP GUI</i> <i>Send virtual key action</i>
Set table cell text	<i>Set table cell text.</i>
Set text	<i>Set text action</i>

Check/uncheck check box action

The Check/uncheck check box action in the SAP package enables you to select or clear a check box in a SAP window.

Settings

- In the **Session name** field, enter the session name you used to connect to the SAP application in the **Connect** action.
- In the **Field path** field, specify the location or a string variable that contains the location of the object.
- In the **Action** option, select **Check**, **Uncheck**, or **Toggle**.

Click action

The Click action in the SAP package enables you to perform a click operation.

Settings

- In the **Session name** field, enter the session name you used to connect to the application in the **Connect** .
- In the **Field path** field, specify the location or a string variable that contains the location of the object.

Click menu action

The Click menu action in the SAP package enables you to click a menu item by text or index in a SAP window.

Settings

- In the **Session name** field, enter the session name you used to connect to the application in the **Connect** .

- In the **Field path** field, specify the location or a string variable that contains the location of the object.
- In the **Select** option, select **Name** or **Index** to specify the name or index of the menu item.

Using Connect action for SAP

Use the **Connect** action to establish a connection with a SAP system that you want to use to automate SAP-related tasks. This must be the first action you use to automate an SAP-related task.

1. In the **Actions** palette, double-click or drag the **Connect** action from the **SAP** package.
2. Specify a name for the session in the **Session name** field.
3. Select an option to specify the connection type:
 - a) If you have selected **Automatic**, no additional information is required to connect to the SAP application.

You must be already logged on to SAP logon application as the system uses the available SAP session to connect to a SAP system.
 - b) If you have selected **SAP GUI**, you must manually provide the following details:
 - **Name:** Specify the value in the **Name** field. The value must be same as entered in the **Description** field of the SAP logon system connection parameters.
 - **Client:** Specify a value for the client identifier. You can enter a value of 0 through 999.
 - **User name:** Click the **Credential** tab to select an entry from the Credential Vault. You can also click the **String** tab to enter a value manually.
 - **Password:** Click the **Credential** tab to select an entry from the Credential Vault. You can also click the **String** tab to enter a value manually.
 - **Language:** Specify the two-letter code for the language set on the SAP server.
4. Click **Save**.

Related tasks

[Using Export table action](#)

Use the **Export table** action to export a table to a datatable or CSV file.

[Using Set table cell text action](#)

Use the **Set table cell text** action to set the text in a specific cell of a table or a grid.

Related reference

[SAP package](#)

The **SAP** package contains actions to automate tasks and processes on a SAP application.

Disconnect action

The Disconnect action in the SAP package enables you to terminate the connection to the SAP application.

Settings

In the **Session name** field, enter the session name you used to connect to the application in the **Connect** .

Double click action

The Double click action in the SAP package enables you to perform a double-click operation on a SAP window.

Settings

- In the **Session name** field, enter the session name you used to connect to the application in the **Connect** .
- In the **Field path** field, specify the location or a string variable that contains the location of the object.

Expand action

The Expand action in the SAP package enables you to expand the item by text or index on a SAP window.

Settings

- In the **Session name** field, enter the session name you used to connect to the application in the **Connect** .
- In the **Field path** field, specify the location or a string variable that contains the location of the object.
- In the **Select** option, select **Text** or **Index** to specify the text or index of the item.

Using Export table action

Use the **Export table** action to export a table to a datatable or CSV file.

To export a table, follow these steps:

1. In the **Actions** palette, double-click or drag the **Export table** action from the **SAP** package.
2. In the **Session name** field, enter the session name you used to connect to the SAP application in the **Connect** action.
3. In the **Field path** field, specify the location or a string variable that contains the location of the object.

You can use Recorder capture action to capture SAP controls and retrieve the field path or install a Scripting Tracker or a similar tool to retrieve the field path of the SAP object.

4. In the **Export As** option, select **CSV** or **Datatable** to specify the export option of the table cell:

Choice	Steps
CSV	<ol style="list-style-type: none"> a. In the File Path field, specify the location or file variable. b. Optional: In the Encoding field, specify the value. c. Select the Export data with header check box to export with header. d. In the When saving field, select Append to existing log file or Overwrite existing log file to append the log file or overwrite the content within the log file.
Datatable	In the Datatable field, specify the value.

5. Click **Save**.

Get cell count action

The Get cell count action in the SAP package enables you to get number of cells in a table or grid.

Settings

- In the **Session name** field, enter the session name you used to connect to the application in the **Connect** .
- In the **Field path** field, specify the location or a string variable that contains the location of the object.
- In the **Assign the output to a variable** field, specify the variable.

Get children names action

The Get children names action in the SAP package enables you to get children control names.

Settings

- In the **Session name** field, enter the session name you used to connect to the application in the **Connect** .
- In the **Field path** field, specify the location or a string variable that contains the location of the object.
- In the **Assign the output to list variable** field, specify the list variable.

Get children text action

The Get children text action in the SAP package enables you to get the text associated with children control.

Settings

- In the **Session name** field, enter the session name you used to connect to the application in the **Connect** .
- In the **Field path** field, specify the location or a string variable that contains the location of the object.
- In the **Assign the output to list variable** field, specify the list variable.

Get column count action

The Get column count action in the SAP package enables you to get number of columns in a table or grid.

Settings

- In the **Session name** field, enter the session name you used to connect to the application in the **Connect** .
- In the **Field path** field, specify the location or a string variable that contains the location of the object.
- In the **Assign the output to a variable** field, specify the variable.

Get row count action

The Get row count action in the SAP package enables you to get number of rows in a table or grid.

Settings

- In the **Session name** field, enter the session name you used to connect to the application in the **Connect** .

- In the **Field path** field, specify the location or a string variable that contains the location of the object.
- In the **Assign the output to a variable** field, specify the variable.

Get selected item action

The Get selected item action in the SAP package enables you to get selected item index from a combo box, page tab, or a tree view control.

Settings

- In the **Session name** field, enter the session name you used to connect to the application in the **Connect** .
- In the **Field path** field, specify the location or a string variable that contains the location of the object.
- In the **Assign the output to a variable** field, specify the variable.

Get status action

The Get status action in the SAP package enables you to get status of a radio button or check box.

Settings

- In the **Session name** field, enter the session name you used to connect to the application in the **Connect** .
- In the **Field path** field, specify the location or a string variable that contains the location of the object.
- In the **Assign the output to a variable** field, specify the variable.

Get table cell index action

The Get table cell index action in the SAP package enables you to get table cell index for text.

Settings

- In the **Session name** field, enter the session name you used to connect to the application in the **Connect** .
- In the **Field path** field, specify the location or a string variable that contains the location of the object.
- In the **Search text** field, specify the text.
- Select the **Case sensitive search** option to specify a case-sensitive search.
- Select the **All occurrences** check box.
- In the **Assign the output to a variable** field, specify the variable.

Get table cell text action

The Get table cell text action in the SAP package enables you to get table cell text by index.

Settings

- In the **Session name** field, enter the session name you used to connect to the application in the **Connect** .

- In the **Field path** field, specify the location or a string variable that contains the location of the object.
- In the **Row** field, specify the number of row from which you want to get the text.
- In the **Column** field, specify the number of column from which you want to get the text.
- In the **Assign the output to a variable** field, specify the variable.

Get text action

The Get text action in the SAP package enables you to get text from a text box, label, or status bar.

Settings

- In the **Session name** field, enter the session name you used to connect to the application in the **Connect**.
- In the **Field path** field, specify the location or a string variable that contains the location of the object.
- In the **Assign the output to a variable** field, specify the variable.

Get item count action

The Get item count action in the SAP package enables you to get the count of items in a combo box, page tab, or tree view control.

Settings

- In the **Session name** field, enter the session name you used to connect to the application in the **Connect**.
- In the **Field path** field, specify the location or a string variable that contains the location of the object.
- In the **Assign the output to a variable** field, specify the variable.

Left click action

The Left click action in the SAP package enables you to perform a left-click operation.

Settings

- In the **Session name** field, enter the session name you used to connect to the application in the **Connect**.
- In the **Field path** field, specify the location or a string variable that contains the location of the object.

Right click action

The Right click action in the SAP package enables you to perform a right-click operation.

Settings

- In the **Session name** field, enter the session name you used to connect to the application in the **Connect**.
- In the **Field path** field, specify the location or a string variable that contains the location of the object.

Select item action

The Select item action in the SAP package enables you to select an item by text or index.

Settings

- In the **Session name** field, enter the session name you used to connect to the application in the **Connect** .
- In the **Field path** field, specify the location or a string variable that contains the location of the object.
- In the **Select** option, select **Text** or **Index** to specify the text or index of the item.

Select radio option action

The Select radio option action in the SAP package enables you to select the radio button in a SAP window.

Settings

- In the **Session name** field, enter the session name you used to connect to the application in the **Connect** .
- In the **Field path** field, specify the location or a string variable that contains the location of the object.

Send virtual key action

The Send virtual key action in the SAP package enables you to send a virtual key.

Settings

- In the **Session name** field, enter the session name you used to connect to the application in the **Connect** .
- In the **Select** list, select a key.
See *Virtual keys in SAP GUI*.

Using Set table cell text action

Use the **Set table cell text** action to set the text in a specific cell of a table or a grid.

To set a value in a table cell, follow these steps:

1. In the **Actions** palette, double-click or drag the **Set table cell text** action from the **SAP** package.
2. In the **Session name** field, enter the session name you used to connect to the SAP application in the **Connect** action.
3. In the **Field path** field, specify the location or a string variable that contains the location of the object.
4. In the **Select** option, select **Text** or **Index** to specify the text or index of the table cell:
 - **Text:** In the **Find Text** field, specify the value.
The system searches for the cell that contains the value.
 - **Index:** In the **Row** and **Column** fields, specify the value.
5. In the **Set Text** field, enter the text to set the table cell.

6. Click **Save**.

Set text action

The Set text action in the SAP package enables you to set the text in an editable field.

Settings

- In the **Session name** field, enter the session name you used to connect to the application in the **Connect**.
- In the **Field path** field, specify the location or a string variable that contains the location of the object.
- In the **Field value** field, specify the text.

Note: You can set the fields to any value, including blank values, for example, text field or date field.

- Select the **Append text** check box.

SAP BAPI package

The **SAP BAPI** package contains actions to automate tasks and processes using SAP Business Application Programming Interface (BAPI). BAPI is a standardized method that enables a third-party application to interact with an SAP system.

Overview of SAP BAPIs

Business Application Programming Interfaces (BAPIs) are APIs that enable external applications to access SAP business objects.

Typically, a BAPI consists of the following parameters:

- **Import parameters:** Used to receive data from the calling applications.
- **Export parameters:** Used to return data to the calling application.
- **Import/export table parameters:** Tables used for both receiving data and returning data.

A parameter can be of the following type:

- **Data element:** Scalar data type
- **Structure:** Typically contains multiple fields

If an import parameter is of the type structure, you can pass multiple values as key-value pairs.

- **Table:** A data structure that contains more than one row

For a BAPI method to work, the calling application can call the method in a BAPI using the following:

- BAPI name
- Import parameters (scalar, structure, table)
- Export parameters (scalar, structure, table)

Before you start

Perform the following actions within the **SAP BAPI** package as part of using the set of available actions:

1. Establish a connection with the SAP application using the **Connect** action.

2. Use the **Create function** action to create a user-defined function for the specified SAP BAPI function. Select the **Begin sequence** option to mark the start of a process followed by the actions to automate a task.
3. Use the **Run function** action to run the function you have created using the **Create function** action. Select the **End sequence** option to mark the end of a process and the **Commit transaction** option to commit the changes.

Actions in the SAP BAPI package

The **SAP BAPI** package includes the following actions:

Action	Description
Connect	<i>Using Connect action for SAP BAPI.</i>
Create function	<i>Create function action .</i>
Get field value	<i>Get field value action .</i>
Get structure	<i>Get structure action .</i>
Get table	<i>Get table action .</i>
Run function	<i>Run function action .</i>
Set field value	<i>Set field value action .</i>
Run standard workflow	<i>Run standard workflow action .</i>
Run custom workflow	<i>Run custom workflow action .</i>

Build sample bots using the SAP BAPI package

If you are getting started with the SAP BAPI package, a good place to start is to build some sample bots with the help of the following tutorials. The tutorials are intended to train you on how to use various actions from the SAP BAPI package to invoke SAP BAPIs, pass import parameters, and retrieve data from export parameters.

- *Example of using Get structure command from SAP BAPI package:* In this tutorial, you will build a that invokes BAPI_FLIGHT_GETLIST from the SAP demo Flight Data application. When executed, the calls the BAPI function by inputting an airline ID and destination details, gets a list of flights, and writes the response data to a CSV file.
- *Example of writing data to SAP using SAP BAPI package:* In this tutorial, you will build a that invokes BAPI_FLICUST_CREATEFROMDATA from the SAP demo Flight Data application. You will use the CUSTOMER_DATA import parameter to pass the customer data to the BAPI. When executed, the creates a new customer record in SAP database and displays the customer number returned by the BAPI.
- *Example of using Run standard workflow from SAP BAPI package:* In this tutorial, you will build a bot that uses a single action to select a BAPI from a list of function modules, to set import parameters, and to get the response data. When executed, the bot gets flight availability data based on the input data, and writes it to a CSV file.

Using Connect action for SAP BAPI

Use the **Connect** action to establish a connection with a SAP system that you want to use to automate SAP-related tasks using SAP Business Application Programming Interface (BAPI). This must be the first action you use to automate an SAP-related task using SAP BAPI.

Download the SAP Java connector package and DLL from the SAP website.

1. In the **Actions** palette, double-click or drag the **Connect** action from the **SAP** package.
2. Specify a name for the session in the **SAP BAPI Session** field.
3. Select one of the following options to specify the location of the SAP Java connector package:
 - **Control Room file:** Enables you to select the SAP Java connector package that is available in a folder in the Control Room.
 - **Desktop profile:** Enables you to select the SAP Java connector package that is available on your device.
 - **Variable:** Enables you to specify the file variable that contains the location of the SAP Java connector package.
4. Select one of the following options to specify the location of the SAP JCo DLL dependency:
 - **Control Room file:** Enables you to select the SAP Java connector DLL that is available in a folder in the Control Room.
 - **Desktop profile:** Enables you to select the SAP Java connector DLL that is available on your device.
 - **Variable:** Enables you to specify the file variable that contains the location of the SAP Java connector DLL.
5. Select one of the following options to specify the connection type:

Option	Steps
Custom Application Server	Select one of the following options to specify the SAP server hostname: <ul style="list-style-type: none"> • Credential: Enables you to use a value available in the Credential Vault that contains information about the SAP server hostname. • Variable: Enables you to use a credential variable that contains information about the SAP server hostname. • Insecure string: Enables you to enter the hostname for the SAP server.

Option	Steps
Group/Server	<p>a. Select one of the following options to specify the SAP message server hostname:</p> <ul style="list-style-type: none"> • Credential: Enables you to use a value available in the Credential Vault that contains information about the SAP message server hostname. • Variable: Enables you to use a credential variable that contains information about the SAP message server hostname. • Insecure string: Enables you to specify the hostname for the SAP message server. <p>b. Optional: Specify the gateway host you want to use to connect to the server in the Gateway host field.</p> <p>c. Optional: Specify the logon group you want to use to connect to the server in the Logon group field.</p>

6. Enter values for the following:

- System number
- **Optional:** SAP instance system ID
- Client number
- Logon language code
- **Optional:** Router string
- Select one of the following options to specify the username you want to use to connect to the SAP server:
 - **Credential:** Enables you to use a value available in the Credential Vault that contains the username.
 - **Variable:** Enables you to use a credential variable that contains the username.
 - **Insecure string:** Enables you to enter the username.
- Select one of the following options to specify the password you want to use to connect to the SAP server:
 - **Credential:** Enables you to use a value available in the Credential Vault that contains the password.
 - **Variable:** Enables you to use a credential variable that contains the password.
 - **Insecure string:** Enables you to enter the password.

7. Click **Save**.

Create function action

The Create function action in the SAP BAPI package enables you to create an alias for a SAP BAPI function and saves it with an alias name.

Settings

You can use the alias name in other actions to use that BAPI function in those actions.

- In the **Session name** field, enter the session name you used to connect to the SAP application in the **Connect** action.
- In the **Function alias name** field, enter the alias that you want to use for the BAPI function.
- In the **BAPI name** field, enter name of the SAP BAPI function for which you want to create the alias.
- Select the **Begin sequence** option if you want to execute the BAPI in a particular sequence to mark the start of a process.

Get field value action

The Get field value action in the SAP BAPI package enables you to obtain data of a specific field from a function, table, or structure.

Settings

- In the **BAPI function alias** field, enter the alias you have provided for SAB BAPI function using the **Create function** action.
- Select one of the following option to specify whether you want to obtain data from a function, table, or structure:

- **Function:** Enables you to get the value of a field from a function.
- **Table:** Enables you to get the value of a field from a table in a SAP BAPI function.

You must specify the **Table alias** from which you want to obtain data.

You must use the **Get table** action before you use the **Get field** action to obtain the value of a field from a table in a SAP BAPI function. You must also specify the **Table alias** from which you want to get data.

- **Structure:** Enables you to obtain data from a structure in a SAP application.

You must use the **Get structure** action before you use the **Get field** action to obtain the value of a field from a structure in a SAP BAPI function. You must also specify the **Table alias** from which you want to obtain data.

- In the **Field name** field, enter the name of the field from which you want to get data.
- In the **SAP BAPI Session** field, enter the session name you used to connect to the SAP application in the **Connect** action.
- In the **Save the output to a variable** field, specify a string variable.

Get structure action

The Get structure action in the SAP BAPI package enables you to obtain table data from a structure using the function alias.

Settings

- In the **BAPI function alias** field, enter the alias you have provided for SAB BAPI function using the **Create function** .
- In the **Structure name** field, enter the name of the structure from which you want to get data.
- In the **SAP BAPI Session** field, enter the session name you used to connect to the application in the **Connect** .
- Select one of the following options to specify how you want to save the data retrieved from the structure:
 - **Alias**: Enables you to provide an alias for the structure and use the alias in other actions.
 - **Variable**: Enables you to store the data retrieved from the structure in a table variable.

Get table action

The Get table action in the SAP BAPI package enables you to get tabular data from a table using the function alias.

Settings

- In the **BAPI function alias** field, enter the alias you have provided for SAB BAPI function using the **Create function** .
- In the **Table name** field, enter the name of the table from which you want to obtain data.
- In the **SAP BAPI Session** field, enter the session name you used to connect to the application in the **Connect** .
- Select one of the following options to specify how you want to save the data retrieved from the table:
 - **Alias**: Enables you to provide an alias for the table and use the alias in other actions.
 - **Variable**: Enables you to store the data retrieved from the table in a table variable.

Run function action

The Run function action in the SAP BAPI package enables you to run the SAP BAPI function.

Settings

- In the **BAPI function alias** field, enter the alias you have provided for SAB BAPI function using the **Create function** .
- Select the **End sequence** option to mark the end of a process and the **Commit transaction** option to commit the changes made during the process.

If you want to end a sequence, you must select the **Begin sequence** option from the **Create function** action. If you have used queued Remote Function Call (qRFC), you must select the **Commit transaction** option to commit the changes you have made.

- In the **SAP BAPI Session** field, enter the session name you used to connect to the application in the **Connect** .

Set field value action

The Set field value action in the SAP BAPI package enables you to set data into a function, table, or structure using the function alias.

Settings

- In the **BAPI function alias** field, enter the alias you have provided for SAB BAPI function using the **Create function** .
- Select one of the following options to specify whether you want to set data in a function, table, or structure:

- **Function:** Enables you to set data in a function.
- **Table:** Enables you to set data in a table in a SAP application.

You must use the **Get table** action before you use the **Get field** action to obtain the value of a field from a table in a SAP BAPI function. You must specify the **Table alias** in which you want to set data. You can also select the **Create new row** option if you want to create a new row in the table and set value in that row.

- **Structure:** Enables you to set data in a structure in a SAP application.

You must use the **Get structure** action before you use the **Get field** action to obtain the value of a field from a structure in a SAP BAPI function. You must also specify the **Structure alias** from which you want to get data.

- In the **Field name** field, enter the name of the field in which you want to set data.
- In the **Field Value** field, enter the value that you want to set.
- In the **SAP BAPI Session** field, enter the session name you used to connect to the application in the **Connect** .

Run standard workflow action

The Run standard workflow action in the SAP BAPI package enables you to run a standard workflow in SAP BAPI.

Settings

- Use the **Select workflow** option to select the workflow from the **Standard BAPI Selector** dialog box.
- The **Import to BAPI** section displays the import parameters for the selected workflow. You can select the **Edit** option from the action menu (vertical ellipsis) to specify a value for the parameters.
 - Select the **Include** option if you want to use that import parameter.
 - Select the **Table** tab to select a table variable containing the values you want to import to BAPI. Alternatively, select the **Strings** tab to specify the value manually.
- The **Export to BAPI** section displays the export parameters for the selected workflow. You can select the **Edit** option from the action menu (vertical ellipsis) to specify a value for the parameters.
 - Select the **Include** option if you want to use that export parameter.

- The **Tables** section displays the tables you can use as export or import parameters for your selected workflow. You can select the **Edit** option from the action menu (vertical ellipsis) to specify a value for the tables.
 - Select the **Include** option if you want to use that table as an export or import parameter.
 - Select either the **Import** tab to use a table as an import parameter or select the **Export** tab to use a table as an export parameter.
 - Select the **Table** tab to select a table variable containing the values you want to import to BAPI. Alternatively, select the **Strings** tab to specify the value manually.
- Select the **Begin sequence** option if you want to execute the BAPI in a particular sequence to mark the start of a process.
- Select the **End sequence** option to mark the end of a process.
- Select the **Commit transaction** option to commit the changes made during the process.
- In the **SAP BAPI Session** field, enter the session name you used to connect to the application in the **Connect** .
- In the **Save exported structures and scalars** field, specify a dictionary variable.
- In the **Save exported tables** field, specify a dictionary variable.

Run custom workflow action

The Run custom workflow action in the SAP BAPI package enables you to run a custom workflow in SAP BAPI.

Settings

- Select the custom workflow you want to run from the **Select Custom workflow** list.
- The **Import to BAPI** section displays the import parameters for the selected workflow. You can select the **Edit** option from the action menu (vertical ellipsis) to specify a value for the parameters.
 - Select the **Include** option if you want to use that import parameter.
 - Select the **Table** tab to select a table variable containing the values you want to import to BAPI. Alternatively, select the **Strings** tab to specify the value manually.
- The **Export to BAPI** section displays the export parameters for the selected workflow. You can select the **Edit** option from the action menu (vertical ellipsis) to specify a value for the parameters.
 - Select the **Include** option if you want to use that export parameter.
- The **Tables** section displays the tables you can use as export or import parameters for your selected workflow. You can select the **Edit** option from the action menu (vertical ellipsis) to specify a value for the tables.
 - Select the **Include** option if you want to use that table as an export or import parameter.
 - Select either the **Import** tab to use a table as an import parameter or select the **Export** tab to use a table as an export parameter.
 - Select the **Table** tab to select a table variable containing the values you want to import to BAPI. Alternatively, select the **Strings** tab to specify the value manually.
- Select the **Begin sequence** option if you want to execute the BAPI in a particular sequence to mark the start of a process.
- Select the **End sequence** option to mark the end of a process.
- Select the **Commit transaction** option to commit the changes made during the process.
- In the **SAP BAPI Session** field, enter the session name you used to connect to the application in the **Connect** .
- In the **Save exported structures and scalars** field, specify a dictionary variable.

- In the **Save exported tables** field, specify a dictionary variable.

Screen package

Use the **Screen** package to automate the process of capturing screenshots. Using the actions in this package, you can capture an area of an application window, the entire computer screen, or an active open window and save it in a specified location in an image format.

Actions in the Screen package

The **Screen** package includes the following actions:

Action	Description
Capture area	Captures specified area of an open application. See Using Capture area action from Screen package
Capture desktop	Captures an image of the full desktop. <ul style="list-style-type: none"> • In the File path to save image field, specify the path where you want to save the captured image. The following file extensions are supported: png, bmp, jpeg, tiff, gif, and wmf. • Select Overwrite file check box to overwrite an existing file with the same name.
Capture window	Captures screenshots of an open application window. See Using Capture window action from Screen package

Secure recording

When secure recording mode is enabled, bots do not display the target object images after capture. This ensures that sensitive data is not shown.

Note: Although the bots do not display the target images after capture, the images are still stored in the Control Room because they are required to run the bots.

When you record a task in secure recording mode, the **Preview** window temporarily shows an image of the captured area. This image is hidden after you navigate away from the Bot editor window or refresh it.

A user with admin privileges must enable this setting. See [Settings](#).

Related reference

[Screen resolution dependent packages](#)

The screen resolution between the Bot Runner and Bot Creator device should be consistent as when resolution-dependent packages are used to build bots, any screen resolution difference between the Bot Creator and Bot Runner device will impact the bots during runtime.

Using Capture area action from Screen package

Use the **Capture area** action in the Screen package to capture a screenshot of the application window area.

To capture a specified area of an application window, perform these steps:

1. In the **Actions** palette, double-click or drag the **Capture area** action from the Screen package.
2. Specify the window in which to capture an object.

Choose from the **Application**, **Browser**, or **Variable** tab.

Option	Description
Application	Select from a list of currently active windows. This option shows a list of all the application and browser windows that are open on the Bot Creator device.
Browser	Select from a list of supported browser tabs. Note: This option supports , Chromium-based , and browsers. For all other browsers, use the Application option.
Variable	Select an existing window variable to specify the title of the application window title.

3. Optional: Insert a wildcard character (*) in the **Window title** field to search for window titles that can change. You can specify one or more wildcards (*) at the start, middle, or end of the value.

For example, to perform an operation on any window that has `Microsoft` in the title, use a wildcard to indicate any string by adding it before or after the value: `*Microsoft*`. The first searches for the exact window title (`Microsoft`), and if it does not find a match, it searches for windows with the term `Microsoft` anywhere in the title.

You can use a regular expression (regex) to identify a window title. Select the regular expression condition as either **String** or a **Pattern** and then enter the value. By default, the **Window title** field is case-sensitive.

To identify a browser title, you can enable the **Case sensitive** option to match the letter case, or disable the option to identify a window title where the letter case does not match.

Note: Ensure that the minimum version installed on your system is the version that was released with v.26. If you have a version released with v.25 or earlier, then by default, the window title will be identified only with matching letter case (case-sensitive).

For example, you can enter the **String** value as `((\w*)-Notepad` for all window title names starting with `((\w*)-Notepad`, or use **Pattern** value as `((\w)\s)*document-Notepad` for only those window titles that match this pattern.

Note:

- When you use a regular expression of type **String** with `-title` as the input value for a window title in any , the might encounter a run time error. To prevent the run time error, ensure that when

you add the string input as `*-title`, the application with the specific title is open. The asterisk (*) is just a character, not a wild card character.

- When you use a regular expression of type **Pattern** with `-title` as the input value for a window title in any , the might encounter a run time error because the input value `*-title` is incorrect. Ensure that you use valid regex patterns.

Note: During runtime, verify that the TaskBot identifies the correct window. If it does not, do the following:

- Open the application or browser window.
- Drag a **Window > Get active window title** action above the **Recorder > Capture** action.
- Insert a string variable into the **Assign the window title to variable** field.
- Drag a **Window > Set title** action below the **Window > Get active window title** action.
- In the **Window** field, insert the window variable generated by the **Recorder > Capture** action.
- In the **New window title** field, insert the string variable from the **Get active window title** action.
- Click **Save**.

-
- Optional: Select the **Resize window** option to specify the window dimensions.

This option delivers a more reliable bot. It resizes the window to the dimensions at which the task was recorded, which enhances the ability of the bot to identify the target object.

- If the window is maximized when you record the task, this option is not selected.
- If the window is not at the maximum size when you record the task, this option is selected, by default, and the width and height fields are automatically filled with the dimensions of the window.

Note: This option is available only for windows that can be resized. It is not available for the **Desktop** or **Taskbar** options.

-
- Click the **Capture region**.

The pixel coordinates of the captured area are displayed in the **X, Y, Width, and Height** fields. You can modify these values.

- Browse to select the **File path to save image**.

The following file extensions are supported: png, bmp, jpeg, tiff, gif, and wmf.

- Click **Overwrite file** to replace an existing file with the same name.
- Click **Save**.

Using Capture window action from Screen package

Use the **Capture window** action of the Screen package to capture an open application window.

To capture an application window, perform these steps:

- In the **Actions** palette, double-click or drag the **Capture window** action from the Screen package.

2. Specify the window in which to capture an object.

Choose from the **Application**, **Browser**, or **Variable** tab.

Option	Description
Application	Select from a list of currently active windows. This option shows a list of all the application and browser windows that are open on the Bot Creator device.
Browser	Select from a list of supported browser tabs. Note: This option supports , Chromium-based , and browsers. For all other browsers, use the Application option.
Variable	Select an existing window variable to specify the title of the application window title.

3. Optional: Insert a wildcard character (*) in the **Window title** field to search for window titles that can change. You can specify one or more wildcards (*) at the start, middle, or end of the value.

For example, to perform an operation on any window that has `Microsoft` in the title, use a wildcard to indicate any string by adding it before or after the value: `*Microsoft*`. The first searches for the exact window title (`Microsoft`), and if it does not find a match, it searches for windows with the term `Microsoft` anywhere in the title.

You can use a regular expression (regex) to identify a window title. Select the regular expression condition as either **String** or a **Pattern** and then enter the value. By default, the **Window title** field is case-sensitive.

To identify a browser title, you can enable the **Case sensitive** option to match the letter case, or disable the option to identify a window title where the letter case does not match.

Note: Ensure that the minimum version installed on your system is the version that was released with v.26. If you have a version released with v.25 or earlier, then by default, the window title will be identified only with matching letter case (case-sensitive).

For example, you can enter the **String** value as `((\w*)-Notepad` for all window title names starting with `((\w*)-Notepad`, or use **Pattern** value as `((\w)\s)*document-Notepad` for only those window titles that match this pattern.

Note:

- When you use a regular expression of type **String** with `-title` as the input value for a window title in any , the might encounter a run time error. To prevent the run time error, ensure that when

you add the string input as `*-title`, the application with the specific title is open. The asterisk (*) is just a character, not a wild card character.

- When you use a regular expression of type **Pattern** with `-title` as the input value for a window title in any , the might encounter a run time error because the input value `*-title` is incorrect. Ensure that you use valid regex patterns.

Note: During runtime, verify that the TaskBot identifies the correct window. If it does not, do the following:

- Open the application or browser window.
- Drag a **Window > Get active window title** action above the **Recorder > Capture** action.
- Insert a string variable into the **Assign the window title to variable** field.
- Drag a **Window > Set title** action below the **Window > Get active window title** action.
- In the **Window** field, insert the window variable generated by the **Recorder > Capture** action.
- In the **New window title** field, insert the string variable from the **Get active window title** action.
- Click **Save**.

-
4. Optional: Select the **Resize window** option to specify the window dimensions.

This option delivers a more reliable bot. It resizes the window to the dimensions at which the task was recorded, which enhances the ability of the bot to identify the target object.

- If the window is maximized when you record the task, this option is not selected.
- If the window is not at the maximum size when you record the task, this option is selected, by default, and the width and height fields are automatically filled with the dimensions of the window.

Note: This option is available only for windows that can be resized. It is not available for the **Desktop** or **Taskbar** options.

-
5. Browse to select the **File path to save image**.

The following file extensions are supported: png, bmp, jpeg, tiff, gif, and wmf.

- Click **Overwrite file** to replace an existing file with the same name.
- Click **Save**.

Service package

Use the Service package to automate operations in Windows and application services including starting, stopping, pausing, resuming, or getting the status of services.

Note: You must have administrator privileges to start, stop, pause, or resume service operations.

Actions in the Services package

The Services package includes the following actions:

Action	Description
Get service status	Retrieves the current status of a Windows or application service. You can store the status of the selected service by assigning it to a selected variable. Example: The Windows Audio service status might be running. You can assign the status value to a selected variable.
Pause service	Pauses a Windows or application service that is currently running.
Resume service	Restarts a selected Windows or application service that was previously paused.
Start service	Starts a selected Windows or application service that is not running.
Stop service	Stops a selected Windows or application service that is currently running.

ServiceNow package

ServiceNow is a leading software provider of digital work flows for enterprise operations. The Automation 360 ServiceNow command package uses the ServiceNow APIs to let you build and deploy bots in Automation 360 that work with records and triggers in ServiceNow.

This package provides actions to authenticate with ServiceNow and perform several actions with records and attachments. To perform these actions in ServiceNow, Automation 360 uses these APIs:

- [Table API](#)
- [Attachment API](#)

Automation 360 bots can increase process efficiency for these types of work flows: customer account creation and management, customer verification, employee on-boarding and off-boarding, data extraction and migration, and claims and invoice processing. Automation 360 helps extend the core work flow capabilities of ServiceNow so that you can automate repetitive tasks for intelligent, end-to-end automation. This Automation 360 command package enables Automation 360 bots and processes to use ServiceNow API features natively within the Automation 360 platform.

The following image shows the the authentication and command actions from Automation 360 to ServiceNow:

ServiceNow Triggers

You can use the ServiceNow triggers to start Automation 360 bots respond to the events in ServiceNow such as incident creation, updates, and so on. For more information on ServiceNow triggers, see [ServiceNow New Record trigger](#) and [ServiceNow Updated Record trigger](#).

Use cases

The key use cases for this package include:

- Create, read, update, and delete records from a ServiceNow table.

- Add, download, and delete attachments on ServiceNow records.
- Streamline Incident responses.
- Trigger specific automations from the creation of new Incidents or Incident updates.

Prerequisites

- The bot creator must have access to a ServiceNow account with required permissions to perform tasks enabled by this package. See [Roles](#).
- Follow ServiceNow guidelines for authenticating to external client with OAuth 2.0. See [Setup OAuth](#).
- Create a Developer account and Developer instance in ServiceNow. See [Personal Developer Instances](#).

Authentication

Use the **Authentication** and **Revoke Authentication** action to connect or disconnect from your ServiceNow instance.

ServiceNow authentication action

Use the **Authentication** action to connect to your ServiceNow instance. After the authentication is successful, you can use other command actions to perform various operations in ServiceNow.

- You must have the *Client ID* and *Client secret* generated in your ServiceNow instance. To generate the Client details, see [Create an OAuth API endpoint for external clients](#).
- You must have the **Bot creator role** for your Automation AnywhereControl Room to use the ServiceNow package in a bot.

You can authenticate access to ServiceNow by retrieving the authentication parameters from the ServiceNow instance and using them in Automation 360.

1. Log in to your ServiceNow instance.
2. Click **All > Application Registry**.
3. Select the OAuth you created.
4. Use the *Client ID* and *Client Secret* in your Authentication action from the Control Room.
5. Log in to the Control Room.
6. Create a new bot or edit an existing bot. See [Create your first bot](#).

7. From the Actions pane, select **ServiceNow > Authentication** and place it under the start of the bot flow.

Security Information	Option
Client ID/Client secret/ User name/ Password	<p>Select one of the following options to specify the Client ID/Client secret/ ServiceNow username/ password:</p> <ul style="list-style-type: none"> • Credential: Enables you to use a value in the Credential Vault that contains information about the Client ID/Client secret/ ServiceNow username/ password. • Variable: Enables you to use a credential variable that contains information about the Client ID/Client secret/ ServiceNow username/ password. • Insecure string: Enables you to enter the Client ID/Client secret/ ServiceNow username/ password for the ServiceNow Authentication.

- In the **ServiceNow URL** field, enter your ServiceNow instance URL.
- (Optional) Enter the API version.
- In the **Client ID** field, enter the *Client ID* copied from ServiceNow. In the example video below an Insecure string is used, while you can use Credential or Variable options for better security.
- In the **Client Secret** field, enter the *Client Secret* copied from ServiceNow.
- Enter the ServiceNow user name.
- Enter the ServiceNow password.
- Enter **Default** as the Session name.
- You can assign the authorization header to a variable by creating either a Multiple or Dictionary variable.

<https://aa2019packagesdkfordocumentation.s3-us-west-2.amazonaws.com/videos/servicenow-authentication.mp4>

8. Click **Run** to save and run your bot. Once authenticated, you can use the token to call other ServiceNow API services.

ServiceNow revoke authentication action

Use the **Revoke Authentication** action to securely discard the refresh token and access token when you do not need them anymore.

- From the **Actions** pane, select **ServiceNow > Authentication > Revoke Authentication** and place it under the bot flow.
- Enter the session name and click **Run**.
- After the bot runs, your ServiceNow access token is revoked.

Records

Use the **Records** action to perform various operations in your ServiceNow instance. You can create, update, delete, or get records from a ServiceNow Table.

ServiceNow create record action

Use the **Create Record** action to create a new data record in the ServiceNow Table app.

- Ensure that you are authenticated before calling any ServiceNow action. For more details, see [ServiceNow Authentication action](#).
- You must create a table in your ServiceNow instance as this action only creates a new record for an existing table entry with the data provided. For more details, see [Creating a table](#).

1. From the **Actions** pane, select **ServiceNow** > **Records** > **Create Record** and place it in the canvas.

2. Specify details in the following fields:

- a) Enter the **Table name**. You can use a standard table name available in ServiceNow, for example: Incident. Or you can use a custom user defined table name, for example: u_test_table.

Note: For ServiceNow tables, ensure that you provide the **Table name** instead of the **Label** name.

- b) Enter the **Fields and data** to insert. Choose either **Dictionary** or **Entry list**. For this example, **Dictionary** is selected.

1. Select the **Type** as *String, Number, Datetime, or Boolean* based on the data you want to insert in the table.
2. Enter a key-value pair, where key is the ServiceNow field name and value is the data you want to update in the field.

Note: The key name for a field is different from the displayed label name. You can view the key name of the field by using one of the following options:

- In your ServiceNow developer instance, navigate to **System Definition > Language File**. You can use the filter option to view fields for specific Tables. For example: Incident.
- Right-click on the field name (as shown below) to display the key name. For example: *caller_id* is the key name for the field **Caller**.

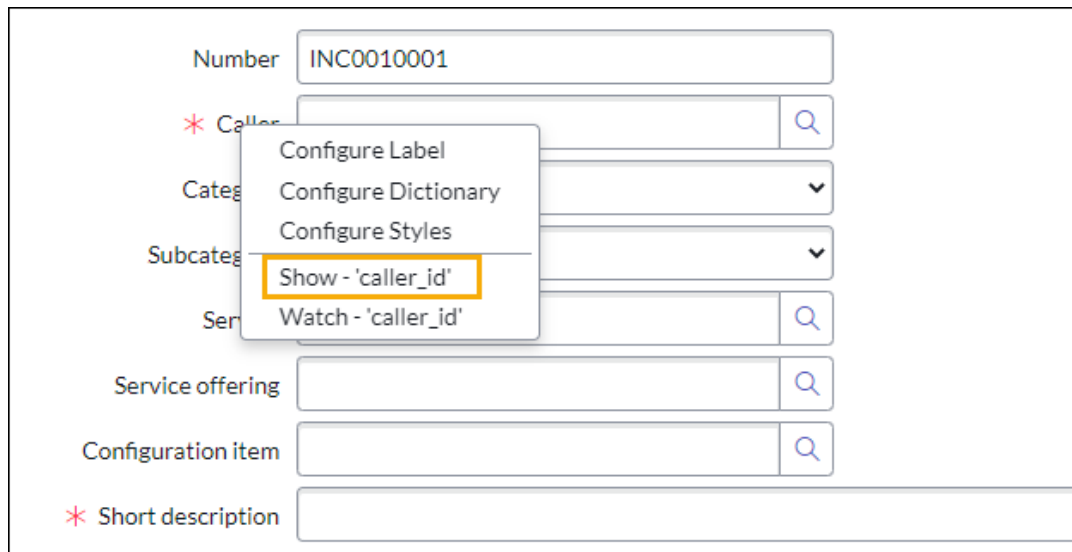

- c) Enter **Default** as the session name.
- d) Save the record ID to a variable. For example, the record ID is saved to *sys_id*.

ServiceNow: Create Record

Inserts one record in the specified table

Required bot agent version: 21.119 or above

Table name

a `” $str_TableName$`

Fields and data (optional)

Dictionary Entry list

b Dictionary Variable

Type	Key
String	caller_id
Value	<code>” Jane-1234</code>

+

Field names and values must be provided for required fields in the specified Table

Session name

c `” Default`

Assign record id to a string variable (optional)

d `” str_Sys_id`

3. Click **Run** to save and run your bot.

4. Verify whether the record is created in the ServiceNow table.
 - a) Find the `sys_id` variable value in the **Debug** mode.
 - b) Replace the ID in the ServiceNow URL (as shown below) to view the latest record created.

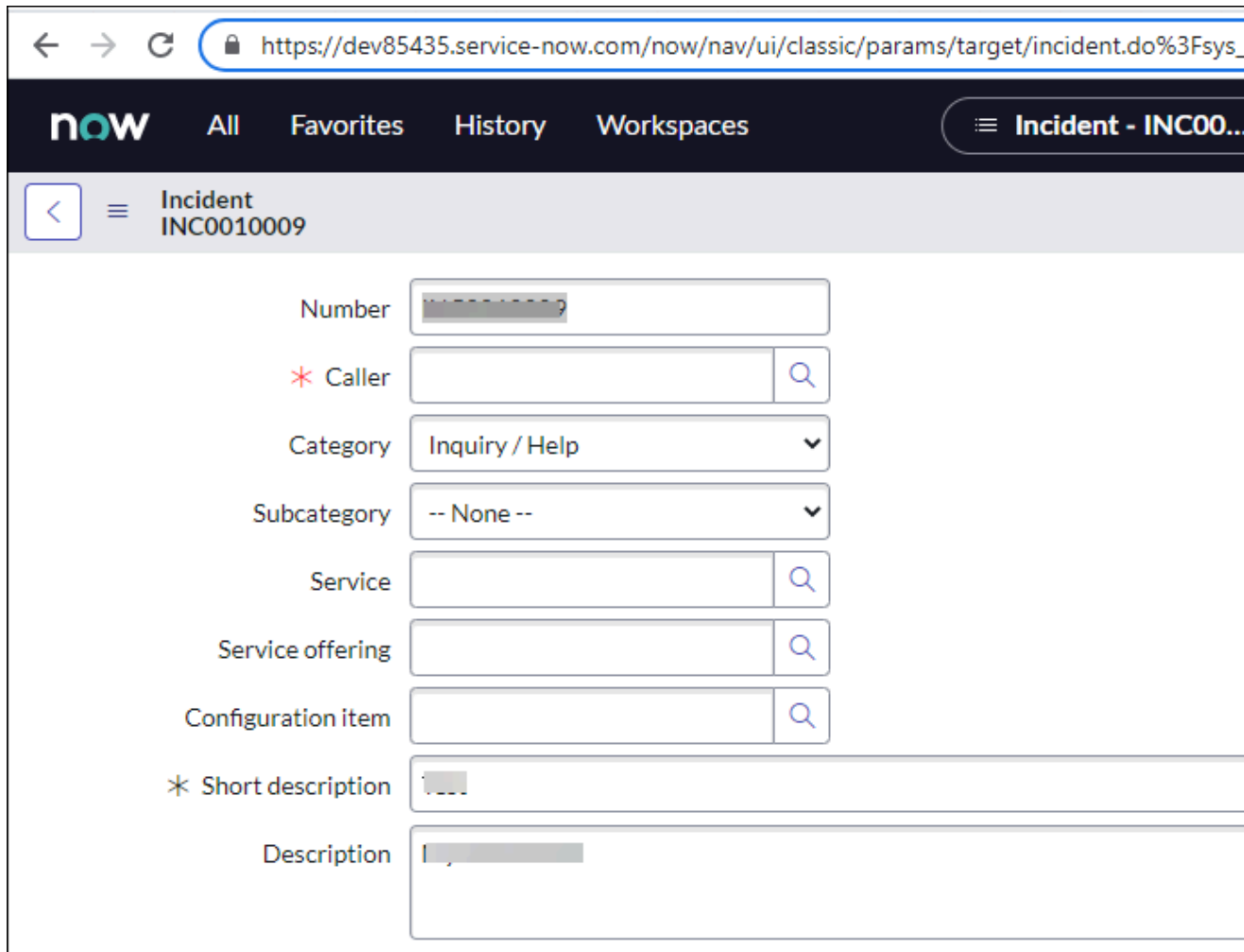

The screenshot shows a web browser window displaying a ServiceNow incident record form. The browser's address bar shows the URL: `https://dev85435.service-now.com/now/nav/ui/classic/params/target/incident.do%3Fsys_...`. The ServiceNow interface includes a navigation bar with the 'now' logo and tabs for 'All', 'Favorites', 'History', and 'Workspaces'. The current page title is 'Incident - INC00...'. The form itself is titled 'Incident INC0010009' and contains several fields: 'Number' (a text input field), '* Caller' (a text input field with a search icon), 'Category' (a dropdown menu set to 'Inquiry / Help'), 'Subcategory' (a dropdown menu set to '-- None --'), 'Service' (a text input field with a search icon), 'Service offering' (a text input field with a search icon), 'Configuration item' (a text input field with a search icon), '* Short description' (a text input field), and 'Description' (a larger text input field).

ServiceNow delete record action

Use the **Delete Record** action to delete a record from a ServiceNow table.

Ensure that you are authenticated before initiating any ServiceNow action. For more details, see [ServiceNow Authentication action](#).

1. From the **Actions** pane, select **ServiceNow** > **Records** > **Get Record** and place it in the canvas.

2. Specify details in the following fields:
 - a) **Table name:** Enter the ServiceNow table name.
 - b) **Record Sys_id:** Enter the *sys_id* of the record. If the record ID is captured in a variable, you can provide the variable name.
 - c) The session name displays as **Default**.

ServiceNow: Delete Record

Deletes a record from the specified table

Required bot agent version: 21.119 or above

Table name

a ”” `$str_TableName$`

Record sys_id

b ”” `str_Sys_id`

Session name

c ”” `Default`

3. Click **Run** to save and run your bot. When the bot is run successfully, your record in the ServiceNow table is deleted.

ServiceNow get record action

Use the **Get Record** action to retrieve a record using the record ID stored in *sys_Id* variable from ServiceNow.

Ensure that you are authenticated before initiating any ServiceNow action. For more details, see [ServiceNow Authentication action](#).

1. From the **Actions** pane, select **ServiceNow > Records > Get Record** and place it in the canvas.

2. Specify details in the following fields:
 - a) **Table name:** Enter the ServiceNow table name.
 - b) **Record sys_id:** Enter the *sys_id* of the record. If the record ID is captured in a variable you can provide the variable name.
 - c) Select **List** for the **Field names (Optional)** field. Enter all the fields that you want to read.
 - d) The session name displays as **Default**.
 - e) Save the outcome to a variable. For example, the object ID is saved to *dict_GetRecordResults*.

ServiceNow: Get Record

Retrieves the record identified by the specified *sys_id* from the specified table

Required bot agent version: 21.119 or above

Table name

a

Record *sys_id*

b

Field names (optional)

c

Session name

d

Assign output to a dictionary variable

e

3. Click **Run** to save and run your bot. When the bot is run successfully, the retrieved record is stored in the specified variable.

ServiceNow get multiple records action

Use the **Get Multiple Records** action to retrieve multiple records from a ServiceNow table.

Ensure that you are authenticated before initiating any ServiceNow action. For more details, see [ServiceNow Authentication action](#).

1. From the **Actions** pane, select **ServiceNow** > **Records** > **Get Multiple Records** and place it in the canvas.

2. Specify details in the following fields:
 - a) **Table name:** Enter the ServiceNow table name.
 - b) Select **List** in the **List of fields to return in the response (Optional)** field. Enter the **Type** and **Value** for the fields you want to view in the response.
 - c) You can optionally filter the records by using name-value pair or query. For example, select **Query** and specify a query parameter to retrieve records for only the queried fields. For example, you can map the *sys_id* to a variable and add it as a query.
 - d) Specify a limit of records to view. If the **Limit** field is blank or set to 0, all records are returned. Response time might vary depending on the volume of the specified Table.
 - e) The session name displays as **Default**.
 - f) Save the outcome to a variable. For example, the object ID is saved to *list_GetMultipleRecordsResult*.

ServiceNow: Get Multiple Records

Retrieves multiple records from the specified table

Required bot agent version: 21.119 or above

Table name

a `"" $str_TableName$`

List of fields to return in the response (optional)

List Variable

Type

b String

Value at 0

`"" category`

Type

String

Value at 1

`"" sys_id`



Filter records by

Name-value pair Query None

Query (optional)

c `"" sys_id=str_Sys_id`

Limit (optional)

d # 1000

If limit is left blank or set to 0, all records will be returned. Response time may vary depending on the volume of the spe

Session name

e `"" Default`

Assign matched records to a list variable

3. Click **Run** to save and run your bot. When the bot is run successfully, you will retrieve all the records from ServiceNow.

ServiceNow update record action

Use the **Update Record** action to update a record in ServiceNow with name-value pairs.

Ensure that you are authenticated before initiating any ServiceNow action. For more details, see [ServiceNow Authentication action](#).

1. From the **Actions** pane, select **ServiceNow** > **Records** > **Get Record** and place it in the canvas.

2. Specify details in the following fields:
 - a) **Table name:** Enter the ServiceNow table name.
 - b) **Sys_id:** Enter the *sys_id* of the record. If the record ID is captured in a variable, you can provide the variable name.
 - c) In **Fields and data**, select **Dictionary** or **Entry list**. In the example, **Dictionary** is selected and the name-value pair is specified to update the record.
 - d) The session name displays as **Default**.

ServiceNow: Update a Record

Updates the specified record with the name-value pairs included in the request body

Required bot agent version: 21.119 or above

Table name

a

Sys_id

b

Fields and data

Dictionary Entry list

c Dictionary Variable

Type	Key
<input type="text" value="String"/>	<input type="text" value="category"/>
Value	
<input type="text" value="`Hardware`"/>	

+ (Add button)

Session name

d

3. Click **Run** to save and run your bot. When the bot is run successfully, your record is updated with the specified details.

Attachments

Use the Attachments action to upload or delete an attachment from a record in the ServiceNow table. You can also download an attachment from a ServiceNow record.

ServiceNow add attachment action

Use the **Add Attachment** action to add a new attachment to the specified record in a ServiceNow Table app.

Ensure that you are authenticated before initiating any ServiceNow action. For more details, see [ServiceNow authentication action](#).

1. From the **Actions** pane, select **ServiceNow** > **Attachments** > **Add Attachment** and place it in the canvas.

2. Specify details in the following fields:

- a) Enter the **Table name**.

Note: For ServiceNow tables, ensure that you provide the **Table name** instead of the **Label** name.

- b) Select the **File to be uploaded** by using one of the following options:

- **Control Room file:** If the file exists within the Control Room folders, select this option.
- **Desktop file:** If the file exists in your local system desktop, select this option and browse the file path.
- **Variable:** You can also store the file path as a variable.

Note: Maximum size of the file to upload cannot exceed 25 MB.

- c) (Optional) You can enter a name in the **New file name** field.
- d) The session name displays as **Default**.
- e) You can assign the attachment ID to a string variable. For example, the attachment ID is saved to *str_AttachmentSysId*.

ServiceNow: Add Attachment

Adds an attachment to the specified record

Required bot agent version: 21.119 or above

Table name

a

Sys_id

b

File to be uploaded

c

New file name (optional)

d

Session name

e

Assign attachment sys_id to a string variable (optional)

f

3. Click **Run** to save and run your bot.

- Verify whether the attachment is added in the ServiceNow record as shown below:

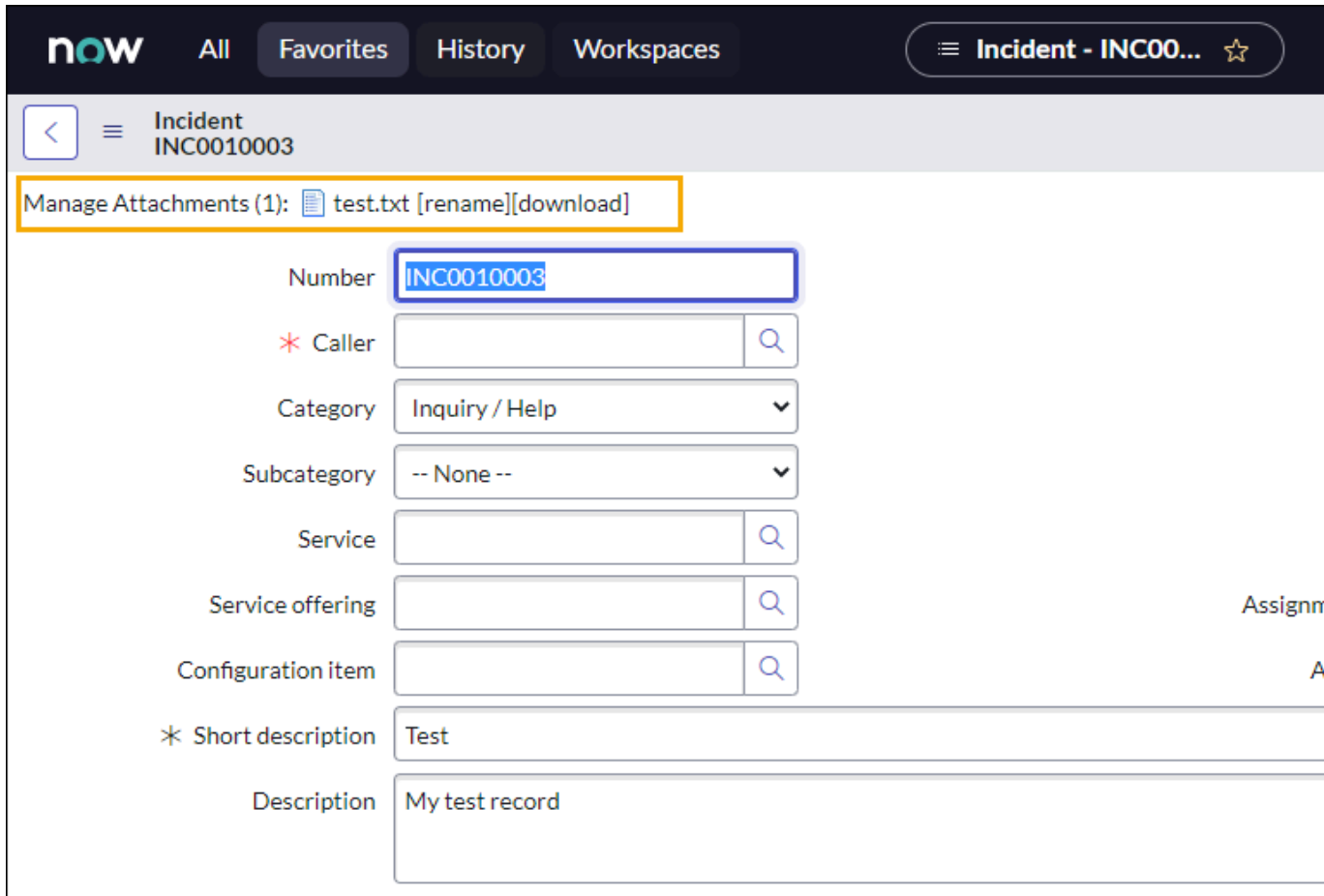

now All Favorites History Workspaces Incident - INC00...

Incident INC0010003

Manage Attachments (1): test.txt [rename][download]

Number INC0010003

* Caller

Category Inquiry / Help

Subcategory -- None --

Service

Service offering

Configuration item

* Short description Test

Description My test record

ServiceNow delete attachment action

Use the **Delete Attachment** action to delete an attachment from a ServiceNow record.

Ensure that you are authenticated before initiating any ServiceNow action. For more details, see [ServiceNow Authentication action](#).

- From the **Actions** pane, select **ServiceNow > Attachments > Delete Attachment** and place it in the canvas.

2. Specify details in the following fields:
 - a) **Sys_id**: Enter the attachment ID or select the variable where you stored the attachment ID.
 - b) The session name displays as **Default**.

ServiceNow: Delete Attachment

Deletes an attachment to the specified record

Required bot agent version: 21.119 or above

Sys_id

a

Session name

b

3. Click **Run** to save and run your bot. When the bot is run successfully, your attachment in the ServiceNow record is deleted.

ServiceNow get attachment action

Use the Get Attachment action to download a new attachment from the specified record in a ServiceNow Table app.

Ensure that you are authenticated before initiating any ServiceNow action. For more details, see [ServiceNow Authentication action](#).

1. From the **Actions** pane, select **ServiceNow > Attachments > Get Attachment** and place it in the canvas.

2. Specify details in the following fields:

a) **Filter attachment by.**

- **Sys_id:** Specify the attachment ID or select a variable where the attachment ID is stored.
- **Associated record:** Specify details of the associated record, to download the associated attachment. You must enter the table name and the table ID.
- **Query:** Specify a query parameter to download the attachments. For example, you can map the *sys_id* to a variable and add it as a query.

b) Enter a **Destination folder path**, or select a variable if the path is stored in a variable.

c) The session name displays as **Default**.

d) You can assign the attachment ID to a string variable. For example, the attachment ID is saved to *list_GetAttachmentResults*.

ServiceNow: Get Attachment

Downloads attachment(s) to the specified folder location

Required bot agent version: 21.119 or above

Filter attachment by

a Sys_id Associated record Query

Sys_id

”” \$str_AttachmentSysId\$

Destination folder path

b ”” \$str_DestinationFolderPath\$

e.g C:\Users\...\attachment-download-folder

Session name

c ”” Default

Assign file metadata to a list variable (optional)

d list_GetAttachmentResults

3. Click **Run** to save and run your bot.

4. The attachment is downloaded to the specified folder path.

ServiceNow field types: Table API

The ServiceNow schema contains various fields that you can modify by using the Automation 360 ServiceNow command package. The following table lists alphabetically the supported field types and their corresponding Automation 360 to ServiceNow actions.

Field Type	Create / Update Record	Get Record
Audio	Not supported	Supported
Choice	Supported	Supported
Collection	Not supported	Not supported
Color	Supported	Supported
Condition String	Limited support	Supported
Conditions	Supported	Supported
Currency	Supported	Supported
Data Structure	Supported	Supported
Date	Supported	Supported
Date/Time	Supported	Supported
Decimal	Supported	Supported
Document ID	Supported	Supported
Domain ID	Supported	Supported
Due Date	Supported	Supported
Duration	Supported	Supported
Field Name	Supported	Supported
File Attachment	Not Supported	Supported
Floating Point Number	Supported	Supported
FX Currency	Supported	Supported
HTML	Supported	Supported
Icon	Supported	Supported
Image	Not Supported	Supported
Integer	Supported	Supported
IP address	Supported	Supported
Journal	Supported	Supported
Journal Input	Supported	Supported

Field Type	Create / Update Record	Get Record
Journal List	Supported	Supported
List	Supported	Supported
Long	Supported	Supported
Name-Value Pairs	Supported	Supported
Password (1 Way Encrypted)	Supported	Supported
Password (2 Way Encrypted)	Supported	Supported
Percent Complete	Supported	Supported
Phone Number (E164)	Supported	Supported
Price	Supported	Supported
Reference	Supported	Supported
Script	Not Supported	Supported
Script (Plain)	Supported	Supported
String	Supported	Supported
String (Full UTF-8)	Supported	Supported
Suggestion	Supported	Supported
Sys ID	Supported	Supported
Table Name	Supported	Supported
Time	Supported	Supported
Translated HTML	Supported	Supported
Translated Text	Supported	Supported
True/False	Supported	Supported
URL	Supported	Supported
Video	Not Supported	Supported
Wiki	Not Supported	Supported
Workflow	Supported	Supported

Simulate keystrokes package

Use the Simulate keystrokes package to simulate keystrokes in Chinese (simplified and traditional), English, French, German, Japanese, Korean, Italian, or Spanish characters.

Action in the Simulate keystrokes package

The Simulate keystrokes package includes the following action:

Action	Description
Keystrokes	See <i>Using Keystrokes action</i> .

Related tasks

[Build a basic bot that uses a desktop application](#)

Build a bot that uses a conditional statement to verify that the calculator is open, then uses the calculator to multiply two numbers. This example uses actions from the Application, If, Simulate keystrokes, Message Box, and Window packages.

Using Keystrokes action

Use the **Keystrokes** action to simulate keystrokes.

Follow these steps to add a **Keystrokes** action:

1. In the **Actions** palette, double-click or drag the **Keystrokes** action from the **Keystrokes** package.
2. Specify the window in which to capture an object.

Choose from the **Application**, **Browser**, or **Variable** tab.

Option	Description
Application	Select from a list of currently active windows. This option shows a list of all the application and browser windows that are open on the Bot Creator device.
Browser	Select from a list of supported browser tabs. Note: This option supports , Chromium-based , and browsers. For all other browsers, use the Application option.
Variable	Select an existing window variable to specify the title of the application window title.

Insert a wildcard character (*) in the **Window title** field to search for window titles that can change. You can specify one or more wildcards (*) at the start, middle, or end of the value. For example, to perform an operation on any window that has `Microsoft` in the title, use a wildcard to indicate any string by adding it before or after the value: `*Microsoft*`. The first searches for the exact window title (`Microsoft`), and if it does not find a match, it searches for windows with the term `Microsoft` anywhere in the title.

You can use a regular expression (regex) to identify a window title. Select the regular expression condition as either **String** or a **Pattern** and then enter the value. By default, the **Window title** field is case-sensitive.

To identify a browser title, you can enable the **Case sensitive** option to match the letter case, or disable the option to identify a window title where the letter case does not match.

Note: Ensure that the minimum version installed on your system is the version that was released with v.26. If you have a version released with v.25 or earlier, then by default, the window title will be identified only with matching letter case (case-sensitive).

For example, you can enter the **String** value as `((\w*)-Notepad` for all window title names starting with `((\w*)-Notepad`, or use **Pattern** value as `((\w)\s)*document-Notepad` for only those window titles that match this pattern.

Note:

- When you use a regular expression of type **String** with `-title` as the input value for a window title in any , the might encounter a run time error. To prevent the run time error, ensure that when you add the string input as `*-title`, the application with the specific title is open. The asterisk (*) is just a character, not a wild card character.
- When you use a regular expression of type **Pattern** with `-title` as the input value for a window title in any , the might encounter a run time error because the input value `*-title` is incorrect.

Ensure that you use valid regex patterns.

3. Optional: Select the **Resize window option to specify the window dimensions.**

This option delivers a more reliable bot. It resizes the window to the dimensions at which the task was recorded, which enhances the ability of the bot to identify the target object.

- If the window is maximized when you record the task, this option is not selected.
 - If the window is not at the maximum size when you record the task, this option is selected, by default, and the width and height fields are automatically filled with the dimensions of the window.
-

Note: This option is available only for windows that can be resized. It is not available for the **Desktop** or **Taskbar** options.

4. In the **Keystrokes, select a radio button:**

- **Enter keystrokes here or use the on-screen keyboard:** Type or use the keyboard to enter keystrokes.
 - **Select a credential:** Uses a password stored in the Credential Vault.
-

Note: A new key named **Return** has been added to the virtual keyboard to replace the Enter functionality and the Enter key in the Number pad has been renamed to **Num Enter**. As a result, the Return key is the main Enter key on the keyboard.

5. Optional: : In the **Delay between each keystroke in ms** field, the delay time.

Note: The default is set to 10 milliseconds.

6. Click **Save.**

SNMP package

The SNMP package allows you to automate network management tasks, such as retrieving and modifying data, and sending notification messages.

Simple Network Management Protocol (SNMP) is used to find the network management component on one or more computers and the managed component on multiple network devices.

The Automation Anywhere SNMP action offers powerful network management. Using this action, users can easily monitor network devices configured with SNMP agent software. Network devices such as servers, workstations, printers, routers, bridges, and hubs, as well as services such as Dynamic Host Configuration Protocol (DHCP) or Windows Internet Name Service (WINS) can be monitored.

Actions in the SNMP package

The SNMP package includes the following actions:

Action	Description
Get	See Using Get action
Get next	See Using Get next action
Send trap	See Using Send trap action
Set	See Using Set action
Walk	See Using Set action

Related reference

[Active Directory package](#)

Use the **Active Directory** package to automate actions in the Active Directory. An Active Directory is a directory service provided by Microsoft to assist the admin in managing users across a group or organization.

[Printer package](#)

Use the actions in the Printer package to automate retrieving and setting the default printer and removing a printer from the list of available printers.

Using Get action

Use the **Get** action in the SNMP package to retrieve data of an object that is managed by an SNMP agent.

1. In the **Actions** palette, double-click or drag the **Get** action from the SNMP package.
2. In the **Agent** field, enter details of the device on which the SNMP agent is available.
3. In the **SNMP Version** section, select an option to specify the SNMP version to be used.

Option	Action
V1	Specify the community string you want to use in the Community field.
V2C	Specify the community string you want to use in the Community field.

Option	Action
V3	<p>Specify the community string you want to use in the Community field.</p> <p>Select an option from the Authentication level list to specify the authentication level you want to use.</p> <ul style="list-style-type: none"> • None: No authentication will be used. • Authentication Only: Enables you to use authentication only. <ul style="list-style-type: none"> a. Select MD5 or SHA from the Authentication method list to specify the authentication method you want to use. b. Select Credential to use a value from the Credential Vault, Variable to use a credential variable, or Insecure string to manually specify the value you want to use. • Authentication and privacy: Enables you to use authentication and privacy. <ul style="list-style-type: none"> a. Select MD5 or SHA from the Authentication method list to specify the authentication method you want to use. b. Select Credential to use a value from the Credential Vault, Variable to use a credential variable, or Insecure string to manually specify the value you want to use. c. Select DES or AES from the Privacy method list to specify the privacy method you want to use. d. Select Credential to use a value from the Credential Vault, Variable to use a credential variable, or Insecure string to manually specify the value you want to use.

4. In the **Object ID** field, specify the ID of the object for which you want to retrieve details.
5. In the **Data type** section, select the **ASCII** or **Hex** option to specify the format in which you want to retrieve details of the object.
6. In the **SNMP advanced option** section, complete the following fields:
 - **Timeout:** Specify the time (in milliseconds) for the action to wait before generating an error.
 - **Remote port:** Specify the port number of the remote device.
 - **Retries:** Specify the maximum number of times the action must try to retrieve the details.

7. In the **Result** section, select an option:
 - **Control Room file:** Uses a file that is available on the Control Room to store the result.
 - **Desktop file:** Uses a file that is available on a device to store the result.
 - **Variable:** Uses a file variable to specify the file location that you want to use to store the result.
8. Select a string variable from the **Assigned to** list.
9. Click **Save**.

Using Get next action

Use the **Get next** action in the SNMP package to retrieve data of the next object that is managed by an SNMP agent.

1. In the **Actions** palette, double-click or drag the **Get next** action from the SNMP package.
2. In the **Agent** field, enter details of the device on which the SNMP agent is available.
3. In the **SNMP Version** section, select an option to specify the SNMP version to be used.

Option	Action
V1	Specify the community string you want to use in the Community field.
V2C	Specify the community string you want to use in the Community field.

Option	Action
V3	<p>Specify the community string you want to use in the Community field.</p> <p>Select an option from the Authentication level list to specify the authentication level you want to use.</p> <ul style="list-style-type: none"> • None: No authentication will be used. • Authentication Only: Enables you to use authentication only. <ul style="list-style-type: none"> a. Select MD5 or SHA from the Authentication method list to specify the authentication method you want to use. b. Select Credential to use a value from the Credential Vault, Variable to use a credential variable, or Insecure string to manually specify the value you want to use. • Authentication and privacy: Enables you to use authentication and privacy. <ul style="list-style-type: none"> a. Select MD5 or SHA from the Authentication method list to specify the authentication method you want to use. b. Select Credential to use a value from the Credential Vault, Variable to use a credential variable, or Insecure string to manually specify the value you want to use. c. Select DES or AES from the Privacy method list to specify the privacy method you want to use. d. Select Credential to use a value from the Credential Vault, Variable to use a credential variable, or Insecure string to manually specify the value you want to use.

4. In the **Object ID** field, specify the ID of the object for which you want to retrieve details.
5. In the **Data type** section, select the **ASCII** or **Hex** option to specify the format in which you want to retrieve details of the object.
6. In the **SNMP advanced option** section, complete the following fields:
 - **Timeout:** Specify the time (in milliseconds) for the action to wait before generating an error.
 - **Remote port:** Specify the port number of the remote device.
 - **Retries:** Specify the maximum number of times the action must try to retrieve the details.

7. In the **Result** section, select an option:
 - **Control Room file:** Uses a file that is available on the Control Room to store the result.
 - **Desktop file:** Uses a file that is available on a device to store the result.
 - **Variable:** Uses a file variable to specify the file location that you want to use to store the result.
8. Select a string variable from the **Assigned to** list.
9. Click **Save**.

Using Send trap action

Use the **Send trap** action in the SNMP package to send messages to the SNMP manager from an SNMP agent. These messages are sent by an SNMP agent whenever certain events occur, such as a system restart.

1. In the **Actions** palette, double-click or drag the **Send trap** action from the SNMP package.
2. In the **Agent** field, enter details of the device on which the SNMP agent is available.
3. In the **SNMP Version** section, select an option to specify the SNMP version to be used.

Option	Action
V1	Specify the community string you want to use in the Community field.
V2C	Specify the community string you want to use in the Community field.

Option	Action
V3	<p>Specify the community string you want to use in the Community field.</p> <p>Select an option from the Authentication level list to specify the authentication level you want to use.</p> <ul style="list-style-type: none"> • None: No authentication will be used. • Authentication Only: Enables you to use authentication only. <ul style="list-style-type: none"> a. Select MD5 or SHA from the Authentication method list to specify the authentication method you want to use. b. Select Credential to use a value from the Credential Vault, Variable to use a credential variable, or Insecure string to manually specify the value you want to use. • Authentication and privacy: Enables you to use authentication and privacy. <ul style="list-style-type: none"> a. Select MD5 or SHA from the Authentication method list to specify the authentication method you want to use. b. Select Credential to use a value from the Credential Vault, Variable to use a credential variable, or Insecure string to manually specify the value you want to use. c. Select DES or AES from the Privacy method list to specify the privacy method you want to use. d. Select Credential to use a value from the Credential Vault, Variable to use a credential variable, or Insecure string to manually specify the value you want to use.

4. In the **Object ID** field, specify the ID of the object for which you want to retrieve details.
5. Optional: In the **Authorative ID** field, specify the ID of the SNMP manager that will receive the notification.

Important: If you have selected **V3** from the **SNMP Version** list, you must provide a value for **Authorative ID**.

6. Select an option from the **Select trap type** list to specify the type of trap you want to send.
 - **Cold start:** Occurs when the SNMP agent initializes its configuration tables.
 - **Warm start:** Occurs when the SNMP agent reinitializes its configuration tables.
 - **Link down:** Occurs when the state of a network adapter on the SNMP agent changes from up to down.
 - **Link up:** Occurs when the state of a network adapter on the SNMP agent changes from down to up.
 - **Authentication fail:** Occurs when the SNMP agent receives a message from an SNMP manager with an invalid community name.
 - **EGP neighbour loss:** Occurs when the SNMP agent cannot communicate with its Exterior Gateway Protocol (EGP) peer.
 - **Enterprise specific:** Occurs when specific error conditions and error codes are defined in the system. The user provides a trap-specific number for this option.
7. In the **SNMP advanced option** section, complete the following fields:
 - **Timeout:** Specify the time (in milliseconds) for the action to wait before generating an error.
 - **Remote port:** Specify the port number of the remote device.
 - **Retries:** Specify the maximum number of times the action must try to retrieve the details.
8. In the **Result** section, select an option:
 - **Control Room file:** Uses a file that is available on the Control Room to store the result.
 - **Desktop file:** Uses a file that is available on a device to store the result.
 - **Variable:** Uses a file variable to specify the file location that you want to use to store the result.
9. Click **Save**.

Using Set action

Use the **Set** action in the SNMP package to set a value for an object managed by the SNMP agent.

1. In the **Actions** palette, double-click or drag the **Set** action from the SNMP package.
2. In the **Agent** field, enter details of the device on which the SNMP agent is available.
3. In the **SNMP Version** section, select an option to specify the SNMP version to be used.

Option	Action
V1	Specify the community string you want to use in the Community field.
V2C	Specify the community string you want to use in the Community field.

Option	Action
V3	<p>Specify the community string you want to use in the Community field.</p> <p>Select an option from the Authentication level list to specify the authentication level you want to use.</p> <ul style="list-style-type: none"> • None: No authentication will be used. • Authentication Only: Enables you to use authentication only. <ul style="list-style-type: none"> a. Select MD5 or SHA from the Authentication method list to specify the authentication method you want to use. b. Select Credential to use a value from the Credential Vault, Variable to use a credential variable, or Insecure string to manually specify the value you want to use. • Authentication and privacy: Enables you to use authentication and privacy. <ul style="list-style-type: none"> a. Select MD5 or SHA from the Authentication method list to specify the authentication method you want to use. b. Select Credential to use a value from the Credential Vault, Variable to use a credential variable, or Insecure string to manually specify the value you want to use. c. Select DES or AES from the Privacy method list to specify the privacy method you want to use. d. Select Credential to use a value from the Credential Vault, Variable to use a credential variable, or Insecure string to manually specify the value you want to use.

4. In the **Object ID** field, specify the ID of the object for which you want to retrieve details.

5. From the **Value type** list, select an option to specify the value you want to set.
 - **OctetString**
 - **Integer**
 - **Gauge**
 - **TimeTicks**
 - **IP**
 - **ObjectID**
 - **OctetByteString**
 - **OctetDecimalByteString**
 - **NULL**
6. In the **Set value** field, specify the value you want to set.
7. In the **SNMP advanced option** section, complete the following fields:
 - **Timeout:** Specify the time (in milliseconds) for the action to wait before generating an error.
 - **Remote port:** Specify the port number of the remote device.
 - **Retries:** Specify the maximum number of times the action must try to retrieve the details.
8. In the **Result** section, select an option:
 - **Control Room file:** Uses a file that is available on the Control Room to store the result.
 - **Desktop file:** Uses a file that is available on a device to store the result.
 - **Variable:** Uses a file variable to specify the file location that you want to use to store the result.
9. Click **Save**.

Using Walk action

Use the **Walk** action in the SNMP package to set up a collection of information about all the devices available on all the connected nodes or subtree.

1. In the **Actions** palette, double-click or drag the **Walk** action from the SNMP package.
2. In the **Agent** field, enter details of the device on which the SNMP agent is available.
3. In the **SNMP Version** section, select an option to specify the SNMP version to be used.

Option	Action
V1	Specify the community string you want to use in the Community field.
V2C	Specify the community string you want to use in the Community field.

Option	Action
V3	<p>Specify the community string you want to use in the Community field.</p> <p>Select an option from the Authentication level list to specify the authentication level you want to use.</p> <ul style="list-style-type: none"> • None: No authentication will be used. • Authentication Only: Enables you to use authentication only. <ul style="list-style-type: none"> a. Select MD5 or SHA from the Authentication method list to specify the authentication method you want to use. b. Select Credential to use a value from the Credential Vault, Variable to use a credential variable, or Insecure string to manually specify the value you want to use. • Authentication and privacy: Enables you to use authentication and privacy. <ul style="list-style-type: none"> a. Select MD5 or SHA from the Authentication method list to specify the authentication method you want to use. b. Select Credential to use a value from the Credential Vault, Variable to use a credential variable, or Insecure string to manually specify the value you want to use. c. Select DES or AES from the Privacy method list to specify the privacy method you want to use. d. Select Credential to use a value from the Credential Vault, Variable to use a credential variable, or Insecure string to manually specify the value you want to use.

4. In the **Object ID** field, specify the ID of the object for which you want to retrieve details.
5. In the **Data type** section, select the **ASCII** or **Hex** option to specify the format in which you want to retrieve details of the object.
6. In the **Walk type** section, select an option to specify the scope from which to collect information.
 - **All:** Displays the variables that are equal to the specified OID for the given tree type structure.
 - **Within:** All variables in the sub-tree below the given OID are queried.

7. In the **SNMP advanced option** section, complete the following fields:
 - **Timeout:** Specify the time (in milliseconds) for the action to wait before generating an error.
 - **Remote port:** Specify the port number of the remote device.
 - **Retries:** Specify the maximum number of times the action must try to retrieve the details.
8. In the **Result** section, select an option:
 - **Control Room file:** Uses a file that is available on the Control Room to store the result.
 - **Desktop file:** Uses a file that is available on a device to store the result.
 - **Variable:** Uses a file variable to specify the file location that you want to use to store the result.
9. Select a string variable from the **Assigned to** list.
10. Click **Save**.

SOAP Web Service package

Use the **SOAP web service** action from the SOAP Web Service package to access and exchange information between two systems in XML format.

With SOAP Web Service, you can perform these actions:

- Consume SOAP web services written to provide structured data for further business processing, such as currency conversion, weather reports, and language translation.
- Connect to different existing applications and different platforms, irrespective of any underlying infrastructure requirements.

The SOAP Web Service establishes complete interoperability between clients or applications and the internet, supporting XML-based open standards, such as Web Services Description Language (WSDL), Simple Object Access Protocol (SOAP), and Universal Description Discovery and Integration (UDDI).

Passing values securely

You can securely pass values from the Credential Vault to the web service by specifying the locker, credential, and attribute in the following supported action fields:

- Custom headers
- Operation parameters
- Raw data: You must select a Credential Vault value that contains the entire parameter as the value.

Proxy support

If your device is configured with a proxy, all outbound requests from this package are routed through the proxy server. See [Connect Bot Agent to a device with a proxy](#).

Note: For an example task about using the SOAP Web Service action, see [Example of using the SOAP web service action](#).

Related tasks

[Example of building a bot that uses credential variables](#)

Securely pass values to a bot using credential variables to automate the process of logging in to a bank website.

Related reference

[Credentials and credential variables in the Bot editor](#)

Use credentials when building bots to pass sensitive information such as passwords and account numbers. Using credentials separates the sensitive information from the bots and Bot Runners, which reduces the risk of data spillage or unauthorized user access.

Step package

The **Step** package groups various actions together and runs them in a specific order. You can provide a relevant name for a step to identify the operation performed by the actions included in that step.

Action in the Step package

The **Step** package includes the following action:

Action	Description
Step	<p>Runs a sequence of actions.</p> <ul style="list-style-type: none"> • Creates a container for actions without impacting the bot run. • Configures actions within the Step action. • Runs the arranged actions in a sequential order. • Groups various actions for better management. • Optional: In the Title field, specify the title.

String package

Use the **String** package to perform various operations such as comparing two strings, retrieving the string length, or converting a string to uppercase or lowercase.

Actions in the String package

The **String** package includes the following actions:

Action	Description
Assign	<i>Assign action</i>
Extract text	<i>Using Extract text action of String package</i>
Compare	<i>Compare action</i>
Evaluate variable	<i>Evaluate variable action</i>
Find	<i>Using Find action of String package</i>
Length	<i>Length action</i>
Lowercase	<i>Lowercase action</i>

Action	Description
Generate random string	<i>Generate random string action</i>
Replace	<i>Using Replace action</i>
Reverse	<i>Reverse action</i>
Split	<i>Using Split action</i>
Substring	<i>Substring action</i>
To boolean	<i>To boolean action</i>
To locale number	<i>To locale number action</i>
To number	<i>To number action</i>
Trim	<i>Trim action</i>
Uppercase	<i>Uppercase action</i>
Import string from text file	<i>Import string from text file action</i>

Related tasks

[Using Extract text action of String package](#)

Use the **Extract text** action to extract a range of text using logical operators from the source string.

[Using Find action of String package](#)

Use the **Find** action to find a substring within the specified string.

[Using Replace action](#)

Use the **Replace** action to find a piece of text from the source string and replace it with another text.

[Using Split action](#)

Use the **Split** action to split the specified string into multiple strings and store the output in a list variable.

Assign action

The **Assign** action in the **String** package enables you to assign or concatenate strings.

Settings

- **Optional:** In the **Select the source string variable(s)/value** field, specify the variable or values. This field holds up to 65535 alphanumeric, character, and empty values.

Note:

- To provide a string that includes a dollar sign (\$), you must enter two dollar signs. For example, if you enter `Pay $$5.00`, the output will be `Pay $5.00`.
 - The values or variables that you can specify for the String package are predefined. See [Predefined variables](#)
-
- In the **Select the destination string variable** field, specify the variable.

Using Extract text action of String package

Use the **Extract text** action to extract a range of text using logical operators from the source string.

Review the information in [Extract text](#).

To extract a substring from the specified source string, do the following:

1. In the **Actions** palette, double-click or drag the **Extract text** action from the **String** package.
2. In the **Source string** field, specify the source string.
3. Specify the text to extract by selecting from the following options:

Option	Steps
Before	<p>Extracts the entire text followed by the value that you have provided in the Start after text field.</p> <ol style="list-style-type: none"> a. In the Start after text field, enter a string to use as the starting point. b. In the Occurrence field, enter a value to specify the number of occurrences. <p>For example, if the source string is <code>This is a test string</code> which is used to extract specific sub-string and you want to extract the entire text after <code>This</code>. To extract the required text, you must enter <code>This</code> in the Start after text field and <code>1</code> in the Occurrence field. This indicates to the system to extract the text that is available after the first occurrence of <code>This</code> in the source string.</p>
Before and/or after	<p>Extracts the text between the values provided in the Start after text and the End before text fields.</p> <ol style="list-style-type: none"> a. In the Start after text field, enter a string to use as the starting point. b. In the OR or AND field, select one of the options: <ul style="list-style-type: none"> • OR: Select to extract text if either of the values specified in the Start after text or the End before text field are available in the source string. • AND: Select to extract text if both the values specified in the Start after text and the End before text fields are available in the source string. c. In the End before text field, specify a string to use as the endpoint for extracting the text. d. In the Occurrence field, enter a value to specify the number of occurrences of the string you have provided in the End before text field. <p>For example, if the source string is <code>This is a test string</code> which is used to extract specific substring and you want to extract the entire text before <code>specific</code>. To extract the required text, you must enter <code>specific</code> in the End before text field and <code>1</code> in the Occurrence field. This indicates to the system to extract the text available before the first occurrence of <code>specific</code> in the source string.</p>

Option	Steps
After	<p>Extracts the entire text preceding the value you have provided in the End before text field.</p> <ol style="list-style-type: none"> a. In the End before text field, specify a string to use as the endpoint for extracting the text. b. In the Occurrence field, enter a value to specify the number of occurrences of the string you have provided in the End before text field. <p>For example, if the source string is <code>This is a test string which is used to extract specific substring and</code> you want to extract the entire text before <code>specific</code>. To extract the required text, you must enter <code>specific</code> in the End before text field and <code>1</code> in the Occurrence field. This indicates to the system to extract the text available before the first occurrence of <code>specific</code> in the source string.</p>

4. In the **If no match found, return** field, select one of the options:
 - **Source String:** Return the source string.
 - **Empty (null) String:** Return the null string if no match is found.
5. In the **When extracting** field, select one of the following options:
 - **Match case:** Matches the case of the text in the source string
 - **Do not match case:** Does not match the case of the text in the source string

Note: By default, the **Match case** option is selected for all the new and existing bots.

6. In the **Number of characters to get** field, select one of the options:
 - **All:** Extracts all characters from the source string.
 - **Only:** Specify the number of characters to extract from the source string.
7. In the **Trim the extracted text (remove blank spaces)** check box, select to remove blank spaces from the extracted text.
8. In the **Remove Enter from the extracted text** check box, select to remove carriage returns from the extracted text.
9. In the **Assign the output to variable** list, specify the variable.
10. Click **Save**.

Extract text

The **Extract text** action enables you to extract text from a source string. You can extract text that occurs in the range of 1 to 999999 times in a file before, after, or between two strings.

Using the **After** Option

This option enables you to extract the entire text followed by the value you have provided in the **Start after text** field. You can also extract the text based on the occurrence of the value you have provided in the field.

For example, `a:123a:123b:123c:` is the source string, you can specify `'1`' in the **Start after text** field and `'2`' in the **Occurrence** field to extract the string followed by the second occurrence of `'1`' in the source string. In this example, the extracted text is `'123b:123c:'`.

Using the **Before** Option

This option enables you to extract the entire text preceding the value you have provided in the **End before text** field. You can also extract the text based on the occurrence of the value you have provided in the field.

Note: You can extract text that occurs more than 1000 times in a file and up to a maximum of 999999 times.

For example, `a:123a:123b:123c:` is the source string, you can specify `'1`' in the **End before text** field and `'3`' in the **Occurrence** field to extract the string preceding the third occurrence of `'1`' in the source string. In this example, the extracted text is `'a:123a:123b'`.

Using the **Before and/or after** option

This option enables you to extract the text between the values you have provided in the **Start after text** and the **End before text** fields. You can also apply the **AND** or **OR** logical operator. You can select the **AND** operator to extract text only when both conditions specified for the **Before** and **After** options are satisfied. Otherwise, you can select the **OR** operator to extract text only when either of the conditions specified for the **Before** or the **After** option is satisfied.

For example, `a:123a:123b:123c:` is the source string, you can specify `'1`' in the **Start after text** and **End before text** fields and `'2`' in the **Occurrence** fields to extract the string after the second and before the fourth occurrence of `'1`' in the source string. In this example, the extracted text is `'123b:123c'`.

Compare action

The **Compare** action in the **String** package enables you to compare two strings.

Settings

- In the **Source string** field, specify the source string.
- In the **Compare to string** field, specify the string that the source has to be compared with.
- In the **When comparing** field, select an option:
 - **Match case:** Matches capitalization.
 - **Do not match case:** Does not match capitalization.
- In the **Assign the output to variable** list, specify the Boolean variable.

Evaluate variable action

The **Evaluate variable** action in the **String** package enables you to compare the user-specified string variable with the string variables in the bot and if a match is found, the action returns the value of the matching variable.

Settings

- Enter the string variable to search for.

- In the **Assign the value to a variable** field, select a string variable to hold the returned value.

Example:

1. Create a variable of type string whose value you want to evaluate and name it `var1`. Here the value of the variable `var1` is `$cityname$` and `$cityname$` has the value `Paris`.
2. Enter `$var1$` in the **Variable expression** field.
3. On bot execution, the user specified string variable `$var1$` now searches among the variables defined in the bot for the string variable `$cityname$` and if the match is found then the action returns the output value of the matched variable `$cityname$`, that is, `Paris`.

Note: This action can evaluate only string variables and up to one level of nesting.

Using Find action of String package

Use the **Find** action to find a substring within the specified string.

This action also enables you to perform a search based on a regular expression. A regular expression is a sequence of characters that define a search pattern. For example, to find all email addresses in the source string, specify the following as a regular expression: `\b[A-Z0-9._%~]+@[A-Z0-9.-]+\.[A-Z]{2,4}\b`.

Note: To search for strings that contain the dollar sign (\$), you must enter the sign twice. Otherwise, the bot interprets the dollar sign as a regular expression character.

To find a substring from the specified string, follow these steps:

1. In the **Actions** palette, double-click or drag the **Find** action from the **String** package.
2. In the **Source string** field, specify the source string.
3. In the **Find string** field, specify the substring.
4. In the **When finding** field, select one of the options:
 - **Match case:** Matches the case of the text.
 - **Do not match case:** Does not match the case of the text.
5. In the **The "find string" is** field, select one of the options:
 - **A regular expression:** The substring is a regular expression
 - **Not a regular expression:** The substring is not a regular expression.
6. Optional: In the **Start from** field, specify the starting point.
For example, you want to replace `Red` in the source string with `Blue` in a paragraph. `Red` is in 10 instances in the paragraph and you want to replace only the third occurrence. Enter `3` in the **Start from** field to identify the third occurrence.
7. In the **Assign the output to variable** list, specify the number variable.
8. Click **Save**.

Length action

The **Length** action in the String package enables you to retrieve the string length.

Settings

- In the **Source string** field, specify the source string.

- In the **Assign the output to variable** list, specify the number variable.

Lowercase action

The **Lowercase** action in the String package enables you to convert the source string to lowercase.

Settings

- In the **Source string** field, specify the source string.
- In the **Assign the output to variable** list, specify the variable.

Generate random string action

The **Generate random string** action in the String package enables you to generate a string of uppercase and lowercase alphanumeric characters and assign it to a string variable.

Settings

- In the **String length** field, enter the number of characters in the generated string.

Note: The maximum number of characters is 300.

- In the **Enter the destination variable to assign the random string** field, specify the string variable.

Using Replace action

Use the **Replace** action to find a piece of text from the source string and replace it with another text.

A regular expression is a sequence of characters that define a search pattern. For example, to find all email addresses in the source string, specify the following as a regular expression: `\b[A-Z0-9._%~]+@[A-Z0-9.-]+\.[A-Z]{2,4}\b`.

Note: The **Replace** action might not replace the Carriage Return and Line Feed (CRLF) characters in a string when you use the Enter variable. To ensure that the characters are replaced, instead of the Enter variable, use the Newline variable.

To replace text from the specified string, follow these steps:

1. In the **Actions** palette, double-click or drag the **Replace** action from the **String** package.
2. In the **Source string** field, specify the source string.
3. In the **Find string** field, specify the substring.
4. In the **When finding** field, select one of the options:
 - **Match case:** Matches the case of the text.
 - **Do not match case:** Does not match the case of the text.
5. In the **The "find string" is** field, select one of the options:
 - **A regular expression:** The substring is a regular expression
 - **Not a regular expression:** The substring is not a regular expression.
6. Optional: In the **Start from** field, specify the starting position.

The action then starts from the value you specify in this field. For example, if you specify 5 in the **Start from** field for the source string "Big blue ocean", when the bot runs, the action ignores the four preceding characters ("Big", including the space character) and searches for the substring in "blue ocean".

7. Optional: In the **Count** field, specify the number of times the found string must be replaced. For example, in the source string "Big blue ocean, blue fish, blue sky", you want to replace the first two instances of "blue" with "green". Enter 2 in the **Count** field, 5 in the **Start from** field, and `green` in the **Replace with** field. When the bot runs, the action produces the output `green ocean, green fish, blue sky`.

Note: By default, the value in the **Count** field is set to -1, which means that all the instances of the found string will be replaced.

8. In the **Replace with** field, specify the text to replace the string.
9. In the **Assign the output to variable** list, specify the variable that will hold the new string.
10. Click **Save**.

Reverse action

The **Reverse** action in the String package enables you to reverse the source string.

Settings

- In the **Source string** field, specify the source string.
- In the **Assign the output to variable** list, specify the variable.

Using Split action

Use the **Split** action to split the specified string into multiple strings and store the output in a list variable.

To split a string into multiple strings, perform these steps:

1. In the **Actions** palette, double-click or drag the **Split** action from the **String** package.
2. In the **Source string** field, specify the source string.
3. In the **Delimiter** field, specify the character to split the string.

For example, comma (,), semicolon (;), pipe (|), slash (/ \), newline character (\n), or space.

In the delimiter text box, the newline character is not accepted for the Enter key as a line break. In that case, you can either press **F2** and select **Enter - String** from String section or input the `$$String:Enter$` variable.

4. In the **Delimiter is** field, select one of the options:
 - **Case sensitive:** The delimiter is case-sensitive.
 - **Not case sensitive:** The delimiter is not case-sensitive.
5. In the **Split into substrings** field, select one of the options:
 - **All possible:** Splits the source string into as many substrings as possible. For example, if the original string is a,b,c,d, each character becomes a substring.
 - **Only:** Limits the number of substrings. For example, if the original string is a,b,c,d, and you enter 3, the output is three strings: a, b, and c,d.

6. In the **Assign the output to list variable** field, specify the list variable.
7. Click **Save**.

Substring action

The **Substring** action in the String package enables you to extract a substring from a string.

Settings

- In the **Source string** field, specify the source string.
- In the **Start from** field, specify the starting point.
- **Optional:** In the **Length** field, specify the length.
- In the **Assign the output to variable** list, specify the variable.

To boolean action

The **To boolean** action in the String package enables you to convert a string to a Boolean.

Settings

- In the **Select string variable** variable field, specify the source string variable.
- In the **Select the boolean variable to store the result** field, specify the Boolean variable.

To locale number action

The **To locale number** action in the String package enables you to convert a string to a locale-formatted number.

Settings

- In the **Source value** field, specify the source string.
- Select any of the following tab to specify locale:
 - **Specify:** Manually specify the two letter ISO codes for the locale you want to use in the **Locale** field.
 - **Device:** Use the default locale configured for the device.
- In the **Save the outcome to a variable** list, specify the variable.

You can also use the action in an expression. For example, `$prompt-assignment.String:toLocaleNumber("en-US")$`.

To number action

The **To number** action in the String package enables you to convert a string to a number.

Settings

This action supports positive, negative, and decimal numbers.

Note: If the string contains commas, remove them by using the **Replace** action to replace each comma with an empty string.

- In the **Enter the string** field, specify the source string.
- In the **Assign the output to variable** field, specify the number variable.

Trim action

The **Trim** action in the String package enables you to trim blanks, whitespaces, tabs, and line breaks from a string.

Settings

- In the **Source string** field, specify the source string.
- In **Trim from the beginning** and **Trim from the end**, select options.
- In the **Assign the output to variable** field, specify the variable.

Uppercase action

The **Uppercase** action in the String package enables you to convert the source string to uppercase.

Settings

- In the **Source string** field, specify the source string.
- In the **Assign the output to variable** list, specify the variable.

Import string from text file action

The **Import string from text file** action in the String package enables you to import values from a variable in a text file into a string variable.

Settings

- Select the text file from the Control Room, desktop, or a file variable.
- In the **Variable key** field, specify the variable that holds the values to import. This field is **not** case-sensitive.

When a bot runs this action, it retrieves the values between the = sign and line break.

- In the **Assign the output to variable** list, specify the variable.

Note: If you built a bot using this action from the String package from Build 5322 or earlier, the action will be missing when you open the bot with the default package version. You must reinsert the action and repopulate the fields.

System package

Use the actions in the **System** package to automate locking, logging off, restarting, and shutting down the computer. Use these actions at the end of a task.

The **System** package includes the following actions:

Note: If you are on Automation 360 v.22 (Build 10526) or a later version, we recommend that you use the Automation 360 v.22 or a later System package version to run your bots seamlessly.

Action	Description
Get environment variable	See Environment variables for System package
Lock computer	Locks the computer.
Logoff	Logs the user off the computer.
Restart	Restarts the computer.
Shutdown	Shuts down the computer.

Related tasks

[Using Log To File action](#)

Using the Log To File action, you can create a log file with data about the events that occur when a TaskBot runs.

Related reference

[Application package](#)

Use the **Open Program/File** action in the **Application** package to launch an application or a file. This action supports .exe, .bat, script files, or shortcut paths.

Environment variables for System package

Select from the list of variables in the **Get environment variable** action to return the system parameters of the device on which a bot is running.

Variable	Description	Example value
ALLUSERSPROFILE	Returns the path to the directory that contains resources and settings used by all system accounts. Note: Use <i>ProgramData</i> for devices that run Windows Vista and later OS.	C:\ProgramData
APPDATA	Returns the file path to the application data directory. This directory contains the settings for applications shared across multiple devices.	C:\Users\ <user>\AppData \Roaming</user>
COMPUTERNAME	Returns the device name without the domain.	AA-NY-FRANKSINATRA
CommonProgramFiles	Returns the file path to the <code>Common Files</code> directory.	C:\Program Files \Common Files
CommonProgramFiles(x86)	Returns the file path to the <code>Common Files</code> directory. Note: This is only available for devices that run 64-bit version.	C:\Program Files (x86)\Common Files

Variable	Description	Example value
CommonProgramW6432	Returns the file path to the <code>Common Files</code> directory. Note: <ul style="list-style-type: none"> This is only available for devices that run 64-bit version. Only use <code>CommonProgramW6432</code> for devices that run Windows Vista and later OS 	C:\Program Files \Common Files
ComSpec	Returns the file path to the command processor	C:\Windows \system32\cmd.exe
DriverData	Returns the file path to the <code>Driver Data</code> directory.	C:\Windows \System32\Drivers \DriverData
HOMEDRIVE	Returns the home drive of the device.	C:
HOMEPATH	Returns the homedir of the device without the system drive.	\Users\ <user>< td=""> </user><>
LOCALAPPDATA	Returns the file path to the application data directory. This directory contains the settings for applications shared across multiple devices.	C:\Users\ <user> </user> \AppData\Local
LOGONSERVER	Returns the name of the group or domain to which the device is connected	\\SJC SRVBKP
NUMBER_OF_PROCESSORS	Returns the number of processors in the device.	4
OneDrive	Returns the path to the OneDrive folder.	C:\Users\ <user> </user> \OneDrive
OS	Returns the device operating system name.	Windows_NT
Path	Returns a semicolon-delimited list of directories that contain executable programs.	C:\Windows \system32;C: \Windows;C: \Windows \System32\Wbem;C: \Windows \System32\WindowsPowerShell \v1.0\
PATHEXT	Returns a semicolon-delimited list of file extensions that the system can execute.	.COM;.EXE;.BAT;.CMD;.VBS;.VBE
PROCESSOR_ARCHITECTURE	Returns the process architecture of the device.	AMD64

Variable	Description	Example value
ProgramData	Returns the path to the directory that contains resources and settings used by all system accounts. Note: Use <i>ALLUSERSPROFILE</i> for devices that run the Windows XP and earlier OS.	C:\ProgramData
ProgramFiles	Returns the path to the directory that stores installed programs.	C:\Program Files
ProgramFiles(x86)	Returns the path to the directory that stores installed programs. Note: This is only available for devices that run 64-bit version.	C:\Program Files (x86)
ProgramW6432	Returns the path to the directory that stores installed programs.	C:\Program Files
PSModulePath	Returns file paths to the modules that are installed on the disk.	%ProgramFiles%\WindowsPowerShell\Modules;C:\Windows\system32\WindowsPowerShell\v1.0\Modules
PUBLIC	Returns the <code>Public</code> folder path.	C:\Users\Public
SystemDrive	Returns the device system drive.	C:
SystemRoot	Returns the system root folder.	C:\Windows
TMP	Returns the path to the directory that stores temporary files.	C:\Users\ <user>\AppData\Local\Temp</user>
TEMP	Returns the path to the directory that stores temporary files.	C:\Users\ <user>\AppData\Local\Temp</user>
USERDNSDOMAIN	Returns the DNS domain of the user.	AAI.AASPL-BRD.COM
USERDOMAIN	Returns the domain of the user.	AAI.AASPL-BRD.COM
USERDOMAIN_ROAMINGPROFILE	Returns the domain of the user profile.	AAI
USERNAME	Returns the logged-in user name.	bob.ross
USERPROFILE	Returns the user profile path.	C:\Users\ <user></user>
windir	Returns the Windows directory path.	C:\Windows

Task Bot package

Use the **Run**, **Pause**, and **Stop** actions in the Task Bot package to manage running one or more child bots from a parent bot or with a third-party software using an API.

Build smaller bots that automate a single task and run them from a parent bot. For example, build a `Login` child bot to enter the username and password into a web form and click submit. The `Login` child bot accepts credentials from the parent bot and returns a success message, and then the parent bot can call the subsequent `CreateInvoice` child bot. The `Login` child bot should also contain error handling logic in case the credentials are incorrect.

This practice of building smaller, self-contained bots enables a user to reuse the bot logic in a greater number of tasks, and makes error handling and troubleshooting easier. This also decreases the amount of time spent building and maintaining bots. As a result, an organization is able to rapidly scale their automation initiatives. The `Login` child bot from this example can be reused in any task that involves providing credentials to a login page on a website.

When you run a TaskBot that calls itself repeatedly until you choose to stop it, the bot runs infinitely and, as a result, encounters an error related to stack memory issues. We recommend that you create a parent and a child bot with different names and then run the child bot from the parent bot.

Note:

- CSV/text file and Recorder sessions cannot be shared across bots. You can share Excel sessions across bots by using a session variable. See [Example of sharing an Excel session between bots](#).
- When you use a file type variable in the Run Task, ensure you have set the default value in the variable. Without default value, the bot displays an error on execution.

In addition, running child bots from a parent bot offers greater control over data in the following ways:

- Users can configure the variables in the child bot to control the direction in which information can be exchanged by selecting from the following options:
 - **Use as input:** The variable holds a value that the child bot accepts from a parent bot or third-party software.
 - **Use as output:** The variable holds a value that the child bot passes to the parent bot or third-party software.
 - **Both:** The value can be passed in both directions.
 - **Neither:** The variable is confined to this bot; it cannot be shared across other bots.

See [Create a variable](#)

- Other users can reuse child bots without viewing their contents.

The **Task Bot** package includes the following actions:

Action	Description
Pause	See Pause action .
Run	<ul style="list-style-type: none"> • See Using the Run action.. • For an example, see Example of using the Run action.
Stop	See Stop action .

Pause action

The **Pause** action in the Task Bot package enables you to temporarily pause the running bot.

Settings

Temporarily pauses the running bot. Use the **Pause** action to modify data or to verify the status of a relevant component.

When the bot reaches the **Pause** action during run time, a **Resume** button appears. You must click **Resume** for the bot to continue to the next action.

Using the Run action

The **Run** action from the TaskBot package enables you to run one or more child bots. Configure the action to run the child bots repeatedly or with a delay, and to pass and retrieve values.

The action runs the selected task multiple times for a specified number of times or for a number of hours. The task can be repeated until the user chooses to stop it. You can save the output values to a dictionary variable, where each key in the dictionary is the variable name and corresponding value from the child bot. Or, you can map each dictionary key to a variable to store the corresponding value.

Note: When you create a TaskBot with dependencies, ensure that the both the parent and child bot are in the same workspace (public or private). You cannot call a public bot from a private bot. To do so, you should first either check-out or clone the public bot into the private workspace and then check-in both the bots to the public workspace.

1. In the **Actions** palette, double-click or drag the **Run** action from the **Task Bot** package.
2. In the **Task Bot to run** field, select the child bot:

Option	Description
Current Task Bot	Runs the current bot recursively.
Control Room file	<p>Select a bot that you want to run:</p> <ul style="list-style-type: none"> • Click the Browse tab if you want to select a bot from your private workspace. The location of the selected bot in the private repository is also displayed. • Click the Search tab if you want to search for a bot from the public workspace and your private workspace. Suggestions about the bots available in the public and private workspaces are displayed when you start typing the name of the bot you want to run. The location of the selected bot in the public and the private workspaces is also displayed.

Option	Description
Variable	Select from the following options: <ul style="list-style-type: none"> • File: Insert a file variable that contains a bot. • Control Room path: Enter an expression beginning with <code>Bots</code> that contains a string variable to specify the bot. For example <code>Bots/\$department\$/PTOReport</code>. <hr/> Note: <ul style="list-style-type: none"> • The file path is case-sensitive. • The bot must be in the same workspace as the parent bot. <hr/>

3. In the **Input values** fields, enter the values or variables to pass to the child bot:

Note: You can pass a Window type variable from a parent bot to a child bot.

- a) Select an input variable to activate the text field.
- b) Enter a value of the required data type.
The icon on the left-side of the text field indicates the data type.

If you are configuring a bot with many input variables, use the **Quick map** option to automatically map variables that share the same name and data type. If the child bot contains variables for which there are no corresponding variables in the parent bot, the **Quick map** option creates new variables and maps them.

4. Optional: Select the repetition.
5. Optional: Select the **Delay between repetitions** option and enter the delay time in the **Minutes** and **Seconds** fields.
6. Optional: Select the **Upon error continue with next repetition or action in this bot** option. For alternative error-handling options, use actions from the Error handler package.

Error handler package

7. In the **Save outcome to a variable** field, select either the **Multiple variables** or **Dictionary** option:

Option	Description
Multiple variables	<p>Click Add variable mapping to associate each dictionary key with a variable in the parent bot.</p> <p>Use this option if you do not want to use actions to extract the dictionary values.</p> <p>Use the Multiple Variables option to assign the output of the child bot to multiple variables directly. Using this option, you can set the multiple values returned by the child bot into the dictionary variable of the parent bot. You no longer need to assign the multiple outputs of the child bot to the individual variables of the parent bot using variable assignment commands. You can use the Dictionary package in the parent bot to extract the individual value assigned to the dictionary variable of the parent bot.</p> <p>For example, when you migrate Enterprise 11 bots, many output variables need to be assigned individually after the Run task action, which increases the size of the bot. You can directly set parent bot variables within the Run task action using the multiple variables option.</p>
Dictionary	<p>Insert or create a dictionary variable to hold the output variables and values in key-value pairs.</p> <p>Each key in the dictionary is the variable name and corresponding value from the child bot.</p>

8. Click **Save**.

For an example of using this action:

- [Example of using the Run action](#)
- [Example of sharing an Excel session between bots](#)

Repeating a bot

Repeat a bot after run failure or when running routine bots.

Options for repeating a bot

Do not repeat

Default. The bot runs once.

Repeat N times

Repeats the bot specified number of times.

Repeat for time unit

Repeats the bot for a time period (hh:mm:ss).

Note: Specify up to 99 hours, 59 minutes, or 59 seconds.

Repeat until stopped by user

Repeats the bot until being stopped manually by clicking the **stop** button or by pressing the **ESC** key.

Delay between repetitions

Sets a duration of time to wait before repeating a bot (mm:ss).

Upon error continue with next repetition or action in this bot

The bot is repeated regardless of run failure.

Note: Error handling cannot capture the error when this option is enabled.

Stop action

The **Stop** action in the Task Bot package enables you to stop the running bot.

Settings

For example, use the **Stop** action to terminate the bot if a condition is met, such as if the bot encounters a file larger than 100 MB.

Example of sharing an Excel session between bots

Build two bots to update the employee salaries in a worksheet. In this example, one bot opens an Excel worksheet and passes the session name as a variable to the second bot, which iterates through the worksheet, calculates each employee's new salary, and updates the value in the worksheet.

Create a worksheet with the following data:

Employee ID	Start date	Salary
200	1/12/2020	50000
233	3/15/2018	75000
500	6/6/2020	60000
555	7/9/2019	65000

Build the child to iterate through the table of employees and update each salary to reflect the raise.

1. Open a new bot.
 - a) From Automation Anywhere web interface, on the left panel, click **Automation**.
A list of available bots and forms is displayed.
 - b) Click **Create a bot**.
 - c) Enter the bot name `RaiseSalaries`.
 - d) Enter the folder location `\Bots\TaskBotExample`.
To change where your bot is stored, click **Choose** and follow the prompts.
 - e) Click **Create and Edit**.
2. Create the following variables:
 - `sessionVariable`: session type; MS Excel subtype; use as input
 - `sCellAddress`: string type; default value of C2
 - `sSalary`: string type

- nSalary: number type
3. Use a **Loop** action to iterate through all the rows in the worksheet.
 - a) Double-click or drag the **Loop** action.
 - b) Select the **For each row in worksheet** iterator.
 - c) Select the **Shared session** tab and insert `$sessionVariable$`.
 - d) Select the **Read cell value** option.
 - e) In the **Assign the current value to this variable** field, create a record variable.
 4. Retrieve the employee's salary.
 - a) Drag into the Loop container the **Excel Advanced > Get single cell** action.
 - b) Select the **Shared session** tab and insert `$sessionVariable$`.
 - c) Select the **Specific cell** option and insert `$sCellAddress$`.
 - d) Select the **Read cell value** option.
 - e) In the **Store cell contents to** field, insert `$sSalary$`.
 5. Convert the salary value to a number data type.
 - a) Drag into the Loop container the **String > To number** action.
 - b) In the **Enter the string** field, insert `$sSalary$`.
 - c) In the **Assign the output to variable** field, insert `$nSalary$`.
 6. Calculate the new salary to be five percent greater than the current salary.
 - a) Drag into the Loop container the **Number > Assign** action.
 - b) In the **Select source variable** field, enter `$nSalary$*1.05`.
 - c) In the **Select destination variable** field, insert `$nSalary$`.
 7. Update the salary in the worksheet.
 - a) Drag into the Loop container the **Excel Advanced > Set cell** action.
 - b) Select the **Shared session** tab and insert `$sessionVariable$`.
 - c) Select the **Specific cell** option and insert `$sCellAddress$`.
 - d) In the **Cell value** field enter `$nSalary.Number:toString$`.

Note: You must convert the value to a string data type before the bot can enter it into the worksheet. Use type casting as an alternative to the **Number > To string** action. *Type conversion*

8. Move the cursor down by a single cell and assign that cell address to `sCellAddress`.
 - a) Drag into the Loop container the **Excel Advanced** > **Go to cell** action.
 - b) Select the **Shared session** tab and insert `$sessionVariable$`.
 - c) Select the **Active cell** and **One cell below** options.
 - d) Drag into the Loop container the **Excel Advanced** > **Get cell address** action.
 - e) Select the **Shared session** tab and insert `$sessionVariable$`.
 - f) Select the **Active cell** option.
 - g) In the **Save active cell address** field, insert `$sCellAddress$`.

9. Click **Save** and **Close**.

Build the parent bot.

10. Open a new bot.

- a) Click **Create a bot**.
- b) Enter the bot name `ExcelParentBot`.
- c) Enter the folder location `\Bots\TaskBotExample`.
To change where your bot is stored, click **Choose** and follow the prompts.
- d) Click **Create and Edit**.

11. Create the following variable:

`sessionVariable`: session type; MS Excel subtype

12. Open the Excel worksheet.

- a) Double-click or drag the **Excel Advanced** > **Open** action.
- b) In the **Session name** field, enter `Session1`.
- c) In the **File path** field, enter the file path to the worksheet you created above.
- d) Select the **Sheet contains header** option.

13. Assign the session to a variable.

- a) Double-click or drag the **Excel Advanced** > **Set session variable** action.
- b) In the **Session name** field, enter `Session1`.
- c) In the **Save session to a variable** field, select `$sessionVariable$`.

14. Select the child bot you built in the above.

- a) Double-click or drag the **Task Bot** > **Run** action.
- b) Click the **Control Room file** option and click **Browse** to select the `RaiseSalaries` bot.
- c) In the **Input values** section, select the **Set SessionVariable** option and insert `$sessionVariable$`.

15. Click **Save** and **Run**.

The Excel worksheet opens and the value of each cell in the third column increases by five percent.

Terminal Emulator package

The **Terminal Emulator** package contains actions that enable you to connect to and automate tasks on another machine. Use these actions to access and control operations on a remote machine. For example, you can run applications and access files on a different operating system.

The Terminal Emulator enables a machine to connect to and communicate with another machine using a command-line or graphical interface. The Terminal Emulator uses the Telnet or SSH protocol to communicate with other machines.

The Terminal Emulator supports ANSI, TN3270E, TN5250E, and VT100 terminal types.

Important: If you use different versions of the Terminal Emulator package in a parent bot and a child bot, the capability to share a session across bots is currently not supported. To share a session across parent and child bots, ensure that you use the same version of the package in both the parent and child bots.

Before you start

Important: Before you establish a connection to a different terminal type, ensure that you have Visual C++ 2019 Redistributable Package installed on your system. If you are on an Automation 360 version earlier than A2019.14 (Build 5322), you must install Visual C++ 2013 Redistributable Package or Visual C++ 2015 Redistributable Package on your system.

Perform the following actions within the **Terminal Emulator** package as part of using the set of available actions:

1. Establish a connection with a host machine using the **Connect** action.

You must first establish a connection with a host machine to automate any Terminal Emulator related task. When establishing the connection, specify the details of the host machine and associate it with a session name. Use the session name provided in this action in the other actions so that you do not have to provide details of the host machine in those actions again. See [Using Connect action for Terminal Emulator](#).

Important: If you use any other action from this package before establishing the connection, you will encounter an error.

2. Use the Terminal Emulator actions to automate a task. For example, use the **Get field** action to retrieve the value from a particular field.
3. After you have automated all the Terminal Emulator related tasks, terminate the connection to the host machine using the **Disconnect** action.

Actions in the **Terminal Emulator** package

The **Terminal Emulator** package includes the following actions:

Action	Description
Clear terminal	Clear terminal action
Connect	Using Connect action for Terminal Emulator

Action	Description
Disconnect	<i>Disconnect action</i>
Get all fields	<i>Get all fields action</i>
Get field	<i>Get field action</i>
Get text	<i>Using Get text action for Terminal Emulator</i>
Hide terminal	<i>Hide terminal action</i>
Search field	<i>Search field action</i>
Send key	<i>Using Send key action</i>
Send text	<i>Using Send text action</i>
Set cursor position	<i>Set cursor position action</i>
Set field	<i>Using Set field action</i>
Set session variable	<i>Set session variable action</i>
Show terminal	<i>Show terminal action</i>
Wait	<i>Using Wait action</i>

Clear terminal action

The Clear terminal action in the Terminal Emulator package enables you to clear the screen of the terminal.

Settings

Specify the **Terminal emulator session name** that you used to establish a connection with the terminal using the **Connect** action.

Using Connect action for Terminal Emulator

Use the **Connect** action to establish a connection with a host machine on which you want to automate a task. You can use this action to establish a connection with the TN3270E, TN5250E, ANSI, VT220, and VT100 terminal types.

This action enables you to specify the details of the host machine and associate it with a session name. Use the session name provided in this action in the other actions, so that you do not have to provide details of the host machine in those actions again.

Important: If you use any other action from this package before establishing the connection, you will encounter an error.

To establish a connection with a host machine, perform the following steps:

1. Double-click or drag the **Connect** action from the **Terminal Emulator** node in the **Actions** palette.

2. Specify a name for the session in the **Terminal emulator session name** field.

Note: Use the different session name to open multiple terminal windows. If you want to use the same session name, you must first close the session of the first terminal window before using the same session name for another terminal window.

3. Specify the **Host name** of the machine you want to connect to:
- Click the **Credential** tab to select an entry from the Credential Vault.
 - Click the **Variable** tab to use a variable to specify the host name.
4. Enter a value in the **Port** field to specify the port you want to use to connect to the host.
5. Select one of the following options to specify the terminal type:

Option	Steps
ANSI	<p>Select an option from the Connection type list to specify the type of connection you want to establish:</p> <ul style="list-style-type: none"> • Telnet • SSH2 <p>For SSH2 connection type:</p> <ul style="list-style-type: none"> • For User authentication: <ul style="list-style-type: none"> • User name: Click the Credential tab to select an entry from the Credential Vault. You can also click the String tab to enter a value manually. • For Password: Click the Credential tab to select an entry from the Credential Vault. You can also click the String tab to enter a value manually. • For Key file authentication: Click one of the following options to specify the location of the file: <ul style="list-style-type: none"> • Control Room file: Enables you to select a PDF file that is available in a folder. • Desktop profile: Enables you to select a PDF file that is available on your device. • Variable: Enables you to specify the file variable that contains the location of the PDF file. • For User name: Click the Credential tab to select an entry from the Credential Vault. You can also click the String tab to enter a value manually.

Option	Steps
TN3270E	<p>a. Select an option from the Host name security list to specify the security you want to use:</p> <ul style="list-style-type: none"> • NONE • SSL • TLS <p>b. Select the Enable TN3270E support check box if you want to choose a connection method.</p> <p>Select an option from the Connection method list:</p> <ul style="list-style-type: none"> • GENERIC: Enables you to specify the Device name. • SPECIFIC: Enables you to specify the Device name and Resource (LU) Name. <p>c. Select an option from the Terminal model list to specify the terminal workstation you want to connect to.</p> <p>d. Select an option from the Code page list to specify the encoding you want to use for the terminal.</p>
TN5250E	<p>a. Select an option from the Host name security list to specify the security you want to use:</p> <ul style="list-style-type: none"> • NONE • SSL • TLS <p>b. Select the Enable TN5250E support check box if you want to specify details about the device and resource.</p> <p>Enter a value in the Device name and Resource (LU) Name fields.</p> <p>c. Select an option from the Terminal model list to specify the terminal workstation you want to connect to.</p> <p>d. Select an option from the Code page list to specify the encoding you want to use for the terminal.</p>

Option	Steps
VT Series <ul style="list-style-type: none"> • VT100 • VT220 	<ol style="list-style-type: none"> a. Select an option from the Terminal model list to specify the terminal type you want to connect to. b. Select an option from the Encoding list to specify the encoding you want to use for the terminal: <ul style="list-style-type: none"> • ANSI • DBCS • UTF-8 <p>The CodePage field appears when DBCS option is selected. The CodePage supports only Japanese Shift-JIS (932).</p> c. Select an option from the Connection type list to specify the type of connection you want to establish: <ul style="list-style-type: none"> • Telnet • SSH2 <p>For SSH2 connection type:</p> <ul style="list-style-type: none"> • For User authentication: <ul style="list-style-type: none"> • User name: Click the Credential tab to select an entry from the Credential Vault. You can also click the String tab to enter a value manually. • For Password: Click the Credential tab to select an entry from the Credential Vault. You can also click the String tab to enter a value manually. • For Key file authentication: Click one of the following options to specify the location of the file: <ul style="list-style-type: none"> • Control Room file: Enables you to select a PDF file that is available in a folder. • Desktop profile: Enables you to select a PDF file that is available on your device. • Variable: Enables you to specify the file variable that contains the location of the PDF file. • For User name: Click the Credential tab to select an entry from the Credential Vault. You can also click the String tab to enter a value manually.

6. Select the **Show terminal window** check box to show the terminal window when the bot runs this action.
7. Select the **Set cursor position to the beginning** check box to edit the screen of the Terminal emulator session manually and set the focus to the first editable field.
8. Select the **Wait for the terminal prompt to appear while connected** check box to wait for the terminal prompt to appear on the screen of the terminal after the connection is established.
 - a) Enter the text you want to display when you connect to the terminal in the **Terminal prompt** field.
 - b) Enter a value in the **Wait time out** field to specify the period in (milliseconds) the system must wait before the connection request is timed out.

9. Select any of the following tabs to create a terminal emulator session:

- **Local session:** Specify a session name that can be used only in the current bot.
- **Global session:** Specify a session name that can be used across multiple bots such as parent bots, child bots, and other child bots of the parent bots.
- **Variable:** Specify a session variable that can be used to share that session with other child bots.

Disconnect action

The Disconnect action in the Terminal Emulator package enables you to terminate the connection with the terminal.

Settings

Specify the **Terminal emulator session name** that you used to establish a connection with the terminal using the **Connect** .

Get all fields action

The Get all fields action in the Terminal Emulator package enables you to retrieve the values of all fields and assigns them to a table variable.

Settings

- Specify the **Terminal emulator session name** that you used to establish a connection with the terminal using the **Connect** .
- Select a table variable to store the retrieved data from the **Assign the value to an existing table variable** list. The table stores each field as a row, with the values of each field organized in the following columns:
 - Field index
 - Field name
 - Field value
 - Is Editable (yes/no)
 - Is Hidden (yes/no)

Note: You can use this action with the TN3270E and TN5250E terminal types.

Get field action

The Get field action in the Terminal Emulator package enables you to retrieve the value of a field based on the index or name of the field and assigns it to a string variable.

Settings

- Specify the **Terminal emulator session name** that you used to establish a connection with the terminal using the **Connect** .
- Select the **By index** option to retrieve the value of a field based on its index, or select the **By name** option to retrieve the value of a field based on its name.

- Select a string variable to store the retrieved data from the **Assign the value to an existing variable** list.

Note: You can use this action with the TN3270E and TN5250E terminal types.

Using Get text action for Terminal Emulator

Use the **Get text** action to retrieve text from the terminal and store it in a string variable. This action enables you to retrieve text from the last line, all lines, or a range of lines. You can use this action with the TN3270E, TN5250E, ANSI, and VT100 terminal types.

To retrieve text from the terminal, do the following:

1. Double-click or drag the **Get text** action from the **Terminal Emulator** node in the **Actions** palette.
2. Enter the name of the session that you have used to establish a connection with the terminal using the **Connect** action in the **Terminal emulator session name** field.
3. Select an option from the **Get text** list to specify the lines from which you want to retrieve text:
 - **Last line:** Retrieves text from the last line of the terminal.
 - **All lines:** Retrieves text from all lines of the terminal.

Select from the following options to extract text from a specific area, viewable area, or the entire page displayed on the screen.

- **Viewport:** Retrieves text from the visible area of the Terminal Emulator window.
- **Number of lines from top:** To retrieve text corresponding to a specific number of lines from the top of the screen.
- **Full page capture (with scroll):** Retrieves all the lines on the screen, including the content that needs to be scrolled to access it.

Note: The **Full page capture (with scroll)** and **Number of lines from the top** options are supported only for **ANSI** and **VT Series** terminals. If you connect with other terminal types, regardless of the option selected, the extracted text displays the results similar to how they are displayed for the **Viewport** option.

- **Lines from-to:** Retrieves text from the specified range of lines of the terminal. You must enter values in the **Start row** and **End row** fields to specify the range.

Note: You can specify a value of 1 through 999.

4. Select a string variable from the **Assign the value to an existing variable** list to assign the retrieved text to that variable.
5. In the **Assign value to variable** list, select a string variable.

Hide terminal action

The Hide terminal action in the Terminal Emulator package enables you to hide the terminal screen.

Settings

This action enables you to hide the terminal screen when the **Show terminal window** option from the **Connect** action is selected. It is useful when you do not want to display the terminal screen when a bot is performing certain tasks. Specify the **Terminal emulator session name** that you used to establish a connection with the terminal using the **Connect** .

Search field action

The search field action in the Terminal Emulator package enables you to search for the field based on the text it contains.

Settings

- From the **Terminal emulator session name** field, choose one of the following options:
 - **Local name** to establish a connection with the terminal using the **Connect** action
 - **Shared session** to share the variable from **Set session variable** or from the parent bot
- Specify the text based on which you want to search the field.
- Select an option from **Select field** to specify whether to retrieve the index or name of the field.
- Assign and save the output to a variable.

Note: The search text you enter must be a complete match and is not case-sensitive.

Using Send key action

Use the **Send key** action to send a key to the terminal. You can use these keys to perform various operations on the terminal. You can use this action with the TN3270E, TN5250E, ANSI, and VT100 terminal types.

To send a key to the terminal, do the following:

1. Double-click or drag the **Send key** action from the **Terminal Emulator** node in the **Actions** palette.
2. Enter the name of the session that you have used to establish a connection with the terminal using the **Connect** action in the **Terminal emulator session name** field.
3. Select an option from the **Select key to be send** list to specify the key you want to send.
4. Enter a value in the **Delay after send key command** field to specify the period the system must wait (in milliseconds) after the selected key is sent.
5. Select the **Wait for text or prompt to appear** check box if you want the system to wait for the prompt or certain text to appear on the terminal.
 - a) Select the **Prompt** option if you want the system to wait till the prompt appears on the terminal.
 - b) Select the **Text** option if you want the system to wait till the specific text appears on the terminal. You must provide the text you want to appear on the terminal in the **Text value to be appear on screen** field.
 - c) Select the **Wait before send key for prompt or text appear** check box if you want the system to wait for the prompt or the specified text to appear on the terminal before sending the selected key.
 - d) Select the **Wait after send key for prompt or text appear** check box if you want the system to wait for the prompt or the specified text to appear on the terminal after sending the selected key.
 - e) Enter a value in the **Time out for prompt or text to appear** field to specify the period (in seconds) the system must wait before the operation times out.
6. In the **Assign value to variable** list, select a string variable.

How send key works in Send text action

Learn how keys work in the **Send Text** action in the Terminal Emulator.

Note: Behavior of the keys that are marked with the asterisk (*) sign in the following tables is defined by the terminal host. The behavior might vary on different terminals.

The following table shows the behavior of the keys in the terminal types TN3270 and TN5250:

Keys	Behavior
KEY_BACKSPACE	Same behavior as the Backspace key on the keyboard.
KEY_BACKTAB	If the cursor is on the first position of a field, it moves to the previous field. Otherwise, it moves to the start of the current field.
KEY_CLEAR	Clears the entire text on the terminal screen.
KEY_ERASEINPUT	Deletes all the text in the field.
KEY_NEXTFIELD	Moves the cursor to the next field on the terminal screen.
KEY_ENTER	Sends Enter key to the terminal host.
KEY_HOME	Moves the cursor to the first editable field on the screen.
KEY_RESET	The reset key only clears the Keyboard lock, such as releasing the terminal if the terminal screen is not working. The screen text and input field values remain the same.
KEY_LEFT	Moves the cursor to the left by one position.
KEY_RIGHT	Moves the cursor to the right by one position.
KEY_UP	Moves the cursor up by one position.
KEY_DOWN	Moves the cursor down by one position.
KEY_PGLEFT	Nothing happens.
KEY_PGRIGHT	Nothing happens.
KEY_PGUP	Page Up key
KEY_PGDOWN	Page Down key
KEY_TABFORWARD	Performs a tab key action on the terminal screen to move the cursor to the next field.
KEY_PF1 *	Same behavior as F1 key on the keyboard.
KEY_PF2 *	Same behavior as F2 key on the keyboard.
KEY_PF3 *	Same behavior as F3 key on the keyboard.
KEY_PF4 *	Same behavior as F4 key on the keyboard.
KEY_PF5 *	Same behavior as F5 key on the keyboard.
KEY_PF6 *	Same behavior as F6 key on the keyboard.
KEY_PF7 *	Same behavior as F7 key on the keyboard.
KEY_PF8 *	Same behavior as F8 key on the keyboard.
KEY_PF9 *	Same behavior as F9 key on the keyboard.
KEY_PF10 *	Same behavior as F10 key on the keyboard.
KEY_PF11 *	Same behavior as F11 key on the keyboard.

Keys	Behavior
KEY_PF12 *	Same behavior as F12 key on the keyboard
KEY_PF13 *	Same behavior as Shift + F1 keys on the keyboard.
KEY_PF14 *	Same behavior as Shift + F2 keys on the keyboard.
KEY_PF15 *	Same behavior as Shift + F3 keys on the keyboard.
KEY_PF16 *	Same behavior as Shift + F4 keys on the keyboard.
KEY_PF17 *	Same behavior as Shift + F5 keys on the keyboard.
KEY_PF18 *	Same behavior as Shift + F6 keys on the keyboard.
KEY_PF19 *	Same behavior as Shift + F7 keys on the keyboard.
KEY_PF20 *	Same behavior as Shift + F8 keys on the keyboard.
KEY_PF21 *	Same behavior as Shift + F9 keys on the keyboard.
KEY_PF22 *	Same behavior as Shift + F10 keys on the keyboard.
KEY_PF23 *	Same behavior as Shift + F11 keys on the keyboard.
KEY_PF24 *	Same behavior as Shift + F12 keys on the keyboard.

Using Send text action

Use the **Send text** action to send text to the terminal. This action also enables you to send predefined keys after the text to perform various operations in the terminal. You can use this action with the TN3270E, TN5250E, ANSI, and VT100 terminal types.

The following keyboard shortcuts are supported in TN3270 and TN5250:

Key entry	Command
Shift + Control + A	Select all
Shift + Control + C	Copy
Shift + Control + X	Cut
Shift + Control + V	Paste

The following keyboard shortcuts are supported in ANSI and VT100:

Key entry	Command
Control + A	Select all
Control + C	Copy
Control + X	Cut
Control + V	Paste

To send a text to the terminal, do the following:

1. Double-click or drag the **Send text** action from the **Terminal Emulator** node in the **Actions** palette.
2. Enter the name of the session that you have used to establish a connection with the terminal using the **Connect** action in the **Terminal emulator session name** field.
3. Specify the **Text** you want to send to the terminal:
 - a) Click the **Credential** tab to select an entry from the Credential Vault.

- b) Click the **Variable** tab to use a variable that contains the text you want to send.
4. Select the **Send a key after sending the above text** check box if you want to send a key after sending the text.
- Select the key you want to send from the list.
 - Enter a value in the **Delay after send key command** field to specify the period (in milliseconds) the system must wait after sending the selected key.
5. Select the **Wait for text or prompt to appear** check box if you want the system to wait for the prompt or certain text to appear on the terminal.
- Select the **Prompt** option if you want the system to wait till the prompt appears on the terminal.
 - Select the **Text** option if you want the system to wait till the specific text appears on the terminal. You must provide the text you want to appear on the terminal in the **Text value to be appear on screen** field.
 - Select the **Wait before send key for prompt or text appear** check box if you want the system to wait for the prompt or the specified text to appear on the terminal before sending the selected key.
 - Select the **Wait after send key for prompt or text appear** check box if you want the system to wait for the prompt or the specified text to appear on the terminal after sending the selected key.
 - Enter a value in the **Time out for prompt or text to appear** field to specify the period (in seconds) the system must wait before the operation times out.
6. In the **Assign value to variable** list, select a string variable.

Set cursor position action

The Set cursor position field action in the Terminal Emulator package enables you to set the position of the cursor on the screen of the terminal.

Settings

- Specify the **Terminal emulator session name** that you used to establish a connection with the terminal using the **Connect** .
- Specify the row number in which to set the cursor in the **Set row** field.
- Specify the column number in which to set the cursor in the **Set column** field.

Note: You can enter a value of 1 through 999 to specify the row and column number where the cursor is set.

Using Set field action

Use the **Set field** action to set a value in a particular field in the terminal. This action also enables you to send predefined keys after the value to perform various operations in the terminal. You can use this action with the TN3270E, TN5250E, ANSI, and VT100 terminal types.

To set a value for a field in the terminal, do the following:

- Double-click or drag the **Set field** action from the **Terminal Emulator** node in the **Actions** palette.

2. Enter the name of the session that you have used to establish a connection with the terminal using the **Connect** action in the **Terminal emulator session name** field.
3. Specify the field for which you want to set a value:
 - a) Select the **By index** option to specify the field based on its index.
The index value starts from zero and ends at 99999. For example, if you want to set the value for the third field, you must specify 2 in this field.
 - b) Select the **By name** option to specify the location of the field.
For example, if you want to set the value for a field in the fifth column of the third row, you must specify `R3C5` in the field.
4. Specify the **Plain text value** you want to set in the specified field:
 - a) Click the **Credential** tab to select an entry from the Credential Vault.
 - b) Click the **Variable** tab to use a variable that contains the text you want to send.
5. Select the **Send enter key after setting field** check box if you want to send the enter key after setting the field.
This option performs the operation similar to pressing the Enter key after setting the value in the field.
6. Select the **Send a key after sending the above text** check box if you want to send a key after sending the text.
 - a) Select the key you want to send from the list.
 - b) Enter a value in the **Delay after send key command** field to specify the period (in milliseconds) the system must wait after sending the selected key.
7. In the **Assign value to variable** list, select a string variable.

Set session variable action

The Set session variable action in the Terminal Emulator package enables you to assign the session name to a variable.

Settings

Pass this session variable from the parent bot to a child bot by entering the variable as an input type variable in the child bot.

Show terminal action

The Show terminal action in the Terminal Emulator package enables you to show the terminal screen.

Settings

This action enables you to show the terminal screen when the **Show terminal window** option from the **Connect** action is not selected. It is useful when you want to display the terminal screen when a bot is performing certain tasks. You must specify Specify the **Terminal emulator session name** that you used to establish a connection with the terminal using the **Connect** .

Using Wait action

Use the **Wait** action to introduce a delay till specific conditions are met in the terminal. You can use this action to wait before executing the next action till the specific text appears on the screen, the cursor

moves to the specified location, and so on. You can use this action with the TN3270E, TN5250E, ANSI, and VT100 terminal types.

To wait till specific conditions are met in the terminal, do the following:

1. Double-click or drag the **Wait** action from the **Terminal Emulator** node in the **Actions** palette.
2. Enter the name of the session that you have used to establish a connection with the terminal using the **Connect** action in the **Terminal emulator session name** field.
3. Select an option from the **Terminal event** list to specify a condition the system should wait till it is met.

The following table provides information about the options available in the list and the input required for each option:

Option	Input required
Wait till text appears	Waits until the text you specified in the Text field matches with the last line of the screen in the terminal.
Wait till text disappears	Waits until the text you specified in the Text field does not match or disappears on the last line of the screen in the terminal.
Wait till cursor moves to position	Waits till the cursor moves to the position you have specified in the Move to row and Move to column fields. Note: You can enter a value of 1 through 999 to specify the row and column number where the cursor is set.
Wait till cursor moves out of position	Waits till the cursor moves out of the position you have specified in the Move out of row and Move out of column fields. Note: You can enter a value of 1 through 999 to specify the row and column number where the cursor is set.
Wait till screen gets blank	No input required.
Wait till screen contains text	Waits till the text you have specified in the Text field is available on the screen of the terminal.
Wait till terminal prompt appears	No input required.
Wait till terminal ready state	No input required.

4. Enter a value in the **How long you would like to wait?** field to specify the period (in milliseconds) the system must wait before the operation times out.
5. In the **Assign value to variable** list, select a string variable.

Share session between TaskBot logic

Use the **Shared Session** option in the Terminal Emulator package to pass the exact state of an application to the concurrently occurring TaskBot logic.

Shared session enables you to reuse actions between TaskBots that run concurrently, for example, connecting to the same application.

To use shared session, create a hierarchy of TaskBot logic that are connected by the **Shared Session** option. As a result, large TaskBot logic are trimmed by removing repetitive commands for connecting and disconnecting.

1. Create a parent bot such as TE_Share_Main that connects to an application on the Terminal Emulator.
2. Use the **Set session variable** action in the TE_Share_Main to assign the current session to a variable such as `$te_session$` of Terminal Emulator session type.
3. Create a child bot such as TE_BMIS to perform any actions such as **Get text** and **Set field**.
4. Add a Run Task action in the TE_Share_Main to call the TE_BMIS.
5. To pass a session variable from the TE_Share_Main to TE_BMIS , select `$te_session$` as an input value in the **Set SessionVariable**.
6. In the TE_BMIS , use **Shared session** tab and insert `$te_session$` as a session variable to obtain data or perform task.
7. In the main task, add an action to disconnect from the application.

Text file package

Open a text file, read data from that file, and save the data to a string variable by using the **Text file** package. This package supports text files encoded in Shift-JIS, ANSI, UTF-16LE, UTF-16BE, Win 1521, Unicode, and UTF-8 and can extract content up to 64kb from text files.

Actions in the Text file package

The Text file package includes the following actions:

Action	Description
Get text	See Using Get text action of Text file package
Read variables	See Read variables action

Using Get text action of Text file package

Extract content from a text file and save that content to a string variable by using the **Get text** action.

To extract text from a text file, perform the following steps:

1. In the **Actions** palette, double-click or drag the **Get text** action from the **Text file** package.
2. In the **Source file** field, select an option to specify the location of the text file:
 - **Control Room file** to open a file from the Control Room.
 - **Desktop file** to open a file from the device. This field also accepts the file path input as a string variable or global value.
 - **Variable** to open a file by specifying a file variable.
3. In the **Text encoding** field, select an encoding to specify the encoding that is applied on the text file. Data from the text file will be retrieved based on the selected encoding option even if the input file has a different encoding.
 - **ANSI**
 - **UTF8**
 - **UTF8 with BOM**
 - **UNICODE**
 - **Win1251**

- **UTF-16LE**
 - **UTF-16BE**
 - **Shift-JIS**
 - **Detect automatically:** identifies file encoding. This option supports UTF-8 with BOM, ANSI, UTF-16LE, and UTF-16BE file encoding.
4. Select the **Trim leading spaces** and **Trim trailing spaces** check boxes to remove the leading and trailing spaces from the data extracted from the text file.
 5. In **Save the outcome to variable** field, select a string variable to hold the output.

Read variables action

You can use the Read variables action in the Text file package to read the values of variables from the text file.

Settings

- In the **Source file** field, select an option to specify the location of the text file:
 - **Control Room file:** Opens a file from the Control Room.
 - **Desktop file:** Opens a file from the device. This field also accepts the file path input as a string variable or global value.
 - **Variable:** Opens a file by specifying a file variable.
- In the **Text encoding** field, specify the encoding to apply on the text file. Data from the text file is retrieved based on the selected encoding option even if the input file has a different encoding.
 - **ANSI**
 - **UTF-8**
 - **UTF-8 with BOM**
 - **Unicode**
 - **Windows 1251**
 - **UTF-16LE**
 - **UTF-16BE**
 - **Shift-JIS**
 - **Detect automatically:** Identifies the file encoding. This option supports UTF-8 with BOM, ANSI, UTF-16LE, and UTF-16BE file encoding.
- Select the **Trim leading spaces** and **Trim trailing spaces** check boxes to remove the leading and trailing spaces from the data extracted from the text file.
- Select the **Convert dictionary keys to lower case before assignment to variables** to convert all the keys to lower case.

Note: When you select this option, ensure that you enter the key in lower case in the **Mapped variables** table.

- In the **Save the outcome to variable** field, specify the variable to contain the output.
- From the **Save the outcome to variable** field, select one of the following options to contain the output:
 - **Multiple variables:** Click **Add variable mapping** to associate each dictionary key with a variable. Use this option to avoid using actions to extract the dictionary values.
 - **Dictionary:** Insert or create a dictionary variable to contain the output variables and values in key-value pairs.

Trigger loop package

The **Trigger loop** package enables you to run a series of actions when a trigger event occurs. You can insert multiple trigger loops within a bot or nest one trigger loop within another trigger loop.

Actions in the Trigger loop package

Action	Description
Trigger loop	<p>Opens the loop to run a series of actions when a trigger event occurs.</p> <hr/> <p>Note: Events within the Trigger loop follow a sequential order and any parallel events that occur during this time are queued.</p> <hr/>
Handle	<p>Specifies the trigger event and runs the actions that are inside the container when that event occurs.</p> <p>Drag the Handle action into the Trigger loop (in Flow view) or below the Trigger loop (in List view).</p>
Break	<p>Terminates the trigger loop for bot to continue with other actions in the trigger event. If there is no Break action after a trigger loop handle, the bot will go back to the start of the trigger loop and wait for the next configured action. So ensure you add the Break action to exit the trigger loop and move on to next action or else the bot will run indefinitely. For example, the Break action in a bot can be used when the user must close or cancel a form.</p> <p>Drag the Break action into the trigger handle container.</p>

Triggers in the Handle action

Trigger	Description	Options
Form	<p>Runs the actions when a form field is modified. Select an existing form and element.</p> <p><i>Using interactive forms</i></p>	<ul style="list-style-type: none"> • On click: Button is clicked. • Got focus: Input field is clicked. • Lost focus: User leaves the input field. • Changed value: Check box or radio button status is changed. • Value selected: Check box is selected. • Value unselected: Check box is deselected. • Assigned to (optional): Creates or selects a variable, and assigns the value from the specified form element to this variable.

Trigger	Description	Options
Hot key	Runs the actions when specific keys are pressed.	<ul style="list-style-type: none"> • Modifiers: Ctrl, Shift, Alt, AltGr, and Win • Keys: <ul style="list-style-type: none"> • Letters A-Z • Numbers 0-9
Object	<p>Runs the actions when an event occurs on the selected interface element. For example, when a user clicks a button.</p> <p>Interface triggers for objects are available only for native Windows applications.</p>	

Related tasks

[Add a form to bot](#)

Adding an existing form to a bot enables users to collaborate with bots. Use the necessary action items to create a bot and build a task logic.

V11 Task Bot package

The **V11 Task Bot** package enables you to run an Enterprise 11 bot from Automation 360 in the Enterprise 11 Control Room.

Actions in the V11 Task Bot package

The package includes the following action:

Action	Description
Run	See Using Run action .

Using Run action

Use the **Run** action to run an Enterprise 11 bot from Automation 360 in the Enterprise 11 Control Room.

Ensure that the Enterprise 11 user credential that you want to use to run the Enterprise 11 bot includes the following:

- Access to the Enterprise 11 Bot Runner device on which you want to run the Enterprise 11 bots
- **Run my bots** and **View my scheduled bots** permissions

To use the **Send callback status to A2019** option, ensure the following:

- The IP address of the Automation 360 Bot Runner device on which you want to run the Automation 360 bot is a static IP address
- The IP address is available in the callback URL of the Enterprise 11 Control Room

[Callback URLs for bot deployment](#)

1. Double-click or drag the **Run** action from the **V11 Task Bot** node in the **Actions** palette.

2. Provide the Enterprise 11 Control Room URL in which you want to run the bot.
3. Click the **Credential** tab to use a value from the Credential Vault and the **Variable** to use a credential variable.

Alternatively, click the **Insecure string** tab to manually specify the value you want to use as the **Username** and **Password** to log in the Control Room you have specified.

4. Specify the location of the bot you want to run in the **Task relative path** field.
5. Optional: Specify the device on which you want to run the bot in the **Bot Runner device name** field. You can specify multiple devices separated by a semicolon. Ensure that the names of the devices you have provided are the same as those on the **My Devices** page of the Enterprise 11 Control Room.

If you do not provide any value in the field, the system runs the bot on any connected devices (device for which the user specified in the Step 3).

6. Select the **Run bot runner session on Control Room** check box to deploy the bot using the remote desktop process.
7. Select the **Wait for task to complete** check box if you want the system to wait for the task to complete before performing the next action in the bot.
 - a) Specify the period you want the system to wait before the bot is timed out in the **Total wait time** field.
 - b) Select the version of the Control Room on which you want to run the bot.

- **11.3.2 or later** (includes 11.3.3.x releases):

Click **Advanced settings** to expand and update the polling attributes.

Field	Description
Wait time before start polling the status	Period (in seconds) you want the system to wait before it starts polling the status after the bot is deployed on the device.
Polling interval for non-started execution	Time interval at which you want the system to poll for status for the Enterprise 11 bot you have set to run but has not started execution.
Polling interval for pending execution	Time interval at which you want the system to poll for status for the bot that you have set to run and is pending execution.
Polling interval for paused execution	Time interval at which you want the system to poll for status for the bot that has started execution and is paused.
Polling interval for in-progress execution	Time interval at which you want the system to poll for status for the bot that has started execution and is currently in progress.

Field	Description
Polling interval for unknown execution	Time interval at which you want the system to poll for status for the bot that has started execution and the current status is unknown.

- **11.3.4 or later:**

- Select the **Send callback status to A2019** option to specify a range for the TCP port that you want to use to send the callback status to Automation 360.

Field	Description
From available TCP port	Starting value in the range for the TCP port that you want to use to send the callback status.
To available TCP port	End value in the range for the TCP port that you want to use to send the callback status.

Note: The IP address of the Automation 360 Bot Runner must be reachable from Enterprise 11 Control Room on the range for the TCP port you have provided.

- Select the **Poll status from 11.x Control Room** option. Click **Advanced settings** to update the polling status from the Enterprise 11 Control Room:

Field	Description
Wait time before start polling the status	Period (in seconds) you want the system to wait before it starts polling the status after the bot is deployed on the device.
Polling interval for non-started execution	Time interval at which you want the system to poll for status for the Enterprise 11 bot you have set to run but has not started execution.
Polling interval for pending execution	Time interval at which you want the system to poll for status for the bot that you have set to run and is pending execution.
Polling interval for paused execution	Time interval at which you want the system to poll for status for the bot that has started execution and is paused.
Polling interval for in-progress execution	Time interval at which you want the system to poll for status for the bot that has started execution and is currently in progress.

Field	Description
Polling interval for unknown execution	Time interval at which you want the system to poll for status for the bot that has started execution and the current status is unknown.

8. Select the dictionary variable from the **Input parameters** list that you want to use to pass input parameters for the bot.

The input variables that you want to pass for the bot are contained as keys in the dictionary variable with their corresponding values.

9. Select the dictionary variable that you want to use to store the output from the **Assign the output to** list.

The dictionary variable stores the output parameters of the Enterprise 11 bot as keys.

Additionally, the following keys are added in the dictionary variable by default:

Key	Value
COMMAND	Name of the command that was last executed by the Enterprise 11 bot.
STATUS	Status of the Enterprise 11 bot execution.
START_TIME	Time when execution of the Enterprise 11 bot started.
END_TIME	Time when execution of the Enterprise 11 bot ended.
AUTOMATION_NAME	Name of the automation

10. Click **Save**.

VBScript package

The **VBScript** package contains actions that enable VBScript functions in a task.

Before you start

1. Verify that the device on which you want to run the VBScript has Windows operating system installed.
2. Open a VBScript file, or input the script you want to run using the **Open** action. You must associate the details of the file or script you want to run with a session name. Use this same session name for other **VBScript** actions.
3. Use the **Run function** action to execute a function within the script or execute the entire script. You must use the VBScript session name you established in the previous step.
4. After you have executed the script, close the VBScript session.

To review the bot launcher logs, navigate to `C:\ProgramData\AutomationAnywhere\BotRunner\Logs\<current month>\Bot_Launcher-<today's date>.log.zip`. Each zipped folder contains a file with data on the code execution, which is useful for debugging.

Actions in the VBScript package

The **VBScript** package includes the following actions:

Note: The **Open** action must be the first action to use the VBScript in a task.

Action	Description
Close	<p>Closes the session.</p> <p>Specify the same session name from the Open action.</p>
Run function	<p>Runs a function within the VBScript.</p> <ul style="list-style-type: none"> In the VBScript session field, specify a session name. Use the same session name from the Open action. Optional: Specify the function name to run and the arguments to pass to the function. <hr/> <p>Note: You can pass only a list variable as an argument for the function. You can use the list variable to pass multiple arguments of different data types such as Boolean, datetime, number, and string.</p> <hr/> <ul style="list-style-type: none"> Optional: If the specified function returns a value, specify the variable to store that value in the Assign the output to variable field. The shows a descriptive default variable name. If you create several output variables, subsequent variable names are appended with a <i>-1</i>, <i>-2</i>, <i>-3</i>, and so on to avoid duplication. <hr/> <p>Note: In VBScript, stand alone scripts do not return a value.</p> <hr/>
Open	<p>Opens a VBScript file.</p> <ul style="list-style-type: none"> In the VBScript session field, specify a session name. Use this same session name for other VBScript actions. In the VBScript, choose one of the following options: <ul style="list-style-type: none"> In the Import existing file option, select an existing VBScript file. <hr/> <p>Note: If you are uploading a script from a file on your desktop, the file and any dependencies must be in a standalone folder. When you select a file for upload, all files and folders at the same folder level are uploaded.</p> <hr/> In the Manual input option, enter the VBScript.

Related tasks

[Example of using the VBScript package in a resilient bot](#)

Build a bot that executes a Microsoft Visual Basic script. Use the Try/Catch package to gracefully end the bot if it fails, making it resilient to crashes. A resilient bot allows scheduled and queued bots to continue even if the current bot encounters an error.

Wait package

Use the actions in the **Wait** package to add a condition to wait for an application screen to change, or a separate window to open or close before proceeding to the next action.

Actions in the Wait package

The **Wait** package includes the following actions:

Action	Description
Wait for condition	See Wait for condition action
Wait for screen change	See Using Wait for screen change action.
Wait for window	See Using Wait for window action.

Wait for condition action

Makes the bot wait until a specific condition is true before executing the next action.

Settings

In the **Wait till** field, specify the condition to meet. For example, the wait condition can be based on whether an application is running, a folder or file exists, a variable matches the specified value, an application window exists, or a machine or server is running.

Note:

- If a bot encounters an internal error that does not appear on the UI, it does not wait for the amount of time that is specified in this action. The bot does not stop and continues to the next line.
- When you create a bot and use the variable option to search the window title and use the condition **Window exists**, or **Window does not exist** the bot will not search for the changed window title. Also, it will not identify the window title if you have changed the variable. You can use the condition **Window with same title does not exist**, or **Window with same title exist** to verify whether a window with the same title exists or changed.

This action offers the same conditions as the If package. See the [If package](#) .

Using Wait for screen change action

Use the **Wait for screen change** action to wait for the content of a specific screen or the entire window to change before executing the next action.

For example, a Human Resources (HR) personnel automating leave-management tasks wants to log in to the HR portal. After entering the user credentials, this action enables the automation task to wait until the next screen loads.

1. In the **Actions** palette, double-click or drag the **Wait for screen change** action from the Wait package.

2. In the **Screen change relative to** field, choose **Window** or **Screen**.

3. Select an application window:

Option	Steps
<p>Application</p>	<p>From the drop-down list, select the window title from the open applications.</p> <ul style="list-style-type: none"> The Window title field displays the title of the application window you have selected. <p>Insert a wildcard character (*) in the Window title field to search for window titles that can change. You can specify one or more wildcards (*) at the start, middle, or end of the value. For example, to perform an operation on any window that has <code>Microsoft</code> in the title, use a wildcard to indicate any string by adding it before or after the value: <code>*Microsoft*</code>. The first searches for the exact window title (<code>Microsoft</code>), and if it does not find a match, it searches for windows with the term <code>Microsoft</code> anywhere in the title.</p> <p>You can use a regular expression (regex) to identify a window title. Select the regular expression condition as either String or a Pattern and then enter the value. By default, the Window title field is case-sensitive.</p> <p>To identify a browser title, you can enable the Case sensitive option to match the letter case, or disable the option to identify a window title where the letter case does not match.</p> <hr/> <p>Note: Ensure that the minimum version installed on your system is the version that was released with v.26. If you have a version released with v.25 or earlier, then by default, the window title will be identified only with matching letter case (case-sensitive).</p> <hr/> <p>For example, you can enter the String value as <code>((\w*)-Notepad</code> for all window title names starting with <code>((\w*)-Notepad</code>, or use Pattern value as <code>((\w)\s)*document-Notepad</code> for only those window titles that match this pattern.</p> <hr/> <p>Note:</p> <ul style="list-style-type: none"> When you use a regular expression of type String with <code>-title</code> as the input value for a window title in any , the might encounter a run time error. To prevent the run time error, ensure that when you add the string input as <code>*-title</code>, the application with the specific title is open. The asterisk (*) is just a character, not a wild card character. When you use a regular expression of type Pattern with <code>-title</code> as the input

Option	Steps
Browser	Select from a list of supported browser tabs. <hr/> Note: This option supports , Chromium-based , and browsers. <hr/>
Variable	Use a window variable to specify the application window you want to use.

4. Optional: Select the **Resize window** option to specify the window dimensions. This option delivers a more reliable bot. It resizes the window to the dimensions at which the task was recorded, which enhances the ability of the bot to identify the target object.
- If the window is maximized when you record the task, this option is not selected.
 - If the window is not at the maximum size when you record the task, this option is selected, by default, and the width and height fields are automatically filled with the dimensions of the window.

Note: This option is available only for windows that can be resized. It is not available for the **Desktop** or **Taskbar** options.

5. Click **Capture region**.
The selected window appears.
6. Drag the mouse to draw a rectangle around the region that you want to capture and right-click when done.
The captured area appears in the **Preview** section, followed by the image coordinates **X, Y, Width,** and **Height**.
7. In the **How long to wait before comparing screens?** field, specify the wait time (in seconds) to begin comparing the window or screen.
When a difference is detected, the comparison stops and the task proceeds to the next action.
8. In the **How long to wait before screen comparing is stopped?** field, specify the wait time (in seconds) for the screen to change.
If the screen does not change within the time you specified, the task proceeds with the next action.
9. Select the **Throw an exception if the screen is not changed** option to show an error message and terminate the bot if the screen does not change.
If the option is deselected and the screen does not change, the task proceeds with the next action.
10. Click **Save**.

Using Wait for window action

Use the **Wait for window** action to wait for the specified window to open or close before executing the next action.

For example, a Human Resources (HR) personnel automating leave-management tasks might require the attendance application to open before they enter the user credentials. This action enables the automation task to wait until the application window opens.

1. In the **Actions** palette, double-click or drag the **Wait for window** action from the Wait package.
2. In the **Wait for window** field, select the option you want the automation to wait for:
 - **Wait for window to open**
 - **Wait for window to close**
3. Select an application window:

Option	Steps
<p>Application</p>	<p>From the drop-down list, select the window title from the open applications.</p> <ul style="list-style-type: none"> The Window title field displays the title of the application window you have selected. <p>Insert a wildcard character (*) in the Window title field to search for window titles that can change. You can specify one or more wildcards (*) at the start, middle, or end of the value. For example, to perform an operation on any window that has <code>Microsoft</code> in the title, use a wildcard to indicate any string by adding it before or after the value: <code>*Microsoft*</code>. The first searches for the exact window title (<code>Microsoft</code>), and if it does not find a match, it searches for windows with the term <code>Microsoft</code> anywhere in the title.</p> <p>You can use a regular expression (regex) to identify a window title. Select the regular expression condition as either String or a Pattern and then enter the value. By default, the Window title field is case-sensitive.</p> <p>To identify a browser title, you can enable the Case sensitive option to match the letter case, or disable the option to identify a window title where the letter case does not match.</p> <hr/> <p>Note: Ensure that the minimum version installed on your system is the version that was released with v.26. If you have a version released with v.25 or earlier, then by default, the window title will be identified only with matching letter case (case-sensitive).</p> <hr/> <p>For example, you can enter the String value as <code>((\w*)-Notepad</code> for all window title names starting with <code>((\w*)-Notepad</code>, or use Pattern value as <code>((\w)\s)*document-Notepad</code> for only those window titles that match this pattern.</p> <hr/> <p>Note:</p> <ul style="list-style-type: none"> When you use a regular expression of type String with <code>-title</code> as the input value for a window title in any , the might encounter a run time error. To prevent the run time error, ensure that when you add the string input as <code>*-title</code>, the application with the specific title is open. The asterisk (*) is just a character, not a wild card character. When you use a regular expression of type Pattern with <code>-title</code> as the input

Option	Steps
Browser	Select from a list of supported browser tabs. <hr/> Note: This option supports , Chromium-based , and browsers. <hr/>
Variable	Use a window variable to specify the application window you want to use.

- In the **How long you would like to wait for this condition to be true?** field, specify the wait time (in seconds) for the window to open or close.
If the window does not open or close within the time you specify, the task proceeds to execute the next set of actions.
- Select the **Throw an exception if wait for window is unsuccessful** option to show an error message and terminate the bot if the window does not open or close within the specified amount of time.
If the option is deselected and the window does not open or close within the specified amount of time, the task proceeds with the next action.
- Click **Save**.

Window package

Use the **Window** package to automate tasks relating to the window.

Window is a data type available for storing application window titles. It is the only data type that can be used in all the actions of the **Window** package. Create a variable of data type **Window** and select or assign a window title.

Note: When you create a Window type variable, note that selecting **Browser** as default value supports only Google Chrome tabs whereas selecting **Application** as default value supports any application window.

Use this variable in any number of actions within the automation task. If the application window title changes, then change the value assigned to the variable. The new application title is reflected in all the actions where the variable is used.

Actions in the Window package

The **Window** package includes the following actions:

Action	Description
Activate	<p>Activates a window.</p> <ul style="list-style-type: none"> In the Window field, select an option: Choose from the Application, Browser, or Variable tab. <ul style="list-style-type: none"> Application: Select from a list of windows, including browser windows, that are currently open on the Bot Creator device. Browser: Select from a list of supported browser tabs. <hr/> <p>Note: This option supports , Chromium-based , and browsers.</p> <ul style="list-style-type: none"> Variable: Select an existing window variable to specify the title of the application window title. In the Window title field, specify the title. <p>Insert a wildcard character (*) in the Window title field to search for window titles that can change. You can specify one or more wildcards (*) at the start, middle, or end of the value. For example, to perform an operation on any window that has Microsoft in the title, use a wildcard to indicate any string by adding it before or after the value: *Microsoft*. The first searches for the exact window title (Microsoft), and if it does not find a match, it searches for windows with the term Microsoft anywhere in the title.</p> <p>You can use a regular expression (regex) to identify a window title. Select the regular expression condition as either String or a Pattern and then enter the value. By default, the Window title field is case-sensitive.</p> <p>To identify a browser title, you can enable the Case sensitive option to match the letter case, or disable the option to identify a window title where the letter case does not match.</p> <hr/> <p>Note: Ensure that the minimum version installed on your system is the version that was released with v.26. If you have a version released with v.25 or earlier, then by default, the window title will be identified only with matching letter case (case-sensitive).</p> <hr/> <p>For example, you can enter the String value as ((\w*)-Notepad for all window title names starting with ((\w*)-Notepad, or use Pattern value as ((\w)\s)*document-Notepad for only those window titles that match this pattern.</p> <hr/> <p>Note:</p> <ul style="list-style-type: none"> When you use a regular expression of type String with -title as the input value for a window title in any , the might encounter a run time error. To prevent the run time error, ensure that when you add the string input as *-title, the application with the specific title is open. The asterisk (*) is just a character, not a wild card character. When you use a regular expression of type Pattern with -title as the input value for a window title in any , the might encounter a run time error because the input value *-title is incorrect. <p>Ensure that you use valid regex patterns.</p> <hr/>

Action	Description
Assign	<p>Assigns a source window variable's value to a designated window.</p> <ul style="list-style-type: none">• In the Window field, select an option: Choose from the Application, Browser, or Variable tab.<ul style="list-style-type: none">• Application: Select from a list of windows, including browser windows, that are currently open on the Bot Creator device.• Browser: Select from a list of supported browser tabs. <hr/> <p>Note: This option supports , Chromium-based , and browsers.</p> <hr/> <ul style="list-style-type: none">• Variable: Select an existing window variable to specify the title of the application window title.• In the Select the destination window variable/value field, specify the variable. <hr/> <p>Note: The regular expression (regex) is currently not supported.</p> <hr/>

Action	Description
Close	<p>Closes the application window.</p> <ul style="list-style-type: none"> In the Window field, select an option: Choose from the Application, Browser, or Variable tab. <ul style="list-style-type: none"> Application: Select from a list of windows, including browser windows, that are currently open on the Bot Creator device. Browser: Select from a list of supported browser tabs. <hr/> <p>Note: This option supports , Chromium-based , and browsers.</p> <ul style="list-style-type: none"> Variable: Select an existing window variable to specify the title of the application window title. <p>Insert a wildcard character (*) in the Window title field to search for window titles that can change. You can specify one or more wildcards (*) at the start, middle, or end of the value. For example, to perform an operation on any window that has <code>Microsoft</code> in the title, use a wildcard to indicate any string by adding it before or after the value: <code>*Microsoft*</code>. The first searches for the exact window title (<code>Microsoft</code>), and if it does not find a match, it searches for windows with the term <code>Microsoft</code> anywhere in the title.</p> <p>You can use a regular expression (regex) to identify a window title. Select the regular expression condition as either String or a Pattern and then enter the value. By default, the Window title field is case-sensitive.</p> <p>To identify a browser title, you can enable the Case sensitive option to match the letter case, or disable the option to identify a window title where the letter case does not match.</p> <hr/> <p>Note: Ensure that the minimum version installed on your system is the version that was released with v.26. If you have a version released with v.25 or earlier, then by default, the window title will be identified only with matching letter case (case-sensitive).</p> <hr/> <p>For example, you can enter the String value as <code>((\w*)-Notepad</code> for all window title names starting with <code>((\w*)-Notepad</code>, or use Pattern value as <code>((\w)\s)*document-Notepad</code> for only those window titles that match this pattern.</p> <hr/> <p>Note:</p> <ul style="list-style-type: none"> When you use a regular expression of type String with <code>-title</code> as the input value for a window title in any , the might encounter a run time error. To prevent the run time error, ensure that when you add the string input as <code>*-title</code>, the application with the specific title is open. The asterisk (*) is just a character, not a wild card character. When you use a regular expression of type Pattern with <code>-title</code> as the input value for a window title in any , the might encounter a run time error because the input value <code>*-title</code> is incorrect. <p>Ensure that you use valid regex patterns.</p> <hr/> <p>Note:</p> <ul style="list-style-type: none"> When multiple Excel windows are opened, the bot closes all the open Microsoft Excel windows even when a specific Excel window name is

Action	Description
Close all	<p>Closes all the windows</p> <p>In the Add window field, you can provide the title of the application windows that you do not want to close.</p> <p>You can also search the window titles by using (*) as a wildcard character. Specify one or more (*) wildcards at the start, middle, or end of the title. For example, to perform an operation on any window that has Microsoft in the title, use a wildcard to indicate any string by adding it before or after the value: *Microsoft*. The bot first searches for the exact window title (Microsoft), and if it does not find a match, it searches for windows with the term Microsoft anywhere in the title.</p> <hr/> <p>Note: To keep the Bot editor window open, ensure that you add it in the Add window field. For example, enter *Control Room Automation Anywhere* in the window title to keep it open.</p>
Get active window title	<p>Retrieves the title of the active window. In the Assign the window title to variable field, specify the variable. The shows a descriptive default variable name. If you create several output variables, subsequent variable names are appended with a -1, -2, -3, and so on to avoid duplication.</p> <hr/> <p>Note: The regular expression (regex) is currently not supported.</p>

Action	Description
Maximize	<p>Maximizes a window.</p> <ul style="list-style-type: none"> In the Window field, select an option: Choose from the Application, Browser, or Variable tab. <ul style="list-style-type: none"> Application: Select from a list of windows, including browser windows, that are currently open on the Bot Creator device. Browser: Select from a list of supported browser tabs. <hr/> <p>Note: This option supports , Chromium-based , and browsers.</p> <hr/> Variable: Select an existing window variable to specify the title of the application window title. <p>Insert a wildcard character (*) in the Window title field to search for window titles that can change. You can specify one or more wildcards (*) at the start, middle, or end of the value. For example, to perform an operation on any window that has <code>Microsoft</code> in the title, use a wildcard to indicate any string by adding it before or after the value: <code>*Microsoft*</code>. The first searches for the exact window title (<code>Microsoft</code>), and if it does not find a match, it searches for windows with the term <code>Microsoft</code> anywhere in the title.</p> <p>You can use a regular expression (regex) to identify a window title. Select the regular expression condition as either String or a Pattern and then enter the value. By default, the Window title field is case-sensitive.</p> <p>To identify a browser title, you can enable the Case sensitive option to match the letter case, or disable the option to identify a window title where the letter case does not match.</p> <hr/> <p>Note: Ensure that the minimum version installed on your system is the version that was released with v.26. If you have a version released with v.25 or earlier, then by default, the window title will be identified only with matching letter case (case-sensitive).</p> <hr/> <p>For example, you can enter the String value as <code>((\w*)-Notepad</code> for all window title names starting with <code>((\w*)-Notepad</code>, or use Pattern value as <code>((\w)\s)*document-Notepad</code> for only those window titles that match this pattern.</p> <hr/> <p>Note:</p> <ul style="list-style-type: none"> When you use a regular expression of type String with <code>-title</code> as the input value for a window title in any , the might encounter a run time error. To prevent the run time error, ensure that when you add the string input as <code>*-title</code>, the application with the specific title is open. The asterisk (*) is just a character, not a wild card character. When you use a regular expression of type Pattern with <code>-title</code> as the input value for a window title in any , the might encounter a run time error because the input value <code>*-title</code> is incorrect. <p>Ensure that you use valid regex patterns.</p> <hr/>

Action	Description
Minimize	<p>Minimizes a window.</p> <ul style="list-style-type: none"> In the Window field, select an option: Choose from the Application, Browser, or Variable tab. <ul style="list-style-type: none"> Application: Select from a list of windows, including browser windows, that are currently open on the Bot Creator device. Browser: Select from a list of supported browser tabs. <hr/> <p>Note: This option supports , Chromium-based , and browsers.</p> <hr/> Variable: Select an existing window variable to specify the title of the application window title. <p>Insert a wildcard character (*) in the Window title field to search for window titles that can change. You can specify one or more wildcards (*) at the start, middle, or end of the value. For example, to perform an operation on any window that has <code>Microsoft</code> in the title, use a wildcard to indicate any string by adding it before or after the value: <code>*Microsoft*</code>. The first searches for the exact window title (<code>Microsoft</code>), and if it does not find a match, it searches for windows with the term <code>Microsoft</code> anywhere in the title.</p> <p>You can use a regular expression (regex) to identify a window title. Select the regular expression condition as either String or a Pattern and then enter the value. By default, the Window title field is case-sensitive.</p> <p>To identify a browser title, you can enable the Case sensitive option to match the letter case, or disable the option to identify a window title where the letter case does not match.</p> <hr/> <p>Note: Ensure that the minimum version installed on your system is the version that was released with v.26. If you have a version released with v.25 or earlier, then by default, the window title will be identified only with matching letter case (case-sensitive).</p> <hr/> <p>For example, you can enter the String value as <code>((\w*)-Notepad</code> for all window title names starting with <code>((\w*)-Notepad</code>, or use Pattern value as <code>((\w)\s)*document-Notepad</code> for only those window titles that match this pattern.</p> <hr/> <p>Note:</p> <ul style="list-style-type: none"> When you use a regular expression of type String with <code>-title</code> as the input value for a window title in any , the might encounter a run time error. To prevent the run time error, ensure that when you add the string input as <code>*-title</code>, the application with the specific title is open. The asterisk (*) is just a character, not a wild card character. When you use a regular expression of type Pattern with <code>-title</code> as the input value for a window title in any , the might encounter a run time error because the input value <code>*-title</code> is incorrect. <p>Ensure that you use valid regex patterns.</p> <hr/>

Action	Description
Resize	<p>Resizes a window.</p> <ul style="list-style-type: none"> In the Window field, select an option: Choose from the Application, Browser, or Variable tab. <ul style="list-style-type: none"> Application: Select from a list of windows, including browser windows, that are currently open on the Bot Creator device. Browser: Select from a list of supported browser tabs. <hr/> <p>Note: This option supports , Chromium-based , and browsers.</p> Variable: Select an existing window variable to specify the title of the application window title. <ul style="list-style-type: none"> Insert a wildcard character (*) in the Window title field to search for window titles that can change. You can specify one or more wildcards (*) at the start, middle, or end of the value. For example, to perform an operation on any window that has <code>Microsoft</code> in the title, use a wildcard to indicate any string by adding it before or after the value: <code>*Microsoft*</code>. The first searches for the exact window title (<code>Microsoft</code>), and if it does not find a match, it searches for windows with the term <code>Microsoft</code> anywhere in the title. You can use a regular expression (regex) to identify a window title. Select the regular expression condition as either String or a Pattern and then enter the value. By default, the Window title field is case-sensitive. <p>To identify a browser title, you can enable the Case sensitive option to match the letter case, or disable the option to identify a window title where the letter case does not match.</p> <hr/> <p>Note: Ensure that the minimum version installed on your system is the version that was released with v.26. If you have a version released with v.25 or earlier, then by default, the window title will be identified only with matching letter case (case-sensitive).</p> <hr/> <p>For example, you can enter the String value as <code>((\w*)-Notepad</code> for all window title names starting with <code>((\w*)-Notepad</code>, or use Pattern value as <code>((\w)\s)*document-Notepad</code> for only those window titles that match this pattern.</p> <hr/> <p>Note:</p> <ul style="list-style-type: none"> When you use a regular expression of type String with <code>-title</code> as the input value for a window title in any , the might encounter a run time error. To prevent the run time error, ensure that when you add the string input as <code>*-title</code>, the application with the specific title is open. The asterisk (*) is just a character, not a wild card character. When you use a regular expression of type Pattern with <code>-title</code> as the input value for a window title in any , the might encounter a run time error because the input value <code>*-title</code> is incorrect. <p>Ensure that you use valid regex patterns.</p> <hr/> <ul style="list-style-type: none"> In the Left, Top, Width, and Height fields, specify values for resizing the window.

Action	Description
Restore	<p>Restores a window.</p> <ul style="list-style-type: none"> In the Window field, select an option: Choose from the Application, Browser, or Variable tab. <ul style="list-style-type: none"> Application: Select from a list of windows, including browser windows, that are currently open on the Bot Creator device. Browser: Select from a list of supported browser tabs. <hr/> <p>Note: This option supports , Chromium-based , and browsers.</p> Variable: Select an existing window variable to specify the title of the application window title. <ul style="list-style-type: none"> Insert a wildcard character (*) in the Window title field to search for window titles that can change. You can specify one or more wildcards (*) at the start, middle, or end of the value. For example, to perform an operation on any window that has <code>Microsoft</code> in the title, use a wildcard to indicate any string by adding it before or after the value: <code>*Microsoft*</code>. The first searches for the exact window title (<code>Microsoft</code>), and if it does not find a match, it searches for windows with the term <code>Microsoft</code> anywhere in the title. You can use a regular expression (regex) to identify a window title. Select the regular expression condition as either String or a Pattern and then enter the value. By default, the Window title field is case-sensitive. <p>To identify a browser title, you can enable the Case sensitive option to match the letter case, or disable the option to identify a window title where the letter case does not match.</p> <hr/> <p>Note: Ensure that the minimum version installed on your system is the version that was released with v.26. If you have a version released with v.25 or earlier, then by default, the window title will be identified only with matching letter case (case-sensitive).</p> <hr/> <p>For example, you can enter the String value as <code>((\w*)-Notepad</code> for all window title names starting with <code>((\w*)-Notepad</code>, or use Pattern value as <code>((\w)\s)*document-Notepad</code> for only those window titles that match this pattern.</p> <hr/> <p>Note:</p> <ul style="list-style-type: none"> When you use a regular expression of type String with <code>-title</code> as the input value for a window title in any , the might encounter a run time error. To prevent the run time error, ensure that when you add the string input as <code>*-title</code>, the application with the specific title is open. The asterisk (*) is just a character, not a wild card character. When you use a regular expression of type Pattern with <code>-title</code> as the input value for a window title in any , the might encounter a run time error because the input value <code>*-title</code> is incorrect. <p>Ensure that you use valid regex patterns.</p> <hr/>

Action	Description
Set title	<p>Assigns a new window title to a window variable.</p> <ul style="list-style-type: none"> In the Window field, select an option: Choose from the Application, Browser, or Variable tab. <ul style="list-style-type: none"> Application: Select from a list of windows, including browser windows, that are currently open on the Bot Creator device. Browser: Select from a list of supported browser tabs. <hr/> <p>Note: This option supports , Chromium-based , and browsers.</p> <hr/> <ul style="list-style-type: none"> Variable: Select an existing window variable to specify the title of the application window title. <ul style="list-style-type: none"> In the New window title field, enter the new title. <hr/> <p>Note: The regular expression (regex) is currently not supported.</p>

Workload package

The Workload package enables you to insert work items in a queue for workload automation. It also enables data chaining between multiple queues. You can orchestrate multiple bots, and enable optimal device utilization through the queuing mechanism of workload management.

For example, a business process of Employee Salary Processing:

- A payroll queue can process the employee salaries, and a payroll bot can add work items to a finance queue.
- The finance queue in turn can release the funds to employees and a finance bot in turn adds works items in a HR queue to email employees on the salary processing completion.

You must have the Queue **Owner** or **Participant** privileges to view the list of queues in the Workload package.

Actions in the Workload package

The Workload package includes the following action:

Note: If you built a bot using actions from the Workload package from Build 5322 or earlier, the action will be missing when you open the bot with the default package version. You must reinsert the action and repopulate the fields.

Action	Description
Insert work item	Allows you to insert a work item from an existing queue to another queue as part of a bot execution.

Related concepts

[Workload management](#)

The workload management module enables users to upload Microsoft Excel and CSV files to the Control Room so that it feeds the records from the files into the bot deployments.

Related tasks

[Attach work item template to TaskBot](#)

Attach a work item template to a TaskBot to use the TaskBot in workload automation.

[Use Work Item variables](#)

You can use the Work Item variables to pass the Work Item attributes or values to the TaskBot from the Control Room when you run the bot with the option **Run bot with queue**.

Using Insert work item action

The **Insert work item** action provides you the flexibility to insert a work item to another queue as part of a bot execution.

- You must have the Queue **Owner** or **Participant** privileges to view the list of queues in the Workload package.
- Ensure that the bot is not connected to a Work item template.

Use the **Insert work item** to manage complex workflows by configuring a bot to add work items from multiple queues. For example, use a bot to read a list of invoices from a .csv file and add the invoices due for payment to another bot that manages information of payments due on specific dates. The automation can be used in the scenarios where work items are part of a different system (Database, Excel) and the bot reads them and adds them to a queue or where one queue adds work items to another queue as part of data chaining.

1. In the **Automation** page, **Create** a bot or **Edit** an existing bot.
2. In the **Actions** palette, double-click or drag the **Insert Work Item** action from the Workload package.
3. In the **Workload: Insert work item** window, add parameters such as the **Queue** and work item values:
 - a) Click **Browse** to select a queue name from the list of queues to insert as a work item.
 - b) Click **Confirm** to add the queue.
 - c) Start entering work item values in the work item fields.

Note: These parameters are populated based on the work item template associated with the selected queue.

You can also assign a variable value to these parameters by pressing the F2 key and selecting a variable name from the list.

Tip: Use UTC format (YYYY-mm-dd 00:00:00) for **Date** data type.

4. Click **Save**.
The action is added to the bot.
5. Add more data using the **Insert Work Item** action.
After the required data is added, **Save** the bot and **Check in** the bot to the **Public** folder for further processing and deployment.

Related concepts

[Create workload queues](#)

A queue is one of the main building blocks of Workload Management. A queue holds data known as Work Items for further processing. The system distributes these Work Items to individual unattended Bot Runners in a device pool for processing.

Related tasks

[Attach work item template to TaskBot](#)

Attach a work item template to a TaskBot to use the TaskBot in workload automation.

[Use Work Item variables](#)

You can use the Work Item variables to pass the Work Item attributes or values to the TaskBot from the Control Room when you run the bot with the option **Run bot with queue**.

[Insert Work Items](#)

Add Work Items from an Excel or CSV file to the queue after you define the structure.

XML package

Extensible Markup Language (XML) is a markup language designed to store and transport data. Use the actions in the XML package to automate the processing of XML data generated from web services and cloud computing applications.

An XML document is structured as an ordered and labeled tree. Each node of the tree is an XML element and is written with an opening and closing tag. In the following example, custname and custid are nodes:

```
<customer>
  <custname>XYZ Corp</custname>
  <custid>A001</custid>
</customer>
```

XPath is a query language that uses path expressions to select nodes or node-sets in an XML document. XPath includes built-in functions for manipulation of string, numeric, Boolean, date and time, and so on.

Before you start

Perform the following actions within the XMLpackage.

1. Start the XML session using the **Start XML Session** action. Use this session name for all corresponding actions.
2. Use the different actions available in the XML package to automate XML-related tasks.
3. Save the session using the **Save XML Session** action to assign the data to a file or String-type variable.
4. End the session using the **End XML Session** action to complete a task.

Actions in the XML package

The XML includes the following actions:

Action	Description
Delete node	<p>Deletes a specific node from XML file.</p> <ul style="list-style-type: none"> • Enter the session name or select an existing variable used in the Start XML session action . • Enter the XPath expression for the node to be deleted. • Enter the attribute (optional)

Action	Description
End session	<p>Closes an XML session.</p> <p>Enter the session name or select an existing variable used in the Start XML session action.</p> <hr/> <p>Note: The End session action clears out session-related data from memory. To save the modified data, use the Save session data action.</p> <hr/>
Execute XPath function	<p>Executes an XPath function and stores the results in a variable.</p> <ul style="list-style-type: none"> • Enter the session name or select an existing variable used in the Start XML session action . • Enter the XPath expression or select an existing variable. • Assign a String-type variable to the output.
Get multiple nodes	<p>Retrieves the value of multiple nodes.</p> <ul style="list-style-type: none"> • Enter the session name or select an existing variable used in the Start XML session action . • Enter the XPath expression to retrieve multiple nodes or select an existing variable. • In the Get each node field, select if you require the Text value, XPath expression, or Specific attribute name of each node. <p>For example,</p> <pre><Customer> <Cust_Details> <custid>A001</ custid> <custname>XYZ Corp</custname> <custzipcode>15639</custzipcode> <country>Mexico</country> <Locale lang="es"> Spanish</Locale> </Cust_Details> </Customer></pre> <ul style="list-style-type: none"> • Text value retrieves the exact value of the specific node element. For example, the <code>custname</code> element of a <code>Cust_Details</code> node retrieves the names of all the customers of the company. • XPath expression refers to the path of the selected node in an XML document. An XPath expression such as <code>Customer//Cust_Details//custid</code> selects only customer IDs that are available in the customer details node. • Specific attribute defines a property or the type of the element in a particular node. For example, <code>lang</code> is an attribute of the <code>Locale</code> element in a <code>Cust_Details</code> node. The output for <code>lang</code> attribute is displayed as <code>es</code>.

Action	Description
Get single node	<p>Retrieves the value of a single node.</p> <ul style="list-style-type: none"> Enter the session name or select an existing variable used in the Start XML session action. Enter the XPath expression, and attribute (optional) to retrieve a node. <p>Get single node retrieves the first value from the XML document based on the provided XPath expression and the attribute.</p> <ul style="list-style-type: none"> Xpath expression with attribute: The attribute value of the XPath expression element is displayed. For example, If the XPath expression is entered as <code>Customer//Cust_Details//Locale</code> with the attribute as <code>lang</code>, the output is displayed as <code>es</code>. XPath expression without attribute: The value of the XPath expression element is displayed. For example, If the XPath expression is entered as <code>Customer//Cust_Details//Locale</code> without any attribute, <code>Spanish</code> is displayed as an output. <ul style="list-style-type: none"> Assign the output to a String-type variable.
Insert node	See Using Insert node action .
Save session data	<p>Saves the XML session data to a file or variable of type String.</p> <ul style="list-style-type: none"> Enter the session name or select an existing variable used in the Start XML session action. To save the session data to a file, select the Write XML data option and specify a file path. Select Overwrite to replace the existing file if a file with the same name exists in the location you have specified. Assign the output to a String-type variable. <hr/> <p>Note: The session data will be saved if you select the Write XML data option.</p>
Start session	<p>Creates a new XML session based on an XML file or specified text.</p> <ul style="list-style-type: none"> Start the XML session. Enter the session name or select an existing variable used in the Start XML session action. Use this session name for all corresponding actions. In the Data Source field, select either File or Text: <ul style="list-style-type: none"> File: Select from the Control Room file, Desktop file, or an existing Variable of File type. Text: Specify the text name or select an existing variable. Save the XML session.

Action	Description
Update node	<p>Updates the value of a node.</p> <ul style="list-style-type: none"> Type the session name or select an existing variable used in the Start XML session action. Enter the XPath expression for the node to be updated. Enter a New value for the node. Select the Updates attribute(s) option to create a new Dictionary or to add an existing Variable of Dictionary-type.
Validate XML document	<p>The tags and document structure are defined when the XML document is created. Use this action to validate an XML document.</p> <ul style="list-style-type: none"> Enter the session name or select an existing variable used in the Start XML session action. Select the validation type from the following options: <ul style="list-style-type: none"> XML schema files (.xsd) <ul style="list-style-type: none"> List: Specify the schema XSD file path you want to validate in the Value field. Click Add to add multiple XML schema files (.xsd). Variables: Create a new variable of type List with subtype String and enter the XSD file path in the Default value field (optional) or use an existing variable. Internal Document Type Definitions (DTDs) Well formed Assign the output to a variable using Assign the output (Valid or Invalid) to variable

Using Insert node action

Use this action to insert a node in an existing XML file and assign it to a value. Optionally, assign a name space and attributes to the node.

To insert a node, do the following:

- Enter the session name.
Use the name of the session that you have used in the **Start XML session** action.
- Specify an **XPath expression** to indicate where to insert the new node.
- Enter a node name.
- Enter a value for the node.
- If the node name exists, select from the following options:
 - Insert it anyways**
 - Skip it**
 - Overwrite it**
- Specify the location to insert the node from the following options:
 - Beginning of the child nodes**
 - End of the child nodes**
 - Before specific child note**

- **After specific child node**

If **Before Specific child node** or **After Specific child node** is selected, specify the child node name before or after which the node must be inserted.

7. Optional: Enter the default name space to be mapped to the node.
8. Enter the attributes using a Dictionary-type variable.
Create a new variable of type **Dictionary** or use one that already exists.
9. Optional: Enter the attribute name space using a Dictionary-type variable
Create a new Dictionary-type variable or use one that already exists.
10. Click **Save**.

Example for using actions in XML package

Using the XML package, create a bot that reads and writes data from an XML file to an Excel sheet.

The sample XML used in this tutorial has the following structure:

```
<movies>
  <movie genre="" year="">
    <name></name>
    <description></description>
    <director></director>
    <writers>
      <writer type=""></writer>
      <writer type=""></writer>
    </writers>
    <rating>R</rating>
  </movie>
</movies>
```

Before you begin, [download a sample XML file](#).

The tutorial is intended to demonstrate the following actions:

- Use an XPath expression to get a node set with specific value and iterate through the items in the node set, for example, movies with specific rating in this tutorial.
- Use an XPath function to iterate through the child node sets.
- Concatenate variables to build a string.
- Write data to an Excel sheet.

Ensure the following:

- You know how to create bots.
- You are familiar with the Control Room user interface.

1. Create a bot and name it XMLDataReader.

<https://aa2019packagesdkfordocumentation.s3.us-west-2.amazonaws.com/videos/create-a-bot-xml-package-tutorial.mp4>

2. Add a step to group all tasks for opening an Excel sheet.

- a) Add the **Step > Step** action after the **Start** flow in the Bot editor.

Note: To add an action, search for the action in the **Actions** pane and drag it to the bot flow in the Bot editor.

- b) In **Title**, enter `Open an Excel Sheet and save the action`.

3. To create and open an Excel sheet, use **Excel advanced > Create workbook**.
 - a) Add the **Excel advanced > Create workbook** action within the **Step** action.
 - b) In **File path**, enter `C:\movies\movies.xlsx`, and save the action. If the `movies` folder does not exist in the specified path, create a `movies` folder in the path.
4. To select the first cell on the Excel sheet, use the **Excel advanced > Go to cell** action.
 - a) Add the **Excel advanced > Go to cell** action after the **Excel advanced: Create workbook** action.
 - b) Click **Specific cell** if it is not already selected, and enter `A1`.
 - c) Save the action.

<https://aa2019packagesdkfordocumentation.s3.us-west-2.amazonaws.com/videos/create-a-workbook-xml-package-tutorial.mp4>

5. Create another step to group all the tasks for retrieving XML data.
 - a) Add the **Step > Step** action after the first **Step** action.
 - b) In **Title**, enter `Get XML Data` and save the action.
6. Start an XML session.
 - a) Add the **XML > Start session** action within the **Get XML Data** step.
 - b) Under **File**, select **Desktop**, browse and select the sample XML file that you downloaded.
 - c) Save the changes.
7. To get all movie nodes with rating R, use the **Get multiple nodes** action.
 - a) Add the **XML > Get multiple nodes** action after the **Start session** action.
 - b) In **XPath Expression**, enter `//movie[rating/text()='R']`, and save the action.
The selected node set is stored in a system variable and is available to the **For each Node in a XML dataset** iterator now.
 - c) To ensure that the action retrieves the entire node set instead of just the text nodes, click **Xpath expression**.

<https://aa2019packagesdkfordocumentation.s3.us-west-2.amazonaws.com/videos/get-multiple-nodes-xml-package-tutorial.mp4>

8. Use the **Loop** action to iterate through the selected node set that the **Get multiple nodes** action retrieves.
 - a) Add **Loop > Loop** after the **XML: Get multiple nodes** action.
 - b) Under **Iterator**, select **XML > For each Node in a XML dataset** as the iterator.
 - c) In **Assign the current row to this variable**, click **(x)** and create a variable with the default name, for example, `XMLNode`. Each item in the node set is now available through the variable.
 - d) Save the action.
9. To get the movie name from the iterated node, use the **Get single node** action.
 - a) Add the **XML > Get single node** action within the **Loop: Loop** action.
 - b) In **XPath expression**, enter `$(XMLNode)/name`.
 - c) In **Assign the output to variable**, create a variable and name it `sMovieName`.
 - d) Save the action.

- 10.** To write the movie name from the XMLNode variable, use the **Set cell** action.
- Add the **Excel advanced > Set cell** action after the **Get single node** action.
 - Click **Active cell**, enter `$$sMovieName$` in **Cell value**, and save the action.

<https://aa2019packagesdkfordocumentation.s3.us-west-2.amazonaws.com/videos/main-loop-through-nodes-1-xml-package-tutorial.mp4>

- 11.** To select a new cell within the Excel sheet, use the **Go to cell** action.
- Add the **Go to cell** action after the **Set cell** action after the **Excel advanced: Set cell** action.
 - Click **Active cell**, select **One cell to the right**, and then save the action.

- 12.** To get the director name from the iterated node, use the **Get single node** action.
- Add the **XML > Get single node** action after the **Excel advanced: Go to cell** action.
 - In **XPath expression**, enter `$$XMLNode$/director`.
 - In **Assign the output to variable**, create a variable with the following name: `sDirector`
 - Save the action.

- 13.** To write the director name from the XMLNode variable, use the **Set cell** action.
- Add the **Excel advanced > Set cell** action after the **XML: Get single node** action.
 - Click **Active cell**, enter `$$sDirector$` in **Cell value**, and save the action.

- 14.** To select a new cell within the Excel sheet, use the **Go to cell** action.
- Add the **Go to cell** action after the **Excel advanced: Set cell** action.
 - Click **Active cell**, select **One cell to the right**, and then save the action.

<https://aa2019packagesdkfordocumentation.s3.us-west-2.amazonaws.com/videos/main-loop-through-nodes-2-xml-package-tutorial.mp4>

- 15.** Because the `<writers>` node can contain multiple `<writer>` nodes, get each writer name, concatenate the names, and write them to a single cell instead of writing values to multiple cells. To do so, add the **Loop** action within the current **Loop** action.

- To get the number of the `<writer>` nodes within the `<writers>` node, add the **XML > Execute XPath function** after the **Excel advanced: Set cell** action. In **XPath expression**, enter `count($XMLNode$/writers/writer)`. In **Assign the output to variable**, create a variable named `sWriterCount`.

You will use the `<writer>` node count to loop through all the `<writer>` nodes.

- Add the **Loop > Loop** action after the **XML: Execute XPath function** action.

Important: The second **Loop** action must be added within the main **Loop** action.

- Under **Iterator**, select **For n times** as the iterator.
- In **Times**, enter the following: `$$sWriterCount.String:toNumber$`

Note: `sWriterCount` contains a string value. To convert string to number, you can use the `$(variable name).String:toNumber$` format, for example, `$$sWriterCount.String:toNumber$`.

- In **Assign the current value to variable (optional)**, create a variable named `Counter`.
- Save the action.

<https://aa2019packagesdkfordocumentation.s3.us-west-2.amazonaws.com/videos/inner-loop-1-xml-tutorial.mp4>

16. To concatenate the values from all writer nodes, create a string variable.

- a) In the **Variables** pane, click the plus icon.
The **Create variable** window opens.
- b) In **Type**, select **String**.
- c) In **Name**, enter `sWriters`.
- d) Click **Create**.

<https://aa2019packagesdkfordocumentation.s3.us-west-2.amazonaws.com/videos/inner-loop-1a-xml-tutorial.mp4>

17. To get the value from the iterated `<writer>` node, use the **Get single node** action.

- a) Add the **XML > Get single node** action within the second **Loop** action.
- b) In **XPath expression**, enter `$XMLNode$/writers/writer[$Counter.Number:toString$]`.
Using the `Counter` variable, you can access a node at a specific index. Note that because the `Counter` variable contains a numeric value, the `.Number:toString$` expression is added to the `Counter` variable to convert it to a string.
- c) In **Assign the output to variable**, create a variable and name it `sWriter`.
- d) Save the action.

18. To assign values from the writer nodes, use the **String > Assign** action.

- a) Add **String > Assign** action after the **XML: Get single node** within the second loop.
- b) In **Select the source string variable(s)/ value (optional)**, enter `$sWriters$, $sWriter$`.
- c) In **Select the destination string variable**, select `sWriters`.
- d) Save the action.

After the inner loop is complete, the `sWriters` variable will contain all the writer names.

<https://aa2019packagesdkfordocumentation.s3.us-west-2.amazonaws.com/videos/inner-loop-2-xml-tutorial.mp4>

19. To write the writer names to a new cell, use the **Excel advanced > Set cell** action within the main loop.

- a) Add the **Excel advanced > Set cell** action after the inner **Loop** action within the first **Loop** action.
- b) Click **Active cell**.
- c) Enter `$sWriters$` in **Cell value**.
- d) Save the action.

The data retrieved from one `<movie>` node is written to a row. To write the data from the next `<movie>` node, you must select the next row in the Excel sheet.

20. To move the cursor to the next row, use the **Excel advanced > Go to cell** action.

- a) Add the **Go to cell** action after the **Set cell** action.
- b) Click **Active cell**, select **Beginning of the row**, and then save the action.
- c) Add the **Go to cell** action again. Click **Active cell**, select **One cell below**, and then save the action.

<https://aa2019packagesdkfordocumentation.s3.us-west-2.amazonaws.com/videos/write-writer-names-to-cell-xml-package-tutorial.mp4>

- 21.** Before the next node in the retrieved `<movie>` node set is iterated, you must reset the `sWriters` variable. To reset the `sWriters` variable, perform the following steps:
- Add the **String > Assign** action after the **Excel advanced: Go to cell** within the main loop.
 - Leave **Select the source string variable(s)/ value (optional)** blank.
 - In **Select the destination string variable**, select `sWriters`.
 - Save the action.

<https://aa2019packagesdkfordocumentation.s3.us-west-2.amazonaws.com/videos/reset-string-variable-xml-package-tutorial.mp4>

- 22.** Create a new step.
- Add the **Step > Step** action after the second **Step** action.
 - In **Title**, enter `Close the file`.

- 23.** To close the Excel sheet, use **Excel advanced Close** action.
- Add **Excel advanced > Close** within the **Close the file** step.
 - Save the changes.

- 24.** Run the bot.

<https://aa2019packagesdkfordocumentation.s3.us-west-2.amazonaws.com/videos/close-file-xml-package-tutorial.mp4>

Get started with recorders

You can use two recorders in Automation 360, the Universal Recorder and the AISense Recorder, to automate tasks by recording interactions with objects such as click, read (data extraction), and write (data entry).

An integrated Recorder

In versions 2.0.9-20201105-164103 and later, the Recorder package contains both the Universal Recorder and AISense Recorder. This offers the following benefits:

- Feature updates are delivered as delta updates, which reduces the time spent downloading the newest Recorder package each release.
- The **Start recording** icon serves as a common entry point to both recorders.

Note: The AISense Recorder fails if you manually upgrade the Recorder package version, such as by importing a bot that contains the integrated Recorder package (Version A2019.17 and later) to a Control Room that has a build from Version A2019.16 or earlier. Always upgrade the Recorder package through the Control Room. Do not attempt to manually upgrade by importing a .jar file or bot.

Choosing which recorder to use for your task

Before you start building your bot, decide which recorder best fits your requirements.

Universal Recorder

Use Universal Recorder when you want to record interactions such as click, read, or write with user

interface objects on your business application. After you have captured the object, you can specify your requirements in terms of the action to be performed on that object.

For example, if you capture a hyperlink, you can select an action to click the link or to retrieve the link text. Similarly, if you capture a table object, you can specify to either retrieve the total number of rows from a table object or retrieve each row one by one and perform any actions on it. This is the most reliable form of automation because it is performed on user interface objects rather than coordinates, images, keystrokes and so on.

AISense Recorder

Use AISense Recorder when you are building and automating your bots on applications that are exposed over Citrix or accessed over RDP. You can also reduce the time spent on building and automating your bots for legacy applications where object-based automation is difficult.

The recorder's resiliency to screen resolution, browsers, and user interface alterations reduces limitations and obstacles when recording tasks across your business applications.

Universal Recorder for object-based automation

Use the Universal Recorder to record interactions, such as click, read (data extraction), and write (data entry), with user interface (UI) objects on the desktop, taskbar, or in an application or browser window.

The earlier Automation Anywhere RPA products such as Version 11.3 have three separate recorders to capture objects from various environments. Automation 360 combines the capabilities of these three recorders into the Universal Recorder to streamline the recording process.

Using the Universal Recorder

You can use the Universal Recorder in the following ways:

- 1.** To record a process consisting of multiple steps, use the Universal Recorder video camera icon, which is located on the top-left of the workbench.

Depending on where you want to add newly captured actions in an existing TaskBot, use one of the following ways:

- To add newly captured actions below an existing action, select the existing action and then start recording.
- To add newly captured actions before the existing actions that are available inside another action, select the other action and then start recording. For example, if you want to add newly captured

actions before the existing actions that are available inside a loop action, select the loop action and then start recording.

Note: If you do not select any action, then the newly captured actions are added at the end of the TaskBot by default.

See [Record a task with the Universal Recorder](#).

2. To record a single interaction that you want to add into an existing TaskBot (for example, if you missed a step when recording a task), use Capture action from the Recorder package.

See [Using the Capture action](#).

For a common use case, see [Example of entering data into a web form from a worksheet](#).

The Universal Recorder is also used within actions to capture coordinates (**Mouse** > **Click** action) or a local file path (**Application** > **Open program/file** action).

Background processing

Background processing enables an automation that involves interacting with an application in the foreground (such as mouse clicks) to run in the background. We recommend that you use the option to run in background to increase the visibility of the target object and improve bot accuracy. The following actions support background processing:

- Click
- Set Text
- Get Text

Related tasks

[Record a task with the Universal Recorder](#)

Use the Universal Recorder to capture a series of interactions (clicks, keystrokes, and mouse movements) with object controls including text boxes, buttons, tables, menus, radio buttons, combo boxes, check boxes, list views, links, trees, and page tabs.

[Edit a task recorded with the Universal Recorder](#)

After recording a task, edit the **Capture** actions to change the window, capture a different object, select a new action, enable background processing, enter a different wait time, or save the output to a variable.

Related reference

[Browser requirements for RPA Workspace](#)

Access the RPA Workspace interface from a browser. After you have installed and enabled extensions in the browser, perform several tasks through the RPA Workspace interface based on your user role and automation requirements.

[Secure recording mode](#)

When secure recording mode is enabled, the bots do not capture values of certain properties or store application images. This ensures that sensitive data is not stored in the bots. This setting only applies to bots that are created or edited after the mode is enabled.

[Recording tasks in applications that run on JRE](#)

Use the Universal Recorder to capture objects from Java applet, web start, and desktop applications that run using Java Runtime Environment (JRE) 6, 7, 8, 9, 10, and 11.

[Recorder package](#)

Recorder package captures a series of tasks in a process and then automates them. You can automate your business applications (for example, desktop, Web, SAP, and Java applications) using the Recorder to

capture actions performed on application objects such as a text box, button, table, radio button, combo box, and list view.

Actions performed on objects captured with Universal Recorder

After capturing the object, specify the action for the bot to do to the object at runtime. For example, if you capture a hyperlink, you can select an action to click the link or to retrieve the link text. Refer to the table below for the objects and their possible actions.

Record a task with the Universal Recorder

Use the Universal Recorder to capture a series of interactions (clicks, keystrokes, and mouse movements) with object controls including text boxes, buttons, tables, menus, radio buttons, combo boxes, check boxes, list views, links, trees, and page tabs.

- To use the Recorder, you must already have done the following:

- [Install Bot Agent and register device](#)
- [Set user device credentials](#)

- Configure device display and font scale to 100%.

If you are using Recorder package version 2.0.6-20200626-193519 or later, you can record tasks in Google Chrome, Internet Explorer, Java, Microsoft Active Accessibility, and Microsoft UI automation applications on a computer that has display scale configured to 100%, 125%, or 150%.

- If you are automating a task using a browser, configure the zoom level to 100%.

If you are using Recorder package version 2.0.6-20200626-193519 or later, you can record tasks in a Google Chrome browser that does not have a zoom level setting of 100%.

- If you are automating a task using a Google Chrome browser, ensure that the Automation Anywhere plug-in that corresponds with the Automation 360 build version is enabled.

[Browser requirements for RPA Workspace](#)

- To automate web applications running on Microsoft Edge Chromium browser in Internet Explorer mode using the Universal Recorder, ensure that the Internet Explorer compatibility mode is enabled. The objects on the web applications are captured using HTML technology. To enable this mode, perform the following steps:

1. On the Microsoft Edge Chromium browser page, click **Settings**.
2. On the left panel, click **Default browser**.
3. Navigate to the **Allow sites to be reloaded in Internet Explorer mode** option and select **Allow**.
4. Click **Add** to add the URL of the page that you want to load in Internet Explorer mode.

Note: The pages that you add open in Internet Explorer mode for 30 days from the date when you add the page.

Considerations when recording a task:

- Use clicks when possible rather than shortcut keys.

When you click an object using the Recorder, it retrieves the object's properties that enable the bot to identify the object at runtime. Keyboard shortcuts are less reliable, so use them when it is not possible to automate the task by a clicking an object.

- If you are automating a task using a browser, do not use autofill to enter values into fields.
- Record the task at low speed.
- Avoid dragging windows during the recording process.
- Avoid clicking on applications that are not part of the process you are recording and automating.

- When Internet Explorer is used, the action waits until the browser is completely rendered and is in a ready state before executing the action.

To record a task using the Universal Recorder, follow these steps:

1. From Automation Anywhere web interface left panel, click **Automation**.
2. Create a new bot or open an existing bot for which you want to record a task.
3. Click **Start recording**.

Note: In versions 2.0.9-20201105-164103 and later, the Recorder package contains both the Universal Recorder and AISense Recorder.

An integrated Recorder

The **Automation Anywhere Recorder** window appears.

4. Select a window from the drop-down list.
If you opened an application recently and it is not available in the list, click the **Refresh** icon.
5. Click **Universal Recorder**.
6. Perform the steps in the task. For example, click buttons, fill in forms, or search a website.
To perform an action on an object, move the mouse pointer on that object. The object is highlighted with a box. If the box does not appear, verify that you have enabled the necessary plug-in. For more information, see *Universal Recorder supported applications and browsers*.

The **Recorder** window contains the number of operations recorded and a description of the most recently captured object. For example, 5. Left click on button 'Submit'.

To redo the previous object capture, click the **Delete** icon at the bottom right of the **Recorder** window to discard the most recent capture.

If Secure recording mode is enabled, a shield icon appears to the right of the red recording icon.

Secure recording mode

7. Click **Finish** after you finish capturing all the necessary objects.
A **Capture** action is generated for each operation.
Where applicable, the **Recorder** generates variables. *Your variables (user-defined)*
8. Edit the actions or click **Save**.

Edit a task recorded with the Universal Recorder

Edit a task recorded with the Universal Recorder

After recording a task, edit the **Capture** actions to change the window, capture a different object, select a new action, enable background processing, enter a different wait time, or save the output to a variable.

Select the **List** view to see the full details of each action.

Edit a recorded task to do the following:

- Change the application window in which you want to perform the operation, or add a wildcard to the window title.
- Change the properties of the captured objects.
- Specify the action you want to perform on the captured objects.
- Introduce a delay before the next action is performed.
- Specify the variable you want to use to store the output.

To add a **Capture** action to the task, see *Using the Capture action*.

To edit a recorded task, perform the following steps:

1. Open the bot that contains the recorded actions you want to edit.
2. Click the **Capture** action that you want to edit.

Make the following changes, as necessary:

3. Change the window selection to the **Currently active** window option.
4. Optional: Insert a wildcard character (*) in the **Window title** field to search for window titles that can change. You can specify one or more wildcards (*) at the start, middle, or end of the value.

For example, to perform an operation on any window that has `Microsoft` in the title, use a wildcard to indicate any string by adding it before or after the value: `*Microsoft*`. The first searches for the exact window title (`Microsoft`), and if it does not find a match, it searches for windows with the term `Microsoft` anywhere in the title.

You can use a regular expression (regex) to identify a window title. Select the regular expression condition as either **String** or a **Pattern** and then enter the value. By default, the **Window title** field is case-sensitive.

To identify a browser title, you can enable the **Case sensitive** option to match the letter case, or disable the option to identify a window title where the letter case does not match.

Note: Ensure that the minimum version installed on your system is the version that was released with v.26. If you have a version released with v.25 or earlier, then by default, the window title will be identified only with matching letter case (case-sensitive).

For example, you can enter the **String** value as `((\w*)-Notepad` for all window title names starting with `((\w*)-Notepad`, or use **Pattern** value as `((\w)\s)*document-Notepad` for only those window titles that match this pattern.

Note:

- When you use a regular expression of type **String** with `-title` as the input value for a window title in any , the might encounter a run time error. To prevent the run time error, ensure that when you add the string input as `*-title`, the application with the specific title is open. The asterisk (*) is just a character, not a wild card character.
- When you use a regular expression of type **Pattern** with `-title` as the input value for a window title in any , the might encounter a run time error because the input value `*-title` is incorrect.

Ensure that you use valid regex patterns.

Note: During runtime, verify that the TaskBot identifies the correct window. If it does not, do the following:

- a. Open the application or browser window.
 - b. Drag a **Window > Get active window title** action above the **Recorder > Capture** action.
 - c. Insert a string variable into the **Assign the window title to variable** field.
 - d. Drag a **Window > Set title** action below the **Window > Get active window title** action.
 - e. In the **Window** field, insert the window variable generated by the **Recorder > Capture** action.
 - f. In the **New window title** field, insert the string variable from the **Get active window title** action.
 - g. Click **Save**.
-

5. Optional: Select the **Resize window** option to specify the window dimensions.

This option delivers a more reliable bot. It resizes the window to the dimensions at which the task was recorded, which enhances the ability of the bot to identify the target object.

- If the window is maximized when you record the task, this option is not selected.
- If the window is not at the maximum size when you record the task, this option is selected, by default, and the width and height fields are automatically filled with the dimensions of the window.

Note: This option is available only for windows that can be resized. It is not available for the **Desktop** or **Taskbar** options.

6. Review the **Object properties** table.

Following are the list of object properties that are selected by default based on the technology type:

Important: The following list does not include all the properties and is restricted to the most commonly used and important properties based on the technology type

Technology type	Object properties	Description
HTML Technology	Control type	This is a read-only property that shows the type of object captured, for example, text box or button.
	DOMXPath	<p>It is the path that is used to locate the control or object that is captured. DOMXPath can be of two types: Relative XPath and Absolute XPath.</p> <ul style="list-style-type: none"> • Absolute Xpath: It contains the complete path from the root element to the desired element. For example, an absolute Xpath for this topic would be <code>/html/body/div/div[1]/main/div[2]/div/div/div[2]/div/div/div[1]/div/article/main/article/div/p[1]</code> • Relative Xpath: This is a shorter path that refers to an element you want to identify. A relative path starts with a <code>//</code> symbol. For example, the relative XPath for this topic would be <code>//*[@id="cloud-using-recorder-action"]/div/p[1]</code> <p>For example, if you want to find the DOMXPath of a particular element on Google Chrome browser, perform these steps:</p> <ol style="list-style-type: none"> Select the element for which you want to extract the XPath. Right-click the element and select Inspect. Right-click the highlighted element in the Element tab. Go to Copy > Copy Xpath to copy the relative path and select Copy > Copy full Xpath to copy the absolute path.

Technology type	Object properties	Description
	Path	It is a numeric representation of the position of a particular control in an application. For web applications, the best practise is to use DOMXPath from the search criteria when compared to Path .
	HTML name and ID	These properties are used to identify an HTML object
	HTML inner text	The DOM innerText Property is used to set or return the text content of a specified node and its descendants
	HTML tag	HTML tags are like keywords that define the way web browser formats and displays the content. For example, if the captured text has an HTML code: <code><h3 class="search_results-title">Search results for "string package"</h3></code> , then enter <code>h3</code> in the HTML tag field.
Microsoft Active Accessibility	Control type	This property is used only as a reference to ensure that the correct object is captured
	Path	It is a numeric representation of the position of a particular control in an application
	Name	This specifies a name of an element and works as an identifier
	ID	This specifies the ID of an element and works as an identifier
Java Technology	Control type	This property is used only as a reference to ensure that the correct object is captured
	Path	It is a numeric representation of the position of a particular control in an application
Microsoft UI Automation	Control type	This property is used only as a reference to ensure that the correct object is captured
	Path	It is a numeric representation of the position of a particular control in an application
	Name	This specifies a name of an element and works as an identifier
	ID	This specifies the ID of an element and works as an identifier
Microsoft UI Automation (COM)	Control type	This property is used only as a reference to ensure that the correct object is captured.
	Path	It is a numeric representation of the position of a particular control in an application.
	Name	This specifies a name of an element and works as an identifier.

Technology type	Object properties	Description
	ID	This specifies the ID of an element and works as an identifier.

The bot uses the selected properties to identify the object control at runtime.

- a) Verify that the **Control Type** matches your intended object.

For example, when capturing a table from a website, ensure the **Control Type** and **HTML Tag** values are **Table**.

If the **Control Type** does not match your intended object, recapture the object control.

- b) Select and assign values to the object properties that you want to include in the object search.

For a more reliable bot, we recommend that you select only the properties that have static values (such as **Name**, **Class**, **Type**, **HTML ID**, and **DOMXPath**), and deselect the properties that have dynamic values (such as **HTML Href**, **Path** or **Value**), which are subject to change and cause bot errors.

It is a best practice to use the wildcard character (*) or variable in object property values to search for objects whose properties are dynamic and changes frequently.

7. Select the **Action** from the drop-down list.

For a full list of possible actions by object, see [Actions performed on objects captured with Universal Recorder](#).

- If you record a click and keystrokes in a text box with a **Control Type** of `Password text`, the **Recorder** does not capture the keystrokes entered into the field. Instead, the action selects the **Set text** option and offers options to securely input the password. We recommend that you store the password in the Credential Vault and insert it into the action as a credential. [Credentials and credential variables in the Bot editor](#)

If you navigate to the text box using the TAB keystroke instead of a click in an MSAA or SAP application, the **Recorder** is able to identify fields with a **Control Type** of `Password text`.

We recommend setting a delay time when using the Set text action to enter keystrokes into a text field.

- If the selected **Action** supports background processing, a **Run in the background** option appears. [Background processing](#)

8. Optional: Enter a value in the **Wait for control** field to specify the number of seconds the bot must wait for the object control to appear on the application window.

9. Optional: Assign the output to a variable.

The Control Room suggests a descriptive default variable name based on the action you selected in step 8. For example, if you selected **Get property**, the suggested output variable is `PropertyValue`. If you create several output variables, subsequent variable names are appended with a `-1` to avoid duplication.

10. Perform the Steps 3 through 9 for the other actions that you want to edit in the bot.

11. Click **Save**.

Link an object to a supporting anchor

Note: You can use object anchoring in Microsoft Active Accessibility, Microsoft UI Automation, or Java applications.

At runtime, if the bot cannot reliably identify an object, link it to a nearby object (such as a link or button) that is easier for the bot to find:

1. Open the **Capture** action.
2. Click the **Anchor** tab.
3. Click **Capture anchor**.

The browser or application window activates with the main object highlighted (the object that you previously captured). A dialog box appears, verifying whether the action has correctly identified the main object.

4. If the correct object is highlighted, click **Yes, Select anchor**.
Otherwise, click **No, I need to correct it** to select the correct object.
5. Select a nearby object to the target object that is easier for the bot to find.
The object is highlighted with an anchor icon on the right of the object.
6. Click **Save**.

Universal Recorder supported applications and browsers

Use the Universal Recorder to record interactions with objects from the supported technologies.

Applications

- HTML applications
- Java applet, web start, and desktop applications that run using Java Runtime Environment (JRE) 6, 7, 8, 9, 10, and 11 (32-bit and 64-bit versions)
See [Recording tasks in applications that run on JRE](#).
- Microsoft Active Accessibility and UI automation
- Microsoft Silverlight version 5 (standard Microsoft controls only)
- Oracle EBS and Forms
- SAP versions 730, 740, 750 patch 9, 760 patch 5, and 770 patch 6
- Citrix Virtual Apps
- Electron

Browsers

- Google Chrome (versions 91 and later) for Manifest V3 extension
- Google Chrome (versions 90 and earlier) for Manifest V2 extension

To build and run bots that contain actions from the Recorder package, you must enable the Google Chrome extension that corresponds with the Recorder package version. See [Google Chrome browser extension requirements](#).

If you encounter an error when recording or running a bot that automates tasks in a Google Chrome browser and you have installed Google Chrome, you must perform additional steps to configure your system. See [Google Chrome extension troubleshooting](#).

- Internet Explorer (version 11)

- Microsoft Edge (version 91 and later) for Manifest V3 extension
- Microsoft Edge (version 90 and earlier) for Manifest V2 extension
- Microsoft Edge based on Chromium (versions 79 and later)

Microsoft Edge is supported on Recorder package version 2.0.9-20201105-164103 and later. You must install the A2019 plug-in for Microsoft Edge and verify that it is running in the Task Manager: [Automation 360 extension for Microsoft Edge](#)

Note: Ensure that the Google Chrome extension is not installed in the Microsoft Edge browser because that configuration causes recording and runtime errors. [Google Chrome extension installed in Microsoft Edge](#)

- Mozilla Firefox (versions 80 and later)

Mozilla Firefox is supported on Recorder package version 2.0.11-20210128-034104 and later. You must install the A2019 extension for Mozilla Firefox: [Automation 360 extension for Mozilla Firefox](#)

Desktop

The desktop refers to the device screen when all application and browser windows are minimized.

Taskbar

The taskbar is the horizontal or vertical bar containing icons of open applications and browsers, as well as the notification area. You can capture application, browser, and system icons, such as Clock and Calendar, volume, and Wi-Fi.

UI objects

See [Actions performed on objects captured with Universal Recorder](#).

Related reference

[Actions performed on objects captured with Universal Recorder](#)

After capturing the object, specify the action for the bot to do to the object at runtime. For example, if you capture a hyperlink, you can select an action to click the link or to retrieve the link text. Refer to the table below for the objects and their possible actions.

Google Chrome browser extension requirements

Ensure the Automation Anywhere Google Chrome extension you are using corresponds with the Recorder package version in your bots.

Automation Anywhere has created two versions of the Google Chrome extension, based on the Recorder package version. **Automation Anywhere A2019 extension version 1.1.0.1 is the recommended Google Chrome extension for bots that contain actions from the Recorder package 2.0.6 and later.** Automation Anywhere Google Chrome extension version 11 or 12 is required only to run bots that contain actions from the Recorder package 2.0.5 and earlier.

Use the table below to verify that your system is running the correct browser agent and Google Chrome extension.

- Verify the browser agent in the **Windows Task Manager > Details** tab.
If the browser agent is in the Task Manager, but is not running:
 1. Verify that the `ComSpec` variable is defined in the **Environment Variables** list.
You can locate this list in **My computer > Properties > Advance System Settings > Environment Variables**.
 2. If the `ComSpec` variable is not in the list, define it by specifying the **Variable Name** as `ComSpec` and the **Variable Value** as `%SystemRoot%\system32\cmd.exe`.
- Verify the Google Chrome extension version in `chrome://extensions/`.
- If necessary, install the Google Chrome extension using the links in the table below.

Google Chrome re-verification: Google Chrome requires re-verification of permissions when the Automation Anywhere Google Chrome extension is updated. If prompted, click **Enable this item** in the Google Chrome message. Alternatively, re-enable the extension through the links in the table above. Similarly, if you are deploying your Bot Runners from a master image, accept the permission from within that image.

Recorder package version	Browser agent	Google Chrome extension and ID
2.0.5 or earlier	<code>Automation.BrowserAgent.exe</code>	Version 11 or 12 ID: jjpdebaihkangkfpbgfemnnlafkahebn
2.0.6 or later	<code>Automation.Bot.BrowserAgent.exe</code>	Version 1.1.0.1 or later ID: kammdlphdfejlopponbapgpbgakimokm

Note: If you upgrade the Bot Agent version by uninstalling the Bot Agent instead of directly upgrading, this also uninstalls the Google Chrome extension. In that case, you must manually reinstall the Google Chrome extension.

If you encounter an error when recording or running a bot that automates tasks in a Google Chrome browser and you have installed the Google Chrome, you must perform additional steps to configure your system. See [Google Chrome extension troubleshooting](#).

Related reference

[Google Chrome extension troubleshooting](#)

If you encounter an error when recording or running a bot that automates tasks in a Google Chrome browser and you have installed Google Chrome, you must perform additional steps to configure your system.

Google Chrome extension troubleshooting

If you encounter an error when recording or running a bot that automates tasks in a Google Chrome browser and you have installed Google Chrome, you must perform additional steps to configure your system.

Prerequisites

Ensure the Automation Anywhere Google Chrome extension you are using corresponds with the Recorder package version in your bots. See [Google Chrome browser extension requirements](#).

To configure your system to run the Google Chrome extension, choose the scenario that applies to you and follow the steps.

Recorder package version 2.0.9 or later:

1. Verify that Google Chrome extension version 1.1.0.1 or higher is installed and enabled.
To install the extension, see [Version 1.1.0.1 or later](#).
2. Open the Windows registry to the Google Chrome browser agent: `Computer\HKEY_LOCAL_MACHINE\SOFTWARE\WOW6432Node\Google\Chrome\NativeMessagingHosts\automation.bot.browseragent`
3. Verify that the registry entry points to the Automation 360 Bot Agent installation directory:
`C:\Program Files\Automation Anywhere\Bot Agent\AABrowserAgent\AAChromeAgentManifest.json`
If this configuration is missing, reinstall the Bot Agent.

Recorder package version 2.0.6, 2.0.7, or 2.0.8 (for Version A2019.16 or earlier)

1. Open the Windows registry to the Google Chrome browser agent: `Computer\HKEY_LOCAL_MACHINE\SOFTWARE\WOW6432Node\Google\Chrome\NativeMessagingHosts\automation.chrome.agent`
2. Verify that the registry entry points to the Automation 360 global cache: `C:\ProgramData\AutomationAnywhere\GlobalCache\embedded-resources\<Recorder package version>\AAChromeAgentManifest.json`

For example, `C:\ProgramData\AutomationAnywhere\GlobalCache\embedded-resources\2.0.6-20200626-193519-1bd6fceb-b036-4202-9932-4dc18349bd5c\AAChromeAgentManifest.json`

If this configuration is missing, do the following steps as an admin:
 - a. Open the Automation 360 global cache: `C:\ProgramData\AutomationAnywhere\GlobalCache\embedded-resources\<Recorder package version>`
 - b. Run the `install.ps1` file.
 - c. Repeat steps 2 and 3 to verify the registry entry is updated.

Recorder package version 2.0.5 or earlier, and never installed Automation Anywhere Enterprise Version 11.3 or later

Note: Use latest Recorder package version available in your Control Room.

1. Verify that Google Chrome extension version 11 or 12 is installed and enabled.
To install the extension, see [Version 11 or 12](#).
2. Open the Windows registry to the Google Chrome browser agent:
`Computer\HKEY_LOCAL_MACHINE\SOFTWARE\WOW6432Node\Google\Chrome\NativeMessagingHosts\automation.chrome.agent`

3. Verify that the registry entry points to the Automation 360 global cache: `C:\ProgramData\AutomationAnywhere\GlobalCache\embedded-resources\<Recorder package version>\AAChromeAgentManifest.json`

For example, `C:\ProgramData\AutomationAnywhere\GlobalCache\embedded-resources\2.0.5-20200626-193519-1bd6fceb-b036-4202-9932-4dc18349bd5c\AAChromeAgentManifest.json`

If this configuration is missing, do the following steps as an admin:

- a. Open the Automation 360 global cache: `C:\ProgramData\AutomationAnywhere\GlobalCache\embedded-resources\<Recorder package version>`
 - b. Run the `install.ps1` file.
 - c. Repeat steps 2 and 3 to verify the registry entry is updated.
4. Verify that the browser agent `Automation.BrowserAgent.exe` is running with the Google Chrome extension installed and enabled.

If this configuration is missing, restart Google Chrome. Either disable and enable the Google Chrome extension, or close all Google Chrome browser tabs and reopen a new window.

Recorder package version 2.0.5 or earlier, and installed Automation Anywhere Enterprise Version 11.3 or later

1. Verify that Google Chrome extension version 11 or 12 is installed and enabled.
To install the extension, see [Version 11 or 12](#).
2. Open the Windows registry to the Google Chrome browser agent: `Computer\HKEY_CURRENT_USER\Software\Google\Chrome\NativeMessagingHosts\automation.chrome.agent`
 - If the above key is available, disable the Google Chrome plug-in version 11.x and enable the Google Chrome plug-in version 12.x.
 - If the above key is not available, disable the Google Chrome plug-in version 12.x and enable the Google Chrome plug-in version 11.x.
3. Restart Google Chrome. Either disable and enable the Google Chrome extension, or close all Google Chrome browser tabs and reopen a new window.
4. Verify that the browser agent `Automation.BrowserAgent.exe` is running with the Google Chrome extension installed and enabled.

Automation Anywhere Enterprise Version 11.3 or later is uninstalled

Uninstalling the Enterprise Client does not remove the Google Chrome extension and registry entries. To remove them manually, do these steps:

1. Disable Google Chrome extension 12.x.
2. Install and enable Google Chrome extension 11.x.
3. In the Windows registry editor, remove the following key: `Computer\HKEY_CURRENT_USER\Software\Google\Chrome\NativeMessagingHosts\automation.chrome.agent`

4. Open the Windows registry to the Google Chrome browser agent:

```
Computer\HKEY_LOCAL_MACHINE\SOFTWARE\WOW6432Node\Google\Chrome  
\NativeMessagingHosts\automation.chrome.agent
```

5. Verify that the registry entry points to the Automation 360 global cache: C:\ProgramData\AutomationAnywhere\GlobalCache\embedded-resources\`<Recorder package version>`\AAChromeAgentManifest.json

For example, C:\ProgramData\AutomationAnywhere\GlobalCache\embedded-resources\2.0.6-20200626-193519-1bd6fceb-b036-4202-9932-4dc18349bd5c\AAChromeAgentManifest.json

6. Restart Google Chrome. Either disable and enable the Google Chrome extension, or close all Google Chrome browser tabs and reopen a new window.

Google Chrome extension installed in Microsoft Edge

Although Microsoft Edge browser settings allow extensions from the Chrome Web Store, we recommend that you **do not install** the Google Chrome extension in the Microsoft Edge browser. Installing it causes recording and runtime errors in bots that interact with the Google Chrome browser. Even if you did not manually install the Google Chrome extension, the auto-sync settings in the Microsoft Edge browser might have automatically installed the extension.

Unable to view Google Chrome extension in offline mode

1. Drag the file `ChromeExtension.crx` to the Google Chrome extension tab.

This file is available in the same path where the `Automation.BrowserAgent.exe` file is available.

Enable the Automation 360 Google Chrome extension.

2. If the Google Chrome extension is still not visible:

- a. Verify if the registry entry `automation.chrome.agent` is available in the path `Computer\HKEY_CURRENT_USER`.

If it is not available, create the registry in the following path: `Computer\HKEY_CURRENT_USER\Software\Google\Chrome\NativeMessagingHosts\automation.chrome.agent`

This entry should have the same path as the entry: `Computer\HKEY_LOCAL_MACHINE\Software\Google\Chrome\NativeMessagingHosts\automation.chrome.agent`

- b. Go to the path `Computer\HKEY_LOCAL_MACHINE\Software\Google\Chrome\Extensions`.

For the 11.1.0.0 Automation 360 Google Chrome extension ID `jjpdebaihkgkfpbgfemnnlafkahebn`, create a new string with the name `path`.

The value of the string will be the path of the `ChromeExtension.crx`, which is available in the same folder where the `AAChromeAgentManifest.json` file is available.

For example, add the entry `C:\ProgramData\AutomationAnywhere\GlobalCache\embedded-resources\2.0.5-20200511-172840-1825fd43-19bc-4dd2-ac56-53a2aed4b0e4\ChromeExtension.crx` in the following locations:

- `Computer\HKEY_LOCAL_MACHINE\Software\Google\Chrome\Extensions(ExtensionID)`
- `Computer\HKEY_CURRENT_USER\Software\Google\Chrome\Extensions(ExtensionID)`

- c. Restart Google Chrome. Either disable and enable the Google Chrome extension, or close all Google Chrome browser tabs and reopen a new window.

Secure recording mode

When secure recording mode is enabled, the bots do not capture values of certain properties or store application images. This ensures that sensitive data is not stored in the bots. This setting only applies to bots that are created or edited after the mode is enabled.

A user with admin privileges must enable secure recording mode. See [Settings](#).

To capture objects in secure recording mode, ensure that the Recorder package is set to 2.0.0-20200318-020414 or higher. See [Manage Control Room packages](#).

When you record a task in secure recording mode, the **Preview** window temporarily shows the captured area. This image is deleted after you close the bot.

When you record a task in secure recording mode, you can choose whether or not the captured images are available for preview and stored in the Control Room. See [Secure recording](#)

Note: Ensure that you use the latest version of the Recorder package. If you are using the 2.7.3-20220527-004608 or an older version of the Recorder package, a preview of the images will be shown in the Bot editor when the objects are captured. The images will be discarded when you refresh the Bot editor.

You can update the following object properties after capturing an object:

Technology	Object property
Microsoft Active Accessibility/UI automation/Java	<ul style="list-style-type: none"> • Item name • Item value • Name • Parent • Value
HTML	<ul style="list-style-type: none"> • HTML InnerText • HTML name • HTML value
Microsoft UI Automation (COM)	<ul style="list-style-type: none"> • Description • Image • Value • Name • Parent • Item name • Item value • Data provider • Content • Legacy name • Legacy value • Legacy description

Recording tasks in applications that run on JRE

Use the Universal Recorder to capture objects from Java applet, web start, and desktop applications that run using Java Runtime Environment (JRE) 6, 7, 8, 9, 10, and 11.

Automation 360 supports JRE 6 and later on both 32-bit and 64-bit systems.

Verify whether additional configuration is necessary, depending on the JRE version:

- If JRE 7 update 6 or later is installed on the registered device, Java Access Bridge is automatically installed on that device.
- If JRE 7 update 5 or earlier is installed on the registered device, you must manually copy the required files to the corresponding directories. See [Java Access Bridge](#).
- If you have more than one version of JRE, Automation 360 configures Java Access Bridge with the default version. To configure it to a different version, you must manually copy the required files to the corresponding directories. See [Java Access Bridge](#).

The first time you record a task in an application running on JRE 6 or 7 update 5 or earlier, an error message might appear if the application is launched before Java Access Bridge is installed. Restart the application and proceed with recording the task.

AI Sense for recording tasks from remote applications

AI Sense is the artificial intelligence (AI) powered capability of Automation 360 that helps you identify objects from an image or an application with a complex user interface (UI) and make automation in all environments faster and more accurate.

AISense is suitable when object-based automation fails or is not efficient for automating tasks on applications that are accessed remotely, in a Citrix environment, and legacy applications.

Some of the issues that affect the accuracy of an automation task in a remote environment are as follows:

- In a Citrix environment, the automation platform receives an image of the application and does not have access to the actual UI elements.
- Screen resolution and scaling might not be the same on the host and client machines.
- The position of a UI element might change for web applications due to a different resolution on the Bot Runner machine.

AISense uses computer vision to intelligently create dynamic linking between objects by determining their composition to deliver change-resilient automation. AISense enables you to accurately automate applications even when labels and text change their position.

Important:

- Bots will fail if they contain actions from Recorder package versions 2.0.9-20201105-164103 or later and the AISense package. You must delete the **AISense** actions and recapture the objects using the integrated recorder icon. [An integrated Recorder](#)
- AISense Recorder supports the following languages: English, Simplified Chinese, Korean, Brazilian-Portuguese, Japanese, and Russian. When you record an application, ensure that the device locale is set to the same language as that of the application, regardless of operation system and keyboard layout. If the user interface (UI) of the application is a combination of English and another language, set the device locale to the other language. For example, if the UI is a combination of English and Russian, set the device locale to Russian.

Note: Even if the device locale is set to a language other than English, you can continue to automate applications that have an English UI without changing the device locale to English.

Recommendation: On any application, regardless of the language of the application, when you use the **Get text** action to retrieve text from a specified area, if the retrieved text is not accurate, we recommend that you perform one of the following actions and then record again:

- Increase the font size.
- Decrease the screen resolution.
- Zoom in to capture the text correctly.

Related tasks[Record a task with AISense Recorder](#)

Use the AISense Recorder to record an end-to-end task on a remote application or an application with a complex user interface (UI).

[Edit a task recorded using AISense](#)

After you have recorded a task using the AISense Recorder, you can edit the recorded actions to perform various actions on the captured objects.

Record a task with AISense Recorder

Use the AISense Recorder to record an end-to-end task on a remote application or an application with a complex user interface (UI).

- If you are automating a task using a browser, ensure that auto-fill is disabled for that browser.
- The screen resolution must be set to 1980x1080 or lower.
- Configure the device display settings to 100% DPI.

- If you are using Automation 360 On-Premises, ensure that the AISense Recorder package is added to your Control Room.

AISense Recorder can capture the following objects from an application: text boxes, buttons, radio buttons, combo boxes, check boxes, active and passive text, image button, scroll, and combo box.

Keep the following considerations in mind when recording a task:

- Record the task at low speed.
- Avoid dragging windows during the recording process.
- Avoid clicking applications that are not part of the process you are recording to automate.

To record a task using the AISense Recorder, follow these steps:

1. From Automation Anywhere web interface left panel, click **Automation**.
2. Create a new bot or open an existing bot for which you want to record a task.
3. Click **Start recording**.

Note: In versions 2.0.9-20201105-164103 and later, the Recorder package contains both the Universal Recorder and AISense Recorder.

An integrated Recorder

The **Automation Anywhere Recorder** window appears.

4. Select a window from the drop-down list.

If you opened an application recently and it is not available in the list, click the **Refresh** icon.

5. Click **AISense Recorder**.

The first time you use the AISense Recorder on a device, the Recorder downloads the required dependencies.

The **Recorder** toolbar appears with **Finish**, **Scan**, **Define**, and **Pause** options.

The Recorder analyzes the application window you selected to identify the UI objects in that window. The options on the toolbar are disabled when the system is analyzing the application window. After the analysis, the options are enabled and you can start recording the task.

6. Perform the actions to record. For example, click buttons, fill in forms, or select an option.

To perform an action on an object, move the mouse pointer on that object. The system highlights an object along with the text associated with that object. For example, when you move the mouse

pointer over a button or check box, the associated text with that button or check box is also highlighted and captured.

- If the object is not highlighted, click the **Scan** option on the recording toolbar. After the system finishes analyzing the application window, you can capture the required object.
- If you want to capture an option from a list, click the list and wait until the highlight appears around the box containing the options. After the box is highlighted, move the mouse pointer over the option you want to capture and wait until the option is highlighted.
- If you use scroll on an application window, you must click **Scan** to analyze the new objects on the window.
- If you want to record an interaction with an object that is only visible when you hover the mouse over the object, see [Detect hidden objects manually](#)

The **Recorder** window contains the number of operations recorded and a description of the most recently captured object. For example, 5. Left click on button 'Submit'.

To redo the previous object capture, click the **Delete** icon at the bottom right of the **Recorder** window to discard the most recent capture.

If Secure recording mode is enabled, a shield icon appears to the right of the red recording icon.

[Secure recording mode](#)

7. Click **Finish** after you finish capturing all the necessary objects.

A **Capture** action is generated for each operation.

Where applicable, the **Recorder** generates variables. [Your variables \(user-defined\)](#)

8. Edit the actions or click **Save**.

[Edit a task recorded using AISense](#)

Detect hidden objects manually

If an object is only visible when you hover the mouse over the object, you must manually specify the object type and location by anchoring it to the nearest text:

1. Click the object once.
2. Click **Define**.

The **AISense Define main object** window appears with a screenshot of the application, where the object is visible.

3. Click and drag a rectangle to outline the object to capture.
4. In the **Supporting anchor** list, select the text that is closest to the object you are capturing.
5. Click **Apply**.

Related tasks

[Edit a task recorded using AISense](#)

After you have recorded a task using the AISense Recorder, you can edit the recorded actions to perform various actions on the captured objects.

Related reference

[AISense for recording tasks from remote applications](#)

AISense is the artificial intelligence (AI) powered capability of Automation 360 that helps you identify objects from an image or an application with a complex user interface (UI) and make automation in all environments faster and more accurate.

[Actions performed on objects captured with AISense Recorder](#)

After you capture objects using the AISense Recorder, you can perform various actions that a bot can perform on the object at runtime.

Edit a task recorded using AISense

After you have recorded a task using the AISense Recorder, you can edit the recorded actions to perform various actions on the captured objects.

Edit a recorded task to do the following:

- Change the application window in which you want to perform the operation, or add a wildcard to the window title.
- Change the properties of the captured objects.
- Specify the action you want to perform on the captured objects.
- Introduce a delay before the next action is performed.
- Specify the variable you want to use to store the output.

Important: Only the following types of objects are supported with AISense Recorder:

- Text boxes
- Check boxes
- Combo boxes
- Radio buttons
- Buttons
- Active text

Active text is the text that you can click. For example, link, menu, text on a navigation pane, and so on. When there are duplicate active texts on the window, the AISense Recorder identifies and applies the action of the first occurrence of that active text on the window.

- Passive text

Passive text is the text that you can only read. It can be any text visible on the window that can be associated with a nearby static anchor text that is available during bot execution. When you select an area that has multiple lines, the AISense Recorder retrieves only the first line of the text from the area.

- Image button

An image button is a button that contains only image and does not have any text associated with it. For example, icons for delete, copy, cut, paste, and so on. You can capture image buttons that are hidden on the application screen and appear when you hover the mouse pointer over them.

- Scroll on an application window and combo box

To edit a recorded task, perform the following steps:

1. Open the bot that contains the recorded actions you want to edit.
2. Click the **Capture** action that you want to edit.

Make the following changes, as necessary:

3. Click the **Window** tab or the **Variable** tab to specify a different application window on which you want to perform the operation.

If you have used the **Window** tab to specify the application window, you can use a wildcard character in the **Window title** field. The wildcard character is useful if the title of an application changes. For example, `Sample* - Google Chrome`.

Note:

- During runtime, verify that the TaskBot identifies the correct window.
- If you use scroll on an application window, you must click the **Analyze window** option to analyze the new objects on the window.

-
4. Update the object properties.

You can only update the value available in the **Anchor** field.

5. Select an option from the **Action** list to specify the action you want to perform on the object.

For a full list of possible actions by object, see [Actions performed on objects captured with AISense Recorder](#).

6. Optional: Enter a value in the **Wait for control** field to specify the number of seconds the bot must wait for the object control to appear on the application window.

We recommend setting a delay time when using the Set text action to enter keystrokes into a text field.

7. Optional: Assign the output to a variable.

The Control Room suggests a descriptive default variable name based on the action that you selected previously. For example, if you selected **Get text**, the suggested output variable is `CaptureText`. If you create several output variables, subsequent variable names are suffixed with a hyphen and number to prevent duplication of variable names.

8. Perform the Steps 2 through 7 for the other actions that you want to edit in the bot.

9. Click **Save**.

Link nearby text to a supporting anchor

At run time, if the bot cannot reliably identify an object, link the object to nearby text that is easier for the bot to find:

1. Open the **Capture** action.
2. Click the **Anchor** tab.
3. Click **Capture anchor**.

The browser or application window activates with the main object highlighted (the object that you previously captured). A dialog box appears, verifying whether the action has correctly identified the main object.

4. If the correct object is highlighted, click **Yes, Select anchor**.

Otherwise, click **No, I need to correct it** to select the correct object.

5. Select nearby text to the target object that is easier for the bot to find.

The text is highlighted with an anchor icon to the right of the text.

6. Click **Save**.

Actions performed on objects captured with AISense Recorder

After you capture objects using the AISense Recorder, you can perform various actions that a bot can perform on the object at runtime.

For example, when you capture a button, you can select to click the button or to retrieve the button text. The following table lists the objects and their possible actions.

Object	Actions
Button	<ul style="list-style-type: none"> • Get text: Extracts the value or caption from the specified captured object. • Click: Use this action to select the captured object. • Left click: Use this action if the Click action does not work during runtime. • Right click: Use this action to perform the right-click operation on the captured object. • Double click: Use this action to perform the double-click operation on the captured object.
Image button	<ul style="list-style-type: none"> • Left click: Use this action if the Click action does not work during runtime. • Right click: Use this action to perform the right-click operation on the captured object. • Double click: Use this action to perform the double-click operation on the captured object.
Active text	<ul style="list-style-type: none"> • Left click: Use this action if the Click action does not work during runtime. • Right click: Use this action to perform the right-click operation on the captured object. • Double click: Use this action to perform the double-click operation on the captured object.
Passive text	<p>Get text: Retrieves text available in the area you have specified.</p>
Check box	<ul style="list-style-type: none"> • Get text: Extracts the value or caption from the specified captured object. • Get status: Retrieves whether the check box is selected. Returns checked or unchecked. • Check: Selects the captured check box. • Uncheck: Clears the captured check box. • Toggle: Switches the check box to the opposite status. For example, if the check box is selected, use the Toggle action to clear it. • Left click: Use this action if the Toggle action does not work during Runtime. • Right click: Use this action to perform the right-click operation on the captured object. • Double click: Use this action to perform the double-click operation on the captured object.

Object	Actions
Combo box (appears as a drop-down list)	<ul style="list-style-type: none"> • Get text: Extracts the value or caption from the specified captured object. • Get selected text: Retrieves text from the selected item. • Select item by text: Selects the item that matches the text you have specified in the Assign value field. <hr/> <p>Note: The Assign value field is case-sensitive.</p> <hr/> <ul style="list-style-type: none"> • Expand: Expands the combo box. • Click: Use this action to select the captured object. • Left click: Use this action if the Click action does not work during runtime. • Right click: Use this action to perform the right-click operation on the captured object. • Double click: Use this action to perform the double-click operation on the captured object.
Scroll bar (within a combo box)	<ul style="list-style-type: none"> • Scroll Up: Performs the scroll up operation. This action is similar to clicking the scroll up button one time. • Scroll Down: Performs the scroll down operation. This action is similar to clicking the scroll down button one time. • Page Up: Performs the page up operation. This action is similar to holding the scroll bar and moving it up. The distance by which the scroll bar is moved up is specified in the Scroll Distance field. • Page Down: Performs the page down operation. This action is similar to holding the scroll bar and moving it down. The distance by which the scroll bar is moved down is specified in the Scroll Distance field. • Left click: Use this action if the Click action does not work during runtime. • Right click: Use this action to perform the right-click operation on the captured object. • Double click: Use this action to perform the double-click operation on the captured object.
RadioButton	<ul style="list-style-type: none"> • Get text: Extracts the value or caption from the specified captured object. • Get status: Retrieves whether the radio button is selected. Returns selected or deselected. • Select: Use this action to select the captured radio button. • Left click: Use this action if the Click action does not work during runtime. • Right click: Use this action to perform the right-click operation on the captured object. • Double click: Use this action to perform the double-click operation on the captured object.

Object	Actions
TextBox	<ul style="list-style-type: none"> • Get text: Extracts the value or caption from the specified captured object. • Set text: Enters the text you have specified in the captured field. It supports credentials. <i>Credentials and credential variables in the Bot editor</i> • Append text: Adds text at the end of existing text in the captured field, instead of overwriting it. • Click: Use this action to select the captured object. • Left click: Use this action if the Click action does not work during runtime. • Right click: Use this action to perform the right-click operation on the captured object. • Double click: Use this action to perform the double-click operation on the captured object.

Capture Image button through AISense Recorder

Image buttons or icons are clickable buttons with no anchors. An application can have one or multiple image buttons. AISense Recorder uses template matching to detect and match image buttons on an application. So even after you record, if the position of the image button changes due to window resizing, AISense Recorder can detect the object and run the bot.

Capture Image button

1. On the left pane, click **Automation**.
2. To create a bot, click **Create new > Bot**, or open a bot for which you want to record a task.
3. Click **Start recording**.
The Recorder bot runtime window appears.
4. Select a window from the drop-down list.
If you opened an application recently and it is not available in the list, click the **Refresh** icon.
5. Click **AISense Recorder** and allow the scanning process to finish.

Note: The AISense Recorder downloads the required dependent files the first time you use it on a device.

The AISense Recorder toolbar appears with these options: **Finish**, **Scan**, **Define**, and **Pause**.

The AISense Recorder analyzes the selected application window to identify the UI objects in that window. When the system is analyzing the application window, the options on the toolbar are unavailable. After the analysis completes, the options are enabled and you can start recording the task.

6. Wait for the AISense Recorder to detect the object.

- If the object is not detected automatically, then when the AISense Recorder reaches the **Ready** state, you can click the **Define** button to detect the object.

Note:

- In the **Define** window, the shows embedded help for each control type so you can select the correct control types for custom objects.
- If you unintentionally click the screen or click before the highlighter appears, provides visibility into it. You must confirm to capture the object again, or use the **Define** functionality to define the object on the screen.

- Select **Image button** from the **Select the object type for the selected area** tab.

The screenshot shows the AISense Define window with three steps:

- Step 1:** Drag and select the area which you want to define from the ... (A dashed box with a plus sign is shown on the right).
- Step 2:** Select one supporting anchor point for the selected area (A dashed box labeled 'Other bookmarks' is shown on the right).
- Step 3:** Select the object type for the selected area. The current selection is 'Selected Image button'. The 'Image button' option is selected and highlighted with a yellow box.

The background shows a web browser window with a table of 'Public Reports'.

Description	Folder	Created By
	Public Reports	Chetan Bhatt
	Public Reports	Kavita Samuel
	Public Reports	Siddharthan V
	Public Reports	Vipul Thikar
	Public Reports	Vipul Thikar
	Public Reports	Vipul Thikar
	Public Reports	Chetan Bhatt
	Public Reports	Chetan Bhatt
	Public Reports	Chetan Bhatt
	Public Reports	Khalid Pasha
	Public Reports	Khalid Pasha

- Draw a rectangle around the image button that you want to capture.

The selected area is shown in the box below the **Drag and select the area which you want to define from the image** field.

10. Hover the mouse cursor over the nearby static text. Once the text is highlighted, select the static text as the supporting anchor.

The image of the anchor is shown in the box below the **Select one supporting anchor point for the selected area** field.

11. Click **Define**.
12. After you have captured the required objects, click **Finish**.

Capture link button through AISense Recorder

The link button control is clickable and has no specific features. In some cases, the AISense Recorder cannot detect it. You must use the **Define** option to detect and capture the link button control.

Capture link button

1. On the left pane, click **Automation**.
2. To create a bot, click **Create new > Bot**, or open a bot for which you want to record a task.
3. Click **Start recording**.

The Recorder bot runtime window appears.

4. Select a window from the drop-down list.
If you opened an application recently and it is not available in the list, click the **Refresh** icon.
5. Click **AISense Recorder** and allow the scanning process to finish.

Note: The AISense Recorder downloads the required dependent files the first time you use it on a device.

The AISense Recorder toolbar appears with these options: **Finish**, **Scan**, **Define**, and **Pause**.

The AISense Recorder analyzes the selected application window to identify the UI objects in that window. When the system is analyzing the application window, the options on the toolbar are unavailable. After the analysis completes, the options are enabled and you can start recording the task.

6. Wait for the AISense Recorder to detect the object.
7. If the object is not detected automatically, then when the AISense Recorder reaches the **Ready** state, you can click the **Define** button to detect the object.

Note:

- In the **Define** window, the shows embedded help for each control type so you can select the correct control types for custom objects.
 - If you unintentionally click the screen or click before the highlighter appears, provides visibility into it. You must confirm to capture the object again, or use the **Define** functionality to define the object on the screen.
-

8. Select **Link** from the **Select the object type for the selected area** tab.

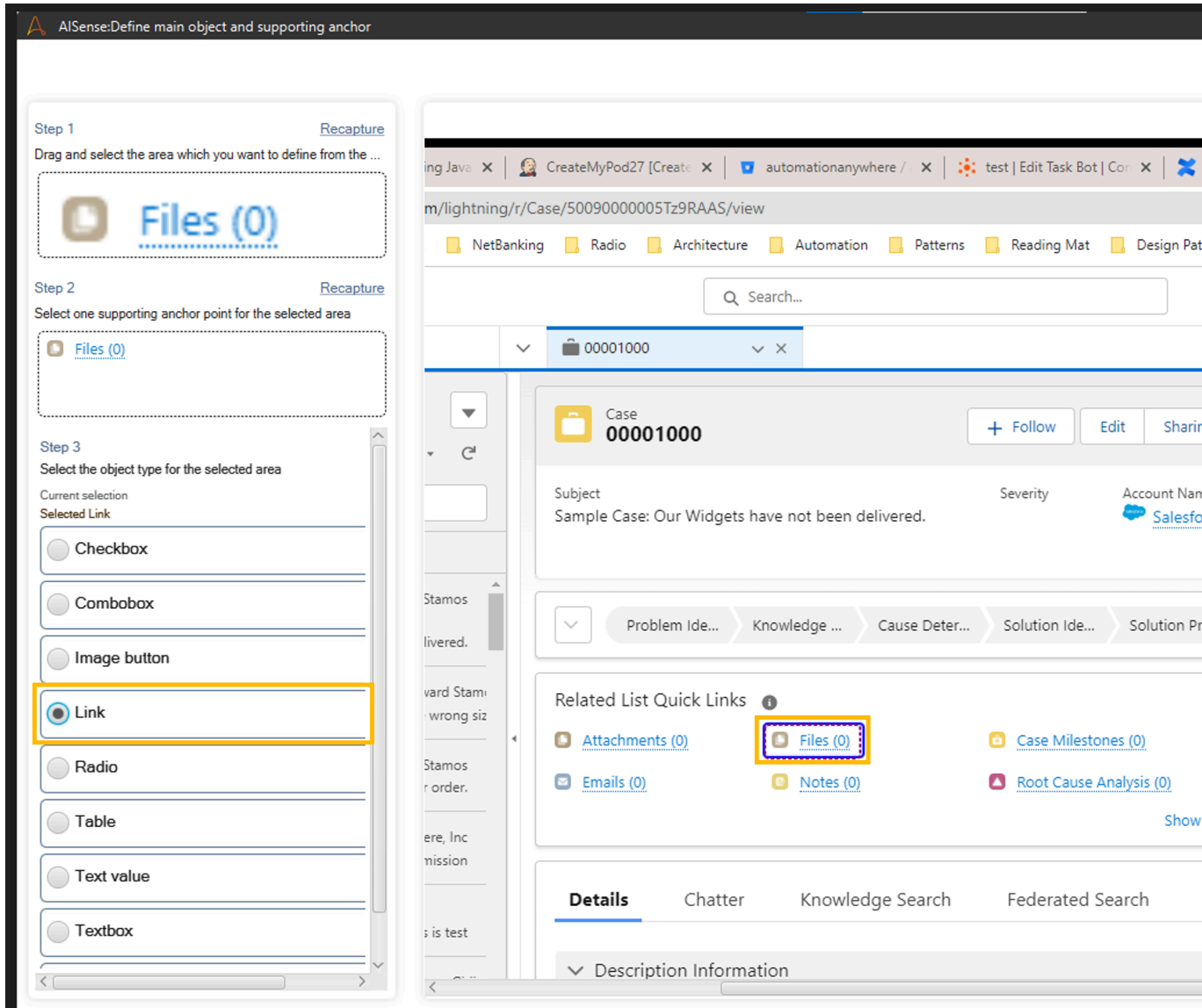

9. Draw a rectangle around the link button that you want to capture.

The selected area is shown in the box below the **Drag and select the area which you want to define from the image** field.

10. Hover the mouse cursor over the text. Once the text is highlighted, select the link text as the supporting anchor.

The image of the anchor is shown in the box below the **Select one supporting anchor point for the selected area** field.

11. Click **Define**.

12. After you have captured the required objects, click **Finish**.

Capture text value through AISense Recorder

Passive texts are texts that are readable only. To make decisions, bots might require extracting texts, for example, key-value pair or text value from a form. If the AISense Recorder cannot detect the texts automatically, then you must use the **Define** option to detect the texts.

Capture the text value

1. On the left pane, click **Automation**.
2. To create a bot, click **Create new > Bot** or open a bot for which you want to record a task.
3. Click **Start recording**.
The Recorder bot runtime window appears.
4. Select a window from the drop-down list.
If you opened an application recently and it is not available in the list, click the **Refresh** icon.
5. Click **AISense Recorder** and allow the scanning process to finish.



Note: The AISense Recorder downloads the required dependent files the first time you use it on a device.

The AISense Recorder toolbar appears with these options: **Finish**, **Scan**, **Define**, and **Pause**.

The AISense Recorder analyzes the selected application window to identify the UI objects in that window. When the system is analyzing the application window, the options on the toolbar are unavailable. After the analysis completes, the options are enabled and you can start recording the task.

6. Wait for the AISense Recorder to detect the object.
7. If the object is not detected automatically, then when the AISense Recorder reaches the **Ready** state, you can click the **Define** button to detect the object.

Note:

- In the **Define** window, the  shows embedded help for each control type so you can select the correct control types for custom objects.
- If you unintentionally click the screen or click before the highlighter appears,  provides visibility into it. You must confirm to capture the object again, or use the **Define** functionality to define the object on the screen.

-
8. Select **Text value** from the **Select the object type for the selected area** tab.
 9. Draw a rectangle around the text area that you want to extract.
The selected area is shown in the box below the **Drag and select the area which you want to define from the image** field.
 10. Hover the mouse cursor over the nearby static text. Once the text is highlighted, select the static text as the supporting anchor.
The image of the anchor is shown in the box below the **Select one supporting anchor point for the selected area** field.
 11. Click **Define**.
 12. After you have captured the required objects, click **Finish**.

Known behavior

AISense Recorder cannot extract texts with multiple lines. If you select multiple lines, only the first line is extracted.

Capture Textbox, Radio, Checkbox, and Combobox

When a screen is dense, sometimes the AISense Recorder cannot detect and classify the controls correctly. To continue to automate the controls seamlessly, you can use the AISense Recorder to capture coordinates of controls and perform certain actions without having to use the Mouse and Simulate keystrokes packages separately.

Textbox, Radio, Checkbox, and Combobox

Note: Any textbox, radio, checkbox, and combobox controls captured using **Define** functionality will be coordinate based automation. This functionality is provided for continuity of workflow.

1. On the left pane, click **Automation**.
2. To create a bot, click **Create new > Bot** or open a bot for which you want to record a task.
3. Click **Start recording**.

The Recorder bot runtime window appears.

4. Select a window from the drop-down list.
If you opened an application recently and it is not available in the list, click the **Refresh** icon.
5. Click **AISense Recorder** and allow the scanning process to finish.

Note: The AISense Recorder downloads the required dependent files the first time you use it on a device.

The AISense Recorder toolbar appears with these options: **Finish**, **Scan**, **Define**, and **Pause**.

The AISense Recorder analyzes the selected application window to identify the UI objects in that window. When the system is analyzing the application window, the options on the toolbar are unavailable. After the analysis completes, the options are enabled and you can start recording the task.

6. Wait for the AISense Recorder to detect the object.
7. If the object is not detected automatically, then when the AISense Recorder reaches the **Ready** state, you can click the **Define** button to detect the object.

Note:

- In the **Define** window, the shows embedded help for each control type so you can select the correct control types for custom objects.
- If you unintentionally click the screen or click before the highlighter appears, provides visibility into it. You must confirm to capture the object again, or use the **Define** functionality to define the object on the screen.

-
8. Select the specific object type from the list of object types from the **Select the object type for the selected area** tab.

The object types that you select is shown under **Current selection**.

9. Draw a rectangle around the control that you want to capture.

The selected area is shown in the box below the **Drag and select the area which you want to define from the image** field.

10. Hover the mouse cursor over the text. Once the text is highlighted, select and define the text as the supporting anchor for identification.

The image of the anchor is shown in the box below the **Select one supporting anchor point for the selected area** field.

11. Click **Define**.
12. After you have captured the required objects, click **Finish**.

Table data extraction through AISense Recorder

Tables are a complex control, with many types, backgrounds, and formatting effects, and hence might not be automatically detected by AISense Recorder in some cases. In such cases, use the **Define** option to detect tables.

Capture a table using AISense Recorder

1. On the left pane, click **Automation**.
2. To create a bot, click **Create new > Bot** or open a bot for which you want to record a task.
3. Click **Start recording**.

The Recorder bot runtime window appears.

4. Select a window from the drop-down list.
If you opened an application recently and it is not available in the list, click the **Refresh** icon.
5. Click **AISense Recorder**. Let the scanning process finish.

Note: The first time you use AISense Recorder on a device, the Recorder downloads the required dependent files.

The Recorder toolbar appears with the following options: **Finish, Scan, Define, and Pause**

The Recorder analyzes the application window that you selected to identify the UI objects in that window. The options on the toolbar are unavailable when the system is analyzing the application window. After the analysis, the options are enabled and you can start recording the task.

6. Wait for AISense Recorder to detect the table in the application.
7. If the table is not detected automatically, then when AISense Recorder is in the **Ready** state, click the **Define** button to detect the table.

Note:

- In the **Define** window, the shows embedded help for each control type so you can select the correct control types for custom objects.
 - If you unintentionally click the screen or click before the highlighter appears, provides visibility into it. You must confirm to capture the object again, or use the **Define** functionality to define the object on the screen.
-

8. Select **Table** from the **Object type** tab and click the top-left header.

The detected table will be highlighted with columns and internal controls.

The screenshot shows the AI Sense interface with three steps for defining a table:

- Step 1:** Drag and select the area which you want to define from the ... (A table is selected in the background).
- Step 2:** Select one supporting anchor point for the selected area. The selected area contains the text: "Report Name|Description|Folder|Created By|Created On".
- Step 3:** Select the object type for the selected area. The "Table" option is selected and highlighted with a yellow border.

The right side of the interface shows the "Table definition" panel for the selected table:

Report Name	Description	Folder
"KeyBank GOLD" LOB Change		Public Reports
"Undefnd" ENT/COMM_Marketing		Public Reports
# AALitmos_PBI_Partner Portal Report		Public Reports
# Advance Certificates - APJ		Public Reports
# Badges - APJ		Public Reports
# Certifications & Badges		Public Reports
# Contacts by Accounts		Public Reports
# Contacts by Accounts and Territories		Public Reports
# Contacts by Accounts and Territory		Public Reports
# Contacts by Accounts_Aviso		Public Reports
# IMEA-Backlog Now and Last Update		Public Reports
# IMEA-Backlog Now and Last Update - ART		Public Reports
# IMEA: Initial SLA		Public Reports
# IMEA:Comm Update SLA-Khalid		Public Reports

At the bottom of the interface, there is a navigation bar with icons for Omni-Channel (Offline), Macros, Chatter Feed, Recent Items, and History.

- If you want to select a limited set of columns, then draw a rectangle around the columns that you want to capture.

AI Sense: Define main object and supporting anchor

Step 1 [Recapture](#)
Drag and select the area which you want to define from the ...

As table value has been selected, no supporting anchor...
Not a table?

Step 2 [Recapture](#)
Select one supporting anchor point for the selected area
Report Name|Description|Folder

Step 3
Select the object type for the selected area
Current selection
Selected Table

- Checkbox
- Combobox
- Image button
- Link
- Radio
- Table
- Text value

Table definition

Customer Support Reports

Reports
Public Reports
27258 items

REPORTS	Report Name	Description	Folder
Recent	"KeyBank GOLD" LOB Change		Public
Created by Me	"Undefnd" ENT/COMM_Marketing		Public
Private Reports	# AALitmos_PBI_Partner Portal Report		Public
Public Reports	# Advance Certificates - APJ		Public
	# Badges - APJ		Public
	# Certifications & Badges		Public
	# Contacts by Accounts		Public
	# Contacts by Accounts and Territories		Public
	# Contacts by Accounts and Territory		Public
	# Contacts by Accounts_Aviso		Public
	# IMEA-Backlog Now and Last Update		Public
	# IMEA-Backlog Now and Last Update - ART		Public
	# IMEA: Initial SLA		Public
	# IMEA:Comm Update SLA-Khalid		Public

Federated Search Omni-Channel (Offline) Macros Chatter Feed Recent Items

Extract data from a table

- After the object is captured, click **Finish** to end the recording.
- Return to the Control Room.
- In the **Object properties** table, verify that the **Control Type** is TABLE. If it is not, click **Recapture object**.
- From the **Action to take on object** drop-down list, select **Get table**.
- In the **Save the outcome to a variable** field, create the `CapturedTableData` variable.
- Double-click or drag the **Data Table > Write to file** action.
- From the **Data table name** list, select `CapturedTableData`.

8. Provide a filepath to create a CSV file. For example, `C:\AutomationAnywhere\Development\SFDC.csv`
9. Select the **Create folders/files if it doesn't exist** option.
10. Select to overwrite the existing file.
11. Click **Save**.
12. Click **Run**.

The bot creates a CSV file in the specified path with the table data extracted.

Correct a column definition

It is possible that dense tables can merge columns due to less space between columns or lack of clear separators. To correct the column definition, perform the following steps:

1. After the object is captured, click **Finish** to end the recording.
2. On the Bot editor window, go to **Object properties** to edit the **Anchor Table** property.

3. Add the pipe character (|) as a delimiter between the column names to separate them. For example, <CHECKBOX>Name|Company|State|Email|Lead status

Note: When the bot is run, previously merged columns will be treated as separate columns.

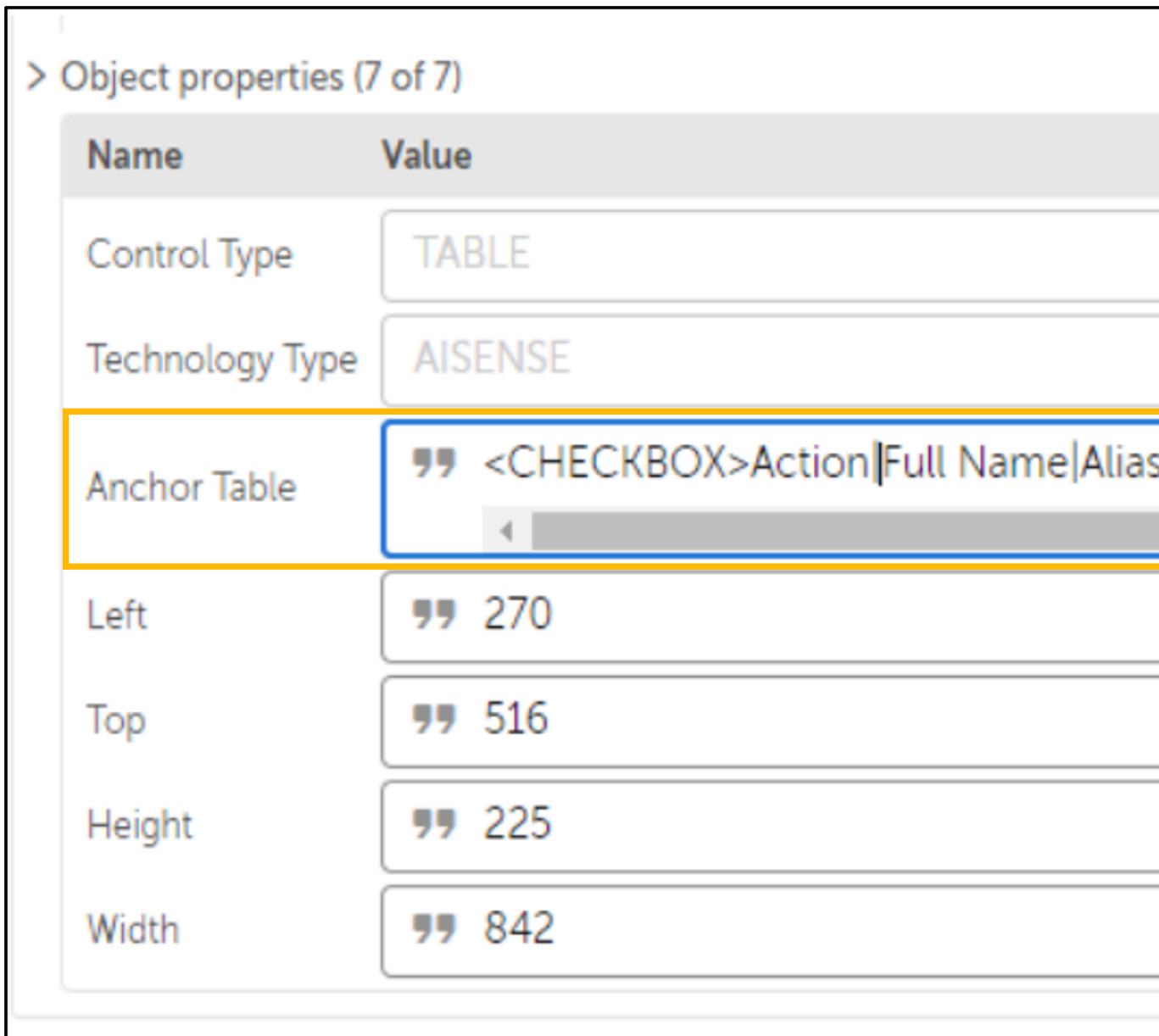

Known behavior

- AISense Recorder cannot extract tables with multiple lines in single rows or cells.
- Pagination and autoscrolling are not supported.
- Truncated columns will not be automatically adjusted to extract truncated cell text.

Use variable anchor

You can use the variable anchor to automate same controls that have different anchors. For example, pages having multiple checkboxes with different captions. These captions might be dynamic and might change based on the workflow. You can use the variable anchor to capture the control once, and then use the anchor as a variable in the Bot editor window. You can use a variable from various sources, for example, Microsoft Excel, CSV, or database.

Capture using variable anchor

1. On the left pane, click **Automation**.
2. To create a bot, click **Create new > Bot** or open a bot for which you want to record a task.
3. Click **Start recording**.
The Recorder bot runtime window appears.
4. Select a window from the drop-down list.
If you opened an application recently and it is not available in the list, click the **Refresh** icon.
5. Click **AISense Recorder** and allow the scanning process to finish.

Note: The AISense Recorder downloads the required dependent files the first time you use it on a device.

The AISense Recorder toolbar appears with these options: **Finish, Scan, Define, and Pause**.

The AISense Recorder analyzes the selected application window to identify the UI objects in that window. When the system is analyzing the application window, the options on the toolbar are unavailable. After the analysis completes, the options are enabled and you can start recording the task.

6. Wait for the AISense Recorder to detect the object.
7. If the object is not detected automatically, then when the AISense Recorder reaches the **Ready** state, you can click the **Define** button to detect the object.

Note:

- In the **Define** window, the shows embedded help for each control type so you can select the correct control types for custom objects.
 - If you unintentionally click the screen or click before the highlighter appears, provides visibility into it. You must confirm to capture the object again, or use the **Define** functionality to define the object on the screen.
-

8. Select **Variable anchor** from the **Select the object type for the selected area** tab.

The screenshot displays the AI Sense interface for defining a main object and supporting anchor. On the left, a sidebar shows two steps: Step 1 (dragging a selection area) and Step 2 (selecting an anchor point). Below these steps is a list of object types: Checkbox, Combobox, Image button, Link, Radio, Table, Text value, Textbox, and Variable anchor. The 'Variable anchor' option is selected and highlighted with a yellow border. On the right, a browser window shows a Salesforce case list. The case number '00001002' is highlighted with a red rectangle. The case details on the right show the subject 'Sample Case: Our Widgets have not b...' and related links for Attachments, Emails, and Files.

9. Draw a rectangle around the checkbox that you want to capture.

The selected area is shown in the box below the **Drag and select the area which you want to define from the image** field.

Note: Hover the mouse over the checkbox and ensure that the checkbox is detected and highlighted with red rectangle before you click **Define**.

10. Hover the mouse over the closest static text. Once the text is highlighted, select the text as the supporting anchor.

The image of the anchor is shown in the box below the **Select one supporting anchor point for the selected area** field.

11. Click **Define**.

12. After you have captured the required objects, click **Finish**.

The recorded steps appear as a separate action in the bot.

For each variable anchor action, you can copy the added action and update the value in the **Anchor** field with the anchor text of the object you want to capture, for each variable anchor action.

Alternatively, you can use the action within the Loop action and use a variable that supports the String data type in the **Anchor** field.

> Object properties (7 of 7)

Name	Value
Control Type	VARIABLE_ANCH
Technology Type	AISENSE
Anchor	” \$AnchorInput
Left	” 47
Top	” 275
Height	” 21
Width	” 21

Keep trying for (seconds)

Note:

- You can assign only highlighted controls to a variable.
 - Ensure no additional control or text exists between the anchor and the control.
-

Enable debug logs for AISense Recorder

You can use debug logs to troubleshoot the application window that you capture and to verify if the object is being detected correctly. The results are available as debug images in the %temp%\AISenseLogs folder.

1. On your local device, browse to C:\Program Files\Automation Anywhere\Bot Agent\config.
2. Open the botlauncher-logging.xml file.
3. Include the following logger entry within the <Loggers> XML element and save the XML file:
<Logger name="com.automationanywhere.recorder" level="DEBUG"/>
For example, add the debug logger entry below the existing logger entry.

```
<Logger name="com.automationanywhere.recorder" level="INFO"/>  
<Logger name="com.automationanywhere.recorder" level="DEBUG"/>
```

Changes you make to the logging configuration file are updated in seconds configured per the monitor interval value.

Note: If the changes are not automatically applied per the monitor interval value, restart the Bot Agent service.

AISense Recorder best practices

To use the AISense Recorder optimally, review the best practices.

Configuring registered devices

- Ensure you use only recommended hardware configuration for registered device as specified. See [Automation 360 Bot Runner device requirements](#)
- If application is running on same device, we recommend you to add additional CPU or RAM to avoid slowness. See [Automation 360 Bot Runner device requirements](#)
- If you are automating a task using a browser, ensure that auto-fill is disabled for that browser.
- Ensure that the screen resolution is set to 1980x1080 or lower. See [Record a task with AISense Recorder](#)
- Configure the device display settings to 100% DPI. See [Record a task with AISense Recorder](#)

Behavior

- When you use the AISense Recorder for the first time on any device, either for recording or for playback, it downloads the required resources from the Control Room. This process might take a few or several minutes depending on the speed of your internet. The state of the process is indicated in the progress bar during recording and the Bot runtime window shows **Downloading additional resources**.
- When you use a new package in a bot and if the package has any updated resources, it gets downloaded automatically that results in a delay in bot execution.
- There is a delay in scanning or bot execution in the following cases:

- The first execution will setup AISense environment which will take couple of seconds (based on machine configuration). User will observe some delay in scanning and bot execution.
- Every time application changes, due to navigation or new controls loaded, AISense has to detect new available controls on the application screen, which will take couple of seconds (based on machine configuration). User will observe some delay in scanning and bot execution.
- Parent and child bot execution: If child bot is using AISense Recorder, every time the child bot is executed, an AISense environment gets created to maintain isolation between bots. User will observe some delay in bot execution.

Methodology

- Record the task at low speed. Click only after the red highlighter appears around the object.
- Avoid dragging the windows during the recording process.
- If AISense Recorder is downloading required resources from the Control Room in case it is deployed for the first time, do not close the Recorder window in between since doing so might corrupt the required resource files.
- When the AISense Recorder is in **Scanning** state, avoid switching between applications.
- When the AISense Recorder is in **Ready** state, move the mouse slowly over the object or control that you want to capture and make sure that it gets highlighted with the red rectangle and then click on it.

Capturing Combo box

The following are some best practises that you can follow when you use the AISense Recorder to capture combo boxes. Below are some of the combo boxes based on the application requirements.

- **Searchable combo box:** The searchable combo box enables you to click in the text area and type. It then starts filtering the typed text from the list and allows you to press enter when a single result is available.
 - To automate this combo box control, during recording, highlight the combo box and click in the center of the combo box. The default action selected will be **Select Item by Text**. Finish the recording.
 - Go back to control room bot editor. Enter the text value along with Enter or combination of Down (down arrow) and Enter to simulate user like action. For example, if you are automating a searchable combo box which has a dropdown list item, then you can either enter the value in the searchable combo box and click Enter to select it or use the down arrow to search for the specific value and click Enter to select that value from the list.

- **Legacy combo box:** The legacy combo box does not have a search functionality and it is mandatory to expand it by clicking triangular button on right side of combo box and select one of the value.
- To automate this combo box control, during recording, highlight the combo box, it should also highlight the small triangular button on right side.

Note: Ensure that it also highlights the small triangular button on the right side.

- Click the button and wait.

The Recorder must take sometime to identify expanded value. During this time, the recording icon in the Recorder window must be in the blinking state.

- As soon as the small recording icon stops blinking, hover the mouse over the list box (expanded combo box) and make sure it highlights list values.
- Select the specific values.
- User can select any value and later change it from the Bot editor window in the Automation Anywhere Control Room.

Using AISense Recorder with other Packages

AISense Recorder is computer vision based object detection method of automating where it captures the image of the application that you want to automate. When you use AISense Recorder to automate applications that have objects like textbox with single underline or combobox without triangular button, the objects might not get detected. In such cases, we recommend you use a combination of AISense Recorder with other packages like OCR and Image Recognition packages or only OCR and Image Recognition packages to automate such use cases.

Client Control

AISense Recorder detects object on the application with specific feature set. When you click an area where there is no control, or click a control before it highlights with red boundaries, it will be recorded as **CLIENT** control. The client control is coordinate based capture of mouse click to replicate user click and is not standard AISense control. We recommend user to recapture control if captured as **CLIENT** control.

Working with bots

Depending on the license and permission assigned to you, you can perform various bot operations and access the private and public workspaces in the Control Room.

Licenses

Two types of licenses are available: Bot Creator and Bot Runner (attended or unattended) licenses.

[Automation 360 licenses](#)

Bot Creator tasks

A Bot Creator user can access both the private workspace and public workspace in the Control Room by navigating to **Automation** on the left panel. The license provides the user exclusive access to the registered device. Other users cannot use the default device of a Bot Creator.

With the Bot Creator license and specific permissions, you can perform the following tasks:

- [Create a bot](#)
- [Run a bot](#)
- [Record a bot](#)
- [Record a task with the Universal Recorder](#) | [Record a task with AISense Recorder](#)
- [Schedule a bot](#)
- [Copy a bot](#)
- [Assign label to a bot](#)
- [View bot version history](#)
- [Export a bot](#)
- [Import a bot](#)
- [Check in a bot](#)
- [Check out a single bot](#)
- [Delete a bot](#)

You can also edit, analyze, save, clone, view content, pause, or stop a TaskBot.

Bot Runner tasks

A Bot Runner can access only to the public workspace in the Control Room. They cannot create or edit bots.

With the Bot Runner license and specific permissions, you can perform the following tasks:

- [Run a bot](#)
- [Schedule a bot](#)
- [Assign label to a bot](#)

You can also view the content of a TaskBot.

Public and private workspaces

The Automation page lists all the folders and bots available within the selected folder in the **Public** and **Private** repositories. If you have migrated the Enterprise 11 or Enterprise 10 data to Automation 360, the Automation page additionally displays the Enterprise 11 or Enterprise 10 TaskBots (.atmx) and MetaBots (.mbot) files in the public repository.

When an Enterprise 11 or Enterprise 10 bot is migrated and converted to the Automation 360 bot, the **My Tasks** and the **My Metabots** folders display the migrated (Enterprise 11 or Enterprise 10) and the converted bots with the same name but different extension. This might create confusion to differentiate between the two bots. Also, you cannot take any actions on the migrated bots except deleting them. To avoid this confusion, you can use the **Show** menu option to show or hide the Enterprise 11 or Enterprise 10 bots.

The Show menu displays three options - **Folder**, **.ATMX Task Bot**, and **.MBOT Meta Bot**. By default, each of these options are selected and displays all the folders and sub folders along with the Enterprise 11 or Enterprise 10 bot files.

If you clear the selected **Folder** option, then the sub-folders will be hidden from the files and folders list and will only display .atmx or .mbot files and when you clear the selected. **.ATMX Task Bot** or the **.MBOT Meta Bot** options, the .atmx or .mbot files, will then be hidden across all the folders.

Depending on the license, users logging in to the Control Room can access the private and public workspaces.

Private workspace

Users with the Bot Creator license can access the private workspace. This workspace is primarily used to create and test bots. It enables users to view and manage all their activities in one primary location. Bots in the private workspace is available only to the users who created them.

Note:

- Users with administrative privileges and Bot Runner license cannot access the private workspace because they cannot create bots.
- The bot name must be unique. If a bot or a folder with the same name exists in the same folder location which you have access to in the public workspace, you cannot either create, check out, or rename the bot with this name in the private workspace.

Public workspace

Both Bot Creator and Bot Runner users can access the public workspace. This is a shared workspace where you can execute the bots.

Users with the Bot Runner license can run bots created by the Bot Creator user. Bots created in the private workspace by Bot Creators can be made available to specific Bot Runner users in the public workspace by defining the permissions at the folder or file level. To do this, users have to first check in the bot from the private workspace to the public workspace.

Note:

- When you create a TaskBot with dependencies, ensure that both the parent and child bot are in the same workspace (public or private). You cannot call a public bot from a private bot. To call a bot from the public workspace, you should first check-out or clone the public bot into the private workspace, include it as a child bot inside the private bot, and check-in both the bots.
- Folder names in private and public workspaces are case-sensitive. You can create a folder with the same name and matching case in private and public workspaces. However, you cannot create folders with the same name but with different case in the workspaces. For example, you can create a folder **My Metabots** in both private and public workspace. However, you cannot create folder names that use the same name but with different case, such as **My Metabots** in the private workspace and **My MetaBots** in the public workspace.
- Sorting and filtering are supported for substrings. For example, if you want to search for bots or files that have `fin` in the file or bot name, enter `fin` as the search criterion. All the bots and files that contain `fin` in the names will be displayed, for example, Finance, Finder, DeltaFinance, and Dolfin.

Wildcards are not supported for searching and filtering bots or files.

Run a bot

You can run a bot to test an automated process.

1. Log in to the Control Room.
2. On the left pane in the public workspace, click **Automation**.
A list of available bots and forms is displayed.
3. Select the bot to run. Hover over the actions menu (vertical ellipses) located to the right of the bot name and click **Run Task Bot**.

If an optional Bot Agent update for your device is available, the following message that Bot Agent has an update is displayed one time per user session or when you log out and log in to the Control Room.

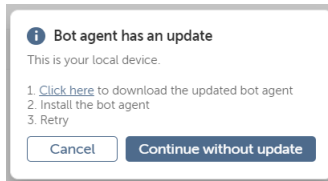

- To download and update the Bot Agent to the latest version on your device, use the **Click here** link.
 - To opt out of the update and continue with the existing Bot Agent version on your device, click **Continue without update**.
4. Select the version of the bot to run.
 - Latest version: To select the latest version of the bot, click the **Latest version** tab.
 - Labeled version: To select the labeled version of the bot, click the **Production version** tab.

By default, the latest version of the bot is selected. If the production label option is selected for the parent bot, the corresponding dependent bots with the production label are also automatically selected. If any of the dependent bots do not have the production label applied, the latest version of the bot is selected.

5. Click the right arrow (→) to add your selection.
6. Select the Bot Runner users from the list of **Available bot runners** in the **Run as** tab.
The list of Bot Runner users that you have access to are displayed.
7. Click the right arrow (→) to add your selection.
8. Select the pool from the list of **Available device pools** in the **Device pools** tab.
The list of device pools for which you have a consumer role are displayed. Select the device pool only if any of the selected Bot Runner users do not have a bot running (default) device.
9. Click the right arrow (→) to add your selection.
10. Optional: Select the **Automation priority** from the **General** tab.
Set the priority to high, medium, or low based on your requirements for resource optimization. The default permission is set to medium.
11. Click **Run bot now**.

Note: If you have not set the device credentials from the **My settings** page, you are prompted to provide the device credentials to run the bot.

If you encounter issues in running a bot, refer to the following articles:

- [Automation 360 - Unable to download the bot or the dependencies to the device; Error code: download.error \(A-People login required\)](#).

- *There is already an existing deployment in-progress for this user session (A-People login required).*

Considerations for running a bot

There are certain considerations you have to keep in mind when running a bot.

- As a Bot Creator, you can deploy a bot on your device or you can run the bot on a remote machine through RDP connection.
- If you are running bots on your local machine as a Bot Creator, enter only your username in the device login credentials; no password is required. The username is required to confirm that the same user who logged in to the local device is deploying the bot. If you are using the Google Chrome plug-in and running bots on your local machine, your username is required.
- As a Bot Runner, you can either deploy the bot yourself or select a run-as user assigned by the administrator. You can run the bot either through your device or choose from the list of devices in a device pool. If you choose to override the default device, the bot will be executed on any available device in the device pool for each run-as user.
- You can preload packages on your local device to shorten the bot runtime.

The system supports running only one bot for each device at a given time. If a bot is already running on the device, you cannot deploy another bot on the device.

While a bot is running on a device, if you try to deploy another bot on the same device, the second bot is queued according to its type. After the deployment of the currently running bot is complete, the queued bot is automatically deployed on the same device.

- If you are running a bot from the Bot editor, closing the Control Room web browser will stop the bot run.
- Run-as user: A set of unattended Bot Runner users that a scheduler can select from to run a bot on a device. The run-as user can select an available device from the device pool to run the bot.
- When bots are queued for a Bot Runner user, bots with higher priority are deployed before bots with lower priority. However, if a bot with lower priority is already running, bots with higher priority are deployed after the bot with lower priority completes running.
- When you create the bot deployment using the **Run bot now** option, the bot is queued for execution. If the bot is deleted while it is queued for execution or while it is active, an error is displayed for that bot in the **In progress activity > View activity** page.
- Attended Bot Runner, Bot Creator, and Citizen Developer users can run the bots using either the **Run bot now** option in the Bot editor or the shortcut key F5. However, unattended Bot Runner users can run their bots only using the **Run bot now** option.

The following table explains the different scenarios where you should choose device pools against bot running devices for the run-as user.

Option	Scenario	Device pool	Default device	Result
Run bot now	Information security compliance where the user cannot log in to any other device	No	Yes	Bot deploys on the default device of the user.
	Specialized application access restricted to a user	No	Yes	Bot deploys on the default device of the user.
Schedule bot	Override bot running device option is selected	Yes	Yes	Bot deploys on the available device in the device pool.

Option	Scenario	Device pool	Default device	Result
	Override bot running device option is not selected	Yes	Yes	Bot deploys on the default device of the user. If default device is not available, the bot deploys on the available device in the device pool.
	Information security compliance where the user cannot log in to any other device	No	Yes	Bot deploys on the default device of the user.
	Specialized application access restricted to a user	No	Yes	Bot deploys on the default device of the user.
WLM (Run bot with queue)	Run on bot running devices option is selected	Yes	Yes	Bot deploys on the default device of the user.
	Run on bot running devices option is not selected	Yes	Yes	Bot deploys on the default device of the user. If default device is not available, the bot deploys on the available device in the device pool.
AARI on the web	Run-as user with device pool assigned	Yes	No	Bot deploys on the available device in the device pool.

Related tasks

[Add queue, Bot Runner, and device pool](#)

Add a queue, Bot Runner, and device pool to the automation from the **Run bot with queue** page.

Move a bot

As a Bot Creator, you can now move your bots and files from one folder to another with ease in the private workspace. If a bot is placed in an incorrect folder, you no longer have to clone it in the correct folder and then delete it from the incorrect folder.

When you are moving a bot, keep the following considerations in mind:

- You can move only bots and files. You cannot move folders.
- You can move only newly created bots and files. Checked-out, edited, and cloned bots cannot be moved.

1. Log in to the Control Room as a Bot Creator user.
2. Select the bot or file to move. Hover over the actions menu (vertical ellipsis) located to the right of the bot or file name and click **Move Task Bot**.
3. Browse and select the folder to which you want to move the bot and click **Choose**. The bot is copied to the destination folder and removed from the source folder.

Note: When the bot is moved, you will see a warning message to change the reference in all the parent bots.

Check in a bot

Check in the bot files or folders to the public workspace from private workspace to make it available for all users who have the permission to access and run the bot.

- You must have Bot Creator or Citizen Developer license to check in a bot to the public workspace.
- You must be assigned a custom role with the following permissions:
 - Required: Check in permission at the folder level and at the corresponding parent folder level in the public workspace.
 - Optional: Create folder permission.
 - Optional: View packages permission.
- To check in a bot with dependent folders and files, ensure you have the following:
 - Create folder permission.

If you are checking in a bot from your private workspace and if the folder in which the bot is present does not yet exist in the public workspace, you must have create folder permission to successfully check in the bot.
 - Check in permission on the dependency folder.
- Ensure that your private and public workspaces have the same folder structure so that when you check in a bot from your private workspace, it will appear in the same folder structure in the public workspace.
- For example, if you check in a bot from the sample bot folder in the private workspace, it will appear in the sample bot folder in the public workspace.

If you want to check in multiple bots as a unit that are not dependent on each other, create a main bot and then add the other bots as dependencies to this main bot. Check in the main bot.

- 1.** Log in to the Control Room as a Bot Creator or a Citizen Developer user.
- 2.** On the left pane, click **Automation**.

A list of available and forms is displayed.

3. You can choose to check in either one bot or multiple bots simultaneously.
 - Select the bot that you want to check in, click the actions menu (vertical ellipsis), and click **Check in Task Bot**.
 - Select the bots that you want to check in and click **Check in checked items**.

Note: You can check in up to 10 bots at a time.

The screenshot shows the Automation Anywhere interface. On the left is a dark sidebar with the logo 'AUTOMATION ANYWHERE Automation 360' and navigation options: Home, Automation, Activity, and Manage. The main area is titled 'Automation' and has tabs for 'Public', 'Private', and 'Bot Store'. Below the tabs, a message states: 'Private bots and files cannot be viewed by other people. If a bot or file has been checked out from the Public tab, it can be viewed and run by other people, but cannot be edited.' A 'Folders' pane on the left shows a tree structure: 'Bots' (expanded) containing 'Document Workspace Pr...', 'IQ Bot Processes', 'My Tasks', 'Sample bots', 'Srilatha' (expanded) containing 'AARI process' (expanded) containing 'bulk ch...' (selected), 'rollback dependencies', 'Version control depend...', 'TaskBotExample', and 'Bot Store'. The right pane shows a table of 'Files and folders (5) (5 checked)'. The table has columns for 'Type', 'Name', and 'Status'. All items are checked and have a status of 'New'.

Type	Name	Status
Task Bot	bulk_chkin1	New
Task Bot	bulk_chkin2	New
Task Bot	bulk_chkin3	New
Task Bot	bulk_chkin4	New
Task Bot	sss	New

4. In the **Check in Task Bot** window, add your comment and select the dependencies you want to check in and click **Check in checked items**.
The bot appears in the same folder structure in the public workspace. Directly referenced dependencies are automatically checked in.

Note:

- You cannot check in a bot file if another bot file already exists in the same location in the public workspace.
 - When you check in a bot along with a cloned bot and no other bots are dependent on the clone, the cloned bot is deleted.
-

If you have issues in checking in a bot, see [Unable to check-in the bots in Automation 360 \(A-People login required\)](#).

Checking out bot and dependencies

The check out process enables you to create an editable copy of the bot in the private workspace from the public workspace for further modification.

After you have modified the bot, you can check in the bot again to the public workspace so that it can be deployed by all users who have permission to access it. You can choose the specific version of the bot and its dependencies (bot and non-bot) during the check-out process.

You can cancel the checked-out bot from your private workspace whereas an administrator can cancel the checked-out bot from the public workspace. This releases the bot for another user who has access in the public workspace. When you cancel check out, the bot status changes to **Public** in the public workspace. In the private workspace, the status changes to **New** if any edits are made to the bot. If there are no changes, the bot is replaced with a clone.

Guidelines for checking out bots

While checking out bot, keep the following considerations in mind:

- If you want to check out multiple bots as a unit that are not dependent on each other, create a main bot and then add the other bots as dependencies to this main bot. Check out the main bot.
- Only one user can check out a bot at a time. When a user checks out a bot, it cannot be checked out by any other user.
- If you are checking out a parent bot in the public workspace whose dependencies are checked out by another user, the dependencies of the parent bot will be cloned in your private workspace.
- If a bot is checked out, it cannot be deleted. The bot should be in a checked-in (**Public**) state to be deleted.
- When you edit a checked-out bot, the status changes to **Checked out edited**.

You can use the **Revert edits** option to revert changes you made to the checked-out bot.

- During check out, a cloned bot can be overwritten or replaced.
- The dependent files are automatically cloned if they are checked out by another user and you have the **Clone** permission on the bot folder.

Prerequisites for checking out bots and dependencies

- You must have Bot Creator or Citizen Developer license to check out a bot to your private workspace.
- You must have check out permission at the folder level.
- You must have the check out permission on the dependency folders to check out a bot with dependent folders and files.
- You must have the **Cancel checkout** and **View content** permissions on a public workspace to cancel or undo a check out performed by a Bot Creator user,

You do not require the **Cancel checkout** permission to cancel the checked out bot from a private workspace.

Checking out bots

You can check out single or multiple bots along with their dependencies. You can also choose the version of the bot and their dependencies during the check out.

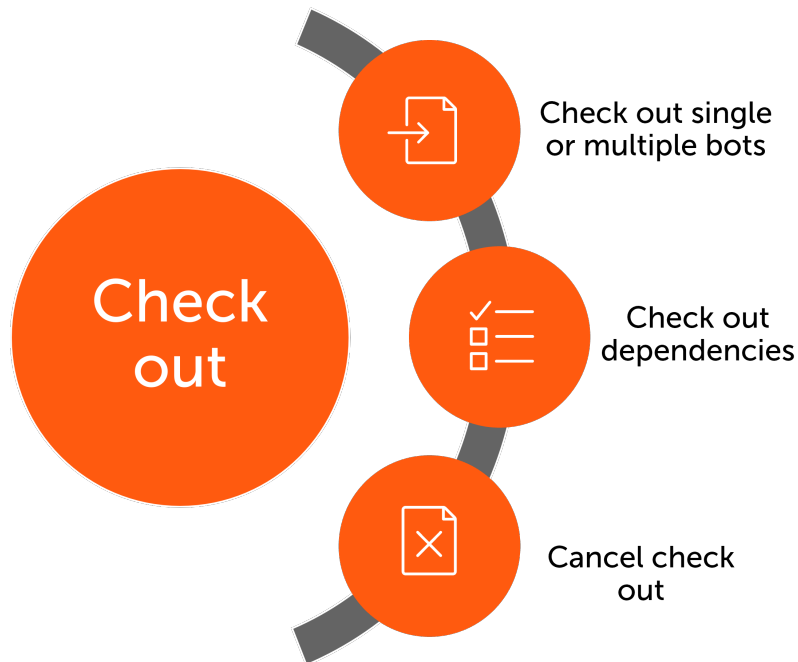

- *Check out a single bot*
- *Check out multiple bots*
- *Check out file dependencies*

Check out a single bot

Check out the specific version of a parent bot and its dependencies from the public workspace to the private workspace to create an editable copy of the bot.

Prerequisites for checking out bot and dependencies

1. Log in to the Control Room as a Bot Creator or a Citizen Developer user.
2. On the left pane, click **Automation**.
A list of available and forms is displayed.
3. Select the bot, choose to either clone or check out the dependencies, open the actions menu (vertical ellipsis) and click **Check out Task Bot**.

Note: If a bot has multiple versions, you can select and check out the specific version of the bot using **Advanced options**. This enables you to roll back to an earlier version of the bot.

Option	Steps
Yes, Checkout	Select this option to check out the latest version of a bot. The dependencies are cloned automatically.

Option	Steps
Advanced options	Select this option to select a specific version of the parent bot and dependencies. <ol style="list-style-type: none"> a. Click Advanced options. b. Select the version of the parent bot to check out. c. Add or remove dependencies to check out. d. Select the version of the dependency (bot or non-bot) to check out. e. Review the dependencies (Overwritten, Missing, Cloned, Skipped). f. Click Check out.

The bot appears in the same folder structure in the private workspace. When you check out bot files or folders, all the dependencies linked to the bot files or folders will either be checked out or cloned according to your choice.

4. To cancel the checked-out bot, click the **Cancel check out Task Bot** option.

You can use this option from either the public or the private workspace.

In the public workspace, the bot status changes to public, and the bot is available for check out by another user with the appropriate permissions.

In the private workspace, the bot status changes to new if any changes are made to the bot. If there are no changes, the bot is replaced with a clone.

Check out multiple bots

Check out the specific versions of the parent bots and its dependencies from the public workspace to the private workspace to create an editable copy of the bot.

Ensure you have completed all the prerequisites for checking out bots:

- [Prerequisites for checking out bot and dependencies](#)
- Check out up to 10 parent bots at a time
- Check out only the latest version of the bot

1. Log in to the Control Room as a Bot Creator or a Citizen Developer user.
2. On the left pane, click **Automation**.
A list of available bots and forms is displayed.
3. Select the bots you want to check out and from the table level icons, click **Check out checked items**.

Note: You can check out up to 10 parent bots at a time. You can check out only the latest version of the bot and its dependencies.

Option	Steps
Check out	Select this option to check out the latest version of a bot. The dependencies are cloned automatically.

Option	Steps
Advanced options	<p>Select this option to review the information about the bot and dependencies which can be checked out, skipped, cloned and click Check out.</p> <ul style="list-style-type: none"> • The Files tab displays the bot files that can be checked out. • The Checkout Dependencies tab displays the dependencies which you can choose to check out. • The Review dependencies tab displays the information on the dependencies which are Overwritten, Missing, Cloned, or Skipped.

The bot appears in the same folder structure in the private workspace. When you check out bot files or folders, all the dependencies linked to the bot files or folders will either be checked out, cloned, skipped, or overwritten. For more information, see [Considerations for checking out multiple bots](#).

Considerations for checking out multiple bots

There are certain considerations you have to keep in mind when checking out multiple bots.

- You can check out up to 10 parent bots at a time.
- You can only check out the latest version of the bot. You cannot select a specific version of the bot to check out.
- During check out of multiple bots, the parent bots and their dependencies are either checked out, cloned, skipped, or overwritten depending on different scenarios.

The following table explains the different scenarios of the parent bots and their dependency behavior during check out of multiple bots.

Scenario	Behavior
Parent bot not checked out by the current user	The parent bot is checked out as part of the bulk checkout and is shown in the check-out section of the basic flow.
Dependency not checked out by the current user	The dependency is checked out as part of the bulk check out and is shown in the check-out dependencies section of the advanced flow.
Parent bot is already checked out by the current user	The parent bot is not re-checked out and is shown in the skipped section of the basic flow.
Dependency already checked out by the current user	The dependency is not re-checked out and is shown in the skipped section of the advanced flow.
Dependency checked out by other users	The dependency is cloned during bulk check out.
Parent bot already cloned by the current user and requiring a check out	The parent bot is checked out as part of the bulk checkout, and the clone will be replaced with the checked out bot.
Dependency already cloned by the current user and requiring a check out	The dependency is checked out as part of the bulk checkout, and the clone will be replaced with the checked out bot.
Dependency already cloned by the current user and is shown again for cloning in bulk check out	The dependency is not re-cloned and is shown in the skipped section of the advanced flow.

Scenario	Behavior
Parent bot is in new status in private workspace	During bulk check-out, the user is provided an option to overwrite the bot in the basic flow.
Dependency is in new status in the private workspace	If the dependency is to be checked out, it is shown in the overwrite section of the advanced flow. If the dependency is to be cloned, it is shown in the cloned section of the advanced flow.

Clone a bot

Create a read-only copy of the bot from the public workspace to the private workspace so that you can have a local copy without checking out the bot.

- Create a user with a Bot Creator license.
- Create a custom role with the clone permission assigned at the folder level to the user.
- To clone a dependency folder, you must have the clone permission on the dependency folder.

Cloning a bot does not affect other users' access to the bot in the public workspace. A bot can be cloned by multiple users.

1. Log in to the Control Room as a Bot Creator user.
2. On the left pane, click **Automation**.
A list of available and forms is displayed.
3. Select the bot you want to clone, click the actions menu (vertical ellipsis), and click **Clone Task Bot**.
The cloned bot appears in the same folder structure in the private workspace.

Delete a bot

If you are a Control Room administrator or user with **Delete from Public** permission, you can delete bots from the public workspace. If you are a Bot Creator, you can delete bots from your private workspace.

To delete a bot, ensure the following:

- **Public workspace:** You must have the Control Room administrator role or the **Delete from Public** permission at the folder level.
- **Dependent folders and files:** You must have the **Delete from Public** permission on these folders and files.
- **Private workspace:** You must have a Bot Creator license.

You cannot restore a deleted bot, so ensure that you no longer require a bot before deleting it.

Note: After you delete a bot, if you immediately create a bot with the same name as the deleted bot and create it in the same folder, an error is displayed in some cases. To avoid this error, after you delete a bot, wait for at least 5 seconds for the deletion to be completed. You can create another bot with the same name as the deleted bot and in the same folder.

- Delete bots from a private workspace:

In a private workspace, you can delete only bots that are in the **New** or **Cloned** status. You cannot delete a bot in the **Checked out** or **Checked out and edited** status.

- Log in to the Control Room as a Bot Creator.
- On the left pane, click **Automation**.
A list is displayed with the available files and folders containing the bots.
- From the **Automation** page, choose one of the following methods to delete a bot:

Option	Action
Specific bot	<ol style="list-style-type: none"> Select the bot. Hover over the actions menu (vertical ellipsis) located to the right of the bot name and click Delete Task Bot. Click Yes, delete.
Multiple bots	<ol style="list-style-type: none"> Select the check boxes corresponding to the bots, and click Delete checked items. Click Yes, delete.

- Delete bots from a public workspace:

In the public workspace, you can delete only bots that are in the **Public** status. You cannot delete bots that are in the **Checked out** status.

- Log in to the Control Room as an administrator, a Bot Creator, or an attended or unattended Bot Runner user with **Delete from Public** permission.
- On the left pane, click **Automation**.
A list is displayed, with the available files and folders containing the bots.
- From the **Automation** page, choose one of following methods to delete a bot:

Option	Action
Specific bot	<ol style="list-style-type: none"> Select the bot. Hover over the actions menu (vertical ellipsis) located to the right of the bot name and click Delete Task Bot. Click Yes, delete.
Multiple bots	<ol style="list-style-type: none"> Select the check boxes corresponding to the bots, and click Delete checked items. Click Yes, delete.

Preload packages

You can preload packages on your local device to shorten the bot runtime.

When you run a bot, the system downloads the bot and all the packages used in the bot. Bot execution begins when the download is complete. If the packages used in the bot are preloaded, the system can skip downloading the packages and start executing the bot, thereby reducing the bot execution timeframe.

Folder path: Preloaded packages are stored in `\ProgramData\AutomationAnywhere\GlobalCache` on the local device.

If there are multiple versions of a package, only the default package is preloaded. You can only preload packages on your local device. For the option to be available, the automatically download preloaded packages setting must be enabled by the Control Room admin.

Note: You can also save specific versions of packages that are used in bots offline to save the time it takes to download these packages from the Control Room. The specific version of packages are stored in the `C:\ProgramData\AutomationAnywhere\AAPreloadedPackages` folder.

Perform the following steps to preload packages on your local device:

1. Log in with a Bot Creator account.
2. Click the **Manage > Devices > Preload package** icon in the menu list for your local device.

Note: The **Preload package** option is also available from the device icon drop-down menu for Automation 360 Cloud through the Google Chrome browser with the Chrome plug-in enabled.

3. In the **Preload packages** window, preload either all packages listed on the **Common packages** page, or select individual packages from the **Customize packages** page.
Common packages are the most lightweight and most commonly used ones.
4. Click the **Start preloading** option.

Copy a bot

Copy a bot to create a duplicate sequence of actions within your private repository. The copy retains the meta-data of the original bot including captured images, recorded objects, called files, and child bots.

To copy a bot, follow these steps:

1. On the left pane, click **Automation**.
A list of available and forms is displayed.
2. Mouse over the actions menu.
The actions menu is the vertical stack of three dots to the left of each bot.
3. Click the **Copy Task Bot** icon.
4. In the **Name** field, enter a name for the duplicate bot.

Important: Bot name must be unique. If a bot with the same name exists in the same folder location which you have access to in the public workspace, you will not be able to copy the bot with this name in the private workspace.

5. Optional: Click **Browse** to select the folder where to save the bot.
6. Click **Copy**.
The duplicate bot appears in the specified folder.

View TaskBot version history

View the history of the changes that have occurred in your TaskBots. You can identify actions performed by a user during a specific date and time along with check-in messages.

You must have either check-in or check-out permissions.

You can view the version history of the TaskBots available in the public workspace and the private workspace (only if there are checked-out bots). However, there is no version history available for new and the cloned TaskBots.

The check-in or the check-out permission is required for the Bot Runner to view the version history. However, note that this permission cannot be used by the Bot Runner to check in or check out bots.

1. Log in to the Control Room.
2. On the left pane, click **Automation**.
A list of available and forms is displayed.
3. View the version history of TaskBots in the following ways:
 - Select the TaskBots for which you want to view version history. Hover over the actions menu (vertical ellipsis) located to the right of the TaskBots name and click **View history Task Bot**.
 - Click the bot name. When the bot open, click the vertical ellipsis at the top-right corner and select the **View history Task Bot** option.

A message appears listing all the versions of the selected bot in a sequence (latest revision on the top and the first revision is at the end). The information includes the version number, check-in message, checked-in date and time, and checked-in by username.

Assign label to a bot

You can now assign a production label for a particular version of a bot. You can use this label to choose the version on which you want to perform certain bot operations. With the version of your choice, you can schedule, run, queue, export, and trigger bot development workflows.

- You must have a custom role with the **Label bots** permission.
 - You can apply labels only to the bots that are checked in to the public workspace.
1. Log in to the Control Room.
 2. On the left panel in the public workspace, click **Automation**.
A list of available bots and forms is displayed.
 3. Select a bot, hover over the Actions menu (vertical ellipsis) on the right of the bot name, and click **Label Task Bot**.
A list of available versions of the bot is displayed.
 4. Select the version of the bot to which you want to apply a label.
 5. Click the right arrow (→) to add your selection.
 6. Click **Apply Label**.
The label **Production** is now assigned to the bot.

Note: If the production label option is selected for the parent bot, the corresponding dependent bots with the production label are also automatically selected. If any of the dependent bots do not have the production label applied, the latest version of the bot is selected. However, if the dependent bot is called through **Task Bot > Run > Variable > Control Room path** option, always the latest version of the bot is selected even if the production label is applied to the bot.

Edit a bot

Edit bot logic using the Bot editor to add, modify, or delete actions and automation steps.

Open a bot

Open a bot in the Bot editor in one of the following ways:

- Select the bot and click **Edit**. The edit button is a pencil icon.
- Right-click on the bot and select **Edit**.
- Click **Actions** and select **Edit**.

Compare bot versions

You can compare different versions of your bots and view any modifications in your workflows in both the public and the private workspaces.

Ensure you have the following permissions:

- **View my bots**
- **View content**
- **Check in** or **Check out**

- **Public workspace**

- Log in to the Control Room as a Bot Creator or a Citizen Developer user.
- Navigate to the public workspace.
- On the left pane, click **Automation**.
A list of available bots and forms is displayed.
- Select a bot, hover over the actions menu (vertical ellipsis) on the right of the bot name, and click **Compare versions**.
The compare version page appears with two versions of your bot. The left column shows the previous version of your bot, and the right column shows the newer version of your bot.
- Click the **Change version** icon to select and confirm the version of the bot that you want to compare on the left and right column.
You can review the two versions of your bot. The red highlights on the left column show the lines that are modified. The green or blue highlights on the right column show the lines that are added or changed. This view shows the bot versions by **Actions**.

Note: When you compare two versions of a bot, you might sometimes not observe any visible changes. This is because the bot version is modified as a result of changes in the underlying JSON file.

- Optional: Select **Variables, Triggers, Packages, or Dependencies** to compare your bot versions by these categories.

Note: The changes made to the immediate dependencies are displayed, and the dependencies are sorted in an alphabetical order.

- Optional: Select the **Swap versions** icon to swap between your two current versions.
- Click **Close** to exit the comparison view.

- **Private workspace**

- Log in to the Control Room as a Bot Creator or a Citizen Developer user.
- Navigate to the private workspace.
- On the left pane, click **Automation**.
A list of available bots and forms is displayed.
- Select a bot, hover over the actions menu (vertical ellipsis) on the right of the bot name, and click **Compare versions**.
The compare version page appears with the left column displaying the source checked-out version of the bot in the public workspace and the right column displaying the checked-out and edited bot in the private workspace.
- Click **Change version** to change the current bot version in the left column (**Public** version).
The **Select version to compare** page prompts you to select a new bot version.

Note: You cannot change version on the right column (**Private** version).

- Select and confirm the version of the bot that you want to compare on the left column.
You can review the source and edited versions of your bot . The red highlights on the left column show the lines that are modified. The green or blue highlights on the right column show the lines that are added or changed. This view shows the bot versions by **Actions**.
- Optional: Select **Variables, Triggers, Packages, or Dependencies** to compare your bot versions by these categories.

Note: The changes made to the immediate dependencies are displayed, and the dependencies are sorted in an alphabetical order.

- Click **Close** to exit the comparison view.

View bot dependency map

You can now view the dependency map for your bot in both the public and private workspaces. The dependency map shows the immediate parent and child bots for any selected bot. With this information, you can gauge the impact of the change in a bot, use the bot effectively, maintain better bot code and reusability, and prevent conflicts.

Ensure that you have the **View content** permission.

- Log in to the Control Room.
- On the left pane, click **Automation**.
A list of available bots and forms is displayed.
- View the dependency map of the bots in the following ways:
 - Select the bot for which you want to view version history. Hover over the actions menu (vertical ellipsis) located to the right of the bot name and click **View dependencies and references**.
 - Click the bot name. When the bot opens, click the vertical ellipsis at the top-right corner and select **View dependencies and references**.
- Toggle between the **Dependencies** and **References** tabs to view the immediate parent and child bots.
 - Dependencies:** Displays the bots or files that the bot uses to run
 - References:** Displays the bots or files that depend on the bot to run

Attach work item template to TaskBot

Attach a work item template to a TaskBot to use the TaskBot in workload automation.

When you attach a work item template to a TaskBot, you can use the variable **\$WorkItem\$** that contains the attributes for the required workload automation when you run the bot using the **Run bot with queue** option.

Use Work Item variables

1. On the left pane, click **Automation**.
A list of available and forms is displayed.
2. Create or edit a TaskBot from the **Automation** page.
The TaskBot opens in edit mode.
3. Select the option **Work item template** from the menu at the top-right of the Workbench.
The list of **Work item templates** appears.
4. Select the template that best suits your workload automation requirement.
5. Click the right arrow to add the template.
The **Work item template attributes** are listed for the selected template.
6. Click **Save**.
7. Choose one of the following actions:
 - Click **Close** to return to the **My bots** page.
 - Click **Return to editor** to continue editing the TaskBot.

Related concepts

[Workload management](#)

The workload management module enables users to upload Microsoft Excel and CSV files to the Control Room so that it feeds the records from the files into the bot deployments.

Related tasks

[Use Work Item variables](#)

You can use the Work Item variables to pass the Work Item attributes or values to the TaskBot from the Control Room when you run the bot with the option **Run bot with queue**.

Related reference

[Workload package](#)

The Workload package enables you to insert work items in a queue for workload automation. It also enables data chaining between multiple queues. You can orchestrate multiple bots, and enable optimal device utilization through the queueing mechanism of workload management.

View package versions available in the Control Room

Actions are grouped into version-specific packages. Bot Creators can select which package version to use for a specific bot.

Basic users can only view the packages available in the Control Room and the specific package details.

Bot Creators require the **AAE_Basic** permission to select specific packages to use within a bot.

Go to the **Manage > Packages** page to view all the packages in the Control Room.

Packages updated in Automation 360 v.26

Important:

- For information about packages updated in **v.27**, see [Packages updated in v.27](#)
- For information about packages in releases previous to v.26, see the PDFs for these releases: [Automation 360 previous release versions](#).

The following table provides details about the updates in the packages for v.26:

Package name	Version	Package updates	Bot Agent version	Control Room version
AARI web	7.0.1-20220727-162102	None	21.134 or later	12316 or later
Active Directory	3.5.0-20220416-233339	None	20.11 or later	8750 or later
Analyze	2.4.4-20220615-020937	None	20.11 or later	8750 or later
App Integration	4.8.0-20220616-123118	<i>Defect fix</i>	21.88 or later	10195 or later
Application	3.5.0-20220416-233350	None	20.11 or later	8750 or later
Boolean	2.5.0-20220118-153154	None	20.11 or later	8750 or later
Bot Migration	9.1.9-20220902-133838	<ul style="list-style-type: none"> • <i>New feature 1</i> • <i>New feature 2</i> • <i>New feature 3</i> • <i>New feature 4</i> • <i>New feature 5</i> • <i>Defect fix 1</i> • <i>Defect fix 2</i> • <i>Defect fix 3</i> 	21.220 or later	15224 or later
Browser	3.6.1-20220802-062805	<i>Defect fix</i>	21.210 or later	14140 or later
Clipboard	3.4.0-20220416-233509	None	20.11 or later	8750 or later
Comment	2.11.0-20220419-061753	None	20.11 or later	8750 or later
Credential	1.3.0-20220416-233509	None	20.11 or later	8750 or later
CSV/TXT	2.9.0-20220419-061754	None	20.11 or later	8750 or later
Database	4.9.3-20220804-174704	<ul style="list-style-type: none"> • <i>Defect fix 1</i> • <i>Defect fix 2</i> 	21.88 or later	10204 or later
Data Table	4.5.1-20220509-073253	None	20.11 or later	8750 or later
Datetime	2.8.8-20220628-071423	<i>Defect fix</i>	20.11 or later	8750 or later

Package name	Version	Package updates	Bot Agent version	Control Room version
Delay	3.5.0-20220416-233521	None	20.11 or later	8750 or later
Dictionary	3.8.0-20220505-214608	None	20.11 or later	8750 or later
DLL	6.6.1-20220617-052638	<ul style="list-style-type: none"> • <i>Enhancement</i> • <i>Defect fix</i> 	21.200 or later	15238 or later
Document Extraction	1.0.6-20221207-201734	None	21.98 or later	15345 or later
Email	3.13.1-20220713-173156	<ul style="list-style-type: none"> • <i>New feature</i> • <i>Defect fix 1</i> • <i>Defect fix 2</i> • <i>Defect fix 3</i> 	21.210 or later	13980 or later
Email trigger	2.7.3-20220714-073535	Defect fix*	21.210 or later	13980 or later
Error handler	2.9.0-20220127-062650	None	20.11 or later	8750 or later
Excel advanced	6.10.4-20220714-144826	<ul style="list-style-type: none"> • <i>New feature 1</i> • <i>New feature 2</i> • <i>Defect fix 1</i> • <i>Defect fix 2</i> 	21.112 or later	11307 or later
Excel basic	6.10.3-20220630-102036	Defect fix*	21.112 or later	11307 or later
File	6.4.0-20220615-171851	<i>Defect fix</i>	21.98 or later	10789 or later
File and Folder	1.2.0-20220628-195259	None	20.11 or later	8750 or later
Folder	6.4.0-20220615-171851	<i>Defect fix</i>	20.11 or later	8750 or later
FTP / SFTP	2.8.1-20220530-074610	<ul style="list-style-type: none"> • <i>Defect fix 1</i> • <i>Defect fix 2</i> 	20.11 or later	8750 or later
Genesys	1.0.4	None	21.210 or later	14199 or later
Google Calendar	2.8.1-20220623-122146	Defect fix*	20.11 or later	8750 or later

Package name	Version	Package updates	Bot Agent version	Control Room version
Google Drive	2.8.1-20220623-094335	Defect fix*	20.11 or later	8750 or later
Google Document AI	1.2.0-20220616-091303	Defect fix*	21.98 or later	10520 or later
Google Sheets	2.9.2-20220628-052504	Defect fix*	20.11 or later	8750 or later
Google G Suite	2.8.0-20220416-235104	None	20.11 or later	8750 or later
Hot key	1.1.0-20220715-220729	None	None	None
If	3.4.0-20220127-062702	None	20.11 or later	8750 or later
Image Recognition	3.11.0-20220623-052117	Defect fix*	21.210 or later	14100 or later
Interactive forms	2.26.2-20220728-053945	<ul style="list-style-type: none"> • <i>New feature</i> • <i>Defect fix</i> 	20.11 or later	8750 or later
Interface trigger	1.5.0-20220812-185225	None	20.11 or later	8750 or later
IQ Bot	2.2.5-20221107-102303	None	21.98 or later	10520 or later
IQ Bot Pre-processor	2.2.5-20221107-101937	None	21.98 or later	10520 or later
JavaScript	2.13.0-20220620-094839	Defect fix*	20.11 or later	8750 or later
JSON	1.1.0-20220419-055641	None	21.98 or later	10520 or later
Legacy AISense	1.0.8-20220714-195459	<ul style="list-style-type: none"> • <i>Defect fix 1</i> • <i>Defect fix 2</i> 	21.220 or later	15224 or later
Legacy Automation	5.3.1-20220804-175600	<i>Defect fix</i>	21.200 or later	13279 or later
List	2.8.0-20220118-153952	None	20.11 or later	8750 or later
Log To File	3.5.0-20220416-233918	None	20.11 or later	8750 or later
Loop	3.5.0-20220416-233919	None	20.11 or later	8750 or later
Message Box	3.4.0-20220416-233919	None	20.11 or later	8750 or later
Mouse	2.12.3-20220616-131218	Defect fix*	21.210 or later	14100 or later
Number	3.5.0-20220416-233938	None	20.18 or later	9130 or later

Package name	Version	Package updates	Bot Agent version	Control Room version
OCR	2.10.0-20220502-204318	None	21.118 or later	8750 or later
Office 365 Calendar	2.8.1-20220516-181356	None	20.11 or later	8750 or later
Office 365 Excel	2.9.1-20220516-182121	None	20.11 or later	8750 or later
Office 365 OneDrive	2.8.1-20220516-182128	None	20.11 or later	8750 or later
PDF	3.6.0-20220616-054613	<ul style="list-style-type: none"> • <i>Defect fix 1</i> • <i>Defect fix 2</i> 	21.31 or later	9300 or later
PGP	3.4.0-20220118-154220	None	21.88 or later	10195 or later
Ping	3.4.0-20220416-234250	None	20.11 or later	8750 or later
Play Sound	2.6.0-20220421-071315	None	20.11 or later	8750 or later
Printer	2.4.0-20220118-154256	None	20.11 or later	8750 or later
Process trigger	1.3.0-20220118-154818	None	21.112 or later	11314 or later
Process Discovery	2.1.13-20220712-150821	None	21.128 or later	12247 or later
Prompt	2.6.0-20220118-154257	None	20.11 or later	8750 or later
Python Script	2.12.0-20220812-184521	None	20.11 or later	8750 or later
Record	1.5.0-20220505-215415	None	20.11 or later	8750 or later
Recorder	2.8.6-20220823-160834	<ul style="list-style-type: none"> • <i>New feature 1</i> • <i>New feature 2</i> • <i>Defect fix 1</i> • <i>Defect fix 2</i> • <i>Defect fix 3</i> • <i>Defect fix 4</i> • <i>Defect fix 5</i> • <i>Defect fix 6</i> • <i>Defect fix 7</i> 	21.210 or later	14068 or later

Package name	Version	Package updates	Bot Agent version	Control Room version
REST Web Service	3.11.1-20220714-082239	<ul style="list-style-type: none"> • <i>New feature 1</i> • <i>New feature 2</i> • <i>Defect fix</i> 	20.11 or later	8750 or later
Salesforce	1.0.2-20220725-133902	<i>New feature</i>	21.119 or later	15422 or later
SAP	3.7.1-20220616-055414	<i>New feature</i>	21.88 or later	10195 or later
SAP BAPI	2.7.0-20220424-053247	None	21.2 or later	9249 or later
Screen	2.8.0-20220426-033753	None	20.11 or later	8750 or later
Service	4.5.0-20220416-234715	None	20.11 or later	8750 or later
Service trigger	1.5.1-20220425-083711	None	21.112 or later	11314 or later
Simulate keystrokes	3.9.2-20220620-185233	Defect fix*	21.200 or later	13297 or later
SNMP	2.5.0-20220419-063009	None	20.11 or later	8750 or later
SOAP Web Service	3.12.1-20220715-125139	<ul style="list-style-type: none"> • <i>New feature</i> • <i>Defect fix*</i> 	21.90 or later	10227 or later
Step	2.3.0-20220715-220724	None	20.11 or later	8750 or later
String	5.4.2-20220412-134724	None	20.18 or later	9130 or later
System	3.9.2-20220421-100102	None	21.88 or later	10217 or later
Task Bot	2.4.0-20220628-195240	None	20.11 or later	8750 or later
Terminal Emulator	4.7.1-20220728-125827	<ul style="list-style-type: none"> • <i>New feature</i> • <i>Defect fix 1</i> • <i>Defect fix 2</i> 	21.93 or later	10353 or later
Text file	1.3.0-20220416-235037	None	20.11 or later	8750 or later
Trigger loop	0.7.0-20220715-220725	None	20.11 or later	8750 or later
V11 Task Bot	1.12.1-20220707-062607	<i>Defect fix</i>	20.11 or later	8750 or later
VBScript	2.16.0-20220628-195244	Defect fix*	21.210 or later	14100 or later
Wait	4.5.0-20220416-235041	None	20.11 or later	8750 or later

Package name	Version	Package updates	Bot Agent version	Control Room version
Window	5.7.1-20220804-040754	<ul style="list-style-type: none"> • <i>New feature</i> • <i>Defect fix 1</i> • <i>Defect fix 2</i> 	20.11 or later	8750 or later
Window trigger	1.4.0-20220118-154823	None	20.11 or later	11314 or later
Workload	2.10.1-20220512-164301	None	20.11 or later	8750 or later
XML	3.6.0-20220530-054638	Defect fix*	20.11 or later	8750 or later

* These fixes do not include information in our documentation site, so no links are provided.

Select the package version used in your bot

As a Bot Creator you have the ability to select which package version to use for a set of actions within your bot.

You need to have **AAE_Basic** permission.

Tip: For existing bots, follow these steps to update to the default package.

1. Open or create a new bot from **Automation** page.
2. Click the vertical ellipses in the upper right corner, and select **Packages**.

Note: The packages used in the selected bot are highlighted.

3. Click the drop-down list to view which version of the package is currently used for this bot.
4. To change the package version to be used for this bot, select the package version to use from the drop-down list of available packages.
5. Click **Change version**.
6. Click **Save**.

Bot compatibility version

Bot compatibility version provides internal versioning for bot compilation and helps track different runtime behaviors for specific features. Compatibility version helps to maintain backward-compatibility when there are breaking changes (when you make changes in one part of the code that can cause potential issues in other areas).

Available compatibility versions

Bot compilation occurs on the device where the Control Room is located. Typically a Windows or Linux device is used based on the deployment model (Windows for On-Premises and Linux for Cloud).

Depending on your requirements, choose one of the following versions:

Version	Description
1	The bot file path is parsed at compilation time
2 (Default)	The bot file path is parsed at bot runtime depending on the device on which the bot is running For example, the UNC (universal naming convention) path format is different for Windows and Linux. When you choose this version, a message is sent to the bot compiler to parse the file path during runtime instead of at compilation time.
3 (Default)	The global value used in the parent bot is carried over to the child bot using a shared cache for the entire bot run which reduces the bot execution time.

Set the bot compatibility version

As a Bot Creator, you can set the bot compatibility version in the private workspace.

1. Log in to the Control Room.
2. In the private workspace, select the bot for which you want to set the version.
The bot opens in edit mode.
3. From the actions menu (vertical ellipsis), select **Advanced settings**.
4. If the **Bot compatibility version** is set to **1** or **2**, we recommend that you set it to **3** (default version) to enhance performance when using global values. Ensure that the parent bot and all the child bots have the **Bot compatibility version** set to **3**.

Note: If you set the **Bot compatibility version** to **1**, the bot runtime might be impacted; and if you set it to **2**, then the bot execution time might increase when using global values across bots.

5. **Optional:** Select the **Enabled improved number support** check box in the **Advanced features** field.

This setting helps in accurate float number calculation (positive or negative whole number with a decimal point) for your new bots.

6. Return to the bot editor and save the bot.

Compatibility version for migrated bots

After migration from Enterprise 11 to Automation 360 and if you have removed the `AAApplicationPath` from the destination path, your bot might fail. For more information on how to resolve this issue, see [Migrated bots and compatibility versions](#).

Set automation priority for your bots

Set the automation priority of your bots to high, medium, or low so that higher-priority automations are processed first for deployment. This enables you to meet your business SLA (service-level agreement) for resource optimization.

- You must have a Bot Creator license.

- You must be assigned the **Set automation priority to high** permission.

You can set the automation priority when you create and edit a bot.

1. Log in to the Control Room as a Bot Creator user.
2. In the private workspace, select a bot for which you want to set the priority.
The bot is opened in edit mode.
3. From the actions menu (vertical ellipsis), select **Advanced settings**.
4. Set the **Automation priority** to high, medium, or low based on your requirements.
When bots are queued for a Bot Runner user, bots with higher priority are deployed before bots with lower priority. However, if a bot with lower priority is already running, bots with higher priority are deployed after the bot with lower priority completes running.
The default permission is set to medium.
5. Return to the bot editor and save the bot.

Configure timeout for bot execution

Specify the amount of time the system must wait before terminating a bot that is unresponsive or is taking more time than expected to complete the task.

When a task times out, any downstream tasks (tasks in a queue) can run without any issues.

Timeout for a task is not applicable in the following scenarios:

- When a task is manually paused.
- If the task is run in Debug mode.
- If the task is called through the **Run** action of the Task Bot package.
- When the first task in a process is paused, additional tasks are canceled and the first task is resumed.

1. Log in to the Control Room.
2. On the left pane, click **Automation**.
A list of available bots and forms is displayed.
3. Open the bot for which you want to set timeout.
4. Select **Advanced settings** from the actions menu (three vertical ellipsis) on the top-right.
5. In the **Time out** field, specify the amount of time you want the system to wait before canceling a bot.
By default, the value in the **Time out** field is set to zero (0) and the system waits till the bot completes execution.
6. Return to the Bot editor and save the changes to the bot.

Create and rename folders

Depending on the permission assigned to you, you can create or rename folder names and description in the private workspace and rename the folder description in the public workspace. This helps to organize your bots and files in the Control Room repository.

To create folders, you must have the following permissions:

- View my bots
- Create folders

To rename folders, you must have the following permissions:

- View my bots

- Rename folders

You can grant access privileges to other users to specific folders so that they can perform various bot operations on the bots contained in that folder. Keep the following considerations in mind while renaming your folder:

- You can rename your non-empty folders only in the private workspace.
- Ensure the following when you rename a folder:
 - It does not contain checked-out or cloned bots even at subfolder levels.
 - It does not contain more than 100 items including subfolders and files.
- **Create a folder**
 - a) Navigate to **Automation > Folder**.
 - b) Click a folder in the **Folders** tree view to open it. For example, **Bots > Sample bots**.
 - c) Click the icon to create subfolders in the **Folder** tab and provide an appropriate name.
 - d) Browse and choose the path where you want to save the folder.
 - e) Click **Create folder**.
The folder is added and can be viewed in the **Folders** tree view and in the **Files and folders** tab.
- **Rename a folder in the private workspace**
 - a) Navigate to **Automation > Folder**.
 - b) Click a folder in the **Folders** tree view to open it. For example, **Bots > Sample bots**.
 - c) In the **Files and folders** tab, hover over the folder that you want to rename and click **Edit folder** (pencil icon).
 - d) Provide an appropriate name and description and browse and choose the path to the location where you want to save the folder.
 - e) Click **Save changes**.
- **Edit folder description in the public workspace**
 - a) Navigate to **Automation > Folder**.
 - b) Click a folder in the **Folders** tree view to open it. For example, **Bots > Sample bots**.
 - c) In the **Files and folders** tab, hover over the folder that you want to rename and click **Edit folder** (pencil icon).
 - d) Enter a meaningful description and then browse to select the location where you want to save the folder.
 - e) Click **Save changes**.

Keyboard shortcuts

List of keyboard shortcuts supported.

All modes - Flow or List view

In the Bot editor, you can open a menu to display available keyboard shortcuts.

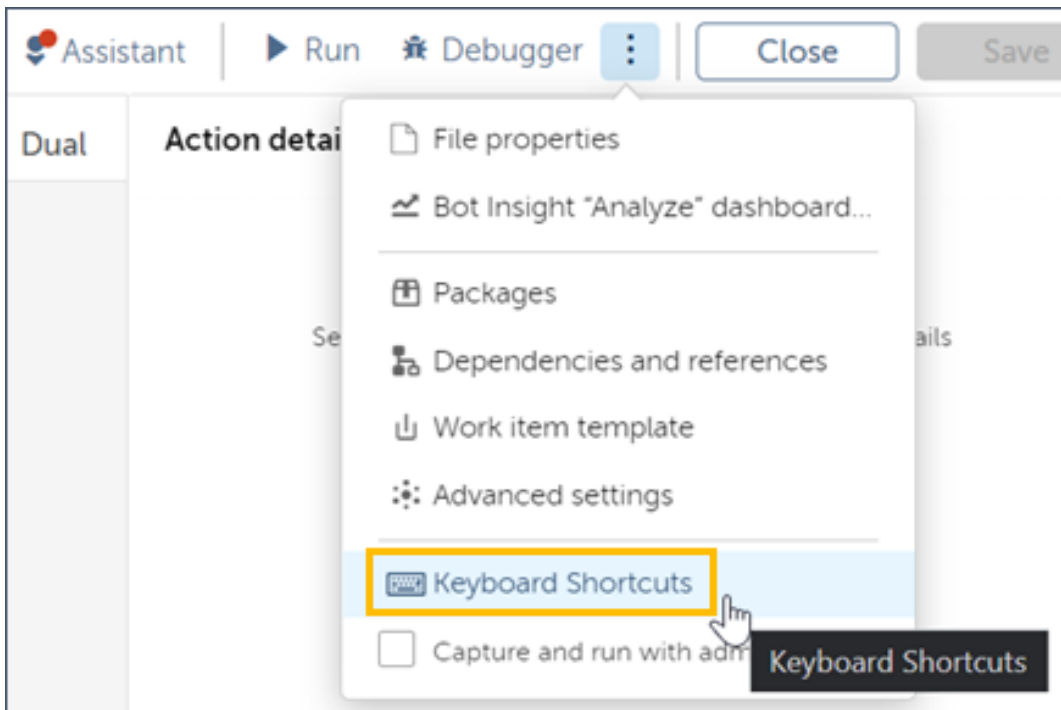

Keys	Action
Esc	Closes node details or clear cursor
Tab	Toggles Flow or List view
Enter	Shows node details and focus first input
Space	Toggles node details
Ctrl A	Selects all nodes

All modes - Flow view

Keys	Action
Up	Moves cursor up
Down	Moves cursor down
Left	Moves cursor left
Right	Moves cursor right

All modes - List view

Keys	Action
Up	Moves cursor up
Down	Moves cursor down

Edit mode

Keys	Action
Ctrl S	Saves file
F5	Run
F10	Enters debug mode
Shift F9	Toggles all breakpoint

Edit modes - Flow or List view in focus

Keys	Action
Ctrl Shift R	Starts recording
Ctrl /	Enables or disables mode
F9	Toggles node breakpoint
Ctrl C	Copy node
Ctrl X	Cut node
Ctrl V	Paste node
Delete	Delete node
Ctrl Z	Undo
Ctrl Y	Redo

Debug mode

Keys	Action
F5	Play/pause/restart
F6	Step next
F7	Stop
F10	Exits debug mode
Shift F9	Toggles all breakpoints

Debug mode - Flow or List view in focus

Keys	Action
F9	Toggles node breakpoints

Node details

Keys	Action
Ctrl Enter	Accepts current input and saves the action or trigger

Variables overview

Automation 360 offers a variety of variables, each designed to hold specific types of data and is intended for specific use. Use the topics below to learn more about each variable and how to use them.

Credentials and credential variables in the Bot editor

Use credentials when building bots to pass sensitive information such as passwords and account numbers. Using credentials separates the sensitive information from the bots and Bot Runners, which reduces the risk of data spillage or unauthorized user access.

Predefined variables

Predefined (or system) variables return the specific values about the machine on which the bot is executed. Users cannot edit the values of a predefined variable.

Your variables (user-defined)

Users and some actions create user-defined variables to temporarily hold values. Use this kind of variable to input values into an action (window title, login credential, or file path) or to accept the output of an action (values read from a file or a Boolean return).

Create a variable

Global values

Global values enable users to reuse identical values between bots instead of creating new variables for each bot. A user with the `AAE_admin` role configures a global value with a default value and can enable non-admin users to overwrite the value to use in their bots.

Work Item variables

You can use the Work Item variables to pass the Work Item attributes or values to the TaskBot from the Control Room when you run the bot with the option **Run bot with queue**.

Predefined variables

Predefined (or system) variables return the specific values about the machine on which the bot is executed. Users cannot edit the values of a predefined variable.

Predefined variable types include clipboard, date time, string and system settings and parameters.

Note: *System variables* are called as predefined variables in Automation 360.

Clipboard

Use the actions in the Clipboard package to perform operations on the clipboard variable. See [Clipboard package](#).

Variable	Description
<i>Clipboard</i>	Returns the contents of the clipboard.

Date time

Use the actions in the Datetime package to perform operations on the date time variables. [Datetime package](#)

Variable	Description
<i>Date</i>	Returns the date including hours, minutes, and seconds. Note: Hours can be in 24-hour or AM/PM format depending on the machine configuration.
<i>Day</i>	Returns the day in DD format.
<i>Hour</i>	Returns the hours in HH format.
<i>Machine</i>	Returns the device name as a string.
<i>Millisecond</i>	Returns the milliseconds with a value between 0 and 999.
<i>Minute</i>	Returns the minutes in MM format.
<i>Month</i>	Returns the month in MM format.
<i>Second</i>	Returns the seconds in SS format.
<i>Year</i>	Returns the year in YYYY format.

String

Use the following variables to change how a string is displayed.

Variable	Description
<i>Enter</i>	Starts a new line without returning to the beginning of the line based on the operating system of the device. For example, the variable always adds a new line in Linux CentOS. In Microsoft Windows, the variable adds a page break in the Microsoft Word application and a new line in the Notepad application.
<i>Newline</i>	Starts a new line and moves the cursor to the beginning of the next line regardless of the application and operating system of the device.
<i>Separator</i>	Demarcates a separation between values with a <code><sep></code> value.
<i>Tab</i>	Creates large space.

System settings and parameters

Use the following variables to return data from the computer that is connected to the running Bot Agent:

Variable	Description
<i>AAControlRoom</i>	Returns the URL of the Control Room.
<i>AAInstallationPath</i>	Returns the Bot Agent installation path. For example, C:\Program Files\Automation Anywhere\Bot Agent.
<i>AATaskExecutor</i>	<p>Returns details on the Run-as user that is used to run a bot. If the bot is deployed on an attended Bot Runner, this variable returns information about the logged-in user. If the bot is deployed by a trigger, this variable returns information about the user associated with that Bot Runner license.</p> <p>This variable is a dictionary with the following keys:</p> <ul style="list-style-type: none"> • <code>Executor_UserName</code> • <code>Executor_FirstName</code> • <code>Executor_LastName</code> • <code>Executor_Email</code> • <code>Execution_type</code>: Returns the type of execution <ul style="list-style-type: none"> • When you schedule a bot to run, the <code>Execution_Type</code> key in the <i>AATaskExecutor</i> variable returns information about the execution type with the schedule type (frequency) such as Run as schedule <Daily, Weekly, or Monthly>. • When you use a trigger in a bot, the <code>Execution_Type</code> key can be accessed through the trigger data. The <code>Execution_Type</code> key returns the Run through Trigger as a string for triggers. The <code>Execution_type</code> can be used in all the triggers.
<i>AATaskInvoker</i>	<p>Returns details on the user that deployed the bot either by running or scheduling the bot. If the bot is deployed to an attended Bot Runner, this variable returns information about the logged-in user. If the bot is deployed by a trigger, this variable returns information about the user who set the trigger.</p> <p>This variable is a dictionary with the following keys:</p> <ul style="list-style-type: none"> • <code>Invoker_Email</code> • <code>Invoker_FirstName</code> • <code>Invoker_UserName</code> • <code>Invoker_LastName</code>
<i>AATaskName</i>	Returns the path and name of the currently running TaskBot. For example, /Bots/Finance/combineSheets.atmx.
<i>CPUUsage</i>	<p>Returns the percentage utilization of the CPU.</p> <p>Use this variable in a Wait for condition action to make the bot wait until machine CPU usage decreases to a specific amount. See Wait package.</p>
<i>Machine</i>	Returns the name of the computer.

Variable	Description
<i>RAMUsage</i>	Returns the RAM usage in megabytes. Use this variable in a Wait for condition action to make the bot wait until machine RAM usage decreases to a specific amount. See Wait package .
<i>OSName</i>	Returns the operating system. For example, <code>Windows 10 64-bit</code> .
<i>TotalRAM</i>	Returns the total amount of RAM available.

- Version 11.3 contained Email, File, and PDF system variables, which could hold a limited number of properties values. In Automation 360, an infinite amount of Email, File, and PDF properties values are stored in User-defined Dictionary variables. For more information, see [Using dictionary variable for email properties](#) and [Using a dictionary variable for PDF properties](#).
- Version 11.3 contained Excel system variables to return the cell, column, or row location. In Automation 360, the Excel Advanced package contains the following actions to return location values: [Get cell address](#), [Get column](#), and [Get row](#).
- Version 11.3 contained the Counter system variable to return the loop iteration count. In Automation 360, the user must create and configure a number variable.

Your variables (user-defined)

Users and some actions create user-defined variables to temporarily hold values. Use this kind of variable to input values into an action (window title, login credential, or file path) or to accept the output of an action (values read from a file or a Boolean return).

When you are building automated tasks, some actions need to refer to and use some values, and these values can be stored in variables. Variables can help you in several ways, from retrieving online data to transferring data between applications, such as Microsoft Excel. A variable can hold one or more values. The values that a variable can contain and the operations that can be performed on the variable are determined by its data type.

Note:

- A bot can return only a maximum of 3 MB to an output variable. In addition, the table structure in `BotOutputVariable` is limited to 300,000 cells.

If you insert more than 300,000 cells, an error message is displayed indicating that the `debug` variable is too big to debug or that `BotOutputVariable` is too big to process.

Workaround: Store the bot output on the device, such as in a `.txt` file. If the output must be shared across multiple Bot Runners, store the output in a shared drive.

- The size of bot input variables is limited to 1900000 bytes. We recommend you use `.txt` file to store large data set.
-

Variable types

The data type of a variable is an attribute that determines the kind of data that the value stored in the variable can have. Data types include storage classifications, such as integers, strings, and characters. Variables such as dictionary, record, list, or table can hold multiple data types.

Most variable types have a package with a similar name, which contains actions used to perform operations on the values stored in the variable. For example, use the actions in the String package to work

on String variables. Similarly, to work on Number variables, use the actions in the Number package. To convert the value of one variable type to another, see [Type conversion](#)

Variable naming

A variable name can contain a maximum of 50 Unicode characters, including numbers (0-9), Latin letters (A-Z, a-z), and special characters (- and _). You can use double-byte characters, such as Chinese, Japanese, or Korean characters, in a variable name. [Unicode range supported in variables](#)

We recommend using camel case for variable names and prefixing the variable name to indicate the scope and data type. For example, `iFileEmailAttachment` for a file type variable that is used to provide an input.

Note: The following is a recommended naming standard for variables `<type/scope indicator><data type><Variable name>`. While there are many naming convention options, some standards must be adopted and used consistently within the organization.

The `<type/scope indicator>` is a single character as follows:

- `p` = local variable (neither input nor output)
- `i` = input variable
- `o` = output variable
- `io` = input and output variable
- `c` = constant

Following are a few more examples for naming variables.

- `iStrAuditLogPath`: a string type variable received from a calling task
- `oNumReturnValue` : a number type variable returned to a calling task
- `ioStrStatus`: a string that is both received from and returned to a calling task
- `cStrNull`: a string that holds no value; for example, useful for string comparisons to check whether a value is present

For more information about scope, see [Task Bot package](#). This standard enables you to search for variables by type. For example, `oStr` returns variables that are used to hold output string values.

Variable types

Variable type and suggested name	Description	Use examples
Any <i>Any</i>	Stores Boolean, Data table, Datetime, File, Number, Record, String, or Window data types. Use this variable type when you are uncertain of which data type an action will output.	Example of using the Run action
Boolean <i>Bool</i>	Stores either a True or False value.	

Variable type and suggested name	Description	Use examples
Credential <i>Cred</i>	Stores string values securely, preventing values from being displayed in a message box or written to a file. The value is either selected from the Credential Vault or is user-provided. <i>Credentials and credential variables in the Bot editor</i>	
DateTime <i>Date</i>	Stores a value containing a single date and time value.	You can format the values by selecting a predefined format or specifying a custom format. <i>Datetime formats</i>
Dictionary <i>Dict</i>	Stores data in the form of key-value pairs. The value can be boolean, number, or string. <i>Dictionary package</i>	<ul style="list-style-type: none"> • <i>Using dictionary variable for email properties</i> • <i>Using a dictionary variable for PDF properties</i>
File <i>File</i>	Stores a file path.	
Form <i>Form</i>	Stores the value that was input into an interactive form field. <i>Using interactive forms</i>	
List <i>List</i>	Stores a sequence of boolean, number, or string values. <i>List package</i>	
Number <i>Num</i>	Stores numeric values, including integers and decimals. It holds values from -9,223,372,036,854,775,808 to 9,223,372,036,854,775,807, and up to 15 decimal digits. You can assign a randomly generated value to this variable. <i>Random number action</i>	You can remove the digits following a decimal when converting the value into a string. <i>Number to string action</i>
Record <i>Rec</i>	Stores a single row of values extracted from a table. The values can be boolean, datetime, number, or string. <i>Record variable</i>	<i>Example of entering data into a web form from a worksheet</i>

Variable type and suggested name	Description	Use examples
Session <i>Sess</i>	Stores the session name from the Excel basic, Excel advanced, or Terminal Emulator packages. Pass this variable from a parent to a child bot in the Task bot > Run action to enable the child bot to process the data in the file opened in the parent bot. Note: When initializing this variable in the child bot, select Use as input .	<i>Example of sharing an Excel session between bots</i>
String <i>Str</i>	Stores alphanumeric and special characters, and empty values. It can hold up to 65535 UTF-8 characters. A string variable can hold multiple lines of text.	You can compare the value in a String variable to an empty String variable. <i>Example of using a conditional statement</i>
Table <i>Table</i>	Stores multiple values in a table of rows and columns. The values can be boolean, datetime, number, or string.	Assign values to a table variable by extracting values from a <i>CSV/TXT file</i> , <i>Excel file</i> , or a <i>Web form</i> .
Window <i>Win</i>	Stores a window title and URL. When you create a Window type variable, note that selecting Browser as default value supports only Google Chrome tabs whereas selecting Application as default value supports any application window.	Some actions, such as the Capture action, create a Window variable to store the specified window title and URL. <i>Example of extracting data from a web table</i>

Delete variables

You can delete user-created variables in either of the following ways:

- **Delete one variable:** In the **Variables** palette, click the vertical ellipsis to the right of the variable name and click **Delete variable**.
- **Delete unused variables:** In the **Variables** palette, click **Delete unused variables**, select which variables to delete, and click **Delete**.

Related tasks

[Create a variable](#)

Create a variable to store values.

Related reference

[Boolean package](#)

The **Boolean** package contains actions that enable you to do various operations on Boolean values.

Data Table package

The Data Table package contains actions that enable you to perform various operations on the values of table variables. Use these actions to join or merge content, search for specific values, insert rows and columns, remove duplicate rows, and write values to a file.

Datetime package

A datetime value consists of a date, time, and time zone. RPA Workspace stores datetime values in a Datetime variable. The **Datetime** package contains actions that enable you to perform various operations on datetime values. You can use these actions to manipulate and compare values in the Datetime variables.

Dictionary package

The **Dictionary** package contains actions that enable you to do various operations on dictionary-type values.

List package

The **List** package contains actions that enable you to perform various operations on a variable of the list data type.

Number package

The Number package contains actions that enable you to perform various operations on a number variable. A number variable holds numeric values, including integers and decimals. It holds values from -9,223,372,036,854,775,808 to 9,223,372,036,854,775,807, and up to 15 decimal digits.

String package

Use the **String** package to perform various operations such as comparing two strings, retrieving the string length, or converting a string to uppercase or lowercase.

Type conversion

You can temporarily convert the values inside a Boolean, Number, or String variable from one type to another type (typecasting) to use within one action. For example, use `$(YourStringVariable).String:toNumber$` to convert the value of a string variable to a number variable to perform mathematical operations.

Recursive expressions

Use a recursive expression to insert a variable in the place of an index or key of a dictionary, list, record, or table variable.

Create a variable

Create a variable to store values.

When you create a variable that uses characters such as the underscore (`_`) or hyphen (`-`) in your variable name, note that the underscore or hyphen are treated as the same character for the variable names. For example, `global-temp_path` is treated the same as `global-temp-path`. If you create a new variable that uses variables different from these two characters, an error is displayed.

If you have created a global variable as `global-temp-path`, you can refer to this variable in any of the following formats:

- `global-temp-path`
- `Global-Temp-Path`
- `global_temp_path`
- `Global_Temp_Path`

To create and configure a variable, perform the following steps:

1. From the Bot editor, click **Variables** > **Create variable** (+ icon) at the top of the **Variables** menu.

The screenshot displays the Automation Anywhere Bot Editor interface. On the left, a vertical sidebar contains a menu with various categories and actions. The 'Variables' menu item is highlighted with a red rectangular box. The main workspace on the right shows a flowchart for a bot named 'Test-VBScript-Topic'. The flowchart begins with a 'Start' trigger (a play button icon). Below it, an 'Error handler: Try' block (a red triangle icon) contains a sequence of actions: 1. 'Prompt: For value during bot execution and assign...' (a document icon), 2. 'String: To number Convert string \$prompt-assig...' (a speech bubble icon), 3. 'List: Add item \$nMakeSomePi\$ to \$lNumber...' (a list icon), and 4. 'VBScript: Open VBScript manual script of 7 lines' (a document icon). An arrow from the 'Error handler: Try' block points to an 'Error handler: Catch AllErrors' block (a red triangle icon), which contains action 10: 'Message box *Bot failed. Be sure you are on...' (a document icon). Another arrow from the 'Error handler: Catch AllErrors' block points to action 9, which is another 'Error handler: Try' block. The 'Variables' menu in the sidebar is highlighted in red.

2. In the **Create variable** window, enter a descriptive name for the variable that is prefixed by a lowercase letter to indicate the variable type.

For example, `sCellValue` to indicate a string data type.

Note:

- You can use double-byte characters, such as Chinese, Japanese, or Korean characters, in a variable name. [Unicode range supported in variables](#)
- Variables cannot be named Java keywords, such as String, Boolean, Integer, Public, and Finally.

-
3. Optional: Enter a description.

Recommendation: Provide meaningful variable description when defining input or output variables.

4. Optional: Select the **Constant (read-only)** option to ensure values cannot be edited or overwritten.
5. Select from the following options:

This field pertains to using a bot to run other bots. See [Task Bot package](#).

- **Use as input:** The variable holds a value that can be passed from the parent bot to a child bot. (Applicable only to a child bot)
- **Use as output:** The variable holds a value that can be passed from a child bot to the parent bot. (Applicable only to a child bot)
- **Both:** The value can be passed in both directions.
- **Neither:** The variable is confined to this bot; it cannot be shared across other bots.

The following example illustrates when to select **Use as input** or **Use as output** in a variable.

Suppose you want to add two numbers. The values are present in the parent bot, and the child bot performs the calculations. For the parent bot to transfer the values to the child bot, the two variables you created must be selected as **Use as input** so that the child bot can receive the values. Now, for the parent bot to receive the calculated value, the variable that stores the result of the calculation in the child bot has to be selected as **Use as output**.

Note: Ensure that you select the check boxes when you create a variable in the parent bot and the child bot. When you build the bot, and if you edit the selection of check boxes, it might impact your parent bot references, such as your parent bot might not work after this change.

-
6. Select a data type from the drop-down list.
For more information on data types, see [Variable types](#).
 7. Optional: Enter a default value to assign to the variable.
The values are NULL/empty by default.
 8. Click **Create**.

The variable appears in the Variables pane on the left side of the Bot editor.

If you want to edit a variable, you can change its name and value but not its data type.

9. To insert a variable into an action field, perform one of the following actions:

- Click F2 to open the variables list.
- Click the **Insert a value** icon, located on the right side of the field.
- Enter the variable name. As you type, the field generates suggestions of existing variables.

Note: Add a dollar sign at the start and end of the variable. For example, `$myVariableName$`.

You can use the variable option and pass it as a parameter to open a file in packages such as XML, Excel basic, or Excel advanced. To open files with different extensions, use the variable option to assign the folder path, file name, and file extension. First, create a variable for the folder path, `$sFolder$`. Then, for the files in the folder path, create two variables, one for file name `$name$` and another for file extension `$extension$`. To open a file, combine the variables as a string, such as `$sFolder$\$name$. $extension$`. For the extension to work with different file types and different open options, you can add conditional logic.

Build a Go be Great bot: Follow the steps in this procedure for an example of how to create a variable and assign it to an action.

Type conversion

You can temporarily convert the values inside a Boolean, Number, or String variable from one type to another type (typecasting) to use within one action. For example, use `$<YourStringVariable>.String:toNumber$` to convert the value of a string variable to a number variable to perform mathematical operations.

In the text field, enter `$<variable name>..` After you enter the period, the auto-fill suggests possible actions such as `toNumber`.

Variable type	Typecasting options
Boolean	<ul style="list-style-type: none"> • invert: Converts the Boolean value to the opposite value (True to False and False to True). • toNumber: Converts the Boolean value to a numeric value (True to 1 and False to 0). • toString: Converts the Boolean value to a string value.
Number	<ul style="list-style-type: none"> • decrement: Decreases the number value by one. • increment: Increases the number value by one. • toString: Converts the number value to a string value. <hr/> <p>Note: When you convert a number value to a string value and if the number has a decimal value, the decimal value is removed after conversion. For example, <code>15.234</code> will be shown as <code>15</code> when you convert it.</p> <hr/>

Variable type	Typecasting options
String	<ul style="list-style-type: none"> • length: Returns the number of characters in the string as a numeric value. • lowercase: Converts the characters in the string to lowercase. • reverse: Reverses the characters in the string. • toBoolean: Converts the string value to a Boolean value. • toNumber: Converts the string value to a number value. The limits of the String to Number action apply here. <p>See String to number action.</p> <ul style="list-style-type: none"> • trim: Trims blanks and whitespaces from the string. • uppercase: Converts the characters in the string to uppercase.

Note: Type casting is not supported for the following scenarios:

- As a value that is passed between bots.
- As a property value for an object captured with the Universal Recorder.

Object properties

Recursive expressions

Use a recursive expression to insert a variable in the place of an index or key of a dictionary, list, record, or table variable.

A recursive expression contains a variable nested inside of another variable (the outer variable). The value of the outer variable is conditional based on the value of the nested variable.

For example, the list variable `$listOfPlanets$` has the following values: Mercury, Venus, Earth, Mars, Jupiter, Saturn, Uranus, and Neptune. The Number variable `$indexPosition$` has value of 2. The expression `$listOfPlanets[$indexPosition$]` returns Earth.

The following types of expressions are supported. You can create a recursive expression containing up to 10 expressions.

- `$dictionaryVariable{$key$}$`
- `$listVariable{$index$}$`
- `$recordVariable{$index$}$`
- `$tableVariable{$rowIndex$}[$columnIndexOrName$]$`

Note:

- You cannot use a Table variable within a List variable. For example, the following expression is not supported: `$vListStr[$vTable[0][0]$]`
 - You cannot combine expressions with properties. For example, the following expression is not supported: `$dictionaryVar{$listStrVar[2]$}.String:reverse$`
-

Record variable

A record variable holds a row of data extracted from a database, spreadsheet, or table in name-field pairs. The fields can store values of Boolean, datetime, number, or string data type.

Working with a record variable

Record variables are commonly used in the loop action to store a single row of retrieved data; you can access a single value by specifying the index number or name. The index number is the position of the name-field pair. The name is either configured when the variable is initialized or it can be extracted from the column headers of the source table.

The following is an example table:

CustomerName	City
Dana	Pittsburgh
Sam	Los Angeles
Alex	Boston

In this example, a bot loops through the preceding table and assigns each row to `rCurrentRow`. To retrieve the value from the first column of each row, use either the index number `$rCurrentRow[0]$` or name `$rCurrentRow{CustomerName}$`.

Note: To retrieve a date time value from a record variable and use it as a string, concatenate the record variable with a string value in the action field.

Schema

A schema is like a template for the record fields. It sets the order of the fields and the type of data that can be entered into each field.

If you select the **Set schema** option when creating a new record variable, the following conditions apply at runtime, where the bot retrieves a row of data and stores it to a record variable:

- The retrieved values must match the configured field data types.

For example, the data set [{"name": "Sally"}, {"id": 002}, {"dob": "03/05/1989"}] can be assigned to a record variable with the schema [{"name": String}, {"id": Number}, {"dob": Date}].

- The data set attributes must follow the same order and capitalization.

For example, the data set [{"name": "Henry"}, {"id": 003}, {"dob": "06/13/2001"}] cannot be assigned to a record variable with the schema [{"id": Number}, {"name": String}, {"dob": Date}] or [{"Name": String}, {"ID": Number}, {"DOB": Date}].

- The record variable can accept a superset of the configured fields if the fields are in the same order.

For example, the data set [{"name": "Alex"}, {"id": 004}, {"dob": "12/10/1995"}, {"pet": "yes"}] can be assigned to a record variable with the schema [{"name": String}, {"id": Number}, {"dob": Date}].

- The record variable does not accept a subset of data.

For example, the data set [{"id": 005}, {"dob": "05/21/1975"}] cannot be assigned to a record variable with the schema [{"name": String}, {"id": Number}, {"dob": Date}].

If the bot encounters a row of data that does not meet the record variable schema, the bot fails. This prevents the bot from passing incorrect or invalid data into the next action.

Unicode range supported in variables

Review the valid characters that can be used in a variable name.

Language	Characters	Range
Arabic		U+0600 - U+0605, U+0620 - U+0669, U+066E - U+06D3
CJK ideographs	Common	U+4E00 - U+9FEA
	Extension A	U+3400 - U+4DB5
	CJK compatibility ideographs	U+F900 - U+FA6D
Chinese	Chinese Kanji	See CJK ideographs
Greek	All alphabetical characters (uppercase and lowercase) are supported. For extended characters (á é ñ ï ï ï ó ù ü ð ω €)	U+0370 - U+0374, U+0376 - U+0377, U+037A - U+037D, U+037F - U+0386, U+0388 - U+038A, U+038C, U+038E - U+03A1, U+03A3 - U+03F5, U+03F7 - U+03FF, U+1F00 - U+1F15, U+1F18 - U+1F1D, U+1F20 - U+1F45, U+1F48 - U+1F4D, U+1F50 - U+1F57, U+1F59, U+1F5B, U+1F5D, U+1F5F - U+1F7D, U+1F80 - U+1FB4, U+1FB6 - U+1FBC, U+1FBE, U+1FC2 - U+1FC4, U+1FC6 - U+1FCC, U+1FD0 - U+1FD3, U+1FD6 - U+1FDB, U+1FE0 - U+1FEC, U+1FF2 - U+1FF4, U+1FF6 - U+1FFC
Japanese	Hiragana	U+3041 - U+3096, U+309D, U+309E

Language	Characters	Range
	Katakana full-width and half-width characters	U+30A1 - U+30FA, U+30FC
	Kanji	See CJK ideographs
	Double-byte numbers	U+FF10 - U+FF19
Korean	Hangul Syllables	U+AC00 - U+D7A3
Latin	a-z	U+0061 - U+007A
	A-Z	U+0041 - U+005A
Latin extended (Czech, Danish, Dutch, Finnish, French, German, Hungarian, Italian, Norwegian, Polish, Portuguese, Romanian, Spanish, and Swedish)	Latin-1 supplement	U+00C0 - U+00D6, U+00D8 - U+00F6, U+00F8 - U+00FF
	Latin Extended-A	U+0100 - U+017F
	Latin Extended-B	U+0180 - U+024F
	Latin Extended-C	U+2C60 - U+2C7F
	Currency symbols	U+20AC
Numbers	0-9	U+0030 - U+0039
Russian	Cyrillic	U+0400 - U+0481, U+0483 - U+0487, U+048A - U+04FF
Special characters	Hyphen (-) and underscore (_)	U+002D, U+005F

Use Work Item variables

You can use the Work Item variables to pass the Work Item attributes or values to the TaskBot from the Control Room when you run the bot with the option **Run bot with queue**.

The Work Item variables are available in a TaskBot only after you attach a work item template to the TaskBot when you define the work item template in the work item structure during queue creation.

Attach work item template to TaskBot

1. On the left pane, click **Automation**.
A list of available and forms is displayed.
2. Click **Create a bot**.
3. In the **Create a Taskbot** window, enter the required parameters such as **Name**, **Description**, and **Folder** location.
4. Click **Create & edit** to open the TaskBot in edit mode.
5. Attach the bot to a queue category by selecting a **Work item template**.

Attach work item template to TaskBot

6. Press the function key F2 to open the **Insert a variable** window and add the following Workload variables to an action:
- a) **workItem** to view the default values or attributes of the Work Item when you run the TaskBot using the **Run bot with queue** option.
The **workItem** is an input variable for debugging a Workload bot to be used for TaskBot deployment options **Run now** and **Schedule a bot**. You can add the values for the **workItem** variable when you create an automation.
On the other hand, when you use the option **Run bot with queue**, the **workItem** variable uses the values passed on by the Control Room.
 - b) **workItemResult** to set the final outcome of the Work Item when you run the TaskBot using the **Run bot with queue** option.
Use the **String > Assign action** to set the value of **workItemResult** variable. This is an output variable type and you can use the string values as well as other variables to set the value of **workItemResult** variables.

The variables are read-only and therefore cannot be edited or deleted from the TaskBot editor page. Double click a variable in the **Variables** panel to view the variable parameters:

- Variable name.
- Description of the variable.
- Read only if the Constant check box is selected when the variable was created.
- To be used as input or output parameter in a TaskBot during run time.
- Variable type.
- The default values or attributes that are configured with the Work Item template for a **workItem** variable or the default output values for a **workItemResult** variable.

Related concepts

[Workload management](#)

The workload management module enables users to upload Microsoft Excel and CSV files to the Control Room so that it feeds the records from the files into the bot deployments.

Related tasks

[Define Work Item structure](#)

Define the Work Item structure for processing in a queue. This enables you to manually upload the Work Items from the system in the absence of ready data in a file.

[Attach work item template to TaskBot](#)

Attach a work item template to a TaskBot to use the TaskBot in workload automation.

Related reference

[Workload package](#)

The Workload package enables you to insert work items in a queue for workload automation. It also enables data chaining between multiple queues. You can orchestrate multiple bots, and enable optimal device utilization through the queueing mechanism of workload management.

Credentials and credential variables in the Bot editor

Use credentials when building bots to pass sensitive information such as passwords and account numbers. Using credentials separates the sensitive information from the bots and Bot Runners, which reduces the risk of data spillage or unauthorized user access.

Credential

A credential holds the sensitive information in attributes. An attribute can have a value that is standard for all users or it can accept a user-input

value. For example, an `Email` credential can hold three attributes: `host name` (standard value), `username` (user input), and `password` (user input).

Credentials are predefined in the **CREDENTIALS** tab and cannot be modified when the user is building or running a bot.

By default, all users can create, manage, and use their own credentials. A user is granted access to another user's credentials by receiving access to a locker that holds the credential. If the credential requires a user-input value, it appears in the **CREDENTIAL REQUESTS** tab.

A credential must be assigned to a locker to be used for building and running a bot.

Locker

A locker specifies which users can view, modify, or access the credentials. For example, a human resources (HR) locker can hold `Email`, `Database`, and `Training website` credentials and allow only specific employees of the HR department to use the credentials in their bots.

Credential variable

A credential variable stores a credential value in a user-defined variable. It enables users to securely pass values to a bot and from a bot to another bot. Using a credential variable ensures that the values are not displayed in a message box or written to a file. The value is either selected from the Credential Vault or is provided by the user. You can use it into any action field that accepts a variable.

Note: Values of this data type cannot be converted to another data type.

You can:

- Pass login credentials to a child bot.
- Retrieve confidential data, such as account numbers, and pass them to the main bot.

Note: You cannot pass credential values to the main bot when you deploy it from the **Run bot now** page. The values must be hard-coded in the bot or selected from the Credential Vault.

Working with credentials

- Only fields with a **Credential** tab below the field name accept a credential.
- Action fields display the locker, credential, and attribute name; users can not see attribute values in the Bot editor.
- A credential cannot be appended to other variables or to a string.

Related tasks[Create credential](#)

Create a credential and add the required attributes.

[Edit a credential](#)

Modify credential details and add or remove attributes.

Example of building a bot that uses credentials

Build a bot that securely logs in to an online bank using credentials from Credential Vault, ensuring that the username or password is not stored in the bot or on the device.

- Credentials must be assigned to a locker to be used in a bot.
- You must have **Consumer** permissions to the locker.

If the email notification setting is enabled, you receive an email that confirms the locker name and your permissions to that locker.

In this example, you configure a credential with user-provided values and build a bot to automate logging into an online bank website.

1. Provide the user-input values.
 - a) Navigate to **BOTS > Credentials > CREDENTIAL REQUESTS**.
The credentials that require a user-provided value have an incomplete icon in the first column.
 - b) Click the credential that holds the bank login credentials.
 - c) Click **Edit**.
 - d) Enter the attribute values for the username and password and click **Save changes**.
2. Open a new bot.
 - a) On the left panel, click **Automation**.
A list of available bots and forms is displayed.
 - b) Click **Create new > Bot**.
 - c) Enter a bot name and click **Create and edit**.
3. Open the browser to the bank login page.
 - a) Double-click or drag the **Browser > Open** action.
 - b) Enter the URL.
For example, `www.examplebank.com/login`.
Use an application page where you want to enter a credential.
 - c) Select your preferred browser.
 - d) Click **Save and Run**.
The bank website opens in a new window. If the website opens in a new tab, drag it into a separate window.
4. Specify the username text box.
 - a) Double-click or drag the **Recorder > Capture** action.
 - b) From the **Object detail** menu, select the window containing the bank website.
 - c) Click **Capture object**.
The window containing the bank website is activated.
 - d) Hover over the username text box and click when a red outline appears.

- e) In the Object properties table, verify that the Control Type is a textbox.
 - f) From the **Action** menu, select **Set text**.
 - g) Select the **Select a credential** option and click **Pick** to navigate to the credential. The **Pick a credential** window appears.
 - h) Select the **Locker, Credential, and Attribute** for the bank website username and click **Confirm**.
5. Repeat Step 4 to specify the password text box.
 6. Specify the Log on button.
 - a) Double-click or drag the **Recorder > Capture** action.
 - b) From the **Object detail** menu, select the window containing the bank website.
 - c) Click **Capture object**.
The window containing the bank website is activated.
 - d) Hover over the Log on button and click when a red outline appears.
 - e) In the Object properties table, verify that the Control Type is a button.
 - f) From the **Action** menu, select **Click**.
 7. Close the window containing the bank website.
 8. Click **Save** and **Run**.

Example of building a bot that uses credential variables

Perform the steps in this task to learn how to pass values securely between bots.

Related reference

[Recorder package](#)

Recorder package captures a series of tasks in a process and then automates them. You can automate your business applications (for example, desktop, Web, SAP, and Java applications) using the Recorder to capture actions performed on application objects such as a text box, button, table, radio button, combo box, and list view.

[Credentials and credential variables in the Bot editor](#)

Use credentials when building bots to pass sensitive information such as passwords and account numbers. Using credentials separates the sensitive information from the bots and Bot Runners, which reduces the risk of data spillage or unauthorized user access.

Example of building a bot that uses credential variables

Securely pass values to a bot using credential variables to automate the process of logging in to a bank website.

Complete the steps in the following task to build the child bot that automates logging in to a bank website:

Example of building a bot that uses credentials

This task is performed by the user who wants to build and deploy . You must have the necessary rights and permissions to complete this task, and authorization to log in to the as the licensed user.

In this example, you modify the bot to accept credentials passed from a parent bot.

In the bot that you built for [Example of building a bot that uses credentials](#), create two credential variables and insert them into the **Recorder > Capture** actions.

1. Configure the credential variable to hold the username.

Field	Input
Name	username
Use as input	select
Type	Credential
Default value	Insecure string, leave field empty

2. Configure the credential variable to hold the password.

Field	Input
Name	password
Use as input	select
Type	Credential
Default value	Insecure string, leave field empty

3. Modify the first **Recorder > Capture** action.
 - a) Click the action to open it in the action editor.
 - b) In the **Select a credential** field, select the **Variable** tab.
 - c) Click F2 to open the Variables menu and select \$username\$.
 - d) Click **Yes, insert**.
4. Repeat the substeps in step 3 to insert the \$password\$ variable into the second **Recorder > Capture**.
5. Click **Save** and **Close**
The **Automation** page appears.

Create a parent bot that will run the child bot and pass it the credential values.

6. Open a new bot.
 - a) Click **Create new > Bot**.
 - b) Enter a bot name and click **Create and edit**.
7. Insert a **Task Bot > Run** action to select the bot and provide the login credentials.
 - a) Double-click or drag the **Task Bot > Run** action.
 - b) In the **Task Bot to run** field, select the **Control Room file** tab.
 - c) Click **Browse** and select the bot that you modified in the above steps.
 - d) In the **Input values** options, select both **Set username** and **Set password**.
 - e) For each credential variable, click **Pick** to select the locker, credential, and attribute.
8. Click **Save** and **Run**.

Related tasks

[Create a variable](#)

Create a variable to store values.

Related reference

[Task Bot package](#)

Use the **Run**, **Pause**, and **Stop** actions in the Task Bot package to manage running one or more child bots from a parent bot or with a third-party software using an API.

Credentials and credential variables in the Bot editor

Use credentials when building bots to pass sensitive information such as passwords and account numbers. Using credentials separates the sensitive information from the bots and Bot Runners, which reduces the risk of data spillage or unauthorized user access.

Global values

Global values enable users to reuse identical values between bots instead of creating new variables for each bot. A user with the `AAE_admin` role configures a global value with a default value and can enable non-admin users to overwrite the value to use in their bots.

Data types

Data type	Description
DateTime	Stores a value containing a single date and time value.
Number	Stores numeric values, including integers and decimals. It can hold up to 15 decimal digits.
String	Stores alphanumeric and character values.
Boolean	Stores a Boolean value as True or False, default value is False.

Working with global values

Note: The maximum number of public global values that can be created by an admin user is 150.

Users can perform the following tasks:

- Create a global value as an admin.
Create a global value
- Update the default value as a non-admin.

Overwrite the default value

- Delete a global value.

A user with the **AAE_Admin** role can delete a global value by hovering over the vertical ellipsis to the right of the value, and clicking the **Delete** icon. When a global value is deleted, any overridden values for that global value are also deleted.

- Insert global values into bots.

All action fields that accept a user-created variable accept a global value. Insert a global value into an action field by pressing F2 or by clicking the **Insert a value** icon on the left side of the field.

Create a global value

You should have the `AAE_Admin` role to create a global value, configure the data type, set the default value, and enable the value to be updated by non-admin users

1. Log in as an administrator and navigate to **Manage > Global values**.
The **All global values** page appears with a table of global values.

2. Click **Create global value**.

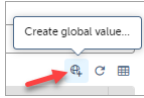

The **Create global values** screen appears.

3. Enter a descriptive name of up to 50 characters.

Note:

- When the global value is initialized, you cannot change the name.
- Global values cannot be named Java keywords such as String, Boolean, Integer, Public, and Finally.

4. Optional: Enter a description of up to 255 characters.

5. Select the data type from the drop-down list.

Data types

6. Enter the default value.

Note: When the value is initialized, you cannot change the type.

7. Specify whether users can overwrite the value:

- **CANNOT be changed:** The default value remains constant across all users and bots.
- **CAN be changed:** Users can overwrite the default value to use in their bots.

Note: When you create a global value, if you set its scope to **CANNOT be changed**, you cannot edit the scope to **CAN be changed** later. If you want the scope of the global value to be **CAN be changed**, delete the value and recreate it with the scope set to **CAN be changed**.

8. Click **Create global value**.

<https://fast.wistia.net/embed/iframe/hdcumdctl>

Overwrite the default value

Global values can be configured to allow non-admin users to overwrite the default value. When building bots, use a global value for values that remain constant across all bots instead of creating a new variable for every bot.

As a non-admin user, you can only overwrite the default value in global values with a changeable scope. You can identify which global values have a changeable scope by checking the value in the **Scope changeable** column in the **All global values** table.

To verify if a global value has a changeable scope and to overwrite the default value, do the following steps:

1. Navigate to **BOTS > Global values**.
The **All global values** table appears. Each row shows the data type, value name, whether the scope is changeable, and the last modified date and time.
2. Find the global value that has a changeable scope.
3. Move your mouse over the vertical ellipsis and click **Edit global value**.
The **Edit global value** page appears with the **User value** field enabled.
4. Enter the value that will overwrite the default value.

Note: This value will overwrite the default value of this global value in all of your bots.

5. Click **Save changes**.

Bot dependencies

Bots dependencies are files and other bots that are required to run that bot successfully.

Related tasks

[Upload bot and its dependencies](#)

You can upload Enterprise 11 or Enterprise 10 bots, their dependent bots, and other files that are required to run a bot successfully in the Automation 360 Control Room.

[View bots dependencies](#)

You can view the files and bots that are added to a bot as its dependencies.

Related reference

[Bot dependencies](#)

Bots dependencies are files and other bots that are required to run that bot successfully.

Upload bot and its dependencies

You can upload Enterprise 11 or Enterprise 10 bots, their dependent bots, and other files that are required to run a bot successfully in the Automation 360 Control Room.

1. On the left pane, click **Automation**.
A list of available and forms is displayed.
2. In the **PRIVATE** tab, expand the **Bots** folder and select the folder in which you want to upload the dependent files.
3. Click the **Upload files** icon.
4. On the **Upload files** page, click **Add files**.
5. From the **Open** dialog box, select the files you want to upload and click **Open**.
6. Click **Upload**.

Related tasks

[Add bot dependencies](#)

You must add the files that are required to run a bot as its dependencies.

[View bots dependencies](#)

You can view the files and bots that are added to a bot as its dependencies.

Add bot dependencies

You must add the files that are required to run a bot as its dependencies.

Ensure that the files you want to add as dependencies are uploaded in the Control Room, except for bots.

The system identifies the automatic dependencies for a bot and adds the required files and other bots as its dependencies. However, for manual dependencies, you must identify the files and bots that are required and add them as dependencies for a bot.

1. On the left pane, click **Automation**.
A list of available and forms is displayed.
2. In the **PRIVATE** tab, expand the **Bots** folder that contains the bot for which you want to add dependencies.
3. Select the bot for which you want to add dependencies.
4. Select the **Edit Task Bot** icon from the actions menu (vertical ellipsis) on the right.
5. Select **Dependencies** from the actions menu (vertical ellipsis) on the top-right.
6. Expand the **Bots** folder and select the folder that contains the files you want to add as dependencies.
7. Select the files you want to add as dependencies from the Available files section and click the right arrow.
8. Click **Save**.
9. Click **Return to editor** if you want to update the bot or click **Close** to close the bot.

Related tasks

[View bots dependencies](#)

You can view the files and bots that are added to a bot as its dependencies.

[Upload bot and its dependencies](#)

You can upload Enterprise 11 or Enterprise 10 bots, their dependent bots, and other files that are required to run a bot successfully in the Automation 360 Control Room.

View bots dependencies

You can view the files and bots that are added to a bot as its dependencies.

1. In the **PRIVATE** or **PUBLIC** tab, expand the folder that contains the bot for which you want to view dependencies.
2. Select the bot for which you want to view dependencies.
3. Select the **View Task Bot** icon from the actions menu (vertical ellipsis) on the right.
4. Select **Dependencies** from the actions menu (vertical ellipsis) on the top-right.
The system shows a list of files and bots that are added as dependencies for the bot.

Related tasks

[Add bot dependencies](#)

You must add the files that are required to run a bot as its dependencies.

[Upload bot and its dependencies](#)

You can upload Enterprise 11 or Enterprise 10 bots, their dependent bots, and other files that are required to run a bot successfully in the Automation 360 Control Room.

Edit bot-dependent text-based files

As a Bot Creator, you can open, view, edit, and save bot-dependent text-based files directly inside the workbench. Automation 360 supports more than 40 text-based file formats, such as TXT, XML, JSON, and Javascript.

- You must have a Bot Creator license.
- You must be assigned a custom role, with the **View content** and **Check out** permissions assigned at the folder level.

If you have the **Check in** permission, you can check in the edited files to the public workspace.

1. Log in to the Control Room as Bot Creator.
2. In the **Private** page, expand the **Bots** folder and select the folder that contains the bot-dependent text-based files that are added as dependencies.

Note: You can edit only the text-based dependent files.

3. Select the file that you want to edit.
4. From the actions menu (vertical ellipses) on the right, click **Edit file** to open the file in the text editor. The file opens up with all the formatting effects.

For example, XML files open up with the same formatting as that in code editor, providing you with a similar experience.

5. Make changes to the file and click **Save**.
The changes made to the file are saved.
6. Click **Close**.

Check out non-bot file dependencies

Check out the specific versions of the non-bot file dependencies from the public workspace to the private workspace to create an editable copy of the file.

Ensure you have completed all the prerequisites for checking out non-bot file dependencies: [Prerequisites for checking out bot and dependencies](#).

1. Log in to the Control Room as a Bot Creator or a Citizen Developer user.
2. On the left pane, click **Automation**.
A list of available bots, forms, and non-bot files are displayed.
3. You can choose to check out either one file or multiple files simultaneously.
 - Select the file dependency that you want to check out, click the actions menu (vertical ellipsis), and click **Check out file**.
 - Select the file dependencies that you want to check out and click **Check out checked items**.

Option	Steps
Check out file	Select this option to check out the latest version of the dependent file.
Advanced options	<p>Select this option to select a specific version of the dependent file to check out.</p> <ol style="list-style-type: none"> a. Click Advanced options. b. Select the version of the dependent file to check out. c. Add or remove further dependencies if any. d. Select the version of these dependencies. e. Review the dependencies (Overwritten, Missing, Cloned, Skipped.) f. Click Check out.

The file appears in the same folder structure in the private workspace.

4. To cancel the checked-out dependent file, click the **Cancel check out for file** option.

You can use this option from either the public or the private workspace.

In the public workspace, the file status changes to **Public**, and the file is available for check out by another user with the appropriate permissions. In the private workspace, the file status changes to **New** if any changes were made to the file. If there are no changes, the file is replaced with a clone.

View version history of non-bot file dependencies

You can now view the version history of your non-bot file dependencies such as TXT, XML, JSON, XLS, VBS, CSV, Javascript files, to identify relevant changes performed by other users to your files on a specific date and time along with the check-in messages.

You must have check-in and check-out permissions.

You can view the version history of the non-bot file dependencies available in the public workspace and the private workspace (only if there are checked-out files). However, there is no version history available for new and cloned files.

1. Log in to the Control Room.
2. On the left pane, click **Automation**.
A list of bots, forms, and dependencies are displayed.
3. Select the dependency file for which you want to view the version history. Hover over the actions menu (vertical ellipsis) on the right and click **View history file**.
A message appears listing all the versions of the selected file in a sequence (latest revision on the top and first revision at the bottom). The information includes the version number, check-in message, date and time of check-in, and the username that made the check-in.

Get started building bots

Use the following three examples to become familiar with building bots using in the cloud-based Bot editor. These examples demonstrate using actions and the Universal Recorder to automate tasks in applications and browsers.

Build a Go be Great bot

Build a basic bot using a **Message Box** action and a variable. Follow these steps to create your first bot that prints the message, `Go be great!`, the Automation Anywhere version of `Hello World!`

Build a basic bot that uses a desktop application

Build a bot that uses a conditional statement to verify that the calculator is open, then uses the calculator to multiply two numbers. This example uses actions from the Application, If, Simulate keystrokes, Message Box, and Window packages.

Example of extracting data from a web table

Build a bot to open a browser window to the Wikipedia website, extract the data from a table, and write it to a CSV file on your desktop. This example uses actions from the Browser, Data Table, Recorder, and Window packages.

For more examples, see [Examples of building bots](#).

More resources

- To learn more, search for the *Hello Automation 360 Bot: Getting Started with Building Bots* course in *Automation Anywhere University: RPA Training and Certification (A-People login required)*.
- You can also visit the *Learn section of the developer portal* for more guidance. Find learning journeys and videos for both new and experienced developers on how to build your first bots.

Build a Go be Great bot

Build a basic bot using a **Message Box** action and a variable. Follow these steps to create your first bot that prints the message, `Go be great!`, the Automation Anywhere version of `Hello World!`

To build a bot you must already have done the following:

- [Install Bot Agent and register device](#)
- [Set user device credentials](#)

If you have already completed the steps in [Create your first bot](#), skip to Step 6.

1. Create a new bot:
 - a) On the left panel, click **Automation**.
 - b) Click **Create new > Bot**.
 - c) In the **Create Task Bot** window, enter the bot name.
 - d) Accept the default folder location: `\Bots\`
To change the default bot storage location, click **Choose** and follow the prompts.
 - e) Click **Create and edit**.
2. Insert a **Message box** action.
 - a) Click **Actions**.
 - b) Search for the Message Box package.
Click in the **Actions** search box and enter `message`. Click the arrow to expand the Message Box options.
 - c) Double-click or drag the **Message box** action to the Bot editor (open space to the right).
3. In the dialog box on the right, specify the conditions for the **Message box** action.
 - a) In the **Enter the message box window title** field, enter `My first bot!`.
 - b) In the **Enter the message to display** field, enter `Go be great!`.
 - c) Accept the defaults in the **Scrollbar after lines** field and **Close message box after** check box.

4. Click Save.

Your bot is now ready to run.

You can view the time spent to create a bot by navigating to **Automation > Home > My metrics**. The **Active Task Bots** table displays the time taken to create every bot. When a bot is edited, the table shows the total time spent on the bot.

For example, if you spend 10 minutes on creating and saving a bot, the **Active Task Bots** table displays the time spent as 10 minutes. If you spend 5 more minutes on editing the same bot, the **Active Task Bots** table displays the total time spent as 15 minutes.

Similarly, the **Average time spent to create a Task Bot** field on the **My Metrics** page displays the average time spent across all users on all bots.

For example, if user 1 spends 120 minutes on **Bot A**, user 2 spends 2 minutes on **Bot B**, and user 3 spends 4 minutes on **Bot C**, the average time is calculated as $(120+2+4)/3 = 42$ minutes.

5. Test your bot.

Click **Run** at the top right.

The bot displays a Message box with the text `Go be great!`.

In the following steps, you configure a variable and insert it in the Message box.

6. Create a variable.

- a) Click **Variables** from the accordion menu on the left panel.
- b) Click **Create variable** (the + sign).
- c) Enter `vHelloWorld` in the name field.
- d) Select the **Use as output** option.
- e) Enter `Say Go be Great! with a variable` in the **Default value** field.
- f) Click **Create**.

7. Assign the vHelloWorld variable to the Enter the message to display field.

- a) Click the **Message box** action in the Bot editor.
- b) In the dialog box, delete the text from the **Enter the message to display** field.
- c) Either press the F2 key or click the **Insert variable** icon.
The **Insert variable** icon is located on the right-side of the text field.
- d) Select `vHelloWorld` from the drop-down list.
- e) Click **Yes, insert**.

8. Click Save.**9. Click Run.**

The bot displays a Message box with the text `Say Go be Great! with a variable`.

After you successfully run your bot, go to [Build a basic bot that uses a desktop application](#).

Build a basic bot that uses a desktop application

Build a bot that uses a conditional statement to verify that the calculator is open, then uses the calculator to multiply two numbers. This example uses actions from the Application, If, Simulate keystrokes, Message Box, and Window packages.

To build a bot you must already have done the following:

- [Install Bot Agent and register device](#)

- *Set user device credentials*

1. Open a new bot.
 - a) On the left panel, click **Automation**.
A list of available bots and forms is displayed.
 - b) Click **Create new > Bot**.
 - c) Enter a bot name and click **Create and edit**.
2. Insert an conditional sequence that verifies that the calculator is open and activates the window.
 - a) Double-click or drag the **If** action.
 - b) Select **Window exists** from the **Condition** drop-down list.
 - c) Select the **Application** tab and click the refresh icon to display all open applications.
 - d) Select **Calculator** from the **Window** drop-down list.
The Calculator window is saved to the variable `window-1`.
 - e) Drag the **Message box** action into the **If** container.
 - f) In the **Enter the message to display** field, enter `The calculator is running`.
 - g) Drag the **Window > Activate** action into the **If** container below the **Message box** action.
 - h) In the **Window** field, insert the `window-1` variable.
3. Insert an alternative sequence that opens the calculator.
 - a) Double-click the **If > Else** action.
 - b) Drag the **Message box** action into the **Else** container.
 - c) In the **Enter the message to display** field, enter `The calculator is not running`.
 - d) Drag the **Application > Open program/file** action into the **If** container below the **Message box** action.
 - e) In the **Location of the program/file** field, enter `C:\Windows\System32\calc.exe`.
4. Insert the **Simulate keystrokes** action to perform the calculation.
 - a) Drag the **Simulate keystrokes** action below the **If** and **Else** containers.
 - b) In the **Window** field, insert the `window-1` variable.
 - c) In the **Keystrokes** field, enter `5*5=`.
 - d) In the **Delay** field, enter `500`.
5. Click **Save** to save the bot.
6. Run the bot.

When the bot runs, the `The calculator is not running` message appears, then the Calculator window opens, and the calculation is performed.
7. Run the bot again.

When the bot runs, the `The calculator is running` message appears, then the Calculator window activates, and the calculation is performed.

If the bot does not input all of the numbers into the calculator, try increasing the keystrokes delay.

Example of extracting data from a web table

Build a bot to open a browser window to the Wikipedia website, extract the data from a table, and write it to a CSV file on your desktop. This example uses actions from the Browser, Data Table, Recorder, and Window packages.

To extract data from a table, do the following steps:

1. Create a new bot:
 - a) On the left panel, click **Automation**.
 - b) Click **Create new > Bot**.
 - c) In the **Create Task Bot** window, enter the bot name.
 - d) Accept the default folder location: `\Bots\`
To change the default bot storage location, click **Choose** and follow the prompts.
 - e) Click **Create and edit**.

For information about bot naming conventions, see [Create your first bot](#).

2. Open a browser window to the web page from which you will extract the table.
 - a) Double-click or drag the **Browser > Open** action.
 - b) Select your preferred browser.
 - c) In the `Link to open` field, enter `https://en.wikipedia.org/wiki/Table_(information)`.
 - d) Click **Save**.
 - e) Click **Run**.
The bot opens the window.
3. Specify the table.
 - a) Double-click or drag the **Recorder > Capture** action.
 - b) From the far-right panel, in the **Window** options, select the **Browser** tab and then select the **Table (information) - Wikipedia** window from the drop-down list.
If the window title does not appear in the list, click **Refresh**.
 - c) Click **Capture object**.
The **Table (information) - Wikipedia** window activates.
 - d) Hover over the Age table below the Basic description heading.
An orange box appears, surrounding the table.
 - e) Click the table.
The **Object Processing** message box appears.
 - f) Return to the Control Room.
 - g) In the Object properties table, verify the Control Type is TABLE.
If it is not, click **Recapture object**.
 - h) From the **Action to take on object** drop-down list, select **Get table**.
 - i) In the **Save the outcome to a variable** field, create the `Tabledata` variable.

The **Table (information) - Wikipedia** window is saved as the variable `window-1`.

4. Specify the file where to save the data.
 - a) Double-click or drag the **Data Table > Write to file** action.
 - b) From the **Data table name** list, select `Tabledata`.
 - c) Provide a file path to create a CSV file.
For example, `C:\Users\\Desktop\WikipediaTable.csv`.
 - d) Select the **Create folders/files if it doesn't exist** option.
 - e) Select to overwrite the existing file.
5. Close the **Table (information) - Wikipedia** window.
 - a) Double-click or drag the **Window > Close** action.
 - b) Select the **Variable** tab and insert `window-1`.
6. Click **Save**.
7. Click **Run**.
The bot creates a CSV file on the desktop with data on seven indexes, their values, and net change.

Examples of building bots

Use these example tasks to become familiar with the features and learn to build bots in Automation 360.

Example of entering data into a web form from a worksheet

In this example, you build a bot to enter multiple rows of data from an XLSX sheet into a web form. Use actions from the Excel advanced, Loop, and Recorder packages.

Before you start building the bot, you can create the following data sets on your desktop in `.xlsx` format as below.

Employee name	Age	Claim amount	Claim date	Claim type
Mike	30	469	22/3/2022	Medical
Sarah	34	766	28/3/2022	Dental
Chris	41	428	13/05/2022	Medical
Samantha	45	1000	09/05/2022	Medical

To retrieve values from an Excel file and input them into a web form, do the following:

1. Create a new bot:
 - a) On the left panel, click **Automation**.
 - b) Click **Create new > Bot**.
 - c) In the **Create Task Bot** window, enter the bot name.
 - d) Accept the default folder location: `\Bots\`
To change the default bot storage location, click **Choose** and follow the prompts.
 - e) Click **Create and edit**.

2. Open the Excel file.
 - a) Double-click or drag the **Excel advanced > Open** action.
 - b) Enter a session name.
 - c) Select the Excel file.
 - d) Mark the **Sheet contains a header** option.

By marking the **Sheet contains a header** option, you enable the bot to search for the column by the header name during run time.

3. Launch the website.
 - a) Double-click or drag the **Browser > Open** action.
 - b) Enter the website URL which consists the webform to update the data.
4. Retrieve the worksheet values and store them in a Table variable.
 - a) Double-click or drag the **Excel advanced > Get multiple cells** action.
 - b) Enter the same session name you used in the **Excel advanced > Open** action.
 - c) Select **All rows** from the drop-down list.
 - d) Create a Table variable using the icon to the right of the **Assign to variable** drop-down list.
5. Instruct the bot to process the data row by row.
 - a) Double-click or drag the **Loop** action.
 - b) Select the **For each row in table** iterator.
 - c) Select the same Table variable that you used in **Get multiple cells**.
 - d) Create a Record variable using the icon to the right of the **Assign to variable** drop-down list.

The Record variable holds all of the values for one row. With each iteration of the Loop, the bot retrieves the values of the next row and stores them in the Record variable, overwriting the values from the previous row.

6. Map the first column header to the web form textbox.
 - a) Double-click or drag the **Recorder > Capture** action.
 - b) Select the same window you opened with the **Open** action.
 - c) Click **Capture object**.
 - d) Hover over the textbox until a red outline appears.
 - e) Click the textbox.
 - f) Return to the Control Room.
 - g) Verify that the **Control Type** value is TEXTBOX.
 - h) Select **Set text** from the **Action** drop-down list.
 - i) In the **Keystrokes** field, insert the same Record variable that you used in the Loop.
 - j) Select the **By name** option and copy-paste the first column header into the field.

7. Repeat the sub-steps in step 5 to map the other columns, with the following differences:
 - a) Instead of searching for the browser window title, insert the Window variable generated by the Recorder.
 - b) When inserting the Record variable in the **Keystrokes** field, copy-paste the subsequent column header into the "By name" field.
8. Capture the Submit button.
 - a) Double-click or drag the **Recorder > Capture** action.
 - b) Insert the Window variable generated by the Recorder.
 - c) Click **Capture object**.
 - d) Verify that the **Control Type** value is BUTTON.
 - e) Select the **Click** action.
9. Click **Save**.

Related reference

[Excel advanced package](#)

The Excel advanced package contains actions that enable you to automate many of the repetitive tasks when working with Microsoft Excel spreadsheets.

[Loop package](#)

Use the Loop package to run a sequence of actions repeatedly for a specific number of times or until a specific condition is met.

[Recorder package](#)

Recorder package captures a series of tasks in a process and then automates them. You can automate your business applications (for example, desktop, Web, SAP, and Java applications) using the Recorder to capture actions performed on application objects such as a text box, button, table, radio button, combo box, and list view.

Example of passing a value between bots

Learn how to pass a value from one TaskBot to another by using a dictionary variable.

Build a parent TaskBot and a child TaskBot that do the following:

- The parent bot prompts the user to enter a song title and passes it to the child bot.
- The child bot takes the input string and returns a new string to the parent bot.
- The parent bot receives the string that the child bot passes as a dictionary.

1. Build a child bot.
 - a) From the Control Room interface, select **Bots > My bots**.
 - b) Click **Create New > Bot**.
 - c) Enter the name for the bot as `GetSongDetails`.
 - d) Click **Create and Edit**.

2. Create a variable named *sMySong*.
 - a) In the **Variables** panel, click the Create variable button.
 - b) In **Type**, select **String** if it is not already selected.
 - c) In **Name**, enter *sMySong*.
 - d) Select the **Use as input** and **Use as output** check boxes.
 - e) Click **Create**.

3. To build a return string, use the **String > Assign** action.
 - a) From the **Actions** panel, find the **String > Assign** action, and add it to the child bot flow.
 - b) In **Select the source string variable(s)/ value**, enter `I love $sMySong$ too!`.
During runtime, `$sMySong$` in the output string will be replaced with the value that the parent bot passes to the child bot.
 - c) In **Select the destination string variable**, select *sMySong* to store the new string.
 - d) Click **Save**.

4. Build the parent bot.
 - a) On the left panel, click **Automation**.
A list of available bots and forms is displayed.
 - b) Click **Create New > Bot**.
 - c) Enter the name for the bot as `FavoriteSong-Parent`
 - d) Click **Create and Edit**.

5. Create a variable named *sMySong*.
6. Use the **Prompt > For value** action to capture a song title.
 - a) From the **Actions** panel, find and add the **Prompt > for value** action to the parent bot flow.
 - b) In the **Prompt window caption** field, enter `Favorite Song`.
 - c) In the **Prompt message** field, enter `Type the title of your favorite song`.
 - d) In the **Assign the value to a variable** field, enter *sMySong*.
 - e) Click **Save**.

7. Use the **Task Bot > Run** action to call the child bot:
 - a) From the **Actions** panel, find and add the **Task Bot > Run** action to the parent bot flow.
 - b) In **Task Bot to run**, select **Control Room** and then click **Choose**.
 - c) Click **Browse** and navigate to the folder that contains the child bot and select `GetSongDetails`.
 - d) In **Input values**, select **Set sMySong** and then enter `$sMySong$` in the variable field.
 - e) In **Save the outcome to a variable (option)**, select **Dictionary** and then create a variable named **dOutput**.
 - f) Click **Save**.

8. Use the **Message box** action to display the string that the child bot returns.
 - a) From the **Actions** panel, find and add the **Message box > Message box** action to the parent bot flow.
 - b) In **Enter the message box window title**, enter `Automation Anywhere Enterprise Client`.
 - c) In **Enter the message to display**, enter `$dOutput{sMySong}$`.
The name of the output variable that the child bot uses is used as the key for retrieving the value from the dictionary variable.
 - d) Click **Save**.

9. Test the bot.
 - a) Click **Run** to run the bot.
After bot is deployed, the **Favorite Song** input box opens.
 - b) In the **Favorite Song** input box, enter a song title.
 - c) Click **OK**.
A message box should display the string that the child bot returns. If no value returns, then review the procedure to assign the incoming value to a dictionary key and a variable.

Related reference

[Dictionary package](#)

The **Dictionary** package contains actions that enable you to do various operations on dictionary-type values.

Example of using a conditional statement

In this example, you build a bot that prints a message based on whether a cell has a value or is empty. Use the actions from the Excel basic or Excel advanced, If, and Message Box packages.

Before building this bot, save an empty Excel worksheet to the desktop.

Because this bot does not create a new Excel worksheet, you can use either the Excel basic or Excel advanced packages.

Note: All of the actions must be from the same package.

1. Open a new bot.
 - a) On the left panel, click **Automation**.
A list of available bots and forms is displayed.
 - b) Click **Create new > Bot**.
 - c) Enter a bot name and click **Create and edit**.

2. Use the **Open** action from the Excel basic or the Excel advanced package to open the Excel sheet.
 - a) Double-click or drag the **Open** action.
 - b) Enter a session name.
 - c) Click **Browse** to provide the file path to the empty Excel worksheet on the desktop.

3. Use the **Get single cell** action to assign the value of a cell to a string variable.
 - a) Double-click or drag the **Get single cell** action from the same package that you used for the **Open** action.
 - b) Provide the session name that you used in the **Open** action.
 - c) Select the **Active cell** option.
 - d) In the **Store cell contents to** field, create the variable `Output`.
4. Use the **If** action to configure the conditional statement.
 - a) Double-click or drag the **If** action.
 - b) Select **String** from the **Condition** drop-down list.
 - c) In the **Source value** field, insert the variable `Output`.
 - d) Select **Equals to** as the **Operator**.
 - e) Leave the **Target value** field empty.
5. Insert a Message box into the **If** container.
 - a) Drag the **Message box** action.
 - b) In the **Enter the message to display** field, enter `Cell is empty`.
6. Use the **Else** and **Message box** actions to configure the alternative sequence of actions.
 - a) Drag the **Else** action next to the **If** action.
 - b) Drag the **Message box** action into the **Else** container.
 - c) In the **Enter the message to display** field, enter `Cell is not empty`.
7. Click **Save**.
8. Run the bot.

As the bot runs, the message box appears with the message `Cell is empty`.
9. Enter a value into the cell located at A1 in the Excel sheet and save the sheet.
10. Run the bot.

As the bot runs, the message box appears with the message `Cell is not empty`.

Related reference

[Excel advanced package](#)

The Excel advanced package contains actions that enable you to automate many of the repetitive tasks when working with Microsoft Excel spreadsheets.

[If package](#)

Use the actions in the **If** package to control the sequence of execution based on one or more conditions of a task.

[Message box package](#)

Use the **Message box** action from the **Message box** package to insert a message box that shows a message when the task runs. For example, you can insert a **Message Box** action to follow a web form so that the action displays the message: `Web Form Filled and Complete`.

Example of using Python script to join a list

Build a bot that uses a Python function to print the message `Go Be Great!`, the Automation Anywhere version of `Hello World`. In this example, the bot combines a list of string values and prints them to a message box.

To run Python script from Automation 360, you must already have the latest version of Python 3.x installed on your device.

1. Create a new bot:
 - a) On the left panel, click **Automation**.
 - b) Click **Create new > Bot**.
 - c) In the **Create Task Bot** window, enter the bot name.
 - d) Accept the default folder location: `\Bots\`
To change the default bot storage location, click **Choose** and follow the prompts.
 - e) Click **Create and edit**.
2. Create a variable to hold the list values:
 - a) Click the **Create variable** icon.
 - b) Enter `lArgument` in the **Name** field.

Recommendation: Prefix the variable name with a lowercase character to indicate the variable data type.

Variable naming

- c) Select the **List** type and **String** subtype.
 - d) In the **Default value** field, enter the following values:
 1. **Value at 0:** `Go`
 2. **Value at 1:** `Be`
 3. **Value at 2:** `Great`
 4. **Value at 3:** `!`
 - e) Click **Create**.
3. Provide the script with a **Python Script > Open** action:
 - a) Double-click or drag the **Python Script > Open**.
 - b) Select the **Manual input** option.
 - c) Copy and paste the following text into the **Enter script here** field.

```
def data ( str ):
    x = " ".join( str )
    return x
```

4. Use a **Python Script > Execute function** action to tell the bot to run the script:
 - a) Double-click or drag **Python Script > Execute function**.
 - b) Enter `data` in the **Enter name of function to be executed** field.
 - c) Select the **IArument** variable from the **Arguments to the function** drop-down list.
 - d) Create the variable `sOutput` for the **Assign the output to variable** field.
5. Insert a **Message box** action to hold the Python function output:
 - a) Double-click or drag the **Message box > Message box** action.
 - b) In the **Enter the message to display** field, select and insert the variable **sOutput**.
 - c) Select the **Close message box after** option. Retain the default value of 5 seconds in the field.
6. Close the script execution session with a **Python Script > Close** action:
 - a) Double-click or drag **Python Script > Close**.
 - b) Click **Save**.
7. Click the **Run** icon.

The bot generates a message box with the text `Go Be Great!`. After 5 seconds, the message box disappears.

To review the bot launcher logs, navigate to `C:\ProgramData\AutomationAnywhere\BotRunner\Logs\<current month>\Bot_Launcher-<today's date>.log.zip`. Each zipped folder contains a file with data on the code execution, which is useful for debugging.

Related reference

[Python Script package](#)

The **Python Script** package contains actions that enable Python Script functions in a task.

[Message box package](#)

Use the **Message box** action from the **Message box** package to insert a message box that shows a message when the task runs. For example, you can insert a **Message Box** action to follow a web form so that the action displays the message: `Web Form Filled and Complete`.

Example of using the DLL package

Build a very simple DLL that will generate a message. Create a bot to run the DLL.

This topic shows how to create a DLL package. If you do not have Microsoft Visual Studio, download the free Community version from [Microsoft Visual Studio Community IDE](#).

Create the DLL package.

1. In Microsoft Visual Studio, create a new class library that will generate a file type .dll by using C#.
 - a) Navigate to **File > New > Project**.
 - b) Search for `dll` in the **Search for templates** field.
 - c) Select the C# library option.
 - d) Configure your project as follows:
 - Project name: DemoDLL
 - Location: [Any]
 - Solution Name: DemoDLL
 - e) Click **Create**.
 - f) Copy the following code and replace the contents of `class1.cs` by pasting:

```
using System;
using System.Collections.Generic;
using System.Linq;
using System.Text;
using System.Threading.Tasks;

namespace DemoDLL
{
    public class CallMe
    {
        public string ImHere()
        {
            String Reply = "You are now inside the DemoDLL, ImHere
function!";
            return Reply;
        }
    }
}
```

- g) In **Solution Explorer**, right-click **Class1.cs** and rename it to "`CallMe.cs`".
- h) Navigate to **File > Save All**.
- i) Navigate to **Build > Build Solution**.
The output window confirms that the DLL package was successfully created and displays the path to your new `DemoDLL.dll` package in the **Output** window. Note the package location, as you will need it later to enter into the bot.

Create a bot to execute the DLL package.

2. Create a bot.
 - a) On the left panel, click **Automation**.
A list of available bots and forms is displayed.
 - b) Click **Create New > Bot**.
 - c) Provide a name for thebot: `MyDLLbot`
 - d) Enter the folder location: `Bots\TaskBotExample`
 - e) Click **Create and Edit**.
3. Create a variable: `sReturnedString`: string type.
Create a variable

4. Use a **DLL > Open** action to load your DLL package.
 - a) From the Actions pane, double-click or drag the **DLL > Open** action.
 - b) In the **DLL:Open, Filepath** field, select file type **Desktop file** and click **Browse** to find your DLL package. Click **Open**.
 - c) Click **Save**.
5. Use a **DLL > Run function** action to execute your DLL package.
 - a) Double-click or drag the **DLL > Run function** action to the last line of the bot.
 - b) Click **Get DLL Details**.
 - c) Select **Desktop file** type and then click **Browse**. Locate your DLL package and click **Open**.
 - d) Click **Next**.
 - e) Expand the `DemoDLL` namespace and select the **CallMe** function. Select method **ImHere** and click **Apply**.
 - f) In the **Assign the value to a variable** field, select `sReturnedString`.
6. Use a **Message box** action to report what was returned from the DLL bot:
 - a) Double-click or drag the **Message box** action to the last line of the bot.
 - b) In the **Enter the message to display** field, type: `From the DLL: "$sReturnedString$"`.
7. Click **Save**.
8. Use the **DLL > Close** action to end the DLL session.
 - a) Double-click or drag the **DLL > Close** action to the last line of the bot.
9. Click **Save**.
10. Click the **List** tab to view your code in text-only mode.

Your code should look like this:

```
Start
DLL:Open "C:\myFolder\source\repos\DemoDLL\DemoDLL\bin\Debug\DemoDLL.dll
for session "Default"
DLL:Run function "ImHere" and store output in variable $sReturnedString$
and session "Default"
MessageBox "From the DLL: "$sReturnedString$".
DLL:Close session "Default"
End
```

11. Run your bot.

The DLL package returns a message to the bot: **From the DLL: "You are now inside the DemoDLL, ImHere function!"**.

Related reference

[DLL package](#)

A dynamic-link library (DLL) file contains a shared library of functions that can be used by Windows programs. The **DLL** package uses a `.dll` file as reference and calls functions from the bot.

Example of transferring data from CSV file to Excel worksheet

In this example, you build a bot to update the product inventory in an Excel worksheet with new product names from a CSV file. Use actions from the CSV/TXT, Excel advanced, IF/ELSE, and Loop packages.

Before you start building the bot, create the following data sets on your desktop in the specified file formats:

Data set 1: ProductInventory.xlsx

Item number	Name	Count	Category	Unit price	Taxable
A0001	Milk	15	Grocery	3	N
A0002	Eggs	6	Grocery	4	N
A0003	Flower	3	Garden	10	Y
A0004	Table	1	Home	50	Y
A0005	Towel	4	Home	10	Y
A0006	Dog Food	16	Pet	22	N
A0007	Paint	43	Home	12	Y

Data set 2: NewProductNames.csv

Item number	Name
A0005	Hand Towel
A0002	Chicken Eggs
A0003	Sunflower
A0004	Coffee Table
A0006	Dog Food - Small Dogs
A0007	Paint - Dark Blue
A0001	2% Milk

In this example, you will build a bot to update the product inventory in an Excel worksheet with new product names from a CSV file. The Excel worksheet has old product names and the CSV file has new product names. You will relate the data in the Excel worksheet and the CSV file with item number and

update the Excel worksheet with the new item name corresponding to the item number. Use actions from the CSV/TXT, Excel advanced, IF/ELSE, and Loop packages

1. Create a new bot:
 - a) On the left panel, click **Automation**.
 - b) Click **Create new > Bot**.
 - c) In the **Create Task Bot** window, enter the bot name.
 - d) Accept the default folder location: `\Bots\`
To change the default bot storage location, click **Choose** and follow the prompts.
 - e) Click **Create and edit**.

2. Open the `NewProductNames.csv` file that you just created.
 - a) Double-click or drag the **CSV/TXT > Open** action.
 - b) In the **Session name** field, enter `session 1`.
 - c) Provide the file path to `NewProductNames.csv`.
 - d) Select the **Contains header** option.

3. Open the `ProductInventory.xlsx` file that you just created.
 - a) Double-click or drag the **Excel advanced > Open** action.
 - b) In the **Session name** field, enter `session 2`.
 - c) Provide the file path to `ProductInventory.xlsx`.
 - d) Choose to open the file in **Read-write** mode.
 - e) Select the **Contains header** option.

4. Use the **Go to cell** action to indicate the first cell in which to update the product names.
 - a) Double-click or drag the **Excel advanced > Go to cell** action.
 - b) In the **Session name** field, enter `session 2`.
 - c) Select the **Specific cell** option and enter `B2`.

5. Use a **Loop** action to retrieve the cell values in each row from `ProductInventory.xlsx`.
 - a) Double-click or drag the **Loop** action.
 - b) Select the **Excel Advanced > For each row in worksheet** iterator.
 - c) In the **Session name** field, enter `session 2`.
 - d) In the **Loop through** field, select **All rows**.
 - e) In the **Assign current value to this variable** field, create a `rInventory` variable.

6. Use a **Loop** action to retrieve the cell values in each row from `NewProductNames.csv`.
 - a) Drag the **Loop** action into the **For each row in worksheet Loop** container.
 - b) Select the **For each row in CSV/TXT** iterator.
 - c) In the **Session name** field, enter `session 1`.
 - d) In the **Assign current value to this variable** field, create a `rNewProduct` variable.

7. Use an **If** action to compare the item number from `ProductInventory.xlsx` to the item number from `NewProductNames.csv` to ensure they are the same before moving on to the next action.
 - a) Double-click or drag the **If** action into the **For each row in csv/txt Loop** container.
 - b) Select the **String** condition.
 - c) In the **Source value** field, input `rInventory[0]`.
 - d) Select the **Equals to (=)** operator.
 - e) In the **Target value** field, input `rNewProduct[0]`.

8. Use the **Set cell** and **Go to cell** actions to update the product name and move to the cell below.
 - a) Double-click or drag the **Excel Advanced > Set cell** action.
 - b) In the **Session name** field, enter `session 2`.
 - c) Select the **Active cell** option.
 - d) In the **Cell value** field, input `rNewProduct{Name}`
 - e) Double-click or drag the **Excel Advanced > Go to cell** action.
 - f) In the **Session name** field, enter `session 2`.
 - g) From the **Active cell** drop-down list, select **One cell below**.

9. Insert an alternative to the **If** action: if the item numbers are not the same, the bot continues to the next row in `NewProductNames.csv`.
 - a) Drag the **If > Else** action.
 - b) Drag the **Loop > Continue** action.

10. Close the files.
 - a) Double-click or drag the **Excel advanced > Close** action.
 - b) In the **Session name** field, enter `session 2`.
 - c) Select the **Save changes** option.
 - d) Double-click or drag the **CSV/TXT > Close** action.
 - e) In the **Session name** field, enter `session 1`.

11. Click **Save**.
12. Run the bot.

The bot updates the `ProductInventory.xlsx` file to look like the following table:

Data set 3: ProductInventory.xlsx

Item number	Name	Count	Category	Unit price	Taxable
A0001	2% Milk	15	Grocery	3	N
A0002	Chicken Eggs	6	Grocery	4	N
A0003	Sunflower	3	Garden	10	Y
A0004	Coffee Table	1	Home	50	Y
A0005	Hand Towel	4	Home	10	Y
A0006	Dog Food - Small Dogs	16	Pet	22	N

Item number	Name	Count	Category	Unit price	Taxable
A0007	Paint - Dark Blue	43	Home	12	Y

Related reference

[CSV/TXT package](#)

The **CSV/TXT** package contains actions that enable you to open a CSV or text file, read data from that file, and assign the data to a Table variable. This package supports files encoded in ANSI, Unicode, UTF-8, or Windows-1251, and can process up to one million records.

[Excel advanced package](#)

The Excel advanced package contains actions that enable you to automate many of the repetitive tasks when working with Microsoft Excel spreadsheets.

[If package](#)

Use the actions in the **If** package to control the sequence of execution based on one or more conditions of a task.

[Loop package](#)

Use the Loop package to run a sequence of actions repeatedly for a specific number of times or until a specific condition is met.

Run TaskBot to merge Excel sheets

Download and run sample TaskBot from the Bot Store to merge two spreadsheets.

Complete these requirements for using the example *TaskBot*:

- Microsoft Excel must reside on the Bot Runner device
- Automation 360 Build 4088 or later
- Excel Advanced package version 2.0.0-20200422-000103 or later
- Two spreadsheets as input: Both sheets must have common data within column A, such as a product or customer number

You can manually create the spreadsheets with columns similar to the following tables 1 and 2. Sheet 1 has columns to append to sheet 2 where a common value resides in column A. The bot expects the file locations and names to be `c:\bot_test\Spreadsheet1.xlsx` and `c:\bot_test\Spreadsheet2.xlsx`.

Table 1

Item Number	Name	Count	Category	Unit Price	Taxable	Backorder	Perishable	Locale
A0001	Milk	15	Grocery	3	N	Y	Y	US
A0005	Towel	4	Home	10	Y	N	N	US
A0006	Dog Food	16	Pet	22	N	N	N	US
A0007	Paint	43	Home	12	Y	N	N	IN

Table 2

Item Number	Name	Brand	Popular	Unit Price	TTS
A0001	Milk	Wholesome Foods	Y	3	1
A0002	Eggs	Dairy Love	Y	4	1
A0003	Flower	Spring Me Up!	N	10	3
A0004	Table	Woods Are Us	N	50	10
A0005	Towel	Claire Dane	N	10	6
A0006	Dog Food	Purina	Y	22	3
A0007	Paint	Color the World	N	12	2

1. Get the [Merge Excel Sheets Example](#) bot from the Bot Store.
The bot is automatically loaded to your Automation 360 On-Premises or Cloud environment.
You will receive an email with instructions for installing the bot in Automation 360 from the Bot Store.
2. Follow the instructions carefully. If you do not have the Bot Developer role assigned, contact your administrator to add the role.
3. If your spreadsheets are not located at `c:\bot_test\Spreadsheet1.xlsx` and `c:\bot_test\Spreadsheet2.xlsx`, update lines 5 and 9 of the bot with your desktop file location.
4. Run the TaskBot.
5. Update the TaskBot with any changes that reflect your use case, and make it your own.
You can also use the bot as a template for future Excel Advanced TaskBots by copying and saving it with a new name.

Related reference

[Excel advanced package](#)

The Excel advanced package contains actions that enable you to automate many of the repetitive tasks when working with Microsoft Excel spreadsheets.

Example of migrating data from Excel to a database

In this example, you build a bot to transfer values from an Excel spreadsheet to a database using actions from the Database, Excel advanced, and Loop packages.

Before you start building your bot, create the following:

- Create an Excel spreadsheet with the following values and save it (For example: *Test_migration_db.xlsx*)

John	Williams	jwilliams@cmail.com
Sam	Li	sam.li@xyz.org

Carl	Miller	carl@carlmillerllc.com
------	--------	------------------------

	A	B	C	D	E	F
1	John	Williams	jwilliams@email.com			
2	Sam	Li	sam.li@xyz.com			
3	Carl	Miller	carl@carlmillerllc.com			

- Create an Access database table named *CustomerT* with the following columns: (create a database similar to the image below and save it - for example: save it as *Test_Migration_db.accdb*)

- FirstName
- LastName
- Email

ID	FirstName	LastName	Email	Click to Add
[New]				

To migrate values from a spreadsheet to a table in a database, perform the following steps:

1. Create a new bot:

- On the left panel, click **Automation**.
- Click **Create new > Bot**.
- In the **Create Task Bot** window, enter the bot name.
- Accept the default folder location: `\Bots\`
To change the default bot storage location, click **Choose** and follow the prompts.
- Click **Create and edit**.

2. Open the spreadsheet:

- Double-click or drag the **Excel advanced > Open** action .
- Click **Browse** to provide the file path.

The screenshot shows a flowchart with three steps: 1. Start, 2. Excel advanced: Open (C:\Temp\Test_migration_db...), 3. Database: Connect (to Microsoft Access in session...). The configuration panel for 'Excel advanced: Open' is open, showing options for file path, sheet headers, sheet names, and open mode (Read-only mode or Read-write mode). The 'Read-write mode' option is selected.

- Select the option to open the file in **Read-write**.

3. Connect to the database:

- a) Double-click or drag the **Database > Connect** action.
- b) Select the **User defined** connection mode.

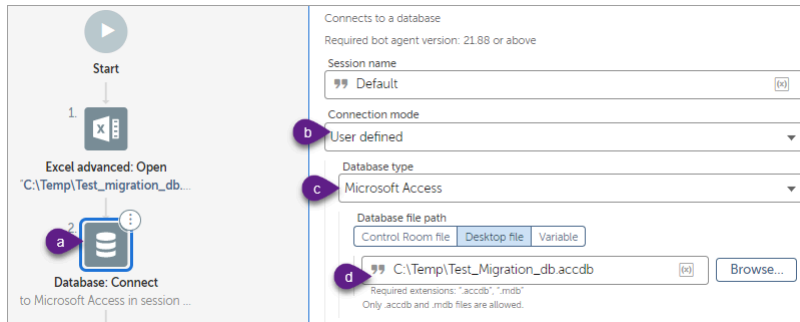

- c) Select the **Microsoft Access** database type.
- d) Click **Browse** to provide the file path.

4. Insert the Excel values into the database, row by row:
 - a) Double-click or drag the **Loop** action.
 - b) Select the **Excel advanced > For each row in worksheet** iterator.
 - c) Select **All rows** from the **Loop through** drop-down.

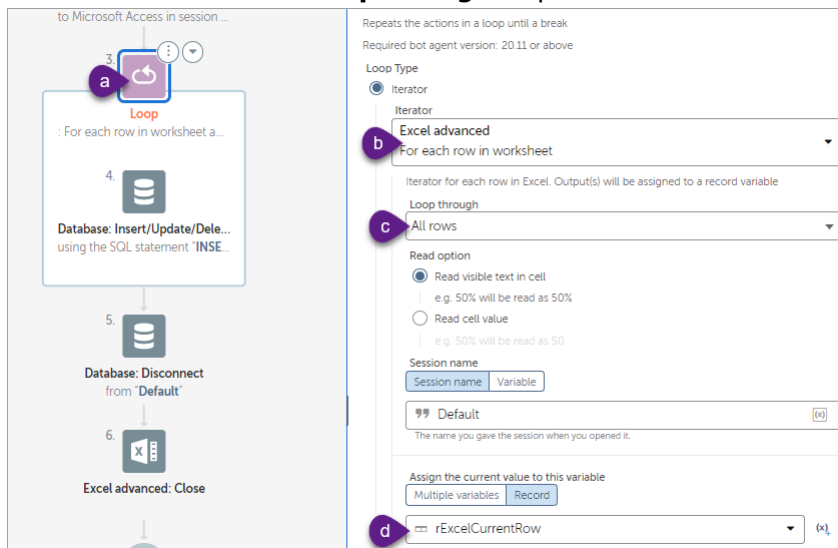

- d) In the Assign the current value to this variable, create the record variable `rExcelCurrentRow`.
- e) Drag the **Database > Insert/Update/Delete** action into the Loop container.
- f) Enter the following SQL statement:

```
INSERT INTO CustomerT (FirstName,LastName,Email) values
('{$rExcelCurrentRow[0]}','{$rExcelCurrentRow[1]}','{$rExcelCurrentRow[2]}');
```

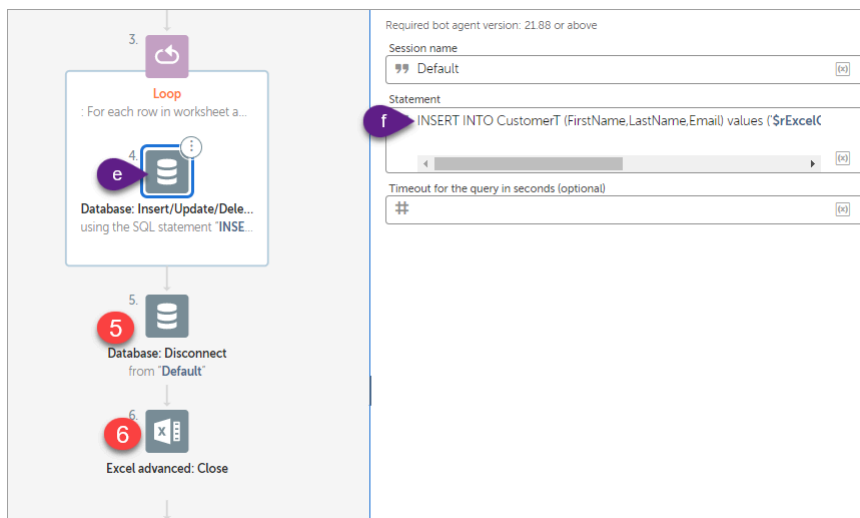

5. Disconnect from the database. Drag the **Database > Disconnect** action below the Loop container.
6. Close the spreadsheet. Double-click or drag **Excel advanced > Close Spreadsheet** action.
7. Click **Save**.

Related reference

[Database package](#)

Databases support internal operations of an enterprise by storing a variety of data, such as sales transactions, product catalogs, inventories, and customer profiles. Use the Database package to connect to a database, begin a transaction, and manipulate the stored data by retrieving, inserting, updating, deleting, and exporting it to a CSV file.

Excel advanced package

The Excel advanced package contains actions that enable you to automate many of the repetitive tasks when working with Microsoft Excel spreadsheets.

Loop package

Use the Loop package to run a sequence of actions repeatedly for a specific number of times or until a specific condition is met.

Example of using the Run action

The **Run** action from the TaskBot package enables you to run and pass values to one or more child bots. In this example, you use the **Run** action to pass two values from a parent bot to the child bot; the child bot adds the values and passes the sum back to the parent bot.

This example demonstrates the following:

Modularization

Modularization separates a TaskBot into several bots, where each bot is built with all the actions necessary to perform one specific function of the greater task.

In this example, you build a single child bot to add the values. You can build several child bots, with each performing a different mathematical operation, and edit the parent bot to call whichever one you want to use.

Reusability

Reusability enables the user to build a bot once, and then use that bot to automate many processes.

The child bot contains only the actions necessary to add the values and print them to a Message Box. Also, the bot adds two variables instead of hard-coded values. As a result, this bot can be reused for any task that involves an addition operation.

Data control

Because the child bot accepts and returns values only through the use of variables, it does not hold data. This minimizes the chance of data leakage.

To run a TaskBot from the current task, perform these steps:

Build the child bot.

1. Open a new bot.
 - a) On the left panel, click **Automation**.
A list of available bots and forms is displayed.
 - b) Click **Create a bot**.
 - c) Enter the bot name `AddChildBot`.
 - d) Enter the folder location `Bots\TaskBotExample`.
To change where your bot is stored, click **Choose** and follow the prompts.
 - e) Click **Create and Edit**.

2. Create the following variables:
 - v1: number type; use as input
 - v2: number type; use as input
 - nSum: number type
 - sSum: string type; use as output

Create a variable

3. Use a **Number > Assign** action to perform the mathematical operation.
 - a) Double-click or drag the **Number > Assign** action.
 - b) In the **Select the source string variable/ value** field, enter the following expression: \$v1\$ + \$v2\$
 - c) Select nSum from the **Select destination number variable** list.
4. Use the **Number > To string** action to convert the value so it can be printed to a Message Box.
 - a) Double-click or drag the **Number > To string** action.
 - b) In the **Enter a number** field, enter the following expression: \$nSum\$
 - c) Select sSum from the **Assign output to variable** list.
5. Click **Save**.
6. Click **Close**.

Build the parent bot.

7. Open a new bot.
 - a) On the left panel, click **Automation**
A list of available bots and forms is displayed.
 - b) Click **Create a bot**.
 - c) Enter the bot name `MathBot`.
 - d) Enter the folder location `\Bots\TaskBotExample`.
To change where your bot is stored, click **Choose** and follow the prompts.
 - e) Click **Create and Edit**.
8. Create a Dictionary variable of Any subtype named `dSums` to accept the values passed from the child bot.
Use the Any subtype to enable the parent bot to accept String, Number, or Boolean type values.

9. Insert a **Task Bot > Run** action to specify the values for the mathematical operation and the output variable to hold the sum.
 - a) Double-click or drag the **Task Bot > Run** action.
 - b) Click **Browse** to navigate to `Bots\TaskBotExample\AddChildBot`.
 - c) Enter the following values in the **Input values** fields:
 - `v1: 12`
 - `v2: 54`
 - d) Select `dSums` from the **Assign output to variable** list.

Note: Use a Dictionary variable to hold the output of the **Run** action in order to make the parent bot more versatile. This way a parent bot can handle different child bots regardless of whether they return a single value or several values.

10. Use a Message Box to retrieve and print the sum.

The variable `sSum` retrieved from the child bot is a key in the Dictionary variable `dSums`.

Note: You must know the variable names from the child bot to extract them from the parent bot. The interface does not automatically import the variable names to the parent bot.

- a) Double-click or drag the **Message box** action.
- b) Enter `$dSums{sSum}$` in the **Message to display** field.

11. Click **Save**.

12. Click **Run**.

The bot runs and the Message Box appears containing the sum 66.

Related reference

[Task Bot package](#)

Use the **Run**, **Pause**, and **Stop** actions in the Task Bot package to manage running one or more child bots from a parent bot or with a third-party software using an API.

[Message box package](#)

Use the **Message box** action from the **Message box** package to insert a message box that shows a message when the task runs. For example, you can insert a **Message Box** action to follow a web form so that the action displays the message: `Web Form Filled and Complete`.

Example of using the SOAP web service action

Use the **SOAP web service** action to pass two numeric values and return the sum from an online calculator application.

To make a SOAP web services call, perform the following steps:

1. Double-click or drag the **SOAP web services** action.
2. Select a connection method:
 - To connect using a URI, enter the URI, for example, `http://www.dneonline.com/calculator.asmx?WSDL`.
 - To connect using a file, select a file from the Control Room or the Desktop, or insert a variable.

3. Optional: Enter the SOAP endpoint in the **Address location** field.

If you specify the address location, the bot uses it during execution; otherwise, the bot uses the address location from the WSDL file.

Note: If you are creating the SOAP URI manually and not using the **Build SOAP request** option, go to step [6](#).

4. Click **Build SOAP request**.

The **SOAP request** window appears, displaying the services and ports, with details about their operations and parameter.

5. In the **SOAP request** window, expand the service for which you want to view the list of ports. Click the required port to display the list of available operations. Select the required operation and click **Apply** to retrieve the operation details from the SOAP request.

If you use the **Build SOAP request** option, **Services, Port, Operation, and Operation parameters** fields are automatically populated with details based on the operation you selected. Go to step [10](#).

6. In the **Service** field, enter the service name.

This field identifies the collection of ports supported by the web service. It holds the `@service name` value for a SOAP web service call, for example, `Calculator`.

7. Optional: In the **Port** field, enter the endpoint to connect with.

If you do not specify a port, the bot will use the first port mentioned in the WSDL file based on the service selected. However, if that port is not supported by the SOAP web service, bot execution will fail.

This field holds the `@binding name` value for a SOAP web service call, for example, `CalculatorSoap`.

8. Select the **SOAP version** of the endpoint that you specified in the **Port** field.

Choose either **1.1** or **1.2**.

9. In the **Operation** field, enter the name of the service function for the endpoint that you specified in the **Port** field.

The bot execution fails if either of the following is true:

- The port mentioned in the port field does not have any operations.
- The operation mentioned in the SOAP request for the port is unavailable.

This field holds the `@operation name` value for a SOAP web service call, for example, `Add`.

10. Select **Operation parameters** or **Raw data parameters** to provide the parameter details.

Note: If you have selected **Build SOAP request**, the parameter details table in the **Operation** tab is automatically populated with the parameters of the selected operation. Provide values for these parameters. You can also add, edit, or delete the parameters for a particular operation.

- If you select **Operation parameters**, enter the name and value of each parameter. For example, enter the following values:
 - a. `intA` in the first **Name** field
 - b. `10` in the first **Value** field
 - c. `intB` in the second **Name** field
 - d. `20` in the second **Value** field
- If you choose **Raw data parameters**, select **Parameters** or **Credential parameters**.

- 11. Parameters:** You can use the credential values from the credential locker without exposing the credentials (username or password) in plain text in the raw data. To do so, you must first map the credential in the credential mapper and use the reference name in the raw data within curly braces. For example, in the raw data, you provided the password in plain text to authenticate to the server.

```
<aut:AuthHeader>
<aut>Password> abc@123</aut>Password>
</aut:AuthHeader>
```

To use the password from the credential locker, perform the following steps:

- a) Click **Add substitution**.

Enter the reference name, for example, `pwd`, in the **Name in XML** field. Select **Credential** to use a value available in the credential vault, **Variable** to use a credential variable, or **Insecure string** to manually specify the value you want to use.

For more information about credential vaults and how to use them, see [Credentials and lockers in the Credential Vault](#).

- b) Click **Add**

- c) Specify the reference in the raw data within curly braces, as follows:

```
<aut:AuthHeader>
<aut>Password>{{pwd}}</aut>Password>
</aut:AuthHeader>
```

The reference name `pwd` specified in raw data will substitute the corresponding value stored in the credential vault.

Ensure that you enter the reference name in the same format as specified in **Add substitution**. For example, if you have entered password as `pwd` in **Add substitution** and enter `password` as reference name in the raw data, when you run the bot, the bot will encounter an error.

- 12. Credential parameters:** If you want to enter raw data parameters as credential. You can choose **Credential** to use a value available in the Credential Vault or select **Variable** to use a credential variable or **Insecure string** to manually specify the value you want to use.

- 13.** Select **No Authentication** or **Basic** from the **Authentication Mode** list.

- If you select **No Authentication**, proceed to the next step.
- If you select **Basic**, enter your credentials.

- 14.** Optional: Provide a Client certificate by selecting a file from the Control Room or your desktop, or insert a variable.

- 15.** Optional: Provide custom headers.

- 16.** Optional: Provide a file to save the XML output.

- 17.** Select **Complete response** or **Selected response** to narrow the scope of the response.

- If you select **Complete response**, proceed to the next step.
- If you select **Selected response**, perform the following steps if you are creating the Xpath expression manually and not using the **Build Xpath** option.

- a. Provide the XPath expression. For example:

```
/*[local-name()='Envelope' and namespace-uri()='http://schemas.xmlsoap.org/soap/envelope/']/*[local-name()='Body' and namespace-uri()='http://schemas.xmlsoap.org/soap/envelope/']/*
*[local-name()='AddResponse' and namespace-uri()='http://
```

```
tempuri.org/']/*[local-name()='AddResult' and namespace-  
uri()='http://tempuri.org/']
```

- b. Select a section of the XML output: **Values**, **Inner XML**, or **Outer XML**.
- c. If you select the option **Values**, choose return content as: **String delimited by** or **List of strings**.
 - If you select **String delimited by**, choose a delimiter option: **Pipe**, **Semicolon**, or **Custom**.
If you select **Custom**, enter variables or characters in the **Custom Delimiter** (optional) field.

Note: The special character dollar sign (\$) as delimiter is not supported.

- Select **List of strings** to return the output of the soap response as list of strings.
-

Note: You can only specify a list type of variable with data type as strings.

18. Click **Build Xpath**.

The Output preview window appears.

19. Select the appropriate node from the response body. The XML path is automatically created. Click **Apply**.

If you use the **Build Xpath** option, **XPath expression** and **Value** fields are automatically populated with details based on the operation you selected.

20. Optional: To set a time-out value when you send a SOAP request and receive a response, in the **Wait for action to complete** field, specify the wait time (in milliseconds).

By default, the wait time is 60000 milliseconds.

21. Configure the P12 certificate:

- To get the SSL certification file, select one of the following options: **Control Room file**, **Desktop file**, or **Variable**
- Configure the Keystore properties:
 - **Keystore file (Optional)**: To provide the keystore file in .p12 format, select one of the following options: **Control Room file**, **Desktop file**, or **Variable**. The keystore file includes the client's private key and certificate.
 - **Keystore password (Optional)**: To provide the password for the keystore file, select one of the following options: **Credential**, **Variable**, or **Insecure string**. The password is used to access the keystore file.

22. Select a variable to store the XML output.

For example, *prompt-assignment*

23. Verify the output of the **SOAP web service** action by inserting a **Message box** action with the variable *prompt-assignment* in the body message.

When you run the bot, the message box should show 30.

Related reference

[SOAP Web Service package](#)

Use the **SOAP web service** action from the SOAP Web Service package to access and exchange information between two systems in XML format.

Example of using Get structure command from SAP BAPI package

Using the SAP BAPI package, build a bot that inputs a structure to get data.

Download the SAP Java connector and DLL from the SAP website.

In this tutorial, you will build a bot that invokes BAPI_FLIGHT_GETLIST from the SAP demo Flight Data application. When executed, the bot calls the BAPI function by inputting an airline ID and destination details, gets a list of flights, and writes the response data to a CSV file.

You will use the following import parameters to limit your search:

- AIRLINE: Use the parameter to pass the airline ID.
- DESTINATION_FROM: Use the parameter to get the structure and pass the city name and airport ID.

The tutorial is intended to demonstrate how to perform the following actions:

- Get the structure of an import parameter.
- Set the values for the fields in the retrieved structure.
- Get response data in a table based on the input data.

1. Create a TaskBot named SAP-BAPI-FlightListReport.

- Log in to Control Room.
- On the left pane, click **Automation**.
- Click the **Create a bot** icon.
- In the **Name** field, enter SAP-BAPI-FlightListReport, and click **Create & Edit**.

2. To connect the bot to your SAP system, from the **Actions** panel, find **SAP BAPI > Connect** action and add it to the bot.

- In **JCo: SAP Java Connector package**, specify the path to the Java connector .jar file.
- In **JCo DLL dependency**, specify the path to the DLL file.
- Choose **Custom Application Server** as **Connection Type**.
- In **Application server host name**, specify the host name of the SAP application server.

Note: As a best practice, use the `*****` to specify sensitive information such as host name, user name, and password.

- In **System number**, enter the instance number.
- In **SAP instance system ID**, enter the system ID.
- In **Client number**, enter the client number.
- In **Logon language code**, enter **EN** or the language specific to your system.
- In **Router string**, enter the SAP router string.
- In **Username**, enter your SAP user name.
- In **Password**, enter your password.
- Run the bot to test the connection.

If the specified connection properties are correct, the bot is executed successfully.

3. To create a function, add the **SAP BAPI > Create function** action.
 - a) In **Function alias name**, enter `getFlightListByAirline`.
 - b) In **BAPI name**, enter `BAPI_FLIGHT_GETLIST`.
4. To filter the data by an airline name, add the **SAP BAPI > Set field value** action.
 - a) In **Function alias name**, enter `getFlightListByAirline`.
 - b) Click the **Function** tab.
 - c) In **Field name**, enter `AIRLINE` as the input parameter name.
 - d) In **Field value**, enter `AZ`.
5. To limit the selection by the airport and the destination city, get the structure of the `DESTINATION_FROM` import parameter first, and then set values for the fields in the retrieved structure. To do this, add the **SAP BAPI > Get structure** action.
 - a) In **Function alias name**, enter `getFlightListByAirline`.
 - b) In **Structure name**, enter `DESTINATION_FROM`.
 - c) To assign the retrieved structure to an alias, click the **Alias** tab in **Destination**, and enter `destinationFrom` in **Create structure alias**.
You can now use the alias to set values for the fields in the retrieved structure.
6. To set a value for the `AIRPORT ID` field in the `DESTINATION_FROM` parameter, add the **SAP BAPI > Set field value** action.
 - a) In **Function alias name**, enter `getFlightListByAirline`.
 - b) In **Source**, click the **Structure** tab.
 - c) In **Structure alias**, enter `destinationFrom`.
 - d) In **Field name**, enter `AIRPORTID`.
 - e) In **Field value**, enter `FCO`.
7. To set a value for the `CITY` field in the `DESTINATION_FROM` parameter, add the **SAP BAPI > Set field value** action.
 - a) In **Function alias name**, enter `getFlightListByAirline`.
 - b) In **Source**, click the **Structure** tab.
 - c) In **Structure alias**, enter `destinationFrom`.
 - d) In **Field name**, enter `CITY`.
 - e) In **Field value**, enter `ROME`.
8. To execute `BAPI_FLIGHT_GETLIST`, add the **SAP BAPI > Run function** action.
 - a) In **Function alias name**, enter `getFlightListByAirline`.
9. To get the filtered data from the `FLIGHT_LIST` table, add the **SAP BAPI > Get table** action.
 - a) In **Function alias name**, enter `getFlightListByAirline`.
 - b) In **Table name**, click the `FLIGHT_LIST` tab.
 - c) In **Destination**, click **Variable** to store the retrieved table data in memory.
 - d) In **Save the outcome to a variable**, create a variable named `tblFlightList` by clicking **(x)**.

10. To write the data from the retrieved table to a CSV file, add the **Data Table > Write to file** action.
 - a) In **Data table**, select `tblFlightList`.
 - b) In **Enter file name**, specify the path to the CSV file to which you want to write the data.
 - c) Select **Create folders/files if it doesn't exist**.
 - d) Click **Overwrite existing file**.
11. Save and then run the bot.

Example of writing data to SAP using SAP BAPI package

Using the SAP BAPI package, build a bot that writes data to the SAP database.

Download the SAP Java connector and DLL from the SAP website.

In this tutorial, you will build a bot that invokes `BAPI_FLCAST_CREATEFROMDATA` from the SAP demo Flight Data application. You will use the `CUSTOMER_DATA` import parameter to pass the customer data to the BAPI. When executed, the bot creates a new customer record in SAP database and displays the customer number returned by the BAPI.

The tutorial demonstrates how to perform the following actions:

- Use the Get structure command to set values for the import parameters.
- Create a new record in an SAP table.
- Receive a response from a BAPI.

1. Create a bot named `SAP-BAPI-CreateNewFlightCustomer`.
 - a) Log in to the Control Room.
 - b) On the left pane, click **Automation**.
 - c) Click the **Create a bot** icon.
 - d) In the **Name** field, enter `SAP-BAPI-CreateNewFlightCustomer`, and click **Create & Edit**.

2. To connect the to your SAP system, from the **Actions** panel, find **SAP BAPI > Connect** action and add it to the .
 - a) In **JCo: SAP Java Connector package**, specify the path to the Java connector .jar file.
 - b) In **JCo DLL dependency**, specify the path to the DLL file.
 - c) Choose **Custom Application Server** as **Connection Type**.
 - d) In **Application server host name**, specify the host name of the SAP application server.

Note: As a best practice, use the to specify sensitive information such as host name, user name, and password.

- e) In **System number**, enter the instance number.
 - f) In **SAP instance system ID**, enter the system ID.
 - g) In **Client number**, enter the client number.
 - h) In **Logon language code**, enter **EN** or the language specific to your system.
 - i) In **Router string**, enter the SAP router string.
 - j) In **Username**, enter your SAP user name.
 - k) In **Password**, enter your password.
 - l) Run the to test the connection.
If the specified connection properties are correct, the bot is executed successfully.
3. To create a function, add the **SAP BAPI > Create function** action.
 - a) In **Function alias name**, enter `createNewFlightCustomer`.
 - b) In **BAPI name**, enter `BAPI_FLCUST_CREATEFROMDATA`.
 4. Because the CUSTOMER_DATA parameter is of the type structure, get the structure of the import parameter and assign it to an alias. To do this, add the **SAP BAPI > Get structure** action.
 - a) In **Function alias name**, enter `createNewFlightCustomer`.
 - b) In **Structure name**, enter `CUSTOMER_DATA`.
 - c) To store the retrieved structure as an alias, click the **Alias** tab in **Destination**.
 - d) In **Create structure alias**, enter `CustomerData`.
You will use the alias to set values for the import field within the retrieved structure.
 5. To set the value for the CUSTNAME field, add the **SAP BAPI > Set field value** action.
 - a) In **Function alias name**, enter `createNewFlightCustomer`.
 - b) In **Source**, click the **Structure** tab.
 - c) In **Structure alias**, enter `CustomerData`.
 - d) In **Field name**, enter `CUSTNAME`.
 - e) In **Field value**, enter `John Doe`.
 6. Repeat Step 5 to add and configure the **Set field value** action for each of the following fields:

Field name	Field value
STREET	testStreet
POSTCODE	101001

Field name	Field value
CITY	testCity
COUNTR	US
COUNTR	00000000
EMAIL	test@example.com
CUSTTYPE	P

7. To execute `BAPI_FLCUST_CREATEFROMDATA`, add the **SAP BAPI > Run function** action.
 - a) In **Function alias name**, enter `createNewFlightCustomer`.

Note: If you want `BAPI_FLCUST_CREATEFROMDATA` to write the data to SAP database, you must select the **End sequence** and the **Commit transaction** options. If you select the **End sequence** option, ensure that you select the **Begin sequence** option in the **Create function** action.

The sample bot created with the help of this tutorial is intended to demonstrate how the `Create()` BAPIs work when the SAP BAPI package is used. It is not intended to modify the database.

The BAPI assigns and returns a customer number after a new customer record is created.

8. To get the number into a variable, add the **SAP BAPI > Get field value** action.
 - a) In **Function alias name**, enter `createNewFlightCustomer`.
 - b) In **Source**, click the **Function** tab.
 - c) In **Field name**, enter `CUSTOMERNUMBER`
 - d) In **Save the outcome to a variable**, create a variable named `strCustomerNumber` by clicking **(x)** and select the variable.
9. To display the customer number, add the **Message Box** action.
 - a) In **Enter the message to display**, select the `strCustomerNumber` variable.

10. Save and run the bot.

Example of using Run standard workflow from SAP BAPI package

Using the Run standard workflow action from the SAP BAPI package, build a bot that retrieves data from SAP systems.

Download the SAP Java connector and DLL from the SAP website.

In this tutorial, you will build a bot that uses the Run standard workflow action. The Run standard workflow action provides a user interface that enables you to select BAPIs and configure the parameters for the selected BAPI.

By using this single SAP BAPI package action, you will perform the following actions:

- Select a BAPI (`BAPI_FLIGHT_CHECKAVAILABILITY`) from a list of function modules available in the connected SAP system.
- Set values for the import and export parameters of the selected BAPI.
- Assign retrieved structure or tables to dictionary or table variables.

When executed, the bot gets flight availability data based on the input data, and writes it to a CSV file.

1. Create a bot named `SAP-BAPI-CheckFlightAvailability`.
 - a) Log in to the Control Room.
 - b) On the left pane, click **Automation**.
 - c) Click the **Create a bot** icon.
 - d) In the **Name** field, enter `SAP-BAPI-CheckFlightAvailability`, and click **Create & Edit**.

2. To connect the bot to your SAP system, from the **Actions** panel, find **SAP BAPI > Connect** action and add it to the bot.
 - a) In **JCo: SAP Java Connector package**, specify the path to the Java connector `.jar` file.
 - b) In **JCo DLL dependency**, specify the path to the DLL file.
 - c) Choose **Custom Application Server** as **Connection Type**.
 - d) In **Application server host name**, specify the host name of the SAP application server.

Note: As a best practice, use the bot to specify sensitive information such as host name, user name, and password.

 - e) In **System number**, enter the instance number.
 - f) In **SAP instance system ID**, enter the system ID.
 - g) In **Client number**, enter the client number.
 - h) In **Logon language code**, enter **EN** or the language specific to your system.
 - i) In **Router string**, enter the SAP router string.
 - j) In **Username**, enter your SAP user name.
 - k) In **Password**, enter your password.
 - l) Run the bot to test the connection.
If the specified connection properties are correct, the bot is executed successfully.

3. From the **Actions** panel, find **SAP BAPI > Run standard workflow** action after the **Connect** action.
4. Select a BAPI.
 - a) Click the **Select workflow** option.
 - b) In the **Standard BAPI Selector** window, from **Select Standard BAPI**, expand **SAP Modules**.
 - c) Find and expand **Flight with connection data (SAP training)**.
 - d) In **Flight with connection data (SAP training)**, expand **General > Create**, select **BAPI_FLIGHT_CHECKAVAILABILITY**, and then click **Select**.

5. Specify values for the fields in the import parameter. Do the following in **Import to BAPI**:
 - a) Click the vertical ellipsis option for the **AIRLINEID** field, and select **Edit**.
 - b) In **Value**, enter DL and click **Apply**.
 - c) Click the vertical ellipsis option for the **CONNECTIONID** field, and select **Edit**.
 - d) In **Value**, enter 1699 and click **Apply**.
 - e) Click the vertical ellipsis option for the **FLIGHTDATE** field, and select **Edit**.
 - f) In **Value**, enter 20170418 and click **Apply**.
The Java connector for SAP systems takes the date values in the yyyyymmdd format.

BAPI_FLIGHT_CHECKAVAILABILITY returns data in the AVAILABILITY export parameter, which is of the type structure.

6. In **Export to BAPI**, perform the following steps:
 - a) Click the ellipsis option for the **AVAILABILITY** field.
 - b) On the **Availability** window, select the **Field name** check box to select all fields within the structure, and then click **Apply**.
7. Store the data that the BAPI exports to a variable.
 - a) In **Save exported structures and scalars**, create a variable by clicking **(x)** and name it *ReturnStructure*.
8. In **Save exported structures and scalars**, create a variable by clicking **(x)** and name it *ReturnStructure*.
9. Save the **Run standard workflow** action.
10. Convert the exported data to a table.
 - a) From the **Actions** panel, find **Dictionary > Get** action, and add it after the **Run standard workflow** action.
 - b) Click inside **Dictionary variable** and select *ReturnStructure*.
 - c) In **Key**, enter AVAILABILITY.
 - d) In **Assign the output to variable**, create a variable by clicking **(x)** and name it *Availability*.
11. To write the data from the retrieved table to a CSV file, add the **Data Table > Write to file** action.
 - a) In **Data table**, select *Availability*.
 - b) In **Enter file name**, specify the path to the CSV file, to which you want to write the data.
 - c) Select **Create folders/files if it doesn't exist**.
 - d) Click **Overwrite existing file**.
12. Save and run the bot.

Example of using the VBScript package in a resilient bot

Build a bot that executes a Microsoft Visual Basic script. Use the Try/Catch package to gracefully end the bot if it fails, making it resilient to crashes. A resilient bot allows scheduled and queued bots to continue even if the current bot encounters an error.

In this bot, you ask the user to provide a number. The bot passes the number to a Microsoft Visual Basic script to multiply by pi and return the value. The bot then reports the result to the user. You can use the

VBScript action to either import an external script or type it directly into your bot. In this example, you manually type the script. You also add resiliency to the bot by adding error handling.

1. Create a bot:
 - a) On the left panel, click **Automation**.
A list of available bots and forms is displayed.
 - b) Click **Create New > Bot**.
 - c) Provide a name for the bot: `MultiplyPi`
 - d) Enter the folder location: `Bots\TaskBotExample`
 - e) Click **Create and Edit**.

2. Create a variable: `nPromptAnswer`:
 - Type: **Number**
 - Name: `nPromptAnswer`

Create a variable
3. Create a variable: `lNumbersForPi`:
 - Type: **List**
 - Subtype: **Number**
 - Name: `lNumbersForPi`
4. Click **Save**.
5. Use the **Prompt > For value** action to ask the user for a number.
 - a) Click the **Show** link on the Actions pane.
 - b) Double-click or drag the **Prompt For value** action to add it to the bot.
 - c) In the **Prompt window caption** field, type: `Any Number`
 - d) In the **Prompt message field**, type: `Enter any number to multiply by pi.`
 - e) In the **Assign the value to a variable** field, select **prompt-assignment**.
6. Click **Save**.
7. Use the **Error handler > Try** action to gracefully end the bot if there was an error, such as the user not entering a number.
 - a) Double-click or drag the **Error handler > Try** action.
 - b) Drag the **Prompt > For value** action under the **Error handler > Try** action.
8. Click **Save**.
9. Convert the **prompt-assignment** (string) to a number value.
 - a) Double-click or drag the **String > To number** action, adding it as the last line before the **Error handler: Catch** action.
 - b) In the **Enter the string** field, press F2 to open the list of your variables, and select **prompt-assignment**.
 - c) Click **Yes, insert**.
 - d) In the **Assign the output to variable** field, select **nPromptAnswer**.
10. Click **Save**.

11. Copy the number value to the first item in the list of numbers to pass to VBScript.
 - a) Double-click or drag the **List > Add item** action, adding it as the last line before the **Error handler: Catch** action.
 - b) In the **List variable** field, select **INumbersForPi**.
 - c) In the **Item to be added** field, select **nPromptAnswer**.

12. Click **Save**.

13. Use the **VBScript > Open** action to provide your Visual Basic source code.

- a) Double-click or drag the **VBScript Open** action, adding it as the last line before the **Error handler: Catch** action.
- b) In the **VBScript** options, select **Manual Input**.
- c) Copy the following code and paste it into the **Enter script here** field:

```
Dim Arg, var1, var2
Set Arg = WScript.Arguments
Function MultiplyPi(Arg)
    var1 = Arg(0)
    var2 = 3.14159
    MultiplyPi = cdbl(var1)*var2
End Function
```

14. Click **Save**.

15. Use the **VBScript > Run function** action to execute the script.

- a) Double-click or drag the **VBScript Run function** action, adding it as the last line before the **Error handler: Catch** action.
- b) In the **Enter the name of the function to be executed (optional)** type `MultiplyPi`.
- c) In the **Parameters (optional)** field, select **INumbersForPi** variable.
- d) In the **Assign the output to variable (optional)** field, select **prompt-assignment**.

16. Click **Save**.

17. Use the **VBScript > Close** action to end the session.

- a) Double-click or drag the **VBScript Close** action, adding it as the last line before the **Error handler: Catch** action.

18. Click **Save**.

19. Print the answer generated in the VBScript on the screen.

- a) Double-click or drag the **Message box** action, adding it as the last line before the **Error handler: Catch** action.
- b) In the **Enter the message to display** field, type `Pi times your number is:` , then press F2 to open the list of your variables. Select **prompt-assignment**.
- c) Click **Yes, insert**.

20. Click **Save**.

21. Notify the user if an error occurred and end the bot gracefully.
 - a) Click the **Error handler: Catch AllErrors** action once so that it is highlighted in your bot.
 - b) Double-click or drag the **Message box** action to insert it as the last bot action.
 - c) In the **Enter the message to display** field, type Bot failed. Please be sure to enter only numbers..
22. Click **Save**.
23. Click the **List** tab to view your code as text only.
Your code should look like this:

```

Start
Error handler: Try
  Prompt: For value during bot execution and assign the value $prompt-assignment$
  String: To number Convert string $prompt-assignment$ to a number and assign it to number variable $nPromptAnswer$
  List: Add item $nPromptAnswer$ to $lNumbersForPi$
  VBScript: Open VBScript manual script of 7 lines
  VBScript: Run function "MultiplyPi"
  VBScript: Close VBScript "Default"
  Message box "Pi times your number is: $prompt-assignment$"
Error handler: Catch AllErrors
  Message box "Bot failed. Please be sure to enter only numbers."
End

```

24. Run your bot.
25. When the bot runs successfully, a message box displays the calculated number. View the message and click **Close**. You can test the resiliency of your bot by running the bot again and entering a letter instead of a number.

Related reference

[VBScript package](#)

The **VBScript** package contains actions that enable VBScript functions in a task.

Build a Bot Insight dashboard bot

In this example, you build a bot that retrieves data from a website to create visualizations in Bot Insight.

Configure an empty string variable named `sNull`.

Create a variable

1. Create a new bot:
 - a) On the left panel, click **Automation**.
 - b) Click **Create new > Bot**.
 - c) In the **Create Task Bot** window, enter the bot name.
 - d) Accept the default folder location: `\Bots\`
To change the default bot storage location, click **Choose** and follow the prompts.
 - e) Click **Create and edit**.

2. Open a browser window to the web page from which you want to extract the table.
 - a) Double-click or drag the **Browser > Launch website** action.
 - b) In the URL field, enter `https://www.statista.com/statistics/183483/ranking-of-languages-spoken-at-home-in-the-us-in-2008/`.
 - c) Select the Internet Explorer browser.

Recommended: Use Microsoft Internet Explorer because it reliably launches the website in a new window, even if another window is already open. Other browsers might launch the website in a new tab if there is an open window.

- d) Click **Save**.
 - e) Click **Run**.
The bot opens the window.
3. Select the table for extraction.
 - a) Double-click or drag the **Recorder > Capture** action.
 - b) Click the **Window** tab and select the **Languages spoken in the United States 2018 | Statista** window from the drop-down list.
If the window title does not appear in the list, click **Refresh**.
 - c) Click **Capture object**.
The **Languages spoken in the United States 2018 | Statista** window is activated.
 - d) Hover over the table until an orange box that surrounds the entire table appears.
 - e) Click the table.
 - f) Return to the Control Room.
 - g) In the Object properties table, verify the Control Type is TABLE.
If it is not, click **Recapture object**.
 - h) From the **Action** drop-down list, select **Get table**.
 - i) In the **Assign output to variable** field, create the `tLanguages` table variable.
4. Specify the file in which to save the data.
 - a) Double-click or drag the **Data Table > Write to file** action.
 - b) From the **Data table name** list, select **tLanguages**.
 - c) Provide a file path to create a CSV file.
For example, `C:\Users\\Desktop\LanguagesTable.csv`.
 - d) Select the **Create folders/files if it doesn't exist** option.
 - e) Select to overwrite the existing file.
5. Specify the file that holds the extracted data.
 - a) Double-click or drag the **CSV/TXT > Open** action.
 - b) Provide the file path to the file specified in step 4.
 - c) Select the **Contains header** option to exclude the first row.

6. Iterate through each row of the file.
 - a) Double-click or drag the **Loop** action.
 - b) Select the **For each row in CSV/TXT** iterator.
 - c) In the **Assign the current row to this variable** field, create the variable `rCurrentRow`.

7. Specify the data to populate the Bot Insight dashboard.
 - a) Double-click or drag the **Analyze > Open** action.
 - b) Double-click or drag the **String > Assign** action.
 - c) Enter `$rCurrentRow[0]$` as the source string.
Press F2 to open the variables menu.
 - d) In the **Select destination string variable** field, create the variable `sLanguage`.
 - e) Double-click or drag the **String > Replace** action.
The extracted data uses commas to separate digits. You must remove the commas before you can convert the string to a number data type to use in Bot Insight.
 - f) Enter `$rCurrentRow[1]$` as the source string.
Press F2 to open the variables menu.
 - g) Enter `,` in the **Find string** field.
 - h) Select the **Not a regular expression** option.
 - i) In the **Replace with** field, enter `$sNull$`.
 - j) In the **Assign the output row to variable** field, create the variable `sPopulation`.
 - k) Double-click or drag the **String > To number** action.
 - l) Enter the `$sPopulation$` variable.
 - m) In the **Assign the output row to variable** field, create the variable `nPopulation`.
 - n) Double-click or drag the **Analyze > Close** action.
 - o) Select the following variables:
 - **sLanguage**
 - **nPopulation**

8. Click **Save** and then **Run**.
9. Click **Analyze**.
The Bot Insight window appears.

Learn more about dashboards.

[Bot Insight dashboards](#)

Related reference

[Analyze package](#)

Use the actions in the **Analyze** package to specify the actions and variables to use in the Bot Insight dashboard and widgets. The **Analyze** package enables you to perform transactional analytics for the data that is logged by the variables when the bot runs.

[Browser package](#)

The **Browser** package contains actions that enable you to download files, find broken links, and launch a website. This package supports Google Chrome, Chromium-based Microsoft Edge, and Internet Explorer browsers.

[Recorder package](#)

Recorder package captures a series of tasks in a process and then automates them. You can automate your business applications (for example, desktop, Web, SAP, and Java applications) using the Recorder to capture actions performed on application objects such as a text box, button, table, radio button, combo box, and list view.

[Data Table package](#)

The Data Table package contains actions that enable you to perform various operations on the values of table variables. Use these actions to join or merge content, search for specific values, insert rows and columns, remove duplicate rows, and write values to a file.

[CSV/TXT package](#)

The **CSV/TXT** package contains actions that enable you to open a CSV or text file, read data from that file, and assign the data to a Table variable. This package supports files encoded in ANSI, Unicode, UTF-8, or Windows-1251, and can process up to one million records.

[Loop package](#)

Use the Loop package to run a sequence of actions repeatedly for a specific number of times or until a specific condition is met.

Example of using multiple analyze actions in a task

Build a bot that uses multiple **Open** and **Close** Analyze actions in a task to analyze and compare the sales data for each quarter of XYZ Company, and create visualizations in Bot Insight.

Before you start building the bot, create the following data set on your desktop in the .csv file format.

PRODC	PRODC	COUNTR	QUANTI' ORDERE QTR1	SALES_ C	QUANTI' ORDERE QTR2	SALES_ C	QUANTI' ORDERE QTR3	SALES_ C	QUANTI' ORDERE QTR4	SALES_ QTR4
S18_136	Wintage Cars	USA	39	4808.31	21	2856	50	5907.5	48	4389.12
S18_136	Wintage Cars	Germany	33	3288.78	42	2262.96	30	1746.6	25	2183.25
S18_136	Wintage Cars	France	41	2055.74	42	4431.84	34	5375.4	45	2304.45
S18_136	Wintage Cars	Australia	48	2354.88	33	3423.75	24	1496.64	32	1742.4
S18_136	Wintage Cars	UK	30	5151	36	3081.24	33	4950.33	29	5176.5
S18_136	Wintage Cars	India	50	3390	45	1702.8	23	4230.62	44	7554.8
S18_136	Wintage Cars	Japan	28	1801.24	22	995.5	47	6034.33	33	5890.5
S18_136	Wintage Cars	New Zealand	43	4818.15	29	1716.22	42	3958.5	27	1879.74
S18_136	Wintage Cars	Norway	39	4178.85	46	1528.58	34	3455.76	38	2323.7

PRODUC	PRODUC	COUNTR	QUANTI' ORDERE QTR1	SALES_ C	QUANTI' ORDERE QTR2	SALES_ C	QUANTI' ORDERE QTR3	SALES_ C	QUANTI' ORDERE QTR4	SALES_ QTR4
S18_136	Wintage Cars	Sweden	22	1903.22	-	-	24	1685.28	23	1643.12
S18_136	Wintage Cars	Spain	50	2490.5	-	-	29	1254.83	38	4299.7
S18_136	Wintage Cars	Canada	49	1689.03	-	-	36	1194.84	20	2212
S18_136	Wintage Cars	Austria	26	2253.68	-	-	49	2414.72	26	3206.32

1. Create a bot.
 - a) Log in to the Control Room as a Bot Creator.
 - b) On the left pane, click **Automation**.
A list of available bots and forms is displayed.
 - c) Click **Create new > Bot**.
 - d) Click **Create and edit**.

2. Open the `XYZ sales data.csv` file that you created.
 - a) Double-click or drag the **CSV/TXT > Open** action.
 - b) In the **Session name** field, enter `Session 1`.
 - c) Provide the file path to `XYZ company sales data.csv`.
 - d) Select the **Contains header** option to exclude the first row.

3. Create a **Record** variable as `Row` by using the **Create variable** icon.
The **Record** variable holds all the values for one row. With each iteration of the loop, the bot retrieves the values of the next row and stores them in the **Record** variable, overwriting the values from the previous row.

4. To retrieve the values in the cells from each row in the `XYZ company sales data.csv` file, use a **Loop** action.
 - a) Select **For each row in CSV/TXT iterator**.
 - b) In the **Session name** field, enter `Session 1`.
 - c) In the **Assign the current row to this variable** field, select the `Row` variable that you created.

5. Create the following variables for four quarters by using the **Create variable** icon at the top of the **Variables** menu.

- PRODUCTCODE
- PRODUCTLINE
- COUNTRY
- QUANTITYORDERED_QTR1
- SALES_QTR1
- QUANTITYORDERED_QTR2
- SALES_QTR2
- QUANTITYORDERED_QTR3
- SALES_QTR3
- QUANTITYORDERED_QTR4
- SALES_QTR4

6. Specify the data to populate on the Bot Insight business dashboard.

- a) Double-click or drag the **Analyze > Open** action.

Note: Ensure that you insert the Analyze **Open** and **Close** actions inside the **Loop** action to analyze and capture the data from each row in the Bot Insight dashboard.

- b) Double-click or drag the **String > Assign** action.

Press F2 to open the variables menu.

- c) Choose the `Row` variable from the drop-down list.

- d) Enter `PRODUCTCODE` and click **Yes, insert**.

- e) In the **Select destination string variable** field, choose the `PRODUCTCODE` variable.

To assign string variables for `PRODUCTLINE` and `COUNTRY`, repeat [Step 6b](#) through [Step 6e](#).

- f) Double-click or drag the **Number > Assign** action.

Press F2 to open the variables menu.

- g) Choose the `row` variable from the drop-down list.

- h) Enter `QUANTITYORDERED_QTR1` and click **Yes, insert**.

- i) In the **Select destination string variable** field, choose the `QUANTITYORDERED_QTR1` variable.

To assign number variables for `SALES_QTR1`, `QUANTITYORDERED_QTR2`, `SALES_QTR2`, `QUANTITYORDERED_QTR3`, `SALES_QTR3`, `QUANTITYORDERED_QTR4`, and `SALES_QTR4`, repeat [Step 6f](#) through [Step 6i](#).

- j) Double-click or drag the **Analyze > Close** action.

- k) Enter the **Transaction** name as `Quarters 1 and 2`.

- l) Select the following transactional variables in the **Close** action:

- `PRODUCTCODE`
- `PRODUCTLINE`
- `COUNTRY`
- `QUANTITYORDERED_QTR1`
- `SALES_QTR1`
- `QUANTITYORDERED_QTR2`
- `SALES_QTR2`

- m) Double-click or drag the **Analyze > Open** action.

- n) Double-click or drag the **Analyze > Close** action.

- o) Enter the **Transaction** name as `Quarters 3 and 4`.

- p) Select the following transactional variables in the **Close** action:

- `PRODUCTCODE`
- `PRODUCTLINE`
- `COUNTRY`
- `QUANTITYORDERED_QTR3`
- `SALES_QTR3`
- `QUANTITYORDERED_QTR4`
- `SALES_QTR4`

7. Click **Save** and then **Run**.

8. Click Analyze Task Bot.

The Bot Insight business dashboard appears.

9. Select the Preview option.

The sales data is displayed as follows:

Task Name: RZ company sales data analysis
Transaction Name: Quarter 1 and 2 Total Records: 13

sales_qtr1	productcode	sales_qtr1	quantityordered_qtr1	quantityordered_qtr2	productline	country
282.76	S1B_1367	338.75	310	410	Vintage Cars	Germany
0.0	S1B_1367	300.03	410	0.0	Vintage Cars	Canada
266.4	S1B_1367	400.0	310	20.0	Vintage Cars	USA
462.84	S1B_1367	200.74	410	410	Vintage Cars	France
365.76	S1B_1367	228.68	48.0	33.0	Vintage Cars	Austria
124.4	S1B_1367	336.2	34.0	48.0	Vintage Cars	India
46.1	S1B_1367	300.24	34.0	23.0	Vintage Cars	Japan
103.08	S1B_1367	410.0	34.0	41.0	Vintage Cars	France
346.24	S1B_1367	510.0	34.0	34.0	Vintage Cars	UK
176.0	S1B_1367	463.0	41.0	31.0	Vintage Cars	New Zealand

Transaction Name: Quarter 3 and 4 Total Records: 13

productcode	quantityordered_qtr3	sales_qtr3	sales_qtr4	quantityordered_qtr4	productline	country
S1B_1367	47.0	6054.33	5890.5	33.0	Vintage Cars	Japan
S1B_1367	24.0	1685.28	1643.12	23.0	Vintage Cars	Sweden
S1B_1367	50.0	5907.5	4389.12	48.0	Vintage Cars	USA
S1B_1367	24.0	1496.64	1742.4	32.0	Vintage Cars	Australia
S1B_1367	34.0	3455.76	2323.7	38.0	Vintage Cars	Norway
S1B_1367	23.0	4230.62	7554.8	44.0	Vintage Cars	India
S1B_1367	29.0	1254.83	4299.7	38.0	Vintage Cars	Spain
S1B_1367	36.0	1194.84	2232.0	20.0	Vintage Cars	Canada
S1B_1367	49.0	2414.72	3206.32	26.0	Vintage Cars	Austria
S1B_1367	30.0	1746.6	2183.25	25.0	Vintage Cars	Germany

Example of updating default package version across bots

In this example, learn how to perform a bulk update of existing bots in the Control Room repository to use the default version of the Excel advanced package.

To update bots to the default package version, ensure you have the **View packages permission** and the **permission to edit bots**. When you update bots to the default package version, all the bots using the Excel advanced package in the public workspace for which you have access will be updated to the default version.

Consider the scenario where there are three versions of the Excel advanced package (5.0.0XXXXXXX, 6.7.0XXXXXXX, and 6.8.0XXXXXXX), and the bots created initially are using the Excel default version of 6.7.0XXXXXXX. The default Excel advanced version has to be changed to 6.8.0XXXXXXX.

In this example, you set the default package version to 6.8.0XXXXXXX so that all public repository bots you have access to and which use the Excel advanced package are updated to use the default version 6.8.0 XXXXXXXX.

1. To update all the bots in the public repository that use Excel advanced package to version 6.8.0XXXXXXX, perform these steps:
 - a) Navigate to **Manage > Packages** .
 - b) Search for and open the Excel advanced package.
 - c) On the package page, click the **Version** field and choose the version 6.8.0XXXXXXX.
 - d) Click **Update bots to default version**.
 - e) On the **Update bots to default package version** window that opens, enter the following information:
 - **Activity name:** Update Package_Excel_MS_6.8.0.
 - **Description:** Bulk update of bots to set the default package version Excel_MS_6.8.0
 - **Check-in comments:** Update the Excel advanced package version with default version 6.8.0.
 - f) Click **Update Bots**.

The bots are checked out to set the package default version as 6.8.0XXXXXXX.

2. Navigate to **Administration > Audit log**.

3. On the **Audit log** page, search by event type and choose the value **Update default package**.

You can view information about the start of the requested process, individual bots that are being updated with the default package version, and the completion of the requested process.

a) Click the **Update default package to bot requested** item name and view the following information:

- **Request name:** UpdatePackage_Excel_MS_6.8.0 XXXXXXXX
- **What changed:** Package version
- **Package name:** Excel_MS
- **Package version:** 6.8.0XXXXXXXX

You can view all the bots that are updated to use the default package version 6.8.0XXXXXXXX.

b) Copy the **Request ID** , for example, b8bfa7bc58a784e4 from the **Update default package to bot requested** page.

c) On the **Audit log** page, search by filter **Request ID** and enter the value b8bfa7bc58a784e4. The **Audit log** page displays all the bots that are either successfully updated or those that failed the update process. See the following example image:

Request ID	Search
Request ID: b8bfa7bc58a784e4	X

Events (626 of 65483810)

Status	Time	Item name	Event type
Successful	08:29:51 IST 2022-06-17	FineTuneRoomDim037	Update default package
Successful	08:29:51 IST 2022-06-17	FineTuneRoomDim023	Update default package
Successful	08:29:51 IST 2022-06-17	FineTuneRoomDim278	Update default package
Successful	08:29:51 IST 2022-06-17	FineTuneRoomDim461	Update default package

d) Click any bot, for example, **FineTune RoomDim037** to view the following details:

- **Package name:** Excel_MS
- **Old package version:** 6.7.0XXXXXXXX
- **Target package version:** 6.8.0XXXXXXXX
- **Old bot version:** 2
- **New bot version:** 3

The bulk update process in this case takes approximately 13 minutes because the Control Room has 500 bots to update.

e) Click the item name **Update default package to bot completed** to view the following details:

- **Request name:** UpdatePackage_Excel_MS_6.8.0XXXXXXXX.
- **Successful bots:** 500
- **Unsuccessful bots:** 0
- **What changed:** Package version
- **Package name:** Excel_MS

- **Old package version:** N/A

Example of using JSON package actions in a bot

Build a bot that runs a JSON script with multiple records. In this example, we use a JSON file that contains a list of feeds from a blog, and the bot extracts the required information from the JSON file and prints it to a message box.

To run JSON script from Automation 360, you must already have the JSON data stored either as a variable or a file (.json, .txt format) on your desktop. The following screenshot displays the structure of a JSON object as a sample.

```
{
  "feeds": [
    {
      "id": 1090,
      "title": "Amsterdam Beaches",
      "description": "It's true that few people think of the Netherlands when planning a beach holiday. But whether you're just visiting or lucky enough to call this iconic city home, there are plenty of great beaches to enjoy in Amsterdam",
      "location": "Kloveniersburgwal 1, 1012 CW Amsterdam, Netherlands",
      "lng": 0,
      "lat": 0,
      "userId": 3043,
      "name": "Ritu singh",
      "isdeleted": false,
      "profilePicture": "/Images/userimageicon.png",
      "videoUrl": null,
      "images": null,
      "mediatype": 0,
      "imagePaths": null,
      "feedsComment": null,
      "commentCount": 3,
      "multiMedia": [
        {
          "id": 2157,
          "name": "beach of amsterdam.PNG",
          "description": null,
          "url": "feedsmedia/3043/c5522956-4ab5-408e-b540-16a8c90af9b0.PNG",
          "mediatype": 1,
          "likeCount": 0,
          "place": null,
          "createAt": "0001-01-01T00:00:00"
        }
      ],
      "likeDislike": {
        "likes": 2,
        "dislikes": 1,
        "userAction": 2
      },
      "createdAt": "2019-12-26T07:08:38.4659686",
      "code": 0,
      "msg": null
    }
  ],
}
```

```

    "totalFeed": 125
  }

```

1. Create a bot.
 - a) On the left panel, click **Automation**.
A list of available bots and forms is displayed.
 - b) Click **Create New > Bot**.
 - c) Provide a name for the bot: `JsonBot`.
 - d) Click **Create and Edit**.

2. Start a JSON session by using the **JSON > Start session** action.
 - a) From the **Actions** pane, double-click or drag the **JSON > Start session** action.
 - b) In the **Data Source** field, choose **File** and select the **Desktop file** file type. Click **Browse** to find your JSON file, for example, `D:\userdefined\My Downloads\Sample Json with 200 Records.json`.
 - c) To create a JSON session, from **Json object session**, select **Local session** and enter **Default** as the session name.

3. Create a variable: *SampleString*
 - **Type:** `String`
 - **Name:** `SampleString`

4. Retrieve the value of the total number of feeds from the JSON script by using the **JSON > Get node value** action.
 - a) From the **Actions** pane, double-click or drag the **JSON > Get node value** action.
 - b) In the **JSON node key or path** field, enter `totalFeed`.
 - c) In the **Session name** field, enter `Default`.
 - d) In the **Save the outcome to a variable** field, select *SampleString*.
 - e) To print the value of `totalFeed`, double-click or drag the **Message box** action.
 - f) To open the list of your variables, in the **Enter the message to display** field, press F2, and then select *SampleString*.
 - g) Click **Yes, insert**.

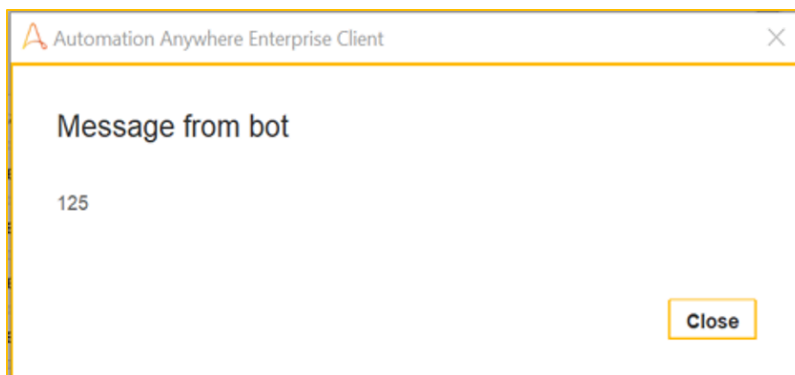

5. To retrieve any specific value from 125 feeds, perform the following steps.
 - a) From the **Actions** pane, double-click or drag the **JSON > Get node value** action.
 - b) In the **JSON node key or path** field, enter `feeds[52].title`.
 - c) In the **Session name** field, enter `Default`.
 - d) In the **Save the outcome to a variable** field, select `SampleString`.
 - e) To print the value of `feeds[52].title`, double-click or drag the **Message box** action.
 - f) To open the list of your variables, in the **Enter the message to display** field, press F2, and then select `SampleString`.
 - g) Click **Yes, insert**.

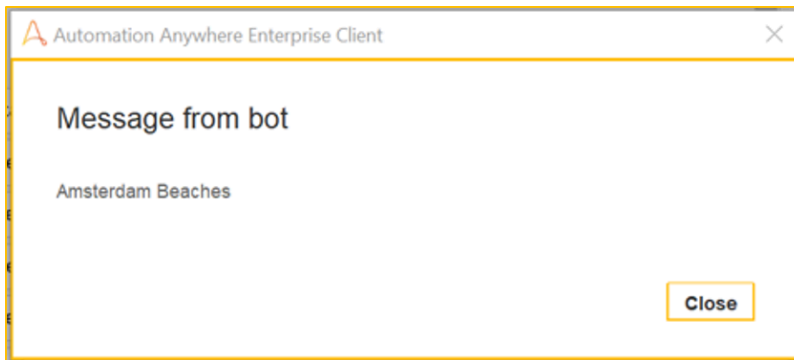

6. Create a variable: `StringList`
 - **Type:** `List`
 - **Subtype:** `String`
 - **Name:** `StringList`

7. To retrieve the list of child nodes from a node path, use the **JSON > Get node list** action.
 - a) From the **Actions** pane, double-click or drag the **JSON > Get node list** action.
 - b) In the **JSON node key or path** field, enter `feeds`.
 - c) In the **Session name** field, enter `Default`.
 - d) In the **Save the outcome to a variable** field, select `StringList`.
 - e) To print all the child nodes under the `feed 51` object, double-click or drag the **Message box** action.
 - f) To open the list of your variables, in the **Enter the message to display** field, press F2, and then select **StringList[51]**.
 - g) Click **Yes, insert**.

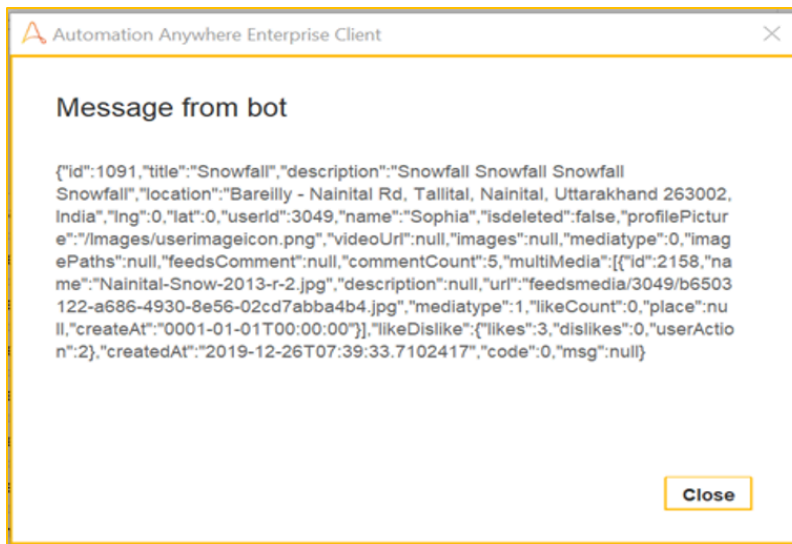

8. To close a JSON session, use **End session**. In the **Session name** field, enter `Default`.
9. Click **Save** and then click **Run**.
10. Start a new JSON session.
 - a) From the **Actions** pane, double-click or drag the **JSON > Start session** action. In the **Data Source** field, select **Text** and enter `StringList[52]`.
 - b) From **Json object session**, select **Local session** and enter `Default 1` as the session name.

11. To retrieve the value from a specific node, use **JSON > Get node value**.
 - a) From the **Actions** pane, double-click or drag the **JSON > Get node value** action.
 - b) In the **JSON node key or path** field, enter `description`.
 - c) In the **Session name** field, enter `Default 1`.
 - d) In the **Save the outcome to a variable** field, select `SampleString`.
 - e) To print the value of the `description` node, double-click or drag the **Message box** action.
 - f) To open the list of your variables, in the **Enter the message to display** field, press F2, and then select `SampleString`.
 - g) Click **Yes, insert**.

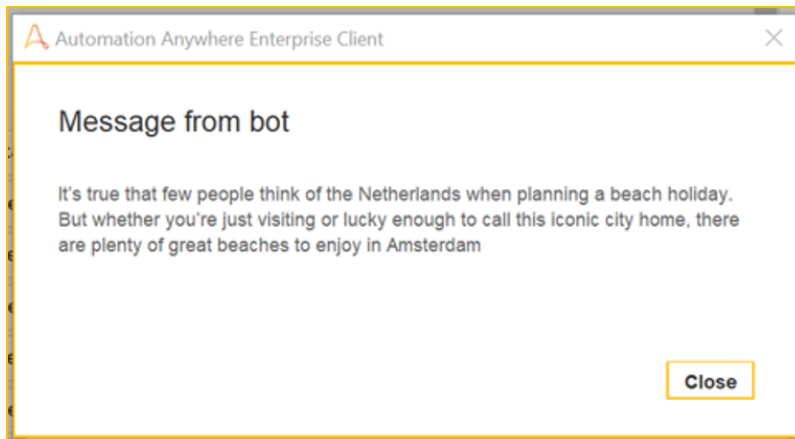

12. To close the JSON session, use **End session**. In the **Session name** field, enter `Default 1`.

13. Click **Save** and the click **Run**.

You can further perform operations to extract the required information from the JSON feed and use the extracted values in your bot. To extract the name value from feed 50 through 60, perform the following steps.

14. Create a variable: `ListItem`

- **Type:** `String`
- **Name:** `ListItem`

15. To process each item in the list, use the **Loop** action.

- a) Double-click or drag the **Loop** action.
- b) Select the **For each item in the list** iterator.
- c) In the **List** field, select `StringList`.
- d) Choose the **Range** option and for the following fields, enter the values provided:
 - **From Index:** `50`
 - **To index:** `60`
- e) In the **Assign the current value to variable** field, select `ListItem`.

16. Start a new JSON session.

- a) From the **Actions** pane, double-click or drag the JSON > **Start session** action.
- b) In the **Data Source** field, select **Text** and enter *ListItem*.
- c) To create a JSON session, from **Json object session**, select **Local session** and enter `Default 2` as the session name.

17. To retrieve the value from a specific node, use the **JSON > Get node value** action .

- a) From the **Actions** pane, double-click or drag the **JSON > Get node value** action.
- b) In the **JSON node key or path** field, enter `name`.
- c) In the **Session name** field, enter `Default 2`.
- d) In the **Save the outcome to a variable** field, select *SampleString*.
- e) To print the value of the `name` node, double-click or drag the **Message box** action.
- f) To open the list of your variables, in the **Enter the message to display** field, press F2 , and then select *SampleString*.
- g) Click **Yes, insert**.

18. Click **Save** and then click **Run**.

The name values retrieved from the feeds 50 through 60 are as follows:

Feeds (object)	Name
50	Ashish
51	Sophia
52	Ritu
53	Shivam
54	Navya
55	Faiz
56	Martin
57	Shweta
58	Jagjit
59	Mark
60	Sophia

Create dictionary type variables

Use Automation 360 to create dictionary type variables using different dictionary subtypes and key value type parameters.

- Ensure you have access to the Control Room.
- You must have credentials with **AAE_Basic** permissions.
- Your workstation must be a registered device in the Control Room.

1. Log in to the Control Room.

2. On the left pane, click **Automation**.
A list of available and forms is displayed.
3. Click the **Create a bot** icon.
4. In the **Name** field, enter `DictionaryMapping`, and click **Create & Edit**.
5. Create four new custom variables:
 - a) Create a new `Dictionary1` variable of **Type** > **Dictionary** and **Subtype** > **String**, and then click **Apply**.
 - b) Create a new `Dictionary2` variable of **Type** > **Dictionary** and **Subtype** > **String**, select **Use as output**, click **Add (+)** sign, and enter **Key** and **Value** as strings, and then click **Apply**.
 - c) Create a new `Dictionary3` variable of **Type** > **Dictionary** and **Subtype** > **Number**, click **Add** sign, and enter **Key** as a string and **Value** as a number, and then click **Apply**.
 - d) Create a new `Dictionary4` variable of **Type** > **Dictionary** and **Subtype** > **Any**, click **Add** sign, and enter **Type** > **String** > **Key** > **Name** > **Value** as a number **Type** > **Datetime** > **Key** > **Date**, enter **Value** for **Datetime** location, enter **Type** > **Boolean** > **Key** > **Result** > **Value** > **True**, and then click **Apply**.
6. In the Actions pane, find **Message box**. In **Enter the message to display**, enter **F2**, and select the variable **Dictionary1** > **Dictionary key** > **Name**.
7. Save the bot and run the **DictionaryMapping** TaskBot.

Related concepts

[How to examples](#)

This section contains code examples and explanations about how to code some basic bot capabilities.

Automation Anywhere Robotic Interface (AARI)

Automation Anywhere Robotic Interface or AARI provides a simple, front-end interface for users to execute and interact with bots and applications.

Use AARI from within applications such as Salesforce and within browsers and desktops for end-to-end process automation across the enterprise by connecting bots in the front and back offices.

Why use AARI

AARI helps you to achieve the following goals:

- Simplify everyday tasks, such as reporting and keeping track of urgent requests.
- Collaborate easily with your team's applications and bots, thereby improving average handle time and resolution rate, which helps improve customer satisfaction.
- Speed up even the most complex requests by automating escalations and approvals.
- Accelerate return-on-investment owing to minimal investment on infrastructure, training, and set-up costs for your enterprise.

What you can do with AARI

AARI enables real-time communication between users and bots. By using AARI to automate repetitive and time-consuming tasks, you can improve customer experience, increase employee productivity, and cut operational costs for your organization.

The following image illustrates how AARI enhances automation.

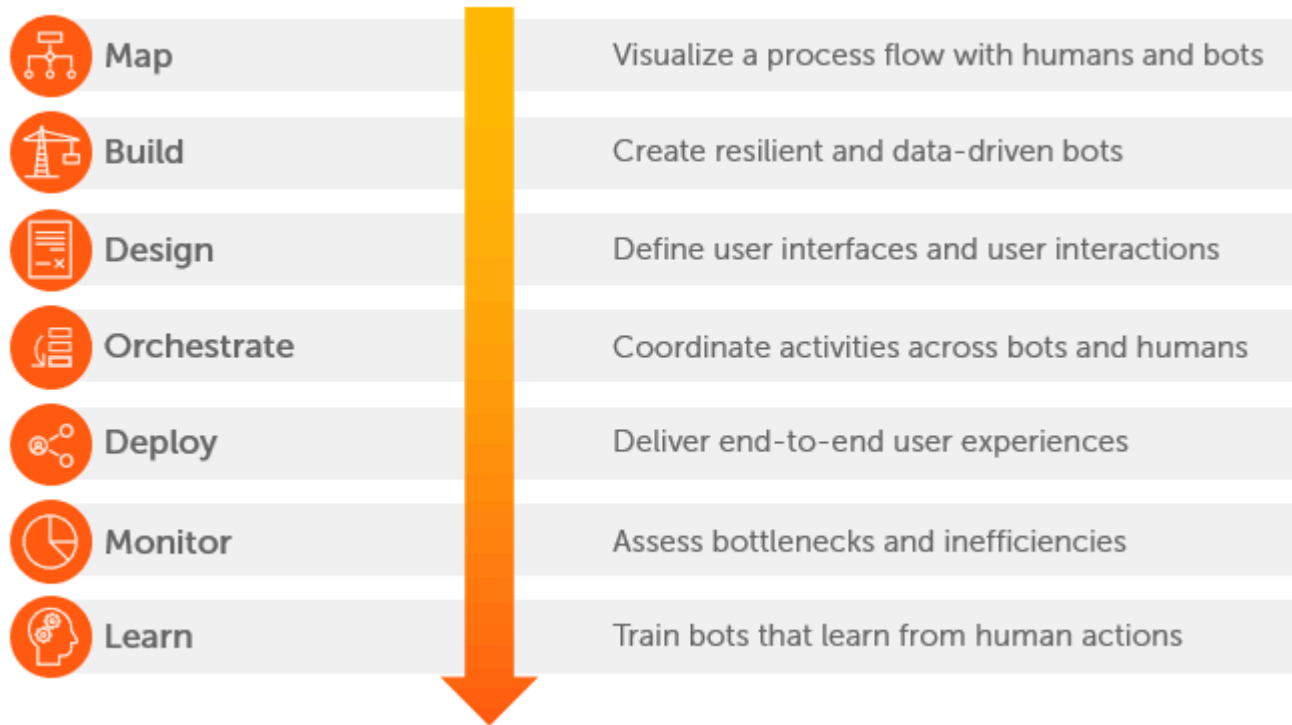

Accessing AARI

AARI provides various interfaces that you can use to connect to business workflows at multiple touchpoints. Access AARI in the following ways:

- Web browser

Access AARI through a URL to manage front and back office functions, gathering input and approval from a single interface.

- Desktop

Retrieve and update data with custom forms. Users can view and interact with all data from a single screen instead of switching between multiple systems.

- Applications

Execute bots from common enterprise applications such as Salesforce and Google Workspace through Automation Anywhere pre-built integrations.

- [RPA Bots for Salesforce](#)
- [RPA Bots for Google Workspace](#)

The following image illustrates the difference in the process flow between AARI on the web and AARI desktop:

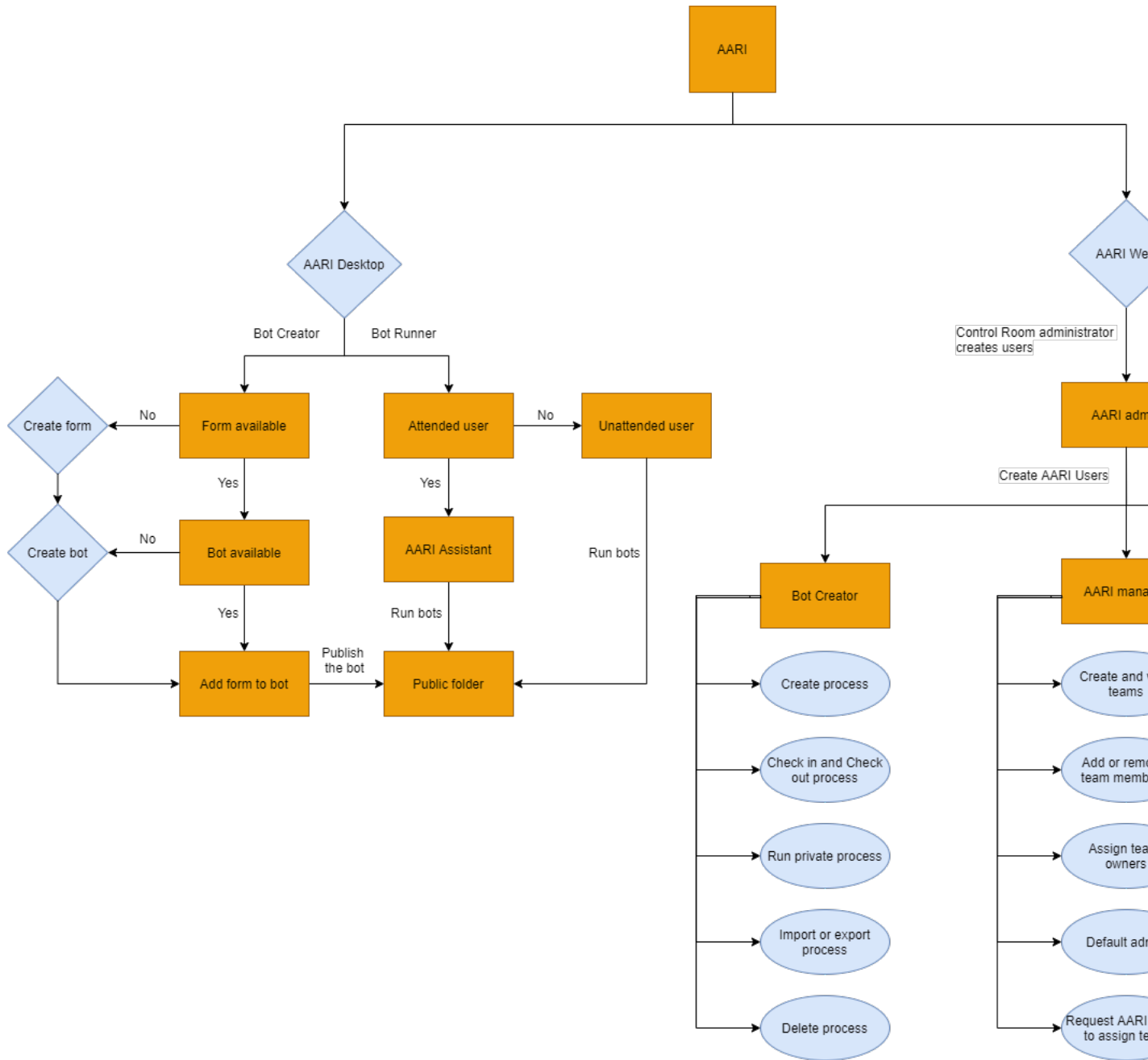

Related concepts

[Using AARI on the web interface](#)

The Automation Anywhere Robotic Interface(AARI) web interface is an intuitive portal and dedicated workspace for AARI users to create requests, run tasks, and for AARI managers to create manage team roles and deployment.

[Using AARI on desktop](#)

Use Automation Anywhere Robotic Interface (AARI) through your desktop to manage routine tasks such as validating data, retrieving approvals, and managing escalations through bots.

Using AARI on the web interface

The Automation Anywhere Robotic Interface(AARI) web interface is an intuitive portal and dedicated workspace for AARI users to create requests, run tasks, and for AARI managers to create manage team roles and deployment.

AARI on the web interface provides an engaging experience with attended and unattended bots. It gives you a one-stop place to view and organize your documents and tasks, perform actions, and hand over the work to bots. In addition, it provides a process-centric approach to deliver automation.

Capabilities

AARI on the web interface helps you in the following ways:

- Start automation from an easy-to-use process catalog.
- Automate long-running workflows across multiple users and bots.
- Handle bot exceptions.
- Train users and reduce errors with guided automation.
- Multitask with humans and bots.
- Monitor and audit attended automation.

AARI on the web helps multiple users to collaborate with bots without disruption and without accessing your personally identifiable information (PII) data and confidential systems.

The following image illustrates the front-office automation capability:

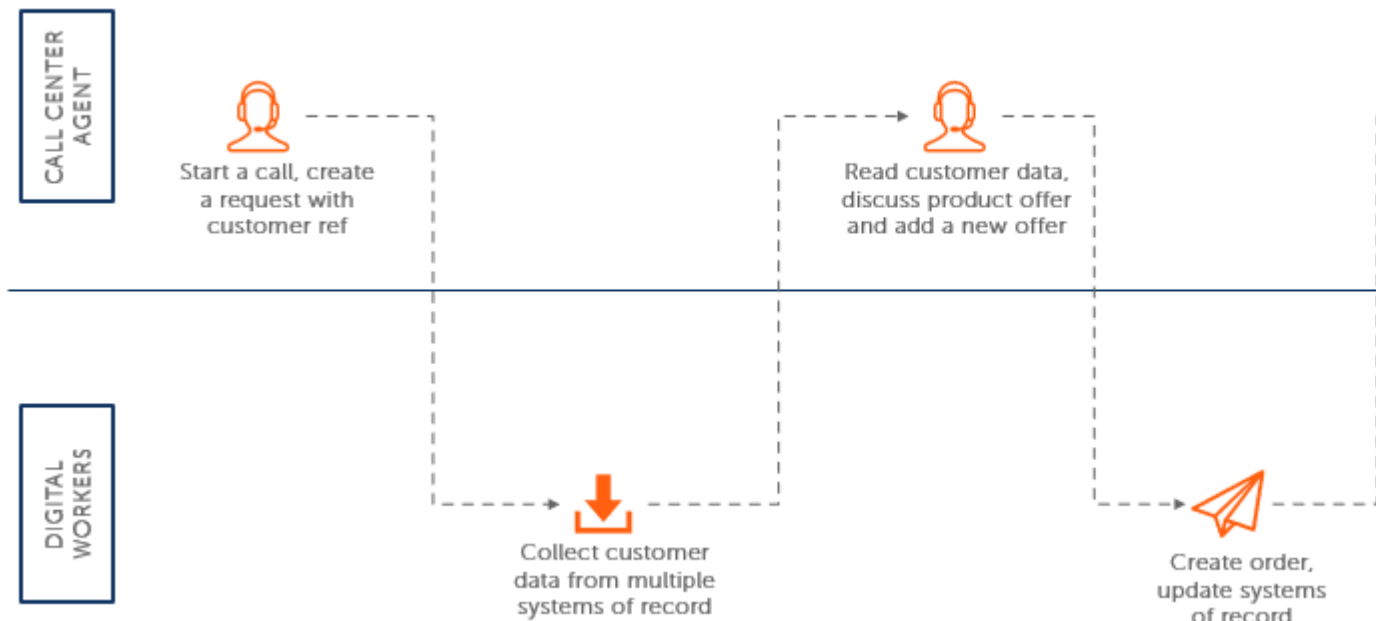

Components

AARI on the web interface includes the following components:

Bots	The bots automate specific, repetitive, rule-based tasks.
Form	The form enables humans to invoke and interact with the bots through the customizable web interface.
Process	The process connects the bots and the forms together. The process contains the logic for triggering the bots and the forms and coordinating the flow of data between them.
Request	The request is an instance of a process. If the process defines a template of how bots and forms interact, a request is a specific instance of that template.
Task	Tasks are the steps that must be performed within a process. Processes can have two types of tasks: <ul style="list-style-type: none">• Human task: A task that is performed by a human; a human task is a form.• Bot task: A task that is performed by a bot.

Review the following image to gain a better understanding of the relationship between these components.

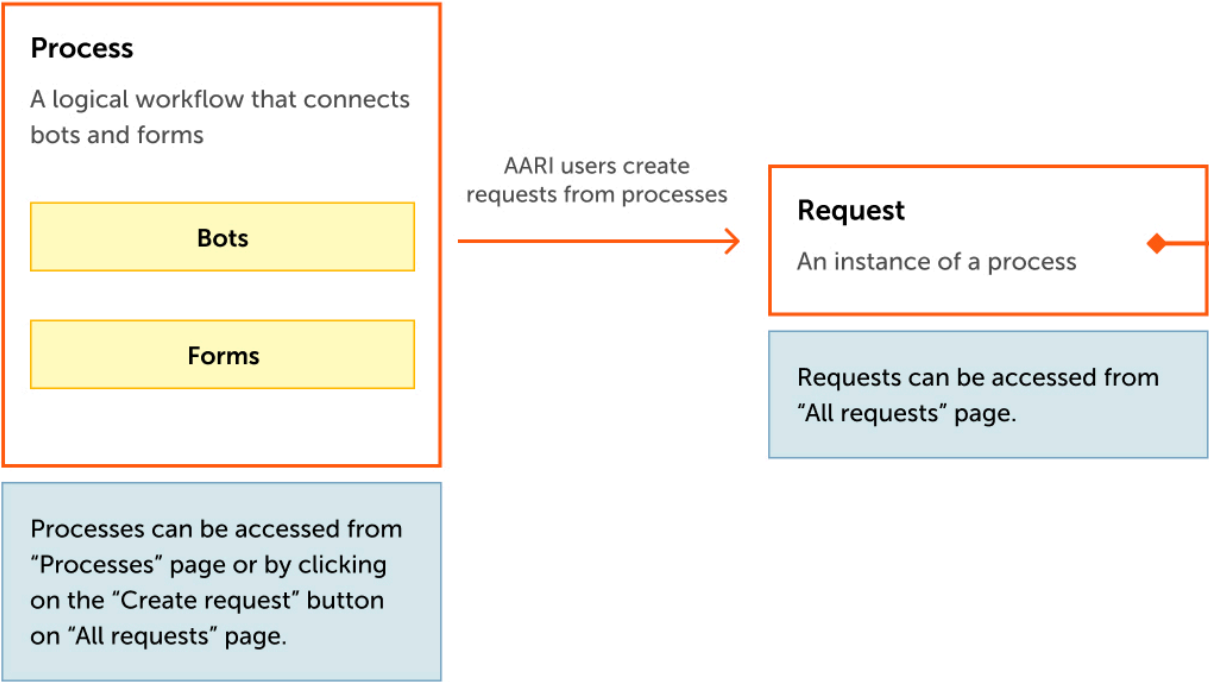

Architecture

The following images illustrate the architecture of AARI on the web interface:

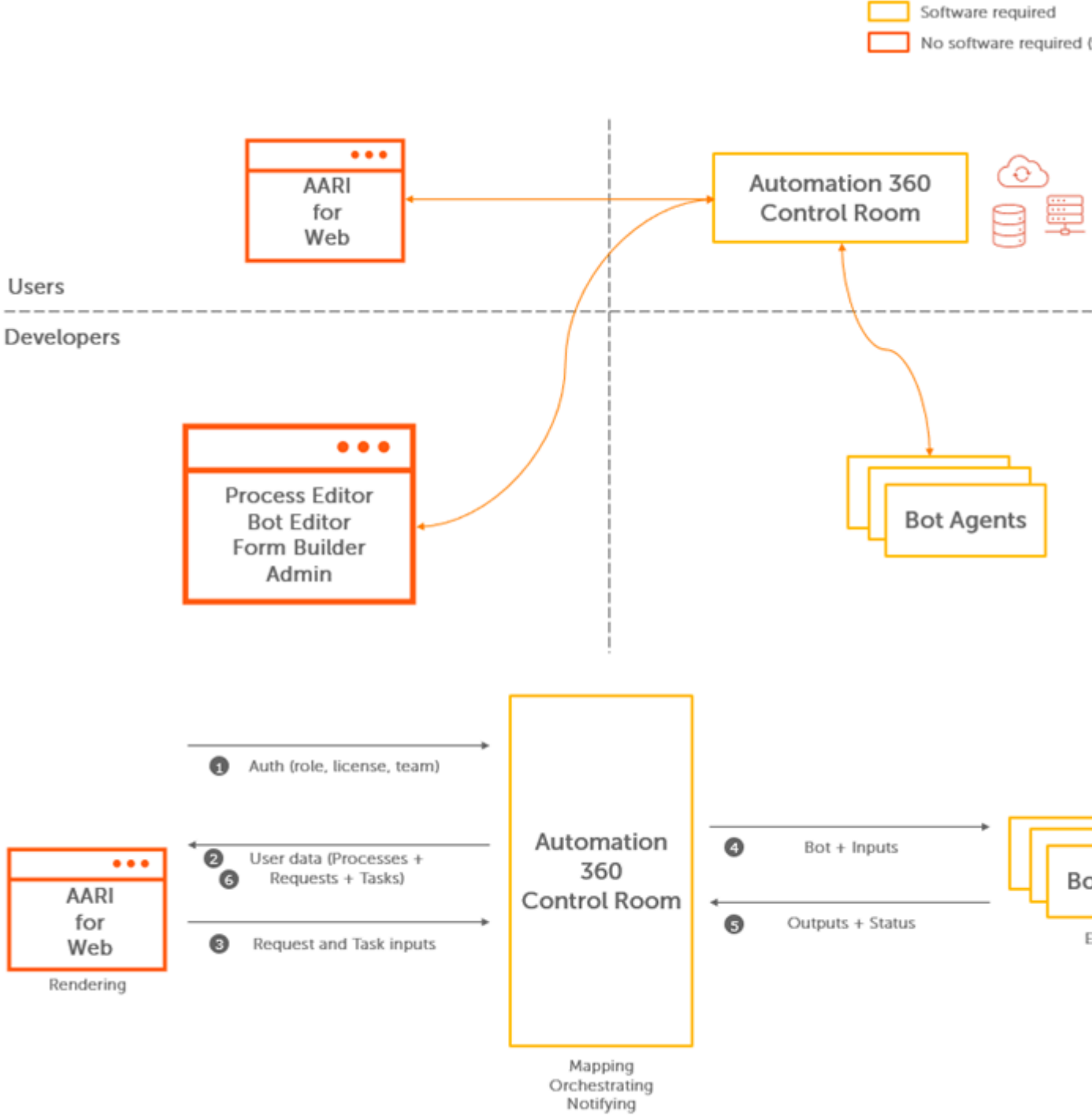

Setting up

The following workflow lists how to use AARI on the web interface to automate and manage your tasks:

1. *Configure and set up roles*
2. *Configure processes*

3. *Deploy processes*

Workflow map: To view the AARI web interface tasks in an interactive visual format, see [Get started with AARI](#).

AARI web interface users

Various users are involved in AARI on the web interface and each user contributes in different ways to help automate the business requirements.

AARI users are broadly categorized into two types, users who can access the Control Room and users who have access only to the web interface. Each user's role and responsibilities vary depending on the stage of the workflow.

Users and their roles

The following table illustrates the relationship between users, roles, and the permissions they have while using AARI on the web interface.

User	Role	Permissions
Control Room administrator	AAE_Admin	Create users with AARI license and assign roles.
Bot Creator	AAE_Basic	<ul style="list-style-type: none"> • Create a process. • Check in a process. • Check out a process. • Run a private process. • Delete a process. • Import a process. • Export a process.
AARI admin	AAE_Robotic Interface Admin	<ul style="list-style-type: none"> • Configure scheduler user and allocate Control Room resources (device pool and unattended Bot Runners) to a process in the configuration setup stage. • Perform the following global team and process management tasks in the process deployment stage: <ul style="list-style-type: none"> • Create, view, and modify all teams. • Assign teams to processes.

User	Role	Permissions
AARI manager	AAE_Robotic Interface Manager	<ul style="list-style-type: none"> • Create and view teams. • Add members to or remove members from the teams. • Assign owners to the teams. • Function as default admin for the teams they create. • Request AARI admin to assign their team to processes.
AARI user	AAE_Robotic Interface User	<ul style="list-style-type: none"> • Create and access requests. • Submit and access tasks.

Team roles and permissions

The following table lists the users, and their roles and permissions in an AARI team.

Team role	Control Room role	Team type	Permissions
Admin	AAE_Robotic Interface Manager	Shared	<ul style="list-style-type: none"> • Create • View all • Delete all • Assign all • Modify team
		Private	<ul style="list-style-type: none"> • Create • View all • Delete all • Assign all • Modify team
Owner	AAE_Robotic Interface User	Shared	<ul style="list-style-type: none"> • Create • View all • Delete all • Assign all
		Private	<ul style="list-style-type: none"> • Create • View all • Delete all • Assign all

Team role	Control Room role	Team type	Permissions
Member	AAE_Robotic Interface User	Shared	<ul style="list-style-type: none"> • Create • View all • Delete • Assign all
		Private	<ul style="list-style-type: none"> • Create • View • Delete • Auto-assign

Note: The **AAE_Robotic Interface Manager** role sets the AARI manager to automatically have an admin team role.

Example

Consider two teams, Finance and HR, and their team roles as listed in the following table:

Finance (private)		HR (shared)	
User	Role	User	Role
User A	Owner	User X	Member
User B	Member	User Y	Member
User C	Member	User Z	Owner

For any process, keep in mind the following:

- User A can view and delete all the requests created inside the team Finance.
- Users B and C can view and delete only their requests inside the team Finance.
- Users X, Y, and Z can view all the requests but can delete only their request inside the team HR.
- User Z can view and delete all the requests created inside the team HR.

Configure roles for AARI on the web

Configure users and assign them the AARI license and relevant roles and permissions to start using the web interface.

As AARI is already installed in the Control Room, you do not need to install it separately in the web interface.

The primary users involved in the configuration stage are as follows:

- Control Room administrator: The Control Room administrator creates users and assigns AARI roles (AARI admin, manager, and user) with the AARI licenses.

[Create users for Automation Anywhere Robotic Interface](#)

- AARI admin: The AARI admin creates the scheduler user and allocates Control Room resources required to run a process.

Configure scheduler user for AARI on the web

Workflow map: Click the following schematic image to view the AARI workflow in an interactive visual



format:

1. *Get started with AARI*

Related concepts

[AARI web interface users](#)

Various users are involved in AARI on the web interface and each user contributes in different ways to help automate the business requirements.

Create users for Automation Anywhere Robotic Interface

Create the Automation Anywhere Robotic Interface (AARI) admin, manager, and users to use the AARI functionality for business processes. The Control Room admin creates users and assigns the required system roles.

Ensure that you have purchased the AARI user license for your business users.

Note: These roles are only applicable for the web interface.

1. From your local machine, log in to your Control Room as administrator.
2. Go to **Administration > Users**.
3. Click **Create user**.

The icon is located at the top-right of the **Users** table.

The **Create user** page is displayed.

4. In the **General Details** section, enter the following user details:

Enable User	Select the check box so that the user can log in immediately.
Username	Enter a unique user name.
Description	Optional: Enter a description for the user.
First name	Optional: Enter the first name of the user.
Last name	Optional: Enter the last name of the user.
Password	Type and confirm a password for the user. Ensure the password follows any necessary password policy.
Email	Enter and confirm the email address for the user. If SMTP is enabled, the user is sent an email to this address to confirm the account. Click the URL in the email to log in to the Control Room and set

up your credentials. All important Control Room notifications will be sent to this email address.

- In the **Select Roles** section, select one of the following roles from the **Available roles** column:

Role	Select this role
Admin	AAE_Robotic Interface Admin
Manager	AAE_Robotic Interface Manager
User	AAE_Robotic Interface User

- Click the right arrow to move the role to the **Selected** column.
- In the **Allocate a device license** section, select the following:

Role	Action
Admin	Retain the default None . The user with administrator role has access to the Control Room and AARI on the web.
Manager	Retain the default None . You can optionally assign the AARI user license to create a request or submit tasks. The user with manager role has access to AARI on the web.
User	Assign the AARI user license. You can also optionally assign the attended Bot Runner license to run local bots or use the desktop interface. The user has access to AARI on the web.

- In the AARI licenses section, select the **AARI user** check box.
- Click **Create user**.
The new user is displayed in the User table. If SMTP is enabled, an email will be sent to the new user inviting them to log in.

Configure scheduler user for AARI on the web

You can configure a scheduler user (global scheduler or per-process scheduler) to allocate the Control Room resources (devices and unattended Bot Runners) to AARI on the web interface. This scheduler user is a dedicated user who helps in process deployment.

The role assigned to the scheduler user cannot be a shared role with any other user such as Bot Runner or an admin user. To perform this task, you will use both the Control Room and AARI web interface.

- Create a scheduler user with a role in the Control Room.*
- Create device pools in the Control Room.*

Note: The AARI administrator is the device pool owner, and you must select your custom role (**AARI-pool-scheduler**) in **Device Pool Consumers**.

- Assign a scheduler user to a process in the web interface.*

Create user and assign role

Create a scheduler user and assign custom role to run the AARI process in the web interface.

You must be an AARI administrator to perform this task.

1. Log in to the Control Room as an administrator.
2. Navigate to **Administration > Roles**.
3. Create a custom role.
For example, AARI-pool-scheduler.
Create a role.
 - a) Set the permissions to **View my bots, View packages, Run my bots, and AARI Scheduler**.
 - b) In the **Bots** tab, select the folders that contain the bots to be run by the AARI scheduler user, that you want to give access to with run and view permissions. Set the required bot permissions for the role at the folder level.
 - c) Select the unattended users in the **Run As** section.
 - d) Save your changes.
4. Create a user.
For example, AARI-scheduler-user.

Note: This user does not require any license.

5. Assign the custom role you created to this user.
For example, AARI-pool-scheduler.

Assign scheduler user to process in the web interface

You can configure a scheduler user (team scheduler, per-process scheduler, or global scheduler) to allocate the Control Room resources (devices and unattended Bot Runners) to AARI on the web interface. This scheduler user is a dedicated user who helps in process deployment.

Ensure that you have created the scheduler user and the device pool.

1. Log in to the web interface as an AARI administrator.
Alternatively, you can navigate to the web interface through the Control Room by clicking the **settings page** link in the **Manage > Device pools** screen. This will automatically navigate you to the AARI web interface screen, with you logged in as an AARI administrator.

2. Select a scheduler user by choosing one of the following options:

The AARI process uses the device pool and unattended Bot Runners configured with this user for each bot deployment.

By default, **Global scheduler** is selected if you have not set a **Scheduler** for any process.

By default:

- a. **Team** scheduler user is selected.
- b. **Process** scheduler user is selected if **Team** scheduler user is not defined.
- c. **Global scheduler** user is selected if the **Team** and **Process** scheduler users are not defined

Scheduler Type	Steps
Team	<ul style="list-style-type: none"> a. Navigate to Manage > Process. b. Select the process to configure the scheduler user. The Edit Process page will open. c. Navigate to the Team tab. d. Select a scheduler user from the drop-down menu in the Scheduler field. The Process scheduler is selected by default. e. Click Save.
Scheduler (per-process scheduler)	<ul style="list-style-type: none"> a. Navigate to Manage > Process. b. Select the process to configure the scheduler user. The Edit Process page will open. c. Navigate to the Deployment tab. d. Select a scheduler user from the drop-down menu in the Process scheduler field. The Global scheduler is selected by default. e. Select the Deployment type. f. Click Close. The setting saves automatically.

Scheduler Type	Steps
Global scheduler	<ol style="list-style-type: none"> a. Navigate to Manage > Process. b. Select the process to configure the scheduler user. The Edit Process page will open. c. Navigate to the Deployment tab. d. Select the Global scheduler user from the drop-down menu in the Process scheduler field. The Global scheduler is selected by default. e. Select the Deployment type. f. Click Close. The setting saves automatically.

Important: If scheduler users had their role removed or do not have sufficient permissions to access a file:

- a.** The Control Room admin will see an audit log of the change.
- b.** The AARI admin will see an error message for an invalid scheduler then must reassign a new scheduler user.
- c.** The AARI user will see an error message for the process.

Configure deployment type for bots

You can configure the deployment type for your bot tasks. This determines how the bots in the process will be deployed. You can also define the mapping between run-as user and the device.

This mapping will help take care of constraints if any in your organizational set up such as credential constraints requiring one to one mapping between devices and run-as user.

- 1.** Navigate to **Manage > Process**.
- 2.** Select the process.
- 3.** Select the **Deployment** tab.
- 4.** In the **Deployment type** field, select one of the following options:
 - **Prefer default device** - The bot deploys on the default device of the unattended Bot Runner user. If default device is unavailable, the bot deploys on the available device in the device pool. All the unattended Bot Runner users in the scheduler user should either have the same device credentials (user name and password) or the different user name and password credentials that are set in all the devices. If the password is different for each device credential, the user name also differs.
 - **Run on pool of device** - The bot deploys on the available device in the device pool. It overrides the default device of the user.
 - **Run only on default device** - The bot deploys only on the default device of the user. In this option, the unattended Bot Runner user should own the default device. If the device is jointly owned by the unattended Bot Runner user along with another licensed user, the device is not used as the unattended Bot Runner user is considered to have no default device. If the scheduler user

has multiple unattended Bot Runner users and one of those users do not have a default device, the bot deployment fails.

5. Click **Close**.

Configure processes

AARI provides front-office and back-office automations, where the Bot Creator user creates a process workflow with human and bot tasks as per the business requirement.

A Bot Creator user can configure a process in the Process Composer in the Control Room. The Process Composer provides a drag-and-drop interface to help create process flows. It enables the user to configure when a bot should be executed. It also displays correct data to the users and exchanges the data across multiple teams.

Designing processes

A process consists of human and bot tasks. A process contains the following components:

- An entry form which is the first step in a process.
- A sequence of process elements as follows:
 - Forms or TaskBots
 - Input, output, and meta-variables to share data
- Logical conditions such as **If, Else** for internal and conditional branching of the process.
- End states to close each request such as completed, failed, or canceled.

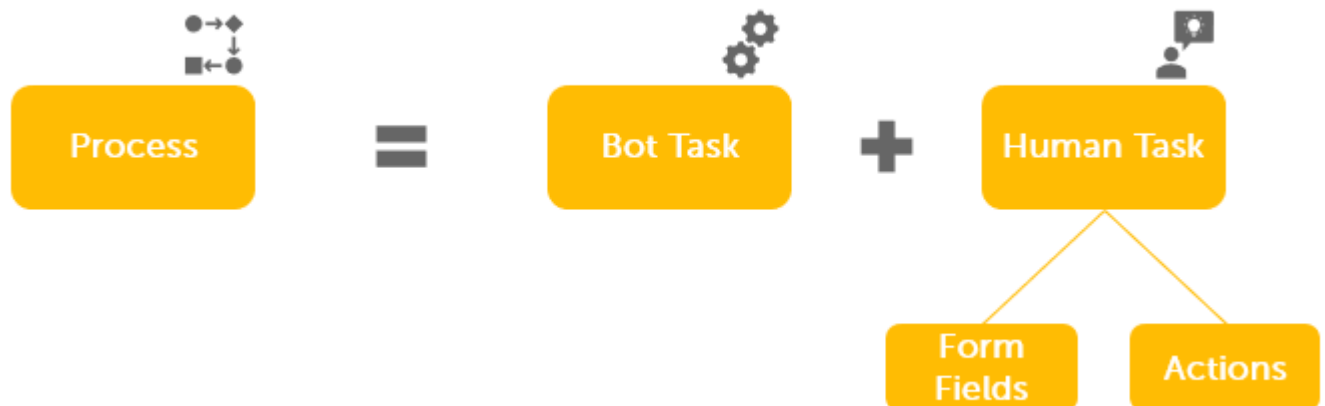

Designing forms

A Bot Creator user can create a form and enter the required data by using form elements that can be rendered in the web interface. They can add or remove form actions when creating processes.

As a user, you can interact with the form only when it is assigned to you. If the form is unassigned, it is not enabled and is read-only. To edit the form, you can assign the form either to yourself or to any member of the team who has access to the process. After editing the form, the assignee can either submit

the form or use any other action options. After the form is submitted or an action option is used, the request view displays the next step or task.

In the web interface, the following elements are supported in a form:

- Checkbox
- Date
- Document
- Dropdown
- Hyperlink
- Image
- Label
- Number
- Password
- Radio Button
- Rich Text Editor
- Select File
- Table
- Text Area
- Text Box
- Time

Designing TaskBots

A Bot Creator user can create a TaskBot that will execute inside the process by using the input and output variables. When the **Use as input** check box is selected, the process passes data into the input variables, and when the **Use as output** check box is selected, the process gets data from the output variables after bot execution.

Process workflow

The following workflow describes the steps involved in building an AARI process and making it available in the web interface:

1. *Create an AARI process.*
 - a. *Create a TaskBot.*
 - b. *Create an AARI form.*
2. *Check in an AARI process.*

Other tasks

Depending on the requirement, a Bot Creator user can also perform other tasks after creating a process:

- If there is a change in the requirement, a Bot Creator user can check out the process to their private workspace and edit the process according to the requirement.

Check out an AARI process.

- The Bot Creator can test the process before checking it in by running it in the private workspace.

You can run the process either in the public or the private workspace using the **Run** option in the Process Composer. The bots in the private process executes on the default device of the Bot Creator.

When the private process is executed, the Bot Creator can create a request, enter data in the initial form, and run their request from the private workspace. Requests created from the private process execution can be viewed only by the user creating the request. Requests created from the public process execution can be viewed by the AARI administrator. Managers and users can view the requests only if they have access to the process.

Run an AARI process.

- Access a process from one Control Room to another by either importing or exporting the process. For example, if a process is developed and tested in the staging pod and is now ready for production, it can be exported from the staging pod. Similarly, this exported process can be imported into the production pod.
 - *Import an AARI process.*
 - *Export an AARI process.*
- If a requirement becomes redundant, the created process can be deleted.

Delete an AARI process.

Related concepts

[AARI web interface users](#)

Various users are involved in AARI on the web interface and each user contributes in different ways to help automate the business requirements.

Create an AARI form

Create an Automation Anywhere Robotic Interface (AARI) form to provide interaction between humans and bots. You can enter the required data using form elements that can be rendered in the web interface. You can add or remove form actions when creating the process.

- You must have a Bot Creator license.
- You must be assigned a custom role with the create folder permission.

Forms in AARI can be displayed in two scenarios:

- Case creation: This is the initial form that is displayed when you want to create a new case and enter the required business data.
- Form step: This form is displayed to show information and prompt for additional inputs.

1. On the left pane, click **Automation**.
A list of available and forms is displayed.
2. Click **Create new > Form**.
3. In the **Create form** page, enter a name for the new form.
Forms are saved in the `\Bots\` folder by default. Click **Browse** to change the default folder.
4. Click **Create & edit**.
The form builder page appears with a single row **Column** layout.
5. If you want to delete a row, click the vertical ellipsis in the form layout and click **Delete row**.
6. Confirm the delete action in the confirmation message.
7. Drag the required element into the form from the **Elements** panel on the left.
8. Use the **Properties** panel on the right to update or change the form properties.
9. Click **Save**.

10. Click Close.*Create an AARI process***Related tasks**[Example of uploading and downloading file for web](#)

This task is a use case of how to use the **Select File** element to upload or download files that are passed in the initial forms in the web interface.

Example of using the Checkbox element dynamically

The **Checkbox** element in the AARI form enables you to select multiple options in a form during bot runtime. In this example, use the **Checkbox** element to generate dynamic options.

You must have a Bot Creator license and be assigned a custom role with create folder permission.

In this example, we will create a process to register new employee details in the company database. The initial form contains basic information such as Name, ID, Date of Birth, Gender, and Location. The initial form has only two options (San Jose and Tokyo) for the Location field. We will make this field dynamic where during requestion creation, a new location (India) is added for those employees whose ID is in the 100 to 200 range.

1. Log in to the Control Room as a Bot Creator user.
2. Create the initial form.

Create an AARI form.

- a) On the left plane, click **Automation**.
- b) Click **Create new > Form**.
- c) Enter the form name `employee_register_initial_form`.
- d) Enter the folder location `Bots\Employee Registration`.
To change where your form is stored, click **Choose** and follow the prompts.
- e) Click **Create & edit**.
- f) Use the following **Elements** and **Element label** in the form.

Elements	Element label
TextBox	Full Name
Number	ID
Date	Date of Joining
Dropdown	Gender

For the **Dropdown** element, enter `Male, Female` in the **Enter list items separated by commas** field.

- g) Click **Save**.
- h) Click **Close**.

3. Create another form.
 - a) In the same folder location, click **Create new > Form**.
 - b) Enter the form name `employee_location`.
 - c) Click **Create & edit**.
 - d) Drag the **Checkbox** element into the form.
 - e) Enter the name in the **Element label** field `Employee location`.
 - f) Click the **plus** icon in the **Checkbox content** field and add the locations `San Jose` and `Tokyo`.
 - g) Click **Save**.
 - h) Click **Close**.

4. Create a new bot.
 - a) In the same folder location, click **Create new > Bot**.
 - b) Enter the bot name `dynamic_checkbox`.
 - c) Click **Create & edit**.

5. Create the following variables:
 - `emp_id`: Number type; use as input
 - `emp_location`: List type, String subtype; use as output; click the **plus** and add two values `San Jose` and `Tokyo`
 - `emp_dyn_location`: String type, add the default value `India`

The default values are San Jose and Tokyo but if the employee ID falls between 100 and 200, the location India is selected.

6. Use the **If** action to configure the conditional statement.
 - a) Double-click or drag the **If** action.
 - b) Select **Number** from the **Condition** drop-down list.
 - c) In the **Source value** field, insert the variable `emp_id`.
 - d) Select **Greater Than (>)** as the **Operator**.
 - e) Enter `100` in the **Target value** field.
 - f) Click **Add condition** and select **And**.
 - g) Select **Number** from the **Condition** drop-down list.
 - h) In the **Source value** field, insert the variable `emp_id`.
 - i) Select **Less Than (<)** as the **Operator**.
 - j) Enter `200` in the **Target value** field.
 - k) Click **Save**.

7. Use the **List** package into the **If** container to insert the new location as per the defined condition.
 - a) Drag the **List > Add item** action.
 - b) In the **List variable** field, select the variable in which to add the list item `emp_location`.
 - c) In the **Item to be added** field, select the variable that contains the value to add `emp_dyn_location`.
 - d) Click **Save**.
 - e) Click **Close**.

8. Create a new process.
 - a) In the same folder location, click **Create new > Process**.
Create an AARI process.
 - b) Enter the process name `employee_register`.
 - c) Click **Create & edit**.
 - d) Click **Start** to add an initial form to the process.
 - e) In the **Select initial data form** field, browse and select the initial form, that is `employee_register_initial_form`.
 - f) Provide **Request title** as `Employee Registration`.
 - g) Drag the **Bot Task** into the Process Composer from the **Task** field.
 - h) In the **Bot Task** panel, **Element name** field, enter a name `Location`.
 - i) Enter the **Task name** `Generate location`.
 - j) In the **Select Task Bot** field, browse and select the bot you created `dynamic_checkbox`.
 - k) In the **Input values** field, select the input variable `emp_id`.
 - l) Drag the **Human Task** into the Process Composer from the **Task** field.
 - m) In the **Human Task** panel, **Element name** field, enter a name `location_form`.
 - n) Enter the **Task name** `Employee location form`.
 - o) In the **Select form** field, browse and select the form you created `employee_location`.
 - p) Click **Add button**.
 - q) Specify `OK` for **Button label** and `Primary` for **Button style**.
 - r) Select the **Feed data into form** check box, `Employee Location[CheckBoxGroup0]`. Set the two variables from the bot as output variables.
 - s) In the **List of options** field, select the output variable `$Location.output[emp_location]$`.
 - t) In the **Default value** field, select the output variable `$Location.output[emp_dyn_location]$`.
 - u) Click **Save**.
 - v) Click **Close**.

9. Deploy the process.
 - a) Click **Run**.
A request is created for the process.
 - b) Enter the values for the initial form.
 - c) Click **Submit**.

The process deploys and if the employee ID falls between the values 100 to 200, the Employee location field will have a new option of India making this option dynamic. If the employee ID is not between the values 100 to 200, the Employee location field will have only two options, San Jose and Tokyo.

Example of uploading and downloading file for web

This task is a use case of how to use the **Select File** element to upload or download files that are passed in the initial forms in the web interface.

1. You must have a Bot Creator license and be assigned a custom role with the create folder permission.
2. Ensure you have access to the RPA Workspace.
3. You must be provided a system-created **AAE_Robotic_Interface User** role with the AARI user license, for the AARI user.
4. Ensure you have access to the web interface.

1. Log in to the RPA Workspace as a Bot Creator
2. Create a new form, see [Create an AARI form](#).
Let's name this form as **File Form**.
The new form window appears for you to design your form.
3. Drag and drop the **Select File** element into your form designer from the **Elements** column.
The **Properties - Select File** window now appears with relevant fields.
4. Specify a label in the **Element label** field.
For example: the element label is **Select a file (PDF)**.
5. Specify the supported file format in the **Enter supported file formats separated by commas** field.
In this case we would specify **PDF**.
6. Click **Save** and close the current window.
7. Create another form.
Let's name this form as **View Document Form**.
8. Drag and drop the **Document** element into your form designer from the **Elements** column.
You can also use the **Image** element, instead of the **Document** element, to add an image to your form.

Note: This works the same way as the **Document** element.

9. **Optional:** you can specify the window formatting and dimensions in the **Properties - Document** window that appears.
10. Click **Save** and close the current window.

11. Create a new bot.
Let's name this bot as **Bot File**.
The new bot window appears for you to create a bot.
12. Select the plus (+) icon in the **Variables** field.
The **Create variable** window appears.
13. Select **File** in the drop-down menu in the **Type** field.
14. Specify the variable name in the **Name** field.
Let's name this variable as **FileVar**.
15. Select only the **Use as input**.
16. Click **Create**.
17. Drag the **Get Storage file** action from the **AARI Web** command.
The **AARI Web Get Storage file** window appears.
18. Select **Variable**.
19. Select the **FileVar** that you had created.
20. Specify the path in the **Full path of file in local device to be saved to** field.

Important: The full path of the file includes the name of the file (ex: C:\aari\output\filename.pdf).

21. Create a new process, see [Create an AARI process](#).
Let's name this process **Process To Download File**.
The Process Composer appears for you to create a process.
22. Click on **Process entry**.
The **Start** window appears.
23. Click **Browse** in the **Select initial data form** field
24. Set the initial form as **File Form** that you had created.
25. Specify the request title and task name.
26. Click **Save** and close the current window.
27. Drag and drop the **Bot Task** into your Process Composer from the **Task** field.
The **Task: Bot Task** window appears.
28. Specify your element and task name in the **Element name** and **Task name** fields.
29. Select your input value as the **FileVar** that you had created.
30. Click **Save** and close the current window.
31. Drag and drop the **Human Task** into your Process Composer from the **Task** field.
The **Task: Human Task** window appears.
32. Specify your element and task name in the **Element name** and **Task name** fields.
33. Select the **Auto-assign this task to** option.
34. Select the **View Document Form** in the **Select Form** field that you had created.
35. Click **Add button** option.
36. Specify your button labels and style **Button label** and **Button style** fields.
37. Select **Document** in the **Feed data into form** field.
Alternatively, select **Image**, if you had used the **Image** element instead.
38. Click **Save** and close the current window.
39. Click **Run** to run your process.

The initial form window for the **Process To Download File** process appears with the **Select a file (PDF)** option for you to upload a file.

40. Click **browse** to select a PDF file in the initial form.

You have uploaded your file to the initial form.

41. Click **Submit**.

The request view page appears and the tasks are running.

One of the process steps will show you a preview of the file that was uploaded.

42. Click **Done** to confirm.

The PDF file is downloaded to the local machine at the file path you set.

43. Navigate to folder on your local machine (e.g. **C:\aari\output**) where you had specified the file path.

The downloaded file should now appear in the folder location.

44. Click the PDF file to view your file.

You have now successfully downloaded and viewed your file.

Cloud storage usage

This topic describes the cloud storage based on the file size that is uploaded by the user.

Overview

Users who use the **Select File** element are able to upload files, these files are stored on the cloud and have specific requirements.

Cloud Storage quota

The files that are uploaded by users are based on the maximum file and storage sizes.

The quota for cloud storage are as follows:

- The file size for when the user uploads a file using the **Select File** element cannot exceed **50 MB**.

Important: The file limit is only attached to a **Select File** element and not a request. In addition, you can only upload one file for each **Select File** element, however, there is no limit to the number of **Select File** elements that can be added to a form.

- The cloud storage can store a maximum of **250 MB** of data per tenant.

Note: This is set by default.

Important: The storage limit is per tenant and not per user.

- The storage for each tenant is extended to an additional 1 GB for every AARI user license that are allocated in the tenant.

Retention Policy

There is a retention policy for files that are uploaded to the cloud storage.

The retention policy are as follows:

File will be deleted 90 days after the time of the file upload.

When a request is deleted, the request and the associated file are permanently deleted and not just sent to the recycle bin.

Note: This is supported only for requests with one associated file, not multiple files.

Example of uploading a file as a request input

This is an example of using forms to upload and view a PDF file.

1. You must have a Bot Creator license and be assigned a custom role with the create folder permission.
2. Ensure you have access to the RPA Workspace.
3. You must be provided a system-created **AAE_Robotic_Interface User** role with the AARI user license, for the AARI user.
4. Ensure you have access to the web interface.

1. Log in to the RPA Workspace as a Bot Creator
2. *Create a form with the **Select File** element.*
This is your first form.
3. *Create a form with the **Document** element.*
This is your second form.
4. *Create a process to view files.*
Now that you have created a process with data from two forms, you can now run your process.
5. Click **Run** in the Process Composer.
The initial form will now open in a separate tab for you to interact.
6. Click **browse** to select a file.
You need to navigate to the file path in your local machine.
7. Select your PDF file.
8. Click **Open**.
You should now be able to open that PDF file in your form.
9. Click **Submit**.
10. Click **Done** to confirm.
The PDF file is successfully uploaded.

Create a form with the Select File element

You can create a form with the **Select File** element to select files.

1. Create a new form.
Let's name this form as **Select File Form**.
2. Drag and drop the **Select File** element into your form designer from the **Elements** column.
The **Properties - Select File** window now appears with relevant fields.
3. Specify a label in the **Element label** field.
This can be labeled as **Upload a file**.
4. Specify the supported file format in the **Enter supported file formats separated by commas** field.
You can specify **PDF**.
5. Click **Save** to save your form session.
6. Click **Close** to close the current form window.

Create a form with the Document element

You can create a form with the **Document** element to select files.

1. Create a new form.
Let's name this form as **Document Viewer Form**.
2. Drag and drop the **Document** element into your form designer from the **Elements** column.
The **Properties - Form** window now appears with relevant fields.
3. **Optional:** You can modify your document dimensions or keep the system default settings.
4. Click **Save** to save your form session.
5. Click **Close** to close the current form window.

Create a process to view files

1. Create a new process.
Let's name this process **View a File Process**.
The Process Composer appears for you to create a process.
2. Click the **Start** node (green icon).
This is the first node of your process entry.
The **Start** window now appears with relevant fields.
3. Click the **Browse** option in the **Select initial data** field to search for a form.
4. Click the **Browse** tab in the **Find a form** window.
5. Select the **Select File Form** that you had created.
This is your first form.
6. Click **Choose** to confirm.
7. Specify the title in **Request title** field.
You can name the title as **Select File** or similar.
Leave the rest of the entries as is.
8. Click **Save**.
9. Drag and drop the **Human Task** from the **Task** column to your process work flow.
The **Task: Human Task** window appears.
10. Specify your element name in the **Element name** field.
You can name the title as **File** or similar.
11. Click the **Browse** option in the **Select form** field to search for a form.
12. Click the **Browse** tab in the **Find a form** window.
13. Select the **Document Viewer Form** that you had created.
This is your second form.
14. Click **Choose** to confirm.
15. Specify your button details in the **Add form button** field.
You can specify **Upload** as the **Button label** and keep the **Primary** setting as the **Button style**.
16. Select the **Document[Document0]** option in the **Feed data into form** field.
This will show up as a check mark your selected option.
17. Click **Insert a variable** in the blank field.
 - a) Select **Request** as your variable source.
 - b) Select **Input** as your variable type.
 - c) Select **Upload a file[File0]-File** as your variable type.

This option should automatically be define for you to choose.

- d) Click **Add** to add and confirm your variable.

18. Click **Save** to save your session.

Create an AARI process

Create an Automation Anywhere Robotic Interface (AARI) process work flow to address your business requirements. You create the process in the Process Composer that incorporates human and bot tasks.

- You must have a Bot Creator license.
- You must be assigned a custom role with the create folder permission.

Note: Each task, logic condition, and end point now supports the copy, paste, and cut elements from the bot editor. Additionally, you can double-click to add and replace items on the canvas. See [Behaviors supported in the Process Composer](#).

1. Create a process:
 - a) From your local machine, log in to your Control Room as a Bot Creator.
 - b) From the left pane, click **Automation**, and then click **Create new > Process**.
 - c) In the **Create process** page, enter a name for the new process.
Processes are saved in the \Bots\ folder by . Click **Browse** to change the default folder.
 - d) Click **Create & edit**.
 - e) **Optional:** Click the process name to rename it.
2. Add an initial form to the process by clicking **Start**.
3. From the **Start** panel, perform these steps:
 - a) Browse and **Select initial data form**.
 - b) In the **Request title** field, enter any text or insert a variable.
This is the input variable. A dynamic title is created for this request that will be displayed in the web interface and will serve as a reference.
You can use a Reference ID such as `ref ID = $RefId$`.
 - c) In the **Task name** field, enter the name of the task.
You can use a Reference ID such as `task ref ID = $RefId$`.
 - d) **Optional:** In the **Data privacy tag** field, enter a text or variable to generate hidden custom output.
 - e) Click **Apply**.
4. [Add Bot Task to AARI process](#).
The Bot Task runs a bot with inputs and outputs.
5. [Add Human Task to AARI process](#).
The Human Task displays a form that requires interactions by a user.
6. **Optional:** [Add Filter Task to AARI process](#).
The Filter task allows you to filter a variable according to your specific criteria.
7. **Optional:** [Add Process Task to AARI process](#).
The Process Task enables for you to run a process.

8. Optional: *Add Document Validation to AARI process.*

The Document Validation Task displays a validator for a document that requires validations.

9. Add a condition to the process by dragging the condition from the **Elements** panel.

You can choose **If/Else pair** or **Else if**.

10. From the **Condition** panel, perform these steps:

- a) **Optional:** Add a description in the **Description** field.
- b) **Optional:** Add a message in the **Display message** field.
The display message you enter is shown in the request view page in the web interface.
- c) Click **Add Condition** to add a condition.
You can choose a condition from the four available types: **Boolean**, **Datetime**, **Number**, or **String**.
- d) Click **Apply**.

11. *Add an End Point to AARI process.*

The End Process ends a process with a selected status while the Go to navigates to another tasks in a process.

You have now configured your AARI process

12. Optional: If you want to preview your bot or forms information in the Process Composer (**Edit process** page) in both your public and private workspace, follow these steps.

- a) Click the vertical ellipsis next to the **Bot Task** or the **Human Task**.
- b) Select either the **Preview bot** or **Preview form** option.
In the public workspace, these options display the **Bot name preview** or **Form name preview** page. The page enables you to quickly view a bot or form.
In the private workspace, these options display the **Edit Task Bot** or **Edit form** page in which you can make changes to your TaskBot or form.

Related tasks[Create your first bot](#)

Perform the following steps to create your first bot that prints the message, `Go be great!`, the Automation Anywhere version of `Hello World!`

[Create an AARI form](#)

Create an Automation Anywhere Robotic Interface (AARI) form to provide interaction between humans and bots. You can enter the required data using form elements that can be rendered in the web interface. You can add or remove form actions when creating the process.

Related reference[About the AARI process in Document Automation](#)

Document Automation uses Automation Anywhere Robotic Interface technology to manage the end-to-end document extraction process. When you create a learning instance in Document Automation, the system also creates an AARI process. Review the following guide to understand the logic.

Add Bot Task to AARI process

You can add a Bot Task to configure the settings.

- 1.** Add a **Bot Task** to the process by dragging the element from the **Element** panel.
- 2.** From the **Bot Task** panel, perform these steps:
 - a) Enter a name in the **Element name** field.
 - b) Enter the task name in the **Task name** field.

The task display name appears in the web interface as a reference. You can use a Reference ID such as `ref ID = $RefId$`.

- c) **Optional:** Select the **Hide this task after completion** check box.
After task completion, the **Bot Task** is not displayed to the user in the web interface.
To display the hidden task, select the **View hidden tasks** check box in the tasks view page of the web interface.
- d) Browse and select the TaskBot in the **Select Task Bot** field.
- e) In the **Run bot and dependencies using** section, select a label version .
You can choose **Latest version** (set by default) or **Production label**.
The bot deploys the version that you select.
- f) In the **Bot priority** section, reference your bot priority level.

Note: The bot priority level is a read-only label that shows **Low**, **Medium**, or **High** depending on the priority level that was set for the bot. Previously, the priority level was set to **Medium** for all the bots, but bot priority is now considered.

Important: If the priority of a task bot was changed, you need to browse for the task bot again in order to reflect the correct priority status for an existing AARI process.

- g) **Optional:** In the **Data privacy tag** field, enter a text or variable to generate hidden custom output.
Select the check box in **Input values** and specify a variable.
The variable input expected by the bot is mapped with the variable that will be populated when creating the request.
 1. Select a task in the **Process task** field.
 2. Select a type in the **Variable type** field.
You can choose **Input**, **Output**, or **Meta**.
See [AARI variable types](#).
 3. Specify your variable in the **Variable** field.

Note: Reference ID is a **Meta** variable type.

 4. Click **Apply**.

3. Click **Save**.

You have now configured the Bot Task in your AARI process.

Add Human Task to AARI process

You can add a Human Task to configure the settings.

1. Add the **Human Task** to the process by dragging the element from the **Element** panel.
2. From the **Human Task** panel, perform these steps:
 - a) Enter a name in the **Element name** field.
 - b) Enter the task name in the **Task name** field.
The task display name is displayed in the web interface as a reference. You can use a Reference ID such as `ref ID = $RefId$`.

- c) Select the **Hide this task after completion** check box.
After task completion, the **Human Task** is not displayed to the user in the web interface.
To display the hidden task, select the **View hidden tasks** check box in the tasks view page of the web interface.
- d) Select the **Make the form read-only** check box.
The **Human Task** does not require any input and executes automatically to the next task.
- e) Select the **Assign this task to the user who created this request** check box.
The task is automatically assigned to the user creating this request in the web interface.
- f) Select the **Auto-assign this task to** checkbox. You can select the following options from the drop-down:
- **The user who created the request:** The task is automatically assigned to the user creating the request in the web interface.
 - **The user who opens this task:** The task is automatically assigned to the user who opens the task in the web interface.
- g) In the **Task expiration time** field, select the time option.
You can choose from among the following options: **No expiration** (default), **1 hour**, **1 day**, **1 week**, **2 week**, **30 days**, and **Custom**.

Note: If you choose the **Custom** option, you must specify the time by the number of days, hours, and minutes. The maximum is **45 days**, and the minimum is **1 minute**. Days range from 0 to 45 days, and hours range from 0 to 23 hours. For minutes, if the hours and days are set to **0**, minute range is 1 to 59 minutes. However, if the hours and days are not set to **0**, minute range is 0 to 59 minutes.

- h) In the **Select form** field, browse and select the second form created.
This form displays the result.
- i) In the **Data privacy tag** field, enter a text or variable to generate hidden custom output.
- j) In the **Add form button** field, specify your button details.
- Specify a name in the **Button label** field.
 - Select a style in the **Button style** field.
You can choose between **Primary**, **Secondary**, or **Cancel**.
 - Click **Add button** to add any additional buttons.
- k) Select the check box in the **Feed data into form** field.
1. Select a task in the **Process task** field.
 2. Select a type in the **Variable type** field.
You can choose **Input**, **Output**, or **Meta**.
 3. Specify your variable in the **Variable** field.
-
- Note:** Reference ID is a **Meta** variable type.
-
4. Click **Apply**.

3. Click **Save**.

You have now configured the Human Task in your AARI process.

Add Filter Task to AARI process

You can add a Filter Task to configure the settings.

1. Add the **Filter Task** option to the process by dragging the element from the **Task** panel.

The filter task applies a filter to the process variable.

Ex: You have a table as an output of a form, and your output has an **Approved** column that contains **Yes** or **No** data in the rows, the filter task will be able to retrieve only rows with **Yes** as an output of the filter task.

2. From the **Filter Task** panel, perform these steps:

- a) Enter a name in the **Element name** field.

- b) Enter the task name in the **Task display name** field.

The task display name is displayed in the web interface as a reference.

- c) **Optional:** Select the **Hide this task** check box.

After task completion, the **Filter Task** is not displayed to the user in the web interface.

To display the hidden task, select the **View hidden tasks** check box in the tasks view page of the web interface.

- d) Enter a variable in the **Variable to be filtered** field.

- e) In the **Filtered type** field, select an option.

For example, for a dictionary variable, the **Check each key/value pair in the dictionary** or **Check entire dictionary** options are available for you to choose.

- f) In the **Filter criterion** field, select a condition.

After you select a condition, specify the **Source variable**, **Operator**, and **Target value** fields.

3. Click **Save**.

You have now configured the Filter Task in your AARI process.

Add Process Task to AARI process

You can add a Process Task to configure the settings.

1. Add the **Process Task** option to the process by dragging the element from the **Task** panel.

2. From the **Process Task** panel, perform these steps:

- a) Enter a name in the **Element name** field.

- b) Enter the task name in the **Task name** field.

The task display name appears in the web interface as a reference.

- c) **Optional:** Select the **Hide this task from users** check box.

After task completion, the **Process Task** is not displayed to the user in the web interface.

To display the hidden task, select the **View hidden tasks** check box in the tasks view page of the web interface.

- d) Select either the **Public folder** or **Private folder** and browse and select the process.

- e) In the **Data privacy tag** field, enter a text or variable to generate hidden custom output.

- f) Select the check box in **Input values** and specify a variable.

1. Select a task in the **Process task** field.

2. Select a type in the **Variable type** field.

You can choose **Input**, **Output**, or **Meta**.

3. Specify your variable in the **Variable** field.

3. Click **Save**.

You have now configured the Process Task in your AARI process.

Add Document Validation to AARI process

You can add a Document Validation Task to configure the settings.

1. Add the **Document Validation Task** option to the process by dragging the element from the **Task** panel.
2. From the **Document Validation Task** panel, perform these steps:
 - a) Enter a name in the **Element name** field.
 - b) Enter the task name in the **Task name** field.
The task name appears in the web interface as a reference.
 - c) **Optional:** Select the **Hide this task from users** check box.
After task completion, the **Document Validation Task** is not displayed to the user in the web interface.

To display the hidden task, select the **View hidden tasks** check box in the tasks view page of the web interface.
 - d) **Optional:** Select the **Auto-assign this task to** checkbox. You can select the following options from the drop-down:
 - **The user who created the request:** The task is automatically assigned to the user creating the request in the web interface.
 - **The user who opens this task:** The task is automatically assigned to the user who opens the task in the web interface.
 - e) Specify the ID in the **Document ID** field.
 - f) **Optional:** In the **Data privacy tag** field, enter a text or variable to generate hidden custom output.
Select the check box in **Input values** and specify a variable.
 1. Select a task in the **Process task** field.
 2. Select a type in the **Variable type** field.
You can choose **Input**, **Output**, or **Meta**.
 3. Specify your variable in the **Variable** field.

3. Click **Save**.

You have now configured the API Task in your AARI process.

Add an End Point to AARI process

You can add an end point to close your AARI process.

You can add the **End point** by dragging the **End process** or **Go to** from the **End point** panel to your process.

- From the **End point: End process** panel, perform these steps:

- a) Choose the type in the **End process status** field.
You can choose between **Completed, Failed, or Cancelled**.
 - b) **Optional:** Specify a name in the **Update request title** field.
 - c) **Optional:** Add a message in the **Display message** field.
The display message you enter is shown in the last step of your task in the request view.
 - d) Click **Apply**.
 - e) Click **Save** to save the process.
- From the **End point: Go to** panel, perform these steps:
 - a) In the **Select target task** option, specify the task by choosing **Bot Task** or **Human Task**.
 - b) Select the **Override the task assignment setting** check box and from the drop down, you can choose either **Unassign the task** or **Assign the task to the user who created the request**.
Depending on your choice, the task is unassigned or the user creating the request can automatically view the task assigned to them in the web interface.
 - c) Click **Save** to save the process.

AARI variable types

Data flow (workflow engine) is the core part of a process that moves data between each task. Tasks require variables in order to run properly and three types of variables are available: input, output, and meta-type variables.

Variable types

Input	Users can use this type of variable in the Process Composer to return values that went "in" a task.
Output	Users can use this type of variable in the Process Composer to return values that went "out" a task.
Meta	Users can use this type of variable in the Process Composer to return high-level information about the request of a task.

Variable entities

Two types of entities can hold variables:

Request	Requests can only hold meta-type variables and have the following form: <code>\$(meta variable name)]\$</code> This meta-type variable value is from the request.
Task	Tasks can hold three types of variables (input, output, meta) and have the following forms: <ul style="list-style-type: none"> • <code>\$(task>.<input output>[<variable name>]\$:</code> This variable value is read from the task input or output.

- `$(task).<meta variable name>$`: This meta-type variable value is read from the task.

Date time variables

Name	Entities	Description
<i>createdOn</i>	Request, Task	Shows the date when the request or task was created. Example: <code>\$(createdOn)</code> or <code>\$(Approval_Task.createdOn)</code>
<i>updatedOn</i>	Request, Task	Shows the date when the request or task was last updated. Example: <code>\$(updatedOn)</code> or <code>\$(Approval_Task.updatedOn)</code>

Dictionary variables

Name	Entities	Description
<i>assignedTo</i>	Task	Shows information about the user who is assigned to the task. Dictionary key: <code>{id}</code> , <code>{username}</code> , <code>{email}</code> Example: <code>\$(Approval_Task.assignedTo)</code>
<i>createdBy</i>	Request	Shows information about the user who created the request. Dictionary key: <code>{id}</code> , <code>{username}</code> , <code>{email}</code> Example: <code>\$(createdBy)</code>

Number variables

Name	Entities	Description
<i>executionCount</i>	Task	Shows the number of times the task was run. Example: <code>\$(Name_Bot.executionCount)</code>
<i>id</i>	Request, Task	Shows the numerical ID of a request or task. Example: <code>\$(id)</code> or <code>\$(Approval_Task.id)</code>
<i>assignedTo{id}</i>	Task	Shows the numerical ID of the user who is assigned to the task. Example: <code>\$(Approval_Task.assignedTo{id})</code>

Name	Entities	Description
<i>createdBy{id}</i>	Request	Shows the numerical ID of the user who created the request. Example: <i>%createdBy{id}\$</i>

String variables

Name	Entities	Description
<i>status</i>	Task	Shows the label of the button clicked (action) for a human task or the bot return code for a bot task (equal to failed when the bot fails). Example: <i>%Approval_Task.status\$</i> or <i>\$Name_Bot.status\$</i>
<i>title</i>	Request, Task	Shows the title of the request or task. Example: <i>%title\$</i> or <i>%Approval_Task.title\$</i>
<i>type</i>	Request	Shows the task type (equal to BOT for bot tasks and FORM for human tasks). Example: <i>%Task.type\$</i>
<i>assignedTo{username}</i>	Task	Shows the username of the user who is assigned to the task. Example: <i>\$Approval_Task.assignedTo{username}\$</i>
<i>createdBy{username}</i>	Request	Shows the username of the user who created the request. Example: <i>\$createdBy{username}\$</i>
<i>assignedTo{email}</i>	Task	Shows the email of the user who is assigned to the task. Example: <i>\$Approval_Task.assignedTo{email}\$</i>
<i>createdBy{email}</i>	Request	Shows the email of the user who created the request. Example: <i>\$createdBy{email}\$</i>

Use an Output variable

Users can create an output variable that is applicable for any process in order to display the output of a child process in the parent process.

Once a user has created a process in the Process Composer, they can create an output variable that can be called in the end process.

- Create an output variable:
 - a) Navigate to the **Output variables** section.
 - b) Click **Show**.

- c) Click the plus (+) icon.
The **Create variable** window appears for your to create a new variable.
- d) Specify the name of the variable in the **Name** field (ex: **output**).
- e) Select your variable type in the **Type** field (ex: **String**).
- f) **Optional:** Specify the variable information in the **Description** field.
- g) **Optional:** Specify a default variable in the **Default value** field.
In this step you need to insert a variable.
 - a. Select a source in the **Variable source** field (ex: **botTask**).
 - b. Select **Output** as a **Variable type** option.
 - c. Select a variable in the **Variable** field (ex: **output**).
 - d. Click **Yes, insert** to confirm your changes.
- h) Click **Create**.
You have now created a new output variable! This output variable is located in the **User-defined** variables in the **Output variables** section.
- Edit or delete an existing output variable:
 - a) Navigate to the **Output variables** section.
 - b) Select the three dots icon next the user-defined output variable (ex: **output**).
 - c) **Optional:** Select the **Delete variable** to delete the current variable.
 - d) Select the **Edit variable** to edit the current variable.
The **Edit variable** window now prompts for you to add any new changes to your current variable.
 - e) Click **Apply** to save your changes.
You have now modified an existing output variable.

Behaviors supported in the Process Composer

Process Composer tasks, logic conditions, and end points now support copy, paste, and cut from the bot editor. This also includes the ability for users to double-click and to replace items on the canvas.

Elements

Copy	Use CTRL + C to copy the data from the task.
Paste	Use CTRL + V to paste the copied data in your task.
Cut	Use CTRL + X to copy and remove data from your task.
Double-click to add	Double-click a task to add data to it.

Copy behaviors

When you copy a task in the canvas, these behaviors will occur:

Task types	Behavior
<ul style="list-style-type: none"> • Bot Task • Human Task • Filter Task • Document Validation Task • If • Else if • End process • Go to 	Properties are retained in the clipboard.
Else	Task is not retained in the clipboard.

Paste behaviors

When you paste a task in the canvas, these behaviors will occur:

Task types	Node selected	Behavior
<ul style="list-style-type: none"> • Bot Task • Human Task • Filter Task • Document Validation Task • If/Else pair 	None	Task is attached to the last node located before the end point (End process or Go to).
<ul style="list-style-type: none"> • Bot Task • Human Task • Filter Task • Document Validation Task • If/Else pair 	<ul style="list-style-type: none"> • End process • Go to 	Task is attached to the last node placed before the end point (End process or Go to).
<ul style="list-style-type: none"> • Bot Task • Human Task • Filter Task • Document Validation Task • If/Else pair 	<ul style="list-style-type: none"> • Bot Task • Human Task • Filter Task • Document Validation Task • If • Else if • Else 	Task is attached to the node.

Task types	Node selected	Behavior
<ul style="list-style-type: none"> End process Go to 	<ul style="list-style-type: none"> Bot Task Human Task Filter Task Document Validation If Else if Else None 	Paste is not allowed or disabled.
<ul style="list-style-type: none"> End process Go to 	<ul style="list-style-type: none"> End process Go to 	Task replaces the selected node.
Else if	<ul style="list-style-type: none"> If Else if 	Task is added as a new Else if node in the same line as the If or Else if and located in the last position before the Else .
Else if	<ul style="list-style-type: none"> Bot Task Human Task Filter Task Document Validation End Process None 	Task is not added to the canvas because this action is invalid.

Cut behaviors

When you cut a task in the canvas, these behaviors will occur:

Task types	Behavior
<ul style="list-style-type: none"> Bot Task Human Task Filter Task Document Validation Task 	Task is removed from the canvas by deletion but the clipboard retains task with all the properties .
<ul style="list-style-type: none"> If Else if 	Task is removed from the canvas by deletion but the clipboard retains task with all the properties. All child nodes are deleted from the canvas.
Else	Task is not removed or retained in the clipboard.
<ul style="list-style-type: none"> End process Go to 	Task is removed from the canvas by deletion but the clipboard contains task with all the properties.

Double-click to add behaviors

When you double-click to add in the canvas, these behaviors will occur:

Task types	Node selected	Behavior
<ul style="list-style-type: none"> • Bot Task • Human Task • Filter Task • Document Validation Task • If/Else pair 	None	Task is attached to the last node located before the end point (End process or Go to) of the main branch (farthest left).
<ul style="list-style-type: none"> • Bot Task • Human Task • Filter Task • Document Validation Task • If/Else pair 	<ul style="list-style-type: none"> • End process • Go to 	Task is attached to the last node located before the end point (End process or Go to).
<ul style="list-style-type: none"> • Bot Task • Human Task • Filter Task • Document Validation Task • If/Else pair 	<ul style="list-style-type: none"> • Bot Task • Human Task • Filter Task • Document Validation • If • Else if • Else 	Task is attached to the selected node.
<ul style="list-style-type: none"> • End process • Go to 	<ul style="list-style-type: none"> • Bot Task • Human Task • Filter Task • Document Validation • If • Else if • Else • None 	Double-click is not allowed or disabled.
<ul style="list-style-type: none"> • End process • Go to 	<ul style="list-style-type: none"> • End process • Go to 	Task replaces the selected node.
Else if	If	Task is added as a new Else if node in the same line as the If or Else if and in the last position before the Else .

Task types	Node selected	Behavior
Else if	<ul style="list-style-type: none"> • Bot Task • Human Task • Filter Task • Document Validation • Else if • End Process • Go to • None 	Task is not added to the canvas because this action is invalid.

Delete an AARI process

As an AARI administrator or a user with **Delete from Public** permission, you can delete an AARI process in the public workspace.

While deleting a process, keep the following considerations in mind:

- You can delete processes that have open requests.

After a process is deleted, you cannot access the process even if the requests still exist. The scheduled bots can still be executed, but the forms cannot be submitted. If you republish the same process, the old requests can be restored and team permissions can be created again.

- You cannot delete checked-out processes.

1. Log in to the Control Room as an AARI administrator or a Bot Creator user.
2. On the left pane, click **Automation**.
A list of available and forms is displayed.
3. Select the process you want to delete, open the actions menu (vertical ellipsis), and click **Delete process**.

You must first delete the process in order to delete the bots or forms within the process.

4. Select **Yes, delete** to confirm.

When the process is deleted from the public workspace, it is removed from the process management page in the web interface. Additionally, if the process is already assigned to any AARI user or team, access is removed after the process is deleted from the public workspace.

Run an AARI process

In the Control Room, as a Bot Creator, you can run a process from the Process Composer in the private workspace.

Keep in mind the following considerations:

- When the process is executed in the private workspace, the Bot Creator can create a request and enter data in the initial form.

In the private workspace, the bots are executed on the default device of the Bot Creator.

- Requests created from the private workspace can be viewed only by the user creating the request.

The AARI administrator cannot view the processes executed from the private workspace in the process management page.

1. Log in to the Control Room as a Bot Creator user.

2. On the left pane, click **Automation**.
A list of available and forms is displayed.
3. Click the process name.
4. When the process opens in the Process Composer, click **Run**.
A window opens, where you are prompted with the initial form.

Check in an AARI process

Check in an Automation Anywhere Robotic Interface (AARI) process to the public workspace from the private workspace to make it available for other users.

- You must have a Bot Creator license.
- You must be assigned a custom role with the following permissions:
 - Required: Check-in and check-out permission
 - Optional: Create folder permission
 - Optional: View packages permission
- To check in a process with dependent folders and files, ensure you have the following:
 - Create folder permission.
If you are checking in a process from your private workspace and if the folder in which the process is present does not yet exist in the public workspace, you must have the create folder permission to successfully check in the process.
 - Check-in permission on the dependency folder.

1. Log in to the Control Room as a Bot Creator user.
2. On the left pane, click **Automation**.
A list of available and forms is displayed.
3. Select the process you want to check in, open the actions menu (vertical ellipsis), and click **Check in process**.
4. In the **Check in Process** window, add your comment and click **Check in**.
The process appears in the same folder structure in the public workspace.

Check out an AARI process

Check out an Automation Anywhere Robotic Interface (AARI) process from the public workspace to create an editable copy of the process.

- Ensure you have the Bot Creator license to check out a process to your private workspace.
 - To check out a process with dependent folders and files, you must have the following:
 - Create folder permission
 - Check-out permission on the dependency folder
1. Log in to the Control Room as a Bot Creator user.
 2. In the public workspace, click **Bots > My bots**.
The **My bots** page is displayed with the list of folders or files containing the processes.
 3. Select the process, open the actions menu (vertical ellipsis), and click **Check out process**.
The process appears in the same folder structure in the private workspace.

Import an AARI process

You can import an Automation Anywhere Robotic Interface (AARI) process from one Control Room to another.

- Ensure that the following rights are enabled to import processes:
 - Import process permission
 - Create folder permission, if it is required
 - Check-in permission
 - Manage package permission
- The process directory path is case-sensitive. So ensure that the export and import paths use the same case in the Control Room to avoid any process execution failure.

In this task, the required process is already exported and an email is received with a link to the zip file containing the package to import.

Any previously exported process is located in the public repository and must be imported and checked in so that it can be deployed from the new Control Room.

The imported process will be available in the public repository.

1. On the left pane, click **Automation**.
A list of available and forms is displayed.
2. Click **Import bot** and browse and select the process to import.

Note: This option currently applies to both bots and processes.

3. Select the option to import a process into the private or public workspace.
4. Set the option for importing the process based on whether a previous version of the process resides in the destination location.
During the import, if a file already exists, you can choose to either skip the process during import or overwrite the existing process and file.
5. Click the **Import bot** icon.
6. Click **Check in**.
On completion, the imported process is placed in the public repository and is ready for deployment from the new Control Room.

Import process dependencies

When you import an AARI process, you might encounter some issues where the import might not work as intended. This topic shows you the scenarios for you to import successfully.

Overview

For these scenarios, a **Parent** process has dependencies with a **Child** process and **Test** form, and needs to import from **Environment A** to **Environment B**. To goal is to successfully import from **Environment A** to **Environment B**.

Parameters

- **Parent** process uses **Child** process and both uses **Test** form in **Environment A**.
- Export **Child-only** zip file that contains **Child** process and **Test** form.

Note: You have to manually export the proper files.

- Export **Parent-only** zip file that contains **Parent** process and **Test** form.
- Export **Parent-and-Child** zip file that contains **Parent** process, **Child** process, and **Test** form.

Scenario A (Best case)

1. **Environment B** has no files.
2. Import **Child-only** zip file into **Environment B**, files of **Child** process and **Test** form will now exist in the repository.
AARI receives a bulk import event of **Child** process and **Test** form files, and a new process called **Child Process** is successfully created..
3. Import **Parent-only** zip file into **Environment B**, files of **Parent** process and **Test** form will now exist in the repository.
AARI receives a bulk import event of **Parent** process and **Test** form files, since **Child Process** exists in AARI, then **Parent Process** is successfully created.
4. Your import is **successful** as the **Child Process** and **Parent Process** are created in AARI.

In this scenario, the import from **Environment A** to **Environment B** was successful as the **Child-only** zip file was imported before the **Parent-only** zip file, therefore the **Child Process** and **Parent Process** was successfully created in AARI.

This is the best case scenario for a successful import.

Scenario B (Conditional Case)

1. **Environment B** has no files.
2. Import **Parent-only** zip file into **Environment B**, files of **Parent** process and **Test** form will now exist in the repository.
AARI receives a bulk import event of **Parent** process and **Test** form files, because **Child Process** does not exist, then this **failed** to created a **Parent Process**.
3. Import **Child-only** zip file into **Environment B**, files of **Child** process and **Test** form will now exist in the repository.
AARI receives a bulk import event of **Child** process and **Test** form files, and a new process called **Child Process** is successfully created.
4. Import **Parent-only** zip file again with **Overwrite existing files into** option selected to **Environment B**, files of **Parent** process and **Test** form will then overwrite in repository.
AARI receives a bulk import event of **Parent** process and **Test** form files, since **Child Process** now exists in AARI, then **Parent Process** is now successfully created.

Important: If the **Overwrite existing files into** is not select, then no bulk import event is generated because files of **Parent** process and **Test** form already exists in repository, therefore **Parent Process** cannot be created in AARI.

5. Your import is **successful** as the **Child Process** and **Parent Process** are created in AARI.

In this scenario, the import from **Environment A** to **Environment B** can fail if the **Parent-only** zip file was imported before the **Child-only** zip file, as the **Parent Process** can only be created if the required dependencies from the **Child Process** exists, and since **Child Process** did not exist in the repository, then **Parent Process** could not be created.

In order to workaround this issue, the user can import the **Parent-only** zip file again with **Overwrite existing files into** option selected to overwrite the existing repository, only after the **Child Process**

was created, to successfully create **Parent Process**. This is a conditional success, only if the **Overwrite existing files into** option was selected by the user, if this option was not selected then the **Parent Process** cannot be created.

To avoid this issue, the user should use **Scenario A** for a successful import experience.

Scenario C (Worst case)

1. **Environment B** has no files.
2. Import **Parent-and-Child** zip file into **Environment B**, files that contains **Parent** process, **Child** process, and **Test** form will now exist in the repository.

AARI receives a bulk import event of **Parent** process, **Child** process, and **Test** form files. However, due to the fact that the **Parent** process and **Child** process relations are not known from the bulk import event, the **Parent** process **might** first be processed. Since the **Child Process** does not exist, then this **failed** to created a **Parent Process**.

3. Your import **failed** as the **Child Process** and **Parent Process** were not created in AARI.

In this scenario, the import from **Environment A** to **Environment B** failed since when the **Parent-and-Child** zip file was imported because the bulk import event does not understand the relation between **Parent** process and **Child** process. The the bulk import event might process the **Parent** process before the **Child** process, which means the **Parent Process** cannot be created as the **Child Process** does not exist, therefore no new process is created in AARI.

To avoid this issue entirely, the user should use **Scenario A** for a successful import experience.

Export an AARI process

You can export an Automation Anywhere Robotic Interface (AARI) process from one Control Room to another.

- Only processes within the public workspace can be exported. To export a process, check in the process into the public workspace.
- Ensure that you have the correct role and permissions to export the process, including the **View package** permission.
- To receive the link to the exported package through email, enable SMTP.

[Email server settings](#)

- To export the process from one Control Room to another, both Control Rooms must be the same version.

The Control Room maintains a maximum of 10 GB of historical export files in the download directory. Files are deleted on a first-in/first-out basis in order to maintain this threshold.

1. On the left pane, click **Automation**.
A list of available and forms is displayed.
2. Click the **Export bot**, browse the public directory, and select the process to export.

Note: This option currently applies to both bots and processes.

The selected process as well as the required dependencies are displayed.

3. Click **Next**.
The process and its dependencies are ready for export and displayed in the **Review Dependencies** window.
4. Click **Next**.
All related packages are displayed.

5. Select the necessary packages associated with the process to export.
You can select **Exclude process packages** to remove all packages from the export.
6. Click **Export bots and files**.
If you have configured SMTP, an email is sent, which contains a link to the zip file of the exported package.
If you have not configured SMTP, perform the following steps to access the link to the zip file of the exported package:
 - a) Navigate to **ACTIVITY > Historical**.
 - b) Search and view the historical activity of the exported package.
 - c) Click **Download exported zip file**.
A link to download the zip file is displayed.
7. Use the link to download the zip file and save it to a location for importing it to another Control Room.

Import the process to an Control Room.

URL parameters

This topic is to help you reference the URL parameters for supported elements.

Overview

You can call a specific AARI process using its ID and pass parameters through the URL to populate the initial forms based on the form field ID. This method of population is also supported for initial forms in the iFrame widget for AARI Integrations.

Important: The supported elements that can construct URL parameters are the **Date, Number, Text Bot, Time** elements.

Remember: The URL value will always overwrite the default value of the form fields.

Data format - for certain elements, there are data format can be accepted, these data format are the following:

- **Text Box, Text Area, and Rich Text Editor** elements accepts **String** type data
- **Number** element accepts **Double** type data.
- **Date** and **Time** elements accepts **RFC 8601** date (local time) type data (ex: 2021-06-10T00:00:00.000)
- **Radio Button** and **Dropdown** elements accepts **String** type data
- **Check Box** element accepts **String** type data.

Parameter Mapping - for certain elements, the mapping of different parameters are the following:

- **Text Box, Text Area, and Rich Text Editor** element
 - **Element ID** shows the value after the element ID become the default element or input value.
 - Example:
 - `TextBox1=MyValue`
 - `TextArea2=MyLooooooooooooongValue`
 - `RichTextEditor3=AnUnformattedString`

- **Number** element
 - **Element ID** shows the value after the element ID will become the default element or input value.
 - Example: `Number2=123.99`
- **Date** and **Time** elements
 - **Element ID** shows the value after the element ID will become the default element or input value.
 - Example:
 - `Date1=2021-06-10T00:00:00.000`
 - `Time0=2021-06-10T23:59:17.000`
- **Radio Button** and **Dropdown** elements
 - **Element ID** shows the value after the element ID will become the default element or input value.
 - Example:
 - `RadioButtonGroup3=TheDefaultOption`
 - `Dropdown0=TheDefaultOption`
- **Check Box** element
 - **Element ID** shows the value after the element ID will become the default element or input value.
 - Example: `CheckBoxGroup1_1=TheOption2`

Delimiter - you can use the **&** symbol between parameters

Password element properties

The **Password** element is now available for the web interface, this topic shows the key functions of this element.

Overview

The **Password** element enables you to add password fields to your forms that can be processed in the web interface. This element has specific behaviors for usage in the web interface.

These behaviors are the following:

- The value of the password field is encrypted when the user submits a form (initial form or as part of a **Human Task**).
- When another user accesses the same form after submission (read-only view of initial form or **Human Task**), they cannot view the password field as it is encrypted.
- Since the password field values are encrypted, they cannot be used in the **If/Else** condition of a process.
- Only the encrypted password field values are stored in the database. The decrypted values are not stored.
- When you pass the encrypted password field value through a credential variable input to a bot inside the process, the encrypted password field value is decrypted by the bot during deployment by using an instantaneous key from the credential vault. No other configuration is required.

When you create a form and use this password element, the element is similar to the **Text Box** element with the exception that your text inputs in these fields are now **masked**.

Properties - the password element will have these key form properties

- **Element ID**

- This field can be editable or overwritten by the user who created the form
- The field takes a unique default value (e.g. default value could be **password1**)

Note: The Bot Creator can reference this field and is meant for internal use.

- **Element label**

- This field can be editable or overwritten by the user who created the form
- A default label can be set (e.g **Password**)
- The options to make the password fields required or read only.

Deploy processes

AARI on the web interface provides a dedicated workspace to organize processes, create requests, and run and view tasks. Managers can create new teams and manage their teams' roles and deployment of tasks.

You can access AARI from the Automation 360 home page by clicking the **Explore AARI** link which provides a shortcut to the AARI web interface.

The screenshot shows the Automation Anywhere Home dashboard. It features a 'Getting started' section with a 'Create a bot' button, an 'Insights' section with a link to 'Explore Bot Insight', a 'Recently visited pages' section with several links, and an 'AARI' section with a link to 'Explore AARI'. The 'AARI' section is highlighted with a red border.

The checked-in processes are available on the web interface and can be assigned to the teams so that the team members can create requests and complete tasks.

The three main components involved in deploying a process are as follows:

- *Team management*
- *Process management*
- *Request management*

Deployment workflow

The following workflow describes the steps involved in deploying a process by using the web interface:

1. [Create an AARI team and assign team roles to members.](#)
2. [Assign an AARI team to a process.](#)
3. [Create a request and complete a task.](#)

Other tasks

Depending on the requirement, you can also perform the following tasks:

- As an AARI manager, you can either assign or unassign tasks to your team members.

[Assign or unassign a task .](#)

- To clear the memory space, as an AARI user, manager, or admin, you can delete the requests that are no longer required.

[Delete a request.](#)

- To make process selection easier at the time of request creation, as an AARI user or manager, you can view, pin, or search for your assigned processes.

[View and search for a process.](#)

- As an AARI user, to quickly search for a specific request created, you can filter and search for that request.

[Filter and search for a request.](#)

- As an AARI user, when you have many tasks created from multiple requests, you can filter and search for a specific task.

[Filter and search for a task.](#)

- You can edit your process in the **Process** page of the web interface.

[Configure an AARI process](#)

- As an AARI admin, you can edit bots to set parameters, enable virtual window, and assign teams to bots.

[Configure an AARI bot](#)

Related concepts

[AARI web interface users](#)

Various users are involved in AARI on the web interface and each user contributes in different ways to help automate the business requirements.

[Reference ID properties](#)

The reference ID is a unique key reference that help you identify your related processes and requests. The reference ID is also different for teams, process, and bots.

Team management

Team management is an essential function of AARI in the web interface. The basis of request and process assignment is dependent on the team setup.

Overview

The team configurable in AARI helps business managers to define the following aspects:

- How a request can be created
- How a request is visible to the other users
- Who can read, update, or delete requests

Team structure

A team contains users with specific team roles—admin, owner, and member. The admin has the ability to modify their team. By default, the AARI manager is the admin of their team. They can create new teams, manage existing teams, assign team roles (admin, owner, member) to members, and add members to their team. As an admin, an AARI manager can add other admins to their teams. A team can have more than one admin but must have at least one admin. To access a process and create new requests, the AARI manager must request the AARI admin to assign the AARI manager's team to a process.

An AARI admin can also simultaneously add multiple users with similar roles (custom role) to the AARI team. The custom role in the Control Room is aligned with a team in AARI on the web, and the behavior of the enhanced team setup is as follows:

- The users added with the custom role are assigned a **Member** role within the team. This role cannot be changed to **Owner** or **Admin**.
- You cannot view these users added with the custom role in the **Users** tab of the **Manage > Team** page.
- If a user is added through the custom role and also added manually to the team, their role in the team will be the same as the role assigned to them manually. For example, if the user is a **Member**, they will continue to have the **Member** role whereas if the user is an **Owner**, they will be assigned the **Owner** role in the team.
- If the user is no longer part of a custom role, the user will also not be a part of the team.

For example, create a custom role (aari_role_finance) in the Control Room and add the required users (aari_user1, aari_user2, aari_mngr1) to this role. You can now add this custom role, aari_role_finance, to a team in AARI on the web, and the users associated with this role are automatically added to the team. The team role of the users (aari_user1, aari_user2, aari_mngr1) is **Member**. The team role of these users cannot be changed from **Member** to either **Admin** or **Owner**. If aari_user2 is added as a part of aari_role_finance and also added manually through the **Users** tab and the role is **Owner**, then the team role of this user is retained as **Owner**.

Team types

Each team is configured to a team type (shared or private) and depending on that type, requests that can be viewed and accessed by members of that team might change.

- **Shared**: All the requests can be viewed by admins, owners, and members of that team.

- **Private:** Requests can be viewed only by the users creating those requests and the owner and admin of the team.

The team roles are based on the Control Room role assigned to the user. Each team role has a subset of permissions and actions that can be performed by that role. These sets of permissions vary between the shared and private team types.

Related concepts

[AARI web interface users](#)

Various users are involved in AARI on the web interface and each user contributes in different ways to help automate the business requirements.

Process management

A process contains human tasks and bot tasks. The AARI teams can use the process to automate their tasks by creating requests.

The AARI admin performs the global process management tasks. The AARI admin can view the checked-in processes from the Control Room and assign teams to a process for request creation.

You can view your requests on the **Processes** page. For easy access to a specific process, you can sort the processes by name in ascending or descending order and toggle the pinning of a process. The responsive view of the **Processes** page adjusts the display to your screen size. To guide with your team assignment, you can also reference the team from which a request is created by referring to the team name added in the process tile on the **Processes** page.

Request management

A request must be created to automate processes to complete assigned tasks. Members of a team create requests and complete the corresponding tasks.

Requests must always be created within a team. This ensures that the teams assigned to the same process cannot see each other's data anymore. By default, an AARI user, selected as an owner or member of their team, can create requests because their role has the **AARI user** license, which enables them to access the web interface and create requests.

The structure of request creation is as follows:

- An AARI user (team owner or member) can access and view all the processes that are assigned to a team on the **Processes** page.
- The AARI user must provide all the required information in an **initial form**.
- The bots and human tasks run in the **request view** page, which contains high-level details of the tasks.
- The task information is displayed in the **Requests** page, for the AARI user to verify.
- The AARI user can view their requests on the **Requests** page. They can manage or sort their existing requests by using a filter.
- A request can be created by either a user or a bot on the **Edit Process** page. If the request is created by a user, the process is displayed on the **Processes** page. If the request is created through a bot, the user cannot create a request or view the process.

Reference ID properties

The reference ID is a unique key reference that help you identify your related processes and requests. The reference ID is also different for teams, process, and bots.

Overview

The main objective of the reference ID is to help the user quickly identify all associated processes and the number of requests created from a process.

Requests

A reference ID is created from a **Process key**, a unique text input, that a user can enter when they edit their process. When the user configures their process key, it creates a prefix that corresponds to their process.

Key enhancements:

- The **Reference** column in the **Requests** page shows the numbers of reference ID (e.g. **2-42, 98-10, MAIN-5**).
- The **Process key** and number of request iterations helps the user identify the sequential consistency among the number of requests for a given process (e.g. A **Finance** process with the **FIN** process key and number of new requests shows **FIN-1, FIN-2, FIN-3, FIN-10**).

URL enhancements:

- The **Requests** URL is now changed to `entity/ref/:ref` from `entity/:id`.
- The user can access their requests directly if they enter the **reference ID** (ex: `/aari/#/requests/all#/requests/ref/2-34`)
- If the user opens any request using **Request ID**, the URL now redirects using **Reference**. For example, consider the **Request ID** as 896 and **Reference** as 2-34 for a request. If the user views the request using the **Request ID** (`/aari/#/requests/all#/requests/896`), the URL will redirect using the **Reference** (`/aari/#/requests/all#/requests/2-34`).

Scenario - Create a process key to view reference ID

1. You edit a **Beta** process to create a **Process key** called **ALPHA**.
2. You create multiple requests from **Beta** process.
3. For each requests created from the **Beta** process, the **ALPHA** process key will iterate one time.
4. You access the **Requests** page and view the **Reference** column.
5. The **Reference** column shows **ALPHA-1, ALPHA-2, ALPHA-3**, this is the **reference ID**.
6. You can now view the **reference ID** for all related processes.

Bot/Process/Team

For **Bot**, **Process**, and **Team**, the function is different compared to **Request**. The **request ID** from a previous environment is now replaced by the **reference ID**, this is to improve the single tenant experience by making a logical sequence to a referential number.

URL enhancements:

- The **Edit Process** page now shows an updated URL (ex: `/aari/#/manage/process/ref/96`) where the user can directly access a process when they enter the **reference ID**.

- The **Edit Team** page now shows an updated URL (ex: /aari/#/manage/team/ref/123) where the user can directly access a team when they enter the **reference ID**.

Upgrade changes in AARI from A360.21 or later versions

From version A360.21 or later, there is a change in how the teams work in AARI on the web interface. Advanced team management now helps business managers define how a request can be created. They can also specify who can view or delete requests.

To ensure that there is no discontinuity in the existing behavior for users who had any access to a process or created requests from a process (regardless of existing team assignment), the following conditions should be maintained:

- The user's access to create a request for a specific process is retained.
- The user's access to view the requests from a process regardless of the team they were part of is also retained.

How existing teams are changed

To maintain the current access to processes and the current teams, the existing teams remain with the following:

- Existing process assigned to them.
- Same members assigned to the team.
- The team type is configured to shared. This ensures that all the members of the team can view the migrated processes and requests.
- Members of the team have one of the following team roles:
 - AARI manager or AARI admin - admin role
 - AARI user - member role

To maintain the current access to requests, new teams are created for each process and the new team has the following:

- Existing processes assigned to the team are named "Teams Migrated for Process X" where X is the process ID. This helps reference the migrated processes. Teams are created for existing processes with this name.
- Users who had access to the process previously are assigned to this team regardless of their existing team assignment, and the team is assigned to the process.
- The team type is configured to shared.
- Members of the team have one of the following team roles:
 - AARI manager AARI admin
 - AARI user

Previously, the AARI managers could create requests without assigning the processes to teams. After the upgrade, they must create teams and ask the AARI admin to assign their team to a process in order to create new requests.



Attention: After the migration process and the creation of the migrated team, in the request creation, there will be two processes (one for each team) for you to select. The two processes will have different behaviors for the request visibility.

Example

The following scenario helps illustrate how the upgrade works.

Consider a process named "Loan Closing," with process ID 47. Georges is a user AARI admin role in the Control Room.

Before Upgrade

Two teams HR and IT have access to the Loan Closing process and the team structure is as mentioned in the table below.

HR		IT	
User Name	Control Room Role	User Name	Control Room Role
Bob	AARI manager	Grace	AARI manager
Carol	AARI user	Steve	AARI user
Debby	AARI user	Debby	AARI user

The behavior before the upgrade is as given below:

- Users from the HR team can see requests created in the IT team and vice versa.
- Bob and Grace can assign the processes that have been previously assigned to them by Georges to the HR and IT team respectively.
- Bob can manage the HR team and similarly, Grace can manage the IT team such as add members, assign processes, rename the team, so on.

After Upgrade

The two initial teams (HR and IT) still remain and additionally one new team (named Team Migrated for Process 47) is created during the upgrade. The team structure of all the three teams are mentioned in the table below:

HR			IT			Team Migrated for Process 47		
User Name	Team Role	Control Room Role	User Name	Team Role	Control Room Role	User Name	Team Role	Control Room Role
Bob	Admin	AARI manager	Grace	Admin	AARI manager	Bob	Admin	AARI manager
Carol	Member	AARI user	Steve	Member	AARI user	Carol	Member	AARI user
Debby	Member	AARI user	Debby	Member	AARI user	Debby	Member	AARI user
					AARI user	Grace	Admin	AARI manager
						Steve	Member	AARI user

The behavior of the teams after the upgrade is as given below:

- Members from the HR team cannot see the requests created in the IT team and vice versa anymore.

- As Debby is a part of both HR and IT team, this user can create requests in both the teams. Two different process cards are displayed to the user during request creation.
- Old requests created inside the HR and IT teams are treated like they were created inside the common team named Team Migrated for Process 47 which has only the Loan Closing process (47) assigned to it.
- Members from both HR and IT teams are all part of Team Migrated for Process 47 and so they can access the old requests. Deleting the team Team Migrated for Process 47 deletes the requests associated with it, so old requests access is removed and cannot be restored.
- Members from HR or IT team can create requests inside the team Migrated for Process 47 and those requests are visible to all the members of the HR and IT team.
- Bob and Grace can manage the HR and IT team respectively as well as jointly manage the Team Migrated for Process 47. This means they can add members to the team, rename the team, remove members from the team, so on.
- Bob and Grace can now only view the processes assigned to their teams by Georges.

Important: During the upgrade, issues with team admin assignment might occur intermittently, whereby either the creator of the team is incorrectly assigned the member role instead of the team admin role or other team members are assigned the team admin role instead of the member role. After the upgrade, the AARI administrator must always verify the team admin assignment.

The following example explains the team admin assignment issue:

Before upgrade: Bob creates the HR team and has the AARI manager role, with Carol, Debby, Grace, and Steve as team members and having AARI user roles.

After upgrade: Bob is assigned the team admin role along with Carol. Debby, Grace, and Steve are assigned the team member roles. In this case, Carol is incorrectly assigned the admin role instead of the member role. The AARI administrator must verify the team admin assignment and change Carol's role to team member.

Create a request and complete a task

An AARI user can create a new request from processes that is their team is assigned to, enter required information in an initial form, and complete tasks.

Ensure you have completed the following:

- Provided a system-created **AAE_Robotic_Interface User** role for the AARI user.
- Assigned the AARI user license.
- Have access to the web interface.

1. Log in to the web interface as an AARI user.

As an AARI user, you are now assigned to a team with an owner or member team role, created by the AARI manager or admin.

2. Navigate to the **Processes** page.

This page shows all available processes that your team was assigned to by the AARI admin.

3. Select an assigned process.

The initial form appears and shows the required fields for you to complete. These fields are from supported interactive form elements.

Important: Processes now includes team names associated to the process that the team is assigned to. The **Team Migrated For Process** team name indicates that the process is available to team members who had previous access to that process, regardless of team assignment, before the Automation 360 upgrade.

4. Complete the required information to the initial form.
You can also fill your initial forms via the URL parameters that is for your **Date**, **Number**, **Text Box**, and **Time** elements.
5. Optional: To view the request in a different tab, select the **Open request in New Tab** option.
6. Click **Submit** to confirm the information and progress.
Optionally, you can click **Cancel** to discard your changes.
7. View the request view page.
Your process is now running, and you might be prompted to complete pending tasks in the request tabs.
8. Complete the required task information in the request tab.
As the bot completes its task, it might prompt you to take over and complete the remaining steps.
9. View your request status.
Your request is now completed.
10. Navigate to **Requests > All requests** to view all requests created in the team.
11. Optional: Click **Create request** button to create a new request from the **Request** page.

Delete a request

An AARI user, manager, or administrator can delete requests that are no longer required. Deleting requests helps clear the memory space. You can also recover a deleted request if necessary.

Ensure you have completed the following:

- Assigned a system-created **AAE_Robotic_Interface User** role for the AARI user, **AAE_Robotic_Interface Manager** for the AARI manager, or **AAE_Robotic_Interface Admin** role for the AARI administrator.
- For the AARI user, manager, or admin:
 - Assigned the AARI user license.
 - Provided access to AARI on the web.

Only requests that are in **Aborted**, **Cancelled**, **Failed**, or **Completed** status can be deleted.

- An AARI administrator can delete any request.

Note: The AARI administrator is the only user who can permanently delete requests.

- The AARI manager can delete requests of the team for which they are the owner.
 - The AARI user can delete only the requests they have created.
-

Important: Files that are associated with a process is deleted when the request are deleted or are automatically deleted after 90 days.

1. Log in to the web interface.
2. Navigate to the **Request** tab.
3. From the list of requests, select the request or requests you want to delete and click the delete icon.
A confirmation message appears to confirm the deletion.
4. Click **Yes, delete** to delete the selected requests.

5. Optional: To recover a deleted request or requests, perform these steps:
 - a) Navigate to the **Recycle Bin** tab.
 - b) Select the requests you want to recover and click the recover icon.
A confirmation message appears to confirm recovery of the request.
 - c) Click **Yes, recover**.
The requests are recovered and appear in the **Requests** tab.

Create an AARI team and assign team roles to members

An AARI manager is a team admin who can create new teams, add members to their team, and assign new team roles. AARI admin can also configure a team but does not have a team role.

Ensure you have completed the following:

- Provided a system-created **AAE_Robotic_Interface_Manager** role for the AARI manager.
- Provided a system-created **AAE_Robotic_Interface_Admin** role for the AARI admin.
- Have access to the web interface.

1. Log in to the web interface as an AARI manager or admin.

2. Navigate to **Manage > Team**.

The **Team** page enables the AARI manager or admin to view all of their teams and provides the option to create a new team.

3. Click **Create new team**.

A **Create new team** window prompts for the AARI manager or admin to enter the team details.

4. Enter a team name in the **Team Name** field.

5. Optional: Enter a description in the **Description** field.

6. Select a user from the drop-down in the **Team admin** field.

7. In the **Request Visibility** field in the **General** tab, select **Shared** or **Private**.

If you select the **Shared** option, then all the requests that are created are accessible to members of the team. If you select the **Private** option, then a request will be available only to the member who created that request and the owners and admins of the team.

8. Add members to the team by choosing one of the following options:

Option	Steps
Users	<p>a. Click the + (plus) icon. The Add members window appears. Use it to search for members to add.</p> <p>b. Search by using name, email, username, or role in the search bar.</p> <p>c. Select the member from the displayed list.</p> <p>d. Click Add & save. Members are now successfully added to the team.</p> <hr/> <p>e. Optional: To remove a team member, select the member and click the trash icon.</p> <hr/> <p>f. Navigate to Roles next to each member name. Each member's team role is set to Member, by default.</p> <p>g. Click Member to change the team role when applicable.</p> <p>h. Select Member, Owner, or Admin to designate the team role.</p> <hr/> <p>Important: A team must have at least one Admin as a member. Only the AARI manager can be assigned the Admin team role because the roles are based on theControl Room roles assigned to the user. A team, however, can have more than one admin.</p> <hr/>
Roles	<p>a. Click the + (plus) icon. The Add roles window appears. Use it to search for roles to add.</p> <p>b. Search for a role in the search bar.</p> <p>c. Select the role from the displayed list.</p> <p>d. Click Add & save. Roles are now successfully added to the team.</p> <hr/> <p>e. Optional: To remove a role, select the role and click the trash icon.</p> <hr/>

9. Optional: Click the **Processes** or **Bots** tabs respectively to view the assigned processes or bots.

10. Click **Close**.

11. Optional: To edit an existing team, click the team's name in **Team** column within **Team Setup** page. The AARI manager or admin can edit a team to update their team setup or click **Delete** to erase the team entirely.

Assign an AARI team to a process

An AARI admin can configure processes in the web interface and assign teams to a process for request creation. They access the web interface to view and manage processes in the **Process Setup** page.

Ensure you have completed the following:

- Provided a system-created **AAE_Robotic_Interface Admin** role for the AARI admin.
- Have access to the web interface.

As an AARI admin, their key function is to assign teams to a process.

1. Log in to the web interface as an AARI admin.

2. Navigate to **Mangage > Process setup**

The **Process Setup** page enables the AARI admin to view all of the check-in processes from the Control Room and assign teams to a process.

3. Click on a process.

An **Edit Process** window appears and shows related information about the process such as the process name, description, tags, and teams.

4. Edit the **Process name field if necessary.****5. Optional: Enter a description in the **Description** field.****6. Click **Add tag** in the **Tags** field to add tags to the process.**

The **Add tag** window appears to search for tags to add.

7. Search for a tag description in the search bar.**8. Click on their name to confirm the tag.****9. Click **Add**.****10. Select the scheduler user from the drop-down menu in the **Scheduler** field.**

Note: The **Global scheduler** option is selected by default if a scheduler is not set for any process.

11. Select the **by user (default) or **by bot** options in the **Request creation** field.**

Important: If the **by user** option is selected, then processes are visible in the **Processes** page for all AARI users (owners or members of team). If the **by bot** option is selected, then the request is created by a bot or another process using the **Process Task** in the Process Composer. A team must be selected in the **Default team to take the bot created request** field, for requests to be created by that team.

12. Click the **+ (plus) icon to add teams to the process.**

The **Add teams** window appears to search for teams to add.

13. Search for a team in the search bar.**14. Click on their name to confirm the team.****15. Click **Add**.**

Team are now successfully added to the process.

16. Optional: To remove a team, click the **trash icon next to the team name.****17. Click **Save**.**

Assign or unassign a task

The Automation Anywhere Robotic Interface (AARI) manager and user can assign specific tasks to their team. They can also unassign tasks.

Ensure you have completed the following:

- Provided a system-created **AAE_Robotic_Interface Manager** role for the AARI manager.
- Provided a system-created **AAE_Robotic_Interface User** role for the AARI user.
- Have access to AARI on the web.

Managers can assign tasks to all members who have access to a process. Users can assign tasks to other users in the same team. Managers and users can unassign tasks.

- 1.** Log in to the web interface as an AARI manager.
- 2.** Navigate to the **Tasks** tab.
- 3.** Select a task from the list.

4. Navigate to
 - **Unassigned**
Tasks are unassigned by default.
 - **Assign to me**
This option assigns the task to the current user.
5. Select the user.
The task is now assigned.
6. Optional: Select **Unassigned**.
The task is now unassigned.

View and search for a process

The AARI user can view, pin, or search their assigned processes.

Ensure you have completed the following:

- Provided a system-created **AAE_Robotic_Interface User** role for the AARI user.
- Assigned the AARI user license.
- Have access to AARI on the web.

1. Log in to the web interface as an AARI user.
2. Click **Create request** from the home page and choose from these options:

Option	Steps
View a process	View your assigned process in the Select a process window. <hr/> Important: A list of processes is available in the All tab by default and are assigned to your team by the manager. <hr/>
View a pinned process	<ol style="list-style-type: none"> a. Click the pin icon. b. Navigate to the Pinned tab. c. View your pinned process.
Search for a process	<ol style="list-style-type: none"> a. Click Create request from the home page. b. Navigate to the search bar. c. Enter your keyword. The search bar dynamically searches your processes for common keywords. You can also search for tags. d. View the searched process.

Filter and search for a request

When an AARI user has created many requests, they can quickly search for a specific request in the **Requests** page.

Ensure you have completed the following:

- Provided a system-created **AAE_Robotic_Interface User** role for the AARI user.
- Assigned the AARI user license.
- Have access to AARI on the web.

Follow these steps to quickly search or filter your requests:

1. Log in to the web interface as an AARI user.
You are now in your home page, where you can view your requests.
2. Navigate to the **Requests** page and choose from these options:

Option	Steps
Sort	<ol style="list-style-type: none"> Click on a column. You can choose from: Status, Reference, Process, Team, Request title Created , Updated or Tags. The column is sorted to ascending order by default. Optional: Click the same column again. The column is now sorted to descending order. View your sorted requests.
Search	<ol style="list-style-type: none"> Click Status (set by default). You can search by Request title, Reference, Process, Tags, Data Privacy Tags (AARI Admin only), and Team. Search for your request. The search bar dynamically searches for common keywords. <ul style="list-style-type: none"> • Enter the title in the Request title field. • Enter the reference key in the Reference field. • Enter a process name in the Process field. • Enter a tag name in the Tags field. • Enter a team name in the Team field. • Optional: Enter the query in the Data Privacy tag field. <hr/> <p>Note: This option is available only for the AARI admin. The admin can update the field and manage any information about data privacy.</p> <hr/> Optional: Click x to clear searched keywords. View the searched requests.

Option	Steps
Filter	<p>a. Click Status (set by default). You can filter by selecting from the drop-down menu.</p> <p>b. Select from the drop-down menu. You can choose from Completed, Failed, Cancelled, and Open.</p> <p>c. Optional: Click x to clear filtered keywords.</p> <p>d. View your filtered requests.</p>
Date	<p>a. Select Created date or Updated date field. The date range window appears.</p> <p>b. Select the current date or specify any dates in the From and To fields.</p> <p>c. Click Submit.</p> <p>d. View your requests by the creation or modified dates.</p>

Filter and search for a task

When an AARI user has created many tasks, they can quickly search for a specific task in the **Tasks** page.

Ensure you have completed the following:

- Provided a system-created **AAE_Robotic_Interface User** role for the AARI user.
- Assigned the AARI user license.
- Have access to AARI on the web.

Follow these steps to quickly search or filter your tasks:

- 1.** Log in to the web interface as an AARI user.
You are now in your home page, where you can view your tasks.
- 2.** Navigate to the **Tasks** page and choose from these options:

Option	Steps
Sort	<p>a. Click on a column. You can choose from: Status, Task Name, Assignee, Team, Request title, Reference, Task Created, Task Updated. The column is sorted to ascending order by default.</p> <p>b. Optional: Click the same column again. The column is now sorted to descending order by default.</p> <p>c. View your sorted tasks.</p>

Option	Steps
Search	<p>a. Click Status (set by default).</p> <p>You can search by Task Name, Request title, Reference, Data Privacy Tags (AARI Admin only), Assignee, and Team.</p> <p>b. Search for your task.</p> <p>The search bar dynamically searches for common keywords.</p> <ul style="list-style-type: none"> • Enter a task name in the Task Name field • Enter the title in the Request title field. • Enter the reference key in the Reference field. • Enter an assignee name in the Assignee field. • Enter the team name in the Team field. • Optional: Enter the query in the Data Privacy tag field. <hr/> <p>Note: This option is available only for the AARI admin. The admin can update the field and manage any information about data privacy.</p> <hr/> <p>c. Optional: Click x to clear searched keywords.</p> <p>d. View the searched tasks.</p>
Date	<p>a. Select Created date or Updated date field.</p> <p>The date range window appears.</p> <p>b. Select the current date or specify any dates in the From and To fields.</p> <p>c. Click Submit.</p> <p>d. View your tasks by the creation or modified dates.</p>
Preset filters in Table view	<p>a. Navigate to the Table view tab (set by default)</p> <p>b. Click My Completed tasks, My Pending tasks, or Unassigned tasks.</p> <p>c. View your filtered tasks.</p>
Filter in Table view	<p>a. Click Status (set by default) or Type.</p> <p>b. Select from the drop-down menu.</p> <p>For Status, you can choose from Pending, Cancelled, and Completed.</p> <p>For Type, you can choose from Form and Validation.</p> <p>c. View your filtered tasks.</p>

Option	Steps
<p>Filter in Detail view</p>	<p>a. Navigate to the Detail view tab.</p> <p>b. Click Filter.</p> <p>c. In the dedicated filter window that appears, configure your contents from these filter options:</p> <ul style="list-style-type: none"> • Choose a preset filter from My Completed tasks, My Pending tasks, and Unassigned tasks. • Select a date in the Created date or Updated date fields. You can select the current date or specify any dates in the From and To fields. • Select a status in the Status option. You can choose Pending, Cancelled, and Completed. • Enter a task name in the Task Name field. • Enter a name in the Request title field. • Enter a name in the Created by field. • Enter the reference key in the Reference field. • Select a type in the Type option. You can choose Form and Validation. • Enter a name in the Assignee field. • Optional: Enter the query in the Data Privacy tag field. <hr/> <p>Note: This option is available only for the AARI admin. The admin can update the field and manage any information about data privacy.</p> <hr/> <p>d. In the task list, you can filter your task with more sort options:</p> <ol style="list-style-type: none"> 1. Click Task Created (set by default). 2. Select in the Sort By field from Status, Task Name, Reference, Title, and Task Created options. 3. Select in the Order field from Ascending (set by default) and Descending orders. <p>e. Optional: Click x to clear any custom filter keywords or tags.</p> <p>f. View your filtered tasks.</p>

Configure an AARI bot

This task shows you how to edit a bot to set parameters as well as to manage team members.

1. Log in to the web interface.
2. Navigate to **Manage > Bot**.
3. Click on an available bot.

This opens the **Edit Bot** page in the **General** tab.

4. Specify a name in the **Bot display name** field.
5. Reference the file name in the **Bot file name** field

Note: The field is grayed out and cannot be modified as this field is to help you reference the name of this bot file.

6. Reference the URI in the **Uri** field

Note: The field is grayed out and cannot be modified as this field is to help you reference the URI of this bot.

7. **Optional:** Enter a description for your bot.
8. **Optional:** Select the **Run this bot in virtual window** check box.

The screenshot shows a form with a text input field labeled "Description (Optional)" and a checkbox labeled "Run this bot in virtual window". Below the checkbox, there is a note: "Requires Windows 8, Windows Server 12, or newer". The checkbox is highlighted with a red border.

This option enables the Picture-in-Picture (PIP) feature in Microsoft Windows. This feature enables attended users to run bots in AARI Assistant on a virtual desktop window, while they continue to work on other applications. For more information on AARI Assistant, see [About AARI Assistant](#).

Important: Microsoft Windows 8, Microsoft Windows Server 12, or any of the later versions are required for virtual window. Here are some of the existing limitations of using the PIP feature:

- Another instance of your current browser cannot be used on Windows Desktop and the virtual window at the same time.
For example, if you are using an instance of Google Chrome on your Windows Desktop, the same cannot be used in the virtual window. In order to use Google Chrome in the virtual window, ensure you close this browser on your Desktop.
- When a virtual window is initiated, you might be logged out of your connected Global Protect software. However, the TaskBot will continue to run in the virtual window.
- Applications that allow single log in are restricted to the corresponding main or virtual windows.
- After a bot starts, it runs in the virtual window and is completely independent of the main instance.

Note: Attended users can use the virtual window option in Embedded Automation to run attended bots from the iFrame widget in their web applications.

9. **Optional:** Select **Delete bot** to delete this bot.

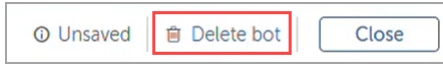

CAUTION: This option will permanently delete your bot.

10. Click on the **Teams** tab.
This page allows you to manage your team members.
11. Click the **Add (+)** button.
This **Add Teams** page appears.
12. Select an available team.
13. Click **Add & save** to confirm your choice.
A team has now been assigned to this bot.
14. **Optional:** Select a team and click **Delete** (recycle) button to remove a team.
15. **Optional:** Select the search bar and filter by **Team**, **Description**, and **Request visibility** from **Private** or **Shared**.
16. Click **Close**.
Your settings are saved automatically.

Configure an AARI process

This task shows you how to edit a process to create a process key, set a default team, as well as enable the option to delete a process.

1. Log in to the web interface.
2. Navigate to **Manage > Process**.
3. Click on an available process.
This opens the **Edit Process** page in the **General** tab.
4. Specify a name in the **Process name** field.
5. **Optional:** Specify the description in the **Description** field.
6. Enter a customer key (if applicable) in the **Process key** field.

Important: The process key must be one to five characters long and in alphabetical order. The process key can only be defined once, and after when the process key is defined, it cannot be modified later by the user.

7. Add tags to your process in the **Tags** field.

8. In the **Tags** field:

- a) Click the **Tags** field.
- b) Specify your tags with unique keywords, such as **Cases** or **Reports**.
- c) Select the **Add as new option** from the drop-down to add a new tag.

The keyword will automatically generate a new tag if it does not exist. The search result is displayed in real time.

Form titled "Edit Process: 34 - Order Status" with tabs for "General", "Teams", and "Deployment". The "General" tab is active. Fields include "Process name" (Order Status), "Description (Optional)", and "Process key". The "Tags" field is highlighted with a red box. Below it, a search result for "Cases" is shown, and a red box highlights the "Add as new tag 5/500" link.

- d) (Optional) Select an existing tag from the drop-down.

Form titled "Tags" showing a list of tags: Support, Workspace, Account, Salesforce, and Case. The "Support" and "Account" tags are selected with checkboxes. A trash bin icon is visible next to the "select tags" dropdown.

- e) (Optional) Select the trash bin icon to delete your tags in the field.

Note: Only the AARI admin can view and create tags.

9. Specify the team in the **Default team** field.

By default the first team that is added to the process is automatically set as the default team. You can change the team by selecting from the drop-down menu.

Important: A default team cannot be deleted from a process. For the admin to remove a default team (e.g. Team 1), they would need to set another team (e.g. Team 2) as the default team, then remove the original team (e.g. Team 1) from the process.

Ex: You can select **Recruitment Director** in the drop-down menu.

10. Choose between the **by user** and **by bot** in the **Request creation** field.

11. In the **Request retention** field:

- Select **Disabled**, **Immediate**, or **Custom** from the first drop-down menu to specify whether the completed request is moved from the **Request** page to the **Recycle bin**.

For example, you can select **Disabled** to prevent your requests from being moved to the **Recycle bin** or select **Immediate** for all current completed requests to be moved without delay.

Note: When you select the **Immediate** option, it can take a maximum time of one hour before the request is moved to the **Recycle bin**.

- Select **Immediate** or **Custom** from the second drop-down menu to specify the number of days when the requests is permanently deleted in the **Recycle bin**.
Ex: You can select the **Custom** option and specify **30** to represents thirty days when the request is deleted in the **Recycle bin**.
- Select the check box option to allow open request to be moved to the **Recycle bin**.

12. Click **Close**.

Your settings are saved automatically.

Bot setup

The AARI admin can manage and assign bots to a team of attended Bot Runner users, for them to view bots in the AARI Assistant.

The main purpose of this feature is to improve the bot assignment for attended Bot Runner users, to enable them to access only the bots that are assigned to their team by an AARI admin.

This helps control which users can view or use a bot. However, if an attended Bot Runner user is not apart of any team, they will be able to view and access all bots in the AARI Assistant.

For the AARI admin to assign a team of attended Bot Runner users to a bot, they must have view permissions on folders containing the bot.

- The AARI admin can access the **Bot Setup** page in the web interface to view all bots and assign them to a team. They can also assign multiple teams to a bot or remove teams from bots entirely.
- When new bots are added to this page, the bots can be assigned to a team of attended Bot Runner users.
- The attended Bot Runner users can view their assigned bots in the AARI Assistant.
- The attended Bot Runner user must have a role with access to the public folder where the bot resides.

Attended and unattended automation

The Automation Anywhere RPA Workspace provides attended and unattended automation for users to create bots that can manage routine tasks efficiently. While users focus on critical inputs that require manual overview or approval, bots handle tasks such as gathering information across databases, validating data, or responding to chats.

Overview

Collaboration between humans and software bots is called *attended automation*. As attended automation requires user supervision, it is best suited for use with smaller and more fragmented tasks. However, some tasks within a business process do not change a lot over time and might not require extensive user intervention, such as collecting data or retrieving information from multiple databases. When such

tasks that require little or no user judgment are configured to trigger other bots, it is called *unattended automation*. Unattended automation is useful to perform privileged operations, requiring elevated permissions and credentials.

Automation 360 offers a combination of attended and unattended automation for a complete RPA solution with the following benefits:

- Automated integration between multiple applications or databases, reducing errors as very little user intervention is necessary.
- Access bots in real-time through an easy to use interface.
- Users can set up or change triggers to start bots based on real-time.

Watch the following video to understand attended automation:

Related concepts

[Using AARI on desktop](#)

Use Automation Anywhere Robotic Interface (AARI) through your desktop to manage routine tasks such as validating data, retrieving approvals, and managing escalations through bots.

Related information

[Using bots to solve problems](#)

Using AARI on desktop

Use Automation Anywhere Robotic Interface (AARI) through your desktop to manage routine tasks such as validating data, retrieving approvals, and managing escalations through bots.

The following workflow describes how to use AARI to automate and manage your tasks:

1. Create a user:

- The Control Room administrator creates a user with a Bot Creator license.

[Create a user | Automation 360 licenses](#)

- The user logs in to the Control Room to start building bots.

[Install Bot Agent and register device | Get started building bots](#)

2. Create forms using the Interactive forms package:

- Interactive forms enable you to design forms for submitting and regrouping data from various applications.

[Create a form](#)

- Link the form to a newly created bot or an existing bot using the Bot editor interface.

[Add a form to bot](#)

3. Add triggers to the bot:

Trigger loop enables you to add triggers that can run a task automatically when certain predefined events occur.

[Adding a trigger to run a bot](#)

About AARI Assistant

Attended Bot Runner users can use the AARI Assistant application to access bots without logging into Control Room.

Control Room administrator adds Active Directory (AD) users by selecting AD domain, providing environment details, and assigning a role and device license. Administrator can further deploy the Control Room RBAC by specifying role-based privileges and permissions at the bots and Bot Runner level.

Control Room RBAC on Bot Runner users facilitate a complete isolation based on pre-defined criteria such as users across various business units or departments. This also includes the privileges that is applied at a folder level to completely and seamlessly isolate bots of one department from the other.

In a typical scenario, triggering some specific bots to complete important tasks can be one of the daily routines for attended Bot Runner users. Entire process of signing into Control Room can be time consuming. AARI Assistant reduces this effort considerably. When Bot Agent is installed on a device, an application shortcut on the desktop for AARI Assistant is also created along with a **Start** menu icon.

Users with attended Bot Runner license can launch this application, use their AD credentials to sign in and review the list of available bots, and run the specific bot.



Attention: AARI Assistant application is not available for the Citizen Developer license.

Sign into AARI Assistant

Use the AARI Assistant application to directly run the bots without signing into Control Room.

- Automation Anywhere AARI service must be running in Control Room to use AARI Assistant.
- This application is designed only for user with attended Bot Runner license. A sign in error is displayed if users with any other license tries to sign in.

1. Click the **AARI** icon to open AARI Assistant.
2. Use Automation 360 credentials to sign into the application.

All the bots that you have access to are listed.

3. Optional: Use the **Search** bar at the top to find a bot.
4. Optional: Click **Show pinned only** check box to list your pinned bots.

Ensure you pin (similar to favorites) the most used bots for a quick access.

5. Click **Launch** to run the bot.

After the bot run is successful, a **Completed** message is displayed. You cannot launch another bot until this activity completes.

Using interactive forms

Interactive forms enable you to build forms for submitting and regrouping data that is used to send and receive information from various applications within your attended automation process.

Interactive forms provide a list of actions that you can drag into a bot as a task logic. Specific function of each action is displayed when you hover over them. The actions within the interactive forms can be broadly classified into the following types:

Form level actions

Represented by  and used within a task logic to manage the linked form.

Element level actions

Represented by  and used to manage elements of a form.

Watch the following video to understand how to use Interactive forms in Automation 360:

Create a form

The form builder in Automation 360 enables you to create or edit forms using various form elements available through a browser interface. A form provides structural content with little or no changes in the layout. You can link a form to bots that perform predefined automated tasks.

The form builder requires no additional installation over the Bot Agent. Control Room users with the Bot Creator license can access the form builder to design a new form or edit an existing form.

This task provides an example scenario where you create a new user registration form that captures all the necessary information. When you link this form to a bot, it can trigger a third-party application to store user information.

The form builder includes the following features:

- The title of your form can be changed with a double-click.
- You can now add elements directly to the form builder without the need to add a column for each element. The elements will dynamically resize to fit the canvas
- You can add up to 25 elements in a form.
- The width of the elements will automatically adjust in the form builder, depending on the number of elements that you add.
- You can also adjust the width of your elements when you click and drag a corner of an element.
- The minimum width of the element is greater than 20.

1. On the left pane, click **Automation**.
A list of available and forms is displayed.
2. Click **Create a form**.
3. In the **Create form** page, enter a name for the new form.
Forms are saved in the `\Bots\` folder by default. Click **Browse** to change the default folder.
4. Click **Create & edit**.
The form builder page appears with a single row **Column** layout.

5. Use the **Properties** tab on the right to update or change the form properties.

- a) Enter the title in the **Form title** field.
- b) Use the **Formatting** fields to set the display font or the font size of the form elements.

Note: Use the **Font name** drop-down menu to select an English-only font.

If you have used any of the supported non-English languages for the form elements, select **Font name > System default**. For example, if you added an element label or text in Japanese, select **Font name > Medium** for the form elements to be displayed in Japanese during the bot runtime.

- c) Use the **Dimensions** field to set the width and height of the form.
- d) Use the **Display behaviors** field to set the way the form is displayed on the user desktop.
- e) Optional: Use the **Logos in footer** field and select one of the following tabs:

- **One Logo**

Click **Select File** and use the **Search**, **Browse**, or **Upload** tabs to select an image file. The selected file is displayed in the footer of the form during bot runtime.

- **Two Logos**

Click the two separate **Select File** options to select two image files. The selected files are displayed in the footer of the form during bot runtime.

- f) Set a variable using **Hidden elements**.

For example, if the registration form is linked to a Social Security Number (SSN) that cannot be displayed to users, select the hidden element **Type** as **Number**. A user with a Bot Creator license can then access this variable when creating a bot.

6. Optional: Click Preview.

The form preview screen enables you to view the display resolution of the form and change the form position on the your desktop. You can select a resolution in the **Display Resolution** option.

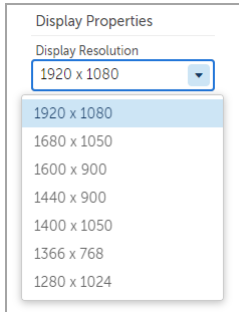

You can either enter the values for the **X** and **Y** coordinates or drag the form using the cursor to update the corresponding X and Y coordinates dynamically.

The **Make form preview centered** option lets you center the form.

Preview of Form

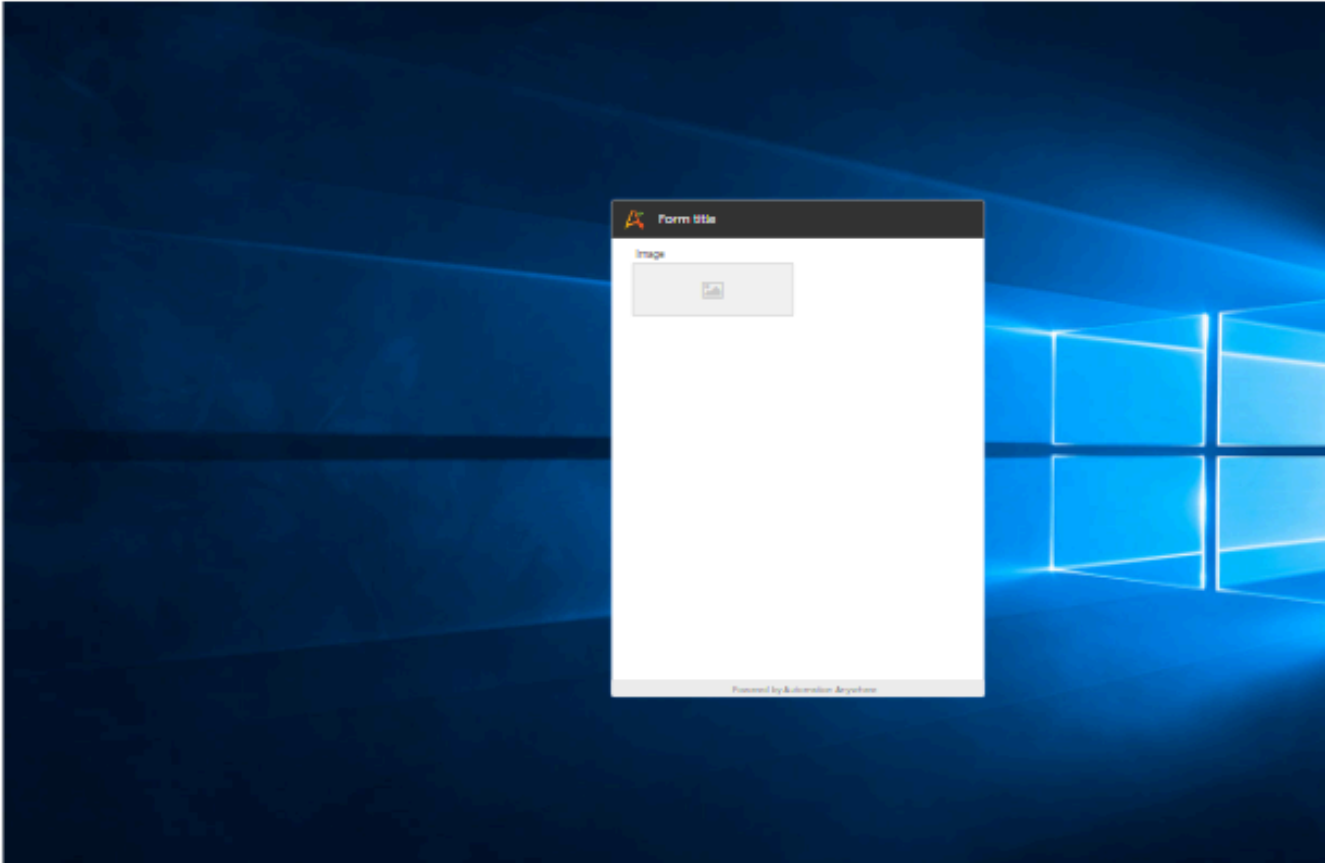

7. In this scenario, drag the following elements into the form:
 - a) **Textbox**: Enter **First Name** in the **Element label** field of the first text box, and enter **Last Name** in the **Element label** field of the second text box.
 - b) **Number**: Enter **Contact Number** in the **Element label** field.
For a new user registration form, some of the fields such as contact number might be mandatory. Use the **Advance behaviors** to make it mandatory and the **Formatting** option to set the input format.
 - c) **Radio Button**: Update the **Element label** as **Gender**. Change the values for the **Radiobutton1** as **Male** and **Radiobutton2** as **Female**.
 - d) **Date**: Enter **Date of Birth** in the **Element label** field.
 - e) **Textbox**: Enter **Email ID** in the **Element label** field.
 - f) **Dropdown**: Update the **Element label** as **Newsletter**. Enter **Daily, Weekly, Monthly**, or **None** in the **Add dropdown content** field.
In this scenario, you can use the **Dropdown** element to create a newsletter option for the new user. This can be used to trigger an email based on the selected option.
 - g) **Button**: Enter **Submit** in the **Button-text (required)** field.
 - h) Drag another **Button** element and enter **Cancel** in the **Button-text (required)** field.
Use the **Button type** drop-down menu and set this as **Secondary**.
8. Optional: Click **Preview**.
Use this feature to preview the appearance of the form based on the resolution of the destination device.
9. Click **Save**.
The new registration form is created and is ready to be linked to a bot.

Using the Button element

Use the **Button** element in the form builder to validate or cancel a form during bot runtime.

1. On the left pane, click **Automation**.
A list of available and forms is displayed.
2. Click an existing form or click **Create new > Form**.
The form builder page appears.
3. Drag **Button** into the form.
4. Enter the name of the element in the **Button-text** field.
5. Optional: Enter the hint text and tooltip.
6. Use the **Button types** drop-down menu to set the type of the button element.
For example, consider you have two buttons, Save and Cancel. Use **Primary** for Save and **Secondary** for Cancel. Or, if you want the button element to appear as a link during bot runtime, select **Subtle**.
7. Optional: Use the following **Advance behavior** option:
 - **Disallow button click when this form is first loaded**: Enable this option to disable the button element when the form is displayed for the first time during bot runtime.
 - **Validate all form fields when this button is clicked**: Enable this option to validate all available fields of the form when a user clicks this button element during bot runtime.

8. Optional: Click one of the following options:
 - **Reset:** Clears all the element customization and sets the default.
 - **Delete:** Deletes the selected element.
9. Click **Save**.

Using the Checkbox element

Use the **Checkbox** element in the form builder to enable users to select multiple options in a form during bot runtime.

1. On the left pane, click **Automation**.
A list of available and forms is displayed.
2. Click an existing form or click **Create new > Form**.
The form builder page appears.
3. Drag **Checkbox** into the form.
4. Enter the name of the element in the **Element label** field.
5. Optional: Enter the hint text and tooltip for the check box element.
6. Use the **Checkbox content** fields to add multiple check boxes and enter a name for each one of them.
For example, if you are creating a sales chart form, use this field to add three check boxes and enter `Product 1`, `Product 2`, and `Product 3`.
7. Optional: Enable any of the following **Advance behavior** options:
 - Select the **Make field required** check box to ensure users select this element during bot runtime.
 - Select the **Make field uneditable** check box to make the element a read-only option.
 - If you have multiple check boxes in the form and want a default selection during bot runtime, select the **Make default selections** check box, and select the necessary option.
8. Use the **Formatting** field to set the vertical or horizontal layout of the check boxes.
9. Optional: Click one of the following options:
 - **Reset:** Clears all the element customization and sets the default.
 - **Delete:** Deletes the selected element.
10. Click **Save**.

Using the Date element

Use the **Date** element in the form builder if the user must schedule a date in the form during bot runtime.

1. On the left pane, click **Automation**.
A list of available and forms is displayed.
2. Click an existing form or click **Create new > Form**.
The form builder page appears.
3. Drag **Date** into the form.
4. Enter the name of the element in the **Element label** field.
5. Select a default date using the **Default value** field.
6. Optional: Select the **Use the local system date when form is loaded** check box to set your system date as the default value.
7. Select one of the following formatting options:
 - **Use locale date format setting:** The date is displayed in the format set on the user's machine.

- **Manual input:** Select the date format to be displayed from the drop-down menu.
8. Enter the hint text and tooltip for the formatting option.
 9. Optional: Enable any of the following **Advance behavior** options:
 - Select the **Make field required** check box to ensure users select this element during bot runtime.
 - Select the **Make field uneditable** check box to make the element a read-only option.
 10. Optional: Click one of the following options:
 - **Reset:** Clears all the element customization and sets the default.
 - **Delete:** Deletes the selected element.
 11. Click **Save**.

Using the Document element

Use the **Document** element in the form builder to render a document, such as an image (.jpg) or PDF, that you want to preview along with the form.

Note: Only one **Document** element can be used in a form.

1. On the left pane, click **Automation**.
A list of available and forms is displayed.
2. Click an existing form or click **Create new > Form**.
The form builder page appears.
3. Drag **Document** into the form.
4. Enter the correct URL or the document location address in the **Default file** field.
5. Use the **Formatting** drop-down menu to set the position of the document element in the form.
6. Optional: Enter a specific width for the element in the **Dimensions** field.
7. Optional: Click one of the following options:
 - **Reset:** Clears all the element customization and sets the default.
 - **Delete:** Deletes the selected element.
8. Click **Save**.

Using the Dropdown element

Use the **Dropdown** element in the form builder to provide multiple options in the form during bot runtime.

1. On the left pane, click **Automation**.
A list of available and forms is displayed.
2. Click an existing form or click **Create new > Form**.
The form builder page appears.
3. Drag **Dropdown** into the form.
4. Enter the name of the element in the **Element label** field.
5. Optional: Enter the hint text and tooltip for the check box element.
6. Use the **Add dropdown content** field to enter the items that must appear in the drop-down menu during bot runtime.
7. Optional: Enable any of the following **Advance behavior** options:
 - Select the **Make field required** check box to ensure users select this element during bot runtime.

- Select the **Make field uneditable** check box to make the element a read-only option.
 - If you have multiple items in the drop-down element and want a default selection during bot runtime, select the **Select default list item** check box, and select the necessary option.
8. Optional: Click one of the following options:
 - **Reset:** Clears all the element customization and sets the default.
 - **Delete:** Deletes the selected element.
 9. Click **Save**.

Using the Dynamic Area element

Use the **Dynamic Area** element in the form builder to display content that is not part of the form itself during bot runtime.

1. On the left pane, click **Automation**.
A list of available and forms is displayed.
2. Click an existing form or click **Create new > Form**.
The form builder page appears.
3. Drag **Dynamic Area** into the form.
4. Enter the name of the element in the **Element label** field.
5. Use the **Placeholder text** field to enter the text that must appear if this element is empty during bot runtime.
6. Enter a specific height of the element in the **Height** field.
The default dimension value is set to 120 and enables a scroll bar if the additional content exceeds this value.
7. Optional: Click one of the following options:
 - **Reset:** Clears all the element customization and sets the default.
 - **Delete:** Deletes the selected element.
8. Click **Save**.
The **Dynamic Area** action is available during bot runtime to render this field.
See [Interactive forms package](#).

Using the Select File element

Use the **Select File** element in the form builder to enable users to attach a file to the form. For example, if the registration form requires a new user to attach a photograph, you can use this element in the form.

1. On the left pane, click **Automation**.
A list of available and forms is displayed.
2. Click an existing form or click **Create new > Form**.
The form builder page appears.
3. Drag **Select File** into the form.
4. Enter the name of the element in the **Element label** field.
5. Use the **Select the format type** field to set one of the following options for upload file format:
 - **Supported Type:** If you select this option, in the **Enter file formats separated by commas** field, ensure that you enter the file types that the user can upload when the bot runs. For example, if you want to allow only `.png` and `.jpeg` file types, enter them in the **Enter file formats separated by commas** field.

- **Unsupported Type:** If you select this option, in the **Enter file formats separated by commas** field, ensure that you enter the file types that will not be supported during upload when the bot runs. For example, if you want to restrict users from uploading `.txt` and `.ppt` file types, enter them in the **Enter file formats separated by commas** field.
6. Optional: Select **Enable file download** if you want the users to be able to download the file.
 7. Optional: Enter the hint text and tooltip for the element.
 8. Optional: Choose one of the following **Advance behavior** options:
 - Select the **Make field required** check box to ensure users must select this element during bot runtime.
 - Select the **Make field uneditable** check box to set the element as a read-only option.
 9. Optional: Choose one of the following options:
 - **Reset:** Clears all the element customization and sets the default.
 - **Delete:** Deletes the selected element.
 10. Click **Save**.
 When you click **Preview** during bot runtime, the system default application is used to display the selected file.

 For example, if Microsoft Excel is set as the default application and you use **Select file** to upload a `.xls` spreadsheet, the selected document is displayed in Microsoft Excel when you click **Preview** during bot runtime.

 Users can click **Browse** to select a file or drag a file into the **Select File** element during bot runtime.

Using the Select Folder element

Use the **Select Folder** element in the form builder to enable users to upload a folder that contains a specified file type during bot runtime.

1. On the left pane, click **Automation**.
A list of available and forms is displayed.
2. Click an existing form or click **Create new > Form**.
The form builder page appears.
3. Drag **Select Folder** into the form.
4. Enter the name of the element in the **Element label** field.
5. Optional: Select the **Show list of supported files in the folder** check box.
If you select this option, the supported file types are displayed below the **Select folder** form element during bot runtime.
6. Enter the supported file types for this element during bot runtime.
For example, if you want to allow users to only upload folders that contain documents or text files, enter `doc` and `txt`.
7. Optional: Enter the hint text and tooltip for the element.
8. Optional: Choose one of the following **Advance behavior** options:
 - Select the **Make field required** check box to ensure users must select this element during bot runtime.
 - Select the **Make field uneditable** check box to set the element as a read-only option.
9. Click **Save**.
Users can click **Browse** to select a folder or drag one into the **Select Folder** element during bot runtime.

Using the Hyperlink element

Use the **Hyperlink** element in the form builder if you want to assign a URL during bot runtime.

1. On the left pane, click **Automation**.
A list of available and forms is displayed.
2. Click an existing form or click **Create new > Form**.
The form builder page appears.
3. Drag **Hyperlink** into the form.
4. Enter the text to be displayed for the URL in the **Display text** field.
5. Enter the link in the **URL** field.
6. Use the **Open in browser** drop-down menu to select a browser to open the URL.
If you select Google Chrome, the URL opens in Google Chrome during bot runtime.
7. Optional: Enter the hint text and tooltip for the check box element.
8. Click **Save**.

Using the Image element

Use the **Image** element in the form builder to enable users to attach an image file to the form. For example, you can use this element to add a company logo to the form during bot runtime.

1. On the left pane, click **Automation**.
A list of available and forms is displayed.
2. Click an existing form or click **Create new > Form**.
The form builder page appears.
3. Drag **Image** element into the form.
4. Enter the id in the **Element ID** field.
5. Enter the name of the element in the **Element label** field.
6. Optional: Enter a value in the **Height** field to adjust the height.
7. Optional: Add a help text.
 - Enter a text in **Hint below field**.
 - Enter a text in the **Tool tip** field.
8. Use the **Desktop or network path to retrieve image** field to specify the image filepath

9. Upload an image in the **Select image file to upload** field.

Note: In Automation 360 v.26, where you must specify a local image for the **Image** element (**Desktop or network path to retrieve image** field), you must use the browse feature in the image property to upload the image.

The screenshot shows the 'Properties - Image' configuration window. It includes sections for 'Element settings' (Element ID: Image0, Element label: Image), 'Formatting' (Height: 64), 'Help text option' (Hint below field: 30 characters max, Tool tip: 200 characters max), and a 'Select image file to upload' field with a 'Select File' button. The 'Select image file to upload' field and its button are highlighted with a red rectangle.

10. Click **Save**.

Using the Label element

Use the **Label** element in the form builder to add a read-only field in the form at bot run time.

1. On the left pane, click **Automation**.
A list of available and forms is displayed.
2. Click an existing form or click **Create new > Form**.
The form builder page appears.
3. Drag **Label** into the form.
4. Enter the name of the element in the **Element label** field.
5. Click the **Formatting** drop-down menu to apply a formatting effect to the element:
 - **Font size:** Set the size of the font.
 - **Emphasis:** Set the font emphasis such as bold, italics, and so on.
 - **Font color:** Set the display colour of the font.
 - **Text alignment:** Set the text alignment within the element.
6. Optional: Enter a tooltip that appears when the user points to the element.
7. Click **Save**.

Using the Number element

Use the **Number** element in the form builder if the form must have a field that allows the user to enter only numeric values during bot runtime.

1. On the left pane, click **Automation**.
A list of available and forms is displayed.
2. Click an existing form or click **Create new > Form**.
The form builder page appears.

3. Drag **Number** into the form.
4. Enter the name of the element in the **Element label** field.
5. Set the default value for the element.
6. Enter the minimum and maximum number of characters that users can enter in this field during bot runtime.
7. Optional: Enter the hint text and tooltip for the check box element.
8. Optional: Enable any of the following **Advance behavior** options:
 - Select the **Make field required** check box to ensure users select this element during bot runtime.
 - Select the **Make field uneditable** check box to make the element a read-only option.
9. Use the **Formatting** options to enable users to enter negative values, trailing zeroes, and comma during bot runtime.
10. Use the **Decimals** drop-down menu to set the number of decimal places.
11. Use the **Special characters** field to enter the prefix and suffix labels for the element.
12. Optional: Click one of the following options:
 - **Reset**: Clears all the element customization and sets the default.
 - **Delete**: Deletes the selected element.
13. Click **Save**.

Using the Password element

Use the **Password** element in the form builder if the form must have a confidential or masked field. This element uses the masking feature by default and Credential Vault encryption to transfer data during bot runtime.

1. On the left pane, click **Automation**.
A list of available and forms is displayed.
2. Click an existing form or click **Create new > Form**.
The form builder page appears.
3. Drag **Password** to the form.
4. Enter the name of the element in the **Element label** field.
5. Use the **Formatting** field for additional options:
 - **Standard**
 - Set the character limit for password using the **Min** and **Max** fields.
 - Enable additional security options for the password.
 - **Custom**
 - Click the **Add regular expression** option and enter a custom password in the **Regular expression** field.
 - **Optional**: Enter the same custom password in the **Test Content** field, and click **Test regular expression** to verify it works correctly.
6. Optional: Enter the hint text and tooltip.
7. Optional: Enable any of the following **Advance behavior** options:
 - Select the **Make field required** check box to ensure users select this element during bot runtime.
 - Select the **Make field uneditable** check box to make the element a read-only option.
8. Optional: Click one of the following options:

- **Reset:** Clears all the element customization and sets the default.
- **Delete:** Deletes the selected element.

9. Click **Save**.

Note: Use the view icon in the **Password** field to review the password during bot runtime.

Using the Radio Button element

Use the **Radio Button** element in the form builder if you want to enable users to select only one of the available options from a field during bot runtime.

1. On the left pane, click **Automation**.
A list of available and forms is displayed.
2. Click an existing form or click **Create new > Form**.
The form builder page appears.
3. Drag **Radio Button** into the form.
4. Enter the name of the element in the **Element label** field.
5. Optional: Enter the hint text and tooltip for the check box element.
6. Enter the names of the radio buttons that will be displayed during bot runtime.
For example, if you are creating a client information form, use this field to add two radio buttons and enter `Male` and `Female`.
7. Enable any of the following **Advance behavior** options:
 - Select the **Make field required** check box to ensure users select this element during bot runtime.
 - Select the **Make field uneditable** check box to make the element a read-only option.
 - If you have multiple radio buttons in the form and want a default selection during bot runtime, select the **Make default selections** check box, and select the necessary option.
8. Use the **Formatting** field to set the vertical or horizontal layout of the radio buttons.
9. Optional: Click one of the following options:
 - **Reset:** Clears all the element customization and sets the default.
 - **Delete:** Deletes the selected element.
10. Click **Save**.

Using the Rich Text Editor element

Use the **Rich Text Editor** element in the form builder to insert a text editor in the form that provides various options to edit the content during bot runtime.

1. On the left pane, click **Automation**.
A list of available and forms is displayed.
2. Click an existing form or click **Create new > Form**.
The form builder page appears.
3. Drag **Rich Text Editor** into the form.
4. Enter the name of the element in the **Element label** field.
5. Set the default value for the element that must appear in the element during bot runtime.
6. Enter the minimum and maximum number of characters that users can enter in this field during bot runtime.

7. Optional: Enter the height for the input area of the field and tooltip for the element.
8. Optional: Enable any of the following **Advance behavior** options:
 - Select the **Make field required** check box to ensure users select this element during bot runtime.
 - Select the **Make field uneditable** check box to make the element a read-only option.
9. Optional: Click one of the following options:
 - **Reset:** Clears all the element customization and sets the default.
 - **Delete:** Deletes the selected element.
10. Click **Save**.

Using the Snapshot element

Use the **Snapshot** element in the form builder to provide the users a screen capture option on the form during bot runtime. The file is saved in the `.jpg` format.

1. On the left pane, click **Automation**.
A list of available and forms is displayed.
2. Click an existing form or click **Create new > Form**.
The form builder page appears.
3. Drag **Snapshot** into the form.
4. Enter the name of the element in the **Element label** field.
5. Optional: Enter the hint text and tooltip for the check box element.
6. Optional: Choose one of the following **Advance behavior** options:
 - Select the **Make field required** check box to ensure users must select this element during bot runtime.
 - Select the **Make field uneditable** check box to set the element as a read-only option.
7. Enter a filepath in the **Desktop path to save snapshot** field where the snapshot file must be saved during bot runtime.
Optionally, you can either allow the user to create a folder if the filepath is not available or change the destination folder of the snapshot file.
8. Enter the suffix text for the snapshot file.
For example, if this element is used to capture sales information, enter `Sales`. The snapshot file is then saved with the text `Sales` added at the end.
9. Optional: Choose one of the following options:
 - **Reset:** Clears all the element customization and sets the default.
 - **Delete:** Deletes the selected element.
10. Click **Save**.
When you click **Preview** during bot runtime, the system default application is used to display the snapshot file.
For example, if Microsoft Photos is set as the default application to open `.jpg` files, the snapshot file is displayed in Microsoft Photos when you click **Preview**.

Using the Table element

Use the **Table** element in the form builder to insert a customizable table in the form that can be used to populate data during bot runtime.

1. On the left pane, click **Automation**.

A list of available and forms is displayed.

2. Click an existing form or click **Create new > Form**.
The form builder page appears.
3. Drag **Table** to the form.
4. Enter the name of the element in the **Element label** field.
5. Optional: Enter hint text for the element.
For example, enter `View outpatients details` if the table is used to capture a list of outpatients.
6. Use the **Rows before scrolling** field to enter the minimum number of rows the table element must have before a scroll bar is added during bot runtime.
7. Add or remove the total number of columns.
8. Click **Column settings** for additional options.
9. In the **Column settings** page, click the **Form element type** drop-down menu to set the element type.
For example, if you select **Dropdown**, use the **Add dropdown content** field to enter the items that must appear in the drop-down menu during bot runtime.
10. Optional: Click **Make columns width equal**.
11. Optional: Select any of the following **Advance behavior** options to enable them:
 - **Make table uneditable**: Enables a read-only view during bot runtime.
 - **Include table actions**: Enables users to add, remove or edit table rows during bot runtime.
If you use the table actions to delete all the rows from a table and then add a new row, the columns and rows of the table appear misaligned. Drag and resize any column to reset the alignment.
 - **Enable column filtering**: Enables users to search and filter the content for all the available columns during bot runtime. This enhances the search for content that is referenced by the column values.
12. Click **Save**.

Using the Text Area element

Use the **Text Area** element in the form builder to insert a text field in the form for users to enter alphanumeric characters during bot runtime.

1. On the left pane, click **Automation**.
A list of available and forms is displayed.
2. Click an existing form or click **Create new > Form**.
The form builder page appears.
3. Drag **Text Area** into the form.
4. Enter the name of the element in the **Element label** field.
5. Use the **Default value** field to enter the default text to be displayed in the element.
6. Enter the minimum and maximum number of characters that users can enter in this field during bot runtime.
7. Enter the height for the input area of the field.
8. Optional: Enter the hint text and tooltip for the check box element.
9. Optional: Enable any of the following **Advance behavior** options:
 - Select the **Make field required** check box to ensure users select this element during bot runtime.
 - Select the **Make field uneditable** check box to make the element a read-only option.

10. Optional: Click one of the following options:
 - **Reset:** Clears all the element customization and sets the default.
 - **Delete:** Deletes the selected element.
11. Click **Save**.

Using the Text Box element

Use the **Text Box** element in the form builder to insert a text box in the form.

1. On the left pane, click **Automation**.
A list of available and forms is displayed.
2. Click an existing form or click **Create new > Form**.
The form builder page appears.
3. Drag **Text Box** into the form.
4. Enter the name of the element in the **Element label** field.
5. Enter the default text that must appear in the element.
For example, if this field is used in a registration form, enter `First name`, which is displayed during bot runtime.
6. Use the **Formatting** field for additional options:
 - **Standard**
Set the character limit using the **Min** and **Max** fields.
 - **Custom**
 - Click the **Add regular expression** option and enter a custom text in the **Regular expression** field.
 - **Optional:** Enter the same custom text in the **Test Content** field, and click **Test regular expression** to verify it works correctly.
7. Optional: Enter the hint text and tooltip for the element.
8. Enable any of the following **Advance behavior** options:
 - Select the **Make field required** check box to ensure users select this element during bot runtime.
 - Select the **Make field uneditable** check box to make the element a read-only option.
 - Select the **Mask data** check box if you want the field to be masked by special characters when the user enters data during bot runtime.
9. Optional: Click one of the following options:
 - **Reset:** Clears all the element customization and sets the default.
 - **Delete:** Deletes the selected element.
10. Click **Save**.

Using the Time element

Use the **Time** element in the form builder to set the time in the form during bot runtime.

1. On the left pane, click **Automation**.
A list of available and forms is displayed.
2. Click an existing form or click **Create new > Form**.
The form builder page appears.
3. Drag **Time** into the form.

4. Enter the name of the element in the **Element label** field.
5. Select a default time using the **Default value** field.
6. Optional: Select the **Use the local system time when form is first displayed** check box to set your system time as the default value.
7. Use one of the following formatting options:
 - Set the time to **12 Hours** or **24 Hours** format.
 - Enter the hint text and tooltip.
8. Optional: Enable any of the following **Advance behavior** options:
 - Select the **Make field required** check box to ensure users select this element during bot runtime.
 - Select the **Make field uneditable** check box to make the element a read-only option.
9. Optional: Click one of the following options:
 - **Reset**: Clears all the element customization and sets the default.
 - **Delete**: Deletes the selected element.
10. Click **Save**.

Add rules to form elements

Add conditional actions, such as If, And/Or, and Then, to various elements in a form by using rules.

For the **Checkbox** and **Radio Button** elements, the rules are triggered only if the corresponding presets are selected. For example, if a form has two mutually exclusive options, such as **Yes** and **No**, the rules associated with these options are triggered only if you select one of the two options.



Attention: Rules are not supported for the following elements:

- Dynamic Area
- Hyperlink
- Image
- Select file
- Select folder
- Snapshot
- Table

Note: The change label action in the form rules now applies to the **Button** element. This form rules will automatically apply to the button where you set the rules. The rules editor is now applicable to the **Table** element. The rules editor and conditions applies for each individual columns while any actions you set are applied for each row in the row level.

Consider a scenario where you are creating a user sign in/registration form. You can add a rule to one of the form elements to enable an option to sign in as an existing user or register a first time user.

1. On the left pane, click **Automation**.
A list of available and forms is displayed.
2. Click **Create new > Form**.
3. In the **Create form** page, enter a name for the new form.
Forms are saved in the `\Bots\` folder by default. (Optional) Click **Choose** to change the default folder.
4. Click **Create & edit**.

5. Drag the following elements into the form:
 - **Dropdown:** In the **Element label** field, enter 'Select user type' and in the **Add dropdown content** field, add 'Existing user' and 'New user'.
 - **Text Box:** Add two elements and name them 'User name' and 'Register'.
 - **Password:** Add one element.
 - **Button:** Add two elements and name them 'Save' and 'Cancel'.
6. On the right pane, click **Form rules > Add rule**.
You can use this option to add rules to the form elements. In this scenario, add two rules.
7. For **Rule1**, update the following fields:
Rule 1 is applied when an existing user tries to sign in. If the user clicks **Select user type > Existing user**, the **Register** text box is made unavailable. Use the **If** menu to set the following conditions:
 - a) **Select user type** as the element condition in the first drop-down menu
 - b) **Choice is** in the second drop-down menu
 - c) **Existing user** in the third drop-down menu

Note: The **If** conditions are supported on the following elements:

- **Dropdown**
- **Checkbox**
- **Radio Button**
- **Date**
- **Time**
- **Hyperlink**

Use the **Then** menu to set the corresponding actions:

- a) The **Register** text box in the first drop-down menu
All the available elements in the form on which the rules are supported are listed in this field. For the **Dropdown** element in the **Then** menu, you can use the **Assign** option to append or overwrite values at bot runtime.
- b) **Disable** in the second drop-down menu

8.

On **Rule1**, click the vertical ellipsis () for the following options:

- **Add rule below:** Add a new rule below **Rule1**.
- **Duplicate rule:** Add a duplicate of **Rule1**.
- **Delete rule:** Delete **Rule1**.

If you added more than one rule, the following additional options are enabled to toggle the rules:

- **Move up**
- **Move down**
- **Move to top**
- **Move to bottom**

9. For **Rule2**, update the following fields:

Rule 2 is applied for a first-time user. If a user clicks **Select user type > New user**, the **User name** and **Password** text boxes are made unavailable. Use the **If** menu to set the following conditions:

- a) **Select user type** as the element condition in the first drop-down menu
- b) **Choice is** in the second drop-down menu
- c) **New user** in the third drop-down menu

Use the **Then** menu to set the corresponding actions:

- a) The **User name** text box in the first drop-down menu
- b) **Disable** in the second drop-down menu
- c) The **Password** text box in the third drop-down menu
- d) **Disable** in the fourth drop-down menu

10. Optional: If you want to interchange the sequence of these two rules, drag **Rule1** below **Rule2** or **Rule2** above **Rule1**.

You can also click the ellipsis (...) next to **Add rules** to select one of the following options:

- **Collapse all**: Collapses the rules. Is enabled only if you have expanded any of the available rules.
- **Expand all**: Expands the rules.

11. Click **Save**.

The new registration form is created and is ready to be linked to a bot.

Add a form to bot

Adding an existing form to a bot enables users to collaborate with bots. Use the necessary action items to create a bot and build a task logic.

This task describes a scenario where you want to design a bot that triggers an existing New User Registration form. A **Hot key** preset trigger starts the bot. An existing form that is linked to the bot is displayed where the user enters the information.

- If the user clicks **Submit**, a User Agreement form is displayed.
- If the user clicks **Cancel**, `User registration is canceled` message is displayed and the bot is terminated.

1. On the left pane, click **Automation**.

A list of available and forms is displayed.

2. Click **Create new > Bot**.

3. Enter a name for the bot.

All the bots are stored in the `\Bots` folder. Click **Browse** to change the folder.

4. Click **Create & edit**.

The bot builder pane is displayed that has **Flow** (default view), **List** and **Dual** view. You can drag the required actions from the left pane to create a task.

5. In **Triggers > Hot key**, drag **Hot key trigger** into **Drag a trigger here** in the bot logic.

6. Set **Ctrl** and **L** as the hot key combination.

7. Use the **Search actions** field to find **Interactive forms**.

8. Drag **Display** into the task logic.

You can use the display action to show the form when the bot is triggered. The display action properties appear on the right.

9. Click the create variable icon () to create a variable.

You have to create a form variable by linking an existing form. This enables you to use the form variable and the associated form across multiple instances.

Note: The form variable can be linked only to forms created using the Control Room form builder.

10. On the **Create variable** screen, enter a name for the form variable you are creating.
11. Click **Browse** and select the New User Registration form.
This links the New User Registration form to the form variable that you are creating.
12. Click **Create & select**.
A new form variable is created. For any existing form variable, use the **Form name** drop-down menu to select it.
13. Use the **Search actions** field to find **Trigger loop** and drag it to add event monitoring.
Event monitoring enables you to simultaneously set multiple events within the task logic of a bot.
14. Drag **Handle** into the **Trigger loop**.
Handle enables you to run an action by configuring a trigger in the **Trigger loop: Handle** for the bot. You can set a trigger when a event occurs on the selected interface (selected application) or when a user clicks the selected form element.
15. For this scenario, use the **Trigger on** drop-down menu to select **INTERACTIVE FORMS > Form trigger**.
16. Click the **Form name** drop-down menu and select the New User Registration form.
This enables you to set a trigger for the **Submit** option of the New User Registration form.
17. Click the **Form element** drop-down menu and select **Submit**.
For the **Button** element of a form, the **Select action trigger** is set to **Clicked** by default. When the user clicks **Submit** on the New User Registration form, it triggers the User Agreement form.
18. (Optional) Use **Assigned to** to create a variable.
You can use this variable to fetch various details for the element you have selected in the **Form element** drop-down menu. This return value is either a string or number based on the element type selected. For example, if you have selected the **Date** element, the return value is a string.
19. Search for **Interactive forms** and drag **Display** into **Trigger loop: Handle**.
20. Click the **Form name** drop-down menu and select User Agreement form.
The User Agreement form appears.
21. Search for **Message** and drag it into **Trigger loop: Handle**, after **Interactive forms**.
A successful registration message appears when the user clicks **Submit**.
22. Terminate the trigger by dragging **Break** into the **Trigger loop**.
Use **Break** to exit the current event loop and for actions where finishing a process is required.
23. Drag another **Handle** next to the **Trigger loop: Handle**.
This enables you to set a trigger for the **Cancel** option of the New User Registration form.
24. Click the **Form element** drop-down menu and select **Cancel**.
25. Search for **Message** and drag it into **Trigger loop: Handle**. Update the **Enter the message to display** field as User registration is canceled.
When the user clicks **Cancel** on the New User Registration form, it triggers a `User registration is canceled` message and terminates the bot.
26. Drag **Trigger Loop > Break** to terminate the loop.
27. Click **Save**.
28. Click **Run with triggers**.
The **Run with triggers** sets the **Hot key** trigger to start the bot, which is Ctrl plus L combination from the keyboard in this scenario.

Related reference

[Interactive forms package](#)

The interactive forms package contains actions that handle exceptions encountered by a bot. All the actions performed by users on the interactive forms can be monitored to execute logic using subtasks.

Adding a trigger to run a bot

Add triggers that can automatically run the selected bot whenever a specific event occurs. For example, clicking a specific button or using a combination of keystrokes.

Triggers integrate predefined events into your workflow and reduce the number of repetitive tasks that users must perform. Attended automation in Automation 360 enables you to create unique triggers for various applications. You can then use these triggers to start a bot.

Use one of the following types of triggers to start a bot:

Important: Trigger are not supported for private workspace, the trigger functionality will not work.

Email

Starts a bot when a new email message is received in the specified email service such as Microsoft Outlook, Email server, or EWS server.

Files and folders

Starts a bot when a predefined file or folder event occurs. You can set one of the following options as the trigger:

- When a new file or folder is created.
- When an existing file or folder is deleted.
- When a file or folder is renamed.
- When a file or folder is modified.

Hot key

Starts a bot when a predefined combination of keystroke is performed on the keyboard. You can set a combination of the following keys as the trigger:

- Control keys such as Ctrl, Alt, Windows logo key, and Esc.
- Keys with regular alphabetical (English) characters.

Interface

Starts a bot when a predefined event occurs on the selected user interface element. Some examples of the predefined events are:

- User clicks a button.
- User opens or closes an application.
- User selects or clears a checkbox.

Note: When capturing an interface trigger in a SAP application, ensure that both the Recorder and Interface trigger packages are from Build 5933 or from a prior release.

Process

Starts a bot when a predefined event occurs on the selected Microsoft Windows process. Some examples of the predefined events are:

- User starts a process.
- User stops or closes a process.

Service

Starts a bot when a predefined event occurs on the selected service in Microsoft Windows. Some examples of the predefined events are:

- Service starts or stops.
- User pauses the service.
- User resumes the service that was paused\.

Window

Starts a bot when a predefined event occurs on the selected application window. An example for a predefined event is when a user opens or closes an application.

Related reference

[Trigger loop package](#)

The **Trigger loop** package enables you to run a series of actions when a trigger event occurs. You can insert multiple trigger loops within a bot or nest one trigger loop within another trigger loop.

Add an email trigger

Starts a bot when a new email message is received from the predefined email service.

Connect the Control Room to one of the email services on your system and trigger the bot when you receive a new email.

For email automation, you can use OAuth 2.0 to authenticate with the email server. To register your application with the Microsoft identity platform, see [Using Connect action for Email](#)

1. On the left pane, click **Automation**.
A list of available and forms is displayed.
2. Click **Create new > Bot**.
3. Enter a name for the bot.
All the bots are stored under the `\Bots` folder. (Optional) Click **Browse** to change the folder.
4. Click **Create & edit**.
5. In the bot builder page, click **Triggers > Email trigger**.
6. Drag **Email** into **Drag a trigger here**.
7. Use the **Email trigger** pane on the right to choose one of the following server types as the trigger for your incoming emails:

Server type	Steps
Microsoft Outlook	Click Outlook . Microsoft Outlook is set as the email service and the bot is triggered when you receive a new email.

Server type	Steps
Email server	<p>Click Email server.</p> <p>a. Enter the email service Host information. For example, if you are using Office365 as your email service, enter Outlook.office365.com.</p> <p>b. Select IMAP or POP3. IMAP and POP3 are protocols used to connect to the mail server that enables you to read your emails through an email client.</p> <hr/> <p>Note: The POP3 protocol has a known limitation where any new calendar invite can also trigger the bot.</p> <hr/> <p>c. Use secure connection (SSL/TLS): Select this option if you want to use a secure connection with the mail server.</p> <p>d. Enter the configured port number for your email server.</p> <p>e. Select one of the following user authentication methods to sign in to the email server:</p> <ul style="list-style-type: none"> • Basic <ul style="list-style-type: none"> • Credential: Click Pick to select the stored Username and Password. <i>Credentials and credential variables in the Bot editor</i> • Insecure string: Enter the username and password. • Client credentials <ul style="list-style-type: none"> • Specify the unique client and tenant IDs generated when you registered the application in the Microsoft Azure portal. • Specify the username you want to use to access the mail server. • Specify the client secret that you generated for your app in the app registration portal. For Client ID, Tenant ID, Username and Client Secret fields, choose from Credential or Insecure string tab: <ul style="list-style-type: none"> • Credential: Use a value available in the credential vault. • Insecure string: Manually enter a value. <hr/> <p>Note: The Email in folder does not support sub-folders when you set the protocol as POP3 for Email Server,</p> <hr/>

Server type	Steps
EWS server	<p>Click EWS server.</p> <ol style="list-style-type: none"> a. From the Microsoft Exchange Version drop-down menu, select your current version. For example, if you are using Microsoft Exchange Service Pack 2, select Exchange2010_SP2 as your email service. b. Enter the domain name, for example, <code>smtplib.office365.com</code> c. Select one of the following user authentication methods to sign in to the email server: <ul style="list-style-type: none"> • Basic <ul style="list-style-type: none"> • Credential: Click Pick to select the stored Username and Password. <i>Credentials and credential variables in the Bot editor</i> • Insecure string: Enter the username and password. • Client credentials <ul style="list-style-type: none"> • Specify the unique client and tenant IDs generated when you registered the application in the Microsoft Azure portal. • Specify the username you want to use to access the mail server. • Specify the client secret that you generated for your app in the app registration portal. <p>For Client ID, Tenant ID, Username and Client Secret fields, choose from Credential or Insecure string tab:</p> <ul style="list-style-type: none"> • Credential: Use a value available in the credential vault. • Insecure string: Manually enter a value.

8. Optional: Use the **Check every** drop-down menu available under all the server types to set the trigger interval.

The trigger interval for the bot is set to 120 seconds by default.

9. Optional: Use **Select Conditions** to specify an email event for the selected server type.

Consider a scenario where you select **Outlook** and want to trigger a bot when you receive an email from a specific sender. In **Select Conditions**, select the **Email from** check box and specify the sender's email address.

When you select the **Email subject contains** check box, the email trigger is executed depending on the following subject conditions:

- When the subject line is provided within double quotation marks (""), for example, "ABC spreadsheet", the trigger is executed only when the email subject has an exact match for the string provided within quotation marks.
- When multiple subject lines are separated by semicolons, for example, ABC spreadsheet; ABC project logs, the trigger is executed when the email subject matches any of the subject lines mentioned.

10. Optional: To create a variable, in the **Assigned to > Record** tab, click .

You can use this variable to retrieve various details about the email that triggered the bot, such as sender, recipient, subject, email content, date, action information, email server host, and port data.

11. Click **Apply**.
12. Click **Run > Run with triggers**.

Microsoft Outlook, Email server, or EWS server is set as the trigger to start the bot for new emails.

Note: When you run an email trigger, the **emailTo** key returns a list of To addresses. To convert the list of To addresses into a string, use the **Assign** action from the List package and then use the **Join items** action from the List package, with the comma as a delimiter to separate the addresses.

Add a file and folder trigger

Starts a bot when a predefined action such as create, delete, rename, or modify is performed on a file or a folder.

This procedure is for a scenario where you want to trigger a bot when a user modifies a document called `Product info.docx`.

Note: This scenario is for a user with Bot Creator role.

For information about how a user with a Bot Runner role can link event triggers, see [Linking event triggers to a Bot Runner](#).

-
1. On the left pane, click **Automation**.
A list of available and forms is displayed.
 2. Click **Create new > Bot**.
 3. Enter a name for the bot.
All the bots are stored under the `\Bots` folder. (Optional) Click **Browse** to change the folder.
 4. Click **Create & edit**.
 5. In the bot builder page, click **Triggers > Files & folders**.
 6. Drag **File trigger** into **Drag a trigger here**.
 7. Click **Browse** and select the `Product info.docx` file.
 8. From the **Start the bot when the file is** drop-down menu, select **modified**.
This sets the trigger for the bot.
 9. Optional: Use the **Assigned to** drop-down menu to assign a variable.
If you want use the **Variables** tab to create a variable, ensure you select the **Use as input** check box for it to appear in the **Assigned to (optional)** drop-down menu.

Note: If you use the `{}^v` in the **Assigned to (optional)** drop-down menu to create a variable, ensure that you do not select the **Constant (read only)** check box.

The following set of data can be retrieved by defining a variable as the input type, which you can assign to get output from the trigger:

- **triggerType:** File or folder trigger
- **eventType:** The type of trigger event

The following set of data cannot be used if the **Set Schema** check box is selected as it returns a non-string variable type:

- **timeStamp:** The time when the trigger occurred

Ensure you link the **timeStamp** value to a string variable to obtain the trigger data. For example, consider you want to extract the date and time for the trigger event when a user modifies the

Sales update.xls file. Use the **Message** action within the task logic, and enter `Date Time-$recordVar[2]$` in the **Enter the message to display** field.

- **fromFolder:** Details of the parent folder path
- **folder:** Details of the file or folder path on which the event occurred

10. Click **Save**.

11. Click **Run > Run with triggers**.

Whenever a user modifies the `Product info.docx`, the bot is triggered.

Related reference

[Event triggers](#)

An event trigger is a predefined action that runs an associated bot. All the bots with event triggers are listed under the **Event triggers** tab.

Add a hot key trigger

Starts a bot when a predefined combination of keys is used on the keyboard.

This procedure is for a scenario where the bot is triggered when a user presses Ctrl (plus) L keys from the keyboard.

Note: Hot key triggers are supported on both attended and unattended Bot Runner licenses. However, the hot key trigger will work for unattended Bot Runner users only if they have access to the associated default device and they use the predefined keys.

1. On the left pane, click **Automation**.
A list of available and forms is displayed.
2. Click **Create new > Bot**.
3. Enter a name for the bot.
All the bots are stored under the `\Bots` folder. (Optional) Click **Browse** to change the folder.
4. Click **Create & edit**.
5. In the bot builder page, click **Triggers > Hot key**.
6. Drag **Hot key trigger** into **Drag a trigger here**.
7. Click **Ctrl** to set it as the **Hot key** from the available key modifiers.
8. Use the drop-down menu to select **L** from the keyboard.
The **Hot key** field displays the key combination that will trigger the bot.
9. Click **Apply**.
10. Click **Run > Run with triggers**.
When the Ctrl and L keys are used on the keyboard, the bot is triggered.

Add an interface trigger

Starts a bot when a predefined action occurs on a specific interface element, such as clicking a button or closing an application.

The following procedure is for a scenario where you want to configure a trigger to start a bot when the user clicks **New** option in Microsoft Word. Before you configure the trigger, ensure that you have the Microsoft Word application open on your system.

Note: Interface triggers for objects are available only for native Windows applications.

Note: Interface triggers are supported on both attended and unattended Bot Runner licenses. However, the interface trigger will work for unattended Bot Runner users only if they have access to the associated default device and perform the predefined action on the specified interface element.

1. On the left pane, click **Automation**.
A list of available and forms is displayed.
2. Click **Create new > Bot**.
3. Enter a name for the bot.
All the bots are stored in the \Bots folder. (Optional) Click **Browse** to change the folder.
4. Click **Create & edit**.
5. In the bot builder page, click **Triggers > Interface trigger**.
6. Drag **Object** into **Drag a trigger here**.
The **Interface trigger: Object** editing panel appears.
7. In **Window detail** tab, click **Application**.

Note: For browser-based events, click **Browser** and select the correct browser tab. Interface triggers are supported on only Google Chrome and Edge Chromium browsers.

8. Click the drop-down menu and select **Taskbar** under **Preset**.
If Microsoft Word is not displayed in the list, you can use the Refresh option to reload the list of applications.
9. Click **Capture object**.
This initiates a built-in web recorder that captures the action. In this scenario, Microsoft Word is displayed. Click **New**, which is then set as the trigger to start the bot.
10. Click the **Select main event** drop-down menu to choose a specific event.
In this scenario, **New** in Microsoft Word is considered a button and the following events are available:
 - **Click:** Triggers the bot when the user clicks the selected main event object.
 - **Click with hotkey:** Use one of the available key modifiers and select a key (alphabetical letters) from the drop-down menu. This combination is set as the hot key to trigger the bot.
11. **Optional:** Select one of the available Control keys (Shift, Alt, Ctrl, Windows and AltGr) as an additional combination for the hot key to trigger the bot.
12. Click **Save**.
13. Click **Run > Run with triggers**.
The preset trigger is created, and the bot is triggered when the user clicks **New** in Microsoft Word.

Add a process trigger

Starts a bot when a predefined action occurs on the selected Microsoft Windows process.

This procedure is for a scenario where you want to configure a trigger to start a bot when users launch or close Microsoft Outlook. Before you configure the process trigger, ensure that you have the Microsoft Outlook application open on your system so that you can select this process.

1. On the left pane, click **Automation**.
A list of available and forms is displayed.
2. Click **Create new > Bot**.
3. Enter a name for the bot.
All the bots are stored in the \Bots folder. (Optional) Click **Browse** to change the folder.
4. Click **Create & edit**.

5. In the bot builder page, click **Triggers > Process trigger**.
6. Drag **Process** into **Drag a trigger here**.
The **Process trigger: Process** editing panel appears.
7. Click the **Process name** drop-down menu and select **Outlook.exe**.
Refresh the **Process name** drop-down menu if none of the processes are listed.
8. Select the following check boxes to set the trigger condition:
 - **Starts**: Triggers the bot when users launch or start Microsoft Outlook.
 - **Stops**: Triggers the bot when users close or stop Microsoft Outlook.
9. Optional: Use the **Assigned to** drop-down menu to assign a variable.
If you want to use the **Variables** tab to create a variable, ensure that you select the **Use as input** check box for it to appear in the **Assigned to (optional)** drop-down menu.
10. Click **Save**.
11. Click **Run > Run with triggers**.
The preset trigger is created, and the bot is triggered when the user launches or closes the Microsoft Outlook application.

Add a service trigger

Starts a bot when any of the predefined actions occur on the selected service in Microsoft Windows.

This procedure is for a scenario where you want to configure a trigger to start a bot when the **Windows Update** service is started, stopped or is paused by a user.

1. On the left pane, click **Automation**.
A list of available and forms is displayed.
2. Click **Create new > Bot**.
3. Enter a name for the bot.
All the bots are stored in the `\Bots` folder. (Optional) Click **Browse** to change the folder.
4. Click **Create & edit**.
5. In the bot builder page, click **Triggers > Service trigger**.
6. Drag **Service** into **Drag a trigger here**.
The **Service trigger: Service** editing panel appears.
7. Click drop-down menu and select **Windows Update**.
Refresh the drop-down menu if none of the services are listed.
8. Select the following checkboxes to set the trigger condition for the **Windows Update** service:
 - **Starts**
 - **Stops**
 - **Pauses**
9. Optional: Use the **Assigned to** drop-down menu to assign a variable.
If you want use the **Variables** tab to create a variable, ensure you select the **Use as input** check box for it to appear in the **Assigned to (optional)** drop-down menu.
10. Click **Save**.
11. Click **Run > Run with triggers**.
The preset trigger is created, and the bot is triggered when any user starts, stops or pauses the **Windows Update** service.

Add a window trigger

Starts a bot when the predefined application window is opened or closed by the user.

This procedure is for a scenario where you want to configure a trigger to start a bot when any user opens a Microsoft Excel document called **Customer_database.xls**. Before you configure this window trigger, ensure that you have opened the **Customer_database.xls** document on your system so that you can select this window.

1. On the left pane, click **Automation**.
A list of available and forms is displayed.
2. Click **Create new > Bot**.
3. Enter a name for the bot.
All the bots are stored in the `\Bots` folder. (Optional) Click **Browse** to change the folder.
4. Click **Create & edit**.
5. In the bot builder page, click **Triggers > Window trigger**.
6. Drag **Window** into **Drag a trigger here**.
The **Window trigger: Window** editing panel appears.
7. Click the **Window** drop-down menu and select **Customer_database.xls**.
Refresh the **Window** drop-down menu if none of the available windows are listed.
8. Under the **Window title** field, click the **String** tab to set the entire title of the selected window.
The **Regex** tab can be used to select a pattern that matches the selected window title. For example, if you select the **Regex** option in this scenario, the bot is triggered if the user opens any `.xls` file.
9. Select **Open** from the **Window action that start the bot** drop-down menu.
10. Optional: Use the **Assigned to** drop-down menu to assign a variable.
If you want use the **Variables** tab to create a variable, ensure you select the **Use as input** check box for it to appear in the **Assigned to (optional)** drop-down menu.
11. Click **Save**.
12. Click **Run > Run with triggers**.
The preset trigger is created, and the bot is triggered when any user opens the **Customer_database.xls** document.

ServiceNow New Record trigger

Create a trigger to monitor a ServiceNow table for new records and begin succeeding RPA actions in your bot flow.

- The bot creator must have access to a ServiceNow account with required permissions to perform tasks enabled by this package. See [Roles](#).
- Follow ServiceNow guidelines for authenticating to an external client with OAuth 2.0. See [Set up OAuth](#).
- Create a Developer account and Developer instance in ServiceNow. See [Personal Developer Instances](#).
- Ensure that you are authenticated before initiating any ServiceNow action. See [Authentication](#)

The new record trigger monitors the creation event of any record within a time period. Upon record creation, the trigger invokes and returns data. If multiple records are created within the entered time period, then the trigger returns data of multiple records.

Map your trigger to a ServiceNow table, and then enter the time period to send a query for that table data. When a new record is found, this trigger is invoked and begins succeeding bot actions.

1. Enter the **URL** for your ServiceNow instance.

2. (Optional) Enter the API version.
3. Select how ServiceNow credentials will be entered for the following fields.

Option	Description
Credential	Select a credential saved in a secure locker that you have mapped to your Control Room.
Insecure string	Enter the credential.

- a) Enter the **Client ID**.
 - b) Enter the **Client secret**.
 - c) Enter the **Username**.
 - d) Enter the **Password**.
4. Enter the **Table name** in ServiceNow to monitor for new records.
A query is sent, and ServiceNow returns data for this table. When a new record is returned in the data, then this trigger is invoked.
 5. (Optional) To store a response from ServiceNow, select and enter a **List** or **Variable** input where the response is stored.
 6. (Optional) Apply filters to specify the type of ServiceNow record to monitor.
 7. Enter how frequent the trigger searches for new records in the **Check every (seconds)** field.
 8. (Optional) Select a variable to save returned data by the trigger.

ServiceNow Updated Record trigger

Create a trigger that monitors a ServiceNow table for updated records and begins succeeding RPA actions in your bot flow.

- The bot creator must have access to a ServiceNow account with required permissions to perform tasks enabled by this package. See [Roles](#).
- Follow ServiceNow guidelines for authenticating to external client with OAuth 2.0. See [Setup OAuth](#).
- Create a Developer account and Developer instance in ServiceNow. See [Personal Developer Instances](#).
- Ensure that you are authenticated before initiating any ServiceNow action. See [Authentication](#)

The updated record trigger monitors the record within a time period. When updates occur, the trigger invokes and returns data. If multiple records are updated within the entered period, then data of multiple records is returned.

Map your trigger to a ServiceNow table. Enter the time period to send a query for that table data. When an updated record is found, this trigger is invoked and can begin succeeding bot actions.

1. Enter the **URL** for your ServiceNow instance.
2. Enter the API version.
3. Select how ServiceNow credentials will be entered for the following fields.

Option	Description
Credential	Select a credential saved in a secure locker that you have mapped to your Control Room.

Option	Description
Insecure string	Simply enter the credential. This data will remain visible.

- a) Enter the **Client ID**.
 - b) Enter the **Client secret**.
 - c) Enter the **Username**.
 - d) Enter the **Password**.
4. Enter the **Table name** where the record is located in ServiceNow.
This data is what the trigger monitors. A query is sent, and ServiceNow returns data for this table. When a record update is returned in the data, then this trigger is invoked.
 5. (Optional) To store a response from ServiceNow, select and enter a **List** or **Variable** input where the response is stored.
 6. (Optional) Apply filters to specify the type of ServiceNow record to monitor.
 7. Enter how frequent the trigger searches for updated records in the **Check every (seconds)** field.
 8. (Optional) Select a variable where returned data is saved by the trigger.

Example for using hot key to trigger a bot

In this example, a front desk executive of an insurance company responds to a call from an existing customer who wants to understand the policy details and its validity. The executive uses a hot key to trigger a bot that retrieves the customer's information.

Information about all the existing customers and the insurance company's various policies is distributed across two different databases. An existing bot maps the data between the two databases and provides consolidated information in a user readable format to the executive. **Ctrl+L** is set as the hot key to trigger this bot.

1. The executive collects caller's information to verify if it is an existing customer.
The executive confirms the caller is an existing customer who wants to know the policy details.
2. The executive uses **Ctrl+L** to trigger a bot.
The bot retrieves the customer information and the corresponding policy details. An authorization message is displayed.

- The executive reviews the information that is consolidated in a form, and answers the customer queries without any delay or hold time.

The following image illustrates this attended automation scenario:

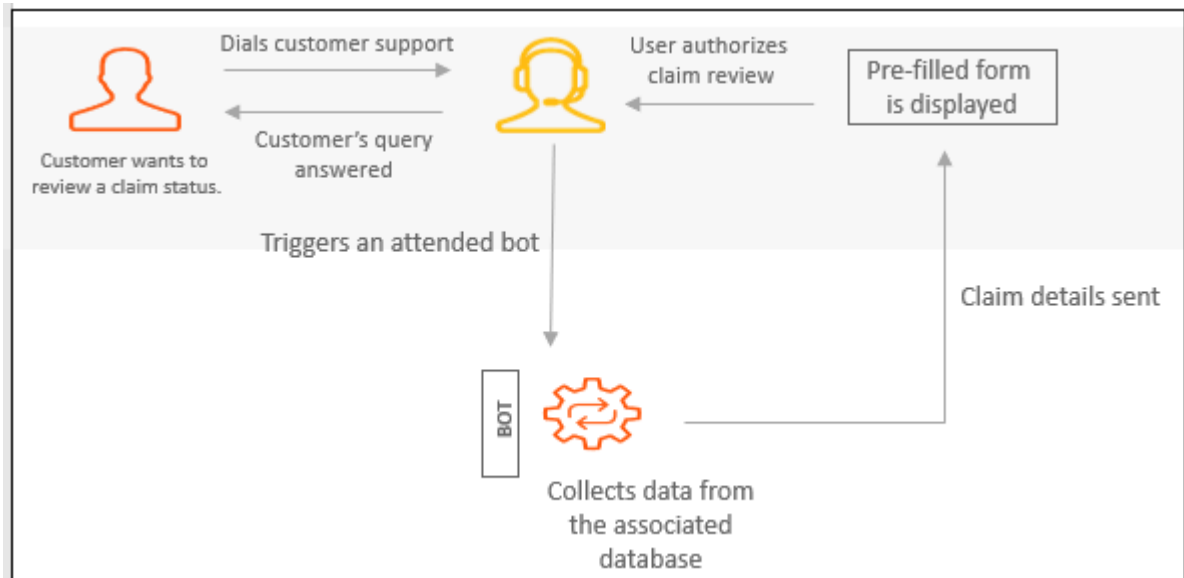

Embedded Automation

Access automated processes and bots from any platform with an embedded interface. Embedded Automation delivers automation everywhere you want, either integrated with your web application or delivered through a browser extension.

Why use Embedded Automation

Embedded Automation brings the power of AARI directly to any cloud environment or web application packaged in an intuitive widget interface. The capability of Embedded Automation empowers end users with essential access to data across platforms, delivered directly to their core interactive space. This data access could be forms, applications, business history, and more. Whenever users need data, Embedded Automation ensures that it is readily available.

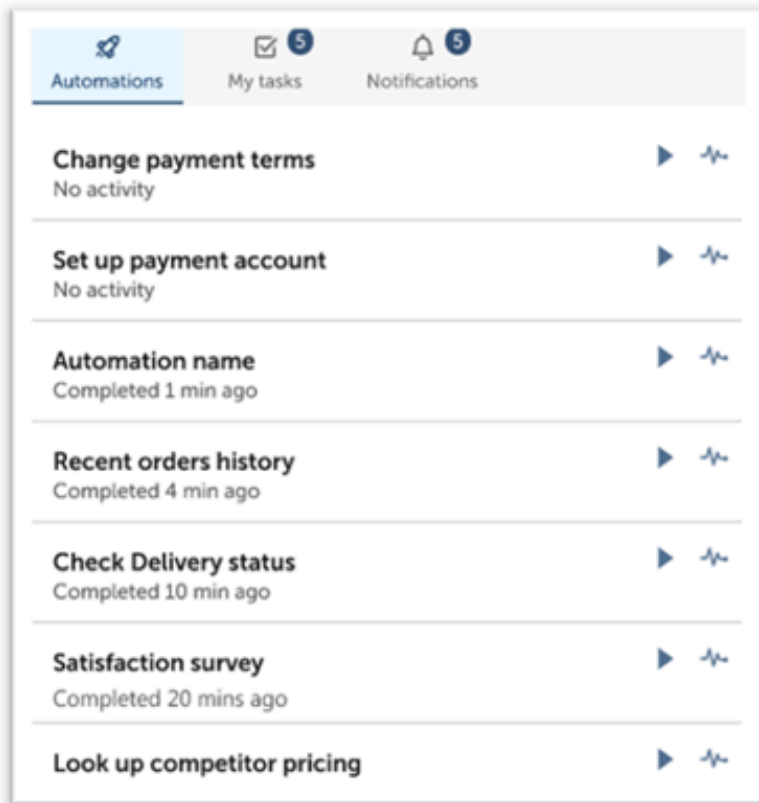

iFrame Widget
for web apps supporting
customization



Embed automation
in any web
application



Attended,
unattended and
process automations



Lightweight and
responsive
interface



Seamless
authentication with
OAuth 2.0 or SAML
SSO

With automations a click away, there's little need to keep open an additional application in your workspace. Automations can simply be embedded in the familiar space you spend the majority of time. With accessible automations, users are able to quickly reach out, deliver data, keep a customer interaction engaging and progressive, and reduce time spent waiting.

What you can do with Embedded Automation

There are many cases where users can leverage this ever-present access to launch automations and processes in their familiar environment. The following are a few cases where Embedded Automation improves workflow with streamlining and precision:

Fetch case data from user input or from hosting data input

Access, complete, and submit forms with business data onscreen in your web application. This further empowers running attended bots that rely on source context and visual cues while executing.

Launch automation with hosting data input

While updating an account, business users can run a bot that takes a sales order number, fetches additional details as needed, and then pushes all details into the system to immediately begin billing for the sale.

Orchestrate case resolution and business workflow

Automated processes can guide agents through a complex task involving management approval, prompting and alerting team members during process phases to expedite approval, and finally enter customer and business data into a final document rendered for official record.

Automate mundane local tasks

Bots can upload sales leads or contact info from a desktop spreadsheet to web applications with one easy click.

Embedded Automation components

The two main components in Embedded Automation are as follows:

A widget within web application through AARI Integrations

AARI Integrations embeds in web applications as a widget. If you are an end user you can access automated processes and bots without leaving your environment. The widget is composed from an HTML inline frame or simply an iFrame widget that the user can configure and access in supported web browsers.

An extension on Google Chrome browser through AARI Extensions

AARI Extensions embeds in web applications as a side panel rendered by an extension for Google Chrome browser. As an end user, you can access automated processes and bots without leaving your environment. In addition, AARI Extensions offers further adaptability through web page customization, such as mapping an automation to web elements, for example, a button. With an OAuth 2.0 connection, existing access to automations in the Control Room are now shared with AARI Extensions to offer you a seamless user experience.

<https://aa2019packagesdkfordocumentation.s3.us-west-2.amazonaws.com/videos/embedded-highlight-aari.mp4>

The AARI admin has the key role of organizing access points for business users using Embedded Automation.

For AARI Integrations, the iFrame widget embeds seamlessly into adjacent content of your web application. The AARI admin must first set up and configure the iFrame widget details using AARI and then assign automations to teams by adding specific members of a team and defining the team owners and admins. After setup is completed business users can deploy automations in their web application using the iFrame widget.

AARI Extensions has a similar setup process, differing in the way the widget is accessed, via an extension for Google Chrome browser. Because of this difference, a developer has to enable web components for the extension. Similar to AARI Integrations, the admin completes the setup and configuration of the iFrame widget using AARI. Next, a bot creator develops a web component using a Page Editor, assisted by the iFrame widget embed code, supplied in AARI. Newly created web components become visible within AARI for Administrators to assign to teams. Assigned users will then navigate to their web application and access the iFrame widget, while logged in to their Control Room.

References

Learn more about the usages of AARI Integrations and AARI Extensions in [AARI Integrations and AARI Extensions](#).

Learn more about Automation Anywhere Robotic Interface (AARI) and its functions in [Automation Anywhere Robotic Interface \(AARI\)](#).

AARI Integrations and AARI Extensions

Compare the two delivery methods of Embedded Automation to decide on the right component for your business needs.

AARI is a platform for automation to assist business users with common workflows. Users can continue to automate using AARI in their favorite web applications and CRM platforms, such as the ServiceNow service portal. When you use AARI Integrations to set up your iFrame widget, you can now access AARI through an embedded widget in your web application and deploy automations, all without the need to leave your environment.

Comparing Embedded Automation components

As you explore AARI Integrations and AARI Extensions, they might seem very similar. They are both solutions that provide your environment with an iFrame widget interface powered by AARI. The iFrame widget hosts automations from AARI on the web, offering the same power of automating with Automation 360.

Either AARI Integrations or AARI Extensions can deliver Embedded Automation. However, depending on where you aim to embed, one component might better suit your needs over the other.

Simply put, the decision to embed a widget in your environment relies on choosing one of the following.

- **Integration:** Add an iFrame to the source code of your web application.
- **Extension:** Develop custom bricks that are coded into your browser through an extension.

Consider technical specifications and styles of these components.

AARI Integrations

AARI Integrations embeds in web applications as an iFrame widget offering end-users access to automated processes and bots without leaving their environment.

Consider the following prerequisites for using AARI Integrations:

- Automation 360 v.26 or later.
- Google Chrome, Microsoft Edge Chromium, or Apple Safari web browsers. See [Browser requirements for RPA Workspace](#).
- AARI licenses and fluency.
- AARI web interface.
- Web application that supports the iFrame widget.

For further details on how to start using AARI Integrations, click the image to navigate to the overview topic:

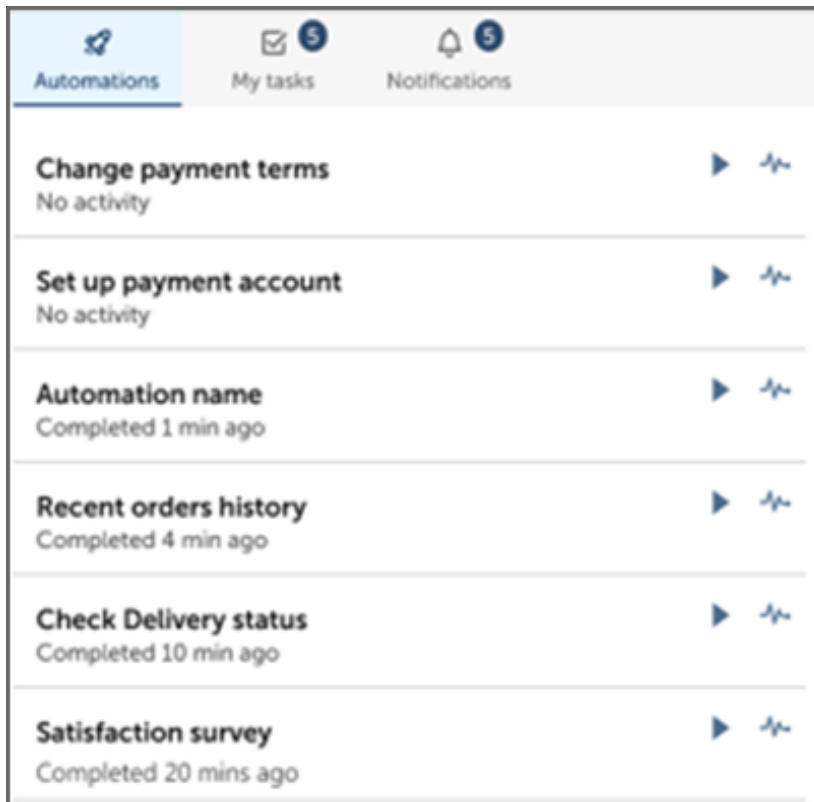

AARI Extensions

AARI Extensions relies on a Chrome extension of your web browser to embed automations. The widget appears outside the application as an Automation Anywhere stylized panel, as in the following image.

Consider the following prerequisites for using AARI Extensions:

- Automation 360 v.26 or later.
- Google Chrome web browser.
- AARI licenses and fluency.
- OAuth 2.0 Control Room configuration for server validation.

For further details on how to start using AARI Extensions, click the image to navigate to the overview topic:

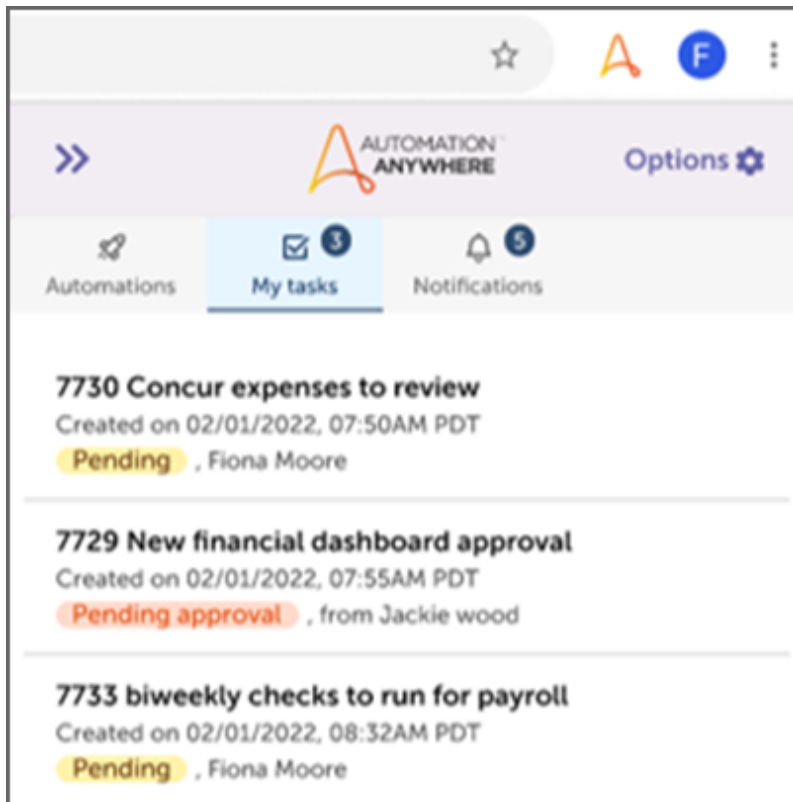

AARI Integrations overview

You can use a widget that embeds automations built on the Automation 360 platform that can be applied natively on any supported web application.

Capabilities

iFrame widget

A widget that is composed from an HTML inline frame, or simply iFrame widget, can be used as a "window" to access another website located in your current web application environment. In addition, the iFrame widget provides reliable and secure methods of quick integrations performance without the need for heavy development work, when involved with custom integrations.

For example, your current web application environment is domain 1, which can access a widget that shows a website from domain 2. These two domains exist in one shared environment, without you navigating to a separate page or window.

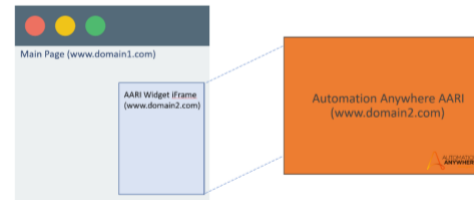

iFrame widget experience on supported web applications

The Automation 360 platform can support embedding an iFrame widget on any web application that supports the iFrame technology to access external contents. Many software-as-a-service (SaaS) web applications support the iFrame widget to allow for customization in a secure environment.

Business users can add contextual workflow automations from inside their most used and preferred enterprise applications. This approach means that users need to add only minimal code to their most used web applications, which when applied can produce a rich, friendly, and more secure interactive user experience.

Actions that can be performed with iFrame widget

Business users can use iFrame widget to perform the following:

- Invoke local automations on their desktop.
- Invoke multistep process workflows from AARI requests.
- Monitor request progress to completion.
- Receive notification of pending tasks.
- Respond directly to pending tasks from iFrame widget.
- View the history of currently running or previously completed automations.

Requisites

- Ensure that you have the proper role and permissions. [Create users for Automation Anywhere Robotic Interface](#)
 - AARI license.
 - Proper roles for AARI admin and user.
- Automation 360 v.26 or later.
- Google Chrome, Microsoft Edge Chromium, or Apple Safari web browsers. See [Browser requirements for RPA Workspace](#).
- AARI web interface.
- Web application that supports iFrame technology.

Process flow

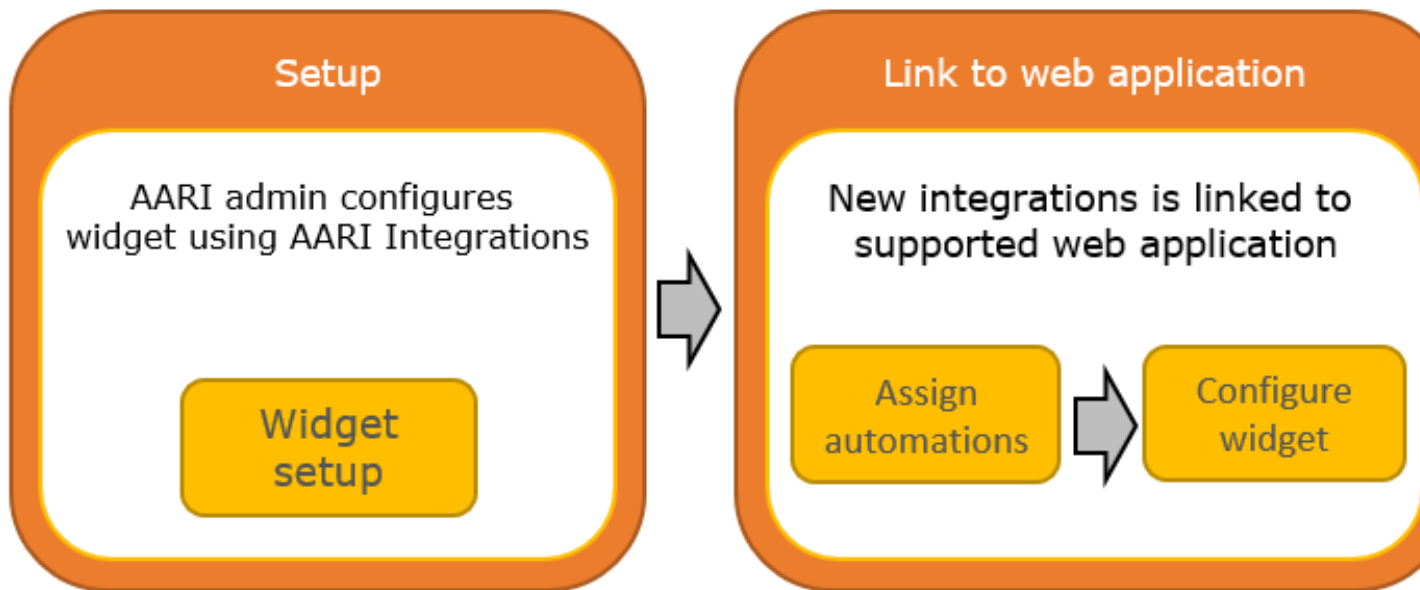

1. Set up your integrations and iFrame widget for a web application.
2. Assign automations to a team for them to access data from the iFrame widget.
3. Configure widget settings in a web application to properly access iFrame widget.
4. Deploy the iFrame widget.

Setup iFrame widget using AARI Integrations

You can define your integrations with iFrame widget for your supported web applications. This includes creating a new integration, iFrame widget, and configuring the iFrame widget code.

Ensure you have completed the following:

- Provided a system-created **AAE_Robotic_Interface Admin** role for the AARI admin.
- Have access to the AARI web interface.
- Complete any necessary password changes to access the AARI web interface.

For this task, you can create new integrations and configure your iFrame widget details including access to the embed code for you to copy and use in a web application.

Important: You can only setup integrations and iFrame widget details for web applications that supports the iFrame widget. If the web application does not support the iFrame widget, refer to [AARI Integrations](#) and [AARI Extensions](#).

1. Log in to the AARI web interface.
2. Navigate to **Manage > Integrations**.
The **Integrations Setup** page appears for you to setup your connection. If this is your first time accessing this page, you will see the **No Integrations** label.
3. Click **Add Integrations** to add a new integration.

4. Specify a name for the integration in the **Name** field.
You can name it **Integrations** or the name of your favorite web application to help you define the web application that you plan to embed the iFrame widget.
5. **Optional:** Specify a description for your integration in the **Description** field.
6. Click **Create & edit**.
Your integrations is now created and forwards you to an **Edit integration** page that you can edit your integration.
7. Navigate to the **Widgets** tab in the same page.
You can add iFrame widgets to your integration in this tab.
8. Click the plus (+) icon.
The **Add Widget** page prompts you to add a new iFrame widget to your integration.
9. Specify a name for the iFrame widget in the **Widget name** field.
10. Specify your tags in the **Filtered automations** field.
You can select existing tags from the drop-down to add to the widget. When you add tags, they display in the **widget** tab in the **tags** column next to the widgets.

11. Click **Save**.
You have now successfully defined a new iFrame widget for your integration.
You can now generate an iFrame code.
12. Click the three dots (ellipses) next to the name of your iFrame widget.
 - **Embed code** option allows you to generate code for the iFrame widget.
 - **Edit** option enables you to edit the iFrame widget details.
 - **Delete** option will delete the iFrame widget.
13. Click **Embed code** option.
The **Embed code** window appears and prompts you configure the code details.

14. Specify the size of the iFrame widget width and height in the **Widget width** and **Widget height** fields, respectively.

Note: The default size of the iFrame widget width and height are **100 %**. You can change % (default) to **px** for pixels depending on your preference.

15. Click **Copy** in the **Embed code** section to copy the code.

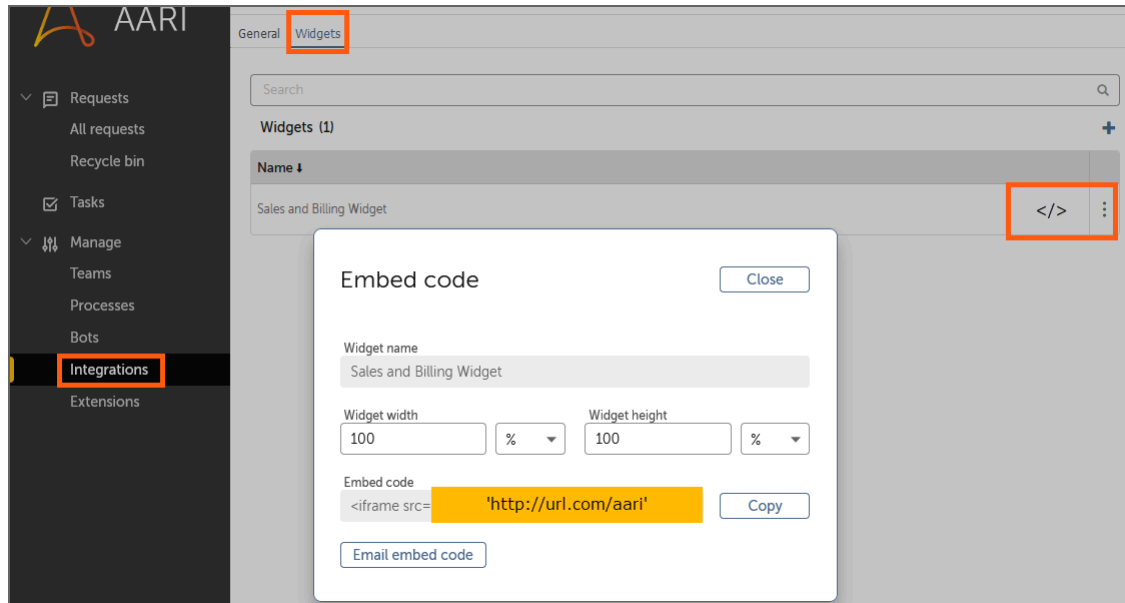

16. **Optional:** Click **Email embed code** if you would like to open your local mail client to email the embed code to another individual.

You now have access to the iFrame widget code.

17. Click **Close**.

You have now successfully copied your iFrame widget code that can be used in a supported web application.

For your next steps, you can assign automations to your team, see [Assign automations to teams](#).

Assign automations to teams

You can configure teams to access automations and tasks for it to be accessed via the Desktop Assistant, AARI web interface, and the iFrame widget embedded in other business applications.

Ensure you have completed the following:

- Provided a system-created **AAE_Robotic_Interface Admin** role for the AARI admin.
- Have access to the AARI web interface.

1. Log in to the AARI web interface.
2. [Assign members to a team](#).
3. [Assign teams to a process](#).
4. [Assign teams to a bot](#).

You have now assigned automations for your team. Members of your team can now automate using the iFrame widget.

For your next steps, you can configure the widget in a web application to access to automations in the iFrame widget, see [Configure iFrame widget in a web application](#).

Assign members to a team

You can follow this task to create a new team and assign members to your team.

1. Navigate to **Manage > Teams**.
The **Team Setup** page appears for you to create new or edit existing teams.
2. Click **Create new team**.
The **Create a team** window appears with details for you to edit.
3. Specify the name of the team in the **Team Name** field.
4. Specify a description for your integration in the **Description** field.
5. Select the **AARI Manager** option in the **Team admin** field.
The AARI manager will be the team admin that manages the user and their access.
6. Click **Create & edit**.
You will now be forwarded to the **Edit team** page where you can edit the team attributes.
7. Select the **Shared** or **Private** option in the **Request Visibility** section.
 - **Shared** option allows for all requests to be access by all member, owners, and team admins in the team.
 - **Private** option allows for the requests to be to be available to only the member who created the request, owner, and team admin in the team.
8. Navigate to the **Users** tab.
9. Click the plus (+) icon to add a users to your team.
10. Select a user or users to be added.
11. Click **Add & save**.
You have now added one or more users to your team.
12. Click **Close**.
You have successfully added users to your team. You can now add automations to the team that allows for members of your team to view and run the automations you assigned.

Related tasks

[Create an AARI team and assign team roles to members](#)

An AARI manager is a team admin who can create new teams, add members to their team, and assign new team roles. AARI admin can also configure a team but does not have a team role.

Assign teams to a process

You can follow this task to assign teams to a process.

1. Navigate to **Manage > Processes**.
The **Process Setup** page appears for you manage your process.
2. Select your existing process from the list of available processes.
For example, you select the **Ordered Items** process.
The **Edit process** page appears with details of your process.
3. Navigate to the **Teams** tab.
4. Click the plus (+) icon to assign the teams to your process.
5. Select your team or teams.
6. Click **Add & save**.
7. You can repeat these steps and add teams to another process of your choice.
8. Click **Close**.

You have successfully added teams your process.
You can now assign teams to your bot.

Related tasks

[Assign an AARI team to a process](#)

An AARI admin can configure processes in the web interface and assign teams to a process for request creation. They access the web interface to view and manage processes in the **Process Setup** page.

Assign teams to a bot

You can follow this task to assign teams to a process.

1. Navigate to **Manage > Bots**.
The **Bot Setup** page appears for you manage your bots.
2. Click **Add bot**.
The **Add bot** page appears for you to add available bots.
3. Select a bot or bots.
For example, you select the **Enterprise Account** bot.
4. Click **Add** to add bot.
The bot that you selected will now be added to the bot list.
5. Select the bot that was added.
The **Edit bot** page appears with details of your bot.
6. Navigate to the **Teams** tab.
7. Click the plus (+) icon to assign the teams to your bot.
8. Select the team that you have created.
9. Click **Add & save**.
10. Click **Close**.
You have now successfully added teams your bot.

Configure iFrame widget in a web application

You must configure iFrame widget settings in a supported web application to properly enable the iFrame widget.

Ensure you have completed the following:

- Provided a system-created **AAE_Robotic_Interface User** role for the AARI user.
- Have access to the AARI web interface.
- Have access to the web application of your choice that supports the iFrame technology. For this task, it would be the ServiceNow Service Portal and ServiceNow App Engine Studio.

1. Log in to the ServiceNow Service Portal.
2. Navigate to the **Widget Editor** page.
This page has a few options for you to configure your widget, as well as a reference for you to view any recently updated widgets.
3. Click the **Create a new widget** option for creating new widgets.
The **Add a Widget** window appears with details for you to specify your widget.
4. Specify the name of the widget in the **Widget Name** field.
The ID of the widget will be automatically generated when you enter the name.

For example, you can name your widget **AA Bots** for reference that this is an Automation Anywhere bots widget.

5. Click **Submit.**

A new window with an HTML template or editor prompts you to enter the iFrame widget details, if applicable.

```
HTML Template
1 <div>
2 <iframe src="https://embed.aaiengineering.com/aari/#/embedded" name="aari-embedded-app" width="370px" height="650px"></iframe>
3 </div>
```

6. Paste your iFrame widget code to the **HTML template.**

This is the iFrame widget code that you had generated in the AARI web interface.

7. Click **Save or press **Ctrl + S** to save the current session.**

You have now added the iFrame widget code and saved your session. This is the code to embed your iFrame widget.

8. Access to the main page of the ServiceNow App Engine Studio.

9. Navigate to **All > Service Portal Configuration**

10. Click **Designer.**

11. Select an existing page to edit.

You are now directed to a designer page.

12. **Optional: Rearrange or remove your existing widgets on the page, to give space for the iFrame widget.**

13. Drag the widget you had created (ex: **AA Bots) from the **Widgets** tab and place it on the page.**

You have now successfully added the iFrame widget and should now be visible on the page.



Attention: The iFrame widget is visible but with no styling applied.

14. Navigate back to the ServiceNow Service Portal

15. Click **Widget Editor.**

16. Click on your widget (ex: **AA Bots) from the **Recently Updated** list.**

You are now navigated to the window with an HTML template. The page should also include a CSS template.

17. Specify the widget (ex: **AA Bots) details in the **CSS** template.**

This can be the border size, style, and color of the widget.

```
CSS - SCSS
1 iframe{
2   border-width: 1px;
3   border-style: solid;
4   border-color: #dee5e7;
5   border-radius: 0.4rem;
6 }
```

18. Navigate back to the designer page.

The iFrame widget structure has now been updated.

19. Refresh the page.

You will notice a small-sized window that appears and is connected to the AARI web interface with a login page.

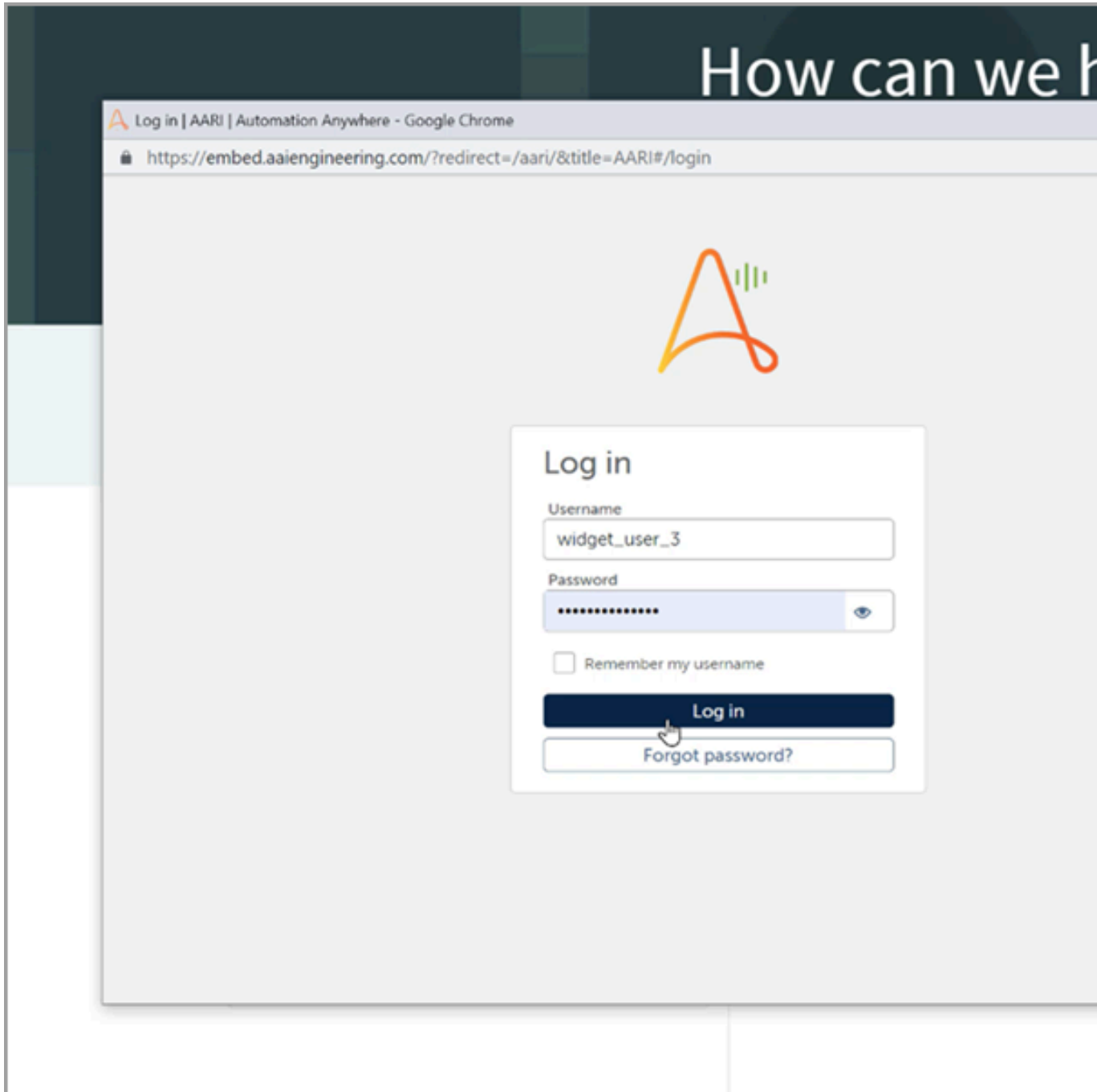
**20.** Log in with your user credentials to the iFrame widget in order to access your AARI data.

The iFrame widget will refresh and a list of automations and tasks from AARI is now available. You can interact directly with your data.

21. View the iFrame widget.

The screenshot displays a web application interface. At the top, there are two main sections: 'Request Something' (Browse the catalog for services and items you need) and 'Knowledge Base' (Browse and search for articles, rate or submit feedback). Below these, the interface is divided into a sidebar and a main content area. The sidebar contains 'Current Status' (No system is reporting an issue), 'Announcements' (Employee Center is available to you), and 'My Assessments and Surveys' (No assessments or surveys for you at the moment). The main content area features a 'My Tasks' section with a list of automation tasks: 'Hardware Replacement Request', 'Request New License for Application', 'Reset Password to Application', 'Virtual Machine Request', and 'VPN Access'. A red box highlights this 'My Tasks' section.

You have now successfully embedded the iFrame widget with AARI data to your web application.

For your next steps, you can deploy your automations using the iFrame widget, see [Deploy automations in web application](#).

Deploy automations in web application

You can now automate your tasks using the iFrame widget.

Ensure you have completed the following:

- Provided a system-created **AAE_Robotic_Interface User** role for the AARI user.
- Have access to the AARI web interface.
- Have access to the web application of your choice that supports the iFrame technology. For this task, it would be the ServiceNow Service Portal.

1. Log in to the ServiceNow Service Portal.

2. Navigate to the page(s) on which you had embedded the iFrame widget.

This can be the **Designer** portal in the ServiceNow Service Portal where you manage your data and relevant information.

- 3.** Log in with your user credentials to the iFrame widget in order to access your AARI automations.
This is the user that is assigned to a team.
The iFrame widget will refresh with a list of available automations.
- 4. Optional:** Fill your initial forms using URL parameters.
You can modify your URL with specific query parameters, to provide more control over your specific data.

Note: Embedded Automation supports these parameters: Check Box, Date, Dropdown, Number, Radio Button, Time, Text Area, and Text Box. For more details, see [URL parameters](#).

5. Run your automations or complete pending tasks.

You can deploy automations using the iFrame widget in the ServiceNow Service Portal.

Note: You can run your bots with the Picture-in-Picture feature. You can enable this feature when you configured your bot in AARI to run in a virtual window. See [Configure an AARI bot](#).

The screenshot displays the ServiceNow Service Portal interface. At the top, there are two main sections: 'Request Something' (Browse the catalog for services and items you need) and 'Knowledge Base' (Browse and search for articles, rate or submit feedback). Below these, the 'Current Status' section shows 'No system is reporting an issue' with a 'More information...' link. The 'Announcements' section shows 'Employee Center is available to you'. The 'My Assessments and Surveys' section shows 'No assessments or surveys for you at the moment'.

The 'Virtual Machine Request' form is highlighted with a red border and contains the following fields:

- Virtual Machine Request**
 - Create new request**
 - VM Details:**
 - Provider: Azure
 - vCPU: 8
 - Memory: 8GB
 - Hard Disk: 200GB
 - Operating System: Windows Server 2019
 - Expiration: 15 Days
 - Business Reason:**
 - [Empty text area]

At the bottom right of the form, there are 'Cancel' and 'Submit' buttons.

Related reference

[URL parameters](#)

This topic is to help you reference the URL parameters for supported elements.

Smart embedded forms and dynamic data mapping

As a developer, you can design smart forms to embed in a widget of a host web application where you can run a script to populate data dynamically.

This enhanced form builder experience enables you to quickly design smart forms with more concise controls. The smart forms are embedded as a widget (using iFrame widgets) in a web application where you can populate data dynamically and run your automations.

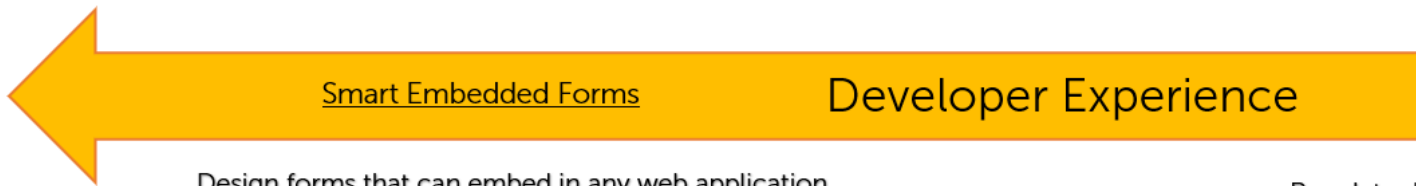
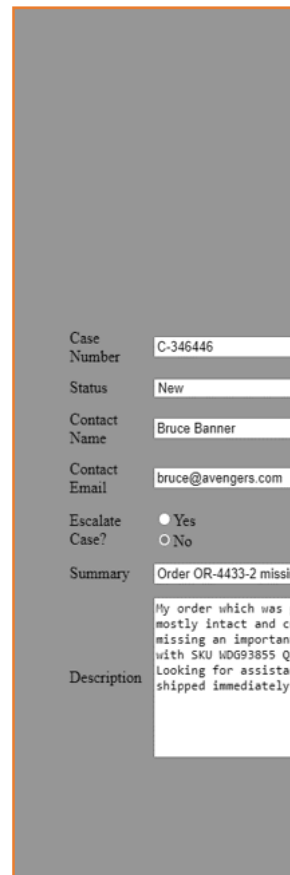
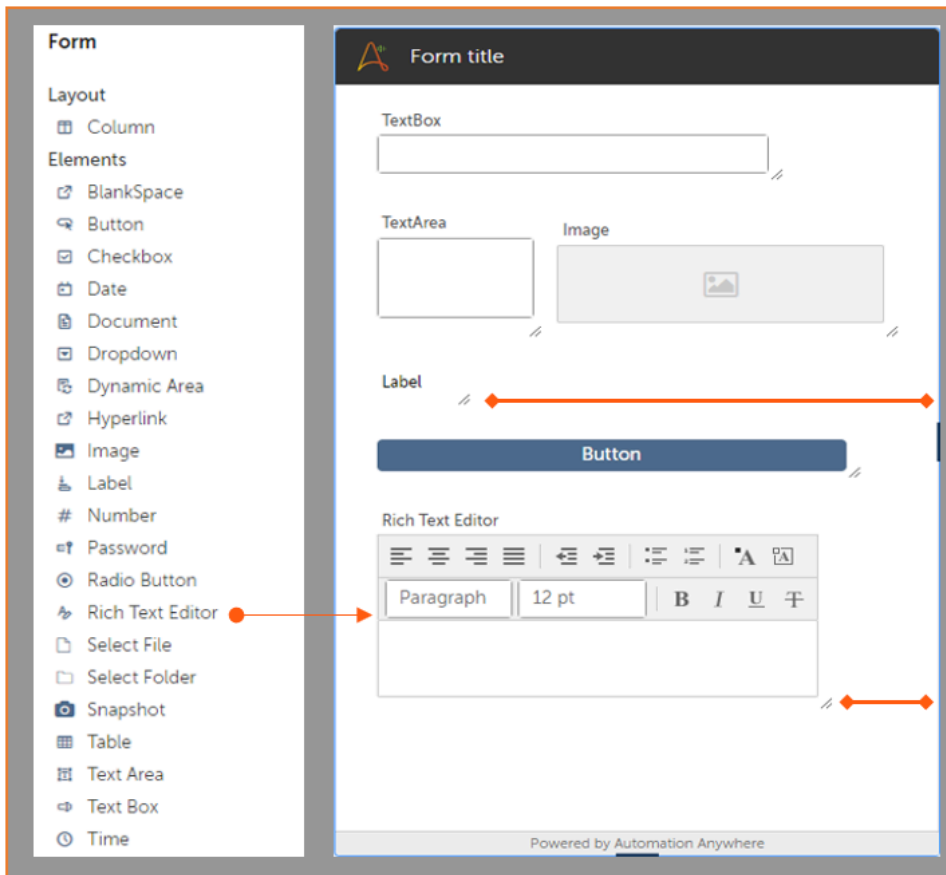

Design forms that can embed in any web application via an embedded widget

- Form canvas dynamically adjusts to fit form size
- Drag and drop elements directly into canvas
- Mouse draggable resizing of elements

Populate d... save time a...

- Script te...
- Host da...
- Data dy...
- Fast and...

What a developer can do

Design smart forms with the enhanced form builder:

- Drag form elements directly to the form builder to add new elements.
- Resize individual form elements to a precise length.
- Design forms to use in an embedded widget.

Populate data dynamically in an embedded widget:

- Utilize a Javascript for a host web application to read and use as inputs in AARI processes.
- Run a script (postMessage API JavaScript) to populate the data of the AARI process based on the process ID, element ID, and its value.

Benefits

Smart embedded forms provides the following benefits:

- Dragging and resizing form elements are a seamless and consistent experience.
- Developers can quickly add new elements to their forms.
- Forms created in the form builder is rendered the same way in an embedded widget.
- Form builder supports up to 25 form elements.
- Behaviors of the older forms are maintained.

Dynamic data mapping provides the following benefits:

- Data is populated dynamically to avoid repetitive data re-entry.
- Only specified data are dynamically populated, which provides a secure way to run automations.

Related concepts

[Embedded Automation](#)

Access automated processes and bots from any platform with an embedded interface. Embedded Automation delivers automation everywhere you want, either integrated with your web application or delivered through a browser extension.

[AARI Integrations overview](#)

You can use a widget that embeds automations built on the Automation 360 platform that can be applied natively on any supported web application.

Map host data to process

You can configure your widget settings from a host application and populate data in the initial form of your iFrame widget. This ensures that you have control over your data without the need for repetitive data entry.

Ensure you have completed the following:

- Provided a system-created **AAE_Robotic_Interface User** role for the AARI user.
- Have access to the AARI web interface.

- Have access to the host web application of your choice that supports the iFrame technology.
- You already set up the iFrame widget. For more details, see [Configure iFrame widget in a web application](#).

1. Log in to the host web application.

This is your target application with the iFrame widget.

2. Navigate to widget settings page or source code of your host web application (where you added the iFrame widget code).

This page contains the embedded code for your widget source.

3. Enter the host data and send data in the script.

Important: To map data, you must load a process on the host web application with a process ID, element ID, and values of the element ID which correlate with each another.

Example structure of host data:

```
hostData =
{
  process ID
  {
    elementID1: value1
    elementID2: value2
    elementID3: value3
  }
}
sendDataToEmbeddedApp = (processID) =>
{
  iframeElement = document.querySelector();
  iframeElement.contentWindow.postMessage({data: hostData[processID]},
    iframeElement.getAttribute());
}
```

```
}

```

Note: The element ID uses form element data types, such as: Check Box, Number, Radio Button, and Text Box.

An additional sample structure:

```
<script>
  const hostData = {
    '34': {
      'Number0': '70',
      'Number1': '71',
      'Number2': '72',
    },
    '30': {
      'TextBox0': 'Abhijeet',
      'TextBox1': 'Mukherjee',
      'TextBox2': 'Important One!!',
    },
  },

```

```
'45': {
  'CheckBoxGroup0': 'key:option1,key:CheckBox2',
  'CheckBoxGroup1': 'key:CheckBox1',
  'RadioButtonGroup0': 'Radio2',
  'TextArea0': 'Hello..',
  'Dropdown0': 'item3'
},
'38': {
  'Number0': '45',
  'RadioButtonGroup0': 'Radio',
  'CheckBoxGroup0': 'key:CheckBox'
},
'48': {
  'RadioButtonGroup0': 'Radio2',
}
}
const sendDataToEmbeddedApp = (processId) => {
  const iframeElement = document.querySelector('[name="aari-embedded-app"]');
  iframeElement.contentWindow.postMessage({data: hostData[processId]}, iframeElement.getAttribute('src'));
}

```

In this example: 45 is the process ID, Number0 is the element ID, and 45 is the value of the element ID.

4. Click **Save** or press **Ctrl + S** to save your session.

You have now configured the host data, and mapped the data to your processes.

5. Navigate to the iFrame widget.
The iFrame widget should show a list of automations.

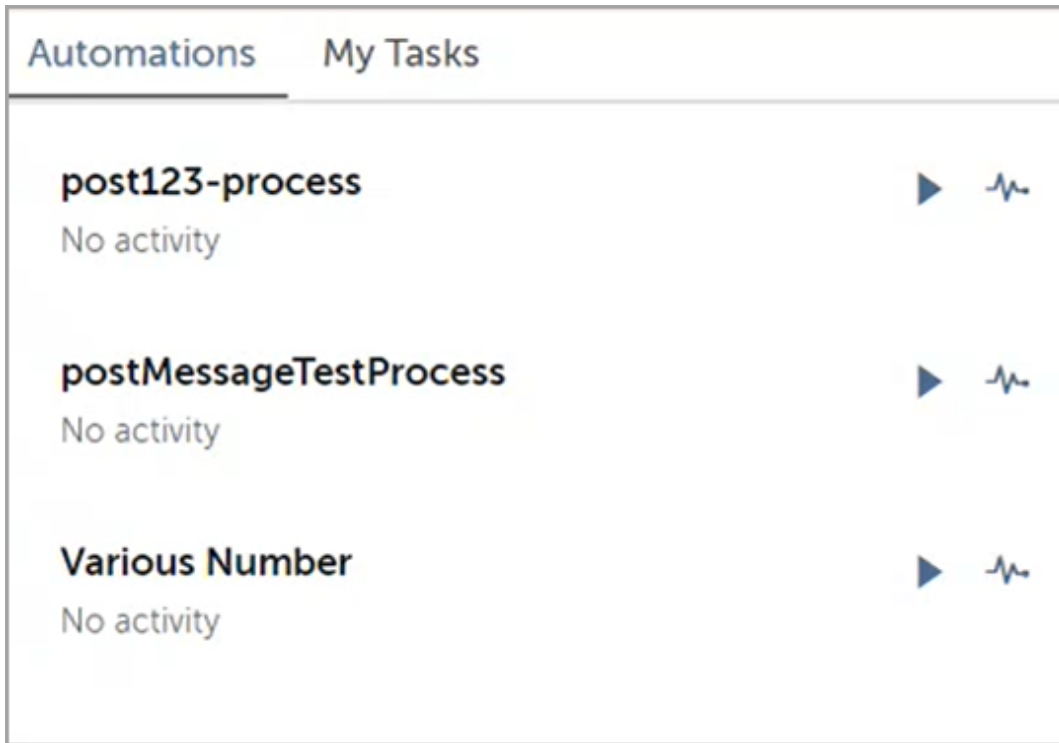

6. Click a process to open an initial form with data already mapped and filled in.

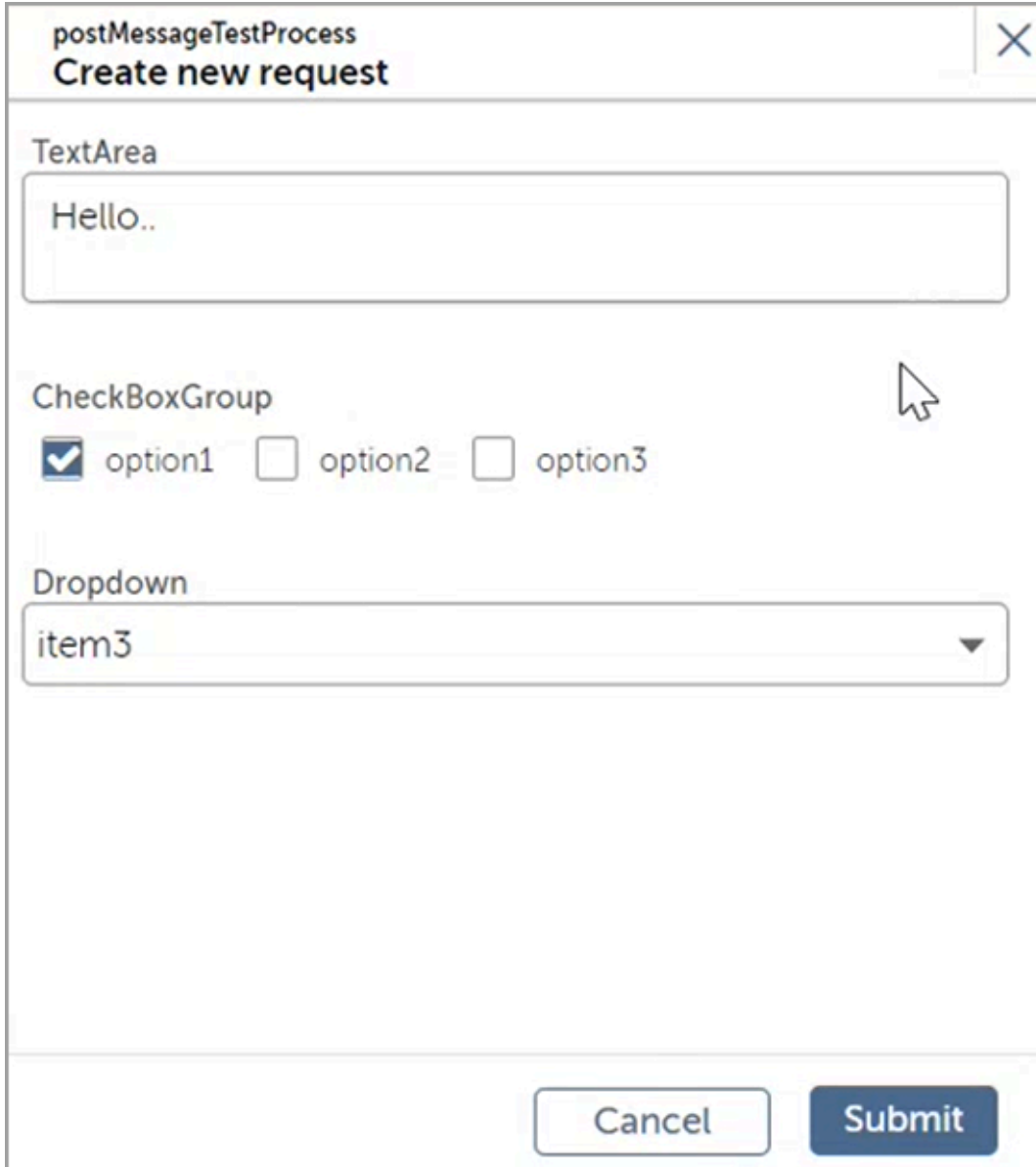

The screenshot shows a form window titled "postMessageTestProcess" with a subtitle "Create new request". The form contains the following elements:

- A "TextArea" field containing the text "Hello..".
- A "CheckBoxGroup" with three options: "option1" (checked), "option2" (unchecked), and "option3" (unchecked).
- A "Dropdown" menu currently displaying "item3".
- At the bottom, there are two buttons: "Cancel" and "Submit".

The initial form shows the mapped data.

7. Click **Submit** to run your automations.

AARI Extensions overview

Access automations in any web scenario with AARI Extensions, offering a custom widget through Google Chrome extensions.



Attention: The OAuth 2 configuration is required, and availability of this feature is based on your region.

Benefits and capabilities of AARI Extensions

Broader access to automations brought to your familiar environment

With AARI Extensions, you can develop custom actions and workflows. The OAuth 2.0 connection offers a seamless connection from the Automation Anywhere Control Room to your web browser. This connection extends automated features into your preferred environment through embedded web components. Develop these components in any web scenario through the use of AARI Extensions. Users with these components can launch automated processes and bots directly from existing environments, where most time is spent. With this access, business data can be retrieved and processed without ever changing applications.

Secure connection with admin control for organizing team and user workloads

AARI Extensions is fully integrated with Automation Anywhere for security and authorization of content. This means that the administrator has complete control over which content is made public through AARI by assigning AARI Extensions content to teams. Content assigned to a team will become visible to the members of the team when the target pages are opened. With this control and organization, administrators can develop specialized components for specific team functions by empowering users with streamlined automations.

Requisites:

- OAuth 2 Control Room configuration: Using secure credentials, configure a security token to validate your identity as a licensed user. Servers will recognize this token and approve your access, eliminating the need to log in multiple times to your accounts. [Use AuthConfig App to enable OAuth2 services](#)
- Automation 360 v.26 or later
- Chrome browser
- AARI licenses: AARI Extensions uses teams and members to securely authorize and deploy content to the right users.
- AARI fluency: Administrators should be familiar with the environment in order to identify key elements used to map custom content to teams.

Additional considerations:

- Roles: Ensure that you have the proper role and permissions for your activity. [AARI web interface users](#)
- Ensure that your browser is not blocking AARI Extensions access and windows.

Process flow

The end-to-end workflow is illustrated in the following diagram.

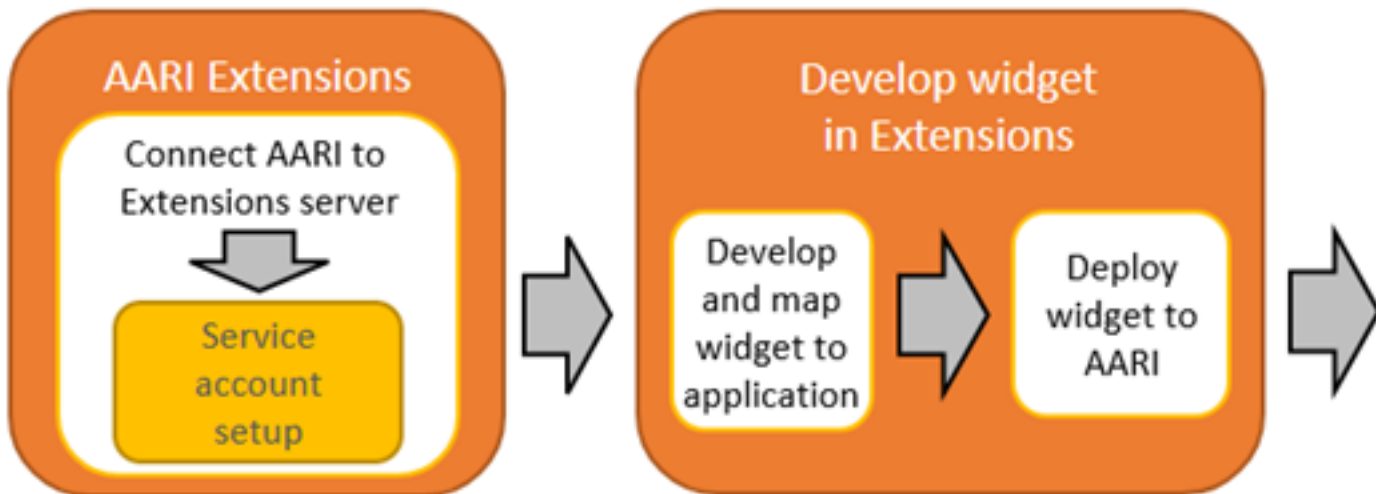

1. To begin accessing features, set up and connect your Control Room to AARI Extensions. [AARI Extensions setup and connection](#)
2. Develop and embed content in your preferred application for AARI Extensions. [Develop a widget for AARI Extensions](#)
3. Administer your developed content to teams for users to access through AARI Extensions. [Provisioning AARI Extensions to teams](#)
4. Get started using the embedded content through AARI Extensions. [Deploy automations in web application](#)

AARI Extensions setup and connection

Set up and connect AARI to AARI Extensions.

- Ensure that you meet all the prerequisites. [AARI Extensions overview](#)

- Have your Service Account Token accessible to enter in setup.

Note: This token is an API key generated in the Control Room, from **Settings**.

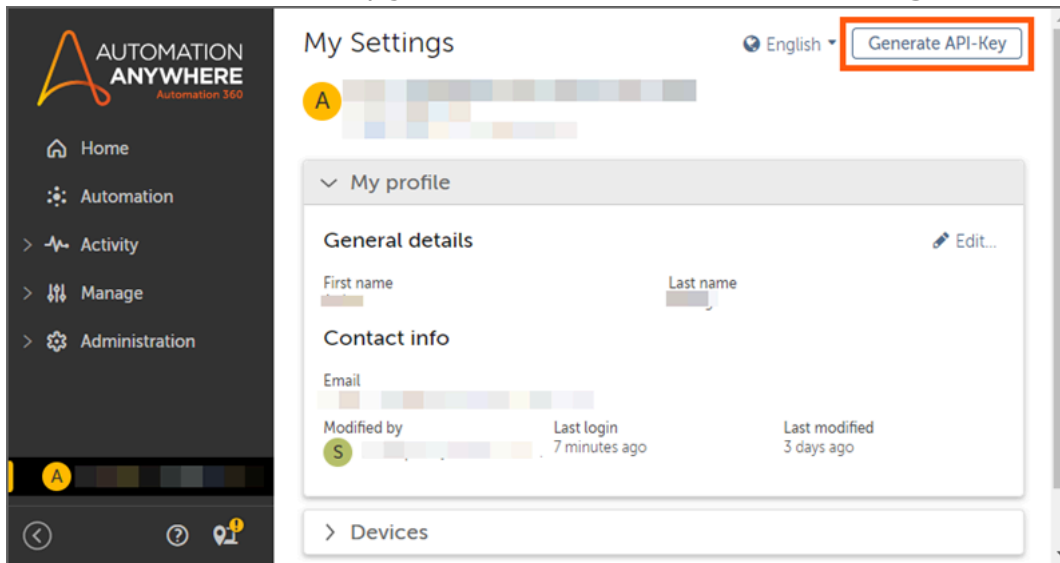

AARI Extensions requires setup and connection of your system. Perform the following steps to complete the setup illustrated in the following diagram.

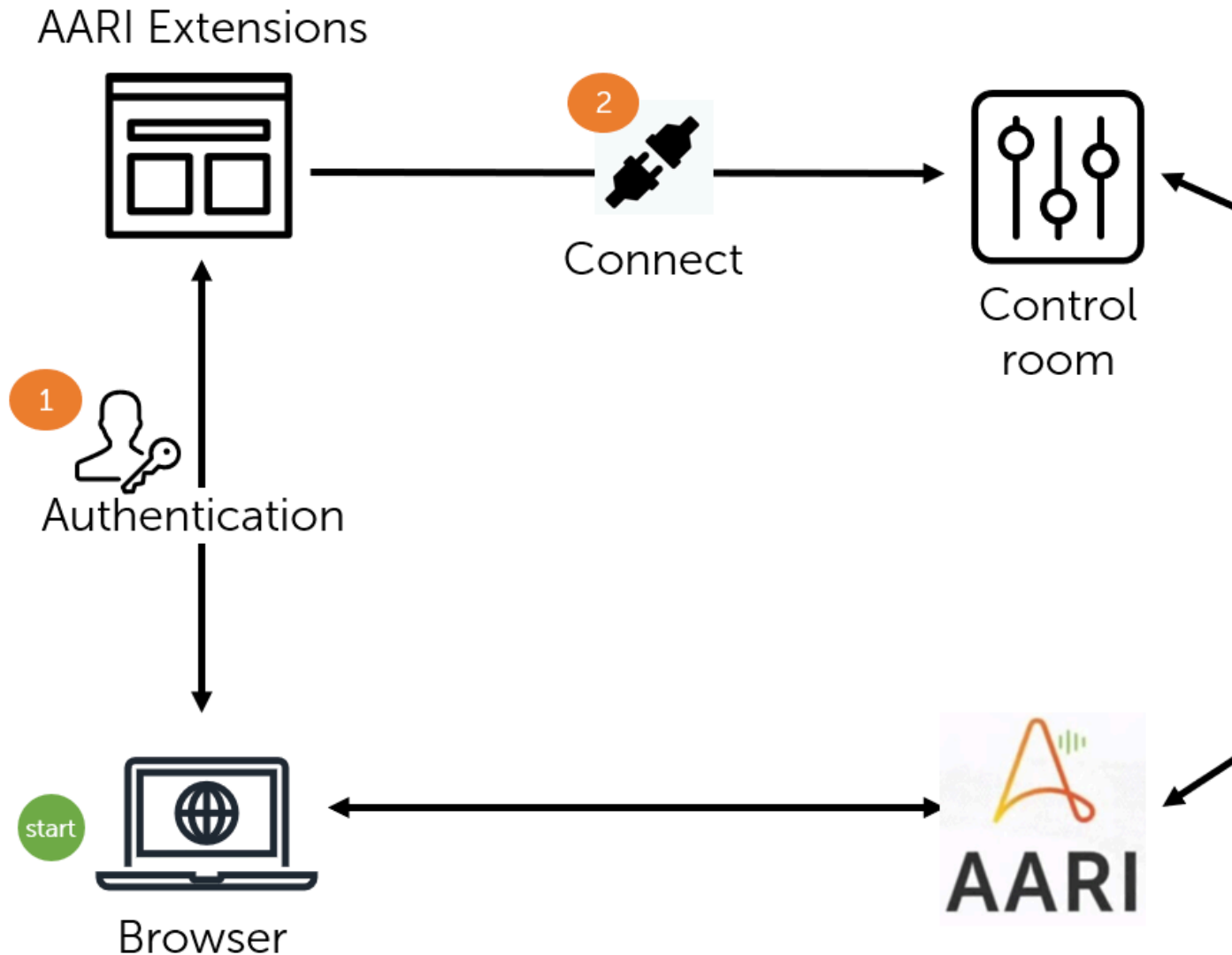

The following video shows the setup process. <https://aa2019packagesdkfordocumentation.s3.us-west-2.amazonaws.com/videos/embedded-extension-setup.mp4.mp4>

1. To open the Extensions setup in a new tab with context about the AAI tenant, in AARI, click **Connect Accounts**.

Note: Your Control Room URL and Partner ID will be automatically filled as part of the setup.

2. Select your Google or Microsoft account to begin the process of deploying and connecting AARI Extensions to your Control Room.
3. Enter a **Name** for the new AARI Extensions Tenant that will be connected to your Control Room, for example, Production.
4. In the Control Room settings:
 - a) Enter the Username of the Service Account that you created previously.
 - b) Enter the **Service Account API Key** to use for server-to-server communication.

5. Select **Connect**.

AARI is now connected to AARI Extensions, and you can assign developed content.

Develop a widget for AARI Extensions

Develop a widget for AARI Extensions

Develop the iFrame widget in AARI Extensions to deploy in your web application.

- You must be logged in to the Control Room with **AAE_Basic** permissions.
- Ensure that AARI Extensions is installed in your browser by completing setup. [AARI Extensions setup and connection](#)
- Set up the widget in AARI that will map automations into AARI Extensions. [Setup iFrame widget using AARI Integrations](#)
- Have the widget **embed code** accessible to enter into AARI Extensions. You need only the URL in quotes after `src=`.

The screenshot shows the AARI Control Room interface. On the left is a dark sidebar with a navigation menu. The 'Integrations' option is highlighted with an orange box. The main content area has a 'General' tab and a 'Widgets' tab, with 'Widgets' also highlighted in orange. Below the tabs is a search bar and a list of widgets, including 'Sales and Billing Widget'. A modal dialog titled 'Embed code' is open in the foreground. It contains the following fields:

- Widget name:** Sales and Billing Widget
- Widget width:** 100
- Widget height:** 100
- Embed code:** `<iframe src='http://url.com/aari'`

At the bottom of the dialog is a button labeled 'Email embed code'.

With AARI Extensions, your Chrome browser will act as the vessel to embed the widget. Using the following steps, develop an iFrame widget for your web application and deploy the widget to AARI to map

your complete embedded automation experience. While you can develop many web components, the following steps streamline a simple process to bring automations directly into your web application.

The PixieBrix Page Editor environment is used to map and configure automations from AARI to your web application and select the component for embedding the widget. This environment uses your OAuth connection to access saved processes and automations from your Control Room and map them to the selected component. For complete details on developing in the Editor, see the following link: [Guide to PixieBrix Page Editor](#)

The following video demonstrates the process of developing the widget in AARI Extensions. <https://aa2019packagesdkfordocumentation.s3.us-west-2.amazonaws.com/videos/embedded-extension-develop.mp4>

1. To begin, navigate to the web application where the iFrame widget will be embedded.
2. Select the **Render Panel** action and delete it by clicking the trash icon on the top of the pane.
3. To open the page editor, from the desired web application, right-click and select **Inspect**.

The following table and image details the development environment.

	Panel	Description
1	Extensions List	Create and select an extension for development.
2	Extension Overview	Add, view, and edit the components of the extension.
3	Configurations panel	Map and configure how components interact with the web page.

	Panel	Description
4	Data panel	Test and debug your extension.

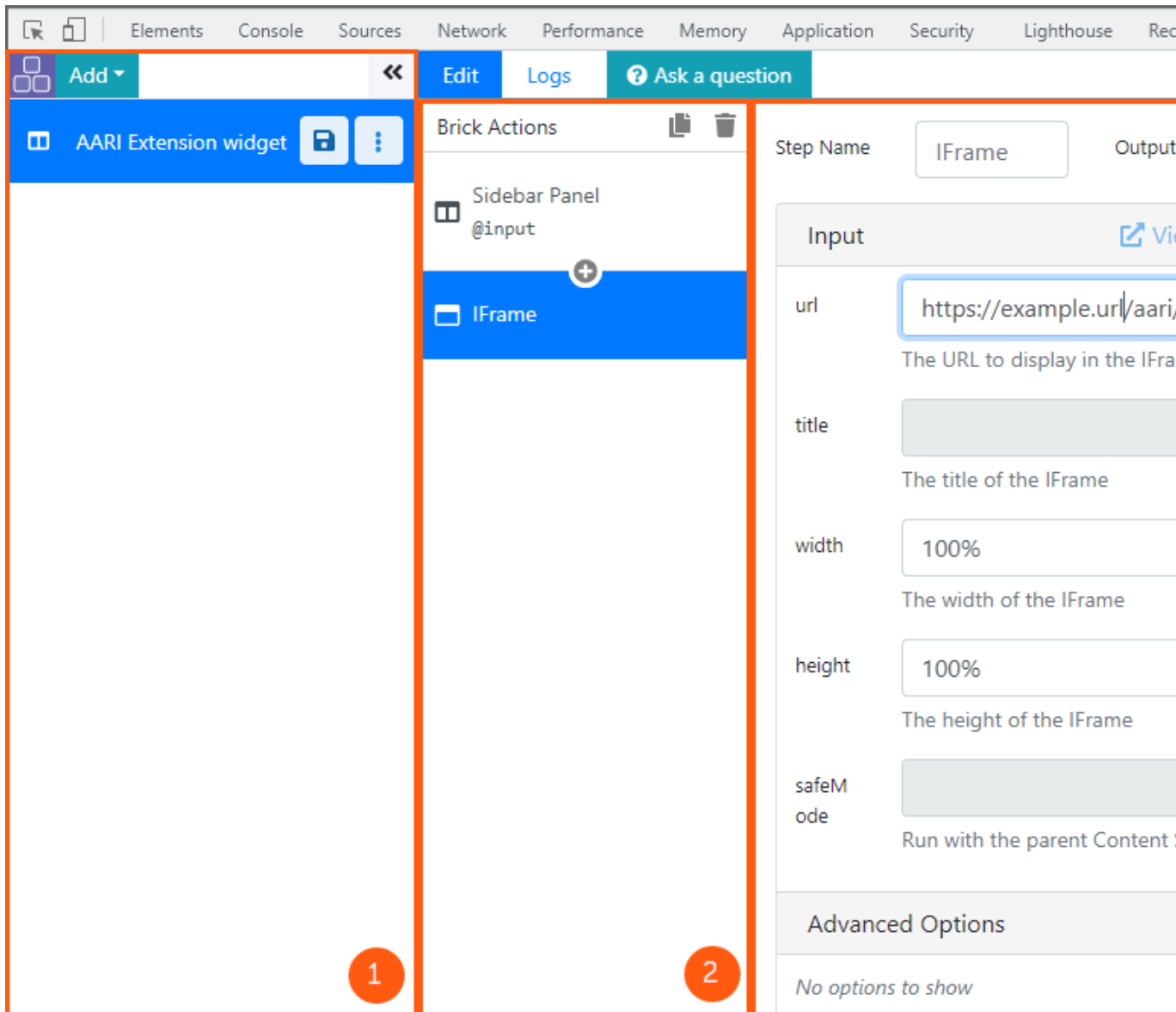

4. From Extensions List, click **Add** and select **Sidebar panel**.
5. From the Overview panel, click the **plus icon** to open the component menu.
6. Select the **iFrame** component and click **Add brick**.
7. In the Configuration panel, complete the necessary fields.
 - a) Enter the **Name** of the widget. This name will appear in AARI when you begin provisioning to users.
 - b) Enter the widget **URL** to access your Control Room.

This is the URL taken from the **embed code** found in AARI Integrations. You need only the URL in quotes after `src=`.

8. **Save** your Extension.

9. Test and debug your extension by using the data panel.

The final output is detailed in the data panel and alerts you to any action that might be mapped or configured incorrectly.



Trouble: If an alert for invalid connection or invalid credential appears, check that you have set up and connected AARI correctly to AARI Extensions.

10. After successful verification, click the vertical ellipses in the Extensions List panel to add your extension to a blueprint.

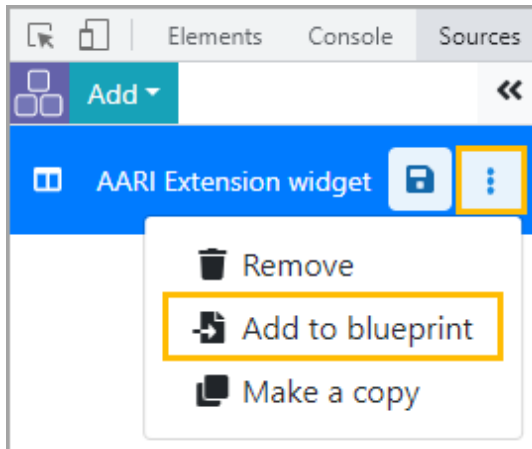

11. Select **create new blueprint**.

12. Select **move** or **copy** into the new blueprint.

13. Enter your **unique id**.

14. Enter the **name** to identify the extension in the next step.

15. Enter the **version** for developers to identify the progressive customizations made over the life of the extension.

16. Enter a **description**.

17. Click **Create** to save your changes.

After developing the extensions for your team, deploy the blueprint to AARI Extensions. [Deploy blueprint to AARI Extensions](#)

Deploy blueprint to AARI Extensions

Select and deploy the version of a verified extension for Teams to access in AARI Extensions.

Select and deploy an extension version (called a blueprint) for teams to access in AARI Extensions. Blueprints package all customizations and return them to the web application as a single version. This provides developers access to make improvements on one version while users simultaneously run a verified version.

Use the management console in the AARI Chrome extension to deploy a blueprint and control the version of developed artifacts.

AARI Chrome extension offers a management console for development artifacts to provide version control. Select the version of an extension by choosing a blueprint from the console. Blueprints package all customizations and return them to the web application as a single version. This allows developers access to make improvements, while users run a verified version.

This task describes how to deploy a blueprint from the AARI Extensions management console to populate your widget and make it accessible.

Prerequisites

- Use a Google Chrome browser with a profile setup with AARI Extensions.
- Ensure you have access to two AARI users, one with the AARI admin profile for set up and one with the AARI user profile for testing.

1. You can either:

- Open a new browser window on your machine and log in to AARI Extensions as an AARI Administrator user; or
- Open a new browser window on a different machine to easier manage active sessions.

Tip: Use Chrome Profiles to manage multiple user profiles on the same machine. For each user profile created, the user must log into AARI and install the Chrome extension into that Chrome profile. Then, each user must log in to the Chrome extension using their respective AARI credentials. This management method:

- Organizes profiles for Administrator, Developer, and end users for testing.
- Optimizes managing multiple sessions when tasks are completed on the same device.

To learn more about Chrome Profiles, see [Google Chrome help](#)

2. Open the Console page by selecting **Chrome > Extensions > PixieBrix**.

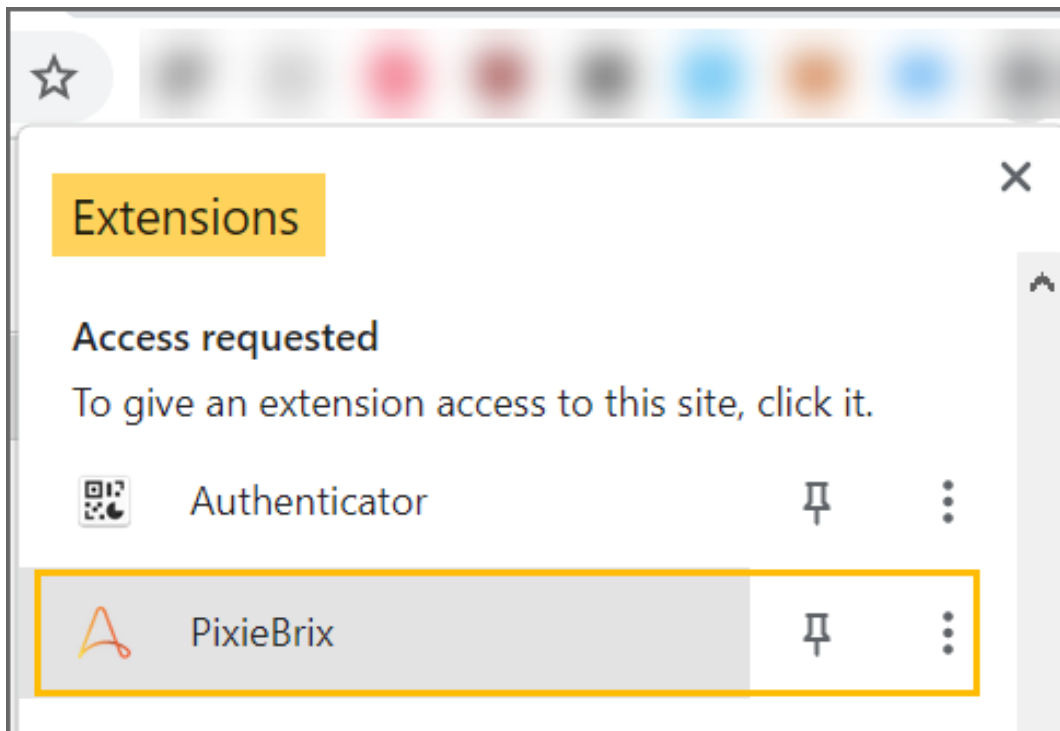

3. Click the **Options** button in the slide out panel that appears.

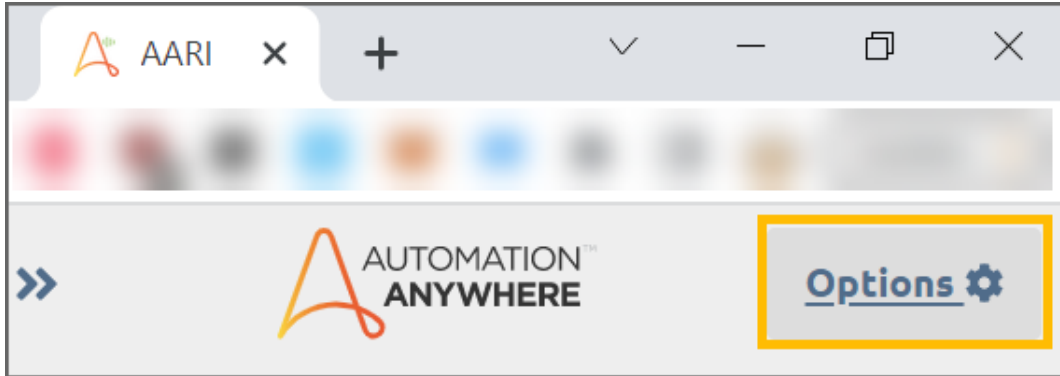

4. If prompted to log in enter your Control Room URL and log in using the AARI Administrator user account.

Note: To switch to a different user in the existing session, click **Open Admin Console** at the top right of the page. In the new tab, click the **username** and select **Logout**.

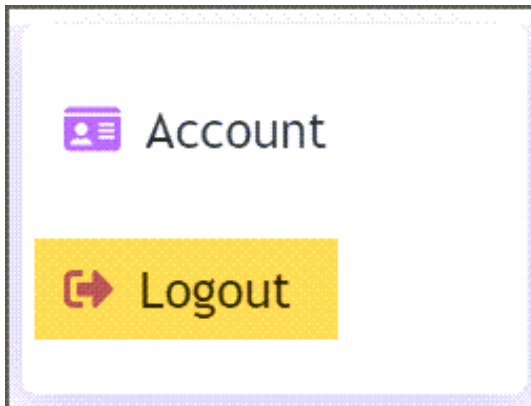

5. When logged in as the AARI Administrator user, click **Open Admin Console** at the top right of the page.

6. Select **Deployments** from the left navigation menu.

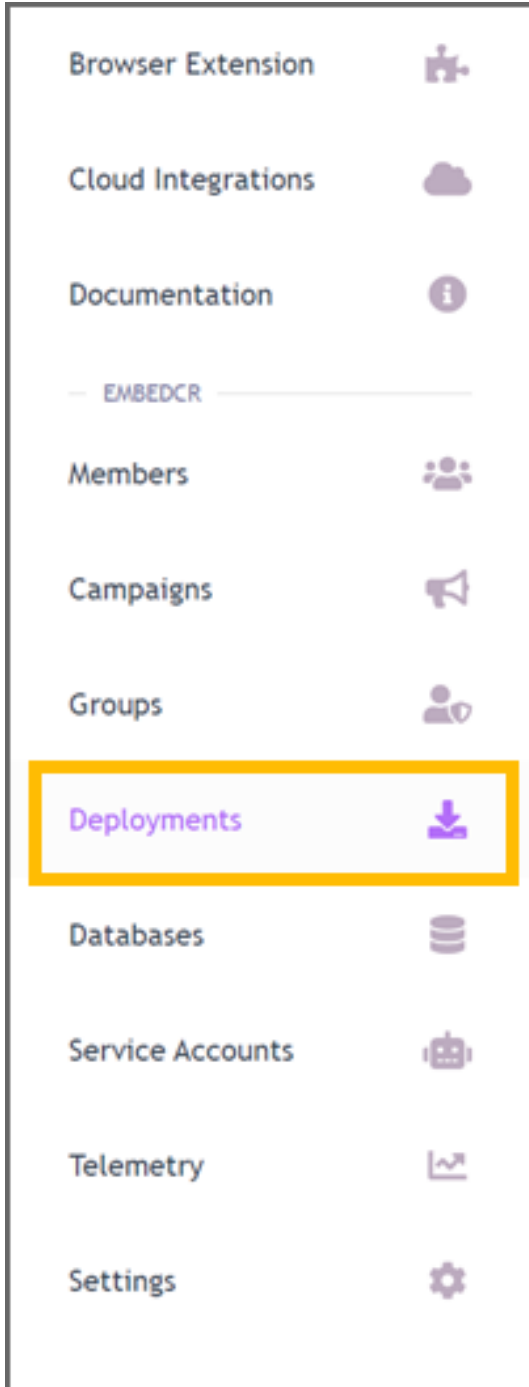

7. Click **+ Create Deployment** at the top right of the Deployments page.
8. Enter the name of your deployment.

9. Select the blueprint of the extension you previously created using the **Develop an widget for AARI Extensions** procedure. *Develop a widget for AARI Extensions*

Create Deployment

Name

Blueprint

Blueprint Version

- @embedcr/automations-sidebar - 1.0.0
- @embedcr/demo_workday_sidebar - 1.0.0**
- @embedcr/my-ondemandcom-trigger - 3.0.0
- @embedcr/my-ondemandcom-trigger - 2.0.0
- @embedcr/my-ondemandcom-trigger - 1.0.0
- @embedcr/ptab-sap-trigger - 1.0.0
- @embedcr/workday-hr-automation - 1.0.0

Integration

Blueprint has n

Configure Blueprint

Blueprint has no options to configure

[Cancel](#) [Create Deployment](#)

10. Click **Create Deployment** to save your settings to AARI.
11. In a new tab or window, navigate to Automation Anywhere AARI and log in as an AARI Administrator user.
12. Open the Extensions page by selecting **Manage > Extensions** from the left-hand navigation menu.
13. Click **+ Add Extension** on the top right of the page.



Your newly deployed extension displays in the table.

14. Select the check box next to your deployed extension and then click **Add & Save**.

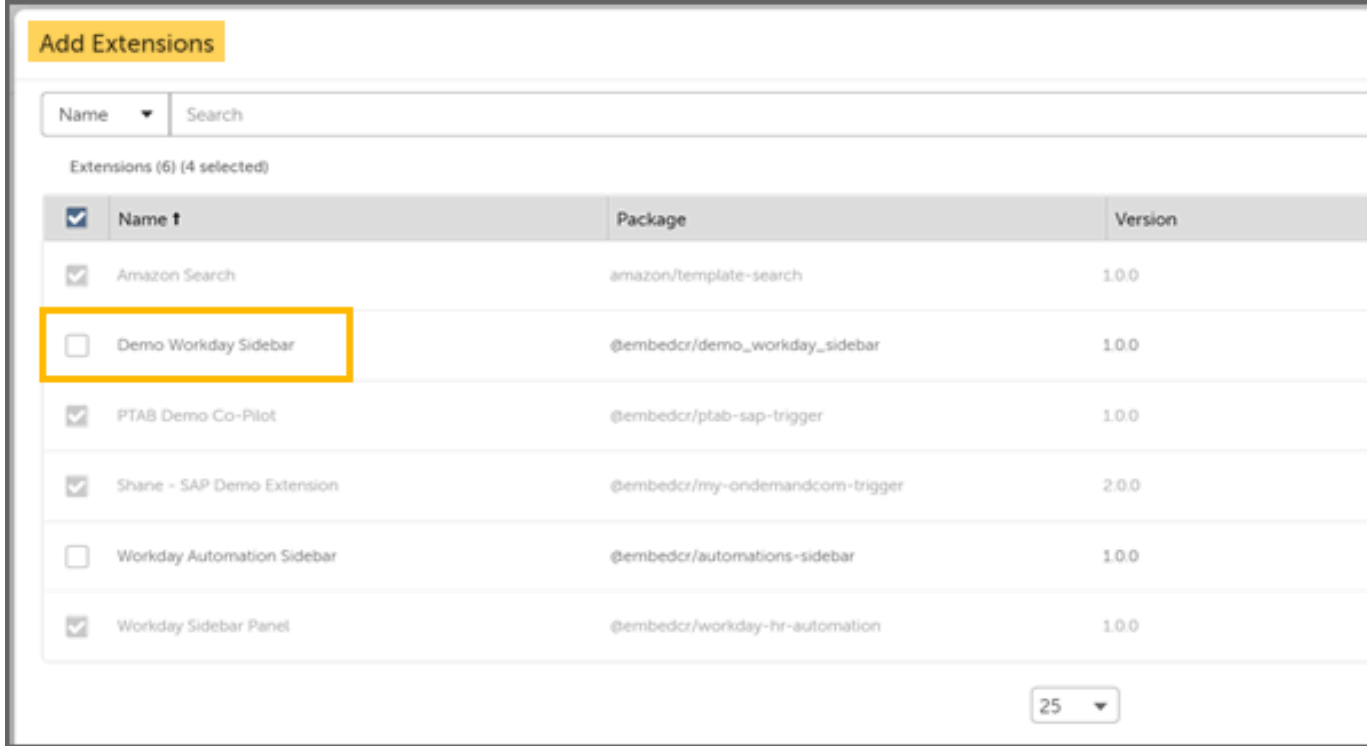

You return to the Extension Setup page.

15. From the Extension Setup page, select the deployment you added.

AARI navigates to the Properties page.

16. To assign one or more teams, select the **Teams** tab at the top of the page.

17. Click the + button on the bottom right to open the Teams dialog.

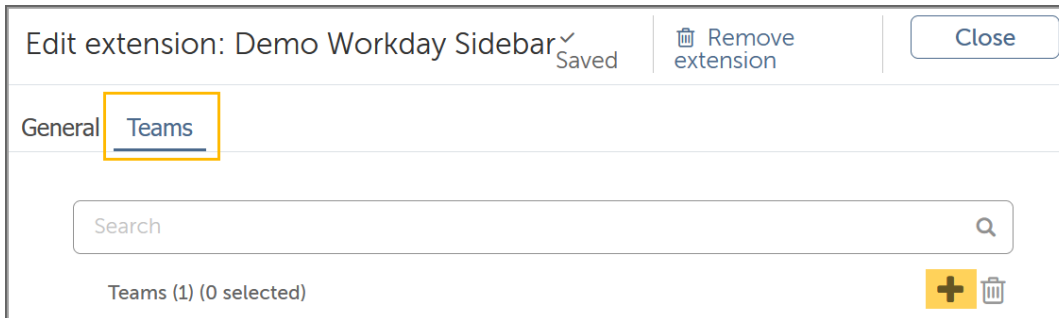

18. Select the Teams for which to assign the extension.



19. Click **Add & Save** to activate and deploy an AARI Teams customization.

Test the customization.

Note: If using Chrome Profiles, switch to a user profile dedicated to an AARI user profile that belongs to this respective Team. Otherwise, follow the steps to log the user out of the Chrome extension and then log in with a user that already has an AARI user license assigned and has been added to this respective Team.

As the user, navigate to your configured application, (similar to how Workday was configured in the previous task). After you access the page configured on the Trigger, the Sidebar panel should automatically display with the list of available automations for the user.

Provisioning AARI Extensions to teams

Organize and assign developed extensions to teams for business roles and functions.

Ensure that you have completed development of the AARI Extensions content. [Develop a widget for AARI Extensions](#)

After developing an extension, make sure to **refresh** AARI to load recently developed content.

- 1.** In AARI Extensions, click **Add Extension**.
- 2.** Select the extension.
Recognize the extension by the **Name** you entered in development.
- 3.** Click **Add and Save**
- 4.** To edit properties, select the newly added extension on the **Extension Setup** page .
- 5.** Click the **Teams** tab.
- 6.** Select **Teams** to assign them the extension.
- 7.** To commit your changes, click **Add and Save**.
The ellipsis on the far right of each team offers an option to send the extension link to users.
Users will now be able to access the widget from their web applications.

Check out what users can do with the extension. [Deploy automations in web application](#)

Example of Embedded Automation using AARI Integrations

An Embedded Automation widget is invoked as an Interaction Widget inside Genesys Cloud. The agent uses the widget to correct a pricing error without leaving Genesys.

Embedded Automation

Business users can directly access authorized automation from within their favorite business applications, without having to open a new interface or learn a new app. Embedded Automation delivers automation everywhere you want, through a widget, either integrated with your web application or delivered through a browser extension. To make the widget accessible, create and configure the widget in your preferred application. Then populate the widget by assigning pre-built automations to teams in AARI. Those teams can access Embedded Automation to complete daily tasks.

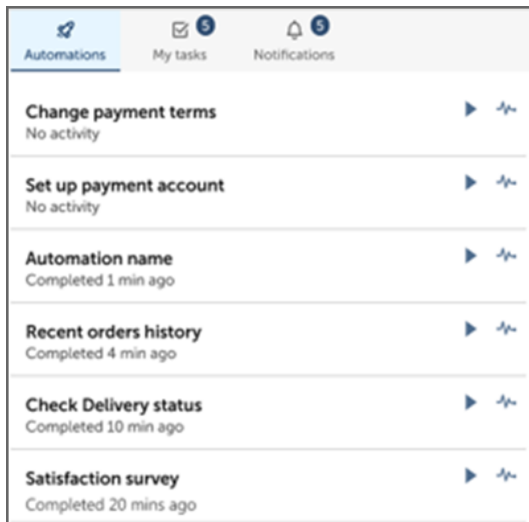

Setup

1. Complete the setup process flow [AARI Integrations overview](#)
2. Assign automations [Assign automations to teams](#)
3. Automations assigned should include the following.
 - Attended bot (that can be deployed on the local device) [Attended and unattended automation](#)
 - AARI Process invocation (with two human step forms) [Deploy processes](#)
 - Unattended bot (triggered via AARI process with no human inputs) [Create an AARI process](#)

Tip: Usable sample code

You can download the following sample code to test this example in your own environment. [GitHub: Embedded Use Case 1](#)

Example Summary

In this example, a contact center agent receives a call about an order with an incorrect charge. The agent, operating in Genesys, responds using the embedded widget by launching automated processes and bots, and handles the order correction without leaving Genesys. Deployed automations touch Salesforce and Zoho Sales Order Management to correct the error in respective systems. Assigned automations are detailed in the following image.

The screenshot displays a software interface with a top navigation bar containing 'Activity', 'Directory', 'Documents', 'Clients', 'Performance', 'Reports', 'Apps', and 'Admin'. On the left, a vertical sidebar includes icons for a profile, star, chat, clipboard, call, calendar, and automation. The main area is divided into three sections: a 'Conversations' list on the left, a call header at the top right, and an 'Interaction Details' panel on the right. The 'Conversations' list shows a call from 'Peterson, Mark' with the subject 'Blue Skies Airlines - Credits and Refunds'. The call header shows 'Peterson, Mark' with a duration of '53:51'. The 'Interaction Details' panel lists: 'Interaction Type: Call', 'Interaction State: Connected', 'Queue Name: Blue Skies Airlines - Credits and Refunds', and 'Customer's Number: tel:+1 [redacted]'. A partial 'Automation' panel is visible on the far right.

This example describes steps the agent takes to correct a pricing error while in Genesys, by using the Embedded Automation widget.

1. Deploy the **Salesforce Account Lookup** bot and enter the phone number to pull up the account record.

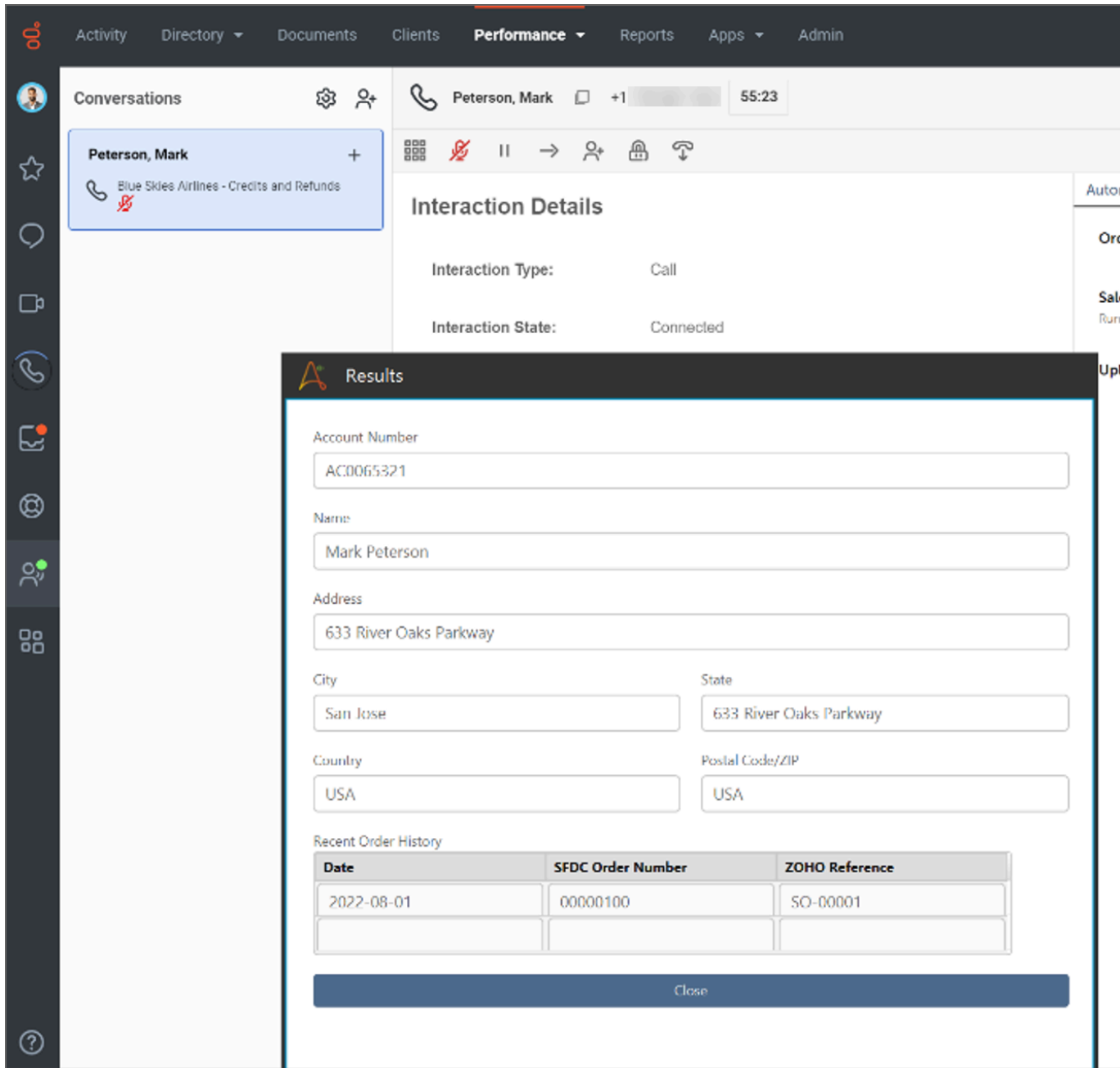

Copy the **SFDC Order Number** to enter in the next step.

2. Launch the **Order Items Price Correction** process from within the widget and enter the order number you have retrieved.
A Bot retrieves order details from Zoho and renders the **Display Order Details** in a form, including products and prices paid.

7-10 Order Number Input
Display Order Details

Widget User 2

Order Date
2022-08-02

Ship Date
2022-08-03

Sales Rep
Jill Brown

Sales Channel
Direct Sales

Shipping details:

First Name
Mark

Last Name
Peterson

Address 1
633 River Oaks Parkway

Address 2

City
San Jose

State
California

Country
U.S.A

Phone
555-985-4412

Email

Cancel Submit

Task Sequence

3. Correct the price on the item in question.

Shipping details:

First Name
Sam

Last Name
Roberts

Address 1
541 5th Avenue

Address 2

City
New York

State
New York

Country

Phone
555-321-0211

Email
samroberts@ew.com

Order details:

SKU	Name	Quantity	Price	Discount
GC1060	GenWatt Diesel 1000kW	1.0	100000.00	0.0
IN7020	Installation: Portable	1.0	3500.00	0.0

Optional Additional Discount (Compensatory)

Apply 3% discount on order

Cancel Submit

Task Sequence

4. Optionally, select the 3% discount for courtesy.
5. Click **Submit**.
The bot calculates the amount to be reimbursed.
6. The bot creates a billing update for refund in Zoho.
7. A reference number is generated, and the system indicates it will take 5-7 business days for refund to appear on card.

After the case is resolved, upload case notes from all cases handled through the day into a compliance application for audit.

	A	B
1	Case Number	Comment
2	00001002	Guided customer to refer to KB Article AB3434HH for directions on installation
3	00001016	Customer inquiring about maintenance guidelines, specifically what to maintain and at what interval. Guidance provided as per generator documentation.
4	00001024	Escalated issue to engineering as issue is mechanical and requires expert assistance from SME
5		

Enter the **file location**, for the automation to send notes to the appropriate contacts.

Example of Embedded Automation using AARI Extensions

An Embedded Automation widget is invoked as a sidebar that appears for users inside Workday. An HR admin uses the widget to enter an employee address and order business assets to be shipped without leaving Workday.

Embedded Automation

Business users can directly access authorized automation from within their favorite business applications, without having to open a new interface or learn a new app. Embedded Automation delivers automation everywhere you want, through a widget, either integrated with your web application or delivered through a browser extension. To make the widget accessible, create and configure the widget in your preferred application. Then assign pre-built automations in AARI that are necessary for teams to complete daily tasks. The widget populates assigned automations for specific roles.

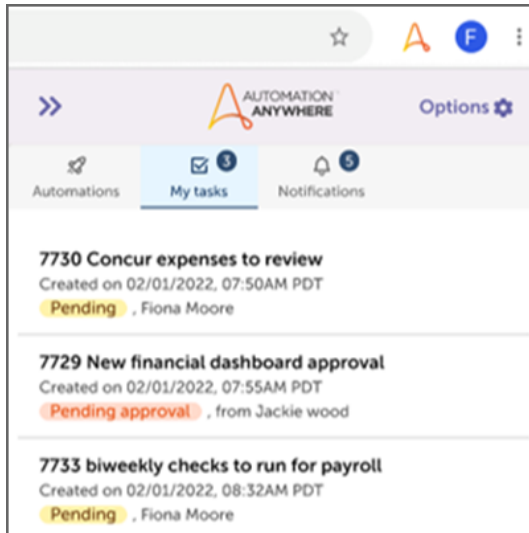

Setup

Embedded Automation is available through a widget in your desired web application. To activate the widget, you'll want to create and configure the widget through AARI Extensions. Then assign pre-built automations to teams for the widget to populate assigned automations for their assigned roles. Setup of task-specific automations are used in this example and are detailed in the following prerequisites.

1. Complete the following setup process flow.

- a. *AARI Extensions setup and connection*
- b. *Setup iFrame widget using AARI Integrations*
- c. *Develop a widget for AARI Extensions*

Note: For this example, configure the widget to trigger as a Page Load event.

- d. *Provisioning AARI Extensions to teams*

2. In this example, two types of automations are assigned and include the following details.

- Attended bot (that can be deployed on the local device) *Attended and unattended automation*
- AARI Process invocation (with two human step forms) *Deploy processes*

Tip: Usable sample code

You can download the following sample code to test this example in your own environment. [GitHub: Embedded Use Case 2](#)

Example Summary

This example begins when a HR Admin logs into Workday and upon landing on the home page, views the new Sidebar that has been deployed by the RPA Center of Excellence (CoE). The Sidebar has been designed to open automatically when the user accesses the Workday application and when the page has completed loading.

The Human Resource Admin begins by opening the Workday application. The Page Load event has been configured to generate the embedded sidebar. The following tasks demonstrate how a HR Admin uses Embedded Automation to access and update an employee address then order hardware assets for delivery.

The following details the automations used in this example. Deployed automations touch Workday and Zoho Sales Order Management to complete the transaction, while the admin remains in the Workday application.

- An attended bot, **Employee Work Address Update**, built for a HR Admin to quickly locate and update home office address details of employees, using interactive forms and local desktop automation.
- An AARI process invocation, **Device Order for Employee**, built for a HR Admin to order hardware assets for employees, like laptops and keyboards, directly from within the HRM application.

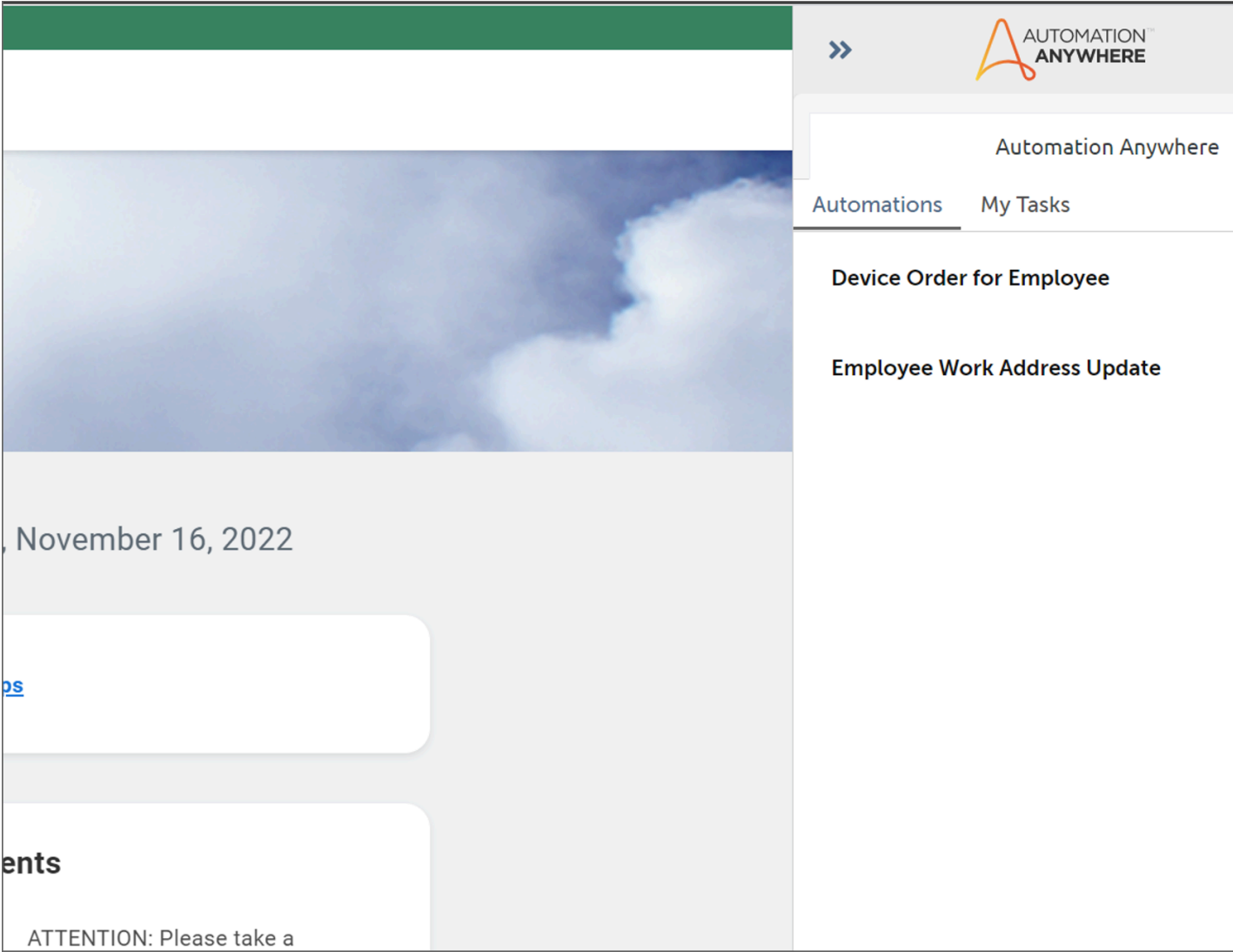

1. Start the **Employee Work Address Update** automation that allows you to enter the Employee ID of whom you want to update details.

Q Search

Let's Get Started

It's Wednesday, November 16, 2022

Timely Suggestions

Here's where you can find...

Search Employees

Employee ID

Search

Powered by Automation Anywhere

[View All Apps](#)

Recommended for You

Understand Your People Network

Based on your role

[View Org Chart](#)

Showcase Your Best Self with Your Profile

Based on your most popular actions

[Manage Profile](#)

Announcements

ATTENTION: Please take a moment to review your home page.

We're Glad You've Joined Team!

We are a company focused on ideas and innovation and we...



© 2022 Workday, Inc. All rights reserved. Workday Proprietary and Confidential. For authorized use only.
 System Status: Your Implementation tenant will be unavailable for a maximum of 12 hours during the next Weekly Service Update; starting on Friday, November 18, 2022 at 6:00 PM Pacific Time (Los Angeles) (GMT-8) through Saturday, November 19, 2022 at 6:00 AM Pacific Time (Los Angeles) (GMT-8).

2. Enter the **Employee ID** for the automation to search Workday for the employee details and return them within an interactive form.

Employee Details

Employee Data

Employee ID: 21507
User ID: tstaff

Person Data

Position: System Administrator
Hire Date: 2020-03-11

First Name: Tim
Last Name: Staff

Email Address: timstaff@getnada.com

Address: 545 Tremont Street

City: Boston
State/Province: MA

ZIP: 02116
Country: USA

Update Work Address

Position Data

Pay Type: Salaried

Management Level: 8_Individual_Contributor

Base Pay: 100000

Bonus Plan Amount: 0
Bonus Plan Percentage: 0

Total Compensation: 100000

Save Changes Cancel

Powered by Automation Anywhere

3. Enter address details of the employee through the provided form to update the employee record. This example includes a simple address update. However, you can update any other employee details based on the available APIs in your Workday instance or by using the Automation Anywhere Universal Recorder.

4. Click **Save Changes**.

Employee Details

Employee Data

Employee ID: 21507 User ID: tstaff

Person Data

Position: System Administrator Hire Date: 2020-03-11

First Name: Tim Last Name: Staff

Email Address: timstaff@getnada.com

Address: 715 SW MORRISON ST

City: PORTLAND State/Province: OR

ZIP: 97205 Country: USA

Position Data

Pay Type: Salaried

Management Level: 8_Individual_Contributor

Base Pay: 100000

Bonus Plan Amount: 0 Bonus Plan Percentage: 0

Total Compensation: 100000

Powered by Automation Anywhere

The automation updates details of the employee record in Workday.

The next automation simplifies daily tasks of the HR Admin by introducing an automated process for device ordering that is embedded directly in the Workday application using the same Sidebar. Typically, this task would require navigating procurement applications to locate and order devices, and navigating the Workday application to capture shipping address details of the employee.

The next section demonstrates how the task is simplified by bringing the ordering process into the primary application where daily tasks are performed. Like the previous task, when the user logs into Workday the Sidebar appears with the list of available automations their CoE has rolled out to the HR team.

5. Find the **New Device Order for Employee** automation displayed in the Sidebar, and click **Start**. A new instance is created.

6. Enter the **Employee ID** for a new order.

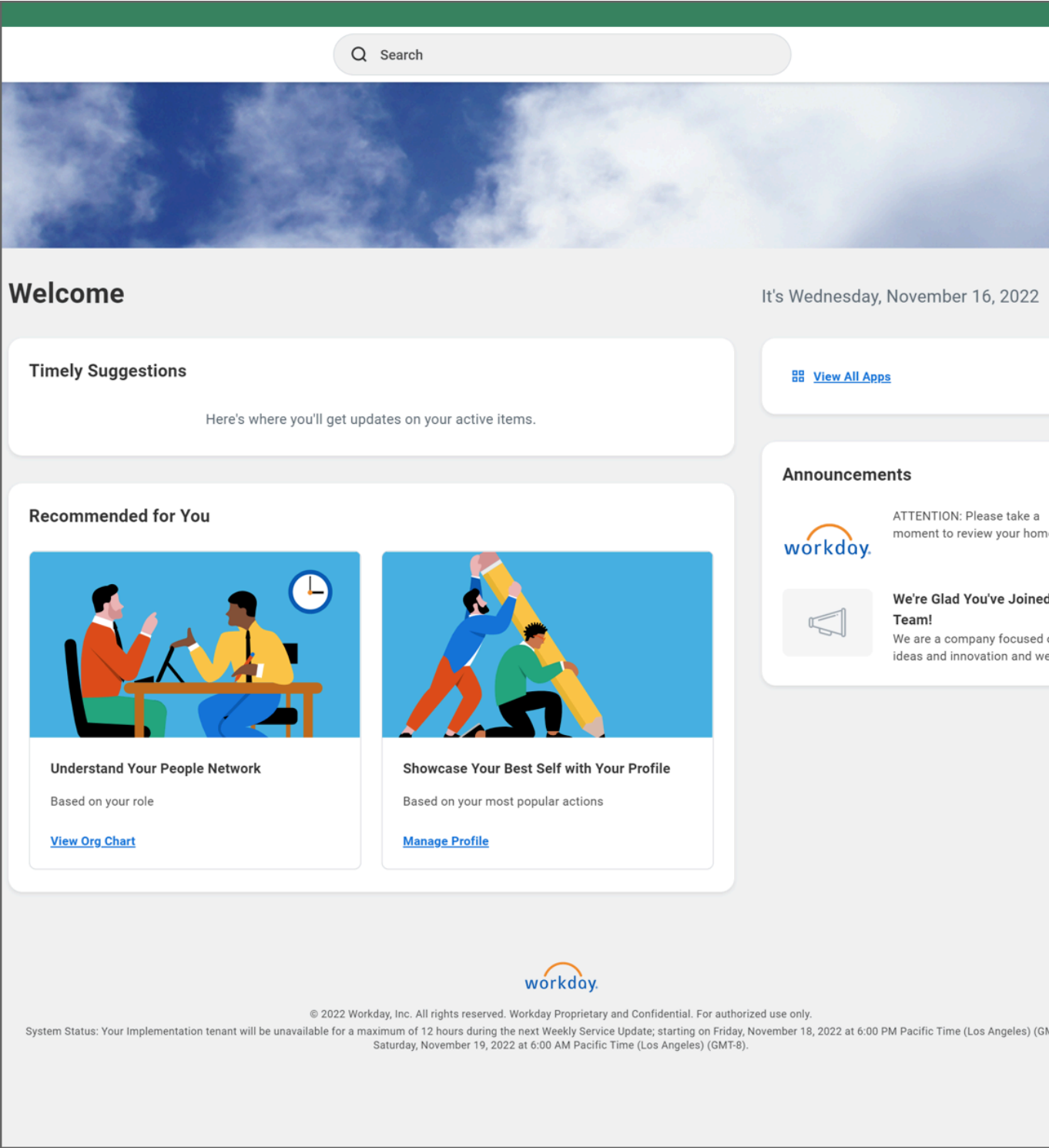

After submitting a valid Employee ID, the automation locates the details of the employee within Workday and returns those details into the next step.

7. Confirm the employee details and choose items to order on their behalf.

>> **AUTOMATION ANYWHERE** Options ⚙️

Automation Anywhere

53-25 Ship New Device ✕
Device Selection

Charlie Harrison ▾ ↗

Employee Data

Employee ID
21507

ZIP
97205

Available Assets to Order

Jabra Evolve 65 UC Headset

\$199.99

Quantity
0

Microsoft Ergonomic Desktop Keyboard

\$121.99

0

Microsoft Bluetooth® Ergonomic Mouse

\$69.99

0

Submit **Cancel**

Task Sequence

8. After the automation has created a new order in the company's order management system, in this case Zoho Order Management, the automation returns the **Sales Order number** for reference.

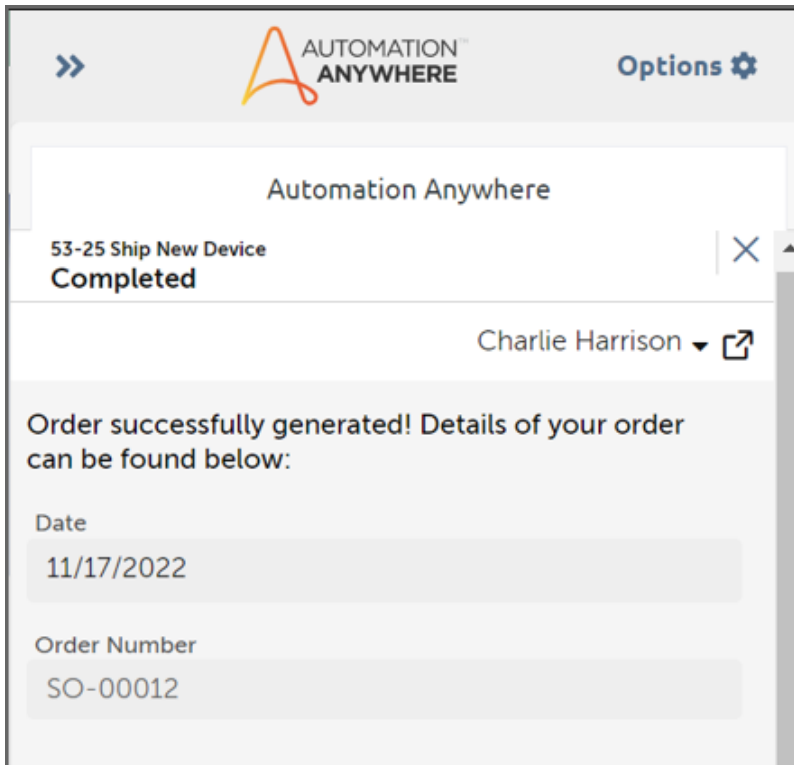

Example of Embedded Automation using AARI Extensions and AARI Integrations

An Embedded Automation widget is invoked as a widget inside ServiceNow and a sidebar inside SAP to resolve a collaborative task across cross-functional teams. An HR admin submits an order request and a manager approves the request.

Embedded Automation

Business users can directly access authorized automations from within their favorite business applications, without having to open a new interface or learn a new app. Embedded Automation delivers automation everywhere you want, through a widget, either integrated with your web application or delivered through a browser extension. To make the widget accessible, create and configure the widget in your preferred application. Then assign pre-built automations in AARI that are necessary for teams to complete daily tasks. The widget populates assigned automations for specific roles.

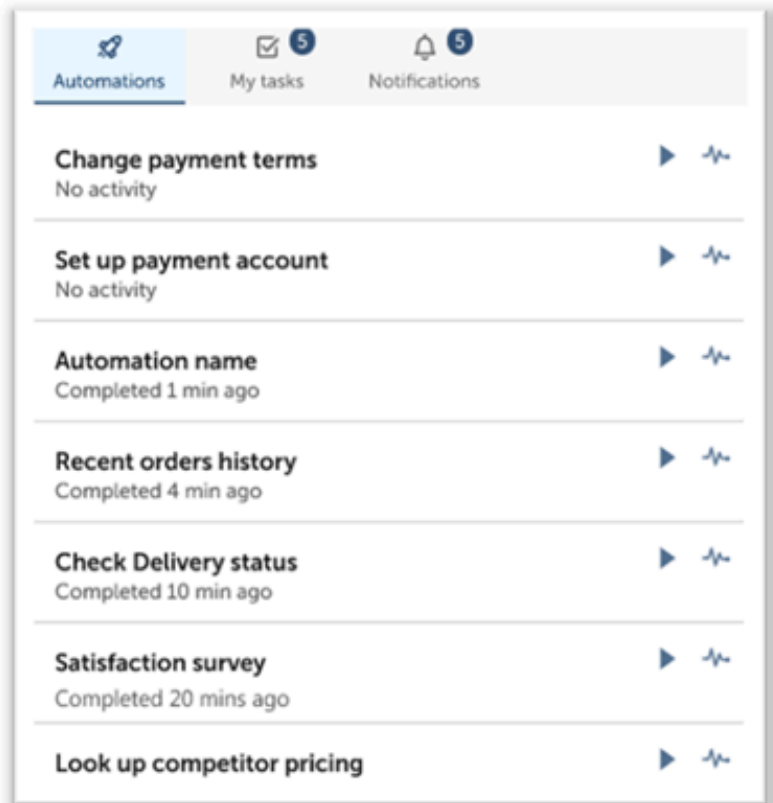

iFrame Widget
for web apps supporting
customization

Embed automation
in any web
application

Attended,
unattended and
process automations



Lightweight and
responsive
interface

Seamless
authentication with
OAuth 2.0 or SAML
SSO

Example Summary

In this example, a company employee (Jane) submits a request to order replacement hardware. Jane, operating in ServiceNow, uses the embedded widget to launch an automated bot to process the order and submit for approval to a Cost Center Manager (Gerald). Gerald, operating in SAP, uses the embedded widget to launch automations that approve and complete the hardware order for shipping.

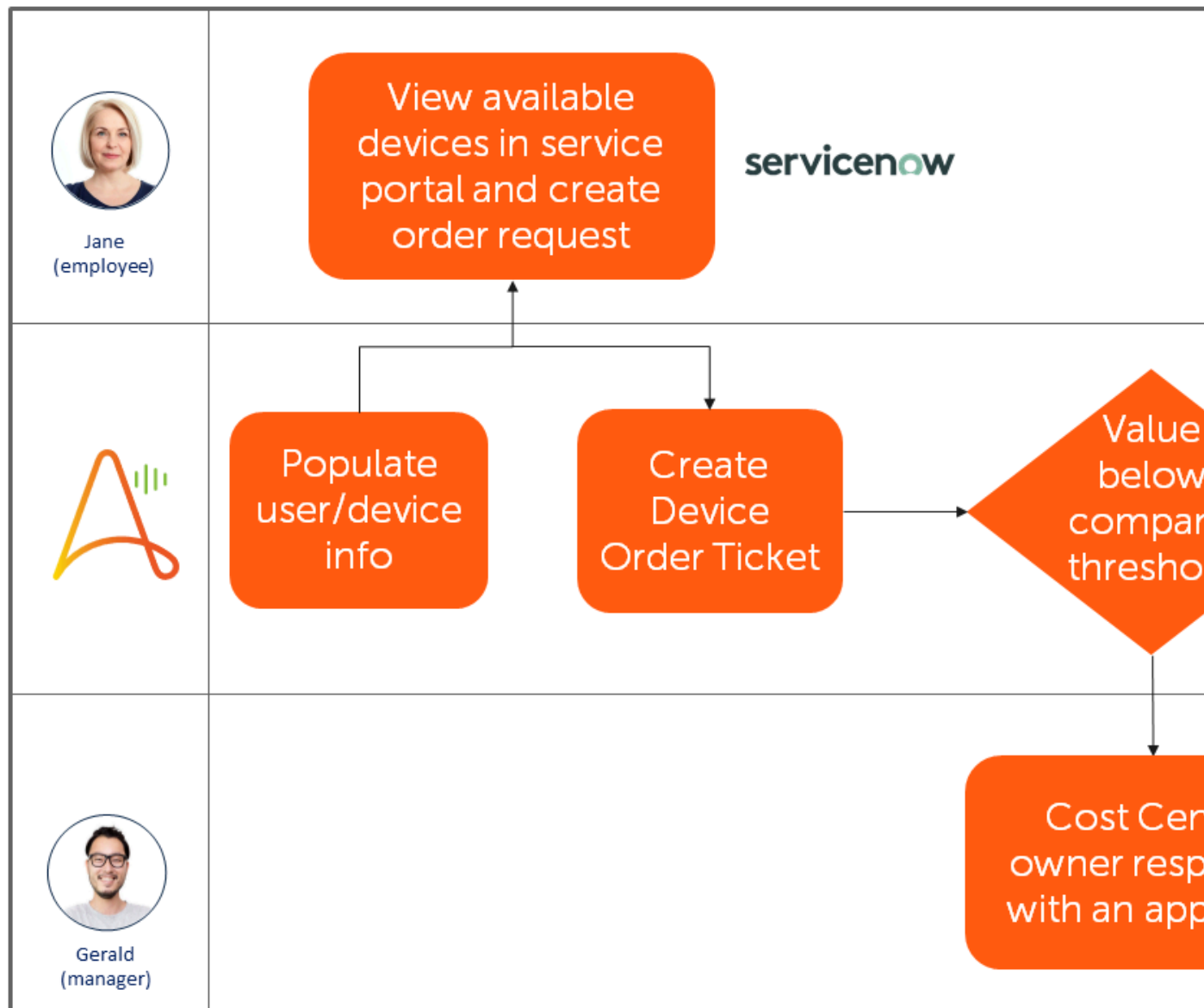
The widget is visible in ServiceNow as a custom ServiceNow component that is placed into the Employee Service Portal page. The widget is invoked as a Sidebar, through the web browser, that appears for users inside SAP S/4HANA on a page load trigger.



Setup

1. Complete the setup process flow for ServiceNow [AARI Integrations overview](#)
2. Complete the setup process flow for SAP [AARI Extensions overview](#)
3. Assign automations [Assign automations to teams](#)
4. The embedded widget can contain combinations of three types of automations:
 - AARI Process invocation (with two human step forms) [Deploy processes](#)
 - Attended bot (that can be deployed on the local device) [Attended and unattended automation](#)
 - Unattended bot (triggered via AARI process with no human inputs) [Create an AARI process](#)

Tip: Usable sample code

You can download the following sample code to test this example in your own environment. [GitHub: ServiceNow](#)

Procedure

For this particular example, we focus on just one of the above types of automations:

The **Hardware Replacement Request** AARI process allows an employee access to the business ServiceNow Service Portal for IT requests. An employee can use the embedded widget to automate requests. Jane's request entails ordering replacement hardware such as keyboards, mice or laptops.

When Jane opens ServiceNow they can see the automated process for **Hardware Replacement Request** within the widget.

The screenshot displays the ServiceNow Service Portal interface. At the top, the ServiceNow logo is visible on the left, and the text "How can we help?" is centered. Below this is a search bar with the placeholder text "How can we help?". The main navigation bar includes three primary sections: "Request Something" (Browse the catalog for services and items you need), "Knowledge Base" (Browse and search for articles, rate or submit feedback), and "Get Help" (Contact support problem). The main content area is divided into two columns. The left column features a "Current Status" section with a highlighted widget titled "Process Automation deployed on a remote device" (indicated by an orange box and arrow), and a "My Open Incidents" section listing several incidents such as "Purchase Request for Hardware: Jane Miller", "Employee payroll application server is down.", "Rain is leaking on main DNS Server", "JavaScript error on hiring page of corporate website", "Can't launch 64-bit Windows 7 virtual machine", and "Sales forecast spreadsheet is READ ONLY". The right column shows a "Hardware Replacement Request" widget under the "Automations" tab, with a "My Tasks" indicator.

1. Jane initiates the **Hardware Replacement Request** and is taken to an input page, within the widget, where required information is entered to execute the automation.

2. Here, Jane can select the request for self or another employee and **Submit**.



Request Something

Browse the catalog for services and items you need



Knowledge Base

Browse and search for articles, rate articles, and provide feedback

Current Status

No system is reporting an issue

[More information...](#)

My Open Incidents

Can't launch 64-bit Windows 7 virtual machine
INC0000019 • 8mo ago

Sales forecast spreadsheet is READ ONLY
INC0000018 • 8mo ago

Hardware Replacement Request

Create new request

Is this request for yourself or for another employee?

Myself

Another Employee

Employee Name

- 3. After selecting an option, the next automation connects Jane to the business HR system where Jane collects employee details such as shipping address. The system connects to the procurement system to fetch available items to be ordered.

Note: For demo purposes, this example includes these steps in the automation to reduce reliance on additional systems.

12-46 Employee Hardware Request
Display Order Form

State/Province
Lancaster

Country
Ohio

ZIP/Postal Code
43130

Hardware Options

Product	Price	Quantity
Microsoft Bluetooth Ergonomic Mouse	69.99	0 ▼
Microsoft Arc Mouse (Black)	118.99	0 ▼

Submit **Cancel**

- 4.** The following business rules were created in this specific automation to check the overall value of the order:

If the total order value exceeds the company threshold of \$3000, then an approval is required from the cost center owner. This generates a request to that individual, Gerald.

- 5.** Gerald focuses on completely different tasks in the cost management application (SAP). So you can see the list of automations in the sidebar are focused on orders, inventory, and other sales related

processes. When Jane's request for Gerald is generated, a toast message appears in the inbox for the new Task within the widget.

OverviewPayable&/?sap-iapp-state=ASD466DKUTRBGEKTAJBME8V1I32HVBESRIRIM762

Accounting Clerk: Country / Region Key: Recon. Account:

Discount Utilization
- Last 6 Months | USD
7.25 K Target 466K Deviation -47%

Days Payable Outstanding Indirect
DPO Average - Last 12 Months
53.3 In Days



Quick Links
Manage Supplier Line Items
Manage Payment Blocks
Display Supplier Balances
Approve Bank Payments
My Inbox

Due Invoices Free for Payment
Total | USD
138.67 M
As of Today

Posted Invoice Period
Total | USD
147.5
This Period

The screenshot displays a SAP Payables dashboard with several key components: 1. Header: A URL bar at the top and three input fields for 'Accounting Clerk', 'Country / Region Key', and 'Recon. Account'. 2. Metrics: 'Discount Utilization' (7.25 K, -47% deviation) and 'Days Payable Outstanding Indirect' (53.3 days). 3. Charts: 'Payment Discount by Month' (stacked bar chart) and 'DPO by Month' (line chart). 4. Quick Links: A list of actions like 'Manage Supplier Line Items' and 'Approve Bank Payments'. 5. Summary Cards: 'Due Invoices Free for Payment' (138.67 M) and 'Posted Invoice Period' (147.5). 6. Navigation: A 'My Tasks' button is highlighted in the bottom right area.

Gerald clicks in **My Tasks** to view the request and continue with the AARI approval process.

>>  **AUTOMATION ANYWHERE** Options 

Automation Anywhere

Automations **My Tasks 3**

Request Approval
Created on 10/26/2022 14:28
Pending

Request Approval
Created on 10/31/2022 07:49
Pending

Request Approval
Created on 11/17/2022 16:09
Pending

6. Gerald approves the request and adds any comments without having to leave the SAP environment.

The screenshot displays the Automation Anywhere interface for a request approval. At the top, there is a navigation bar with a double arrow icon, the Automation Anywhere logo, and an 'Options' menu with a gear icon. Below this is a header section with the title 'Automation Anywhere' and a sub-header '38-29 Request Approval Approval' with a close button. The user 'Gerald Brown' is shown with a dropdown arrow and an external link icon. The main content area is titled 'Request Details' and contains several fields: 'Date' (2022-11-17T00:00-08:00[America/Los_Angeles]), 'Employee First Name' (Jane), 'Employee Last Name' (Miller), 'Devices Requested:' (Qty 1 of Apple MacBook - Intel Core i9 - 64GB Memory - 8TB SSD @ \$4799), 'Total Value' (\$4799), and 'Requestor Comments' (Require new laptop as old one no longer charges). At the bottom, the 'Approval Decision' section is highlighted with a yellow box, featuring two radio buttons: 'Approve' and 'Deny'. Below this is the 'Approver Comments' field.

7. Jane is able to see the details of each step in the overall process and the status in the workspace widget. She can see that all have been completed successfully and an IT ticket has been created and closed on her behalf to track the request.

Current Status	Task Sequence
<p>No system is reporting an issue</p> <p>More information...</p>	<p>✓ Run Business Rules Nov 17, 2022 16:18 Completed BOT</p>
	<p>✓ Create ServiceNow Ticket Nov 17, 2022 16:19 Completed BOT</p>
	<p>✓ Cost Center Approval Needed Nov 17, 2022 16:19 Completed</p>
	<p>✓ Procurement: Create Order Nov 17, 2022 16:19 Completed BOT</p>
	<p>✓ Update Order Details: Close Ticket in ServiceNow Nov 17, 2022 16:19 Completed BOT</p>
	<p>✓ Request closed Nov 17, 2022 16:19 Completed Jane Miller</p>

My Open Incidents
Purchase Request for Hardware: Jane Miller INC0010062 • just now
Purchase Request for Hardware: Jane Miller INC0010061 • 2m ago
Purchase Request for Hardware: Jane Miller INC0010060 • 10m ago
Purchase Request for Hardware: Jane Miller INC0010058 • 18d ago
Employee payroll application server is down. INC0007001 • 8mo ago
Rain is leaking on main DNS Server INC0000016 • 8mo ago

Process discovery by using Discovery Bot

You can use Discovery Bot to identify the processes in your business that can be automated. Discovery Bot identifies such processes by recording and analyzing user interactions with various systems for processes, comparing the potential ROI from automating these processes, and creating bots to automate the processes.

What is process discovery

Process discovery is the first step in automation, in which the processes that can be automated in a business are identified. Process discovery is a method used to uncover business processes by recording user interactions with various systems and analyzing the recorded interactions to identify patterns. User interactions with any of the following types of systems can be recorded and analyzed:

- Enterprise solutions, such as ERP, CRM, business process management (BPM), and ECM
- Personal productivity applications, such as Microsoft Excel and Outlook
- Terminal and virtual environments, such as Citrix XenApp and Remote Desktop

Why use Discovery Bot

Many companies begin their automation projects with manual process discovery and documentation. Manual review of process documentation requires interviewing business users and mapping work flows while performing daily operations involving additional resources, which can be time-consuming for businesses. This additional effort prevents or delays businesses from reaching the decision to automate their processes and reaping the benefits of automation. As a result, many of the automation opportunities are left undiscovered. Discovery Bot allows businesses to assess ROI from potential opportunities that can help with deciding and implementing automation for their processes.

Capabilities

Discovery Bot helps in the following ways:

- Enables automatic process documentation and analysis, thereby saving time and resources
- Identifies the correct processes for automation for business users and citizen developers
- Enables business analysts and RPA developers to accelerate automation and maximize RPA ROI
- Converts automation opportunities into bot prototypes for further development and deployment by the automation developer

How Discovery Bot is used

The Discovery Bot administrator creates processes and invites business users through an email invitation to participate in the recording of these processes. Business users record the steps they perform for various business processes. Discovery Bot aggregates the recordings and generates a proposed work flow. The business analyst can adjust the work flow to select and merge steps into branches from different recordings. From the work flow, the analyst identifies and prioritizes potential automation opportunities based on ROI. Opportunities are approved by the analyst, and Discovery Bot converts the opportunities to TaskBots for deployment.

The following image illustrates how Discovery Bot supports your automation journey from process discovery to bot creation.

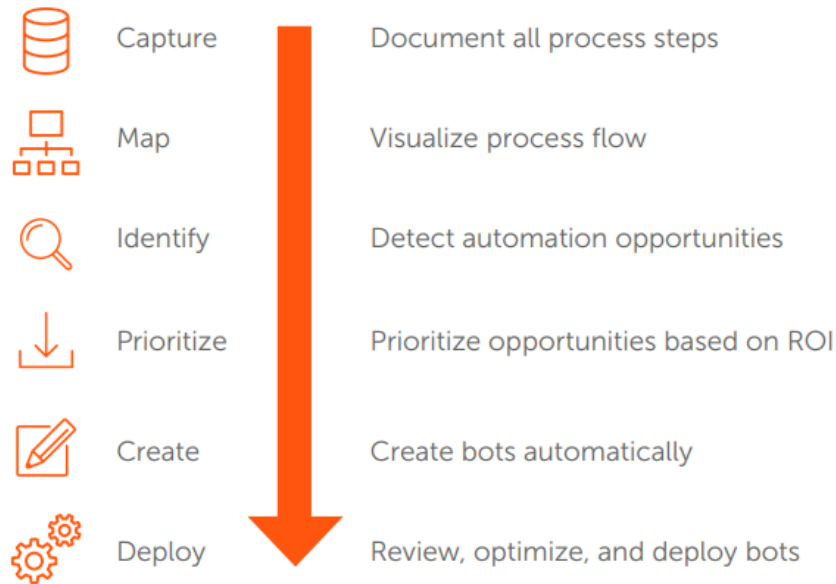

Workflow map: To view Discovery Bot tasks in an interactive visual format, see [Get started with Discovery Bot](#).

For an overview of how to get started with Discovery Bot, watch the following video:

<https://www.youtube.com/embed/wxp8xi4zn14>

See [Get started with Discovery Bot](#).

Get started with Discovery Bot

Discovery Bot enables organizations to accelerate the automation of business processes from process discovery to bot creation.

- Ensure the system requirements are met.

[Prerequisites for Discovery Bot](#)

- Install and configure Discovery Bot for users in your organization.

[Installing Control Room On-Premises](#)

1. Set up users and assign Discovery Bot roles.

Assign Automation 360 users with the relevant Discovery Bot permissions and associated licenses.

- [Discovery Bot users](#)
- [Supported licenses for Discovery Bot](#)
- [Create users for Discovery Bot](#)
 - [Create multi-role users for Discovery Bot](#)
 - [Create a custom role for Discovery Bot](#)
 - [Assign the Discovery Bot custom role to a user](#)

2. Set up the business process within your organization.

Create a placeholder for collecting all of the recordings associated for a given process. Invite one or more users through email notification to a Discovery Bot process recording session.

Create a Discovery Bot process

3. Record the process.

Business users record their work for the associated processes, annotate their steps, and submit for review a proposed automation work flow.

- *Supported applications and browsers for Discovery Bot*
- *Record a Discovery Bot business process*
- *Record a Discovery Bot process using AARI Assistant*

4. Analyze the process.

The relevant business users (subject matter experts (SMEs), RPM or business analysts (BA)) review the recording data and opportunities associated with the process for specific usage patterns.

Analyzing opportunities for automation

5. Create opportunities. Merge specific recordings or steps as required. Prioritize opportunities and generate bots automatically.

- *Review opportunities, convert to bot, and generate PDD*
- *Using the Filter and Toggle frequency counter options*

Discovery Bot users

Various users are involved in the discovery process, and each user's role and responsibility helps in identifying potential automation opportunities for a business process. The streamlined workflow in Discovery Bot enables various users to collaborate without changing their operations in a major way.

Discovering processes for automation involves the following users:

Control Room administrator

Creates other users, assigns roles to users, and assigns Discovery Bot licenses for users

Discovery Bot administrator

Creates, edits, and deletes processes; also, associates Discovery Bot roles to and disassociates Discovery Bot roles from processes

Users with the Discovery Bot administrator privilege cannot view the recorded data of any process, participate in the recording analysis, or create new opportunities for automation.

Discovery Bot business user

Represents the task force in an organization that will benefit from process automations. The business user performs the following associated tasks for business processes:

- Performs the steps in the assigned process and records the steps

The business user is responsible for recording the steps in the process that are being reviewed and evaluated for potential automation candidates. The business user is invited to

participate in recording session by the Discovery Bot administrator.

- Edits the **Step description** (annotated user text) field for recordings.

For each recording, the business user can review the recorded screen captures and provide annotations to capture the business context for the analyst to review. The business user can update the **Data** (keyboard entered) text field if the information should not be shared with the analyst, for example, user ID and password. If the captured steps are not relevant to the process, the business user can delete the steps before submitting the recording for review.

Note: After a recording has been submitted, it cannot be edited.

- Controls the recording of processes using the media control symbols on the Discovery Bot recorder.

Users can start, pause, resume, and stop the recording on demand by using the Discovery Bot recorder to capture the relevant steps for each process.

Note: After the recorder has been stopped, additional steps cannot be inserted into that recording.

Discovery Bot analyst

This user can also be known by other names in an organization, such as process owner, process analyst, business analyst, or subject matter expert. The Discovery Bot analyst is responsible for reviewing the associated recordings and identifying potential candidates for automation. The analyst can perform the following steps:

- View all approved recordings from assigned users for a given process.

The analyst cannot edit the recordings; however, they can merge the necessary variations from multiple recordings and create an aggregate view of the process.

- Create opportunities from individual recordings and the aggregated view created from multiple recordings, and convert the opportunities into bots.
- Export a potential opportunity to a Word document for reference.

While it is not a prerequisite for the analyst to be knowledgeable about the processes they are reviewing, it is beneficial because this knowledge

helps in easily selecting and analyzing the recordings.

Supported licenses for Discovery Bot

Learn about the supported Discovery Bot licenses to ensure business workers are ready to begin using Discovery Bot.

Process Discovery licenses must be purchased for use for business analysts and business users using Discovery Bot. Discovery Bot supports two licenses:

- Process analyzer license for the Discovery Bot analyst

This license allows a user to view and manage the metadata from all recordings within the process and create, view, and manage opportunities created from the recordings.

- Process recorder license for the Discovery Bot user

The process recorder license allows a user to view, record, and submit a process using the Discovery Bot recorder.

The following table displays detailed information for supported licenses and permissions for Discovery Bot business workers:

Discovery Bot user	System-provided Discovery Bot role	Discovery Bot features	Discovery Bot license required
Discovery Bot admin	AAE_Discovery Bot Admin	<ul style="list-style-type: none"> • Create, view, update, and delete processes. • Assign Discovery Bot analyst and business user to processes. 	None
Discovery Bot analyst	AAE_Discovery Bot Analyst	<p>View assigned processes.</p> <hr/> <p>Note: Assigned processes are only displayed after the processes are created by the Discovery Bot admin.</p> <hr/>	Process analyzer

Discovery Bot user	System-provided Discovery Bot role	Discovery Bot features	Discovery Bot license required
		<p>View only recordings (including annotated steps and metadata) that they have created or been assigned to. An Analyst can also view recordings of other users in the process as long as they are in Approved state.</p> <p>If a user is no longer assigned to a process, the user will lose access to the recordings.</p>	Process analyzer
		View all recordings (own and other users), including metadata and annotated steps, for a given process.	Process analyzer
		<ul style="list-style-type: none"> • Create, view, update, and delete manual generated aggregation • View all manually generated aggregations 	Process analyzer
		Create and view own opportunities for a given process.	Process analyzer
		Convert an opportunity to a bot.	Process analyzer for opportunity creation. Bot Creator license is required to convert an opportunity to a bot.
		Export opportunity to Word.	Process analyzer

Discovery Bot user	System-provided Discovery Bot role	Discovery Bot features	Discovery Bot license required
Discovery Bot user	AAE_Discovery Bot User	<ul style="list-style-type: none"> • Using the Discovery Bot recorder, create or more recordings for an assigned business process. • Update own recording to include annotations for the steps. • Delete one or more steps from own recording before submission. • View only recordings (including annotated steps, keyboard entered text, and application type) that they have created or been assigned to. The user can update the keyboard entered text field if the information should not be shared with the analyst (e.g. user ID and password). <hr/> <p>Note: Assigned processes are only displayed after the processes are created by the Discovery Bot admin.</p> <hr/> <p>If a user is no longer assigned to a process recording, the user will lose access to the recording data.</p>	Process recorder

Prerequisites for Discovery Bot

To use Discovery Bot for your enterprise business processes, you must have an Automation 360 working environment and the associated dependencies installed: Bot Agent, browser extension, and so on.

Supported versions and server requirements

Verify that you have the correct Control Room version installed. The Control Room deployment can be cloud or on-premises.

Ensure your Control Room server requirements are set up before installation. See [Control Room server requirements](#).

System requirements

For Discovery Bot users' recording processes or assigned bot creation privileges, verify that your device meets the following system requirements:

- Windows machine is only supported for recording sessions.
- Oracle database is not supported on Discovery Bot.
- Set your local device credentials for any device that is connected to the Control Room. This is a one-time setup for each device. Ensure each device that you use accepts the credentials in your profile.
- [Set user device credentials](#)
- Register your device and install the latest Bot Agent version on your machine. If you have not already installed the Bot Agent, when you log in initially, you will be prompted to install the Bot Agent from the **Processes** tab. Follow the prompts to install the Bot Agent. This will automatically add your user credentials.

[Install Bot Agent and register device](#)

- To record processes using Google Chrome, the Chrome plug-in must be installed.

[Browser requirements for RPA Workspace](#)

- Ensure your environment is ready to begin recording and analyzing processes using the Discovery Bot recorder. The prerequisites are similar to the Universal Recorder.

[Record a task with the Universal Recorder](#)

- Verify the Discovery Bot recorder requirements are completed.

[Supported applications and browsers for Discovery Bot](#)

Update proxy settings

You must update your proxy settings to add the Automation Anywhere URL domain to the trusted list. The added URL domain is specific to your region of Automation Anywhere cloud. If you are using your proxy to access our cloud, you must avoid a redirect to your proxy. Remove any authentication type settings and policy acceptance.

Installation requirements

The Discovery Bot installer is integrated with the Automation 360 installer. No separate installation is required for Discovery Bot On-Premises users. The IT administrator in your organization performs this task. See [Installing Control Room On-Premises](#).

Note: Ensure your database server requirements are met before using SQL authentication mode to connect to the Control Room: [Installing Control Room using Custom mode](#).

For custom installation, you can now change the default repository path location to a new location on your server after installation. The default path is: C:\ProgramData\AutomationAnywhere\ServerFiles. The Process Discovery files now reside in the ServerFiles folder.

Note: For Control Room admin. You must manually copy and paste the existing data into the new location if you change the default path to the new location.

The generated PDD file for an opportunity is now stored locally on your server by Automation 360 On-Premises. The path to the file storage is: C:\ProgramData\AutomationAnywhere\ServerFiles\ProcessDiscovery\opportunity. The existing PDD files will automatically be moved to the new location and will not be deleted when a reinstall or upgrade occurs in the Control Room.

Verify installation

After the installation is complete, log in to your Control Room as an administrator. The Discovery Bot tab is available for use from the left panel.

Process Discovery package

The Process Discovery package contains actions that record various object operations such as click (right or left), recording, and window resizing that are used during process recording sessions. View information about the Process Discovery package from the **View package** page (**Bots > Packages > Process Discovery**).

The package is included in the default packages. You can preload the default package when you connect to your device. Preloading the package helps to speed the start time of the recorder the first time you begin recording a process.

The actions in the package are not available for use from the Bot editor.

Related concepts

[Preload packages](#)

You can preload packages on your local device to shorten the bot runtime.

Upgrade Discovery Bot from Enterprise A2019.15 to later versions

Upgrade Discovery Bot from Enterprise A2019.15 (On-Premises) to a later version for the latest features and enhancements.

Enterprise A2019.15 provides a separate installer (executable file) for Discovery Bot On-Premises users to install and use Discovery Bot from the Control Room. Starting from A2019.16, the Discovery Bot installer is integrated with the Enterprise A2019 installer. To upgrade from Enterprise A2019.15 to a later version, you must first uninstall Discovery Bot from your machine and install the Control Room.

1. In your Windows device, go to **Apps & features**.
2. Search for Discovery Bot.
3. Click **Uninstall**.
4. Install the latest version of the Control Room.

[Installing Control Room On-Premises](#)

- From your local machine, log in to your Control Room as an administrator.
The **Discovery Bot** tab is available for use from the left panel.

Create users for Discovery Bot

Create the Discovery Bot admin, analyst, and users to begin using the Discovery Bot functionality for front-office and back-office business processes. The Control Room admin creates these users and assigns the required system roles.

Ensure that you have purchased the necessary Discovery Bot licenses for your business users before you begin creating users: [Prerequisites for Discovery Bot](#).

To use the Discovery Bot features, the user must be assigned the appropriate role and licenses. See [Supported licenses for Discovery Bot](#).

Note: The Discovery Bot Admin role and permissions are distinct from the Control Room Admin role. See [Discovery Bot users](#).

- From your local machine, log in to your Control Room as administrator.
- Go to **Administration > Users**.
- Click **Create user**.
The icon is located at the top-right of the **Users** table.
The **Create user** page is displayed.
- In the **General Details** section, enter the following user details:

Enable User	Select the check box so that the user can log in immediately.
Username	Enter a unique user name.
Description	Optional: Enter a description for the user.
First name	Optional: Enter the first name of the user.
Last name	Optional: Enter the last name of the user.
Email	Enter and confirm the email address for the user. If SMTP is enabled, the user is sent an email to this address to confirm the account. Click the URL in the email to log in to the Control Room and set up your credentials. All important Control Room notifications will be sent to this email address.

- In the **Select Roles** section, select one of the following roles from the **Available roles** column:

Discovery Bot user	Select this role
Admin	AAE_Discovery Bot Admin
Analyst	AAE_Basic and AAE_Discovery Bot Analyst Note: The AAE_Basic role is required to view or add actions to the bots.
Business user	AAE_Basic and AAE_Discovery Bot User Note: The AAE_Basic role is required to view or add actions to the bots created by the analyst.

6. Click the right arrow to move the role to the **Selected** column.
7. In the **Allocate a device license to this user** section, select the following:

Discovery Bot user	Action
Admin	Retain the default None for the user. This user only has access to the Control Room.
Analyst	Assign the Bot Creator - Development license to this user. <hr/> Note: This license is required to convert an opportunity to a bot.
Business user	Retain the default None for the user. This user only has access to the Control Room.

8. Under **Allocate other types of licenses for this user? > Discovery Bot licenses**, select the following:

Discovery Bot user	Action
Admin	No license is required.
Analyst	Select the Process analyzer license.
Business user	Select the Process recorder license.

9. Click **Create user**.
The new user is displayed in the User table. If SMTP is enabled, an email will be sent to the new user inviting them to log in.

Create a Discovery Bot process

You can begin capturing business processes using Discovery Bot. Create a process and assign users to record and capture the process using the Discovery Bot recorder.

Create multi-role users for Discovery Bot

Create multi-role users when you want to combine system-generated Discovery Bot roles and licenses to provide additional functionality for your users. Depending on your business requirements, you can combine up to three Discovery Bot system-generated roles and two process discovery licenses.

Ensure that you have purchased the necessary Discovery Bot licenses for your business users: [Prerequisites for Discovery Bot](#).

To use the Discovery Bot features, the user must be assigned the appropriate role and licenses.

Note: The Discovery Bot Admin role and permissions are distinct from the Control Room Admin role. See [Discovery Bot users](#).

Multi-role users will see a different set of menu actions (vertical ellipsis icon) available on a tile for a process. These actions are different from the standard Discovery Bot user actions that are available on a tile for a process.

The following actions are available for multi-role users (Admin + Business user + Analyst) on a tile for a process:

Admin actions

- View process details
- Edit process details

- Delete process
- View/edit process details

Business user actions

- Start recording
The **Start Recording** icon is displayed on a tile for a process, or you can select start recording from the vertical ellipsis icon.
- Edit my recording

Analyst action

- Analyze processes
- View process opportunities

1. From your local machine, log in to your Control Room as administrator.
2. Go to **Administration > Users**.
3. Click **Create user**.

The icon is located at the top-right of the **Users** table.
The **Create user** page is displayed.

4. In the **General Details** section, enter the following user details:

Enable User	Select the check box so that the user can log in immediately.
Username	Enter a unique user name.
Description	Optional: Enter a description for the user.
First name	Optional: Enter the first name of the user.
Last name	Optional: Enter the last name of the user.
Password	Optional: Enter your password and confirm the password.
Email	Enter and confirm the email address for the user. If SMTP is enabled, the user is sent an email to this address to confirm the account. Click the URL in the email to log in to the Control Room and set up your credentials. All important Control Room notifications will be sent to this email address.

5. In the **Select Roles** section, select the following roles from the **Available roles** column to create multi-role users:

Discovery Bot user	Select this role
Admin + Business user	AAE_Discovery Bot Admin and AAE_Discovery Bot User
Admin + Analyst	AAE_Basic , AAE_Discovery Bot Admin , and AAE_Discovery Bot Analyst
Business user + Analyst	AAE_Basic , AAE_Discovery Bot User , and AAE_Discovery Bot Analyst
Admin + Business user + Analyst	AAE_Basic , AAE_Discovery Bot Admin , AAE_Discovery Bot User , and AAE_Discovery Bot Analyst

6. Click the right arrow to move the roles to the **Selected** column.

7. In the **Allocate a device license to this user** section, select the following:

Discovery Bot user	Action
Admin + Business user	Retain the default None for the user. This user only has access to the Control Room.
Admin + Analyst	Assign the Bot Creator - Development license to this user. Note: This license is required to convert an opportunity to a bot.
Business user + Analyst	Assign the Bot Creator - Development license to this user. Note: This license is required to convert an opportunity to a bot.
Admin + Business user + Analyst	Assign the Bot Creator - Development license to this user. Note: This license is required to convert an opportunity to a bot.

8. In the **Allocate other types of licenses for this user** section, select the following:

Discovery Bot user	Action
Admin + Business user	Select the Process recorder license.
Admin + Analyst	Select the Process analyzer license.
Business user + Analyst	Select the Process analyzer and Process recorder licenses.
Admin + Business user + Analyst	Select the Process analyzer and Process recorder licenses.

9. Click **Create user**.

The new user is displayed in the User table. If SMTP is enabled, an email will be sent to the new user inviting them to log in.

Create a Discovery Bot process

Log in with your multi-role credentials and create a process. Assign users to record and capture the process using the Discovery Bot recorder. Review and analyze business processes.

Create a custom role for Discovery Bot

Learn how to create a Discovery Bot custom role that allows users to select Discovery Bot feature permissions from standard business user roles (Admin, Business user, or Analyst roles), and a single Control Room admin feature permission for viewing users.

Ensure that you have purchased the necessary Discovery Bot licenses for your business users: [Prerequisites for Discovery Bot](#).

To use the Discovery Bot features, the user must be assigned the appropriate role and licenses.

Note: The Discovery Bot Admin role and permissions are distinct from the Control Room Admin role. See [Discovery Bot users](#).

Use case

The Discovery Bot custom role user is enabled with Control Room Admin feature permissions for viewing users, but does not have edit permissions. The role allows the user to view and manage all Discovery Bot feature permissions for processes, recordings, aggregations, and opportunities. However, the role does not allow the user to view opportunities or the associated metadata created by other analysts in the **Opportunities** tab. The permission to view all opportunities is not enabled for the user.

1. From your local machine, log in to your Control Room as administrator.
2. Go to **Administration > Roles**.
3. Click **Create role**.
The icon is located at the top-right of the **All roles** table.
The **Create role** page is displayed.
4. Enter a **Role** name, and optionally enter a **Role** description.
5. Scroll to the **Administration** section.
6. Select **View users**.
7. Select **View roles**.
8. Scroll to the **Discovery Bot** section.
9. Select **View assigned process** at the parent level.
The child-level permissions are enabled.
10. Select **all** the following feature permissions:
 - a) **Discovery Bot** process feature permissions at the child level
 - b) **Discovery Bot** recording feature permissions at the parent and child levels
 - c) **Discovery Bot** aggregation feature permissions at parent and child levels
 - d) **Discovery Bot** opportunity feature permissions at the parent and child levels

Note: Do **not** select **View all opportunities**.

11. Click **Create role**.
The **Discovery Bot** custom role is created.

Assign the Discovery Bot custom role to a user

Assign the Discovery Bot custom role to a user

Create a new user and assign the **Discovery Bot** custom role you created to the user.

Ensure that you have purchased the necessary Discovery Bot licenses for your business users: [Prerequisites for Discovery Bot](#).

To use the Discovery Bot features, the user must be assigned the appropriate role and licenses.

Note: The Discovery Bot Admin role and permissions are distinct from the Control Room Admin role. See [Discovery Bot users](#).

Custom role users will see a different set of menu actions (vertical ellipsis icon) available on a tile for a process, depending on the permissions given to users. These actions are different from the standard Discovery Bot user actions that are available on a tile for a process.

For this custom role use case, the following actions are available on a tile for a process:

Admin actions

- View process details
- Edit process details
- Delete process

Business user actions

- Start recording

The **Start Recording** icon is displayed on a tile for a process, or you can select start recording from the vertical ellipsis icon.

- Edit my recording

Analyst action

Analyze processes

1. From your local machine, log in to your Control Room as administrator.
2. Go to **Administration > Users**.
3. Click **Create user**.

The icon is located at the top-right of the **Users** table.

The **Create user** page is displayed.

4. In the **General Details** section, enter the following user details:

Enable User

Select the check box so that the user can log in immediately.

Username

Enter a unique user name.

Description

Optional: Enter a description for the user.

First name

Optional: Enter the first name of the user.

Last name

Optional: Enter the last name of the user.

Password

Optional: Enter your password and confirm the password.

Email

Enter and confirm the email address for the user. If SMTP is enabled, the user is sent an email to this address to confirm the account. Click the URL in the email to log in to the Control Room and set up your credentials. All important Control Room notifications will be sent to this email address.

5. In the **Select Roles** section, select the **AAE_Basic** role and the Discovery Bot custom role you created from the **Available roles** column.
6. Click the right arrow to move the roles to the **Selected** column.
7. In the **Allocate a device license to this user** section, select the **Bot Creator - Development license**.
8. In the **Allocate other types of licenses for this user** section, select the **Process analyzer** and **Process recorder** licenses.

9. Click Create user.

The new user is displayed in the User table. If SMTP is enabled, an email will be sent to the new user inviting them to log in.

Create a Discovery Bot process

Log in with your custom role credentials and create a process. Assign users to record and capture the process using the Discovery Bot recorder. Review and analyze business processes.

Create a Discovery Bot process

Create a Discovery Bot process and assign users to record and analyze a process for your automation requirements.

- This task is performed by the Discovery Bot admin who manages the creation, deletion, and editing of Discovery Bot processes.

Note: Multi-role and custom role user can also perform this task depending on the roles or the permissions given to users. You will see a different set of menu actions (vertical ellipsis icon) available on a tile for a process.

- Ensure the **Process recorder** license is allocated to Discovery Bot users assigned to recording a process.
- Ensure the **Process analyzer** license is allocated to the Discovery Bot analyst assigned to analyzing a process.
- Create a process and assign users:
 - a) From your local machine, log in to your Control Room as a Discovery Bot administrator.
 - b) Go to **Discovery Bot > Processes**.
 - c) Click **Create Process**.
The **Create process** page is displayed.
 - d) In the **General Details** tab, enter a **Process Name**.
Special characters are not supported. Creating a process with a duplicate name is not supported.
 - e) Optional: Enter a **Process Description**.
 - f) Click **Next** to assign users to a process.
 - g) Optional: In the **Users** tab, select the Discovery Bot business user or analyst from the list of **Available** users.
 - h) Click the right arrow to move the roles to the list in the **Selected** column.
 - i) Click **Next** to view the invitation that is sent to users to begin recording processes.
 - j) Click **Create Process**.
 - k) Click **Close** to exit the page and return to the **Processes** page.

Note: An email invitation is sent to assigned users (new users or users added at a later time) to begin a Discovery Bot process recording session.

The newly created process is displayed in the **Processes** page on a tile.

For users, all of their assigned processes are available for viewing from the **Processes** page. Use the search field to help you locate a specific process by name. The field is not case-sensitive. For users, use the field to search on a process you are assigned to. For admin users, use the field to search on all processes. Use the sort field to help you locate a process tile quickly. Click the drop-

down to sort for a process tile based on the process name in alphabetical order or you can sort in the order of newest process created to oldest process and vice versa. The tile for a process displays the following information for an admin user:

Process tile	Description
Recordings	The number of the recordings captured and stored for a process by users.
Process Cycle	The average time, in minutes and seconds, across all recordings captured for a process.
<p data-bbox="462 514 966 556">Vertical ellipsis icon (three dots)</p> <hr/> <p data-bbox="462 577 966 703">Note: You might see a different set of menu actions available from the tile if you are a Discovery Bot standard user, multi-role user, or custom role user.</p> <hr/>	<p data-bbox="966 514 1469 577">View, edit, or delete information for a process.</p> <ul data-bbox="966 598 1469 850" style="list-style-type: none"> • Click View process details to view more information about a process, edit and update information, and save changes. • Click Edit process details to edit a process. Enter your changes and click Save changes. Click Close to return to the Processes page. <hr/> <p data-bbox="966 882 1469 945">Note: The name of the process cannot be changed.</p> <hr/> <ul data-bbox="966 966 1469 1060" style="list-style-type: none"> • Click Delete process to delete a process. A message window appears. • Click Yes, delete to delete a process. <p data-bbox="966 1081 1469 1165">All recordings and associated data are permanently deleted. This cannot be undone.</p> <p data-bbox="966 1186 1469 1249">Click No, cancel to return to the Processes page.</p> <ul data-bbox="966 1260 1469 1480" style="list-style-type: none"> • Click View/edit process details to view more information about a process, edit and update information, and save changes. To edit a process, click Edit. Enter your changes and click Save changes. Click Close to return to the Processes page. <hr/> <p data-bbox="966 1512 1469 1575">Note: The name of the process cannot be changed.</p> <hr/> <ul data-bbox="966 1596 1469 1795" style="list-style-type: none"> • Click Edit my recording to edit and review recordings. • Click View process opportunities to view auto-generated or custom opportunities created from the Opportunities tab.

- Create a process and add users at a later time:
 - a) From your local machine, log in to your Control Room as a Discovery Bot administrator.
 - b) Go to **Discovery Bot > Processes**.
 - c) Click **Create Process**.
The **Create process** page is displayed.
 - d) In the **General Details** tab, enter a **Process Name**.
Special characters are not supported. Creating a process with a name previously used for another process is not supported.
 - e) Optional: Enter a **Process Description**.
 - f) Click **Create Process** to create a process without assigning users.
 - g) Click **Close** to exit the page and return to the **Processes** page.

- Update an existing process and add users.
 - a) From your local machine, log in to your Control Room as a Discovery Bot administrator.
 - b) Go to **Discovery Bot > Processes**.
 - c) Go to the process you want to edit.
 - d) Click **Edit** from the **Options** icon.
 - e) In the **Edit process** page, click **Next** to assign users to a process.
 - f) In the **Users** tab, select the Discovery Bot business user or analyst from the list of **Available** users.
 - g) Click the right arrow to move the roles to the list in the **Selected** column.
 - h) Click **Save changes**.
 - i) Click **Next** to view the invitation that is sent to users to begin recording processes.
 - j) Click **Close** to exit the page and return to the **Processes** page.

Note: An email invitation is sent to assigned users (new users or users added at a later time) to begin a Discovery Bot process recording session.

The newly created process is displayed in the **Processes** page on a tile.

Record a Discovery Bot business process

Log in to your Control Room as a Discovery Bot user and record a business process assigned to you.

Supported applications and browsers for Discovery Bot

Learn about supported applications and browsers to ensure your environment is ready before you begin using the Discovery Bot recorder.

About the Discovery Bot recorder

The Discovery Bot recorder is similar in function to the Automation 360 Universal Recorder with one significant difference: pre-selection of the application to be used for recording is not required.

The Discovery Bot recorder captures data across many user interface (UI) objects such as Windows applications, native applications, executable file, or browser window on PC devices and machines or virtual

machines running Windows OS. Use the Discovery Bot recorder to capture, read (data extraction), write (data entry), and click (left or right) operations when working across various operations. A single recording per user can capture up to 8 hours of user actions.

The Discovery Bot recorder displays the performed action by using highlighter. Click the object control, for example, a button, form field, or a table. A red outline highlights the control when you move the mouse over it to capture the action.

You can perform actions like double-click, drag-drop, click and hold, and text select while recording. Actions performed using keyboard strokes are displayed in the **Data** field.

Supported applications and browsers

The recorder supports system, web, and virtual applications including the following:

Applications

- Microsoft applications: Edge, PowerPoint, Excel, Word, Outlook, Calculator, Notepad, Notepad++, Teams
- Zoom
- Snagit
- Java applet, web start, and desktop applications that run using Java Runtime Environment (JRE) 6, 7, 8, 9, 10, and 11 (32-bit and 64-bit versions)
- Microsoft Active Accessibility and UI automation based applications
- Oracle EBS and Forms
- SAP 730, 740, 750 and 760 versions.
- Citrix Virtual Apps

Browsers

- Internet Explorer version 11
- Google Chrome

Note: Chrome plug-in must be installed to record processes. If the Chrome plug-in is removed, you must manually add and re-enable the plug-in. [Google Chrome browser extension requirements](#)

Desktop

The desktop refers to the device screen when all application and browser windows are minimized.

Taskbar

The taskbar is the horizontal or vertical bar containing icons of open applications and browsers, as well as the notification area. You can capture application, browser, system, and other icons, for example such as the clock and calendar, volume, and Wi-Fi.

Record a Discovery Bot business process

Record, capture, and annotate steps for a business process using the Discovery Bot recorder. The process recording allows the Discovery Bot analyst to view all recorded steps for a quantitative and comparative

analysis. The steps along with the captured metadata and user actions help the analyst make the decision to create opportunities and bots.

- This task is performed by the Discovery Bot user who records assigned business processes and submits the same for review and analysis.

Note: Multi-role and custom role user can also perform this task depending on the roles or the permissions given to users. You will see a different set of menu actions (vertical ellipsis icon) available on a tile for a process.

- Ensure that you have set your device credentials and installed the latest Bot Agent version on your machine before using the Discovery Bot recorder.
- Ensure that the machine on which you will be performing the recordings is also duly registered.

Prerequisites for Discovery Bot

1. Record a business process:

- a) From your local machine, log in to your Control Room as Discovery Bot business user.
- b) Go to **Discovery Bot > Processes**.
The **Processes** page appears, displaying all processes assigned to the user for recording.
- c) Click the **Start Recording** icon from the tile associated with the process you want to begin recording a process.

Note: You can also select, **Start Recording** from the from the vertical ellipse icon to begin recording a process.

A message window appears notifying you that you are now recording and sharing your screen. The **Discovery Bot Recorder** window is displayed with **Pause** and **Stop** options. Pause and resume the recording as required. Allow for a few minutes for the recorder to start the very first time you begin recording a process.

- d) Perform the actions to record.
For example, open an application and fill in a form or open a browser and search a website. Click the object control, for example, a button, form field, or a table. A red outline highlights the

control when you move the mouse over it to capture the action. The red outline indicates that the recorder is ready for you to take the next action in recording the process.

You can perform actions like double-click, drag-drop, click and hold, and text select while recording. Actions performed using keyboard strokes are displayed in the **Data** field.

- e) Click **Stop** to end the recording.

You can click **Cancel recording** to cancel a recording at any time.

Wait for a few seconds for the recorder to end. The details in the tile for the process is incremented to include the new recording in the **Recordings** section.

Note: Once the recording has been stopped, additional steps cannot be added to the recording.

Note: A maximum of 8 hours worth of user actions can be captured in a single recording.

- f) Enter a name for the recording in the field provided.
The character limit is 50. Special characters are supported.
- g) Click **Save** to save your changes.
- h) Click **Cancel** to discard the recording.

Note: If you discard the recording, you cannot recover it.

2. Review the captured steps, annotate them, and submit a process recording for review to the Discovery Bot analyst:

- a) From **Processes**, select a process by clicking the process name or anywhere within the process tile body. From **Processes**, click the vertical ellipsis icon and select **Edit my recording** to edit and review recordings.

If you click the process tile body or the process name, the **Opportunities** page appears. Only approved recordings from the **Opportunities** tab are displayed for the analyst.

For Discovery Bot multi-role and custom role users, click the vertical ellipsis icon and select **Edit my recording** to edit and review recordings. If you click the process tile body or the process name, the **View process** page appears. Only approved recordings are displayed for the analyst on the **View process** page.

The **Recordings** page appears with the **Recordings** table on the left and single recording details on the right. The table displays the following information:

Recordings	Description
Recordings (#) (# selected)	The number of recordings logged in by users.
Customize columns	Click the table icon to display or hide columns (ID, Status, Process Cycle, and Recorder), or edit the layout of the header rows to display right or left as required.

Recordings	Description
ID	<p>The ID number of the recording in the database. The system collects and sequentially increments the index for each recording captured by the users.</p> <hr/> <p>Note: To search for a specific recording, select ID and enter the ID number in the search bar.</p> <hr/>
Name	The recording name.
Status	<p>The status of the recording:</p> <ul style="list-style-type: none"> • Pending: Initial state. • Approved: All user-required edits have been completed and recording is ready for review by an analyst. • Error: There is an error when storing the recording in the system. • Declined: Currently not being used. <hr/> <p>Note: To search on a process status, select Status and choose a status from the drop-down list.</p> <hr/>
Process Cycle	The recording duration, in minutes and seconds, excluding the time that the recorder was paused.
Recorder	<p>The name of the user that created the recording.</p> <hr/> <p>Note: To search on users assigned to a recording, select Recorder from the drop-down list and enter the user name in the search bar. The search is case-sensitive.</p> <hr/>

- From the **Recordings** table, select a recording to view all captured steps. In the right pane, the header displays the recording ID details, including the total steps captured during the recording session, recording name, process time, and current recording status.

Each recorded step includes: screenshot image with the **Screen** option (icon), application type, data (keyboard entered text), and step description (annotated user text) fields.

- Optional:** To provide a description for the recording, click in the **Description** area. Using the **Description** field that appears, share the context and the purpose of the recording with the analyst. The character limit is 255. The description entered is displayed in the PDD.
- Click **Save** to save the description you entered in the **Description** field.

6. Optional: Click the **Screen** icon to display or hide the screenshot image.

Use the **Screen** option icon when you do not want to share personal image details with the Discovery Bot analyst, multi-role, or custom role users. To remove personal information, for example username and password credentials from the image, edit the **Data** field prior to submission for analyst review.

Note: If you hide an image and Click **Submit**, you cannot display the image again.

7. Click the screenshot to display the image in full size.

The **Screenshot** shows the state of the application at the time of performing the associated action. The red outline highlights where you have performed actions like click and hold and text select. You cannot edit the screenshot. Click the image when you want to display a larger view of the screenshot. Review the step action in more detail from the modal window. Click the pagination located below the image to select a step number or use the right or left arrows to quickly display all captured images. For actions not captured by the recorder such as double-click, drag-drop, and click and hold, you can document the individual steps in the **Step description** field for the analyst.

The duration of the recorded step is displayed in minutes and seconds below the screenshot. Use this information to help prioritize what step or sequence of steps are a better candidate for automation. For example, if a sequence of steps takes longer to perform, you can automate this first for a process to save manual effort.

- Click the **Hide image** icon to hide the image.

The image will not be submitted to the analyst for review. Click **X** to close the frame. Click **Save** to save your selection.

- Click **Show image** to display the image.

The image will be submitted to the analyst for review. Click **X** to close the frame. Click **Save** to save your selection.

8. Optional: Update the application name used in the process recording in the **Application** text field.

The **Application** field represents the name of the application on which the action was performed. If required, the user that made the recording can change this.

9. Optional: Update the keyboard entered text used in the process recording in the **Data** text field.

The **Data** field represents any data entered by the user at that step during the recording.

Note: You must follow the keyboard data entry with a left or right mouse click. For any step in which the data was entered, you can make changes to the data in the **Data** field. You cannot enter any data for steps which do not have any data entered during the actual recording of the process.

10. Optional: Update the context associated with the step in the **Step description** text field.

The **Step description** text field represents any additional description that you would like to provide regarding the operation being performed. The maximum character limit is 2000.

11. Optional: Delete any step that is not required to be included in the process recording.

12. Repeat the above steps for each step as required.

13. Optional: Click **Save** to save your changes.

Use the **Save** option when you want to edit and compare the recording data (including application, keyboard entered text, and annotation text fields) across multiple recordings captured in the **Recordings** table.

14. Optional: Click **Delete** to delete the recording for that process.

Use the **Delete** option when you do not want to submit the recording data to the analyst for review. The recording and associated data is deleted from the **Recordings** page for that process.

15. Click **Submit.**

The recording is submitted to the analyst for review and approval.

Note: After a recording is submitted, it cannot be edited to make additional changes.

16. Click the **Download option to export the opportunity data into a Process Definition Document (PDD) with the same name as the opportunity. Select the type of PDD (Word or PDF) that you want to export. The PDD includes the process recording flow chart and the time on each individual step in hours, minutes, and seconds.**

When an opportunity is created, the PDD begins processing in the background automatically. When the PDD is generated, the field changes from Processing PDD to **Download**. You can now download the document. An email notification to the business user is also sent to the email address on file. If an error occurs when you download the PDD, click **Download** again to generate the PDD again.

Note: If you are a multi-role user, you will receive two email notifications for the exported data, one for the recording data and one for the opportunity data.

Note: You must be the owner of the opportunity to be able to download it; otherwise, the download option is not available.

On your machine, the document is saved in the folder that is configured for downloads in your browser.

Analyzing opportunities for automation

Log in to your Control Room as a Discovery Bot analyst to review and analyze the recordings to create opportunities or bots as required.

Record a Discovery Bot process using AARI Assistant

Use AARI Assistant to record Discovery Bot business processes without signing in to the Control Room.

- Before using the Discovery Bot recorder, ensure that you have set your device credentials and installed the latest version of the Bot Agent on your machine.

Note: The Bot Agent installation will load the AARI icon on your desktop.

- Ensure that the machine on which you will be performing the recordings is also duly registered.

Prerequisites for Discovery Bot

- Ensure that your browser settings allow redirects and pop-ups from your browser to access the Control Room.

1. Double-click the AARI icon to open the AARI Assistant.

2. Use Automation 360 credentials to sign in to the application.

3. Click **Processes**.

The **Recording Processes** page appears, displaying all the processes assigned and available to the user.

4. When you want to start recording a process, click **Start recording**.

A message window appears, notifying you that you are now recording and sharing your screen. The **Discovery Bot Recorder** window is displayed with **Pause** and **Stop** options. Pause and resume the recording as required. The first time you begin recording a process, the recorder might take a few minutes to start recording.

5. Perform the actions to record.

6. To end the recording, click **Stop**.
You will be redirected to the Control Room to review and edit your recording before you submit it.
[Record a Discovery Bot business process](#)
7. To review the steps of previous recordings and submit them, click **Previous recordings**.
You will be redirected to the Control Room to review the recordings.

Analyzing opportunities for automation

Review opportunities and process recording data by using graphs and charts that help you to analyze and understand the benefits and savings from a potential opportunity with or without automation.

Opportunities

The Opportunities header provides a snapshot of the recording and opportunity data captured by all users for assigned processes. The following data is displayed in the **Opportunities** header:

Field	Description
Savings	The potential savings (yearly savings or savings per run) associated with the opportunity
Number of opportunities	The number of opportunities that include the selected recordings
Number of process variants	The number of branches included in the opportunity
Average process cycle	The average duration of the recordings provided for the process
Participants	Number of users who submitted recordings for the process

Opportunities evolution

Use the opportunities evolution map as a guide to decide which opportunities to automate first. Each quadrant displays the following:

- **Proceed now:** These opportunities yield the maximum benefit and ease of implementation.
- **Long term:** These opportunities yield good ROI but will take time to implement. They also require a higher implementation effort to automate.
- **Hold:** The automation benefit is low and the implementation time is high. The recommendation is not to automate.
- **Quick wins:** Always do this first to build momentum.

Application usage

The donut chart displays the number of applications used across selected recordings. The application usage details are displayed in the table to the right of the chart in the following format: Application | minutes seconds | percentage. The percentage represents the percent of the application used over a total of all applications used.

Use case

Use this information to quickly understand user participation and process complexity and variability; the higher the application count, the higher the complexity and variability of the process that is being analyzed. The average process cycle time will provide a quick insight into the duration of the process within the expected processing time. If the actual process cycle is higher across application count, this might be an indicator that the process is a more suitable candidate for automation and assists with improving efficiency.

Process cycle time by process

This graph displays the time associated with the average process cycle (in minutes) for each process and by user.

Use case

Use this information to help you understand which processes take the most time and therefore, will potentially give you more savings if automated. For example, an analyst can learn why a process recording took longer or was completed in a shorter period for one particular participant and compare this information with other participants. This information is instrumental in narrowing down on a smaller subset of the process recordings to study them for inefficiencies that might result in better or more opportunities for automation.

Number of steps by a process

This graph displays the average number of manual steps in each process and by user. Use this information to compare the number of steps across processes. Processes with greater number of manual steps are more likely candidates for automation.

Review opportunities, convert to bot, and generate PDD

Review potential, system-generated opportunities, create custom opportunities from a system-generated opportunity, and convert them to bots. You can also export the opportunity data to a Microsoft Word or PDF document for your reference.

Automation opportunities are of two types, system-generated and manual. System-generated opportunities, also known as auto-generated opportunities, are created when at least one recording is approved by the user for a process. The auto-generated opportunities are available immediately for you to begin analyzing from the **Opportunities** page for the recording. The **Download** option to generate a Microsoft Word or PDF document is not available for auto-generated opportunities. Creating a branch and merging steps into the branch for auto-generated opportunities is not available from the process diagram.

Manual opportunities, also known as custom opportunities, are created from auto-generated opportunities. A custom opportunity allows you the flexibility to review current and newly added recordings from users and decide to accept or reject the new recording changes to the existing process diagram. You can also create a branch as you add steps from another recording to the process diagram. The **Download** option is available for you to use if you want to download a Microsoft Word or PDF document of the custom opportunity data for your reference.

- This task is performed by the Discovery Bot analyst who is in charge of reviewing and analyzing the associated recordings of business processes.

- Ensure the analyst is assigned a Process analyzer license and the **AAE_Discovery Bot Analyst** role before processes are analyzed.

Supported licenses for Discovery Bot

- Ensure the analyst is assigned a Bot Creator license to convert opportunities to bots.

Supported licenses for Discovery Bot

1. Review the data in the **Opportunities** tab:

- a) From your local machine, log in to your Control Room as Discovery Bot analyst.
- b) Go to **Discovery Bot > Opportunities**.

The **Opportunities** page displays all the opportunities you have created. You can configure the menu option to display as you want using the **Customize columns** icon. The table lists the following information:

Field	Description
Opportunity name	The name created for the opportunity. To identify an auto-generated opportunity from a custom opportunity, the auto-generated opportunity begins with the name of the process hyphen OPPORTUNITY.
Process name	The name created for the process.
Type	The type of opportunity created for a process. The type can be Auto or Custom.
Path	The type of path specified based on the Filter option applied to the opportunity. Auto-generated opportunities use filter default value of Most common path.
Date created	When the opportunity was created.
Date modified	The date the opportunity is modified by the analyst. The modified date can occur when a opportunity is updated or when a custom opportunity is created.
Owner	The name of the process owner. The process owner can be system or analyst.
# of recordings	The number of recordings for a process associated with the opportunity.
# of applications	The number of applications used in a recording session associated with the opportunity.
Process cycle	The duration of the recording session associated with the opportunity.
# of users	The number of users who participated in the recording session for that process.

Field	Description
Cost without automation	The formula used to calculate the cost of the opportunity without automation. Use the formula to help you decide which opportunities to prioritize for your business development based on ROI, applications used, number of users, and so on. The formula is calculated by taking the number of users multiplied by the total hourly pay of number of users multiplied by the average process cycle.
Savings	The potential savings associated with the opportunity (this could have been specified as a yearly savings or savings per run).
Priority	The priority level assigned to the opportunity. The priority can be one of the following: <ul style="list-style-type: none"> • Low • Medium • High
Bot created	The bot created for an opportunity. This can be Yes or No. The Convert to bot option is not available for auto-generated opportunities. The Convert to bot option is available for custom opportunities only.

- c) Select the required opportunity by sorting, searching, or both from the table using the **Search** field.
 - d) Click the vertical ellipsis icon (three dots) from the table to view an opportunity or download a Word or PDF PDD document.
The PDD download option for Word or PDF is only available for custom opportunities.
 - e) Select an opportunity from the table for display.
- 2. Optional: Create a custom opportunity from the autogenerated opportunity.**
- a) Expand the **Recordings** section from the left side of the main canvas.
By default, all selected recordings are displayed in the process diagram.
 - b) Select a single recording from the **Recordings** section for review, as needed.
The selected recording is colored in blue from the **Recordings** section and displayed in the new feeder canvas to the left of the main canvas. All recordings are displayed in the process diagram

to the right of the main canvas. Toggle off the selected recording to select another recording for display.

- c) Select either the screenshot icon or the application icon to decide how you want to display the steps.

Use the **Zoom in** or **Zoom out** options as required. Use the **Reset** zoom to bring the view back to the default level and recenter the process in the canvas.

Contiguous steps performed in the same application are combined together. This is displayed as a single group to allow better readability of the process. The number of steps collated together is indicated in the bottom-right corner of the group.

Note: If the screenshot view is the last active view, then the image of the last step in the group is the one that is displayed for the collapsed group. You can drag the process within the canvas by holding down the mouse left button and moving the process to the desired location.

- d) Click a step to expand a group of steps to preview the step in more detail. Alternatively, click the arrow near the top-right corner of the group icon.
Use the group icon to display groups of steps that belong to the primary and secondary level actions (and subgroup level actions) used during the recording session. As required, expand a group of steps to drill down from the primary to subgroup-level actions to help you decide what group of steps to use when creating a potential opportunity for a task that you want to automate. For example, a primary-level action displays Microsoft Outlook, a secondary-level action displays Outlook mail notification, and subgroup-level actions can display compose email, body email, and send email.
- e) Select the **Select all steps** check box from the **Overview** pane to select all the steps in the process diagram.
Based on your requirements, use the Shift key to customize the number of steps within a path from the main canvas. If you select a nested branch or loop, the parent branch or loop displays a partial selection.
- f) Optional: Use the **Filter** option to customize a specific opportunity. *Using the Filter and Toggle frequency counter options.*
- g) Optional: Use the **Toggle frequency counter** option to display the frequency of path as compared to other recordings. For more information, see *Using the Filter and Toggle frequency counter options.*
- h) Click **Save as** to save the opportunity as a custom opportunity.
- i) Enter a name and description for the opportunity in the fields provided.
- j) Click **Save as** to save your changes.
A message window appears notifying you that the opportunity is created. Click the hyperlink to view the custom opportunity. The PDD is generated and available for download from the **Opportunities** table. Click the vertical ellipsis to download the PDD in Word format or PDF.

Note: The filter option you selected for a custom opportunity will not be reflected in the new custom opportunity process diagram.

3. Optional: Create another custom opportunity from a custom opportunity. Add steps from another recording to the process diagram, create a branch, and merge steps from one or more recordings into the branch.
 - a) Select a single recording from the **Recordings** section.
 - b) Click the branch icon from the right main canvas to add a condition step.
Moving the subsequent step into a branch on the left and adding a new branch to the right in the empty branch are to receive steps from another recording. In the top-right corner of the

yellow box, click the three dots to create a new branch or delete a branch. The branch endpoint is displayed with a small circle.

By default, you can move the branch endpoint lower in the path flow to include more than one step. To move the branch endpoint, press down with the cursor on the endpoint until you see the dotted lines appear around the branches. Drag the endpoint downward in the path flow. Place the endpoint when you see the dotted lines appear between the arrow. The endpoint is shifted downward in the path flow and includes more steps. To select a custom selection of steps, use the Shift key to select a certain number of steps within a path from the main canvas. Cross-path selection is not available.

The loop icon is displayed as an orange circle with an arrow. A loop is a sequence of steps that occurs for a specific number of times for a single recording. The loop icon has a **for** condition displayed under this along with **Count**, which describes the number of times the sequence of

steps in this loop is repeated in the process. You can change the loop condition (**for** and **while**) by saving the process diagram.

- c) Click the **Condition** field at the node level.
- d) In the **Condition** field, enter a name for the condition. Example, `credit score`.
- e) Click the check mark to save the name for the condition.
- f) Open the corresponding branches on the right and left and set a value for the condition. For example, enter less than 200 on the right and greater than 700 on the left.
- g) Drag and drop steps from the recording in the feeder canvas into the receiver step that reads `Drag items here` of the branch in the main canvas.
Use the Shift key to select one or more steps to drag into the receiver step. To clear a condition in the branch, click the three dots. Select **Clear branch**.
- h) Click **Save** to save your changes to the process diagram.
The PDD begins processing in the background automatically. When the PDD is generated, the field changes from Processing PDD to **Download**.
- i) Repeat steps a through h to review additional recordings and create branches and merge steps into the branch.
- j) From the **Overview** pane, click the **Edit** icon to update the potential savings associated with the custom opportunity.
The potential savings and potential cost can be updated at any time as you review the steps from various recordings and make changes within the process diagram.
- k) Enter the estimated cost of the process without automation.
- l) Enter the potential savings associated with the process when automation is used.
This is your best assessment of the expected savings on an annual basis if a bot is used to perform all the steps in the opportunity.
- m) Select the priority from the drop-down list.
- n) Click **Update**.
- o) Click **Save** to save your changes to the process diagram.
- p) Repeat steps j through o to update the potential cost for the custom opportunity from the **Overview** pane.
- q) Click **Save as** to save the opportunity as a custom opportunity.
- r) Enter a name and description for the opportunity in the fields provided.
- s) Click **Save as** to save your changes.
A message window appears notifying you that the opportunity is created. Click the hyperlink to view the custom opportunity.
- t) Optional: Repeat steps 4a through s to create another custom opportunity from this custom opportunity, as needed.
All opportunities (autogenerated and custom) can be viewed from the **Opportunities** page.

4. Optional: For custom opportunities, review new recordings submitted by the Discovery Bot user. Accept or dismiss the new changes for the process diagram.

- a) Click **Review** to accept the updates and review the new recordings.
- b) Select the new recording from the **Recordings** section.
The selected recording is highlighted in blue. The recording opens for display to the left of the canvas. Refer to the dotted lines around the steps. The placement of the steps is displayed in the process diagram to the right of the canvas with a bold border around the steps. The shaded green

refers to the placement of the groups of steps from the new recording as they will appear in the process diagram if you update with these changes.

- c) Click **Update with changes** to accept the updates to the process diagram.
A pop-up message is displayed, indicating that your changes are successfully updated.
- d) Click **Back to edit** to return to the current process diagram without the changes.
- e) Click **Dismiss** to dismiss the changes.
Continue reviewing the current process diagram for the custom opportunity. Add steps from another recording to the process diagram, create a branch, and merge steps from one or more recordings into the branch, as needed.

5. Convert to bot:

- a) Click the **Convert to bot** option.
- b) Enter a bot name.
- c) Optional: Enter a description.
- d) Click **Browse** and accept the default folder location `\Bots\`.
To change the location where your bot is stored, drill down to the folder in which you want to save the bot.
- e) Click **Confirm**.
- f) Click **Convert**.
A message window appears notifying you that the bot has started to convert. You will receive an email when the bot is converted successfully. Click the hyperlink in the email to take you to your folder in which the bot was generated.

Note: In the **My bots** tab, the converted bot displays an error, with 0 byte size while the bot creation is in process. Avoid opening the bot until the bot conversion is complete.

The **Convert to bot** option is only available if you have the Bot Creator license. To review the created bot you must have the **AAE_Basic** role assigned.

- 6.** Click the **Download** option to export the opportunity data into a Process Definition Document (PDD) with the same name as the opportunity. Select the type of PDD (Word or PDF) that you want to export. The PDD includes the process recording flow chart with a URL link to the process diagram inside Discovery Bot, and the time on each individual step in hours, minutes, and seconds. The PDD does not display the process diagram if there are more than 100 steps selected.

When an opportunity is created, the PDD begins processing in the background automatically. When the PDD is generated, the field changes from Processing PDD to **Download**. You can now download the document. An email notification to the business user is also sent to the email address on file. If an error occurs when you download the PDD, click **Download** again to generate the PDD again.

Note: If you are a multi-role user, you will receive two email notifications for the exported data, one for the recording data and one for the opportunity data.

Note: You must be the owner of the opportunity to be able to download it; otherwise, the download option is not available.

On your machine, the document is saved in the folder that is configured for downloads in your browser.

Using the Filter and Toggle frequency counter options

Use the Filter and Toggle frequency counter options from the toolbar to help you review, analyze, and compare the various recordings in the process work flow as you look to create a potential opportunity.

Filter option

Use the **Filter** option when you want to use a set of values to compare the different sections of a process across various recordings by selecting a specific path and step filter. The **Filter** window displays the following:

Option	Action
Path: With the most common flow	Select this option when you want to see what paths have the most common variance of a process that is being used. If you choose to automate this type of path, you will have a higher return on your investment.
Path: With the most deviations	Select this option when you want to see certain sections of the process that have a different deviation in the path. The automation priority for such paths are usually low.
Path: With the most repetitive flow	Select this option when you want to display sections of the process that are more repetitive and cost more. The automation priority for such paths are usually high.
Step: Application	Select the Application option when you want to see the application type used during the recording. Use this option to see which applications are more frequently used, and to decide on which applications should be a priority.
Step: Action Type	Select the Action type option to filter the process steps to display only particular actions that will help you get an idea how the steps are used.
Clear	Select Clear to clear all selected options.
Reset	Select Reset to reset to the previous saved state of the filters in a view.
Apply	Select Apply to apply the selected options for display for the system generated or manual opportunity.

Toggle frequency counter

Use the toggle frequency counter option to display the number of recordings that a particular path takes in the flow for a system generated or manual opportunity. Use this option to help you understand the frequency of the path as compared to other recordings. From the **Recordings** table, select two or more recordings and the **Toggle frequency counter** displays two at the start of the process flow to indicate

the number of recordings selected. If each recording takes a different path, the process flow is divided between the total number of recordings selected and displays accordingly. For example, if there are ten recordings in a view and three paths displayed. Two recordings follow one path, two recordings follow the second path, and six recordings follow the third path. Along the path flow, you will see two, two, and six. If a step is merged, the number gets added between the two paths. Use the thick or thinness of the path to help you prioritize processes for automation. The most commonly used path is the thickest path and this can be useful for prioritizing a process when reviewing many recordings. For example, if there are 5 paths for 20 recordings, you will quickly see which is the thickest and consider automating this path. If you have additional bandwidth to automate another path, you can drill down in the flow and look at the numbers to see what path is next as a possible candidate for automation.

Getting started with Privacy Enhanced Gateway

Control the data that the Process Discovery cloud platform receives by using the Process Discovery Privacy Enhanced Gateway (PEG). PEG redacts sensitive data that is included in video frames collected by the Process Discovery desktop sensor. This redaction occurs within your own Virtual Private Cloud (VPC) before the data is forwarded to the Process Discovery cloud for analysis.

Deployment

Before installing PEG in your network, review the deployment platforms supported by PEG, virtual machine (VM) size requirements, and storage requirements.

Obtaining PEG

PEG runs as a VM in your VPC. PEG deployments are supported on Microsoft Azure, AWS, and Google Cloud Platform. Automation Anywhere will provide cloud images for you to deploy.

VM size requirements

The following VM sizes are supported for PEG installation:

- Azure: NC8as T4 v3
- AWS: g4dn.4xlarge
- Google Cloud Platform: N1-highmem-8 with 1 nvidia-tesla-t4 GPU

Note: Each PEG VM can handle 10 sensors per calendar week, with each sensor sending data for approximately eight hours each day for five days a week.

Common storage requirements

Before you install PEG, ensure that your OS or root disk has 2 TB of nearline SSD storage or more. Encrypt the disk using your platform's storage encryption mechanisms.

Deployment and networking requirements

Learn about the deployment architecture based on certificates for HTTPS connections and the associated port and DNS requirements.

Deployment

With this deployment model, all connections to PEG remain within networks that you control.

Figure 5: Architecture

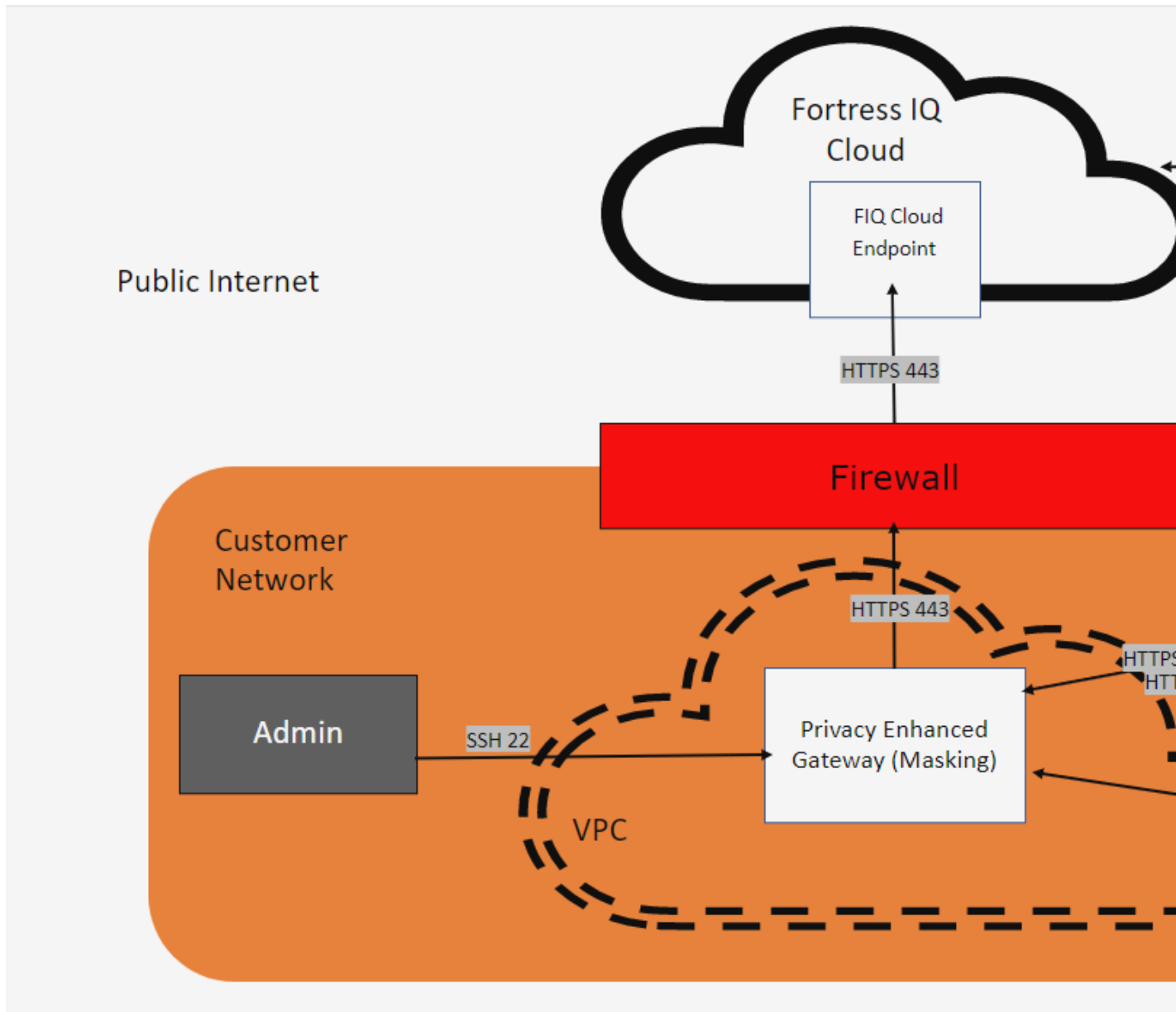

Port requirements

The following table lists the port requirements for ingress and egress IP addresses.

Port	Protocol	Purpose	Ingress private IP	Ingress public IP	Egress to public internet
22	TCP	ssh connectivity for Admin	#		
443	TCP	<p>Ingress</p> <p>Desktop sensor and business analyst connectivity over HTTPS (TLS 1.2)</p> <p>Egress</p> <p>PEG sends redacted data to Process Discovery.</p> <p>Also used to pull down PEG installer, updates, and so on from our repositories</p> <p>Sensor connects directly to Process Discovery cloud to get configuration information only. No collected data is sent directly from the sensor to the Process Discovery cloud.</p>	#		#
80	TCP	Used for redirection from http to HTTPS (443)	#		

DNS requirements

You will provide PEG with an apex domain name that you want to use (for example, example.com). Based on that, PEG will inform you about the DNS sub domain records that you must create.

Install PEG

Review the checklist before you begin installing PEG in your environment.

Ensure that PEG VM is deployed and that the network connectivity is set up.

PEG installation checklist

The details for each of these steps follow later.

1. Create certificates.
2. Create DNS entries and deploy PEG VM.
3. Configure PEG to work with a proxy (if you require a proxy).
4. Configure PEG by following the regular set of steps.
5. Validate that PEG is running.

Note: Through the installation process, replace the values within angle brackets with your actual values and remove the angle brackets. For example:

- `<apex domain>` might be replaced by `example.com`.
- `<UID>` might be replaced by `123456ab-789c-12de`.

Create certificates

Create certificates as part of installing PEG.

You can create certificates by using one of two options.

- Option 1: PEG generates keys and CSRs.
- Option 2: Create your own keys and certificates.

In both cases, you will need the following:

- Unique ID (UID): Each PEG VM you run must have a unique id. You can define the UID to be anything you want as long as it meets the following criteria:
 - Less than or equal to 18 characters in length
 - Contains only letters from a to z, numbers from 0 to 9 and/or hyphens
 - Must not begin or end with a hyphen
 - Must not contain consecutive hyphens
- **Tip:** To easily create a UID, take the last 18 characters of a GUID generated from an online GUID generator.

- The apex domain that you want to use for the PEG DNS names (for example, `example.com`)

Option 1: PEG generates keys and CSRs

You can use PEG to generate the keys and CSRs for you. To do that, perform the following:

1. Log in to PEG through ssh.

If you do not log in as user named `peguser`, then ensure that you switch to the `peguser` per this command before performing these steps.

```
sudo su - peguser
```

2. If you already have a unique ID (UID) by Process Discovery, run the following command: `echo "<UID>" > ~/.kudzu/appliance.txt`, where UID is the unique ID that you were provided. If you do not have a UID, the next few steps will generate one for you.
3. Run `cd peg && ./peg_start.sh`.
4. Select **Cluster management**.

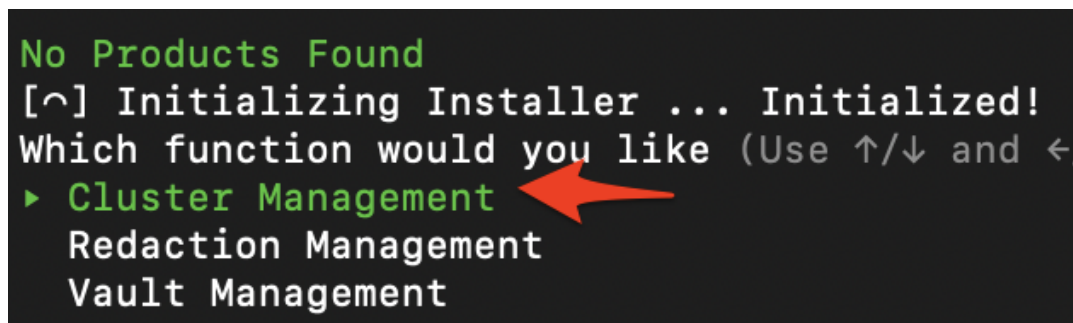

```
No Products Found
[~] Initializing Installer ... Initialized!
Which function would you like (Use ^/v and <
▶ Cluster Management
  Redaction Management
  Vault Management
```

5. Select **Generate Certificate Requests**.

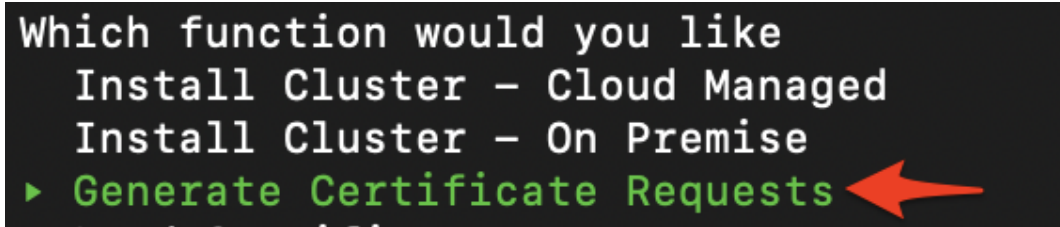

6. Fill out the options that follow.
7. Exit the menu.
8. Please record the UID value that you see in the output of this command: `cat ~/.kudzu/appliance.txt`
The CSRs are located in `~/peg/csr`.
9. Create certificates from those CSRs per [Common Tasks - Creating the certificates](#) below.

Option 2 - Create your own keys and certificates

Learn how to create keys and certificates before you deploy PEG.

Keys and certificates must be in Base64 PEM format (called openssl or PKCS #8 for the key format in some systems). Create certificates according to [Common Tasks - Creating the certificates](#). Keys must not be password protected. Also, ensure that your keys match the file names in the **Key File Name** column of, [Table 3: Mapping of domain names to certificate file names](#).

Common Tasks - Creating the certificates

Learn how to create Base64 PEM certificates.

When you create the certificates, create six server Base64 PEM certificates (called openssl format in some systems), with domain names and file names mapped as follows, where the UID is provided to you by Process Discovery and the apex domain is your apex domain that you will use for PEG. Each certificate you create must just contain the leaf certificate and not the full chain.

Table 3: Mapping of domain names to certificate file names

Domain	Cert file name	Key file name (Required only if you created your own keys)
analytics-fiq-<UID>.<apex domain>	analytics-cert.pem	analytics-key.pem
proxy-fiq-<UID>.<apex domain>	proxy-cert.pem	proxy-key.pem
storage-fiq-<UID>.<apex domain>	storage-cert.pem	storage-key.pem
st-fiq-<UID>.<apex domain>	st-cert.pem	st-key.pem
dlp-fiq-<UID>.<apex domain>	dlp-cert.pem	dlp-key.pem
es-fiq-<UID>.<apex domain>	es-cert.pem	es-key.pem
klite-fiq-<UID>.<apex domain>	klite-cert.pem	klite-key.pem

Note: You can create one certificate with all of the SANs. You can also create just one key if you create keys if you want. However, you will still need to make sure there are seven copies of that certificate and

seven copies of that key (if you created keys) named as indicated previously. Do not create a wildcard certificate.

Create DNS entries and deploy PEG VM

Create DNS entries and deploy PEG VM as part of installing PEG.

Create DNS entries where each domain mentioned in [Table 3: Mapping of domain names to certificate file names](#), points to the PEG VM (PEG must have a static IP or a static domain name).

Configure PEG to work with a proxy

Configure PEG to use a proxy for outbound traffic if required.

Deploy PEG VM

Note: When you deploy the PEG VM, ensure that it has a static IP or at least a static domain name. To configure the VM static IP address, use the mechanism provided by your VPC provider.

1. Log in to the PEG VM through ssh.
2. Copy your proxy certificate, if one is required, to the following locations:

Note: The proxy file name must have a .crt extension and must be in the Base64 PEM format (called openssl format in some systems).

- ```
sudo cp <your proxy certificate.crt> /usr/local/share/ca-certificates/
```
- ```
sudo cp <your proxy certificate.crt> /peg_v/certs/
```

3. For the OS to load the certificate, run the following command: `sudo update-ca-certificates`
4. Add the following to the `/etc/environment` file (including the username and password if required) using the `http_proxy` and `https_proxy` values for your environment.

Note: Although this is not a requirement, the `https_proxy` value is often the same as the `http_proxy`, with the protocol being HTTP for both.

Enter the URL in the following format: `<your http/https proxy url>` Enter the username and password if required. `http://username:password@host:port/`

```
---
```

```
http_proxy=<your http proxy url> https_proxy=<your https proxy url>
```

```
no_proxy="localhost,::1,127.0.0.0/8,0.0.0.0,10.0.0.0/8,192.168.0.0/16,172.16.0.0/12"
```

5. Log out of your ssh session and then log back in.
This allows the proxy settings to be picked up by the operating system.

6. Edit the following values as follows in `~/peg/text_pipeline/values-gpu.yaml`. (These values are at the bottom of the file).

Enter the URL in the following format: `<your https proxy url>`. Enter the username and password if required. <http://username:password@host:port/>

If you do not use a certificate for the proxy, `fluentd_cert_path` should be left as follows: ""

```
---
```

```
has_fluentd_proxy: "true"
```

```
fluentd_cert_path: "/peg_v/certs/<your proxy.crt>"
```

```
https_proxy: "<your https proxy url>"
```

```
---
```

7. If you performed the steps in [Set up and configure PEG](#) before performing the proxy steps outlined in the previous steps, perform the following steps:

- Run `cd peg && ./peg_start.sh .`
- Select **Cluster Management** and press Enter, and then select **Load Certificates** and press Enter again.

```
No Products Found
[~] Initializing Installer ... Initialized!
Which function would you like (Use ↑/↓ and
▶ Cluster Management
```

```
Which function would you like
  Install Cluster – Cloud Managed
  Install Cluster – On Premise
  Generate Certificate Requests
▶ Load Certificates
```

Set up and configure PEG

Configure PEG for your environment.

If you require a proxy configuration, first perform the steps outlined in [Configure PEG to work with a proxy](#).

Ensure the following:

- Unique ID (UID) provided by Process Discovery
- Platform endpoint provided by Process Discovery

- PEG-managed certificates: the apex domain that you want to use for the PEG DNS names (for example, example.com)

1. Log in to PEG through ssh.

Note: If you do not log in as user named peguser, then ensure that you switch to the peguser before performing these steps: `sudo su - peguser`.

2. Run the following commands:

```
echo "<apex domain>" > ~/.kudzu/apex_domain.txt
```

```
"<UID>" > ~/.kudzu/appliance.txt
```

```
echo "127.0.0.1" > ~/.kudzu/external_ip.txt
```

```
echo "CSRs Generated" > ~/.kudzu/csr_log.txt
```

3. Modify the existing values in `~/peg/text_pipeline/values-gpu.yaml` as seen here. Do not include a slash at the end of the URL.

```
external_fluentd_url: "https://<FortressIQ provided platform endpoint>"
```

```
external_fluentd_port: "443"
```

4. Confirm that the PEG VM can reach the Process Discovery platform by running the following: `curl https://<FortressIQ provided platform endpoint>`

The following message is displayed:

```
400 Bad Request
```

```
'json' or 'msgpack' parameter is required.
```

Although that result is an error response, it is expected as the curl is not sending a well-formed message. The response confirms that the server received the request and responded.

5. Copy the PEG certificates that you created to `/peg_v/certs/` directory.

Ensure that they are named according to the certificate file names in [Table 3: Mapping of domain names to certificate file names](#).

6. If you also created your own keys, copy the PEG keys that you created to the `/peg_v/keys/` directory. Ensure that the keys are not password protected. Also, ensure that they are named according to the certificate file names in Table 1.

If you did not create your own keys, the PEG-generated keys are automatically included by PEG.

7. Run `~/peg/scripts/validatecerts.sh`.

To confirm that the certificates are valid, continue only if the script passes with "All checks passed!"

8. Reboot to ensure that any updated drivers are applied correctly: `sudo reboot now`

9. Run `cd ~/peg && ./peg_start.sh`.

10. Select **Redaction Management** and press Enter, and then select **Install module** and press Enter again.

```
No Products Found
[~] Initializing Installer ... Initialized!
Which function would you like
  Cluster Management
▶ Redaction Management
```

```
Which function would you like
▶ Install Module
  System Monitoring
```

Note: Do NOT install cluster.

11. Select **Vault Management** and press Enter, and then select **System Monitoring** and press Enter again.

```
No Products Found
[~] Initializing Installer ... Initialized!
Which function would you like
  Cluster Management
  Redaction Management
▶ Vault Management
```

```
Which function would you like
▶ Install Module
  System Monitoring
```

12. Select **Storage Management** and press Enter, and then select **Initialize Storage** and press Enter again.

```
No Products Found
[~] Initializing Installer ... Initialized!
Which function would you like
  Cluster Management
  Redaction Management
  Vault Management
▶ Storage Management
```

```
Which function would you like?
▶ Initialize Storage
  System Monitoring
```

13. Select **Cluster Management** and press Enter, and then select **Load Certificates** and press Enter again.

```
No Products Found
[~] Initializing Installer ... Initialized!
Which function would you like (Use ↑/↓ and
▶ Cluster Management
```

```
Which function would you like
  Install Cluster – Cloud Managed
  Install Cluster – On Premise
  Generate Certificate Requests
▶ Load Certificates
```

14. Change the analytics page password. Run the following and enter your password. `cd ~/peg/scripts/ && ./change_elastic_password.rb`

Note: The username for logging in to `https://analytics-fiq-<UID>.<apex domain>` is *admin*.

15. Add storage users as needed . You will need at least one user with at least read access to confirm that PEG works. These are the users that can review the redaction of the images. `~/peg/scripts/add-storage-user.rb` .

This script also gives you the option to create users that can edit the pass-and-block (allow/deny) list.

Note: The username that you create corresponds to the **Access Key** in the login page for `https://storage-fiq-<UID>.<apex domain>`. The password corresponds to the **Secret Key**.

Configuration is now complete.

Validate PEG is running

Verify whether your PEG configuration is operating correctly in review mode.

To confirm that PEG is running as expected, perform the following steps:

1. In a browser, go to `https://storage-fiq-<UID>.<apex domain>`.
You will see a screen like this: ("Access Key" = "your username" and secret key = "your password")

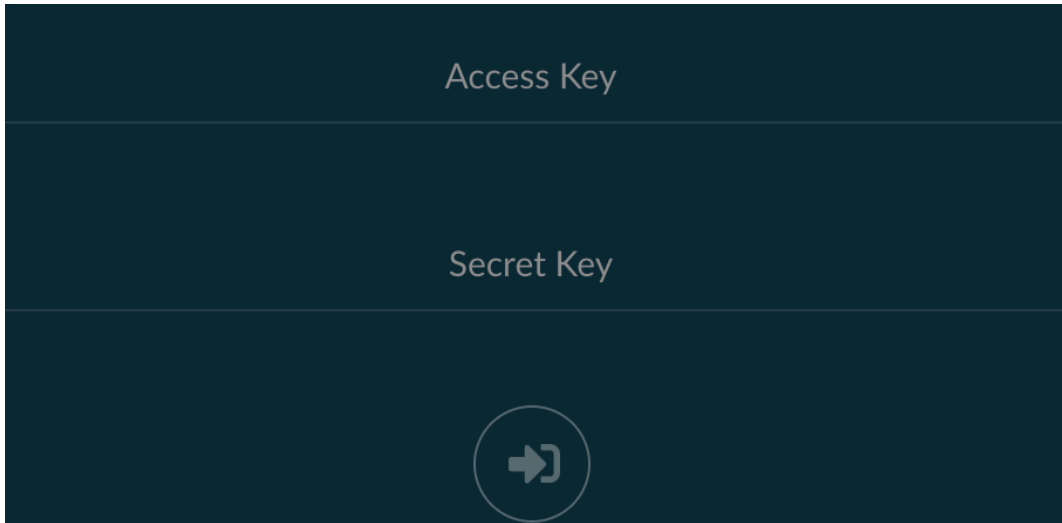

2. Log in to `https://storage-fiq-<UID>.<apex domain>` using a user you created in the configuration steps previously (by running `~/peg/scripts/add-storage-user.rb` on the VM).
3. After you log in, you will see these folders on the left. If you do not, run the "Storage Management" "initialize storage" steps in the configuration steps. If you still do not see them after that, contact .

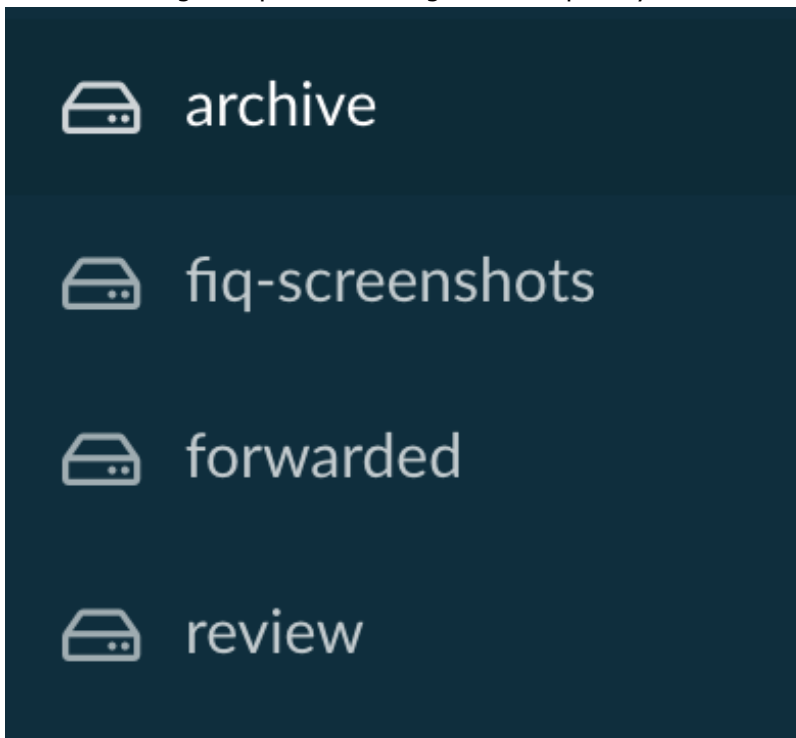

4. In a browser, go to the analytics URL: `https://analytics-fiq-<UID>.<apex domain>`
You will see a screen similar to the following:

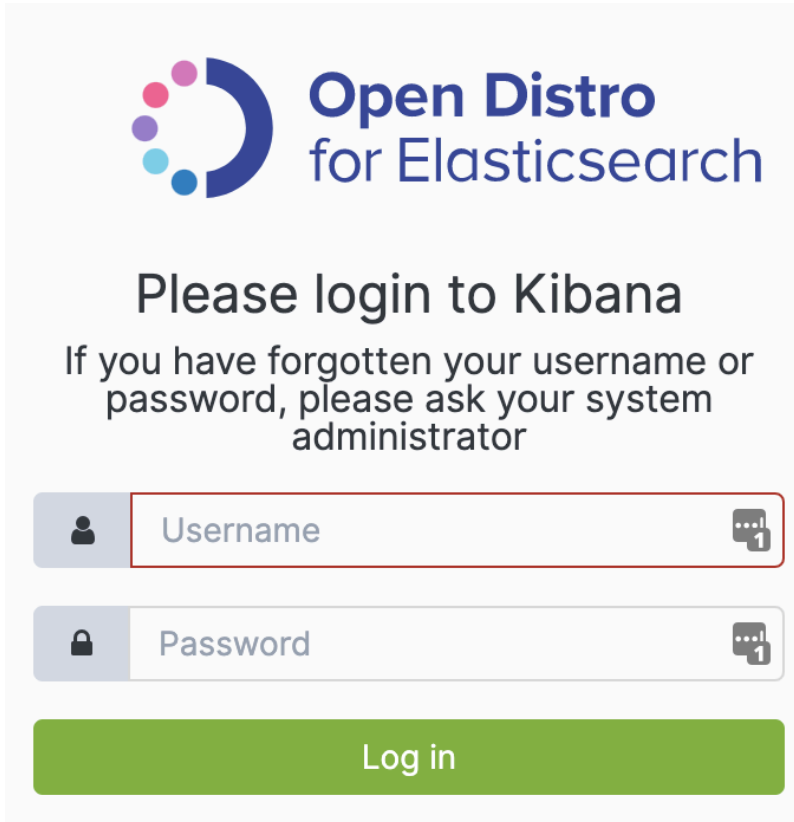

Open Distro
for Elasticsearch

Please login to Kibana

If you have forgotten your username or password, please ask your system administrator

Username

Password

Log in

If you do, go to the next step.

5. In a browser, go to `https://dlp-fiq-<UID>.<apex domain>`.
You will just see a blank page. If you encounter an error or it times out, then there is something wrong.
6. Install the Neo Sensor on a Windows machine. Open a web page, such as <https://www.fortressiq.com> and then click the page several times.
7. After 10 minutes (which is the approximate duration for review images to be generated), log in to `https://storage-fiq-<UID>.<apex domain>`. Log in with one of the storage users that you created previously in the configuration steps.
Note on the folders on the left side:
- **fiq-screenshots**: Shows the screenshot that PEG received
 - **forwarded**: Shows what the screenshot looks like if it is forwarded. This is populated regardless of whether it was actually forwarded or not.
 - **review**: PEG adds annotation to the images here to show more clearly what will be redacted. PEG includes a blue rectangle around where the redacted word previously existed and includes the text it found above the rectangle.
8. Click the **fiq-screenshots** folder on the left.
9. Download some of the images from this folder and confirm that they look like the results of your test.
10. Click on the **review** folder.

11. Download some of the images from this folder and confirm that they appear to be from your test. If PEG finds words that must be redacted, PEG includes a blue rectangle around where the redacted word existed and it includes the text it found above the rectangle, as follows.



If this looks as expected, you have validated that PEG is working in review mode.

PEG modes overview

Redacted images are processed in one of two modes, the review mode and the forwarding mode.

PEG can run in one of two modes:

- Review mode
- Forwarding mode

Review mode

This is the default mode for PEG when it runs for the first time. In this mode, you can review the redacted images, make changes to the pass-and-block lists, and so on, without PEG forwarding data to the Process Discovery cloud.

Forwarding mode

When you are comfortable with the results of your review of the images, you can enable the forwarding mode. After that, PEG will redact sensitive data from newly incoming images and send the redacted data to the Process Discovery platform. (Existing images from review mode will not be forwarded.)

Switch between modes

Change PEG to the forwarding mode and then back to the review mode.

By default, PEG initially starts in the review mode.

1. To switch to the forwarding mode:

- a) Edit the `~/peg/text_pipeline/values-gpu.yaml` file. At the end of the file, change the `forward_to_fluentd` value to `true` and save the changes.
`forward_to_fluentd: "true"`
- b) Push the change to PEG by running the following from any folder:

```
source ~/peg/scripts/vars.sh
```

```
kubectl delete cronjob.batch/text-pipeline-masking-masking-cron -n text-pipeline
```

```
kubectl get pods --output=jsonpath={.items..metadata.name} -n text-pipeline -o=name | grep cron | xargs -n1 kubectl delete --grace-period=0 --force -n text-pipeline
```

```
helm upgrade text-pipeline ${text_pipeline_dir} -f ${values_file_t} --namespace text-pipeline --set ocr.name=st-fiq-$new_gen_uuid.$apex_domain --set masking.name=dlp-fiq-$new_gen_uuid.$apex_domain
```

2. To switch back to the review mode:

- a) Edit the `~/peg/text_pipeline/values-gpu.yaml` file. At the end of the file, change the `forward_to_fluentd` value to `false` and save the changes.
`forward_to_fluentd: "false"`
- b) Push the change to PEG by running the following from any folder:

```
source ~/peg/scripts/vars.sh
```

```
kubectl delete cronjob.batch/text-pipeline-masking-masking-cron -n text-pipeline
```

```
kubectl get pods --output=jsonpath={.items..metadata.name} -n text-pipeline -o=name | grep cron | xargs -n1 kubectl delete --grace-period=0 --force -n text-pipeline
```

```
helm upgrade text-pipeline ${text_pipeline_dir} -f ${values_file_t} --namespace text-pipeline --set ocr.name=st-fiq-$new_gen_uuid.$apex_domain --set masking.name=dlp-fiq-$new_gen_uuid.$apex_domain
```

Determining content for redaction

PEG redacts words for forwarding based on the pass and block lists.

PEG determines the words that must be redacted base on two lists:

- The pass list

- The block list

The pass list

PEG comes with a built-in pass list. This list is based on our experience with customers. It contains all the words that PEG will not redact. Only words in the pass list will be included in images and other data sent to the platform. Words not on the pass list will be redacted.

The block list

The block list is a list of words that PEG will redact. PEG redacts words based on this list first before it processes the pass list. The block list is useful in situations where you know words exist on the pass list that you want redacted, but you do not want to have to modify the pass list. For example, a common use case is that some people's names are also everyday words that appear on the pass list by default. You can create a block list of all of the names of your employees or common names in various countries, which can be obtained from the Internet.

Modify the pass and block lists

Modify the pass list or the block list in the **dictionaries** folder.

To modify the pass list or the block list, perform the following steps:

1. Log in to <https://storage-fiq-UID.<apex domain>> as a user who has access to edit the pass and block lists.
2. On the left navigation menu, select the **dictionaries** folder.

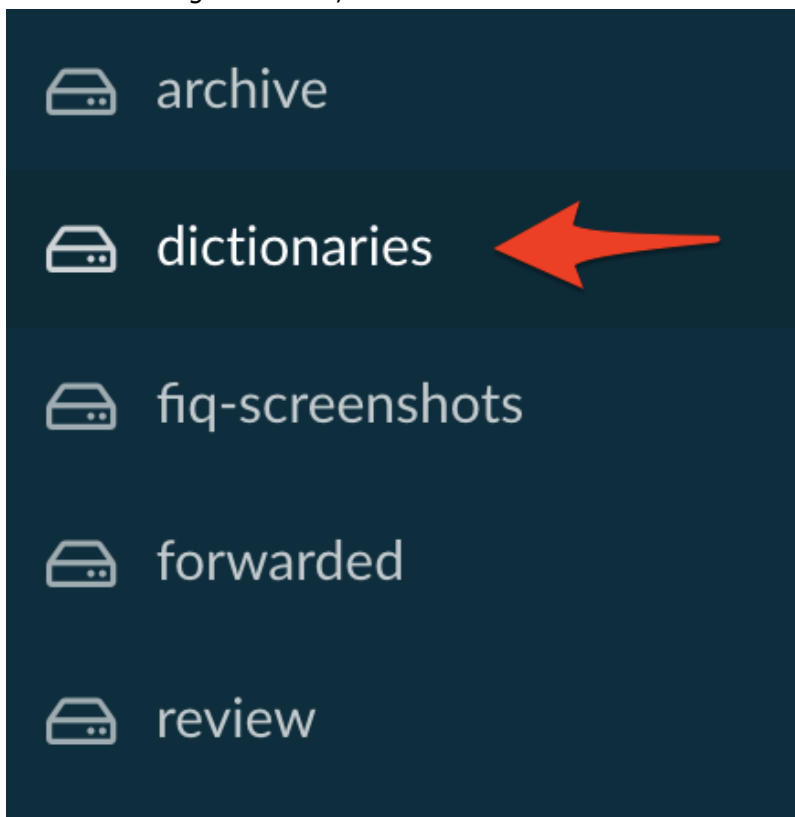

- In the dictionaries folder, you will see the **block-list.txt** and **pass-list.txt** files as follows.

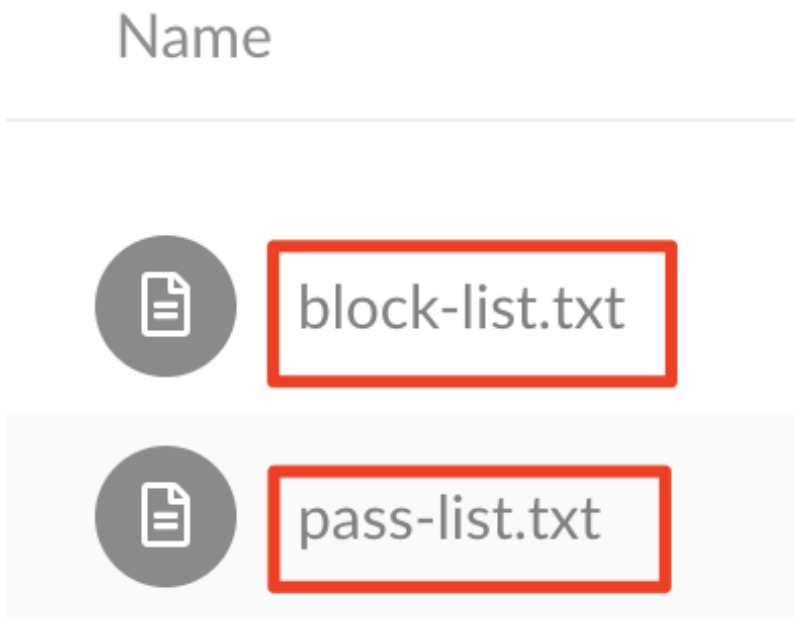

- Select the files that you want to edit and download them.

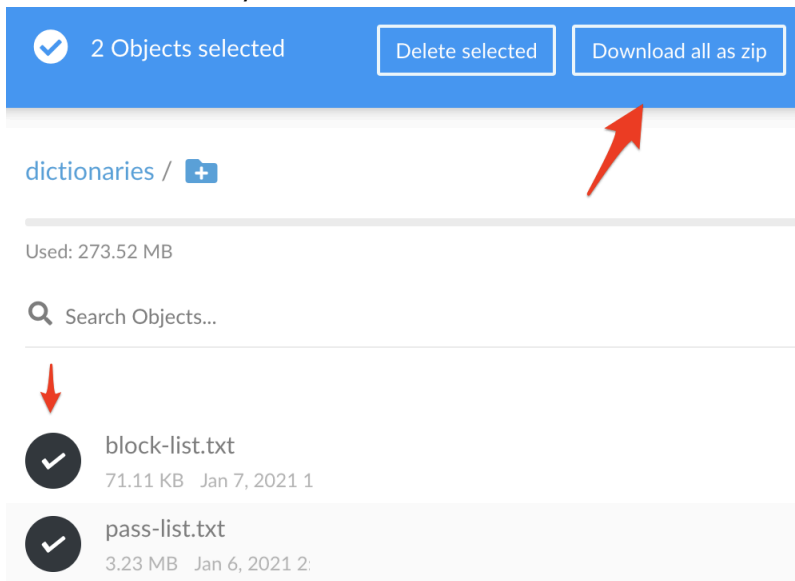

- Edit the list that you want to edit by using any text editor. Ensure that each word that you add to either list is followed by space and the number 1.
account 1
customer 1
user 1

Note: Use all lowercase letters for all the words.

6. Upload the modified files (named "pass-list.txt" or "block-list.txt" accordingly) to the same dictionaries folder. This will overwrite the existing files and apply your changes. The upload button is at the bottom-right corner of the page. Click plus (+) sign and then the upload icon.

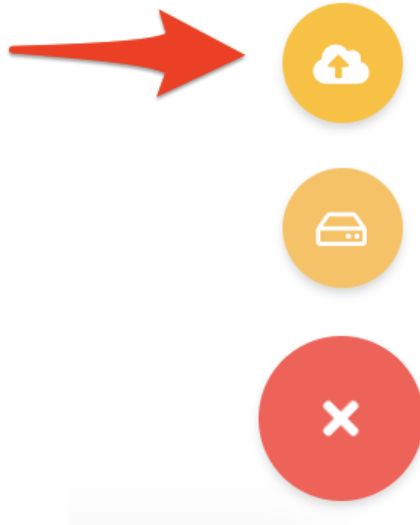

Manage redaction and forwarding settings from the UI

Manage your forwarding and redaction configurations, and export logs from a simplified UI interface.

You can use the Privacy Enhanced Gateway (PEG) UI interface to perform administrator tasks such as:

1. Update an existing pass list with new words or upload a new list.
2. Set the forwarding settings (true or false) to send redacted data to the platform.
3. Forward existing events that were previously recorded on a users machine.
4. Download and review PEG logs (including logs for the last 24 hours).



Redaction & Forwarding Panel

General Settings

1
Redaction List **Forwarding**

Forward to platform ⓘ 2 External platform URL ⓘ

Forward live records ⓘ Forward existing masked records ⓘ 3 UTC start date for forwarding ⓘ

Use Proxy ⓘ
 https proxy ⓘ

Manage redaction list configurations

Learn how to manage your redaction configurations from the Privacy Enhanced Gateway (PEG) UI and export logs, instead of running commands on the Command Line Interface (CLI).

To update your redaction settings from the UI, perform the following steps:

1. Log in to your PEG klite URL platform as an administrator: `https://klite-fiq-<UID>.<apex domain>`.
2. In the upper right-corner, navigate to **Admin > PEG configuration**.
3. In General Settings, select **Redaction List**.
4. In the **Pass List** section, select from the following options:

Option	Action
Upload new list document	Click to upload a new list of words. The words on this list are not redacted and are sent to the platform. Words are on this list typically do not contain sensitive, private information (such as credit cards numbers, phone numbers, names, and so on). Note: Any word that is not on the pass list is redacted.

Option	Action
<pass-list>.txt	<p>a. Click to edit the existing pass list. The list is saved in the Downloads folder.</p> <p>b. Open the file, add your changes, and save the file.</p> <p>c. Click Upload new list document to upload the document.</p> <p>A pop-up message appears notifying you that the pass list is updated successfully.</p> <p>Each line can only contain one word. A word can contain letters, numbers, and symbols, but no spaces. For words with numbers and symbols, those words will only be used for comparison if the Cleaning field is set to false. The words are case-insensitive. For more details about cleaning, see step 11.</p>
Text field	Enter the words in the text field to update the existing pass list followed by the Enter key. For example, to update the pass list to include a category (such as Support), enter Support in the text box followed by the Enter key.

5. Click **UPDATE** to save your changes for the pass list in the text field.
6. Click **CLEAR ALL** to clear your changes in the text field and start over.
7. In the **Block List** section, select from the following options:

Option	Action
Upload new list document	Click to upload a new list of words. The words are on this list are redacted and not sent to the platform.
<block-list>.txt	<p>a. Click to edit the existing block list. The list is saved in the Downloads folder.</p> <p>b. Open the file, add your changes, and save the file.</p> <p>c. Click Upload new list document to upload the document.</p> <p>A pop-up message appears notifying you that the block list is updated successfully.</p> <p>Each line can only contain one word. A word can contain letters, numbers, and symbols, but no spaces. For words with numbers and symbols, those words will only be used for comparison if the Cleaning field is set to false. The words are case-insensitive. For more details about cleaning, see step 11.</p>
Text field	Enter the words in the text field to update the existing block list followed by the Enter key.

8. Click **UPDATE** to save your changes for the block list in the text field.
9. Click **CLEAR ALL** to clear your changes in the text field and start over.
10. In the **Redaction Word Filter Setting** section for **Fuzzy Matching**, select **true** to allow Optical Character Recognition (OCR) some level of variation (fuzzy matching) to consider a word a match. By default, **Fuzzy Matching** is set to true and PEG does not require an exact match when comparing a word with a word on the pass for the block list. Select **false** to disable fuzzy matching.

Note: When reviewing the redaction levels, you might find some sensitive text (that is not on the allow list) displaying unexpectedly in the applications screenshots. In that case, select **false** to disable fuzzy matching to provide a preferable result.

For example, if OCR reads a word as kello. There is a chance that OCR might be right or wrong in how it reads the word kello. Kello is not in the pass or block list. Kello might be considered a close enough match to hello (with the idea that kello was just OCR misreading hello). So, if the word hello is in the pass list, then the word kello would also be allowed and not redacted.

11. In the **Cleaning** field, click the drop-down to select **true** to remove all non-alphabetic (anything not a letter in the alphabet) from a detected word before comparing it to the words in the dictionaries. Select **false** to allow numbers for cleaning. By default, cleaning is set to true.

Note: Cleaning defines whether non-alphabetic characters should be ignored when comparing a word with the dictionaries.

For example, there are category types (PURCH2A, PURCH2B, and PURCH2C) that are a mix of numbers and letters that appear in your application screens that should not be redacted. To ensure that PURCH2A, PURCH2B, and PURCH2C are not redacted, add the words to the allow list and disable cleaning. PEG will not remove the numbers from these words when comparing with the words on the allow list. Another example is if you have an account ID, such as SA31LE. If cleaning is set to true, then PEG removes the number 31 from SA31LE and compares the word, SALE with the words in the allow list. If SALE is in the allow list, then it is not redacted. However, if you set cleaning to false, cleaning compares SA31LE with the words on the allow list. Since SA31LE is not in the allow list, SA31LE is redacted.

12. Click **UPDATE** to save your changes.
A pop-up message appears notifying you that your changes are successfully deployed.
13. To export logs from the UI, click **Export Logs**.
The logs begin generating. After the logs have generated, click **Download Logs** to unzip the logs from the Downloads folder. The log files contain information about the system (including logs for the last 24 hours).

Manage forwarding configurations

Learn how to manage your forwarding configurations from the Privacy Enhanced Gateway (PEG) UI instead of running commands on the Command Line Interface (CLI).

To update your forwarding settings from the UI, perform the following steps:

1. Log in to your PEG klite URL platform as an administrator: `https://klite-fiq-<UID>.<apex domain>`.
2. In the upper right-corner, navigate to **Admin > PEG configuration**.
3. In General Settings, select **Forwarding**.
4. In the **Forward to platform** field, select **true** to forward redacted data platform, or select **false** to prevent sending forward redacted data to the platform.
By default, the **Forward to platform** field is set to false.

- 5.** In the **Port for forwarding** field, the default port number is 443.
We recommend that you leave the default port number as 443 unless you need to change it.
- 6.** In the **Forward live records** field, select **true** to forward the live events to the platform, or select **false** to prevent sending any events to the platform.
You can use this setting to forward new incoming events. It will not forward existing events that are masked. If you select **false**, the incoming events are redacted, but not sent to the platform.
- 7.** In the **Forward existing masked records** field, select **true** to forward existing events that were already recorded but have not been sent to the platform. Select **false** to prevent sending any existing events collected on your machine to the platform.
You use this field only to forward data that was previously collected. For example, you might have collected events for two weeks and forgot to send the events to the platform.
- 8.** In the **UTC start date for forwarding** field, enter the start date for the observed at date range. The observed at date range is when the Neo Sensor recorded the event on the machine. You must specify the range in the UTC time zone.
Based on the date range you enter, PEG forwards previously redacted events that were not already forwarded to the platform.
- 9.** In the **UTC end date for forwarding** field, enter the end date for the observed at date range.
- 10.** To use a proxy, click the **Use Proxy** checkbox.
- 11.** In the **https proxy** field, enter the proxy URL address to use.
If required, include the username and password in the URL: `http://username:password@host:port/`
- 12.** Click **Deploy**.

Manage disk space

Manage disk space by managing the duration for which images are kept in the review folder.

When the disk usage is over 90 percent, PEG stops processing new messages. To manage the setting in the review folder, perform the following steps:

- 1.** Add the following block of code to the end of the `~/peg/text_pipeline/values-gpu.yaml` file. (Alternatively, if an entry already exists, modify it.)

```
#Archive Info
review_retention_days: 365
```

The value that you include here will be the number of days for which PEG will keep an image in the review folder. Replace the number **365** with the number of days for which you want to retain review images. This will affect only the review images. The original images and the images in the forwarded folder will not be affected.

2. Push the change to PEG by running the following from any folder:

```
source ~/peg/scripts/vars.sh
```

```
kubectl delete cronjob.batch/text-pipeline-masking-masking-cron -n text-pipeline
```

```
kubectl get pods --output=jsonpath={.items..metadata.name} -n text-pipeline -o=name | grep cron | xargs -n1 kubectl delete --grace-period=0 --force -n text-pipeline
```

```
helm upgrade text-pipeline ${text_pipeline_dir} -f ${values_file_t} --namespace text-pipeline --set ocr.name=st-fiq-$new_gen_uuid.$apex_domain --set masking.name=dlp-fiq-$new_gen_uuid.$apex_domain
```

Renew and replace certificates and keys

In the customer-managed certificates deployment model (unlike in the PEG-managed certificates deployment model), certificates and keys that are about to expire are not renewed and replaced automatically, so you need to perform these tasks manually.

When your certificates are about to expire, you must perform the following tasks:

1. Create a new certificate. There are two options available. You can choose to have PEG create the new certificate signing request, or you can create your own certificates and keys.
2. Upload the new certificate.

Create a new certificate and key. Ensure that PEG creates the new certificate signing request.

If you want PEG to generate the new certificates and keys, perform the following steps:

1. Run `cd peg && ./peg_start.sh`.
2. Select **Cluster Management**.

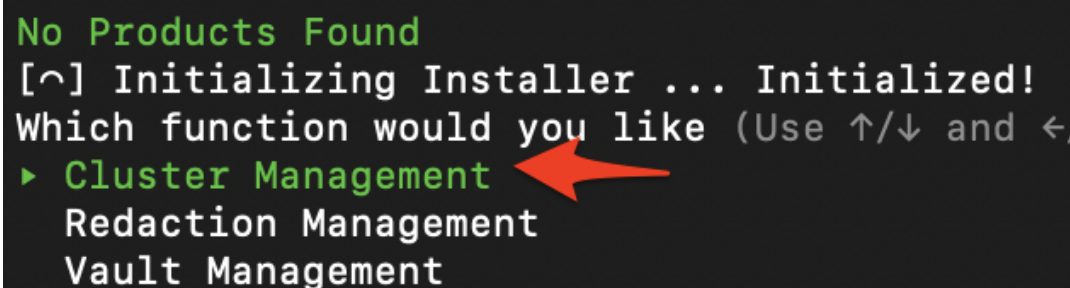

```
No Products Found
[^] Initializing Installer ... Initialized!
Which function would you like (Use ^/v and ^)
▶ Cluster Management
  Redaction Management
  Vault Management
```

3. Select **Generate Certificate Requests**.

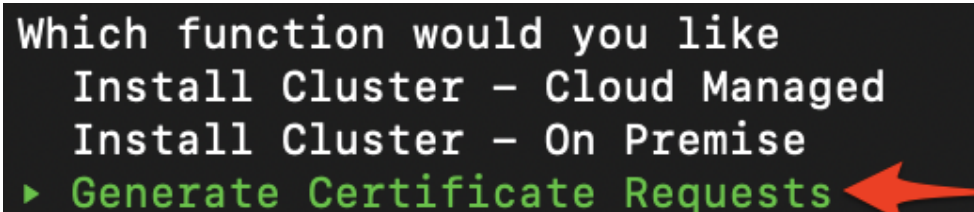

```
Which function would you like
  Install Cluster - Cloud Managed
  Install Cluster - On Premise
▶ Generate Certificate Requests
```

4. Fill out the options that follow.
5. Exit the menu.

6. The csrs are located in `~/peg/csr`.
7. Create certificates from CSRs that PEG generated. For more information, see [Create certificates](#).

Upload the new certificates

Upload the new PEG certificates.

1. Copy the PEG certificates that you created to the `/peg_v/certs/` directory. Ensure that they are named according to the certificate file names in [Table 3: Mapping of domain names to certificate file names](#).
2. If you also created your own keys, then copy the PEG keys that you created to the `/peg_v/keys/` directory. Ensure that the keys are not password-protected. Also, ensure that they are named according to the certificate file names in [Table 3: Mapping of domain names to certificate file names](#). If you did not create your own keys, then the PEG-generated keys are included by PEG.
3. Run `~/peg/scripts/validatecerts.sh`. To confirm that the certificates are valid, continue only if the script displays the following: All checks passed!
4. Run the following command on PEG so it loads the latest certificates:

```
kubectl rollout restart deployment.apps/traefik -n kube-system
```

Create image viewer user in analytics portal

Learn how to create an image viewer user and add the user to the analytics portal. Use the image viewer to find, view, and compare images in PEG.

To create a user in image viewer user and add a user to the **klite_read_only** role in the analytics portal, perform the following steps:

Note: The image viewer uses the same logins as those used in the PEG analytics portal.

1. In a browser, go to the analytics portal: `https://analytics-fiq-<UID>.<apex domain>`
2. Enter your admin username and password. Your admin password is the same password as the elastic password you set when you configured PEG.
3. Go to **Security > Internal users**.
4. Click **Create internal users**.
5. In the **Create internal user** form, enter your username and password.
6. Click **Create**.
7. Go to **Security > Roles**.
8. In the search field, enter **klite_read_only**.
9. Click **klite_read_only**.
10. Select the **Mapped Users** tab, and click **Map Users**.
11. Select the users you want to map.
12. Click **Map**.

Users can now log in to the image viewer.

Configuring image viewer

Before you can use the image viewer, you must configure it.

The image viewer requires you to step up the user configuration for first-time users (or if you have to clear cookies you will have to configure it again).

If you are using PEG for the first time, perform the following steps to use the image viewer.

1. To open the image viewer application, enter the following address in a web browser: `https://klite-fiq-<UID>.<apex domain>`
2. In the **Configuration Settings** dialog box, click **Getting started**.
3. Enter your klite username and password.
Enter the username and password that was created for new image viewers users. For more information, see [Create image viewer user in analytics portal](#).
4. For **Index Pattern**, from the drop-down list, select **event_logs**.
5. For **Image Key Field**, from the drop-down list, select **screenshot_key**.
6. Click **Continue**.
You can now use the image viewer.

Using image viewer

Use the image viewer to view the images in buckets that are used frequently.

Before you begin, configure the settings as mentioned in [Configuring image viewer](#). You can use the image viewer to see images in the following buckets:

- **fiq-screenshots**: This includes the screenshot that PEG received.
- **forwarded**: This is what the screenshot looks like when it is forwarded. This is populated regardless of whether it is forwarded or not.
- **review**: This includes annotated images. PEG adds annotation to the images to clearly show what will be redacted. PEG puts a rectangle around where the redacted word previously existed and includes the text it found above the rectangle.

To review the images, perform the following steps:

Note: These steps show you the buckets that are used frequently, but you can change the selection as needed.

1. Log in to the image viewer.
The image viewer application is located at your PEG klite URL: `https://klite-fiq-<UID>.<apex domain>`
2. In Bucket 1, click the pencil icon to select the bucket you want.
For example, select **fiq-screenshots**.
3. In Bucket 2, click the pencil icon to select the bucket you want.
4. Select the timeframe within which you want to review the data.
For example, select **Last 15 days**.

5. Click Refresh.

If images were sent during the selected timeframe, you can see them now. The Bucket 1 version of the screenshot is on the left. The Bucket 2 version of the screenshot is on the right. You can move the bar in the middle to the left and the right to see the difference between the two.

Note: If you just sent in an image, it might not be displayed for 10 minutes.

- 6. Click Filters** to filter the data to only look at a specific set of screenshots.
For example, click **Add filter** to see all notepad screenshots for a specific user.
- 7. Click Configure Field** to select what fields you want to see above the screenshot.
For example, select the **Application**, **Screenshot_key**, and **Title** fields. The image viewer displays these fields above the screenshot.
- 8.** To export images, select the Export image icon located in the top-right corner of the page.
The **Export Images** window appears.
- 9.** Select the image range from 1 to 10 using the modal bar.
- 10.** Select the slot from the drop-down list.
For example, select slot 1.
- 11.** For **Export Option**, choose from the **Selected Range** option or the **Random** option.
- 12.** Click **Download**.

Neo Sensor application

Use the Neo Sensor to record activity on a user's machine to determine what business processes are candidates for automation.

The Automation Anywhere Process Discovery Neo Sensor is a lightweight application that integrates to the machines' video card to record user activities. The sensor operates in both thick and thin client applications, and across multiple monitors. You can configure which applications and domains can be used to capture activity.

System requirements

The following system requirements are supported for installing the Neo Sensor:

- Operating Systems
 - Physical Desktop: Windows 10, Windows 11
 - Citrix VDI: Windows Server 2016, Windows Server 2019
- Memory: 4 GB RAM
- Required software packages: .NET 4.7 or later

Installing Neo Sensor

Learn how to install Neo Sensor on your machine.

Ensure that you install Neo Sensor as a user on your machine, and not on a system level. Any user with privileges to run an MSI installer, and write permissions to their own user folder, can perform the installation. If you are using Microsoft SCCM or other software deployment solutions to deploy the MSI, make sure it is deployed as the user you are deploying it to.

- 1.** Obtain the msi package from Automation Anywhere.

2. Unzip the msi file if you have received it as a zip file.
3. Double-click the Neo2 MSI to launch the Installation Wizard.
4. Click **Next**.
5. Click **Next** to continue with your organization, endpoint, and port information.
Your customer information is already populated in the fields provided.
6. Click **Install** on the Ready to Install Neo2 window to begin the installation.
7. Click **Finish** to exit the Setup Wizard.
The installation is complete and the Neo Sensor is now running. A Neo2 shortcut displays on your desktop and a pop-up message displays informing you that Neo Sensor has started recording. The Process Discovery icon is displays in your system tray.
8. To quit the recording, right-click the Process Discovery icon in the system tray and select **Quit**.
A message displays that the recording has stopped. To restart the recording, double-click the Process Discovery icon Neo2 shortcut on your desktop.

Note: Depending on how the Sensor is configured, the quit option might not be available.

Installing Neo Sensor in a VDI environment

Learn how to install the Neo Sensor in a Virtual Desktop Infrastructure (VDI) environment and create a portable package.

Many VDI environments do not allow msi installs that install as the user, especially if they are non-persistent desktops. If the msi installer does not work in your environment, you must create a portable installer on a machine with access to the Automation Anywhere Process Discovery platform.

1. Install the Neo Sensor using the MSI installer. For more details, see [Installing Neo Sensor](#).
Ensure that Neo Sensor is running. The Neo Sensor icon displays in the bottom right corner of the system tray.
2. Navigate to `C:\Users\\AppData\Local\Programs\Neo2` and copy the files that the Neo Sensor installer created in that folder to a different folder.
For example, you can name the folder Neo Sensor files.
3. In Windows Explorer, search in **Add or remove programs**.
4. Locate the Neo Sensor app and remove the program.
This removes the existing install folder and the registry settings.
5. Copy the Neo Sensor files that you put in a folder to any folder on the VDI server.
6. Create a startup script to start the Neo2.exe on login for users that will run the Neo Sensor.
By default, the Neo Sensor needs write access to the folder it is running from because that is where the Neo Sensor writes the logs and downloads the configuration from the platform. Since the Neo Sensor runs in the user space, users need write access to that folder. If you do not want users to have write access to that folder, you can specify a different writable folder to store the logs and the Neo Sensor configuration. For more details on storing the logs and sensor configuration to a writable folder, see [Modifying the log and configuration storage location](#).

Modifying the log and configuration storage location

Learn how to change the location of the logs and the Neo Sensor configuration storage folder to a folder that is writable to all users who have the Neo Sensor running on their machine.

1. Copy the `NeoRemoteConfig.json` file to the folder where you want to store it.

The `NeoRemoteConfig.json` file is one of the Neo Sensor files you should see in your portable installer folder. The folder you copy it to must be the same writable folder where you want to store the logs.

2. Set the log and config file location by specifying the absolute path to the new folder in the `Path.config` file. In the folder with the `Neo2.exe`, there should be a `Path.config` file. For example, your `Path.config` file might contain: `z:\user_shared_storage\neo2_logs_and_config`.

You can assign it to an absolute path or can use one special reserved variable `{MyDocuments}`.

If you use the `{MyDocuments}` variable in the `Path.config` file, the logs will be stored in a folder named `Neo2` in the user's Documents folder.

Note: The Neo Sensor expects to see the `NeoRemoteConfig.json` in that folder.

Verify Neo Sensor Installation

Use the log files to verify that the Neo Sensor is installed correctly on your machine.

1. While the Neo Sensor is running and in recording mode, click a few times anywhere on your machine. Clicking a few times on your machine triggers the Neo Sensor to collect and send a screenshot to the Platform which results in entries in the Neo Sensor logs that you can use for validation. For more details on enabling the Neo Sensor in recording mode, see [Enable and disable the users recording](#).
2. From Windows Explorer, open the `C:\Users\\AppData\Local\Programs\Neo2` folder. If you changed the default location for the logs, then open the folder you have changed it to.
3. Locate this log file: `Neo_<machine name>_<userid>.log`
4. Double-click to open the log file.

If the Neo Sensor is working as expected, the following lines display as an example towards the bottom of the log file. If everything is correct, a job number displays, followed by **OK**.

```
2022-11-08 22:03:39.3775 TEST\testuser
com.FIQ.Neo2.Utility.Network.RawLogForwardingPostConsumer [INFO] Worker
id: 5b1bd418-2e19-4097-8ba7-31af6f22bd0a, queue size: 0, current job 152
OK, time elapsed: 0ms, type: fiq.win.keylog
```

```
2022-11-08 22:03:39.3775 TEST\testuser
com.FIQ.Neo2.Utility.Network.RawLogForwardingPostConsumer [INFO] Worker
id: 61849714-b916-43b7-8878-eced56dd1d65, queue size: 0, current job 151
OK, time elapsed: 5ms, type: fiq.win.screenshot
```

If the Neo Sensor is not working, you will see words such as **error** and **failed** in the log files output.

Note: If you experience issues, please contact Automation Anywhere for assistance.

```
2022-11-08 14:13:32.5720 TEST\testuser
com.FIQ.Neo2.Utility.Network.RawLogForwardingPostConsumer [ERROR]
Worker id: bbe8547d-3c67-473d-a328-e949a7c25a03, queue size: 13,
```

```
current job 2 failed, type: fiq.win.screenshot, time elapsed:
10ms, System.AggregateException: One or more errors occurred. ---
> Flurl.Http.FlurlHttpException: Call failed. An error occurred
while sending the request. POST https://test.example.com:443/
fiq.win.screenshot ---> System.Net.Http.HttpRequestException: An error
occurred while sending the request. ---> System.Net.WebException: The
remote name could not be resolved: 'test.example.com'
```

Enable and disable the users recording

Learn how to enable or disable the Observers recording in the platform.

1. Log in to into the Process Discovery platform.
2. Navigate to **Data > Observers**.
3. Identify the Observer you want to enable or disable the recording.
4. From the **Actions** column, click the drop-down arrow to **Start Recording** or **Stop Recording** for that Observer.

Preprocessing error messages

If you encounter any preprocessing errors, review the cause and perform the required action to resolve the error.

Note:

- From Automation 360 v.23, if an error occurs when you run a bot, a preprocessing or runtime error is shown. Note that preprocessing of child bots does not occur in sequence because these bots are referred in the parent bot and are sometimes in complex nested workflows. Therefore, the errors might be displayed in any sequence for these child bots. The parent bot cannot proceed further until all the errors in the child bots are resolved.
- The following scenarios are applicable only to Automation 360 v.21 or earlier releases. For v.22, Only the **Catch action** scenario is applicable, so review the probable cause.

Cause	Action required
A mismatch occurred and we did not find the expected variable data type.	Use an inline expression or a separate action to convert to the correct variable data type. Variables overview
A "\$" is being read as a variable but no such variable exists.	Use "\$\$" to escape the dollar sign and try again.
The bot is calling another bot, but we did not find the child bot at the specified location.	Check the path and try again.
We found a Catch action that is not contained by a Try action.	Ensure that each Catch action is contained by a Try action.
We found a Try action that does not contain a Catch action. Each Try action requires at least one Catch action inside it.	Ensure that each Try action contains a Catch action.

See also: [Pre-processing error while migrating bot from lower to higher version \(A-People login required\)](#).

Build advanced bots and packages

Learn how to build action packages and advanced bots that include custom features such as scripting, and API calls. Find recommendations on bot and action package design and reusability.

More resources

On the [Developer portal](#), find additional how-to tutorials on building advanced bots and packages.

Package SDK

Package SDK enables you in creating and uploading action packages to your Control Room.

The Automation Anywhere Package Development Kit provides detailed instructions for users to independently develop custom actions and upload the packages in their Control Room. The custom action are build in an IDE and are compiled to generate Java Archive (JAR) files. The JAR files are then uploaded to the Control Room which becomes available as actions under the **Action Panel**.

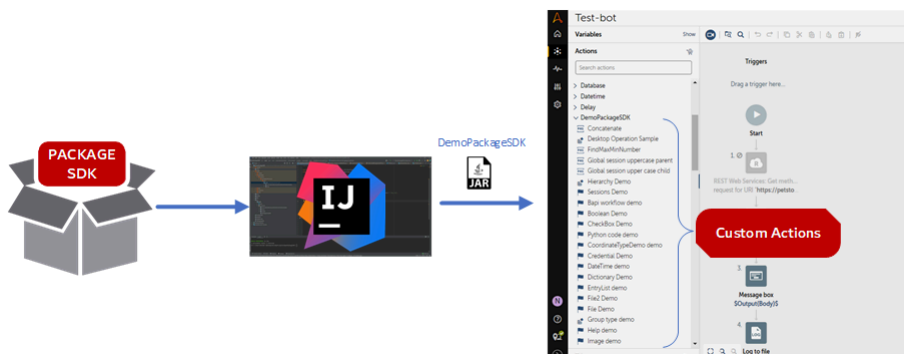

The Package SDK section includes sample codes and supporting files for Java developers to create and validate custom actions.

[November 2022, Release \(Automation 360 v.27\)](#)

[A360-package-sdk-2.6.1.zip](#)

[June 2022, Release \(Automation 360 v.25\)](#)

[A360-package-sdk-2.5.0.zip](#)

[December 2021, Release \(Automation 360 v.23\)](#)

[A360-package-sdk-2.4.1.zip](#)

[September 2021, Release \(Automation 360 v.22\)](#)

[A360-package-sdk-2.3.0.zip](#)

[June 2021, Release \(Automation 360 v.21\)](#)

[A2019-package-sdk-2.1.0.zip](#)

[April 2021, Release \(A2019.20\)](#)

[A2019-package-sdk-2.0.9.zip](#)

[February 2021, Release \(A2019.19\)](#)

[A2019-package-sdk-2.0.8.zip](#)

[January 2021, Release \(A2019.18\)](#)

[A2019-package-sdk-2.0.7.zip](#)

[November 2020, Release \(A2019.17\)](#)

[A2019-package-sdk-2.0.6.zip](#)

[September 2020, Release \(A2019.16\)](#)

[A2019-package-sdk-2.0.5.zip](#)

[August 2020, Release \(A2019.15\)](#)

[A2019-package-sdk-2.0.4.zip](#)

[July 2020, Release \(A2019.14\)](#)

[A2019-package-sdk-2.0.3.zip](#)

[May 2020, Release \(A2019.13\)](#)

[A2019-package-sdk-2.0.2.zip](#)

April 2020, Release (2019.12.1)	A2019-package-sdk-2.0.1.zip
April 2020, Release (2019.12)	A2019-package-sdk-2.0.0.zip
March 2020, Release (2019.11)	A2019-package-sdk-1.0.11.zip
February 2020, Release (A2019.10)	A2019.10-package-sdk-1.0.0.zip
January 2020, Release (A2019.09)	<ul style="list-style-type: none"> • SDK Demo Package: A2019.09-packageSDK-1.0.0.zip • Documentation: A2019.09-package-annotations-javadoc.zip
November 2019 Release (A2019.08)	<ul style="list-style-type: none"> • SDK Demo Package: A2019.08-packageSDK-1.0.0.zip • Documentation: A2019.08-package-annotqtions-javadoc.zip
October 2019 Release (A2019.07)	<ul style="list-style-type: none"> • SDK Demo Package: A2019.07-Package-Sdk-1.0.0.zip • Documentation: A2019.07-package-annotations-javadoc.zip

For detailed release notes for the SDK Packages, see [Automation 360 Package SDK Release Notes](#).

Click a title to read details about each task in the process.

Set up the Java project	Set up an integrated development environment (IDE) for Java, including Automation Anywhere custom annotations to develop an action package that you can upload to your Control Room.
Standard coding practices and guidelines for developing packages	This topic covers standard coding practices and guidelines that help to ensure the development of high quality packages.
Develop a sample package	Develop your own package and upload it to an Control Room to provide custom actions for bots.
How to examples	This section contains code examples and explanations about how to code some basic bot capabilities.
Annotations	This section provides reference information about the annotations used to create Automation Anywhere packages.
Build and test a demo package and bot	This practical how to section demonstrates that creating, changing, and managing packages allow you to customize actions and efficiently manage packages for all Control Room users.
Build and test a custom package	Use IntelliJ to build a custom package and use Automation 360 actions to test the package.

Related reference

[Automation 360 Package SDK Release Notes](#)

Review the new, changed, fixed, and deprecated features, and security fixes, known issues, and limitations for the Automation 360 (formerly Enterprise A2019) Package SDK.

Set up the Java project

Set up an integrated development environment (IDE) for Java, including Automation Anywhere custom annotations to develop an action package that you can upload to your Control Room.

A working knowledge of Java and Gradle is required in order to successfully build an action package. You require the following software and file:

- Java Developer Kit (JDK) 11
- Java IDE
 - [Eclipse](#)
 - [Community edition of IntelliJ](#)
- Gradle plug-in v.5.*.* in the IDE
- Automation Anywhere Bot Agent installed and connected to your Control Room **Download and extract a zip file**

Download and extract the zip file for the release you want:

<i>November 2022, Release (Automation 360 v.27)</i>	<i>A360-package-sdk-2.6.1.zip</i>
<i>June 2022, Release (Automation 360 v.25)</i>	<i>A360-package-sdk-2.5.0.zip</i>
<i>December 2021, Release (Automation 360 v.23)</i>	<i>A360-package-sdk-2.4.1.zip</i>
<i>September 2021, Release (Automation 360 v.22)</i>	<i>A360-package-sdk-2.3.0.zip</i>
<i>June 2021, Release (Automation 360 v.21)</i>	<i>A2019-package-sdk-2.1.0.zip</i>
<i>April 2021, Release (A2019.20)</i>	<i>A2019-package-sdk-2.0.9.zip</i>
<i>February 2021, Release (A2019.19)</i>	<i>A2019-package-sdk-2.0.8.zip</i>
<i>January 2021, Release (A2019.18)</i>	<i>A2019-package-sdk-2.0.7.zip</i>
<i>November 2020, Release (A2019.17)</i>	<i>A2019-package-sdk-2.0.6.zip</i>
<i>September 2020, Release (A2019.16)</i>	<i>A2019-package-sdk-2.0.5.zip</i>
<i>August 2020, Release (A2019.15)</i>	<i>A2019-package-sdk-2.0.4.zip</i>
<i>July 2020, Release (A2019.14)</i>	<i>A2019-package-sdk-2.0.3.zip</i>
<i>May 2020, Release (A2019.13)</i>	<i>A2019-package-sdk-2.0.2.zip</i>
<i>April 2020, Release (2019.12.1)</i>	<i>A2019-package-sdk-2.0.1.zip</i>
<i>April 2020, Release (2019.12)</i>	<i>A2019-package-sdk-2.0.0.zip</i>
<i>March 2020, Release (2019.11)</i>	<i>A2019-package-sdk-1.0.11.zip</i>
<i>February 2020, Release (A2019.10)</i>	<i>A2019.10-package-sdk-1.0.0.zip</i>
<i>January 2020, Release (A2019.09)</i>	<ul style="list-style-type: none"> • SDK Demo Package: <i>A2019.09-packageSDK-1.0.0.zip</i> • Documentation: <i>A2019.09-package-annotations-javadoc.zip</i>

November 2019 Release (A2019.08)

- SDK Demo Package: [A2019.08-packageSDK-1.0.0.zip](#)
- Documentation: [A2019.08-package-annotations-javadoc.zip](#)

October 2019 Release (A2019.07)

- SDK Demo Package: [A2019.07-Package-Sdk-1.0.0.zip](#)
- Documentation: [A2019.07-package-annotations-javadoc.zip](#)

Configure the build files, compile the JAR file, add the package to your Control Room, and then build a bot to test your package. [Build and test a demo package and bot.](#)

Related concepts[Standard coding practices and guidelines for developing packages](#)

This topic covers standard coding practices and guidelines that help to ensure the development of high quality packages.

[How to examples](#)

This section contains code examples and explanations about how to code some basic bot capabilities.

[Annotations](#)

This section provides reference information about the annotations used to create Automation Anywhere packages.

[Build and test a demo package and bot](#)

This practical how to section demonstrates that creating, changing, and managing packages allow you to customize actions and efficiently manage packages for all Control Room users.

Related tasks[Develop a sample package](#)

Develop your own package and upload it to an Control Room to provide custom actions for bots.

Standard coding practices and guidelines for developing packages

This topic covers standard coding practices and guidelines that help to ensure the development of high quality packages.

Testing

Ensure high quality code. Write sufficient unit tests and integration tests for your package.

Icons

Set proper icon for your package.

Setting the version manually

The SDK package build version gets updated automatically every time a build happens. However, you can set it manually in the command project of a common **build.gradle** file.

- Update the **build.gradle** file before a build.
- Enter up to four digits numbers, separated by a period, as shown below:

```

. . .
ext {
    version '2.0.8'
}

```

Dependencies

```
dependencies {...}
```

Embed all the dependencies in your package JAR. Load the dependencies at run time by extracting them to a temporary location. Be sure to clean the temporary location after the dependencies are loaded.

Dependent JAR files

Add dependent JAR files under dependencies in the **build.gradle** file as implementation so that the dependant JAR files are packaged.

```
...
dependencies {
    compileOnly name: 'command-
annotations'
    compileOnly name: 'bot-runtime'
    compileOnly name: 'bot-api'
    implementation name: 'i18n-api'
        implementation name:
'mydependentjavafile.jar'
    apt name: 'command-processor'
    compileOnly group:
'org.apache.logging.log4j',
name: 'log4j-core', version:
"$loggerVersion"
    testImplementation
"org.testng:testng:$testNgVersion"
    testImplementation name: 'bot-
runtime'
    testImplementation name: 'bot-api'
}
...
```

Add new actions to the exiting package

When adding new actions to an existing package, make sure to do clean before packaging. It is always a good practice to do clean build - gradlew.bat clean build shadowJar.

Error messages

Provide meaningful error messages.

- **Do** throw meaningful error messages. For example, in local language using i18n APIs with `BotCommandException`, throw a new exception

```
BotCommandException(MESSAGES.getString("Run.E
```
- **Do not** throw generic error messages, such as `ex.message`.

Basic validation

Use the validation annotation rules, such as `@NotEmpty` included with this development kit. Do not add basic validations for your code. See [Validation annotations](#).

Loops

Avoid long running loops in your code. Long running loops can cause high CPU usage, leading to errors such as, "Bot is unresponsive."

Add logging

Use the default **log4j** logger provided in the bot run time framework. Do not add your own logger. See the sample code for details.

Logging levels

- **ERROR/FATAL:** Severe error event that the user is affected and there is no workaround.
- **WARN :** Unexpected error occurred but the system has recovered from it.
- **INFO:** Informational messages about state change, for example, an accepted request.
- **DEBUG:** Detailed diagnostic information that will be required to debug when something goes wrong.
- **TRACE:** All information is captured about an application behavior.

If you are not sure of the log level, set it to **TRACE**.

Loading resources

All resources should be loaded using current thread context class loader, as shown in the following example:

```
Thread.currentThread().getContextClassLoader().getResources("com.automationanywhere.cpa.samples.logging")
```

Related concepts

[How to examples](#)

This section contains code examples and explanations about how to code some basic bot capabilities.

[Annotations](#)

This section provides reference information about the annotations used to create Automation Anywhere packages.

Related tasks

[Set up the Java project](#)

Set up an integrated development environment (IDE) for Java, including Automation Anywhere custom annotations to develop an action package that you can upload to your Control Room.

[Develop a sample package](#)

Develop your own package and upload it to an Control Room to provide custom actions for bots.

Develop a sample package

Develop your own package and upload it to an Control Room to provide custom actions for bots.

Download and extract the contents from the latest Automation 360 Package SDK release. The newest package contains the necessary sample source code to build your package.

You need to have a project created in a Java IDE. For details about setting up a project, read [Set up the Java project](#).

The following high-level tasks provide the basic workflow for creating a package.

1. Create a java class.

This class is the action you plan to publish in your package.

Important: It is required that the class supports the default constructor.

2. Add required business logic to the class.

The following are the supported return types:

- **Void**: Use this return type if your action does not return any value.
- **Value**: Use this return type if your action returns any type of value.

3. Annotate the class with `BotCommand` and `CommandPkg` Annotations to make the class eligible to be converted to an action.

4. Annotate the variable that accepts values with `Idx` and `Pkg`.

5. Annotate the entry method with the `Execute` annotation.

6. From the action prompt, run `gradlew.bat clean build shadowJar`.

The JAR file created from the build is located in `build/lib`.

From the Control Room on the **Bots > Package** page, click the **Add package** icon to upload the JAR file.

Tip: To upload a package to a Control Room, you need **Upload package** permission. Review how to add a package to an Control Room: [Add packages to the Control Room](#).

Related concepts

[Standard coding practices and guidelines for developing packages](#)

This topic covers standard coding practices and guidelines that help to ensure the development of high quality packages.

[How to examples](#)

This section contains code examples and explanations about how to code some basic bot capabilities.

[Annotations](#)

This section provides reference information about the annotations used to create Automation Anywhere packages.

Related tasks

[Set up the Java project](#)

Set up an integrated development environment (IDE) for Java, including Automation Anywhere custom annotations to develop an action package that you can upload to your Control Room.

Using the package SDK

These example topics provide a basic understanding of how to use the Package SDK with Automation 360. Each SDK package includes a collection of configurable files that you can use to build a custom package, and then use the package to create TaskBots.

Use the following steps to create, configure, and build an IntelliJ project to compile a new package, and then create a bot to test the package you created.

1. Download, extract, and review the Package SDK files:

- Download the latest Automation Anywhere A2019 Package SDK.

[Enterprise Automation360 Package Development Kit Release Notes](#)

- Go to your `Downloads` folder, right-click your downloaded Package SDK, and select **Extract All**.
- Review all the files included in the package. You can drop any java file in your IntelliJ project to view or edit the content.

2. Install the latest Automation 360 version:
 - a) After the installation, log in to the Control Room with an admin privilege and create a new user with permissions to upload a package and create bots.
Create a user
 - b) Connect your local device to the Control Room. If required, download and install the latest Bot Agent.
Install Bot Agent and register device
3. Install Java SE Development Kit 11 or IntelliJ IDE Community Edition and Gradle plug-in.
 - Java SE Development Kit 11 (<https://www.oracle.com/java/technologies/javase/jdk11-archive-downloads.html>)
 - Java IDE (<https://www.jetbrains.com/idea/download/#section=windows>)
4. Configure the sample build files in the IntelliJ project.
Configuring build files
5. Create a new directory, package, and class.
Creating new Java class
6. Use the compiled JAR file as a package and upload it to your Control Room in Automation 360.
Upload custom package to your Control Room
7. Create a TaskBot to test the new package.
Create a bot to test the new package
8. Optional: Verify the results, and if required, add additional actions to your bot flow, and configure parameters and values.
9. View additional resources.
To learn more, search for the *Package SDK: How to examples*.

Configuring build files

Configuring build files

Use IntelliJ to configure and compile a JAR file, and then upload it as a package to your Control Room in Automation 360.

A basic understanding of JDK and Java IntelliJ is required in order to build an action package. Ensure you have the following software and files:

- Java SE Development Kit 11 (<https://www.oracle.com/java/technologies/javase/jdk11-archive-downloads.html>)
- Java IDE (<https://www.jetbrains.com/idea/download/#section=windows>)
- Automation Anywhere A2019 SDK. Download and extract the zip file for the release you require:
Enterprise A2019 Package Development Kit Release Notes

1. Unzip the contents of the SDK package to your `IdeaProjects` directory and rename the folder from `<latest package sdk zip file>` to `A2019FileDetails`.
2. In IntelliJ IDEA, go to **File > Open** and open the project located at `C:\Users\<User>\IdeaProjects\A2019FileDetails`.
3. Open the `settings.gradle` file in the project root, and set the `rootProject.name = 'A2019FileDetails'`
4. Update the `package.template` file located at **src > main > resources > package.template**.
5. Change the package name from `A2019DemoPackage` to `A2019FileDetails`.
6. Update the package name in **locales json**: go to **src > main > resources > locales > en_US.json**.

- a) Open the `en_US.json` file and update the **required** label field. Update the optional description.
 - b) Delete all other remaining lines in the `en_US.json` file.
7. Open the `build.gradle` in the project root. After the dependencies section, remove other dependencies, if they are not required.
 8. Save all files.

Creating new Java class

Creating new Java class

Use IntelliJ to create a new java class and a new directory, and configure other build files.

Complete the steps in the following task: [Configuring build files](#).

1. Create a new **Java Class**, right-click the `com.automationanywhere.botcommand` package, and select **New > Java Class**. Enter the name for the new class `GetFileDetails`.
 - a) Copy `@BotCommand` from the `Concatenate.java` and paste it into the new `GetFileDetails.java` file.

```
import static com.automationanywhere.commandsdk.model.DataType.STRING;
//BotCommand makes a class eligible for being considered as an action.

@BotCommand
//CommandPks adds required information to be dispalable on GUI.
@CommandPkg(
    //Unique name inside a package and label to display.
    name = "concatenate", label = "[[Concatenate.label]]",
    node_label = "[[Concatenate.node_label]]", description =
    "[[Concatenate.description]]", icon = "pkg.svg",

    //Return type information. return_type ensures only the right kind
    of variable is provided on the UI.
    return_label = "[[Concatenate.return_label]]", return_type = STRING,
    return_required = true)
public class Concatenate {

    //Messages read from full qualified property file name and provide
    i18n capability.
    private static final Messages MESSAGES = MessagesFactory
        .getMessages("com.automationanywhere.botcommand.samples.messages");

    //Identify the entry point for the action. Returns a Value<String>
    because the return type is String.
    @Execute
    public Value<String> action(
        //Idx 1 would be displayed first, with a text box for entering the
        value.
        @Idx(index = "1", type = TEXT)
        //UI labels.
        @Pkg(label = "[[Concatenate.firstString.label]]")
        //Ensure that a validation error is thrown when the value is null.
        @NotEmpty
        String firstString,

        @Idx(index = "2", type = TEXT)
        @Pkg(label = "[[Concatenate.secondString.label]]")
        @NotEmpty
        String secondString) {
```

```

//Internal validation, to disallow empty strings. No null check
needed as we have NotEmpty on firstString.
if ("".equals(firstString.trim()))
    throw new
BotCommandException(MESSAGES.getString("emptyInputString",
"firstString"));

if ("".equals(secondString.trim()))
    throw new
BotCommandException(MESSAGES.getString("emptyInputString",
"secondString"));

//Business logic
String result = firstString + secondString;

//Return StringValue.
return new StringValue(result);

```

- b) Update the @CommandPkg parameters such as: name, label, node_label, description, and icon.
 - c) Update the return_label and the return_type.
 - d) Add the NumberValue action, internal validation, business logic, and the return value.
 - e) Delete the Concatenated. java file and samples.commands. basic directory, and the sample.commands directory.
2. Configure the en_US.json file: go to **src > main > resources > locales > en_US.json** and add the following fields after the label and description values, and delete other parameters from the file.

```

{
  "label": "File Details",
  "description": "Returns basic file details",
  "GetFileDetails.label": "File Size",
  "GetFileDetails.description": "Return the size of the selected file in
bytes",
  "GetFileDetails.node_label": "File Size in Bytes",
  "GetFileDetails.return_label": "File Size",
  "GetFileDetails.return_label_description": "Return in bytes",
  "GetFileDetails.filePath.label": "Select a File for analysis"
}

```

3. Delete packages: go to **src > main > java > com.automationanywhere.botcommand**, and delete the samples.commands and delete the samples packages.
4. Import new icons from Github and update the CommandPkg annotation.
 - a) Download any icons you want to use in your bot flow and save them as .svg files.
 - b) Copy your image files into the **src > main > resources > icons** folder.
5. Create a new directory: go to **src**, right- click, and select **New > Directory**.
 - a) In the **Name** field, enter `test\java`. Alternatively, select the `test\java`, and enter the name `TestFileSize`.
 - b) Configure test annotations in the `TestFileSize` java class.
 - c) Create a `@test` public class, create a `GetFileDetails` object, and invoke the action.
 - d) Optional: Run the `TestGetFileDetails` in IntelliJ to test it.

- Configure the `TestFileSize` file, and open `TestFileSize` and copy and paste the following code:

```
{
    @Test
    public void TestGetFileDetails() {
        String filePath = "src\\main\\resources\\icons\\sample.svg";
        //Create GetFileDetails Object
        GetFileDetails getFileDetails = new GetFileDetails();
        //invoke action
        NumberValue output = getFileDetails.action(filePath);
        Assert.assertEquals(output.getAsDouble(), 5027.0);
    }
}
```

- Save the project: **File > Save All**.
- Click **Reload All Gradle Projects**, and then click **Execute Gradle Task**, and verify that the **A2019FileDetails** project is selected.
- In the **Run Anything** window, enter `gradle clean build shadowJar`.
After it runs, the following message is displayed: `BUILD SUCCESSFUL in 8s <number of seconds>`

Upload custom package to your Control Room

Upload custom package to your Control Room

Use the compiled JAR file and upload it as a package to your Control Room in Automation 360.

- Complete the steps in the following task: [Creating new Java class](#).
- Ensure you have the following:
 - Access to the Control Room.
 - Credentials with **AAE_Basic** permission or a custom role with the capability to upload packages to the Control Room.

- From Windows Explorer, go to `C:\Users\<>Username>\IdeaProjects\A2019-FileDetails\build\libs` and locate `A2019FileDetails-2.0.9.jar`.
- Log in to your Control Room as a user with permissions to add a new package.
- Click **BOTS > Packages**.
- In the **All packages** page, move your mouse over the plus sign and click **Add package**.
- In the **Add package** page, click **Browse** and locate the `A2019FileDetails-2.0.9.jar` file.
By default, the file is located at: `C:\Users\<>Username>\IdeaProjects\A2019-FileDetails\build\libs`.
- Select the `A2019FileDetails-2.0.9.jar` file and click **Open**.
- Click **Upload Package**.

When you upload a custom package to the Control Room, a notification is also sent to the Control Room users to notify about package updates. This notification is sent to the users who have the **View package** permission. For more information, see [Add or update package](#) event notification.

Create a bot to test the new package

Create a bot to test the new package

Use the actions in Automation 360 to create a bot and test the new package you have added to your Control Room.

Ensure you have the following to build the bot:

- Access to the Control Room.

- Credentials with **AAE_Basic** permission or a custom role to create bots.
 - Your workstation is a registered device in the Control Room.
 - Your package `A2019FileDetails-2.0.9.jar` is available in the Control Room.
1. Log in to the Control Room.
 2. On the left pane, click **Automation**.
A list of available and forms is displayed.
 3. Click the **Create a bot** icon.
 4. In the **Name** field, enter `TestingFileSize` or any other name you want.
 5. Click **Create & Edit**.
 6. In the Actions pane, find **File Details** and drag **File Size** into the bot flow.
 - a) In the **Select a File for analysis** field, select **Desktop file**, click **Browse**, and select any file from your desktop.
 - b) Click **Create variable** to create a new number variable.
 - c) In **Create Variable**, enter `nFileSize` and click **Create & Select**.
 - d) Click **Apply**.
 7. In the Actions pane, find the **Number** package and drag the **To String** command.
 - a) In the **Enter a number** field, enter **F2**, and select **nFileSize**.
 - b) In the **Assign the output to variable** field, select **prompt-assignment - String** from the drop-down list.
 - c) Click **Apply**.
 8. From the Actions pane, drag **Message box**.
 9. In the **Enter the message to display** field, click **F2** and select the **prompt-assignment variable**.
 10. Click **Apply** and **Save**.
 11. Click **Run**.
The bot displays the `<The value of the file size>`, which is a successful build.

If you were not able to run bot your bot, go back and modify your configuration steps in your Control Room.

How to examples

This section contains code examples and explanations about how to code some basic bot capabilities.

Return a value from an action

Set the following properties on `CommandPkg` to store the action output in a variable.

Expose property attributes of action

The property values of an action can be exposed by setting the following properties on `CommandPkg`.

Organize and group actions when developing packages

Review the provided examples on how to add and group actions during the package SDK development process.

Input types - UI elements

The user interface (UI) elements are the input controls used to receive inputs in an action while building a bot.

Create custom variables using Package SDK

When using Automation 360, you can create custom variables using the SDK package.

Create a condition using Package SDK

When using Automation 360, you can create a condition with the SDK package.

Add a condition in a custom package for If condition

Add conditions in a custom package.

Create an iterator using Package SDK

In Automation 360, you can create an iterator with the SDK package. An iterator is used to loop through multiple objects of similar type and is used with the Loop package. It consists of two methods, `next` and `hasNext`, which return the actual object and a boolean value.

Create a trigger using Package SDK

When using Automation 360, you can create a trigger using the SDK package.

Custom triggers - pull and push mechanism

The examples provided in this topic demonstrate how to create time-based and event-based triggers, pull ([link TriggerDemo](#)) and push (`SimpleMessageListenerContainer`) mechanisms using the SDK package.

Add debug logs of custom packages to bot_launcher.log file

You can add logs using `log4j`. The dependency is already added in the package SDK sample `build.gradle` file.

Handle sessions in a custom package

You can extract a session using a session name from the `SessionsMap`. In the same package, you can use sessions to pass information between actions, but not to other packages.

Configure shared session using Package SDK

Package SDK provides configuration for the SDK users to create and use shared sessions. Sessions are seamlessly shared between different bots to share resources between them. This means that if a session has been created, the other TaskBots can read and update the session and vice versa.

Create a bot to test the custom package

A shared session enables you to reuse actions between TaskBots that run concurrently, for example, using the same Excel file to pass values.

Actions

Any action class supports only one method as an entry point. Annotate all parameters of the entry point method with `Idx`. There are three types of actions:

- Command\Action (default choice)
- Iterator
- Condition



CAUTION: If you do not provide a public setter to member variables with `Inject`, compilation errors occur.

Related concepts

[Standard coding practices and guidelines for developing packages](#)

This topic covers standard coding practices and guidelines that help to ensure the development of high quality packages.

[Annotations](#)

This section provides reference information about the annotations used to create Automation Anywhere packages.

Related tasks

[Set up the Java project](#)

Set up an integrated development environment (IDE) for Java, including Automation Anywhere custom annotations to develop an action package that you can upload to your Control Room.

[Develop a sample package](#)

Develop your own package and upload it to an Control Room to provide custom actions for bots.

Return a value from an action

Set the following properties on `CommandPkg` to store the action output in a variable.

Action return values

- **return_type**
Defines the return type of the action. It usually matches the entry method return type.
- **return_required**
When the value is set to `true` the return value is required.
- **return_label**
A description of the UI label for the variable value.

Example: Convert a sourceString to uppercase and assign the result to returnTo

```
//BotCommand makes a class eligible for being considered as an action.
@BotCommand

//CommandPks adds required information to be displayable on the UI.
@CommandPkg(
    //Unique name inside a package and label to display.
    name = "uppercase", label = "[[Uppercase.label]]",
    node_label = "[[Uppercase.node_label]]", description =
    "[[Uppercase.description]]", icon = "pkg.svg",

    //Return type information. return_type ensures only the right kind of
    variable is provided on the UI.
    return_label = "[[Uppercase.return_label]]", return_type =
    STRING, return_required = true)
public class Uppercase {

    //Messages read from a fully qualified property file name and provides i18n
    capability.
    private static final Messages MESSAGES = MessagesFactory
        .getMessages("com.automationanywhere.botcommand.samples.messages");

    //Identify the entry point for the action. Returns a Value <String> because
    the return type is String.
    @Execute
    public Value<String> action(
        //Idx 1 would be displayed first, with a text box for entering the value.
        @Idx(index = "1", type = TEXT)
        //UI labels.
        @Pkg(label = "[[Uppercase.sourceString.label]]")
        //Ensure that a validation error is thrown when the value is null.
```

```
@NotEmpty
String sourceString,
```

Related concepts

[How to examples](#)

This section contains code examples and explanations about how to code some basic bot capabilities.

Expose property attributes of action

The property values of an action can be exposed by setting the following properties on `CommandPkg`.

Action property values

	Property Attributes	Description
1	property_name	The name of the property, unique at action level, in auto-complete box this name would appear.
2	property_description	A description of the property.
3	property_type	The data type on which property operates, only if the type matches, the property will be appear in the auto-complete box.
4	property_return_type	The data type for what property returns. If this type does not match with the field type where it is used, there will be validation error.

```
@BotCommand
@CommandPkg(label = "Uppercase", name = "uppercase", description="Converts
the string to upper case",
icon = "uppercase.svg", node_label="Convert {{sourceString}} to upper case|
and assign the result to {{returnTo}}|",
return_type=DataType.STRING, return_required = true, return_label="Assign
the output to variable",
property_name="uppercase", property_description="Converts the string to
upper case", property_type=DataType.STRING,
property_return_type=DataType.STRING) public class UpperCase {

    @Execute
    public Value<String> convert(
        @Idx(index = "1", type=TEXT)
        @Pkg(label="Source string")
        @NotEmpty
        String sourceString){
        return new StringValue(sourceString.toUpperCase());
    }
}
```

For example, the above class in the UI will look like:

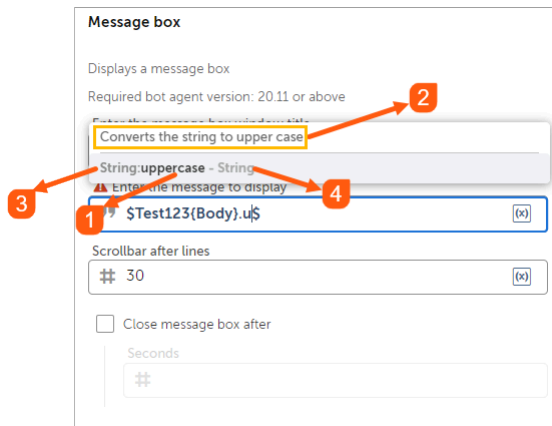

Related concepts

[How to examples](#)

This section contains code examples and explanations about how to code some basic bot capabilities.

Organize and group actions when developing packages

Review the provided examples on how to add and group actions during the package SDK development process.

Example: Add actions

```
@BotCommand
//CommandPks adds required information to be dispalable on the UI.
@CommandPkg(
    //Unique name inside a package and a label to display.
    name = "concatenate", label = "[[Concatenate.label]]",
    node_label = "[[Concatenate.node_label]]", description =
    "[[Concatenate.description]]", icon = "pkg.svg",

    //Return type information. return_type ensures only the right kind of
    variable is provided on the UI.
    return_label = "[[Concatenate.return_label]]", return_type = STRING,
    return_required = true)
```

Example: Group actions

Use the `group_label` to `ConcatenateGroup` which it is displayed in the UI also as **ConcatenateGroup**. When the `group_label` is not used, you will get all the actions in the respective package.

```
@BotCommand
//CommandPks adds required information to be dispalable on the UI.
@CommandPkg(
    //Provide a unique name inside a package and a label to display.
    group_label = "ConcatenateGroup", name = "concatenateWithGroup", label =
    "concatenateWithGroup",
    node_label = "[[Concatenate.node_label]]", description =
    "[[Concatenate.description]]", icon = "pkg.svg",

    //Return type information. return_type ensures only the right kind of
    variable is provided on the UI.
    return_label = "[[Concatenate.return_label]]", return_type = STRING,
    return_required = true)
public class ConcatenateWithGroup {
```

Input types - UI elements

The user interface (UI) elements are the input controls used to receive inputs in an action while building a bot.

The following examples show the supported input types. Use the UI elements to create user interface (UI) designs to build the Control Room interfaces. For instance, if you need an input as text then, use `TEXT`, if you need a radio button, select `RADIO`, and so on. This topic is based on the *SampleUI* sample available within the **Package SDK** in the following location: `<PackageSDK>\src\main\java\com\automationanywhere\botcommand\samples\commands\ui\SampleUI.java`.

1. Make sure you have imported the following packages to ensure all the functionalities works as described in the sample.

```
import com.automationanywhere.commandsdk.annotations.Idx;
import com.automationanywhere.commandsdk.annotations.Pkg;
import com.automationanywhere.commandsdk.annotations.rules.CodeType;
import com.automationanywhere.commandsdk.annotations.rules.VariableType;
```

2. Add the `@BotCommand` annotation to make a class as an Action in the Control Room. For more information on annotations, see [Annotations](#).

```
@BotCommand
```

3. Add the `@CommandPkg` annotation to define all the UI related components - *labels, description, and name*.

```
@CommandPkg(label = "UI Demo", description = "Demonstrates the provided
  UI elements", name = "uiDemo")
```

4. Create a class and define the fields as described below.
 - a. Annotate the method with `@Execute` to execute the method during compilation.
 - b. In this sample, `@Idx` and `@Pkg` are used as a member of the class, so you should use `set` and `get` methods to define them.
 1. `@Idx` - Defines the index of an action.
 2. `@Pkg` - Defines all the parameters and member variables shown in the interface. Must be accompanied by the `@Idx`, if not this annotation is ignored.
 3. `@Inject` - To receive value from the UI using the member class, `@Inject` is required at field levels.

```
@BotCommand
@CommandPkg(label = "UI Demo", description = "Demonstrates the
  provided UI elements", name = "uiDemo")
public class SampleUI {
    @Idx(index = "1", type = TEXT)
    @Pkg(label = "Text type")
    @Inject
    String text;

    @Execute
    public String getText() {
        return text;
    }
    public void setText(String text) {
        this.text = text;
    }
}
```

}

5. Drag the action into canvas and you will be able to input a string in the text field. You will see an input box similar to this image.

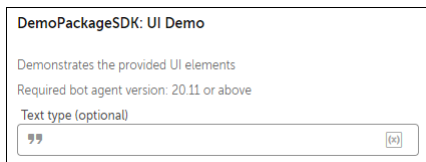

UI element - Number field

Use the *Number* type to create an UI element that will accept a number. Using the below sample you will be able to create a field that will accept only numbers.

```
@BotCommand
@CommandPkg(label = "UI Demo", description = "Demonstrates the provided UI
elements", name = "uiDemo")
public class SampleUI {
    @Idx(index = "2", type = NUMBER)
    @Pkg(label = "Number type")
    @Inject
    String num;

    @Execute
    public String getNum() {
        return num;
    }
    public void setNum(String num) {
        this.num = num;
    }
}
```

Other UI elements

It is possible to create other UI components like: *Boolean*, *Radiobutton*, *Number*, *Variable*, *Code*, *Dictionary*, *List*, *Date/Time*, and so on. To get a complete list of UI elements supported, see `<PackageSDK>\src\main\java\com\automationanywhere\botcommand\samples\commands\ui\SampleUI.java`.

UI validations supported

The following UI validations are also supported:

- *@NotEmpty* means that the UI field needs an input at the bot design time.
- *@LocalFile* refers to a local file from a user machine.
- *@NumberIntegers* refers to a number value that you can provide, such as, a float or a double input kind.

Create custom variables using Package SDK

When using Automation 360, you can create custom variables using the SDK package.

Using custom variables

Use Automation 360 to create a custom variable. This is a system variable and is used as other bot variables, except it is read-only and the value is calculated instead of being assigned.

Required annotations

For creating a variable, the following annotations are required:

Annotation	Usage
BotCommand	Use the <code>BotCommand</code> annotation with the variable as <code>commandType</code> . This ensures that the plain old Java object (POJO) is suitable for creating an Automation 360 variable.
CommandPkg	These values are used when creating a package. Provide a name, label, and description to the annotation.
Idx	Annotate all the parameters and member variables that are required and help with the validation check. Alternatively they might be displayed in the interface for the input. Provide the index (<code>Idx</code>) and the type.
Pkg	Annotate all the parameters and member variables that will be shown in the interface. This annotation will be ignored if it is not accompanied by the <code>Idx</code> .
VariableExecute	The method that has to be called for returning the variable value. This method does not accept any input parameters. <code>Sessions</code> and <code>GlobalSessionContext</code> are available through setter injection.

Use case example

The following use case shows how to return the current time for the system default zone.

1. Create the POJO class with the business logic:

```
public class Now {

    public DateTimeValue now() {
        Instant instant = Instant.now();
        ZonedDateTime now = instant.atZone(ZoneId.systemDefault());
        return new DateTimeValue(now);
    }

}
```

2. Annotate the POJO class to enable it for the Automation 360 variable and to create the package:

```
@BotCommand(commandType = BotCommand.CommandType.Variable)
@CommandPkg(description = "The current datetime at system default zone.",
    name = "Now", label = "", variable_return_type = DataType.DATETIME)
public class Now {

    public DateTimeValue now() {
        Instant instant = Instant.now();
        ZonedDateTime now = instant.atZone(ZoneId.systemDefault());
        return new DateTimeValue(now);
    }

}
```

```
}

```

3. Annotate the `now` method to denote it to be the execute method.

```
@VariableExecute
public DateTimeValue now() {
    Instant instant = Instant.now();
    ZonedDateTime now = instant.atZone(ZoneId.systemDefault());
    return new DateTimeValue(now);
}
```

Every variable must have one test `VariableExecute` method.

Related concepts

[How to examples](#)

This section contains code examples and explanations about how to code some basic bot capabilities.

Using EntryList

EntryList enables you to accept any number of parameters through the bot designer. The parameter structure is defined in the Automation 360 actions.

Example: EntryList

The following example shows how to create a parameter with the name of `village pair`.

```
@BotCommand
@CommandPkg(label = "EntryList example", description = "EntryList example",
    icon = "sample.svg", name = "entryListExample")
public class EntryListExample {
    // UI display for ENTRYLIST 1.1, the linking is done based on the ENTRYLIST
    title.
    // This should be added as a child of the ENTRYLIST, however it should not
    be part of options.
    // The EntryList does not need a setter or Inject as the value is provided
    inside the ENTRYLIST.
    @Idx(index = "1.3", type = TEXT, name = "NAME")
    @Pkg(label = "Name", default_value_type = DataType.STRING)
    @NotEmpty
    private String name;
    //Linked to 1.2 through title.
    @Idx(index = "1.4", type = TEXT, name = "VILLAGE")
    @Pkg(label = "village", default_value_type = STRING)
    private String city;
    @Execute
    public void setParameter(
        // Add the entryList, the values are accepted as a list of values.
        // Provide the column header for the tabular display of accepted entries.
        // In Pkg, provide a unique title.
        // Provide Idx for each option separately, this is needed to
        // have the correct UI type when the entry form is presented.
        // Add only columns to options, you cannot add their definitions.
        @Idx(index = "1", type = ENTRYLIST, options = {
            @Idx.Option(index = "1.1", pkg = @Pkg(title = "NAME", label = "Name")),
            @Idx.Option(index = "1.2", pkg = @Pkg(title = "VILLAGE", label =
                "village")),
        })
        //Label that is displayed in the UI
    )
```

```

@Pkg(label = "Provide name value entries")
//Header of the entry form
@EntryListLabel(value = "Provide entry")
//Button label which displays the entry form
@EntryListAddButtonLabel(value = "Add entry")
//Unique rule for the column, this value is the column TITLE.
@EntryListEntryUnique(value = "NAME")
//Message to display in the table when no entries are present.
@EntryListEmptyLabel(value = "No parameters added")
    List<Value> entryList) {
}

```

Here is another example of the EntryList, define the values of the EntryList usage.

```

//Entry list//
@Idx(index = "1", type = ENTRYLIST, options = {
    @Idx.Option(index = "1.1", pkg = @Pkg(title = HEADER_ENABLED, label =
    "[[HEADER1]]")),
    @Idx.Option(index = "1.2", pkg = @Pkg(title = HEADER_NAME, label =
    "[[HEADER1]]")),
    @Idx.Option(index = "1.3", pkg = @Pkg(title = HEADER_VALUE, label =
    "[[HEARER3]]"))
})
@Pkg(label = "customHeaderslabel")
@EntryListLabel(value = "customHeaderlabel")
@EntryListAddButtonLabel(value = "add.header")
@EntryListEmptyLabel(value = "no.header")
@Inject
List<Value> customHeaders;

```

Related concepts

[How to examples](#)

This section contains code examples and explanations about how to code some basic bot capabilities.

Using regular expression

Use regular expressions (regex) to create string patterns that help match, locate, or manage text in Java. Together, the literals and special characters define a logical pattern. Use the pattern to compare strings of text to check if the strings match the defined pattern.

Note: Regular expression (regex) does not recognize `[\b]` as a Backspace command. Use `\\b` to use Backspace instead.

Example: MatchesRegex

Use `MatchesRegex` to test the string pattern.

In the following example, the input pattern starts from the English alphabet, uppercase and lowercase, (A-Z/a-z) and ends with a numeric value.

```

@Idx(index = "1", type = TEXT)
@Pkg(label = "Field label", description = "Field description")
@MatchesRegex("^[A-Za-z]\w*")
@NotEmpty
String cell

```

If the pattern does not match, the following message is displayed: `Must match pattern.`

Related concepts

[How to examples](#)

This section contains code examples and explanations about how to code some basic bot capabilities.

FILE2 (Regex) attribute

A regular expressions (RegEx) are patterns of string defined to search for a file in a specified path. Use the `FILE2` attribute when using regular expressions (regex) to create string patterns.

For instance: If you want to search a folder path for a file (For example `Hello.txt`) which contains a certain string. . You will use `File2` attribute type to enter the following regex pattern: `Hell` or `e11` which will find the file that matches the search criteria. This topic is based on the `File2TypeDemo` sample available within the **Package SDK** in the following location `<PackageSDK>\src\main\java\com\automationanywhere\botcommand\samples\commands\basic\types\File2TypeDemo.java`.

Using the FILE2

1. Make sure you have imported the following packages to ensure all the functionalities works as described in the sample.

```
import com.automationanywhere.commandsdk.annotations.*;
import com.automationanywhere.commandsdk.model.AttributeType;
import org.apache.logging.log4j.LogManager;
import org.apache.logging.log4j.Logger;
```

2. Add the `@BotCommand` annotation to make a class as an Action in the Control Room. For more information on annotations, see [Annotations](#).

```
@BotCommand
```

3. Add the `@CommandPkg` annotation to define all the UI related components - *labels, description, icon, return type, and name*.

```
@CommandPkg(label = "[[File2TypeDemo.label]]", description =
  "[[File2TypeDemo.description]]", icon = "sample.svg", name =
  "file2TypeDemo")
```

4. Create a method (For example: `regexFile`) within your class and define the fields as described below.
 - a. Annotate the method with `@Execute` to execute the method during compilation.
 - b. In the below sample, `@Idx`, `@Pkg`, and `@NotEmpty` are defined as a parameters of the method. If they are used as a member of the class, then you should use `set` and `get` methods to define them.
 1. `@Idx` - Defines the index of an action. (`@Idx(index = "1", type = AttributeType.FILE2)`)
 2. `@Pkg` - Defines all the parameters and member variables shown in the interface (`@Pkg(label = "[[File2TypeDemo.localFile.label]]")`). Must be accompanied by the `@Idx`, if not this annotation is ignored.
 3. `@NotEmpty` - Defines that this parameter cannot be empty (`@NotEmpty @LocalFile FileValue fileValue)`).

```
@BotCommand
@CommandPkg(label = "[[File2TypeDemo.label]]",
```

```

description = "[[File2TypeDemo.description]]", icon =
"sample.svg", name = "file2TypeDemo")
public class File2TypeDemo {
    private static Logger logger =
    LogManager.getLogger(File2TypeDemo.class);

    @Execute
    public void regexFile(
        @Idx(index = "1", type = AttributeType.FILE2)
        @Pkg(label = "[[File2TypeDemo.localFile.label]]")
        @NotEmpty @LocalFile FileValue fileValue)

```

5. Build and upload the custom package to the Control Room. For more information on uploading the package, see [Using the package SDK](#).
6. Create a bot.
7. Drag the action into canvas and you will be able to input the regex to find a file. You will see an input box similar to this image.

Print the Regex - Folder name and the File location

Use the [Logger](#) interface obtained from Log4j package to provide information of the objects being manipulated. In the below sample you will be able to log the *folder name* and the *local file location* by using the `debug` method.

```

@BotCommand
@CommandPkg(label = "[[File2TypeDemo.label]]",
description = "[[File2TypeDemo.description]]", icon = "sample.svg", name =
"file2TypeDemo")
public class File2TypeDemo {
    private static Logger logger = LogManager.getLogger(File2TypeDemo.class);

    @Execute
    public void regexFile(
        @Idx(index = "1", type = AttributeType.FILE2) @Pkg(label =
        "[[File2TypeDemo.localFile.label]]") @NotEmpty @LocalFile FileValue
        fileValue) {
        if (fileValue.isRegex()) {

            RegexFile regexFile = fileValue.getRegex();
            logger.debug("folder name {}", regexFile.getFolder());
            logger.debug("local file location {}",
            regexFile.getFileNamePattern().toString());
        } else {
            logger.debug("Regex option is not selected");
        }
    }

```

```
}

```

Create a condition using Package SDK

When using Automation 360, you can create a condition with the SDK package.

Using a condition

If and Loop are branching constructs in Automation 360. They are used to run a sequence of actions when a condition is set to `true`. A condition is used along with the If and Loop packages. A condition takes a set of inputs and returns a Boolean value.

Required annotations

For creating a condition, the following annotations are required:

Annotation	Usage
<code>BotCommand</code>	Use the <code>BotCommand</code> annotation with the condition as <code>commandType</code> . This ensures that the plain old Java object (POJO) is suitable for the creation of an Automation 360 condition.
<code>CommandPkg</code>	These values are used when creating a package. Provide a name, label, and description to the annotation.
<code>Idx</code>	Annotate all the parameters and member variables that are required and help with the validation check, or they might be displayed in the interface for the input. Provide the index (<code>Idx</code>) and the type.
<code>Pkg</code>	Annotate all the parameters and member variables that will be shown in the interface. This annotation will be ignored if it is not accompanied by the <code>Idx</code> .
<code>ConditionTest</code>	The method that has to be called for testing the condition. It must return a Boolean value. If the method accepts parameters, then annotate them with <code>Idx</code> .

Use case example

The following use case verifies whether the given number is greater than the other number.

1. Create the POJO class with the business logic:

```
public class IsGreater {
    public Boolean checkGreater(Double first, Double checkAgainst) {
        return first > checkAgainst;
    }
}
```

2. Annotate the POJO class to enable it for the Automation 360 condition and to create the package:

```
@BotCommand(commandType = Condition)
@CommandPkg(label = "Is greater condition", name = "IsGreater",
  description = "Checks if the given number is greater than the other.",
  node_label = "{{first}} > {{checkAgainst}} ")
public class IsGreater {
  public Boolean checkGreater(Double first, Double checkAgainst) {
    return first > checkAgainst;
  }
}
```

3. Annotate the checkGreater method to indicate that this method should be used as a comparison method.

```
@ConditionTest
public Boolean checkGreater(Double first, Double checkAgainst) {
  return first > checkAgainst;
}
```

Every condition must have exactly one test condition method.

4. Annotate the parameters of the checkGreater method with Idx and Pkg.

Add @NotEmpty to ensure the value is not null.

```
@ConditionTest
public Boolean checkGreater(
  @Idx(index = "1", type = AttributeType.NUMBER) @Pkg(label = "Number to
  check") @NotEmpty Double first,

  @Idx(index = "2", type = AttributeType.NUMBER) @Pkg(label = "Number to
  compare against") @NotEmpty Double checkAgainst) {

  return first > checkAgainst;
}
```

The attribute type number returns a Double.

Related concepts

[How to examples](#)

This section contains code examples and explanations about how to code some basic bot capabilities.

Add a condition in a custom package for `if` condition

Add conditions in a custom package.

Create condition values in an Action

- To create a condition, set `commandType` property of `BotCommand` annotation with value as `Condition`.
- To define the entry method of the condition, use the annotation `ConditionTest`.

```
@BotCommand(commandType = Condition)
@CommandPkg(label = "File exists", name = "fileExists",
  description = "Checks if the file exists.",
  node_label = "file exists at {{sourceFilePath}}", icon = "")
public class Exist extends AbstractCondition {
```

```

@ConditionTest
public boolean test(@Idx(index = "1", type = FILE) @LocalFile @Pkg(label
= "File path") @NotEmpty String sourceFilePath,
                   @Idx(index = "2", type = NUMBER) @Pkg(label = "How
long you would like to wait for this condition
to be true?(Seconds)",
                   default_value = "0", default_value_type =
DataType.NUMBER)
                   @GreaterThanEqualTo("0") @LessThanEqualTo("99999")
@NotEmpty @NumberInteger Double waitTimeout) {

    // Add the logic to check for the condition
}
}

```

The following example verifies if the provided boolean value is false.

Set `commandType` to `Condition`.

```

@BotCommand(commandType = Condition)
@CommandPkg(label = "False condition example", name =
"conditionalTypeExample",
            description = "Checks if the boolean value is false.")
public class ConditionalTypeExample {

    @ConditionTest
    public Boolean validate(
        @Idx(index = "1", type = AttributeType.BOOLEAN)
        @VariableType(BOOLEAN)
        @Pkg(label = "Boolean variable", default_value_type = BOOLEAN)
@NotEmpty Boolean variable
    ) {
        return variable == null ? false : !variable ;
    }
}

```

Related concepts

[How to examples](#)

This section contains code examples and explanations about how to code some basic bot capabilities.

Create an iterator using Package SDK

In Automation 360, you can create an iterator with the SDK package. An iterator is used to loop through multiple objects of similar type and is used with the Loop package. It consists of two methods, `next` and `hasNext`, which return the actual object and a boolean value.

Required annotations

When iterator is used, the `next` method returns the next available value. If no more values are available, an exception is shown. The `hasNext` method checks for other values and returns `false` if no more values are available. In Automation 360, when the loop is executed, `hasNext()` is called first, and `next()` is called only if `hasNext()` returned a `true` value.

For creating an iterator, the following annotations are required.

Annotation	Usage
<code>BotCommand</code>	Use the <code>BotCommand</code> annotation with an iterator as the <code>commandType</code> . This ensures that the plain old Java object (POJO) is eligible for creating an Automation 360 iterator.

Annotation	Usage
CommandPkg	When creating a package, provide a name, label, and description to the annotation.
Idx	Annotate all parameters and member variables that are required and help with the validation check, or they can be displayed in the interface for the input. Provide the <code>Idx</code> and the type.
Pkg	Annotate all parameters and member variables that will be displayed in the interface. This annotation will be ignored if it is not accompanied by the <code>Idx</code> .
HasNext	The method that has to be called for testing if the iteration has more elements (returns <code>true</code> if <code>next()</code> returns an element rather than throwing an exception). It must return a Boolean value. If the method accepts parameters, then they must be annotated with the <code>Idx</code> . The <code>hasNext</code> method verifies it and returns <code>false</code> if no more values are available. In Automation 360, when Loop is executed, <code>hasNext()</code> is called first. <code>next()</code> is called only if <code>hasNext()</code> returns a <code>true</code> value.
Next	The method returns the next available value in the iteration. The return type is a value. If no more value is available, an exception is shown.

Use case example

The example use case loops through number of times, for example, for (`int i=0; I<n; i++`) Java construct. It accepts the value of `n` from the Bot Creator when the bot is created.

1. Make sure you have imported the following packages to ensure all the functionalities works as described in the sample.

```
import com.automationanywhere.botcommand.data.Value;
import com.automationanywhere.botcommand.data.impl.NumberValue;
import com.automationanywhere.commandsdk.annotations.BotCommand;
import com.automationanywhere.commandsdk.annotations.CommandPkg;
import com.automationanywhere.commandsdk.annotations.HasNext;
import com.automationanywhere.commandsdk.annotations.Idx;
import com.automationanywhere.commandsdk.annotations.Inject;
import com.automationanywhere.commandsdk.annotations.Next;
import com.automationanywhere.commandsdk.annotations.Pkg;
import
    com.automationanywhere.commandsdk.annotations.BotCommand.CommandType;
import
    com.automationanywhere.commandsdk.annotations.rules.GreaterThanOrEqualTo;
import com.automationanywhere.commandsdk.annotations.rules.NotEmpty;
import com.automationanywhere.commandsdk.annotations.rules.NumberInteger;
import com.automationanywhere.commandsdk.model.AttributeType;
import com.automationanywhere.commandsdk.model.DataType;
```

2. Create the POJO class with the business logic.

Ensure that the POJO has a method and returns a boolean value. This will act as the comparison method.

```
@BotCommand(commandType=CommandType.Iterator)
@CommandPkg(return_label = "Return the value in variable", node_label =
    ": {{times}} times",
    label = "Iterator demo", description = "Iterate number of times", name =
    "iteratorTypeDemo", return_type = DataType.NUMBER)
public class IteratorTypeDemo {
    @Idx(index = "1", type = AttributeType.NUMBER)
```

```

    @Pkg(label = "times", default_value = "10", default_value_type =
DataType.NUMBER)
    @GreaterThanEqualTo("0")
    @NumberInteger
    @NotEmpty
    @Inject
private Double times = 10d;

private Double counter = 0d;

    @HasNext
    public boolean hasNext() {
return counter < times;
    }

    @Next
    public Value<Double> next() throws Exception{
if (counter >= times)
    throw new Exception("Counter '" + counter + "' is exceed the times limit
'" + times + "'");

counter++;
    NumberValue result = new NumberValue();
    result.set(counter);
    return result;
    }

    public void setTimes(Double times) {
        this.times = times;
    }
}

```

3. Annotate the POJO class to enable it for the Automation 360 iterator and to create a package.

```

@BotCommand(commandType = CommandType.Iterator)
@CommandPkg(return_label = "Return the value in variable", node_label =
": {{times}} times",
label = "Iterator demo", description = "Iterate number of times", name =
"iteratorTypeDemo", return_type = DataType.NUMBER)
public class IteratorTypeDemo {

private Double times = 10 d;
private Double counter = 0 d;

public boolean hasNext() {
return counter < times;
}
}

```

4. Annotate the hasNext () and next () method appropriately.

```

@HasNext
public boolean hasNext() {
return counter < times;
}

@Next
public Value < Double > next() throws Exception {
if (counter >= times)
    throw new Exception("Counter '" + counter + "' is exceed the times
limit '" + times + "'");

counter++;
NumberValue result = new NumberValue();
}

```

```

result.set(counter);
return result;
}

```

The methods are named in easy-to-use way and are in parallel with the Java iterator interface. There is no restriction from the SDK side when naming methods.

In an iterator, do not use parameter methods, but use `setter injection`.

5. Annotate the variables with `Idx` and `Pkg`.

Add `@NotEmpty` to ensure the value is not null, and add `@GreaterThanOrEqualTo` to ensure the value is always greater than 0.

```

@Idx(index = "1", type = AttributeType.NUMBER)
@Pkg(label = "times", default_value = "10", default_value_type =
    DataType.NUMBER)
@GreaterThanOrEqualTo("0")
@NotEmpty
@Inject
private Double times = 10 d;

```

The attribute type number returns a `Double`.

Related concepts

[How to examples](#)

This section contains code examples and explanations about how to code some basic bot capabilities.

Create a trigger using Package SDK

When using Automation 360, you can create a trigger using the SDK package.

Using a trigger

Use Automation 360 to create a trigger. A trigger launches a bot when certain conditions are met and waits until conditions have changed or stopped. When the conditions of the trigger are matched, the run method is called to signal the trigger.

Required annotations

For creating a trigger, the following annotations are required:

Annotation	Usage
<code>BotCommand</code>	Use the <code>BotCommand</code> annotation with the trigger as <code>commandType</code> . This ensures that the plain old Java object (POJO) is suitable for creating the trigger with Automation 360.
<code>CommandPkg</code>	These values are used when creating a package. Provide a name, label, and description to the annotation.
<code>Idx</code>	Annotate all the parameters and member variables that are required and help with the validation check. Alternatively, they might be displayed in the

Annotation	Usage
	interface for the input. Provide the index (<code>Idx</code>) and the type.
<code>Pkg</code>	Annotate all the parameters and member variables that will be shown in the interface. This annotation will be ignored if it is not accompanied by the <code>Idx</code> .
<code>StartListen</code>	Starts the trigger listener.
<code>TriggerId</code>	A trigger ID, which is required for stopping the trigger.
<code>TriggerRunnable</code>	Provides the runnable. Calling the runnable sends a signal that launches a bot associated with a trigger.

Use case example

The following use case shows how to create a timer trigger that triggers a bot at a regular interval.

1. Create the POJO class with the business logic:

```
public class TriggerDemo {
    private static final Timer TIMER = new Timer(true);

    public void startTrigger(Double interval) {
        TimerTask timerTask = new TimerTask() {

            @Override
            public void run() {
                // Do nothing
            }
        };

        TIMER.schedule(timerTask, interval.longValue());
    }
}
```

Multiple triggers of the same type can exist in a bot. All triggers are identified by a `triggerId`.

2. Add a `triggerId` to the class:

```
@TriggerId
private String triggerUid;

public String getTriggerUid() {
    return triggerUid;
}

public void setTriggerUid(String triggerUid) {
    this.triggerUid = triggerUid;
}
```

3. Store the `TimerTask` separately so that when you want to stop a specific trigger, use the `triggerId`.

```
private static final Map<String, TimerTask> taskMap = new
    ConcurrentHashMap<>();

public void startTrigger(Double interval) {
    TimerTask timerTask = new TimerTask() {

        @Override
        public void run() {
            // Do nothing
        }
    };
    taskMap.put(this.triggerUid, timerTask);
    TIMER.schedule(timerTask, interval.longValue());
}
```

4. Start a trigger when conditions are met. Accept a runnable and call it appropriately.

```
@TriggerRunnable
private Runnable runnable;

public Runnable getRunnable() {
    return runnable;
}

public void setRunnable(Runnable runnable) {
    this.runnable = runnable;
}

public void startTrigger(Double interval) {
    TimerTask timerTask = new TimerTask() {

        @Override
        public void run() {
            runnable.run();
        }
    };
    taskMap.put(this.triggerUid, timerTask);
    TIMER.schedule(timerTask, interval.longValue());
}
```

5. Stop the trigger, either individually (use a `triggerId`), or stop all triggers at the same time (`StopAllTriggers`).

```
/*
 * Cancel all the task and clear the map.
 */
@stopAllTriggers
public void stopAllTriggers() {
    taskMap.forEach((k, v) -> {
        if (v.cancel()) {
            taskMap.remove(k);
        }
    });
}

/*
 * Cancel the task and remove from map
```

```

*
* @param triggerUid
*/
@stopListen
public void stopListen(String triggerUid) {
    if (taskMap.get(triggerUid).cancel()) {
        taskMap.remove(triggerUid);
    }
}
}

```

6. Add the remaining annotations.

```

@BotCommand(commandType = BotCommand.CommandType.Trigger)
@CommandPkg(label = "Demo Trigger", description = "Demo Trigger", icon =
    "email.svg", name = "demoTrigger")
public class TriggerDemo {
    //Other code

    @startListen
    public void startTrigger(@Idx(index = "1", type = AttributeType.NUMBER)
        @Pkg(label = "Please provide the interval to trigger in seconds",
            default_value = "120", default_value_type = DataType.NUMBER)
        @GreaterThan("0")
        @NumberInteger
        @NotEmpty
        Double interval) {
        //Other code
    }

}
}

```

Related concepts

[How to examples](#)

This section contains code examples and explanations about how to code some basic bot capabilities.

Custom triggers - pull and push mechanism

The examples provided in this topic demonstrate how to create time-based and event-based triggers, pull ([link TriggerDemo](#)) and push ([SimpleMessageListenerContainer](#)) mechanisms using the SDK package.

Example: Time-based triggers - Pull mechanism

The required conditions of triggering are tested at the regular interval, in seconds.

- A trigger checks the database (DB) at regular intervals and if the SQL (DB) value that a user provides is more than 0, then the timer-based trigger is triggered.
- When the event occurs, it runs the `consumer.accept(<RecordValue Instance>)` method and triggers an associated bot.
- It verifies the conditions at each run.
- Add the valid DB driver in the **build gradle** file to run this example.

This example is an extension of the timer-based trigger ([TriggerDemo](#)) and demonstrates the trigger pull mechanism.

Note: This is an illustrative example and do not use it in the production environment.

```

@BotCommand(commandType = BotCommand.CommandType.Trigger)
@CommandPkg(label = "JDBC Query Trigger", description = "JDBC Query
Trigger", icon = "jdbc.svg", name = "jdbcQueryTrigger",
return_type = RECORD, return_name = "TriggerData", return_description =
"Available keys: triggerType")
public class DBStatus {

private static Logger logger = LogManager.getLogger(DBStatus.class);

// Map storing multiple tasks
private static final Map<String, TimerTask> taskMap = new
ConcurrentHashMap<>();
private static final Timer TIMER = new Timer(true);

@TriggerId
private String triggerUid;
@TriggerConsumer
private Consumer consumer;

/*
* Starts the trigger.
*/
@StartListen
public void startTrigger(
@Idx(index="1", type = AttributeType.TEXT)
@Pkg(label = "Provide the database driver class")
@NotEmpty
String driverClassName,

@Idx(index="2", type = AttributeType.TEXT)
@Pkg(label = "Provide the Jdbc connection string")
@NotEmpty
String jdbcUrl,

@Idx(index="3", type = AttributeType.TEXT)
@Pkg(label = "Provide the user Name")
@NotEmpty
String userName,

@Idx(index="4", type = AttributeType.CREDENTIAL)
@Pkg(label = "Provide the password")
@NotEmpty
SecureString password,

@Idx(index="5", type = AttributeType.TEXT)
@Pkg(label = "Provide the SQL to check the records")
@NotEmpty
String sqlQuery,

@Idx(index = "6", type = AttributeType.NUMBER)
@Pkg(label = "Provide the interval to query in seconds", default_value =
"300", default_value_type = DataType.NUMBER)
@GreaterThan("0")
@NumberInteger
@NotEmpty
Double interval) {

DataSource dataSource = getDataSource(driverClassName, jdbcUrl, userName,
password);

```

```

TimerTask timerTask = new TimerTask() {

    @Override
    public void run() {
        logger.debug("checking DB");
        try {
            if(checkRecordsExist(dataSource.getConnection(), sqlQuery)){
                consumer.accept(getRecordValue());
                return;
            }
        } catch (SQLException e) {
            logger.warn(e.getMessage(), e);
            logger.warn("Trigger is still running.");
        }
        logger.debug("no records found");
    }
};

taskMap.put(this.triggerUid, timerTask);
TIMER.schedule(timerTask, interval.longValue(), interval.longValue());
}

private RecordValue getRecordValue() {
    List<Schema> schemas = new LinkedList<>();
    List<Value> values = new LinkedList<>();
    schemas.add(new Schema("triggerType"));
    values.add(new StringValue("DBStatus"));

    RecordValue recordValue = new RecordValue();
    recordValue.set(new Record(schemas, values));
    return recordValue;
}
/*
 * Cancel all the tasks and clear the map.
 */
@stopAllTriggers
public void stopAllTriggers() {
    taskMap.forEach((k, v) -> {
        if (v.cancel()) {
            taskMap.remove(k);
        }
    });
}

/*
 * Cancel the task and remove from the map
 *
 * @param triggerUid
 */
@stopListen
public void stopListen(String triggerUid) {
    if (taskMap.get(triggerUid).cancel()) {
        taskMap.remove(triggerUid);
    }
}

    public static DataSource getDataSource(String driverClassName, String
url, String userName, SecureString password) {
        BasicDataSource ds = new BasicDataSource();
        ds.setDriverClassName(driverClassName);
        ds.setUrl(url);
        ds.setUsername(userName);

```



```

        ds.setPassword(password.getInsecureString());
        return ds;
    }

    public static boolean checkRecordsExist(Connection con, String query)
        throws SQLException {

        Statement stmt = null;
        try {
            stmt = con.createStatement();
            ResultSet rs = stmt.executeQuery(query);
            rs.last();
            if(rs.getRow() > 0)
                return true;
        } catch (SQLException e ) {
            throw new BotCommandException("Problem running statemnt", e);
        } finally {
            if (stmt != null) { stmt.close(); }
        }
        return false;
    }

    public String getTriggerUid() {
        return triggerUid;
    }
    public void setTriggerUid(String triggerUid) {
        this.triggerUid = triggerUid;
    }
    public Consumer getConsumer() {
        return consumer;
    }
    public void setConsumer(Consumer consumer) {
        this.consumer = consumer;
    }
}

```

Example: Event-based triggers - Push mechanism

The trigger waits for an event to occur, for example, a message listener to start listening.

- An event details are stored in the memory and a message listener waits for a message.
- When the event occurs, it runs the `consumer.accept(<RecordValue Instance>)` method and triggers an associated bot..

The following example shows how to create a simple `ActiveMQ` message listener (`SimpleMessageListenerContainer`) to demonstrate the trigger push mechanism.

```

@BotCommand(commandType = BotCommand.CommandType.Trigger)
@CommandPkg(label = "JMS Trigger", description = "JMS Trigger", icon =
    "jms.svg", name = "jmsTrigger",
    return_type = RECORD, return_name = "TriggerData", return_description =
    "Available keys: triggerType")
public class JMSQueue implements SessionAwareMessageListener {

    // Map storing multiple MessageListenerContainer
    private static final Map<String, MessageListenerContainer> taskMap = new
    ConcurrentHashMap<>();

    @TriggerId
    private String triggerUid;
    @TriggerConsumer

```

```

private Consumer consumer;

//This method is called by MessageListenerContainer when a message arrives.
// At this point, the trigger get enabled
@Override
public void onMessage(javax.jms.Message message, Session session) throws
JMSEException {
    consumer.accept(getRecordValue());
}

private RecordValue getRecordValue() {
    List<Schema> schemas = new LinkedList<>();
    List<Value> values = new LinkedList<>();
    schemas.add(new Schema("triggerType"));
    values.add(new StringValue("JMSQueue"));

    RecordValue recordValue = new RecordValue();
    recordValue.set(new Record(schemas, values));
    return recordValue;
}
/*
 * Starts the trigger.
 *
 * Use this method to setup the trigger, such as, setup the
MessageListenerContainer and start it.
 */
@StartListen
public void startTrigger(@Idx(index = "1", type = AttributeType.TEXT)
@Pkg(label = "Provide the broker URL")
@NotEmpty
String brokerURL, @Idx(index = "2", type = AttributeType.TEXT)
@Pkg(label = "Provide the queue name")
@NotEmpty
String queueName) {

    if (taskMap.get(triggerUid) == null) {
        synchronized (this) {
            if (taskMap.get(triggerUid) == null) {
                SimpleMessageListenerContainer messageListenerContainer = new
SimpleMessageListenerContainer();
                messageListenerContainer.setConnectionFactory(new
PooledConnectionFactory(brokerURL));
                messageListenerContainer.setDestinationName(queueName);
                messageListenerContainer.setMessageListener(this);
                messageListenerContainer.start();
                taskMap.put(triggerUid, messageListenerContainer);
            }
        }
    }
}

/*
 * Cancel all the tasks and clear the map.
 */
@StopAllTriggers
public void stopAllTriggers() {
    taskMap.forEach((k, v) -> {
        v.stop();
        taskMap.remove(k);
    });
}

```

```

/*
 * Cancel the tasks and remove from the map
 *
 * @param triggerUid
 */
@stopListen
public void stopListen(String triggerUid) {
    taskMap.get(triggerUid).stop();
    taskMap.remove(triggerUid);
}

public String getTriggerUid() {
    return triggerUid;
}

public void setTriggerUid(String triggerUid) {
    this.triggerUid = triggerUid;
}

public Consumer getConsumer() {
    return consumer;
}

public void setConsumer(Consumer consumer) {
    this.consumer = consumer;
}
}

```

Related concepts

[How to examples](#)

This section contains code examples and explanations about how to code some basic bot capabilities.

Add debug logs of custom packages to **bot_launcher.log** file

You can add logs using `log4j`. The dependency is already added in the package SDK sample `build.gradle` file. Review the logging info using `RadioTypeDemo.java` file.

Example 1: Logger info - Get region value using `RadioTypeDemo` class

1. Review the code example where the logger is added in the code, open the `RadioTypeDemo.java` file located at `<your latest package-sdk-2.0.9\src\main\java\com\automationanywhere\botcommand\samples\commands\basic\types`

```

@BotCommand
@CommandPkg(label = "[[RadioTypeDemo.label]]",
description = "[[RadioTypeDemo.description]]", icon = "sample.svg", name
= "radioTypeDemo")
public class RadioTypeDemo {

    private static Logger logger =
    LogManager.getLogger(RadioTypeDemo.class);

    @Execute
    public void getRegionValue(@Idx(index = "1", type = AttributeType.RADIO,
options = {
        @Idx.Option(index = "1.1", pkg = @Pkg(label =
"[[RadioTypeDemo.region.1.1.label]]", value = "us_east")),
        @Idx.Option(index = "1.2", pkg = @Pkg(label =
"[[RadioTypeDemo.region.1.2.label]]", value = "us_west")),

```

```

    @Idx.Option(index = "1.3", pkg = @Pkg(label =
"[[RadioTypeDemo.region.1.3.label]]", value = "us_central"))
    })
    @Pkg(label = "[[RadioTypeDemo.region.label]]")
    @NotEmpty
    String region) {
        logger.info("Selected region is {}", region);
    }

```

2. Build a simple bot from the Automation 360 Demo package and select a radio group: **Radio Demo**.
3. Select an appropriate region, such as, US East.
4. Save and run the bot.
5. Access the folder where the logs were generated, the default log location: C:\ProgramData\AutomationAnywhere\BotRunner\Logs\Bot_Launcher.log.

If the logs get roll back from the `Bot_Launcher.log` file, then logs will create a folder based on the month when they were created, for example, 2021-May. Inside this folder, the logs will continue to generate.

6. Open the `Bot_Launcher.log` file and review the log info for the **RadioTypeDemo** and **selected region is us_east**.

Example 2: Assigning a value to clipboard

The following example accepts a user input or a variable and assigns it to clipboard.

```

@BotCommand
@CommandPkg(label = "Copy to", icon="assigntoclipboard.svg" , name =
"assignToClipboard", description
= "Accepts user input or a variable and assigns it to Clipboard",
node_label="{{value}}")
public class AssignToClipboard {

    private static Logger logger =
    LogManager.getLogger(AssignToClipboard.class);

    @Execute
    public static void assign(@Idx(index = "1", type = TEXT) @Pkg(label =
"Value") @NotEmpty String
        value) {

        logger.trace("Assigning '{}' value to clipboard.", value);
    }
}

```

Related concepts

[How to examples](#)

This section contains code examples and explanations about how to code some basic bot capabilities.

Handle sessions in a custom package

You can extract a session using a session name from the *SessionsMap*. In the same package, you can use sessions to pass information between actions, but not to other packages.

Configure the following attributes

- Apply an annotation to the class field and add a corresponding public setter.

- Retrieve the *SessionsMap* using the *Sessions* attribute.
- Set the variable type as *Map<String, Object>*.
- Set the *attributeType*: TEXT or SESSION. If *type = TEXT*, it is a regular session; if *type = SESSION*, it is a *sharedSession*.

Start a new session

```
@BotCommand
@CommandPkg(label = "Start session", name = "startSession", description =
"Start new session",
icon = "pkg.svg", node_label = "start session {{sessionName}}|") public
class Start {

    @Sessions
    private Map<String, Object> sessions;

    @Execute
    public void start(@Idx(index = "1", type = TEXT) @Pkg(label = "Session
name",
    default_value_type = STRING, default_value = "Default") @NotEmpty String
sessionName) {

        // Check for existing session
        if (sessions.containsKey(sessionName))
            throw new
BotCommandException(MESSAGES.getString("xml.SessionNameInUse",
sessionName));

        // Do some operation

        // Create new session
        sessions.put(sessionName, new Session(operation));
    }
    public void setSessions(Map<String, Object> sessions) {
        this.sessions = sessions;
    }
}
}
```

End a session

```
@BotCommand
@CommandPkg(label = "End session", name = "endSession", description = "End
session", icon =
"pkg.svg", node_label = "End session {{sessionName}}|")
public class EndSession {
    @Sessions
    private Map<String, Object> sessions;
    @Execute
    public void end(
        @Idx(index = "1", type = TEXT) @Pkg(label = "Session name",
default_value_type = STRING,
        default_value = "Default") @NotEmpty String sessionName) {

        sessions.remove(sessionName);
    }
}
```

```

    public void setSessions(Map<String, Object> sessions) {
        this.sessions = sessions;
    }
}

```

Add a session

In the below example, string objects are used (although in real actions, you can use complex objects).

```

@BotCommand
@CommandPkg(label = "[[SessionDemo.label]]", description =
    "[[SessionDemo.description]]", icon = "sample.svg", name = "sessionDemo")
public class SessionDemo {

    // Sessions are provided as a Map. Actions can add or remove entries in
    // this
    // Map.
    // The choice to reuse/overwrite/delete/add any Object in this Map belongs
    // to
    // the actions, and the framework makes no assumption regarding it.
    @Sessions
    private Map<String, Object> sessionMap;

    @Execute
    public void execute(@Idx(index = "1", type = TEXT)
        @Pkg(label = "[[SessionDemo.name.label]]")
        @NotEmpty
        String name) {
        if (!sessionMap.containsKey(name))
            sessionMap.put(name, "Some Value");
    }

    // Ensure that a public setter exists.
    public void setSessionMap(Map<String, Object> sessionMap) {
        this.sessionMap = sessionMap;
    }
}

```

Set a session variable

The below example shows how to develop an action (for example, Set session variable). In the action, the session details are retrieved and stored as a session variable so that the information can be used within a specific package.

```

@BotCommand
@CommandPkg(label = "[[SessionDemo2.label]]", description =
    "[[SessionDemo2.description]]", icon = "sample.svg", name = "SessionDemo2",
    return_type = DataType.STRING)
public class SessionDemo2 {

    // Sessions are provided as a Map. Actions can add or remove entries in
    // this
    // Map.

```

```
// The choice to reuse/overwrite/delete/add any Object in this Map belongs
to
// the actions, and the framework makes no assumption regarding it.
@Sessions
private Map<String, Object> sessionMap;

@Execute
public Value<?> execute(@Idx(index = "1", type = TEXT)
@Pkg(label = "[[SessionDemo2.name.label]]")
@NotEmpty
String name) {
    if (sessionMap.containsKey(name)) {
        return new StringValue(sessionMap.get(name));
    }
    return new StringValue("session does not exist");
}
// Ensure that a public setter exists.
public void setSessionMap(Map<String, Object> sessionMap) {
    this.sessionMap = sessionMap;
}
}
```

Related concepts

[How to examples](#)

This section contains code examples and explanations about how to code some basic bot capabilities.

Configure shared session using Package SDK

Package SDK provides configuration for the SDK users to create and use shared sessions. Sessions are seamlessly shared between different bots to share resources between them. This means that if a session has been created, the other TaskBots can read and update the session and vice versa.

Share session between parent and child

The following section describes creating a shared session. The parent *GlobalSessionDemoUpperCaseParent* returns a *Session value* to the global session and is used by the child bot *GlobalSessionDemoUpperCaseChild*.

Note: Place the three classes below in the following location: <PackageSDK>\src\main\java\com\automationanywhere\botcommand\samples\commands\basic

1. Create the following POJO class `DemoForSession` that implements `CloseableSessionObject`.

```
package
com.automationanywhere.botcommand.samples.commands.basic.GlobalSessionSampleProject

import
com.automationanywhere.toolchain.runtime.session.CloseableSessionObject;

import java.io.IOException;

public class DemoForSession implements CloseableSessionObject
{
    public void setClose(boolean close) {
        this.close = close;
    }

    boolean close=false;
    public String getDemo() {
```

```

        return demo;
    }

    public void setDemo(String demo) {
        this.demo = demo;
    }
    public DemoForSession(String demo){
        this.demo=demo;
    }
    String demo;

    @Override
    public boolean isClosed() {
        return close;
    }

    @Override
    public void close() throws IOException {

    }
}

```

2. Add the `@BotCommand` annotation to make a class as an Action in the Control Room. For more information on annotations, see [Annotations](#).

```
@BotCommand
```

3. Add the `@CommandPkg` annotation to define all the UI related components - *labels, description, icon, return_type, and name*. The elements *return_label, return_settings, return_type, and return_required* belonging to the `@CommandPkg` ensures that the SESSION is returned by the parent bot.

```

@CommandPkg (
    //Unique name inside a package and label to display.
    name = "GlobalSession", label = "Global session uppercase parent",
    node_label = "Shared session parent node label", description = "Shared
    session parent description", icon = "pkg.svg",

    //Return type information. return_type ensures only the right kind of
    variable is provided on the UI.
    return_label = "Return the parent session",
    return_settings = {ReturnSettingsType.SESSION_TARGET},
    return_type = SESSION,
    return_required = true)

```

4. Create the `GlobalSessionDemoUpperCaseParent` object. The `GlobalSessionDemoUpperCaseParent` gets a lower case string input from the action's input, converts it to an upper case string and store the result in the `SessionValue`.
 - Annotate the method with `@Execute` to execute the method during compilation.

```

package
    com.automationanywhere.botcommand.samples.commands.basic.GlobalSessionSampleProje

import com.automationanywhere.botcommand.data.impl.SessionValue;
import com.automationanywhere.commandsdk.annotations.*;
import com.automationanywhere.commandsdk.annotations.rules.NotEmpty;
import com.automationanywhere.commandsdk.model.ReturnSettingsType;
import org.apache.logging.log4j.LogManager;
import org.apache.logging.log4j.Logger;

import java.util.Map;

```



```

import static
    com.automationanywhere.commandsdk.model.AttributeType.TEXT;
import static com.automationanywhere.commandsdk.model.DataType.SESSION;

//BotCommand makes a class eligible for being considered as an action.
@BotCommand

//CommandPks adds required information to be dispalable on GUI.
@CommandPkg(
    //Unique name inside a package and label to display.
    name = "GlobalSession", label = "Global session uppercase parent",
    node_label = "Shared session parent node label", description =
    "Shared session parent description", icon = "pkg.svg",

    //Return type information. return_type ensures only the right kind of
    variable is provided on the UI.
    return_label = "Return the parent session",
    return_settings = {ReturnSettingsType.SESSION_TARGET},
    return_type = SESSION,
    return_required = true)
public class GlobalSessionDemoForStringUpperCaseParent {
    private static Logger logger =
        LogManager.getLogger(GlobalSessionDemoForStringUpperCaseParent.class);

    //Identify the entry point for the action. Returns a SessionValue
    because the return_type is SESSION.
    @Execute
    public SessionValue action(
        //Idx 1 would be displayed first, with a text box for entering the
        value.
        @Idx(index = "1", type = TEXT)
        //UI labels.
        @Pkg(label = "Enter string in lower case")
        //Ensure that a validation error is thrown when the value is null.
        @NotEmpty
        String firstString) {
        String result = firstString.toUpperCase();
        DemoForSession demoForSession= new DemoForSession(result);
        return SessionValue
            .builder()
            .withSessionObject(demoForSession)
            .build();
    }
}

```

5. Create the *GlobalSessionDemoUpperCaseChild* object. The *GlobalSessionDemoUpperCaseChild* gets a lower case string input from the action's input, converts it to upper case and concatenates it with the *SessionValue* received from the parent bot.

```

package
    com.automationanywhere.botcommand.samples.commands.basic.GlobalSessionSampleProject

import com.automationanywhere.botcommand.data.Value;
import com.automationanywhere.botcommand.data.impl.StringValue;
import
    com.automationanywhere.botcommand.samples.commands.basic.Uppercase;
import com.automationanywhere.commandsdk.annotations.*;
import com.automationanywhere.commandsdk.annotations.rules.NotEmpty;
import com.automationanywhere.commandsdk.annotations.rules.SessionObject;
import com.automationanywhere.commandsdk.model.AttributeType;
import com.automationanywhere.commandsdk.model.DataType;

```

```

import org.apache.logging.log4j.LogManager;
import org.apache.logging.log4j.Logger;

import static com.automationanywhere.commandsdk.model.AttributeType.TEXT;
import static com.automationanywhere.commandsdk.model.DataType.STRING;

//BotCommand makes a class eligible for being considered as an action.
@BotCommand

//CommandPkgs adds required information to be disalable on GUI.
@CommandPkg(
    //Unique name inside a package and label to display.
    name = "GlobalSessionChild", label = "Global session upper case child",
    node_label = "Global session child node label",
    description = "Global session child description", icon = "pkg.svg",

    //Return type information. return_type ensures only the right kind of
    variable is provided on the UI.
    return_label = "Return the concatenated string to", return_type =
    STRING, return_required = true)
public class GlobalSessionDemoUpperCaseChild {
    private static Logger logger = LogManager.getLogger(Uppercase.class);

    @Execute
    public Value<String> action(
        //Idx 1 would be displayed first, with a text box for entering the
        value.
        @Idx(index = "1", type = TEXT)
        //UI labels.
        @Pkg(label = "Enter a sting in lower case to concatenate")
        //Ensure that a validation error is thrown when the value is null.
        @NotEmpty
        String sourceString,
        @Idx(index = "2", type = AttributeType.SESSION)
        @Pkg(label = "sharedSession", description = "sharedSession",
            default_value = "Default", default_value_type = DataType.SESSION)
        //Using the sessionObject annotation here as its a consumer class
        @SessionObject
        DemoForSession session) {

        //Business logic
        String result = sourceString.toUpperCase();
        logger.info("session: {}", session);
        return new StringValue(result+session.getDemo().toUpperCase());
    }
}

```

6. Build and upload the custom package to the Control Room. For more information on uploading the package, see [Using the package SDK](#).
7. Create a bot by using the **Global session uppercase parent** action.
 - a. Enter a lower case string (For example: *parentbot string*)
 - b. Enter a name for the session. The parent bot returns the value to the Global session (For example: Global)
8. Create a TaskBots by using the **Global session upper case child** action. You will be able to input a lower case string and also get the string from the shared parent session. Concatenate the parent and child strings.

9. Use a **Message box** to show the output.

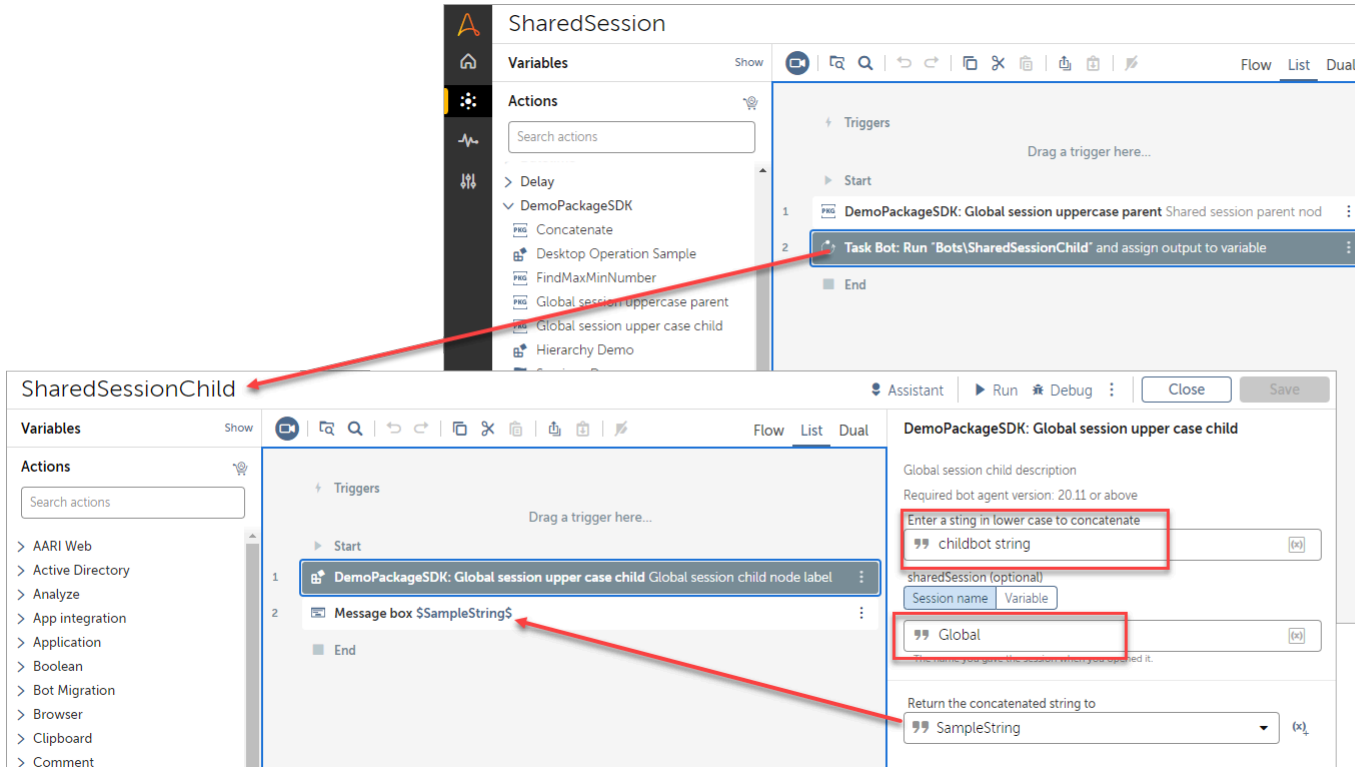

10. Now call the **Global session upper case child** into the parent.

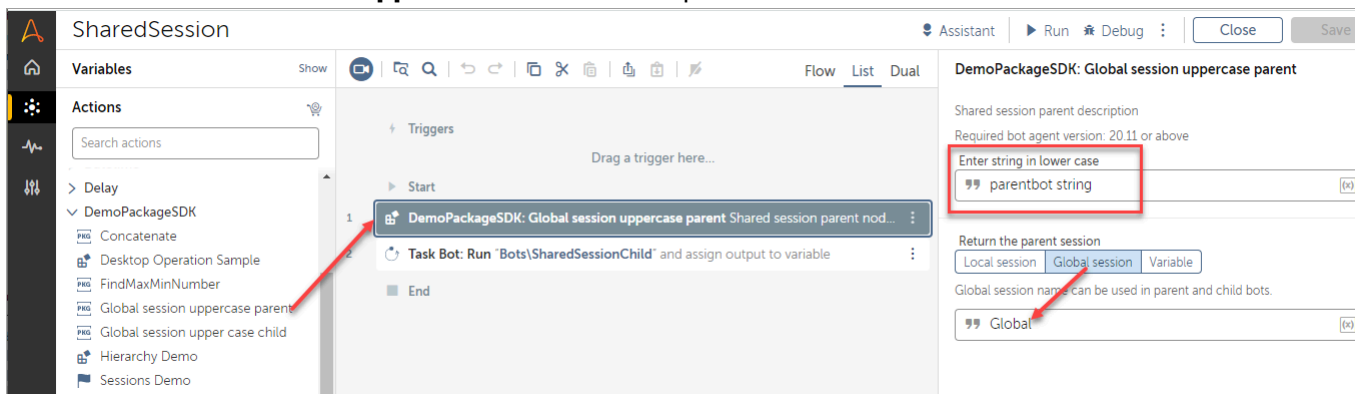

11. Run the parent bot and you will see the message box showing the value from the Child bot which it derived using the Shared global session.

Build bots to share session details using Package SDK

A shared session enables you to reuse actions between TaskBots that run concurrently, for example, using the same Excel file to pass values.

Ensure you have the following to build a TaskBot:

- Access to the Control Room
- Credentials with **AAE_Basic** permissions
- A development license, which enables you to create and run TaskBots
- Your workstation is a registered device in the Control Room

- An Excel file that you want to use in the shared session actions
1. Log in to the Control Room.
 2. Create three TaskBots that will share the shared session actions.
 3. Create a new *childSession2* variable of **Type > Session** and **Session type > MS Excel session**, select **Use as input**, and then click **Apply**.
 4. On the left pane, click **Automation**.
A list of available and forms is displayed.
 5. Click the **Create a bot** icon.
 6. Create a new bot called *childBot2*.
 - a) In the **Name** field, enter *childBot2*.
 - b) In the Actions pane, find **Excel Advanced**, and drag **Get current worksheet name** to the Bot editor.
 - c) In **Session name > Shared session**, enter **F2 > childSession2**, and in **Assign the output to variable**, select **prompt-assignment**.
 7. Create a new *parentSession* variable of **Type > Session** and **Session type > MS Excel session**, and then click **Apply**.
 8. Create a new bot called *parentSession*, and click **Create & Edit**.
 9. In the Actions pane, find **Excel Advanced**, and drag **Open** to the Bot editor.
 - a) In **File path**, select **Desktop file**, click **Browse**, and navigate to the Excel file that you want to use.
 - b) In **Session name**, retain **Default**.
 - c) Click **Save**.
 10. Create a new *childSession1* variable of **Type > Session** and **Session type > MS Excel session**, select **Use as input**, and then click **Apply**.
 11. Create a new bot called *childBot1*.
 - a) In the **Name** field, enter *childBot1*.
 - b) In the Actions pane, find **Excel Advanced**, and drag **Get single cell** to the Bot editor.
 - c) Select **Active cell** in **Session name**, and select **Local name**, enter **F2**, and then in **Store cell content to**, select **prompt-assignment**.
 12. In the Actions pane, find **Excel Advanced**, and drag **Set session variable** to the Bot editor.
 - a) In **Session name**, retain **Default**.
 - b) In **Save session to a variable**, select **parentSession**.
 13. From the Actions pane, find **Task Bot**, and drag **Run** to the Bot editor.
 - a) In **Task Bot to run**, select **Control Room file**, click **Choose**, and then **Browse**, and select **childBot1**.
 - b) In **Input values**, select **Set childSession1**, enter **F2**, and select **parentSession**.
 14. In the Actions pane, find **Excel Advanced**, and drag **Close**, select **Session name** as **Local name**, and retain **Default**.
 15. In the Actions pane, find **Message box**. In **Enter the message to display**, enter **F2**, and then select **prompt-assignment**.

16. From the Actions pane, select **Task Bot**, and drag **Run** to the Bot editor.
 - a) In **Task Bot to run**, select **Control Room file**, click **Choose**, and then **Browse**, and then select **childBot2**.
 - b) In **Input values**, select **Set childSession2**, enter **F2**, and select **childSession1**.
17. In the Actions pane, find **Message box**. In **Enter the message to display**, enter **F2**, and select **prompt-assignment**.
18. Save all three bots and run the **parentSession** TaskBot.

The following three messages are displayed:

```
Single cell value from parent bot:1
```

```
Current worksheet name of excel opened in parent bot: Sheet1 <name of the sheet>
```

```
Your bot has run successfully!
```

Related concepts

[How to examples](#)

This section contains code examples and explanations about how to code some basic bot capabilities.

Annotations

This section provides reference information about the annotations used to create Automation Anywhere packages.

- [Creation and function annotations](#)

List of the available creation and function annotations.

- [Validation annotations](#)

Validates annotated strings and values used in the Java code.

- [Configure and use credential allow password annotation](#)

Use the provided **CredentialTypeDemo.java** package SDK file and configure the **CredentialAllowPassword** annotation for the password field in Automation 360 locker actions.

Related concepts

[Standard coding practices and guidelines for developing packages](#)

This topic covers standard coding practices and guidelines that help to ensure the development of high quality packages.

[How to examples](#)

This section contains code examples and explanations about how to code some basic bot capabilities.

Related tasks

[Set up the Java project](#)

Set up an integrated development environment (IDE) for Java, including Automation Anywhere custom annotations to develop an action package that you can upload to your Control Room.

[Develop a sample package](#)

Develop your own package and upload it to an Control Room to provide custom actions for bots.

Creation and function annotations

List of the available creation and function annotations.

Annotation: BotCommand

Makes the type eligible to be treated as an *action*. You can define three types of actions **commandType** property.

- Command\Action
- Condition
- Iterator

Examples:

- `@BotCommand(commandType = BotCommand.CommandType.Iterator)`
- `@BotCommand(commandType = Condition)`
- `@BotCommand(commandType = Varialbe)`
- `@BotCommand(commandType = Trigger)`

Annotation: CommandPkg

Makes the type eligible for creation of action **package.json**. This annotation must be used with **BotCommand** to take effect.**Pkg** participates in the activity only when this annotation is present.

Example:

```
@CommandPkg(label = "Create", name = "createFile",
description = "Creates a file", node_label = "{{filePath}}",
icon = "file.svg")
```

Annotation: ConditionTest

Participates in the **Condition** execution. This annotation can only be used when the **BotCommand** has **commandType** set as **Condition**. Only one method needs to be annotated when **BotCommand** annotation is present on the type. Failure to do so will result in the compilation error.

Annotation: Execute

Participates in the execution of **BotCommand**. Exactly one method needs to be annotated when **BotCommand** annotation is present on the type. Failure to do so will result in the compilation error.

Example:

```
@Execute public void create( @Idx(index = "1", type = FILE) @LocalFile
@Pkg(label =
"File", description = "e.g. C:\\MyDoc\\MyFile.doc") @NotEmpty String
filePath,
@Idx(index = "2", type = CHECKBOX) @Pkg(label = "Overwrite an existing
file")
@NotEmpty Boolean isOverwrite) { createFile(filePath, isOverwrite); }
```

Annotation: GlobalSessionContext

Can only be applied to member variables and fetches the `GlobalSessionContext` through a setter.

Example:

```
@com.automationanywhere.commandsdk.annotations.GlobalSessionContext
private GlobalSessionContext globalSessionContext;

public void setSessionMap(Map < String, Object > sessionMap) {
    this.sessionMap = sessionMap;
}
public void
setGlobalSessionContext (com.automationanywhere.bot.service.GlobalSessionContext
globalSessionContext) {
    this.globalSessionContext = globalSessionContext;
}
```

Annotation: HasNext

Participates in the execution of `Iterator`. This annotation can only be used when the `BotCommand` has `commandType` set as `Iterator`. Requires the `Next` annotation to be present. One method needs to be annotated when `BotCommand` annotation is present on the type. Failure to do so will result in the compilation error.

Annotation: Index

Makes the annotated element part of hierarchy utilized for the code and resource generation. Without this annotation no `BotCommand` related element annotations would be processed.

Annotation: Idx.Option

An option represents the elements that would play in the hierarchy, but lend the values to the parents.

Examples:

- RADIO

```
@Idx(index = "1", type =RADIO, options = {
    @Idx.Option(index = "1.1", pkg = @Pkg(node_label
= "[[Delay.delayType.1.1.node_label]]", label =
"[[Delay.delayType.1.1.label]]", value = REGULAR)),
    @Idx.Option(index = "1.2", pkg = @Pkg(node_label
= "[[Delay.delayType.1.2.node_label]]", label =
"[[Delay.delayType.1.2.label]]", value = RANDOM)
})
@Pkg(label = "[[Delay.delayType.label]]", default_value = "REGULAR",
default_value_type = DataType.STRING)
@Inject
private String delayType;
```

- SELECT

```
@Idx(index = "2", type = SELECT, options = {
@Idx.Option(index = "2.1", pkg = @Pkg(label =
"[[LaunchWebsite.browser.2.1.label]]", value = "DEFAULT")),
```

```
@Idx.Option(index = "2.2", pkg = @Pkg(label =
  "[[LaunchWebsite.browser.2.2.label]]", value = "INTERNET_EXPLORER")),
@Idx.Option(index = "2.3", pkg = @Pkg(label =
  "[[LaunchWebsite.browser.2.3.label]]", value = "FIREFOX")),
@Idx.Option(index = "2.4", pkg = @Pkg(label =
  "[[LaunchWebsite.browser.2.4.label]]", value = "CHROME"))
}) @Pkg(label = "[[LaunchWebsite.browser.label]]", default_value =
  "DEFAULT", default_value_type = DataType.STRING) @NotEmptyStringbrowser)
```

Annotation: Inject

Makes an element eligible for injection into the annotated type object. The injection is setter-based so a corresponding setter in the type is **mandatory**. The injected values would form the **BotCommand** parameter map using the name provided in **Idx**.

Annotation: Next

Participates in the **Iterator** execution. This annotation can only be used when the **BotCommand** has `commandType` set as **Iterator**. Requires the `HasNext` annotation to be present. One method needs to be annotated when **BotCommand** annotation is present on the type. Failure to do so will result in compilation error.

Annotation: Pkg

Makes an element to participate in the `package.json` creation. This annotation is ignored when **Idx** is not present.

Related concepts

[Annotations](#)

This section provides reference information about the annotations used to create Automation Anywhere packages.

Validation annotations

Validates annotated strings and values used in the Java code.

Annotation	Description
CodeType	The MIME-type of the code to format.
CredentialOnly	Can only accept a credential value, no string allowed.
Equals	Validates that the given string is equal to the annotated string variable.
FileExtension	Validates the annotated string value that ends with the supported extension type.
GreaterThan	Validates that the annotated number variable value is always greater than the given numeric value.
GreaterThanEqualTo	Validates that the annotated number variable value is always greater than or equal to the given numeric value.

Annotation	Description
LessThan	Validates that the annotated number variable value is always less than the given numeric value.
LessThanEqualTo	Validates that the annotated number variable value is always less than or equal to the given numeric value.
LocalFile	Can only accept local paths and no file expression.
MatchesRegex	Validates that the annotated string value matches the given regular expression.
NotEmpty	Validates and throws an exception when the annotated variable value is null. <pre>@Execute public Value<Double>length (@Idx (index="1", type=TEXT) @Pkg (label="Source string") @NotEmpty String sourceString) {}</pre>
NotEquals	Validates that the given string is not be equal to the annotated string variable.
NotMatchesRegex	Validates that the annotated string value does not match the given regular expression.
NumberInteger	Ensures the UI accepts only integers and not double for the annotated variable value.
RepositoryFile	Can only accept repository paths and no file expression.
VariableNotPackage	Cannot choose a variable from this package.
VariablePackage	Can only choose a variable from this package.
VariableSubType	The variable subtype must match.
VariableType	The variable type must match.
VariableUserDefined	Can only choose a user-defined variable.

Related concepts

[Annotations](#)

This section provides reference information about the annotations used to create Automation Anywhere packages.

Configure and use credential allow password annotation

Use the provided **CredentialTypeDemo.java** package SDK file and configure the **CredentialAllowPassword** annotation for the password field in Automation 360 locker actions.

Example: Review the CredentialTypeDemo.java

Use the following `CredentialTypeDemo.java` file located at: `<latest package-sdk>2.0.9\src\main\java\com\automationanywhere\botcommand\samples\commands\basic\types` as an example on how to configure the credential attribute.

```
@BotCommand
@CommandPkg(label = "[[CredentialTypeDemo.label]]",
description = "[[CredentialTypeDemo.description]]", icon = "sample.svg",
name = "credentialTypeDemo")
public class CredentialTypeDemo {

private static Logger logger =
LogManager.getLogger(CredentialTypeDemo.class);

/**
 * To accept credentials the {@link AttributeType} in index should be
 * {@link AttributeType.CREDENTIAL CREDENTIAL}. A {@link SecureString} is
 * provided for any credentials type.
 */
@Execute
public void printCredentials(@Idx(index = "1", type =
AttributeType.CREDENTIAL)
@Pkg(label = "[[CredentialTypeDemo.credentials.label]]")
SecureString credentials) {
// SecureString provides multiple way to access the data inside.
// Let's try to get the user name and print it in logs.

// To get the username as String
String userName = credentials.getInsecureString();
logger.trace("User name from getInsecureString : {}", userName);
}
```

Example: Configure the credential attributes @Execute

Configure the index, type, label, optional description, and the `credentialAllowPasswordAttribute`. When creating a new or updating an existing package, use the **CredentialAllowPassword** annotation to allow the credential picker to pick a credential attribute marked as a password field.

```
@Execute
public void printCredentials(@Idx(index = "2", type =
AttributeType.CREDENTIAL)
@Pkg(label =
"[[CredentialTypeDemo.credentialsAllowPasswordAttribute.label]]")
@CredentialAllowPassword SecureString credentialAllowPasswordAttribute) {
```

Configure the attributes in the Control Room

In the **Attribute name** field, enter `password` and an optional **description**, in **Input** field, select **Standard**, and enter the `Value`. In the **Security** field, select **Use attribute only on Password or Masked fields**.

Use the credential attribute in Control Room

- In the **Pick a credential** field, select **credential**. In the **Attribute** field, select **username**. In the **Provide the credential for the user (optional)** field, select **Credential**, and then **Pick**.
- In the **Attribute** field, select **password**. In the **Provide the credential for the password (optional)** field, select **Credential**, and then **Pick**.

Build and test a demo package and bot

This practical how to section demonstrates that creating, changing, and managing packages allow you to customize actions and efficiently manage packages for all Control Room users.

Here is a list of all the necessary tasks to create a package, add the package to your Control Room, and verify your work in a bot. Complete the listed tasks in order.

Tip: Click the title of each step to go the detailed task.

Step 1 [Update related workflow and build files](#)

Follow the detailed steps for updating workflow and build files for this project using your integrated development environment (IDE).

Step 2 **Choose your favorite IDE**

You can compile a package from the IDE of your choice. Here are two possible ways you can compile a package:

[Compile a demo JAR file from the Eclipse UI](#)

Use Eclipse to compile a demo JAR file that you can add as a package to your Control Room.

[Compile a demo JAR file from the command line](#)

Compile the demo Java code provided with this software development kit.

Step 3 [Add your demo package to the Control Room](#)

Users with **Upload package** permission can add packages to the Control Room for use by all Bot Creators.

Step 4 [Create a demo bot with the demo package](#)

Create a bot using the demo package to verify the actions that were created.

Step 5 [Change the Java file used to create the package JAR file](#)

Modify and compile the Java code used to create a package to fix issues and create new functionality.

Step 6 [Upload new demo package](#)

Package management allows you to upload package updates. The new package has the same name, but a different version number.

Step 7 [Update the demo bot with the updated package](#)

Update bots to use specific package versions.

Update related workflow and build files

Follow the detailed steps for updating workflow and build files for this project using your integrated development environment (IDE).

Complete all the steps for project setup detailed in [Set up the Java project](#).

This task shows you how to update the appropriate build and workflow files.

1. Open the project "A2019DemoPackage" that you created in [Set up the Java project](#).
You can find the project file in the directory where you extract the zip files to, for example `c:\A2019DemoPackage`.
2. From inside the project, Open the **settings.gradle** file.
3. Replace the project name with `A2019DemoPackageFirstnameLastname`.
If your name is John Developer it would look like this, `A2019DemoPackageJohnDeveloper`.
4. Open **src > main > resources > package.template**.

5. Update the **name**, **label**, and **description** values.

Original package.template	Updated package.template
<pre>{ "name": "A2019DemoPackage", "label": "A2019DemoPackage", "description": "Provides actions for A2019DemoPackage operations.", "group": "", "artifactName": "", "packageVersion": "", "codeVersion": "", "commands": [] }</pre>	<pre>{ "name": "A2019DemoPackageFirstnameLastname", "label": "A2019DemoPackageFirstnameLastname", "description": "A2019DemoPackageFirstnameLastname", "group": "", "artifactName": "", "packageVersion": "", "codeVersion": "", "commands": [] }</pre>

6. Save the changes.

After you have setup the build files, you need to compile the demo Java code, [Compile a demo JAR file from the command line](#).

Compile a demo JAR file from the Eclipse UI

Use Eclipse to compile a demo JAR file that you can add as a package to your Control Room.

Before starting this task complete the steps in [Update related workflow and build files](#).

Build a package file using a Gradle project in the Eclipse IDE.

1. Import the A2019DemoPackage as a Gradle project, **File > Import > Gradle > Existing Gradle Project** and click **Finish**.
2. From the **Gradle Tasks** tab, go to **<your project> > build** and run the following tasks in order.
 - a) **<your project> > build > clean**
 - b) **<your project> > build > build**
3. From the **Gradle Tasks** tab, go to **<your project> > shadow** and run the **shadowJar** task.

Your compiled package file is located in **file:\ \A2019DemoPackage\build\libs**. The package file has named after your project name (**<your project>-1.0.0.jar**).

To add your custom package to your Control Room follow the instructions in [Add packages to the Control Room](#).

Related concepts

[Build and test a demo package and bot](#)

This practical how to section demonstrates that creating, changing, and managing packages allow you to customize actions and efficiently manage packages for all Control Room users.

Compile a demo JAR file from the command line

Compile the demo Java code provided with this software development kit.

Before starting this task complete the steps in [Update related workflow and build files](#).

1. Open a terminal window and go to where the **gradlew.bat** file is located.

```
... \A2019DemoPackage > gradlew.bat
```

2. In the terminal window, type `gradlew.bat clean build shadowJar`, and press **Enter**. Here is an example of what you see:

```
> . . .\A2019DemoPackage>gradlew.bat clean build shadowJar

> Task :compileJava
Note: Starting hierarchy discovery for
'com.automationanywhere.botcommand.demo.Concatenate'
Note: Starting non-hierarchical element discovery for
'com.automationanywhere.botcommand.demo.Concatenate'
Note: Starting hierarchy discovery for
'com.automationanywhere.botcommand.demo.Uppercase'
Note: Starting non-hierarchical element discovery for
'com.automationanywhere.botcommand.demo.Uppercase'
Note: Starting Command Java generator...
Note: Starting Json generator...
Note: Generating command json for Concatenate
Note: Generating command json for Uppercase

> Task :commandCodeGen
mergeJsonFiles: updatePackage: group com.automationanywhere ,
artifactName A2019DemoPackageFirstnameLastname ,
packageVersion 1.0.0-20190816-101906
```

The compiled file is located in **file:\ \A2019DemoPackage\build\libs**.

To add your custom package to your Control Room follow the instructions in [Add packages to the Control Room](#).

Related concepts

[Build and test a demo package and bot](#)

This practical how to section demonstrates that creating, changing, and managing packages allow you to customize actions and efficiently manage packages for all Control Room users.

Add your demo package to the Control Room

Users with **Upload package** permission can add packages to the Control Room for use by all Bot Creators.

Before you can upload a package, you need valid user login credentials with **Upload package** permission for the Control Room you are adding the package to.

To add a package from a source other than Bot Store, follow these steps:

1. Navigate to **Manage > Packages**.
2. Click **Add package**.
3. Click **Browse**.
4. Locate and select the package to add to the Control Room.
Packages are Java Archive (JAR) files that contain actions used to create bots.
5. Click **Upload package**.
6. On the **Bots > Packages > Confirm package** page, choose any of the following options:
 - **Accept, enable and set as default:** Uploads and enables the selected package, and sets it to the default package for the Control Room.
 - **Accept and enable:** Uploads and enables the package, but the package is not set as the default package. Bot Creators have to specifically select non-default packages to use them for creating bots.
 - **Accept but disable:** Uploads and disables the new package.

Choosing **Reject** stops the upload process.

To add a package from Bot Store, see the following video:

- After installation, click **Administration** > **Packages** to verify that the package is added.
When you add or update a package in the Control Room, a notification is also sent through the **Notifications** icon. This notification is sent to the Control Room users who have the **View package** permission. For more information, see [Add or update package](#) event notification.

After successfully uploading your demo package, create a bot to test the actions you just created. For detailed step about how to create a bot, read [Create a demo bot with the demo package](#)

Create a demo bot with the demo package

Create a bot using the demo package to verify the actions that were created.

Here are the minimum prerequisites for building this demo bot:

- Access to a Control Room
- User credentials with **AAE_Basic** permission
- Your local host (workstation) is a registered device in the Control Room
- Ensure that the demo package **A2019DemoPackageFirstnameLastname** is available in the Control Room

This task uses the following actions and components:

- Uppercase (demo package)
 - [Message box](#)
 - [Variables overview](#)
- On the left pane, click **Automation**.
A list of available and forms is displayed.
 - Click the **My Task Bot** icon.
 - Type `MyDemoBot1` in the **Name** field.
 - Click **Create & Edit**.
 - Expand **A2019DemoPackageFirstnameLastname** and double **Uppercase**.
 - Type `hello world, go be great!` in all lower case letters.
 - Create the variable `vMyDemoVar1`.
 - Click **Apply**.
 - Add a **Message box** and insert the variable **vMyDemoVar1** in the **Enter the message to display** field.
 - Click **Apply** and **Save**.
 - Click the **Run** icon.
A message box with "HELLO WORLD, GO BE GREAT!" in all upper case letters is displayed. The custom action **Uppercase** converted all the letters from lower case letters to upper case letters.

The task, [Change the Java file used to create the package JAR file](#), gives instruction on how to modify the **Uppercase** action to convert all upper case letters to lower case letters.

Change the Java file used to create the package JAR file

Modify and compile the Java code used to create a package to fix issues and create new functionality.

- Open the project "A2019DemoPackage."

- From inside the project, open **src/main/java/com.automationanywhere.botcommand.samples.commands/basic/Uppercase** .
- Change the function from upper case to lower case.

Original function	Updated function
<pre>String result = "ALL".equals(caseType) ? sourceString.toUpperCase() : (sourceString .substring(0, 1).toUpperCase() + sourceString .substring(1));</pre>	<pre>String result = "ALL".equals(caseType) ? sourceString.toLowerCase() : (sourceString .substring(0, 1).toUpperCase() + sourceString .substring(1));</pre>

- Save the changes and re-compile the package.

You can now upload the changed package to the Control Room. [Upload new demo package](#)

Related tasks

[Upload new demo package](#)

Package management allows you to upload package updates. The new package has the same name, but a different version number.

Upload new demo package

Package management allows you to upload package updates. The new package has the same name, but a different version number.

You need **AAE_Basic** permissions to create and edit bots.

- From the **Bots > Packages** page, click the **Add package** icon.
- Browse** to the location of the package to add.
Packages are Java Archive (JAR) files that contain actions used to create bots.
- Select the package to add, and click **Upload package**.
- On the **Bots > Packages > Confirm package** page, click **Accept, enable and set as default**.

You can select specific packages to be used from within a bot. Read detailed steps about managing packages for specific bots in [Update the demo bot with the updated package](#) task.

Update the demo bot with the updated package

Update bots to use specific package versions.

- Access to the bot created in the task [Create a demo bot with the demo package](#).
- AAE_Basic** permission.

- On the left pane, click **Automation**.
A list of available and forms is displayed.
- Double-click **MyDemoBot1**, the demo bot you created in an earlier task.
- Click the **vertical eclipses** in the upper right corner and click **Packages**.
- Expand the row for the package **A2019DemoPackageFirstnameLastname**.
- From the drop-down list of package versions, select the **Default** version.

Because you added the updated package as the default version, you are selecting the new version of the package you created.

6. Click **Change Version** and **Save**.
7. On the left pane, click **Automation**.
A list of available and forms is displayed.
8. Double-click **MyDemoBot1**.
9. Click **A2019DemoPackageFirstnameLastname** and type HELLO WORLD, GO BE GREAT! in the **Source string** field.
10. Click **Apply** and **Save**.
11. Click the **Run** icon.
The message box displayed by the bot displays "hello world, go be great!" This verifies that the action from the updated package is being used.

Build and test a custom package

Use IntelliJ to build a custom package and use Automation 360 actions to test the package.

Complete the following tasks to create a custom package, upload the package to your Control Room, and build a bot to test it. After you update the IntelliJ files, create directories, and create and update java classes, you can build the custom package.

1. *Build a custom package in IntelliJ*
Use IntelliJ to import the Automation Anywhere SDK, create a new package, and compile a JAR file that you can upload to your Control Room.
2. *Add custom package to your Control Room*
Use the compiled JAR file and upload it to the Control Room.
3. *Create a bot to test the custom package*
Use Automation 360 actions to create a bot to test the custom package.

Note: The customer support team does not provide guidance for the code written by customers.

See also: [Create custom packages](#)

Build a custom package in IntelliJ

Use Java IntelliJ to create and compile a JAR file that you can upload as a package to your Control Room in Automation 360.

A basic understanding of JDK and Java IntelliJ is required in order to build an action package. Ensure you have installed the following software and files:

- [Java SE Development Kit 11 Downloads](#)
 - Java IDE [Community edition of IntelliJ](#)
1. Download the latest release of the Automation Anywhere **Package SDK**. For the latest release of the Package SDK, see - [Automation 360 Package SDK Release Notes](#).
 2. Unzip the contents of the SDK package to any of your local directory.
 3. Rename the folder from A360-package-sdk-`<version number>` to `MetricToImperial`.
 4. In IntelliJ IDEA, go to **File > Open** and open the project at `C:\<SavedLocation>\MetricToImperial`.

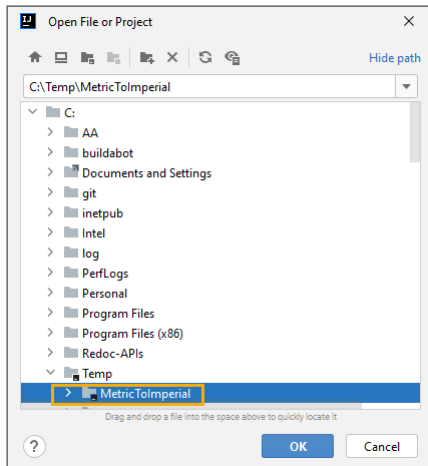

5. Open the `settings.gradle` file in the project root. Set the `rootProject.name = 'MetricToImperial'`

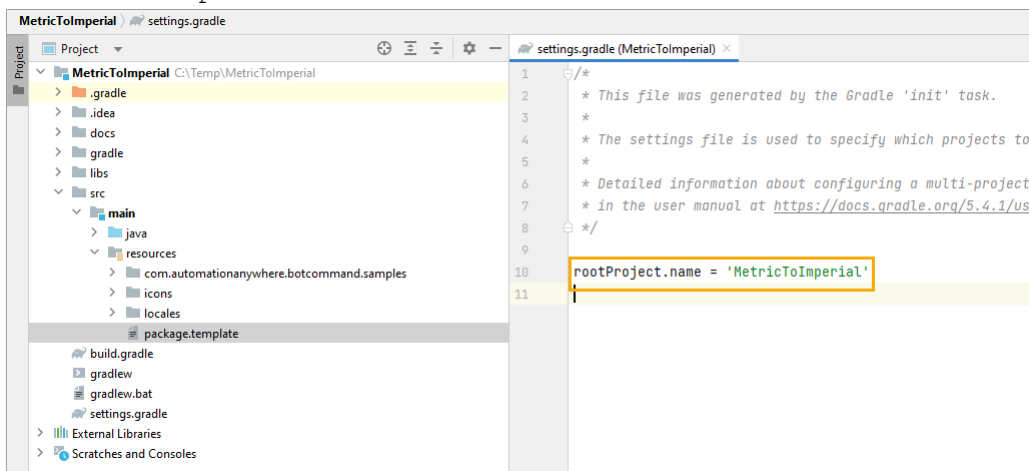

6. Open the `package.template` file located at `src > main > resources > package.template`.
7. Change the package name from `A360DemoPackage` to `MetricToImperial`.

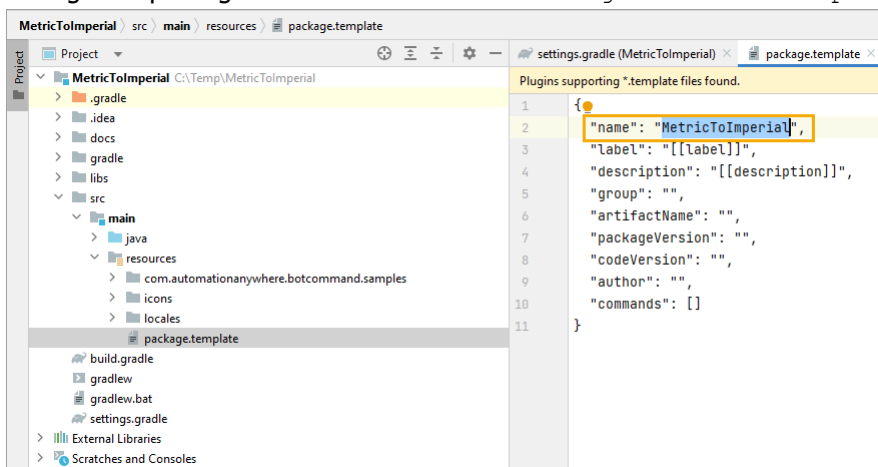

Click the **Sync** button in IntelliJ to update the project.

8. Update the package name in **locales json**: go to **src > main > resources > locales > en_US.json**.
 - a) Open the **en_US.json** file and update the **required** label field from A360DemoPackage to MetricToImperial. Update the optional description.
 - b) Delete all other remaining lines in the **en_US.json** file.
9. Delete the sample packages, go to **src > main > java > com.automationanywhere.botcommand**, and delete the `samples.commands` and delete the `samples` packages.
10. Create a new package, right-click on java folder and select **New > Package**. Enter the new package name as `metrictoimperial.commands`.
11. Create a new **Java Class**, right-click on the `metrictoimperial.commands` package, and select **New > Java Class**. Enter the name for the new class `CMtoINCH`:
 - a) Open the **CMtoINCH** class. Copy and paste the following code above the class definition statement:

```
import static com.automationanywhere.commandsdk.model.DataType.NUMBER;
//BotCommand makes a class eligible for being considered as an action.
@BotCommand
//CommandPks adds required information to be disalable on GUI.
@CommandPkg(
    //Unique name inside a package and label to display.
    name = "CMtoInch", label = "[[CMtoINCH.label]]",
    node_label = "[[CMtoINCH.node_label]]", description =
    "[[CMtoINCH.description]]", icon = "ruler_icon.svg",
    //Return type information. return_type ensures only the right
    kind of variable is provided on the UI.
    return_label = "[[CMtoINCH.return_label]]", return_type =
    NUMBER, return_required = true)
```

- b) Inside the **CMtoINCH** class, copy and paste the following code:

```
//Identify the entry point for the action. Returns a Value<String>
because the return type is String.
@Execute
public NumberValue action(
    //Idx 1 would be displayed first, with a text box for entering
    the value.
    @Idx(index = "1", type = AttributeType.NUMBER)
    //UI labels.
    @Pkg(label = "[[CMtoINCH.CMInput.label]]")
    //Ensure that a validation error is thrown when the value is
    null.
    @NotEmpty
    Double CMInput) {
    //Internal validation, to disallow empty inputs. No null check needed
    as we have NotEmpty on CMInput.
    if ("".equals(CMInput.toString().trim()))
        throw new BotCommandException("Input of CM is required");
    Number result;
    try {
        //Conversion logic
        result = CMInput * 0.393701;
    } catch (Exception e) {
        //Throw custom error message
        throw new BotCommandException("Unable to convert " +
        CMInput.toString() + "cm to inches");
    }
}
```

```
//Return NumberValue.
return new NumberValue(result);
}
```

To import the namespaces, click the highlighted red notations and press ALT+ENTER key and select **Import** which automatically imports namespaces based on the annotations and datatypes.

The screenshot shows an IDE window for the project 'MetricToImperial'. The file 'CMtoINCH.java' is open, showing the following code:

```

4 import com.automationanywhere.commandsdk.annotations.*;
5 import com.automationanywhere.commandsdk.annotations.rules.NotEmpty;
6 import com.automationanywhere.commandsdk.model.AttributeType;
7
8 import static com.automationanywhere.commandsdk.model.DataType.NUMBER;
9 //BotCommand makes a class eligible for being considered as an action.
10 @BotCommand
11 //CommandPks adds required information to be displayable on GUI.
12 @CommandPkg(
13     //Unique name inside a package and label to display.
14     name = "CMtoInch", label = "[[CMtoINCH.label]]",
15     node_label = "[[CMtoINCH.node_label]]", description = "[[CMtoINCH.description]]", icon = "[[CMtoINCH.icon]]",
16     //Return type information. return_type ensures only the right kind of variable is provided
17     return_label = "[[CMtoINCH.return_label]]", return_type = NUMBER, return_required = true)
18 public class CMtoINCH {
19     //Identify the entry point for the action. Returns a Value<String> because the return type is String
20     @Execute
21     @ public NumberValue action(
22         //Idx 1 would be displayed first, with a text box for entering the value.
23         @Idx(index = "1", type = AttributeType.NUMBER)
24         //UI Labels.
25         @Pkg(label = "[[CMtoINCH.CMInput.label]]")
26         //Ensure that a validation error is thrown when the value is null.
27         @NotEmpty
28         Double CMInput) {
29         //Internal validation, to disallow empty inputs. No null check needed as we have NotEmpty on CMInput
30         if (!"".equals(CMInput.toString().trim()))
31             throw new BotCommandException("Input of CM is required");
32         Number result;
33         try {
34             //Conversion logic
35             result = CMInput * 0.393701;
36         } catch (Exception e) {
37             //Throw custom error message
38             throw new BotCommandException("Unable to convert " + CMInput.toString() + "cm to inches");
39         }
40         //Return NumberValue.
41         return new NumberValue(result);
42     }
43 }

```

Red circles 'a' and 'b' highlight the `@BotCommand` and `@Execute` annotations respectively.

12. Configure **en_US.json** file, go to **src > main > resources > locales > en_US.json** and add the following fields after the label and description values:

```
"CMtoINCH.label" : "cm to inches",
"CMtoINCH.node_label": "cm to inches",
"CMtoINCH.description" : "Convert centimeters to inches",
"CMtoINCH.return_label" : "Assign the Output in Inches to a Number Variable",
```

```
"CMtoINCH.CMInput.label" : "Centimeters to Convert to Inches"
```

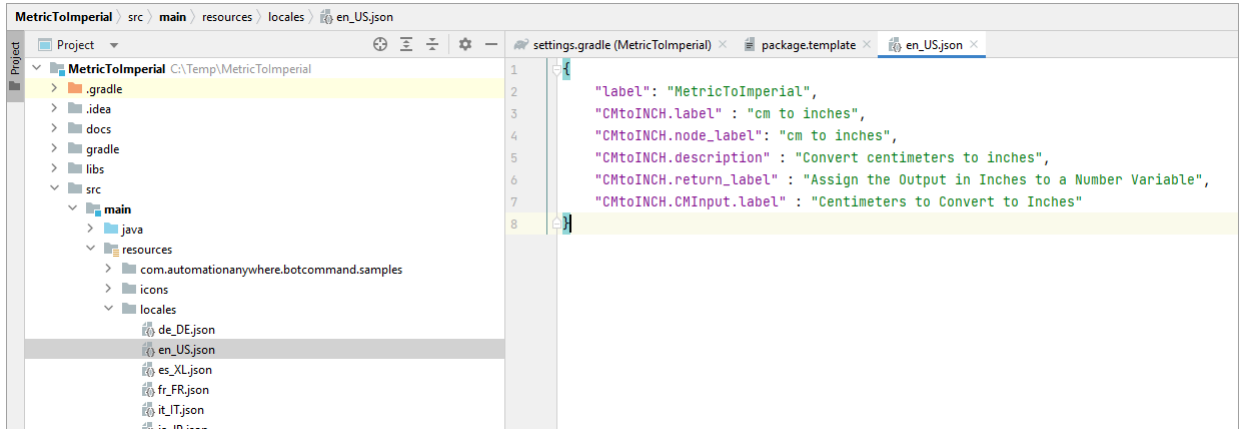

13. Update the CommandPkg annotation. Download icons from Github.

- Download ruler_icon.svg from [github](#) and right-click the image and save the image as ruler_icon.svg.
- Download iconwhite.svg from [github](#), right-click the image and save the image iconwhite.svg.
- Copy both files into the **src > main > resources > icons** folder.

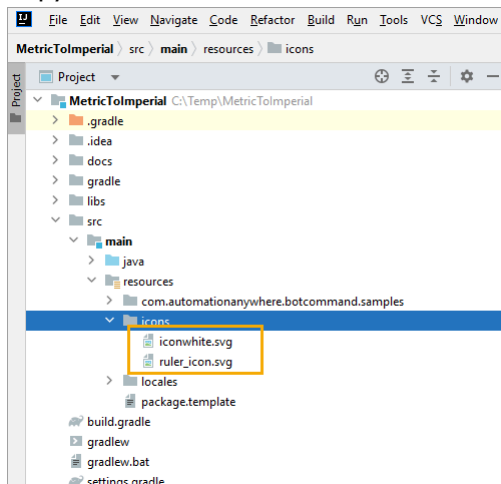

14. Open the build.gradle in the project root. After the dependencies section, but before the last closing tag, copy and paste the following code:

```
test {
    testLogging {
        exceptionFormat = 'full'
    }
    useTestNG() {}

    afterSuite { desc, result ->
        if (!desc.parent)
            println("${result.resultType} " +
                "(${result.testCount} tests, " +
                "${result.successfulTestCount} successes, " +
                "${result.failedTestCount} failures, " +
                "${result.skippedTestCount} skipped)")
    }
    maxHeapSize "3g"
```

```
}

```

- 15.** Update the version number and remove dependencies that is not required for your project from build.gradle.

<https://aa2019packagesdkfordocumentation.s3.us-west-2.amazonaws.com/videos/cm-to-inch-build-gradle.mp4>

- 16.** Create a new directory, right-click **src** and select **New > Directory**.

- In the **Name** field, enter `test\java`, or select the **test\java** suggestion from the **Gradle Source Sets**.
- Create a new package, right-click the `java` directory and select **New > Package**.
- Enter the name for the newly created package: `metrictoimperial.commands`.

- 17.** Create new Java class, right-click and select **New > Java Class**. Enter the name for the new class `CMtoINCHTest`.

Inside the `CMtoINCHTest` class, copy and paste the following code:

```
@Test
public void testCMtoINCH(){
    Double validInput = 10.00;
    Double expectedOutput = 0.393701 * validInput;
    CMtoINCH testCM = new CMtoINCH();
    Value<Double> result = testCM.action(validInput);
    Assert.assertEquals(result.get(), expectedOutput);
}
```

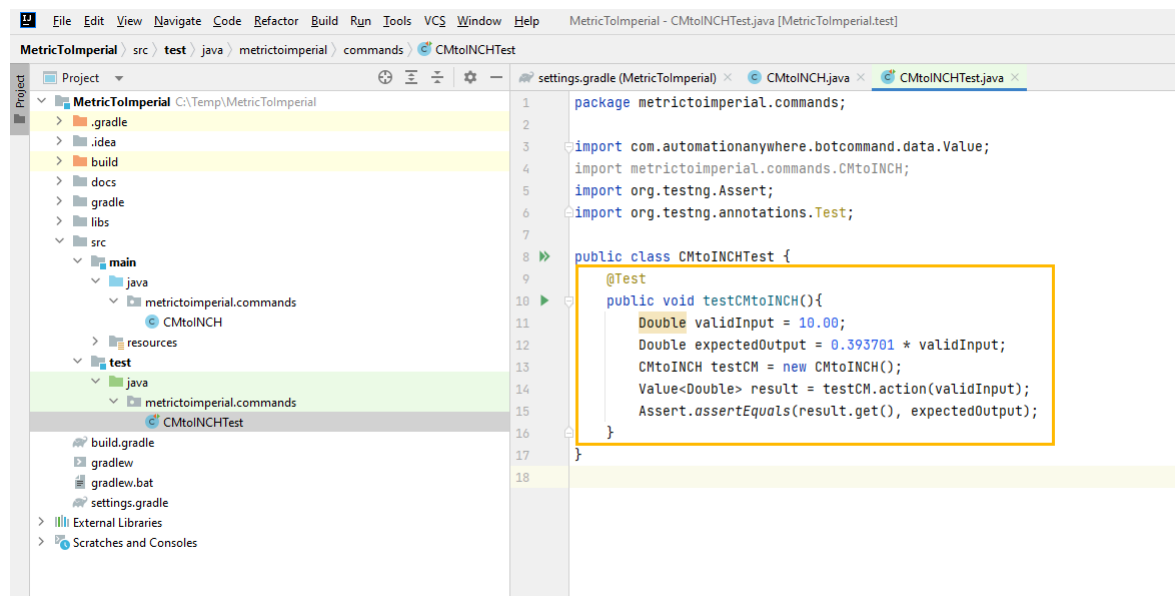

- 18.** Save the project **File > Save All**.

19. Build the package.

You can use the IntelliJ UI or the command line. If you are using the command line:

- a) Open a terminal window and navigate to the `MetricToImperial` directory.
- b) To build the project, enter the following command: `gradlew.bat clean build shadowJar`

A `BUILD SUCCESSFUL` message appears.

Sometimes a build might fail because existing files could not be automatically deleted and a system message appears indicating the execution failed for the task: `clean`. If this occurs, close the explorer windows and run the build again.

Add custom package to your Control Room

Add custom package to your Control Room

Use the compiled JAR file and upload it as a package to your Control Room in Automation 360.

- Complete the steps in [Build a custom package in IntelliJ](#).
- Ensure you have the following:
 - Access to the Control Room.
 - Credentials with **AAE_Basic** permission or a custom role with permissions to add packages to the Control Room.

1. From Windows Explorer, go to `C:\Users\\IdeaProjects\MetricToImperial\build\libs` and locate `MetricToImperial-1.0.0.jar`.
2. Log in to your Control Room as a user with permissions to add a new package.
3. Click **BOTS > Packages**.
4. In the **All packages** page, move your mouse over the plus sign and click **Add package**.
5. In the **Add package** page, click **Browse** and locate the `MetricToImperial-1.0.0.jar` file. By default, the file is located at: `C:\Users\\IdeaProjects\MetricToImperial\build\libs`.
6. Select the `MetricToImperial-1.0.0.jar` file and click **Open**.
7. Click **Upload Package**.

When you add a custom package to the Control Room, a notification is also sent to the Control Room users to notify about package updates. This notification is sent to the users who have the **View package** permission. For more information, see [Add or update package](#) event notification.

Create a bot to test the custom package

Related concepts

[Build and test a custom package](#)

Use IntelliJ to build a custom package and use Automation 360 actions to test the package.

Related tasks

[Add custom package to your Control Room](#)

Use the compiled JAR file and upload it as a package to your Control Room in Automation 360.

[Create a bot to test the custom package](#)

Use the actions in Automation 360 to create a bot and test the custom package.

Create a bot to test the custom package

Use the actions in Automation 360 to create a bot and test the custom package.

Ensure you have the following to build the bot:

- Access to the Control Room.
- Credentials with **AAE_Basic** permission or with a custom role to build a bot.
- Your workstation is a registered device in the Control Room.
- Your package **MetricToImperial-1.0.0.jar** is available in the Control Room.

1. Log in to the Control Room.
2. On the left pane, click **Automation**.
A list of available and forms is displayed.
3. Click the **Create a bot** icon.
4. In the **Name** field, enter `MetricToImperialTest`.
5. Click **Create & Edit**.
6. In the Actions pane, find **Metric to Imperial** and drag **Convert centimeters to inches** into the bot flow.
 - a) In the **CM to Convert** field, enter 1.
 - b) Click **Create variable** (next to the **Output** field) to create a new number variable.
 - c) In **Create Variable**, enter `nInchesOutput` and click **Create & Select**.
 - d) Click **Apply**.
7. In the Actions pane, find the **Number** package and drag the **To String** command below **Convert centimeters to inches**.
 - a) In the **Enter a number** field, enter **F2** and select **nInchesOutput**.
 - b) In the **Enter number of digits after decimal** field, enter 5.
 - c) In the **Assign the output to variable** field, select **prompt-assignment - String** from the drop-down list.
 - d) Click **Apply**.
8. From the Actions pane, drag **Message box**, click **F2** and insert the **prompt-assignment variable**.
9. In the **Enter the message to display** field, click **F2** and select the **prompt-assignment variable**.
10. Click **Apply** and **Save**.
11. Click **Run**.
The bot displays the `0.39370` message, which is a successful build.

Related concepts

[Build and test a custom package](#)

Use IntelliJ to build a custom package and use Automation 360 actions to test the package.

Related tasks

[Build a custom package in IntelliJ](#)

Use Java IntelliJ to create and compile a JAR file that you can upload as a package to your Control Room in Automation 360.

[Add custom package to your Control Room](#)

Use the compiled JAR file and upload it as a package to your Control Room in Automation 360.

Using Python to parse JSON response

Use the Automation 360 Python script to execute Python functions to build a bot. Use the Python functions to parse the JSON response from a REST Web Services GET request.

Ensure you have the following to build the bot:

- Basic understanding of Python programming language.
- Basic experience with creating Automation Anywhere bots.
- Download and install Python 3.

[download Python](#)

Do one of the following:

- While installing the Python, make sure to select **Add Python x.xx to PATH** during the Python installation.

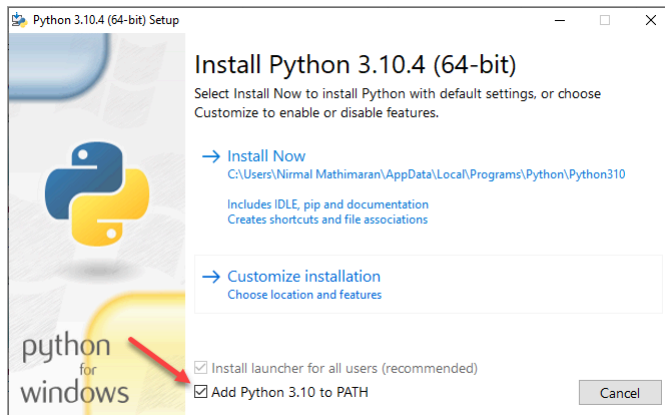

- Add a path to the Environment variable.

1. Log in to the Control Room.
2. On the left pane, click **Automation**.
A list of available and forms is displayed.
3. Click **Create a bot** icon.

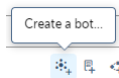

4. In the **Name** field, enter `PythonTutorial`.
5. Click **Create & Edit**.

6. In the Actions pane, click **Variables** to create the following new variables:
 - a) Name *dResponse*, **Type** > **Dictionary** and **Subtype** > **String**.
 - b) Name *dRetrieveValue*, **Type** > **Dictionary** and **Subtype** > **Any**.
 - c) Name *dResponseBody*, **Type** > **String**.
 - d) Name *sFullName*, **Type** > **String**.
 - e) Name *sLocation*, **Type** > **String**.
 - f) Name *sTotalUserCount*, **Type** > **String**.
 - g) Name *nTotalUserCount*, **Type** > **Number**.
 - h) Name *nCurrentUser*, **Type** > **Number**.
 - i) Name *sCurrentUser*, **Type** > **String**.
 - j) Name *prompt-assignment*, **Type** > **String**.
7. From the Actions pane, select **REST Web Services** > **Get method** and place it under the **Start** of the bot flow.
 - a) In the **URI** field, enter <https://randomuser.me/api/?results=5&inc=name,email,location&nat=us>. This is a sample API that returns random user details to the calling application.
 - b) In the **Authentication Mode** drop-down list, select **No Authentication**.

The screenshot displays the Automation Anywhere interface. On the left, the 'Flow List' pane shows a sequence of actions: Start, REST Web Services: Get method (highlighted with a red box and labeled 'a'), String: Assign, Python script: Open, Python script: Execute function, Dictionary: Put, and String: To number. On the right, the configuration for the 'REST Web Services: Get method' action is shown. The 'URI' field is set to 'https://randomuser.me/api/?results=5&inc=name', labeled 'a'. The 'Authentication Mode' is set to 'No Authentication', labeled 'b'. The 'Assign the output to a variable' section shows 'dResponse' selected in the dropdown, labeled 'c'. The 'Wait for action to complete' field is set to '60000' milliseconds.

- c) In the **Assign the output to a variable** drop-down list, select **dResponse -Dictionary of Strings**.

8. From the Actions pane, click **String > Assign** action and drag it into the canvas below the **REST Web Services** action.

a) In the **Select the source string variable value** field, enter `$dResponse{Body}$`.

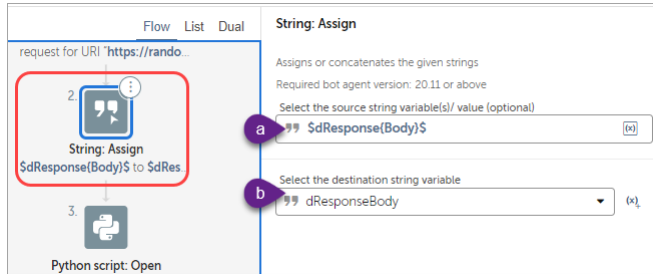

b) In the **Select the destination string variable** drop-down list, select **dResponseBody - String**.

9. From the Actions pane, click **Python script > Open** and drag it into the canvas below the **String > Assign** action.

a) In the **Python** field, select **Manual input**.

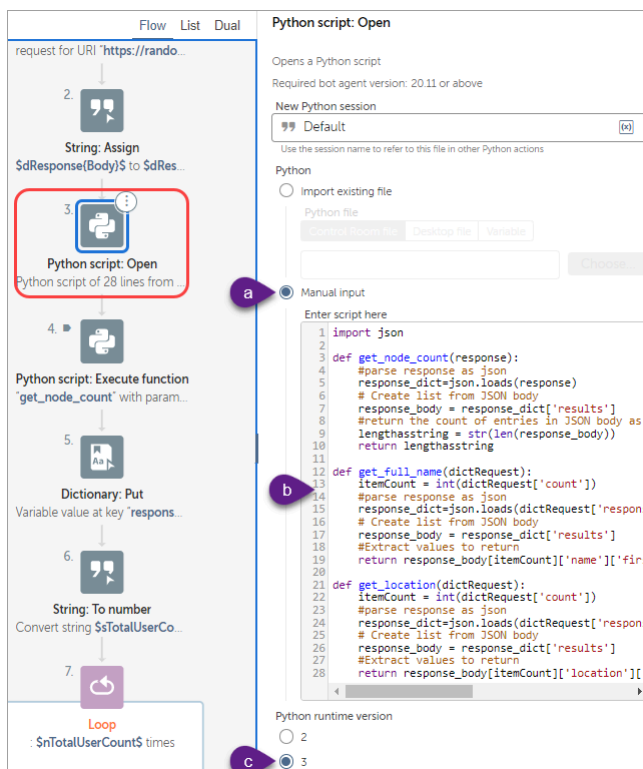

b) In the **Enter script here** field, copy and paste the following code.

```
import json

def get_node_count(response):
    #parse response as json
    response_dict=json.loads(response)
    # Create list from JSON body
    response_body = response_dict['results']
    #return the count of entries in JSON body as string
    lengthasString = str(len(response_body))
    return lengthasString
```

```

def get_full_name(dictRequest):
    itemCount = int(dictRequest['count'])
    #parse response as json
    response_dict=json.loads(dictRequest['response'])
    # Create list from JSON body
    response_body = response_dict['results']
    #Extract values to return
    return response_body[itemCount]['name']['first'] + " " +
    response_body[itemCount]['name']['last']

def get_location(dictRequest):
    itemCount = int(dictRequest['count'])
    #parse response as json
    response_dict=json.loads(dictRequest['response'])
    # Create list from JSON body
    response_body = response_dict['results']
    #Extract values to return
    return response_body[itemCount]['location']['city'] + ", " +
    response_body[itemCount]['location']['state']

```

c) In the **Python runtime version** field, retain the default value as **3**.

10. From the Actions pane, click **Python script > Execute function** and drag it into the canvas below the **Python script > Open** action.

a) In the **Python session** field, retain **Default**.

b) In the **Enter the name of function to be executed** field, enter `get_node_count`.

c) In the **Arguments to the function** drop-down list, select **dResponseBody - String**.

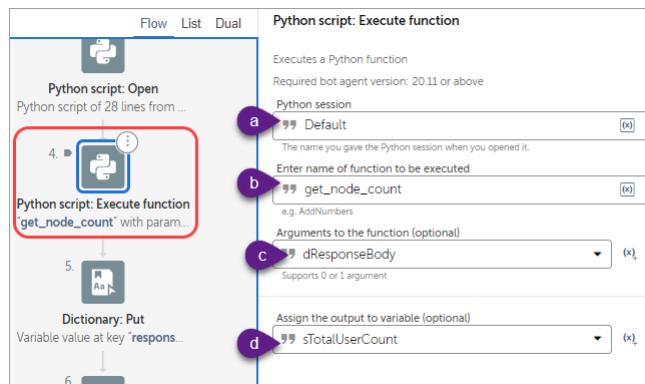

d) In the **Assign the output to a variable** drop-down list, select **sTotalUserCount - String**.

11. From the Actions pane, click **Dictionary** > **Put** and drag it into the canvas below the **Python script** > **Open** action.
 - a) In the **Dictionary variable** field, select **dRetrieveValue -Dictionary**.
 - b) In the **Associate to this key** field, enter `response`.
 - c) In the **New value** drop-down list, select **dResponseBody - String**.
 - d) In the **Assign previous value to a variable** drop-down list, select **prompt-assignment - String**.

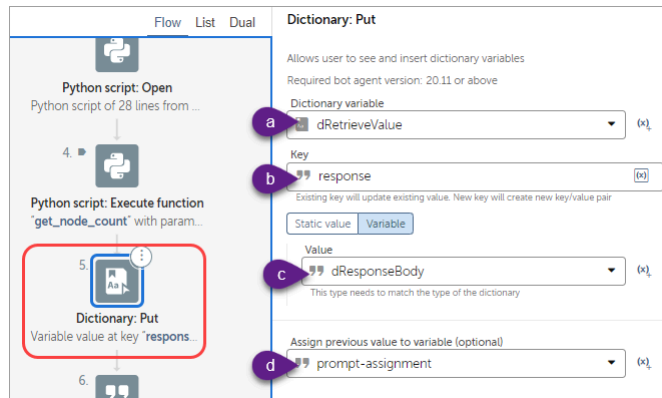

12. From the Actions pane, click **String** > **To number** and drag it into the canvas below the **Dictionary** > **Put** action.
 - a) In the **Enter the string** field, enter `$$sTotalUserCount$`.
 - b) In the **Assign the output to a variable** drop-down list, select **nTotalUserCount -**

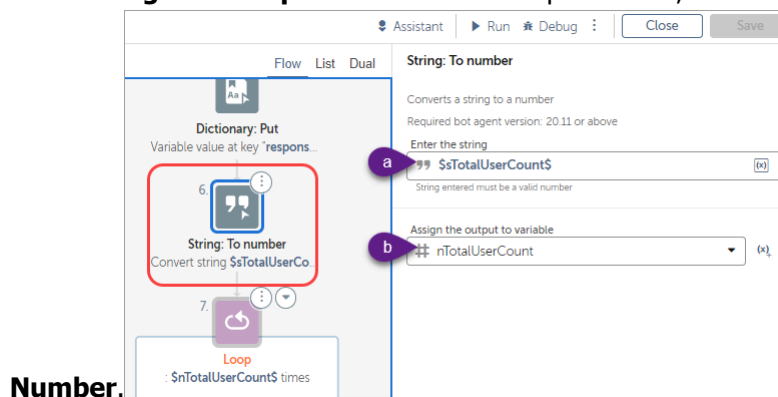

Number.

13. From the Actions pane, click **Loop** > **Loop**.

- a) In the **Loop Type** > **Iterator**, select **For n times** from the drop-down list.
- b) In the **times** field, enter \$nTotalUserCount\$.
- c) In the **Assign the current value to a variable** drop-down list, select **nCurrentUser** -

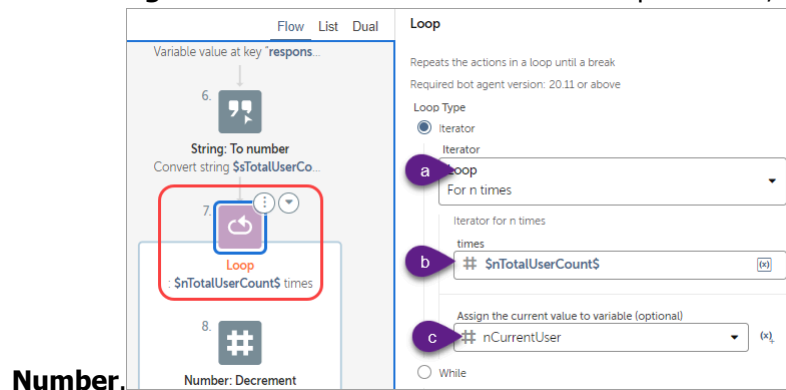

14. From the Actions pane, click **Number**, select **Decrement** and place it inside the **Loop** action.

- a) In the **Enter number** field, enter \$nCurrentUser\$.
- b) In the **Enter decrement value** field, enter 1.
- c) In the **Assign output to a variable** drop-down list, select **nCurrentUser** -

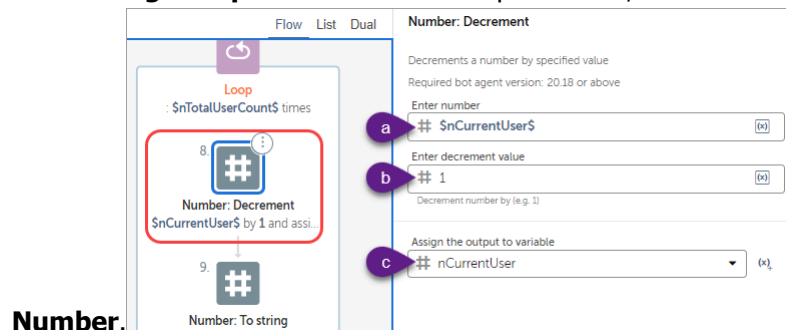

15. From the Actions pane, click **Number**, select **To string** and place it inside of the **Loop** action, below **Number** > **Decrement**.

- a) In the **Enter a number** field, enter \$nCurrentUser\$.
- b) In the **Enter number of digits after decimal** field, enter 0.
- c) In the **Assign output to a variable** drop-down list, select **sCurrentUser** -

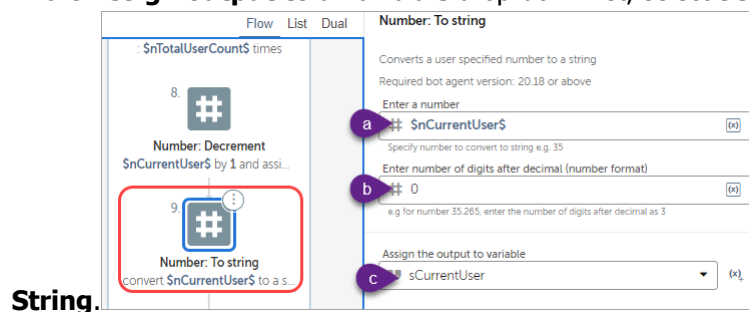

16. From the Action pane, click **Dictionary** > **Put** and place it inside of the **Loop** action.
- In the **Dictionary variable** field, select **dRetrieveValue -Dictionary**.
 - In the **Associate to this key** field, enter `count`.
 - In the **New value** drop-down list, select **sCurrentUser - String**.
 - In the **Assign previous value to a variable** drop-down list, select **prompt-assignment** -

String.

17. From the Actions pane, click **Python script** > **Execute function** and place it inside of the **Loop** action.
- In the **Python session** field, retain **Default**.
 - In the **Enter the name of function to be executed** field, enter `get_full_name`.
 - In the **Arguments to the function** drop-down list, select **dRetrieveValue - Dictionary**.
 - In the **Assign the output to a variable** drop-down list, select **sFullName** -

String.

18. From the Actions pane, click **Python script** > **Execute function** and place it inside of the **Loop** action.
 - a) In the **Python session** field, retain **Default**.
 - b) In the **Enter the name of function to be executed** field, enter `get_location`.
 - c) In the **Arguments to the function** drop-down list, select **dRetrieveValue - Dictionary**.
 - d) In the **Assign the output to a variable** drop-down list, select **sLocation** -

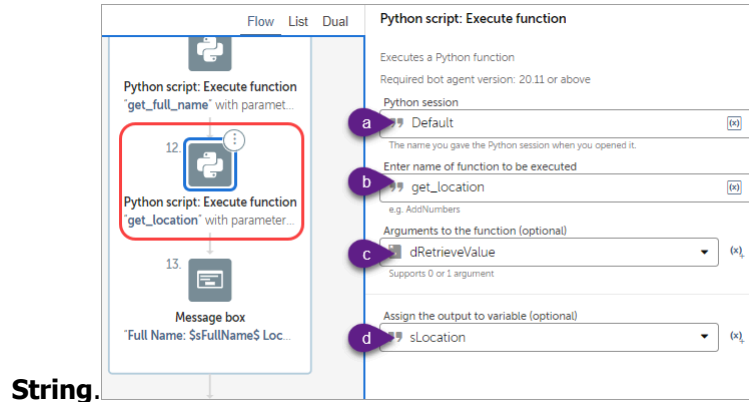

String.

19. From the Actions pane, click **Message box** and place it inside of the **Loop** action.
 - a) In the **Enter the message to display** field, enter the following:

Full Name: \$\$FullName\$ Location: \$\$Location\$

- b) Select **Close message box after** > **Seconds**, enter

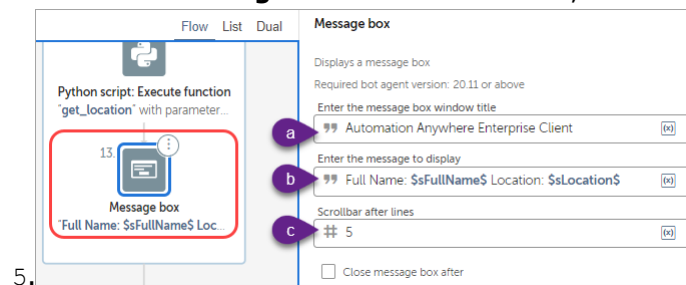

20. From the Actions pane, click **Python script** > **Close** and place it outside of the **Loop** action.
 - a) In the **Python session** field, retain **Default**.

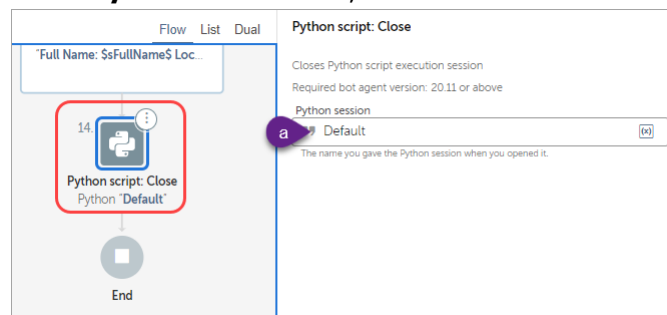

21. Click **Save** to save your bot, and then click **Run**.
The bot runs, displaying five full user names with locations for approximately 5 seconds each before completing its successful execution.

Use JavaScript to build a bot to take user input

Use the JavaScript actions Automation 360 to execute JavaScript functions to build a bot. Use the actions to create a bot that takes user input and provides the appropriate output.

Ensure you have the following to build the bot:

- Basic understanding of JavaScript programming language.
- Basic experience with creating Automation Anywhere bots.

1. Log in to the Control Room.
2. On the left pane, click **Automation**.
A list of available and forms is displayed.
3. Click **Create a bot** icon.
4. In the **Name** field, enter `Hello User`.
5. Click **Create & Edit**.
6. In the Actions pane, click **Variables** to create the following new variables:
 - a) Name `lInputList`, **Type** > **List** and **Subtype** > **String**.
 - b) Name `sInputName`, **Type** > **String**.
 - c) Name `sOutput`, **Type** > **String**.
7. From the Actions pane, click **Prompt** > **For value**:
 - a) In the **Prompt window capture** field, enter `Enter your name here`.
 - b) In the **Prompt message** field, enter `Please enter your name here`.
 - c) In the **Assign the output to a variable** drop-down list, select **sInputName - String**.
8. From the Actions pane, click **List** > **Add item**:
 - a) In the **List variable** drop-down list, select **lInputList - List**.
 - b) In the **Item to be added** drop-down list, select **sInputName - String**.
 - c) In the **Add item** field, select **To end of list**.
9. Create a new JavaScript file.
 - a) Open a notepad, and copy and paste the following code:

```
function response(str){
return "Hello "+ str
}
```
 - b) Save the file in your desktop as `Salutation.js`, and select **Save as type:** as **All Files**.
10. From the Actions pane, click **JavaScript** > **Open**:
 - a) In the **JavaScript session** field, leave as **Default**.
 - b) In **JavaScript** > **Import existing file**, for the **JavaScript file** field, select **Desktop file**.
 - c) Click **Browse** and select the `Salutation.js` file from your desktop or where you saved the file.
 - d) In the **Assign the output to a variable** drop-down list, select **sOutput - String**.

11. From the Actions pane, click **JavaScript > Run JavaScript**:
 - a) In the **Enter name of the function to be executed** field, enter `response`.
 - b) In the **Parameters** drop-down list, select **IInputList - List**.
12. From the Actions pane, click **Message box**:
 - a) In the **Enter the message to display** field, enter `$$sOutput$`.
13. Click **Save** to save your bot, and then click **Run**.
14. When the bot prompts to enter a name, enter the name and click **OK**.
A message from the bot appears: `Hello <User>`.

Bot developer recommendations

Automation Anywhere provides a flexible platform for bot and package development. The information in this topic provide guidelines and recommendations on how to structure and develop robust and reusable bots and packages.

Bot Store submissions checklist

Use the checklist to ensure that your Automation 360 Bot Store submission is correctly created, processed, and accepted. If you do not follow requirements listed in the checklist, your submission will be rejected and will not be published on the Bot Store page.

Use this checklist from the developer portal: [Automation 360 bot submission checklist](#).

Building reusable bots

Review the guidelines to gain a better understanding of how to develop bots or subtasks for reusability, from designing and creating through reusing.

Define prerequisites, input, output, and variables

When you build bots for reusability, define the following:

- Document all necessary prerequisites on how to use your bot either on its own or as a subtask.
- When creating your bots, define values as input, output, or local. Input and output variables are used when your bot is designed to be used as a subtask, allowing it to receive and pass back values to or from another calling bot.
- Provide meaningful variable descriptions when defining input and output variables so that other developers know how to interact with your subtask.
- Adhere to an established standard for variable naming guidelines. Review the Automation Anywhere user-defined variables for variable naming guidelines. [Your variables \(user-defined\)](#)

Follow single-responsibility principle

Bots developed for reusability should follow the single - responsibility principle which states

that each subtask or component should have responsibility over a single part of the functionality of the overall bot and that responsibility should be entirely encapsulated by that subtask or component.

Other examples of single-responsibility:

- A subtask that processes a single transaction, but can be called multiple times for each transaction on a list.
- A subtask that collects screen display data on a single page of a website, but can be called multiple times as a bot goes through pagination.

Bot design considerations

Consider the following patterns based on which templates must be developed for use:

1. Master, Main, and Sub bots

- Master bot: This bot is called directly to begin the process, through mechanisms including scheduling through the Control Room or API call. Include the following major process steps in the **TRY** section:
 - a. Initial setup for the process.
 - b. Validation that the setup was successful. For example, check whether all required files and folders exist or initial variable values are populated as required.
 - c. Run the desktop **PRE-PROCESS CLEANUP**.
 - d. Call the main bot to run the business logic of the process.

In the **FINALLY** section, run the desktop **POST-PROCESS CLEANUP**.

- Main bot: This bot calls the sub bots as required to run the business logic of the process. Include the following major process steps in the **TRY** section:
 - a. Validation of any input. For example, input variable values from the master bot.
 - b. Execution of sub bots.
 - c. Validation of any output.
 - d. Ensure population of any output variable values based on the execution

of main bot, to return to the master bot.

In the **CATCH** section, log the error, and ensure population of any output variable values, for example, **oStrResult** to pass back to the master bot.

- Sub bots
 - A sub bot is called by the master bot or main bot to run the actual business logic required for the automation. They are also referred to as helper tasks or utility tasks because their only purpose is to assist the calling task.
 - Use output variables to return a result indicator to the calling bot either main, or another sub bot. For example, **outStrResult**. The value contains an error message if the processing was not successful due to an error or exception that had occurred.

2. Main and Sub bots: This pattern includes the master and the main bot in a single main bot. The design pattern of the Sub bot is similar to the design pattern explained above.

Opening and closing applications

Any applications, files, or windows that a bot or subtask opens must be closed by the same bot or subtask.

- For example, when a bot opens Microsoft Excel to perform a spreadsheet operation, verify that the spreadsheet and Excel are closed when the bot finishes processing.
- Close applications when the bot execution is successful or unsuccessful.
- Use the **Finally** block of the **Try/Catch/Finally** operation to ensure applications are closed regardless of success of the task processing.
- In the case that applications do not respond during testing, consider using the command prompt to forcefully close (kill) the applications. For example, to forcefully close power point, the command-line operation would be:

```
Taskkill /IM powerpnt.exe /F
```

Error handling

After completing the task, verify that the bot successfully handles any failure or exceptions.

- Each task or subtask must handle its own errors.

- An unhandled exception in a subtask can cause issues in a parent task.
- Use **Try/Catch/Finally** blocks at the root level of every bot.
- Use **Try/Catch** blocks inside of a loop if you want to try an operation multiple times before reporting a failure.

Event or exception handling

Other than action errors that are captured by **Try/Catch**, you must perform code checks for other processes such as events or exceptions. If a certain process condition occurs, notify or log these conditions for additional analysis.

- Develop a configurable event handler TaskBot that minimizes the requirement for code changes if the actions change. For example, maintain an XML file that contains a definition of all the possible events or exceptions and any notification requirements when those events or exceptions occur.
- In the code, when such events or exceptions occur, write the information to an event log. You can also add memory usages and capture a screenshot.
- Run the event handler TaskBot to process the event or exception. For example, issue a notification using parameters such as email recipient, CC recipient, or subject from the XML file.
- If the notification requirements vary for each environment, or change over time, the configuration file can be updated without having to change the code.

Running bots on other computers

When designing a bot, enable it so it runs on computers other than the computer on which a bot was created.

- Use variables for local file paths, network shares, or window titles so that your bot can successfully run from other machines.
- Consider using global values for environment markers or network shares that multiple bots need access to.
- Use wildcard characters for window titles where appropriate to enable bots to run regardless of

specific environment or version of the target application. For example, instead of using

```
Salesforce - Professional Edition
- Internet Explorer
```

use the following:

```
Salesforce - * - Internet Explorer
```

Using prompts, message boxes, and infinite loops

Prompts and message box actions stop the bots from running when waiting for a user input. Unless a user input is required, design the bots without using prompt statements.

- When using loops, ensure all loops have a definite end by clearly defining their number of iterations or specifying where break loop actions need to exist.
- If your bot is intended to run as an unattended bot, remove or disable any prompts or message box actions.
- If you are building bots for an attended automation scenario, message boxes and prompts are often reasonable or required for bots to run as expected. Use message boxes to display different variables, such as, responses, outputs, or values.

Storing sensitive data in the Credential Vault

The Control Room includes the Credential Vault that can be used to store sensitive information, such as user names, passwords, API keys, and tokens.

- When building a bot, create a locker in the Control Room using the Credential Vault to store credentials and retrieve them as required by referencing the credential and the attribute. This allows users to create bots that consume APIs or perform logins without the need for bot builders to directly hard-code the required credentials within a bot.
- Do not hard-code sensitive credentials into a bot, or a subtask, because hard-coded storage in a bot introduces a security risk.
- When Credential Vault values are required to be used in a bot, verify that all locker names and credentials are clearly defined in the bot documentation. If required, include details on how to obtain credentials, for example, an API key or a token.

Testing independent tasks

When creating bots for reusability, design them in a way that they can be tested independently of other subtasks.

- Practice the test-driven development (TDD) approach: When adding a new bot, or a new feature in an application, write a test case for it.
- In a test case, define the specific function that validates that feature or functionality.
- For single-responsibility principle and reusability, create many smaller tasks that can be tested independently.

Using comments and steps

Comments enable developers to provide descriptions within their bots so that bot other bot developers can better understand what each section, block of code, or subtask is designed for. Include clear comments to allow developers to understand the purpose of the function of a given code block.

- When bots are submitted to the Bot Store, commenting demonstrates how to customize the bot.
- Using comments makes code maintenance easier because section descriptions help identify where changes might be required to enable developers to work towards quicker issue resolution
- Comments on bots that are a *work in progress* can be helpful when creating placeholders for future work. Consider using a *TODO* command as a reminder to add logic to the bot, but update the comments when the work is completed.
- Automation 360 includes the Step action, which provides the capability to organize the code into logical groupings to improve readability and the flow.
- Create an outline of the major objectives of your bot by using empty, labeled step actions. When that is completed, go back to each step and complete the logic for the step.

Creating logging files

Identifying problems without logs can be difficult when bots are running unattended on any number of Bot Runners. Software developers, support teams, and bot owners rely on logs to understand where their automations have issues and how to diagnose problems. Bots must log errors to get error details.

- Use error handling and screen captures to better understand when a bot or subtask encounters an error.
- Use the A2019 Bot Store template that contains basic error handling, logging, and snapshot capabilities with the customizable root logging location for maintaining older log files.

[Bot Store bot template](#)

- If required, create additional logging files and include a full audit history of everything a bot or subtask has done. The additional log files can include audit, debug, and performance information about the bot, as well as the following:
 - Main bot start and end time.
 - Subtask start and end time.
 - The completion time of specific milestones defined within the bot.
 - Number of transactions received in an input file.
 - Number of successfully processed or failed transactions.

See also: [Best practices: Building reusable and secure Automation 360 bots and packages](#)

Related tasks

[Using Loop action](#)

Use the Loop action to repeatedly run a sequence of actions for a specific number of times or until a condition is met.

Related reference

[Your variables \(user-defined\)](#)

Users and some actions create user-defined variables to temporarily hold values. Use this kind of variable to input values into an action (window title, login credential, or file path) or to accept the output of an action (values read from a file or a Boolean return).

[Application package](#)

Use the **Open Program/File** action in the **Application** package to launch an application or a file. This action supports .exe, .bat, script files, or shortcut paths.

[Error handler package](#)

If a bot encounters an error due to an abnormal condition or exceptions during execution, the normal execution of the bot is hindered, and the bot fails to complete the task. The Error handler package contains actions that enable you to easily handle exceptions a bot encounters and transfers control to the other actions within that bot.

[Step package](#)

The **Step** package groups various actions together and runs them in a specific order. You can provide a relevant name for a step to identify the operation performed by the actions included in that step.

[Prompt package](#)

Use the **Prompt** package to accept an input value, a yes/no response, or to open a file or folder.

[Message box package](#)

Use the **Message box** action from the **Message box** package to insert a message box that shows a message when the task runs. For example, you can insert a **Message Box** action to follow a web form so that the action displays the message: `Web Form Filled and Complete`.

Building reusable packages

Review the guidelines to understand how to build packages for reusability.

Know your incoming data

When setting fields that your action package requires from the user, provide specifics in setting

the attribute type to limit the kinds of data that your package receives.

- Limit the input to reduce the burden of checks that have to be done when the package is received.
- Javadoc includes 34 defined attribute types, so review those when you build your package to select the appropriate field types.
- Set your package so that it takes a stored value. For example, on behalf of the bot, your package is making API calls, verify that the *AttributeType* of the action input field for the API key or a token is set to *credential*. This way users are encouraged to use a value stored in the Credential Vault for sensitive input data that the package requires.

Use labels appropriately

In the *CommandPkg* annotation, use different labels, *node_labels*, and descriptions appropriately.

- Use these labels as short descriptions of your action and use only a few words to describe an action.
- Replicate the same naming style as it is presented in the default Action packages.
- Each action is a child element of a package, and the action label is displayed along with the package icon in the Actions pane. Use short names to describe each action.
- Document an expected input format for certain fields. Use the parameter description for the *@Pkg* annotation. This allows package developers to review the format, requirement, or data that must be used for a specific input field. For example:

```
@Pkg(label = "Start Date",
      description="Date Format as MM/
      DD/YYYY")
```

Unit test your components

During the package development, create unit tests to validate that each component and the action of the package is working as expected.

- Validate the behavior of the individual test unit, a single class, or a single action, to ensure that it is functioning as expected.
- Review and document any feature or functionality defects at early stages of the development process.

Handling errors

Include the error handling in the bot logic to ensure that all errors are handled gracefully. If an error is not handled, it could prevent a bot runner from executing other tasks.

- Create meaningful error messages that can help bot consumers with error resolutions.
- As a package developer, keep in mind these recommendations:
 - Use **Try/Catch** block to accommodate for an error.
 - Use a multi-catch block to find specific errors, and use the **BotCommandException** to return customized error messages. For example:

```
//create array of 3 items
int[] myIntArray = new int[]{1,
    0, 7};
try {
    //print 4th item in array

    System.out.println(myIntArray[3]);
    //Perform operation on
    first and second items in
    array
    int result =
    myIntArray[0] / myIntArray[1];
} catch
(ArrayIndexOutOfBoundsException
e) {
    //Throw custom message for
    IndexOutOfBounds
    throw new
    BotCommandException("The
    array does have the number of
    expected items.");
} catch (ArithmeticException e)
{
    //Throw custom message on
    Arithmetic Exception
    throw new
    BotCommandException("Math
    Operation Error with " +
    Integer.toString(myIntArray[0])
    + " and " +
    Integer.toString(myIntArray[1]));
}
```

Follow single-responsibility principle

A package is a collection of actions. Each action within a package must have a single responsibility and that responsibility must be encapsulated by that action.

- Following the single-responsibility principle helps your package consumers to implement it easily, simplifies testing, and avoids unnecessary modifications.
- The actions that you offer allow package consumers to customize the way they use your package within their bots, and can help their bots be as efficient as possible.

Provide examples

When submitting packages to the Bot Store include a demo bot that demonstrates the use of the package.

- Use the Automation 360 actions and allow package consumers to use these actions to expend their bot capabilities.
- Always provide sample bots with descriptions to help your package consumers with the knowledge they require to understand its proper use.

See also: [Best practices: Building reusable and secure Automation 360 bots and packages](#)

Related reference[Building reusable bots](#)

Review the guidelines to gain a better understanding of how to develop bots or subtasks for reusability, from designing and creating through reusing.

Troubleshooting and debugging

Troubleshooting and debugging information.

Troubleshoot bot run issue

Issue: I'm unable to deploy a bot because I get the following – Unexpected error setting up a new user session.

Cause:

Most often, this error is caused by invalid device credentials.

Solution:

Confirm the device is registered and connected.

1. Select **Devices > My devices** from the Automation Anywhere web interface.
2. Confirm that the Status column shows **Connected** for the relevant device.

Confirm that the device username and password are correct.

1. Select the profile icon on the Automation Anywhere web interface and select **Edit profile**.
2. Verify the device username.

Depending on how the device is configured within the network, you might need to prepend it with the domain name. For example, domainname\firstname.lastname.

3. Verify the device password.

Debugger features

The Automation Anywhere Debugger tool helps you to identify and troubleshoot any issues during bot running process.

Debugger

You can use the Automation Anywhere Debugger tool to identify and troubleshoot any issues during the bot running process. The Debugger tool is available from:

- **Bot Assistant** utility
- Bot editor

Open the bot from the Automation page and invoke the **Debugger**. You can add, update or delete actions and variables within a bot when **Debugger** is invoked from the Bot editor.

The Bot editor canvas provides the following breakpoints controls that you can use for the **Debugger** tool:

- To insert a breakpoint, click the vertical ellipses and select **Enable breakpoint**.
- To disable a breakpoint, click the vertical ellipses and select **Disable breakpoint**. The breakpoint becomes inactive.
- To clear all breakpoints, click the **Clear all breakpoints** icon.

The **Debugger** tool provides the following controls:

- **Start debugger**: Use to start the debugging process.
- **Step Over**: Use to move one action at a time.
- **Stop**: Use to stop the debugging process.
- **Step Out**: Use to jump to the next breakpoint directly. The **Debugger** tool skips to the next action and pauses. When the debugging is in process, the **Start debugger** icon changes to **Step Out**.

Watched variables

You can use **Watched variables** to watch the values of the respective variable during bot execution. By default, the **Watched variables** list is empty. With a single click, you can add used variables in a bot. These variables are displayed in a pop-up window where you can select or deselect, one or more variables, from the list.

You can add variables used in a bot to the **Watched variables** list using either of these methods:

- Select the **Click here to add used variables** link under **No watched variables** to add all of the used variables in a bot with one click.
- Click the x () icon next to **Watched variables** to add or remove variables manually.

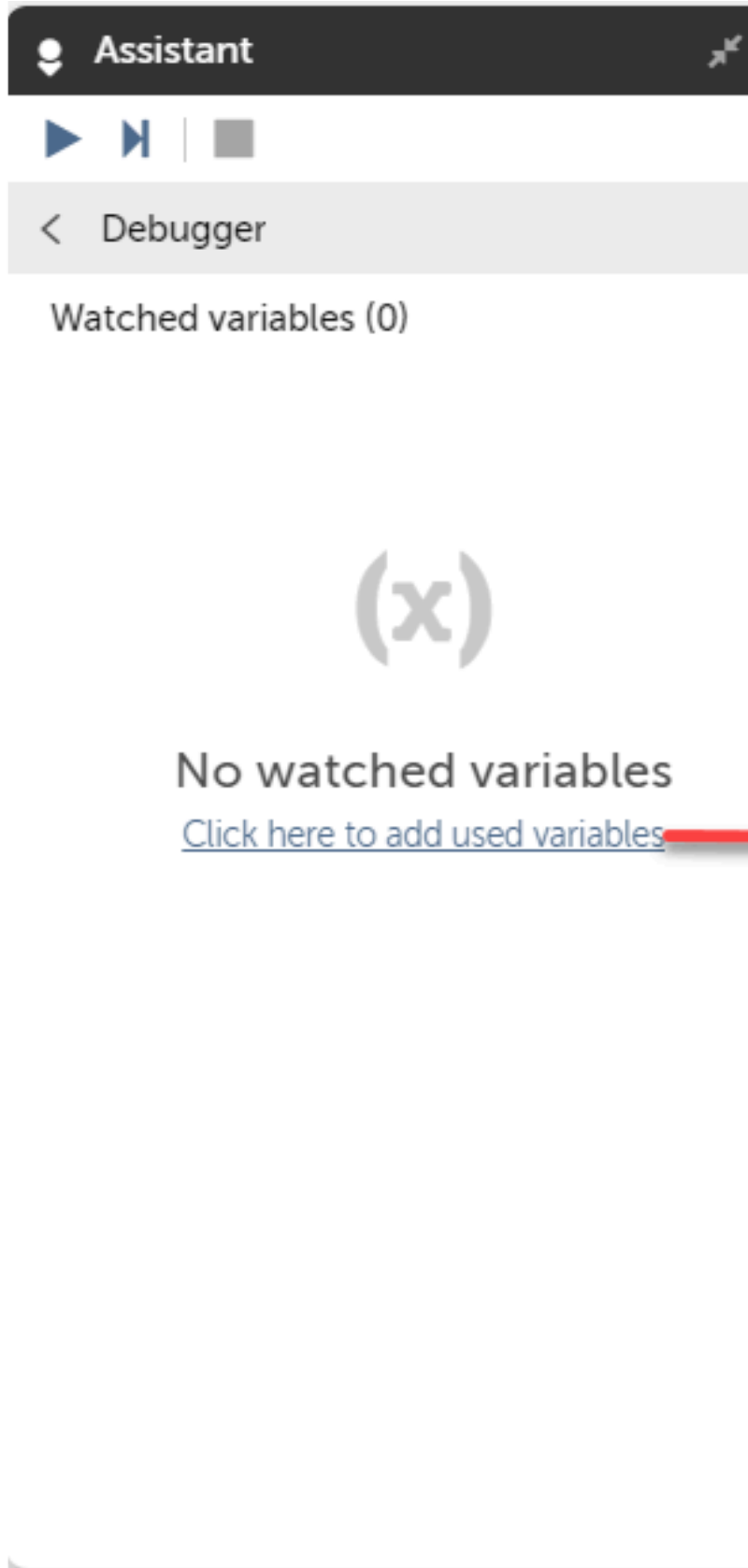

The following pop-up is displayed when you click the x icon to add or remove variables manually:

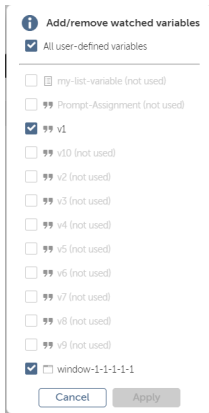

When a bot updates the variables, the values of those variables are updated dynamically in the **Watched variables** list. This provides a current status of a bot run at each action, and helps fix any bot-related errors at an early stage from the Debugger tool.

The following pop-up window displays the list of Watched variables:

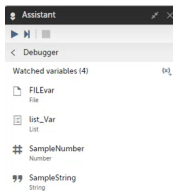

Note:

- You can run the **Debugger** tool using the **Flow** and **List** views. However, we recommend that you use the **List** view to see which action is running.
 - You cannot edit actions during the debugging process.
 - If you rename a variable that is in the **Watched variables** list, then you must re-add it for it to appear under **Watched Variables** list.
-

Bot Agent log files

Various types of information about the Bot Agent are captured in different log files. You can analyze these log files when the Bot Agent or a bot encounters an error and identify the root cause for that error.

Overview

The Bot Agent log files enable you to perform these actions:

- Determine whether a bot ran successfully
- Identify issues that resulted in a bot failure
- Determine if the device is properly connected with the Control Room

Log file locations

The Bot Agent log files are available at `C:\ProgramData\AutomationAnywhere\BotRunner\Logs` on your device. The following files are available at this location:

Bot_Launcher

Captures information about the execution of a bot such as the operations performed, events triggered, and errors encountered by the bot.

The filename now includes the name of the user running the bot on the Bot Runner. For a multi-user session machine, there will be a bot launcher log per user.

Node_Manager

Captures information about when a bot is run from the Control Room and communication details between a Bot Runner and the Control Room.

Log file configuration

To configure the different types of log files that can be collected from the devices connected to the Control Room, see [Configure log collection](#) and [Customize device settings](#).

Digitize

Automation Anywhere offers several web-based intelligent document processing solutions that extract semi-structured data from documents and convert it into structured data, which can be used by Robotic Process Automation (RPA) bots for automation of business processes.

Overview

Typically, RPA bots can automate only those tasks that involve processing structured data. As a result, about 80% of a business's data remains inaccessible to RPA bots as "dark data." This dark data is made accessible to RPA bots by cognitive automation, which combines the technologies of intelligent document processing and RPA. With cognitive automation, semi-structured data is extracted from documents such as invoices, and converted into structured data, so RPA bots can subsequently use this structured data for automating business processes.

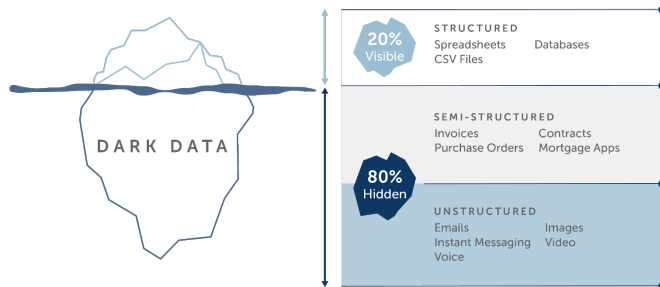

Learn more about the Automation Anywhere intelligent document processing solutions:

Document Automation

Document Automation is the new Cloud-native intelligent document processing solution that business users can set up to automatically read and process documents quickly using pretrained models and validation feedback.

[Document Automation](#)

Automation 360 IQ Bot

In Automation 360 IQ Bot, users configure templates and train bots to extract data from a variety of documents. Automation 360 IQ Bot is available for on-premises and cloud installations, and offers users a wide range of tools to customize and optimize document processing, including the following:

- Packages to create models for classifying documents by category and to enhance the quality of documents or images for better extraction
- Standard form models for extracting data from documents that have minimal or no variation in their layout
- Support for Optical Character Recognition (OCR) engines to improve the accuracy of the extracted data

IQ Bot 11.3.x*Automation 360 IQ Bot*

This early version of IQ Bot supports Enterprise 11 customers. It is available for on-premise installations only.

*IQ Bot 11.3.x***Community Edition**

The Community Edition version offers users limited features from the document processing solutions Document Automation and Automation 360 IQ Bot. This version is available to users for free.

Community Edition

Community Edition

The Community Edition version offers users limited features from the document processing solutions Document Automation and Automation 360 IQ Bot. This version is available to users for free.

Users are not required to purchase a license and there are no time limitations. However, there are some functionality constraints as follows:

- You can create a maximum of five learning instances per user.
- You cannot delete a learning instance.
- In the learning instance list, you can view and access only the learning instances and data that you created.
- You cannot integrate a Community Edition version of Document Automation with an Automation 360 IQ Bot environment.
- Google Document AI and Standard forms are not supported.

Get started with Community Edition

To begin using Community Edition:

1. Register and log in to Community Edition:

Complete steps one and two of *Get started with Community Edition*.

2. Install the Bot Agent and set user device credentials.

- a.** Navigate to **Manage > Devices** and click **Connect local device**. Follow the steps in the wizard to connect the Control Room to your device.
- b.** Click **Refresh** to verify that your device is connected.
- c.** Click your username. Navigate to **My settings > Devices > Credentials**. Click **Edit** to provide your device username and password.

3. Navigate to **Manage > Learning instances** and select a version of IQ Bot to begin creating learning instances:
 - **Option 1:** Click the **Create learning Instance** option.
Create learning instances to extract data from invoices in Document Automation: [Create a learning instance in Community Edition](#)
 - **Option 2:** Click the **Train other documents** option.
Create learning instances to extract data from other document types using Automation 360 IQ Bot: [IQ Bot Community Edition quick start guide](#)

Create a learning instance in Community Edition

Create a learning instance to begin processing documents. In Community Edition, you can extract data from invoices in English using the ABBYY OCR provider.

1. From the Control Room home page, navigate to **Manage > Learning Instances > Create Learning Instance**.
2. Enter a name and description for the learning instance.
Document Automation does not allow duplicate learning instance names, so the name you provide must be unique.
3. Click **Next**.

We recommend that you open a sample document side by side with the Control Room window as you configure the form and table fields.

Note:

- A form field is a type of field that occurs only once in a document.
- A table field is a type of field that reoccurs throughout a document, typically in the form of a table.

-
4. Configure the form and table fields for extraction.

Document Automation offers a standard set of form and table fields, many of which are not initially visible. You can search for a field by field name, field label, or data type.

To see the full list of fields, click **Show unused fields**. See the following video for a demonstration: <https://aa2019packagesdkfordocumentation.s3-us-west-2.amazonaws.com/videos/view-all-li-fields-iqbot.mp4>

Click a field to open the fields editor. You can edit most attributes of a field. You cannot edit the name and default aliases. Document Automation assigns default aliases, which are hardcoded keywords, to standard fields to help with extraction. You cannot modify or delete default aliases, but you can add aliases in the **Custom aliases** field. See the following video for a demonstration of creating a custom alias: <https://aa2019packagesdkfordocumentation.s3-us-west-2.amazonaws.com/videos/custom-alias-iqbot.mp4>

Mouse over the menu icon to the right of a field to access the up/down arrows. Use the arrows to rearrange the order of the fields for a more efficient manual validation. The order of the fields does not impact extraction.

To learn more about the other field attributes, review the table in the next step.

5. To add a field, click **Add a field** and complete the following fields:

Option	Description
Field name	Enter a field name that begins with an alphabetical character (A-Z or a-z). In standard fields, the field name is hardcoded and cannot be changed.

Option	Description
Field label	<p>Enter a user-friendly name to help validators.</p> <p>For example, you can rename <code>Organization tax number</code> to a localized name, such as <code>VAT number</code>.</p> <p>The field label does not affect extraction.</p>
Confidence	<p>Set a threshold to reduce potential false positives.</p> <p>At the time of processing, the Document Automation engine assigns a score to each field in a document to indicate the certainty that the data was correctly extracted. If the document contains fields with a score that is lower than the confidence threshold, the document is sent to the validation queue.</p> <p>If you enter a high confidence threshold, more documents will be sent to the validation queue. If you enter a low confidence threshold, fewer documents will be sent to the validation queue.</p> <p>Supports values from zero to 100.</p>
Data type	<p>Choose from Address*, Text, Number, and Date.</p> <p>If the data in the field does not match the data type, the document is sent to the validation queue.</p> <p>Document Automation supports variations of the date format.</p> <p>* If you are configuring a learning instance with a user-defined document type, the form fields include the address data type, which extracts the entire structure of an address.</p>
Required	<p>Select one of the following:</p> <ul style="list-style-type: none"> • Required: Field cannot be empty. • Optional: Field can be empty or not exist in the document.
Default aliases	<p>No action is necessary for this field. Document Automation assigns default aliases, which are hardcoded keywords, to standard fields to help with extraction.</p>
Custom aliases	<p>Additional keywords to help Document Automation locate the field. For example, add country or region-specific names for fields such as <code>VAT number</code> as an alias to an <code>Organization tax number</code> custom field.</p> <hr/> <p>Note: Custom aliases must be unique. They cannot duplicate the default alias of another field. Exception: Form fields can have duplicate custom aliases as the table fields and vice versa.</p> <hr/>
Validation rules	<p>Depending on data type, create rules using patterns, formulas, lists, and statements such as starts or ends with.</p> <p>Formula validation Pattern validation</p>

6. Click **Create**.

Upload documents to the learning instance, fix validation errors, and verify the extracted data: [Process documents in Community Edition](#)

Process documents in Community Edition

Upload sample invoices to train the learning instance, verify the extracted data, and fix validation errors.

- If you have not done so already, [Create a learning instance in Community Edition](#)
- Ensure that each file is 2 MB or less.
- Ensure that the sample invoices are in the following supported document types:
 - PDF
 - JPG
 - JPEG
 - PNG
 - TIF
 - TIFF

Upload sample invoices to a learning instance to test the learning instance's data extraction capabilities. If a document requires manual validation, the system sends it to the Validator, where you must manually enter the correct data.

1. Upload documents to the learning instance:

Note: Community Edition can process a maximum of five documents at a time. You must wait for a document to successfully complete processing (and validation if necessary) to upload another document.

- a) Click **Process documents**.
- b) In the **Process Documents** window, click **Browse** to select the files to upload.
- c) In the **Download data to** field, enter the file path where the extracted data is output to a CSV file.
- d) Click **Process documents**.
The Bot Runner window appears. The window disappears when the documents are done processing. Refresh the **Learning instances** table to see the updated metrics.

If there is a value next to the **Validate documents** link, you must manually validate the fields with errors. Otherwise, proceed to step 2b to review the extracted data.

2. Fix the validation errors

a) Click **Validate documents**.

The AARI Task Manager opens in a new tab, with the first failed document in queue. For an introduction to the Validator user interface, see [Using the AARI Task Manager Validator for Document Automation](#).

b) Review each field to verify the data type and extracted value.

Document Automation supports the following data types: text, number, time, and check box

Alternatively, from the drop-down list on the right panel, you can select **Show fields that need validation**.

Note: When documents are awaiting validation, if you edit the learning instance, click **Reprocess** to reattempt extraction.

Reprocessing documents does not affect the uploaded documents metric.

c) Update the fields with errors.

Click the field or draw a box around the values that you want to extract.

For Automation Anywhere pre-trained models, you can configure the learning instance to extract specific values in a field and ignore others. For more information, see [Using validation feedback to extract specific values in a table](#).

<https://aa2019packagesdkfordocumentation.s3-us-west-2.amazonaws.com/videos/validation-iqbot.mp4>

- To skip a document without correcting errors, click **Skip** to proceed to the next document in the validation queue.
- To remove a document that cannot be processed, click **Mark as Invalid**.

d) After you make the necessary corrections, click **Submit** so that the document can finish processing.

The next document in queue appears. When all the documents are corrected, the system displays a message stating that no more tasks are available.

e) Close the tab to return to the **Learning Instances** page.

3. Verify the output results:

a) Open the file in the `Success` folder that contains the extracted data and review the results to ensure that it matches your use case.

b) Optional: Review the **Learning Instance** dashboard.

The dashboard displays the total number of uploaded documents and the number of documents pending validation.

Congrats! You have now successfully processed your first documents in the Community Edition version of Document Automation.

Automation 360 IQ Bot

Automate document-centric business processes, end to end, by using IQ Bot, a web-based, Cloud-native intelligent document processing solution that can read and process complex documents and email. This solution combines RPA with AI techniques to extract and classify semi-structured and unstructured data.

Automation 360 IQ Bot is a hybrid solution for On-Premises and Cloud deployments.

Note: From Build 4695 (A2019.13), Automation 360 IQ Bot has feature parity with IQ Bot Version 11.3.4.2 and some features from Version 11.3.5. For feature parity information between Automation 360 IQ Bot and the corresponding IQ Bot 11.x versions, see [Automation 360 IQ Bot feature comparison matrix](#).

Overview

The technologies of IQ Bot and RPA together constitute cognitive automation. With cognitive automation, IQ Bot extracts semi-structured and unstructured data and converts it into structured data, and RPA bots subsequently use this structured data for automating business processes.

IQ Bot works by using **learning instances**. A learning instance is a structure that holds information such as document type, language, and fields to be extracted from tables and forms. A learning instance also includes bots that are trained to extract data from documents.

IQ Bot is also supported by RPA bots that are built for functions such as training the Classifier, sharpening document resolution, and downloading the extracted data.

After the bots in a learning instance are trained and the necessary RPA bots are built, a learning instance is set to production mode. After that, IQ Bot can start processing documents automatically, through the following steps:

1. Retrieves documents from a source, such as attachments in incoming email
2. Improves document quality
3. Classifies documents into groups
4. Extracts data
5. Either downloads the extracted data or first sends the document for manual validation and then downloads the data

Types of IQ Bot users

In many organizations, different types of users perform specific tasks within their product area to create, configure, and publish a learning instance and the supporting assets. To learn more about the user types, required licenses, roles, and permissions, and the assigned product areas, see [IQ Bot user personas](#).

The following diagram demonstrates the sequence of how a learning instance and supporting assets are built, as well as which user performs which task.

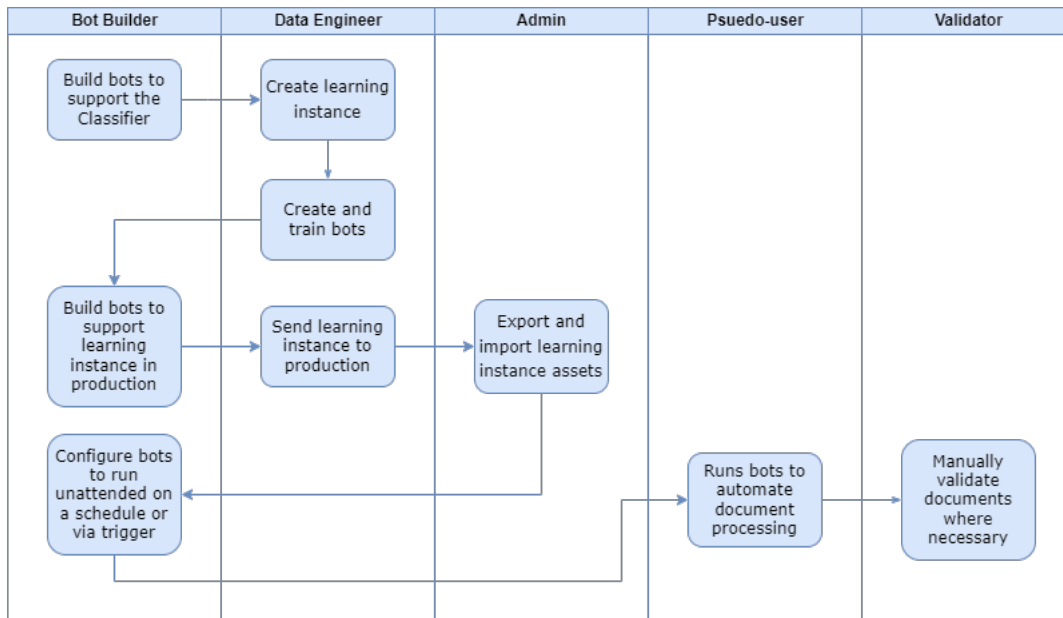

Get started with learning instances

Perform the following these steps to create a learning instance, train bots, and set the bots to production:

- [Using Automation 360 IQ Bot On-Premises](#)
- [Using Automation 360 IQ Bot Cloud](#)

Build RPA bots for IQ Bot

The following links guide you in configuring RPA bots to support IQ Bot functions.

- Use the IQ Bot Classifier package to improve classification and prevent invalid documents from being uploaded to a learning instance.
 - [Train the classifier](#) | [Classify documents](#)
- Use the IQ Bot Pre-processor package to prepare documents and extract data before processing.
 - [Using EnhanceImage action](#) | [Using ConvertImageToPDF action](#)
- After sending a learning instance to production, configure a bot with the **Process documents** action from the IQ Bot Extraction package: [IQ Bot Extraction package](#)
- [Download extracted data](#)

Resources

For more information, review the courses in the IQ Bot Developer learning trail: [IQ Bot Developer Training \(A-People login required\)](#).

You can also search for the following courses in [Automation Anywhere University: RPA Training and Certification \(A-People login required\)](#):

- [Intelligent Document Processing with IQ Bot](#)
- [Unleash Your Intelligent Bots: Develop Cognitive Bots Driven by AI & Machine Learning \(IQ Bot\)](#)

Related concepts

[Install and update Automation 360 IQ Bot](#)

This collection of topics guide you through the process of installing or setting up Automation 360 IQ Bot On-Premises and Cloud.

[Languages supported in Automation 360 IQ Bot](#)

Up to 31 languages are supported in IQ Bot. You can also access up to 190 languages in IQ Bot by using an OCR engine.

IQ Bot architecture diagram

This diagram shows the different components of IQ Bot architecture.

Use the IQ Bot, components, Designer and Validator for designing and validating bots, respectively. In a typical scenario, IQ Bot portal and IQ Bot platform communicate through a network firewall and a load balancer.

Various protocols are used to communicate between the different components. A database server, a file storage server, and servers for IQ Bot are used. An organization has the flexibility of using a separate server for the database or using the Control Room clusterdatabase. A firewall is between the external components, web browser and Bot Runner, and the data center load balancer. Chrome is the supported browser.

Using Automation 360 IQ Bot On-Premises

Create a learning instance, train the bots to extract data from documents, and push the learning instance to the production environment.

Complete the steps to [install IQ Bot](#).

You must be assigned either the IQ Bot Admin or IQ Bot services roles.

As you configure a learning instance, a Bot builder creates RPA bots to support the learning instance functions. For more information, see [IQ Bot process overview](#).

1. In Automation 360 IQ Bot, click the **LEARNING INSTANCES** tab to create a new learning instance, upload sample documents to train, and select the OCR engine for document processing.

[Create a learning instance](#)

[Select an OCR engine](#)

2. Train the uploaded sample documents in the IQ Bot Designer.

[Train a learning instance](#)

3. As you finish training each bot, set it to Production mode. When all the bots are in Production mode, set the learning instance to Production mode so it can start processing real documents.

[Tasks performed from Bot page](#)

[Set learning instance to Production](#)

Using Automation 360 IQ Bot Cloud

Create a learning instance, train the bots to extract data from documents, and push the learning instance to the production environment.

Complete the steps to [install IQ Bot](#).

You must be assigned either the IQ Bot Admin or IQ Bot services roles.

As you configure a learning instance, a Bot builder creates RPA bots to support the learning instance functions. For more information, see [IQ Bot process overview](#).

1. In Automation 360 IQ Bot, click the **Learning Instance** tab to create a new learning instance and upload sample documents to train.

[Create a learning instance](#)

Note: As Tegaki API OCR requires a separate On-Premises set up that is not supported in Automation 360 IQ Bot Cloud, all other OCR engines except the Tegaki API OCR are available.

- You will always have the latest version of the OCR engines supported by Automation 360 IQ Bot Cloud, but cannot select a specific OCR version.
- You cannot configure OCR settings from the Control Room. Starting with Automation 360 IQ Bot.19 version, we have provided an internal API that can be used to configure OCR settings in the database.

2. Train the uploaded sample documents in the IQ Bot Designer.

[Train a learning instance](#)

3. As you finish training each bot, set it to Production mode. When all the bots are in Production mode, set the learning instance to Production mode so it can start processing real documents.

[Tasks performed from Bot page](#)

[Set learning instance to Production](#)

IQ Bot user personas and roles

Learn about the users that contribute to IQ Bot and the associated roles and licenses. IQ Bot users and roles are defined in the Control Room.

IQ Bot user personas

A persona refers to the type of tasks that a user performs and the product areas with which a user interacts. To learn more about how each user contributes to IQ Bot, see [IQ Bot process overview](#).

User type	Description	Roles, permissions, and licenses	Access to product areas	Related links
Bot builder	Builds RPA bots to support IQ Bot functions such as training the Classifier and pre-processing documents	Bot developer role + Bot creator license	Automation 360	Build RPA bots for IQ Bot

User type	Description	Roles, permissions, and licenses	Access to product areas	Related links
Data engineer	Creates learning instances, trains bots, and sends bots to production	IQ Bot Admin or IQ Bot services roles	Following tabs in Automation 360 IQ Bot <ul style="list-style-type: none"> • Dashboard • Learning Instances • Bots • Domains • Administration (IQ Bot Admin only) 	Using Automation 360 IQ Bot On-Premises Using Automation 360 IQ Bot Cloud
Admin	Uploads custom domains and migrates learning instances between IQ Bot environments	IQ Bot Admin role or a custom role with the migration utility permission	Following tabs in Automation 360 IQ Bot <ul style="list-style-type: none"> • Dashboard • Learning Instances • Bots • Domains • Administration 	Custom domains in IQ Bot Migrate learning instances
Pseudo-user	Runs the RPA bots to upload, pre-process, classify, and extract data from documents in IQ Bot	Unattended Bot Runner license + view learning instance permission	Automation 360 and IQ Bot	
Validator	Manually corrects fields in documents that IQ Bot could not process	Validator role	Only the learning instances to which permission is granted	Use the IQ Bot Validator

IQ Bot roles

A role determines the areas in IQ Bot to which you have access. Roles are assigned in the Control Room and are of two types, predefined system roles and custom roles. If your user type is Admin, you can create custom roles.

- System roles: These roles are built in and have a predefined set of permissions that cannot be customized.
- Custom roles: These roles can be customized and modified to grant granular permissions to an IQ Bot user. An admin can configure the scope of a role with organization-wide permissions to manage all organizational resources or more narrowly to be limited to department-level resources. For more information, see [Defining a custom role for IQ Bot](#).

The following table describes the permissions and access areas applicable to each system role:

System role	IQ Bot permissions	Access to tabs
AAE_IQ Bot Admin	Access to all IQ Bot features and can migrate learning instances between environments	<ul style="list-style-type: none"> • Dashboard • Learning Instances • Bots • Domains • Administration Migration utility
AAE_IQ Bot Services	All permissions related to learning instances	<ul style="list-style-type: none"> • Dashboard • Learning instances • Bots
AAE_IQ Bot Validator	Can launch the Validator for granted learning instances	Learning instances

Related concepts

[Defining a custom role for IQ Bot](#)

For various roles within IQ Bot, you can use role-based access control (RBAC) to enable or restrict user access to learning instances, related features, and functionality by defining granular permissions. You can also use RBAC to define custom roles in IQ Bot.

Related tasks

[Creating a user with an IQ Bot specific role](#)

Create users in the Control Room to access IQ Bot.

Related reference

[Automation 360 licenses](#)

The **All Licenses** page displays detailed information about current product and device licenses.

Defining a custom role for IQ Bot

For various roles within IQ Bot, you can use role-based access control (RBAC) to enable or restrict user access to learning instances, related features, and functionality by defining granular permissions. You can also use RBAC to define custom roles in IQ Bot.

IQ Bot supports two types of role definitions:

- System roles in Control Room: These roles are built-in and have a pre-defined set of permissions that cannot be customized. To learn more, see [IQ Bot roles](#).
- Custom roles in Control Room: These roles can be customized and modified to grant granular permissions to an IQ Bot user. If you are an admin, by creating a custom role, you can grant users access to specific learning instances.

If you are a user with the **View and Manage Roles** permission, you can use the Control Room to create and assign custom roles.

Permission	Description
View my learning instances	Allows a user to access their own learning instances.

Permission	Description
View learning instances from the same role	Allows a user to view only learning instances created by the same role. Note: If multiple users are assigned the same role, then all these users will have access to the same learning instances.
View all learning instances	Allows users to view all learning instances created by any user across all roles.
Edit learning instance	Allows users to edit learning instances.
Delete learning instance	Allows users to delete learning instances.
Send learning instance to production	Allows users to move learning instances from staging to production.
Import domain	Allows users to import domains into IQ Bot.

Things to remember:

- Ensure that users with **View learning instance from the same role** do not have non-IQ Bot roles. Example: When you create a learning instance, all the roles that you have under your name gets assigned to the learning instance. So, if you have AA_Basic role in combination with **View learning instance from the same role**, then all the users with AA_Basic role have access to IQ Bot. Therefore, users who create learning instances must not be assigned non-IQ Bot roles.
- It is required that creators of learning instances for a specific department must be assigned a minimum of two roles:
 - A role that allows them to create learning instances
 - A department-specific role with the **View learning instance from the same role** permission
- When new learning instances are migrated, existing roles will not be migrated. After the roles are assigned in the target system, they cannot be changed. IQ Bot A360 does not support changing role assignments of learning instances.

Related tasks

[Create a role](#)

As an administrator, you can configure roles with permissions to access features and perform operations such as create, edit, or delete a bot in the Control Room, and assign the role to a user.

[Creating a user with an IQ Bot specific role](#)

Create users in the Control Room to access IQ Bot.

Creating a user with an IQ Bot specific role

Create users in the Control Room to access IQ Bot.

Create administrator, services, and Validator IQ Bot users with Microsoft Windows credentials using the following roles in the Control Room:

- **AAE_IQ Bot Admin**
- **AAE_IQ Bot Services**
- **AAE_IQ Bot Validator**

Tip: The Active Directory users are authenticated with their Active Directory credentials, and the non-Active Directory users are authenticated with the credentials stored in the Control Room database.

Users in Control Room are created depending on the type of user configured during installation.

Note: IQ Bot supports 50 concurrent users. However, Document Extraction if all users are active at the same time, then you cannot run Document Extraction in parallel. Additionally, if the number of concurrent users exceeds 50, system performance might degrade.

1. Log in to Control Room as a user with the **AAE_Admin** role.
 2. Go to **Administrator > Users**.
 3. Click the **Create User** icon.
The **Create User** page appears.
 4. Enter the required information on the **Create User** page.
-

Note:

- The **First name**, **Last name**, and **Description** fields are optional. For a first name and last name, use numbers, spaces (), period (.), hyphen (-), and underscore (_).
 - For a Non-Active Directory user, provide information in each field.
-

5. To create a user with the administrator role, select **AAE_IQBotAdmin**. To create a user with the services role, select **AAE_IQBotServices**, To create a Validator role, select the **AAE_IQBotValidator** role.
6. Select a license to be allocated to the user from the **Allocate a device license to user** section.
If no license slots are available for a role, an alert message appears.
7. Click **Save** to create the user.

To switch a user type from Development to Run-time or vice versa, depending on the automation requirements of your organization, update the license type from the License Management section in Control Room.

After a Validator or a services user is created, an email is sent to the user. The user is asked to do the following:

- Verify the email ID and set the Control Room access password, if the Control Room is configured for the Non-Active Directory users.
- Verify the email ID, if the Control Room is configured for the Active Directory users.

Related concepts

[Defining a custom role for IQ Bot](#)

For various roles within IQ Bot, you can use role-based access control (RBAC) to enable or restrict user access to learning instances, related features, and functionality by defining granular permissions. You can also use RBAC to define custom roles in IQ Bot.

Languages supported in Automation 360 IQ Bot

Up to 31 languages are supported in IQ Bot. You can also access up to 190 languages in IQ Bot by using an OCR engine.

When you review the list of languages in IQ Bot, you will observe the following:

- Some languages are listed multiple times as variants, for example, Norwegian, Norwegian (Bokmal), Norwegian (Nynorsk).
- Among languages that are written from right to left, only Arabic is currently supported on IQ Bot.
- For languages not in the IQ Bot UI by default:
 - These rely on ABBYY FineReader Engine 12.2 for text segmentation and OCR, then IQ Bot for classification, extraction, and auto-correction.
 - Contact your **Cognitive Services** or **Sales Engineering** representative to create IQ Bot custom domains to access these languages.
 - In the SQL database and `.json` file, IQ Bot requires language codes for 160 of the additional languages to appear in the UI, and culture codes to allow numeric and date validation.

Note:

- For ABBYY FineReader Engine and Microsoft Azure Computer Vision OCR engine, IQ Bot uses its text segmentation + OCR.
 - For Microsoft Azure Computer Vision OCR engine, user can select any language from IQ Bot's dropdown, but the API aims to auto-detect the language during processing, and override user selection.
-

The following table provides a list of supported languages in IQ Bot for various document types:

Language	Document types such as invoice, contracts, health insurance, purchase order, and so on	Document type -
English	X	X
German	X	X
French	X	X
Spanish	X	X
Italian	X	X
Afrikaans		X
Arabic		X
Bulgarian		X
Catalan		X
Chinese (Simplified)		X
Chinese (Traditional)		X
Czech		X
Danish		X
Dutch		X
Flemish		X
Greek		X
Hungarian		X
Indonesian		X
Japanese		X
Korean		X

Language	Document types such as invoice, contracts, health insurance, purchase order, and so on	Document type -
Latin		X
Malay		X
Norwegian		X
Polish		X
Portuguese		X
Romanian		X
Russian		X
Serbian (Latin)		X
Slovak		X
Swedish		X
Turkish		X

The following table lists the languages that are supported in IQ Bot through a custom domain:

Abkhaz	Galician	Mari	Sioux (Dakota)
Adyghe	Ganda	Maya	Slovenian
Agul	German	Miao	Somali
Albanian	German (new spelling)	Minangkabau	Sorbian
Armenian (Eastern)	German (Luxembourg)	Russian and English	Sotho
Armenian (Grabar)	Guarani	Mohawk	Sunda
Armenian (Western)	Hani	Mongol	Swahili
Avar	Hausa	Mordvin	Swazi
Aymara	Hawaiian	Nahuatl	Tabassaran
Bashkir	Icelandic	Nenets	Tagalog
Basque	Ido	Nivkh	Tahitian
Belarussian	Interlingua	Nogay	Tajik
Bemba	Irish	NorwegianNynorsk and NorwegianBokmal	Tatar
Blackfoot	Kabardian	Norwegian (Bokmal)	Thai
Breton	Kalmyk	Norwegian (Nynorsk)	Jingpo
Bugotu	Karachay-Balkar	Nyanja	Tongan
Burmese	Karakalpak	Occidental	Tswana
Buryat	Kasub	Ojibway	Tun
Chamorro	Kawa	Old English	Turkmen
Chechen	Kazakh	Old French	Turkmen (Latin)

Chukcha	Khakas	Old German	Tuvan
Chuvash	Khanty	Old Italian	Udmurt
Corsican	Kikuyu	Old Slavonic	Uighur (Cyrillic)
Crimean Tatar	Kirghiz	Old Spanish	Uighur (Latin)
Croatian	Kongo	Ossetian	Ukrainian
Crow	Korean (Hangul)	Papiamento	Uzbek (Cyrillic)
Dargwa	Koryak	Tok Pisin	Uzbek (Latin)
Dungan	Kpelle	Portuguese (Brazil)	Vietnamese
Dutch (Netherlands)	Kumyk	Portuguese (Portugal)	Cebuano
Eskimo (Cyrillic)	Lak	Provençal	Welsh
Eskimo (Latin)	Sami (Lappish)	Quechua	Wolof
Esperanto	Latvian	Rhaeto-Romanic	Xhosa
Estonian	Latvian (language written in Gothic script)	Romanian (Moldavia)	Yakut
Even	Lezgin	Romany	Yiddish
Evenki	Lithuanian	Ruanda	Zapotec
Faeroese	Luba	Rundi	Zulu
Fijian	Macedonian	Russian (old spelling)	
Finnish	Malagasy	Russian (with accents marking stress position)	
Frisian	Malinke	Samoan	
Friulian	Maltese	Selkup	
Scottish Gaelic	Mansi	Serbian (Cyrillic)	
Gagauz	Maori	Shona	

The following table provides you with links to supported languages for all IQ Bot supported OCR engines:

IQ Bot supported OCR engines	List of supported languages
ABBYY FineReader Engine	ABBYY FineReader Engine OCR supported languages
Microsoft Azure Computer Vision OCR engine	https://docs.microsoft.com/en-us/azure/cognitive-services/computer-vision/language-support
Google Vision API	https://cloud.google.com/vision/docs/languages
Tesseract4 OCR 4.0.0	https://tesseract-ocr.github.io/tessdoc/Data-Files-in-different-versions.html

IQ Bot supported OCR engines	List of supported languages
Tegaki API	<ul style="list-style-type: none"> • Japanese • Korean • Japanese - English • Korean - English

Note: The supported languages in IQ Bot must be considered in concurrence with the OCR supported languages.

Tip: If you are unable to see all languages in the IQ Bot UI or if IQ Bot is unable to extract data from multiple languages in a document, troubleshoot the issue:

Unable to extract data from Multiple languages in a document (A-People login required)

Note: If you are adding custom language to a custom domain, then you must retain the language ID across all installations from where IQ Bot learning instances will be exported and imported.

About the Classifier

Learn about how documents are classified and the factors that affect classification.

When documents are uploaded to a learning instance, the Classifier sorts the documents into document groups based on the layout, which is the order in which the fields appear on the page. If a document is uploaded to a learning instance in production and the document does not match the layout of any of the document groups, the Classifier creates a new group for that document.

The following graphic illustrates how uploaded invoices that contain specific fields are sorted into one of three groups, depending on the order in which the fields appear in the invoice.

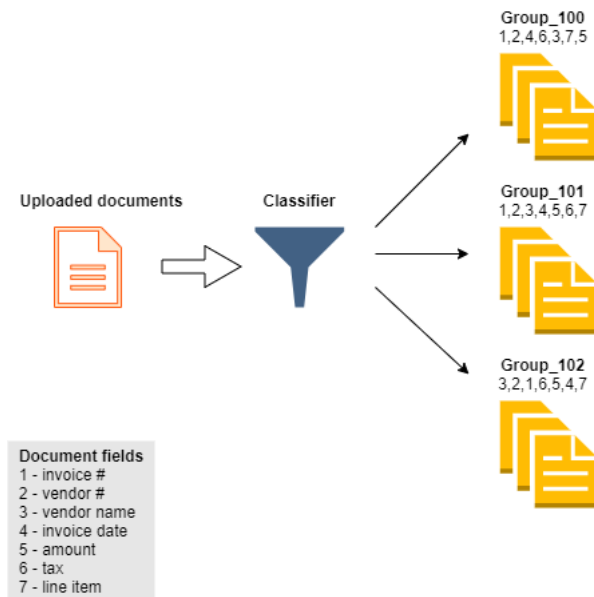

Alternatively, you can manually define a document group to process all the documents with an identical layout. In this case, IQ Bot bypasses the Classifier and sends the document to the group you created that has the same layout as the uploaded document. This option is useful when the OCR fails to detect one or

more fields in a document, causing the Classifier to unnecessarily create a new document group or send the document to the wrong group. See [Create a new document group](#).

Note: User-created document groups cannot be deleted.

The Classifier is supported by RPA bots and the IQ Bot Classifier package. It contains actions that automate identifying and sorting the different document types. See [IQ Bot Classifier package](#).

Resources

Watch the following videos to learn more about how the Classifier works and how to use it:

<https://www.youtube.com/embed/MXwtff5kL84>

<https://www.youtube.com/embed/EdUNEHtu8i0>

Learning instances created with out-of-box or custom domains

IQ Bot checks for a minimum number of fields that you selected to successfully classify the document. In all other cases, the document will be marked as unclassified.

For example:

- If you create a new learning instance with one to four fields selected, IQ Bot checks for at least four fields from the total number of fields presented for that specific learning instance. Similarly, if you create a learning instance with five fields selected, IQ Bot checks for at least five fields.
- If you create a learning instance with six or more fields selected in the learning instance, IQ Bot checks for at least six fields. For example, if you selected eight fields in an invoice domain, IQ Bot checks for at least six fields out of the total fields available.

Learning instances created with other domains

If you create a learning instance with multiple fields, IQ Bot checks for at least one field and classifies the document. If IQ Bot does not find any field, the document will be marked as unclassified.

Factors that impact classification

Factor	Notes
Page layout	If the page layout is different from the original document with respect to document content position, IQ Bot sends the document to a different group.
Label orientation	All the labels in a document must be oriented in the same direction. If some of the labels are vertical and some horizontal, the document is sent to a different group.
Label position	Labels can be positioned anywhere on the page. However, the label sequence from left to right and top to bottom must be the same as in the training documents.
Match percentage	IQ Bot uses a 70% match for labels.

Factor	Notes
Fields added after the learning instance is created	Fields added after a learning instance is created are excluded from the classification process.

Related tasks

[Limit the creation of document groups](#)

Limit the number of new document groups that the Classifier can create when a learning instance is in production.

Create a new document group

Manually define a user-created document group to process documents with an identical layout. For example, invoices from a specific supplier.

- If you have not done so already, [Create a learning instance](#). After you create a learning instance, you are redirected to the document groups page, where you create a new document group.
- Identify the group label. This is the name of the folder in the `documents\classify\train` directory where documents with an identical layout are sent. You will provide the group label in the steps below.
- Identify sample documents (maximum 150) that have an identical layout. You can upload more documents to train the group after the group is created.

1. Navigate to the learning instance details page and click **Create group**.

2. In the **Group label** field, provide the folder name that contains the sorted documents in the `documents\classify\train` directory.

3. Click **Browse** to upload sample documents to define the layout.

4. Click **Save**.

1. Configure the mechanism to sort incoming documents to the correct group:

- To use the Classifier, run the bot with the **Train Classifier** action to create the classification model and sub-folders to hold the sorted documents in the `documents\classify\train` directory. See [Using Train Classifier action](#).
- Alternatively, create RPA bots identify and sort incoming documents using conditional statements, such as string-matching the file name or sender. See the String condition in the [Loop package](#) or [If package](#).

2. Update the following actions:

- **Optional:** Update the **Classify Document** action to use **Express mode**. See step 6 in [Using the Classify document action](#).
- Update the **Upload document** action to provide the group label. See step 4 in [Upload document action](#).

3. Upload more documents to train the group. When you are done with training, set the group to production.

4. After you set the group to production: If you have a bot with the **Process Documents** action, you must update the action with the group label. See step 7 in [Using IQ Bot Process documents action](#).

Note: During the production process, you must not move the learning instances or bots from Staging to Production or vice-versa.

Create a learning instance

Create a learning instance and upload sample documents for training. In this step, you define the data elements for a single document type, such as an invoice or a purchase order, and the fields which you want to extract.

Ensure the sample documents meet the following requirements:

- Each document is a separate file. For example, if you have downloaded an email and its attachments into a single PDF, you must separate the email body from the attachments. See [Using the Split document action](#).
- The documents are in one of the following supported file types:
 - PDF
 - JPG
 - JPEG
 - PNG
 - TIFF
- Use documents with a resolution value of at least 300 dots per inch (dpi).
- In staging, you can upload a maximum of 150 documents of 10 MB file size per learning instance.
- In production, you can upload a maximum of 50 MB file size per document. However, the maximum number of documents allowed per learning instance depends on the license.
- There are no limitations on the number of pages per document in a pdfbox OCR.
- You can upload 60 pages per document in an image-based OCR.
- You can upload up to a file size of 12 MB. You can upload additional documents after creating the learning instance.
- The file names of the documents that you upload should not start with special characters, such as the hyphen (-).

Note:

- With the Tesseract4 OCR, currently there is a known limitation which restricts the number of pages per document to less than 60 pages.
- Azure confidential computing enables organizations to upload encrypted data to secured storage, such as private folders on a virtual machine. If you upload documents from such secured folders to IQ Bot, these are moved to **Unclassified** status as data extraction is not supported for such documents.

When you start with a collection of documents to insert into a digital process, you will probably have a mix of documents types, formats, and orientations. An invoice, for example, has a consistent set of data elements, whereas a purchase order contains a different set of data elements. You must create a different learning instance for each of these document types, using the following steps:

1. Navigate to **LEARNING INSTANCES** and click the **New instance** option.
2. In the **Create new learning instance** screen, enter the following information:
 - a) **Instance name:** Enter a unique name.

IQ Bot version **A360.21 and below** does not allow duplicate learning instance names. Even if you delete a learning instance, the name cannot be reused. From **IQ Bot version A360.22**, it

is possible to create duplicate learning instance names, as well as reuse the name of a deleted learning instance.

- b) Optional: **Description:** Enter a description.
- c) **Document type:** Select the document type from the drop-down list.

Do not choose standard forms as **Document type** while creating learning instance. Based on the option you select, a predefined set of form and table fields for the domain type appears. For example, when you select **Invoices**, the common forms and tables of an invoice appear.

Note: If you want to create a domain to use specifically for this learning instance, select **Document type > Other** and enter a domain name. In the upcoming steps, you will customize the domain.

For more information on creating a custom domain, watch the following video:<https://www.youtube.com/embed/mxn26uQDPoI>

If you want to create a domain to use in more than one learning instance and you have the required access permissions, you can work with Automation Anywhere support to create a custom domain. See [Custom domains in IQ Bot](#) for more information.

-
- d) **Primary language of documents:** Use the drop-down menu to select a language for the learning instance.

[Languages supported in Automation 360 IQ Bot](#)

To create custom domains in other languages and access up to 190 languages that IQ Bot supports, contact Automation Anywhere support.



Trouble: If you are unable to see all languages in the IQ Bot interface, troubleshoot the issue: [Unable to extract data from Multiple languages in a document \(A-People login required\)](#)

-
- e) **Upload your documents:** Click the **Browse** option to upload sample documents.

3. Select or de-select fields in the Common form fields and Common table/repeated sections fields sections.

Form fields appear one time in a document, such as the invoice date or number. Table fields are fields that reoccur throughout the document, such as the item total or quantity.

To see all the possible fields, click **Additional form fields** or **Additional table/repeated section fields**.

4. Optional: Add additional fields by entering the field name in the Additional form fields or Additional table/repeated section fields section.

Follow the naming conventions when you enter a name in the **Add fields (Optional)** field:

- Field names can only begin with alphabetical characters (A-Z and a-z).
- Field names can only include alphanumeric characters and spaces.
- Field name cannot end with a space.

5. Optical Character Recognition: Select the required OCR engine.

[Select an OCR engine](#)

6. Optional: De-select the My PDF documents do not have images check box. To learn more, see Disable PDFBox option

When this check box is selected, IQ Bot uses PDFBox OCR to process PDF documents; non-PDF documents are processed by the OCR you selected in the previous step.

7. Checkbox auto-detection: Select the **Detect checkboxes** check box to enable this feature.

Selecting this option allows IQ Bot to automatically detect check boxes in a document. However, it might increase the processing time of documents.

8. Click the **Create instance and analyze** option to create the learning instance. The system analyzes and sorts the training documents into logical groups based on field identification and shows the details in the **Learning Instance > Summary** tab.

When a new learning instance is created, the sample documents you uploaded are analyzed and sorted into groups based on the document characteristics. To learn more, see [About the Classifier](#).

After the Classifier finishes sorting the documents, you are redirected to the Designer, where you will train bots to extract data from each sample document. [Train a learning instance](#).

Related tasks

[Select an OCR engine](#)

You can select an OCR engines that suits your requirement for data extraction based on your document types. Restarting IQ Bot services is not necessary for implementing an engine change.

Related reference

[Create a learning instance for standard forms](#)

Learning instance is used in IQ Bot to extract, train, validate content from standard forms. Use the following instructions to create a learning instance for processing standard forms in IQ Bot

Select an OCR engine

You can select an OCR engines that suits your requirement for data extraction based on your document types. Restarting IQ Bot services is not necessary for implementing an engine change.

During IQ Bot installation, the system sets the latest version of Tesseract Optical Character Reader as the default OCR engine. This is also the default setting for the product. However, you can manually set the OCR engine in the `Settings.txt` file, which becomes the default engine. Similar to the prior releases of IQ Bot, you can continue to manually update the `Settings.txt` file with the OCR engine name you want to set as default.

When creating a learning instance, you can select an OCR engine from the **Optical Character Recognition** drop-down menu. See [Create a learning instance](#)

Note: Selecting an OCR engine in the interface overrides the settings in the `Settings.txt` file.

The following table lists the various OCR engines supported in IQ Bot and the corresponding options:

Table 4: List of OCR engines and their specifications

Qualifiers	OCR Version	Supported installation	Handwritten	Languages Supported	Document Quality	Document Type
Tesseract OCR	4	Cloud and On-Premises	N/A	English German Spanish Italian French	No noise No dark background No stamps/watermarks 200+ dpi	Invoices, POs, etc. Semi-structured formats

Qualifiers	OCR Version	Supported installation	Handwritten	Languages Supported	Document Quality	Document Type
ABBYY FineReader Engine	12.3, or 12.4	Cloud and On-Premises	N/A	English All Latin+ Chinese Japanese Korean	Less noise Dark background with white fonts Has stamps/watermarks 96+ dpi	Invoices, POs, etc. Semi-structured formats Mortgage Forms, Tax Forms Unstructured Formats
Microsoft Azure Computer Vision OCR engine	2.0 or 3.2	Cloud and On-Premises	English only	English All Latin+ Chinese Japanese Korean	Less noise Dark background Has stamps/watermarks 96+ dpi	Invoices, POs, etc. Semi-structured formats Passports, Driving license, etc. KYC documents
Google Vision API	Version is updated automatically to match current release	Cloud and On-Premises	N/A	English All Latin+ Asian	Less noise Dark background Has stamps/watermarks 96+ dpi	Invoices, POs, etc. Semi-structured formats Mortgage Forms, Tax Forms Unstructured Formats
Tegaki API	Check with your Cogent Labs sales representative	On-Premises only	Japanese and Korean	Japanese and Korean	No noise No dark background No stamps/watermarks 200+ dpi	Invoices, POs, etc. Semi-structured formats

1. On the **Create a new learning instance** page, select the domain and language of the documents. In the **My learning instance** list page, a new **OCR Engine** column is available that shows the OCR engine used for creating each learning instance. This information is useful to the user when deciding on document processing.

2. The **Fields to extract** and **Advanced Settings** sections are displayed when you select the domain. Each domain is available with a predefined list of primary supported languages. Language selection is enabled and available from the **Primary language of documents** drop-down list based on supported languages for a specific domain.

Note: If you select a language from the **Primary language of documents** drop-down list and then select an engine that does not support that language, the system displays an error message in the **Optical character recognition** drop-down list.

3. Click **Advanced Settings > Optical character recognition** to display the OCR engine options drop-down list.

If the OCR engine selection is invalid, the **Create instance and analyze** option is not enabled.

Note: IQ Bot automatically installs all OCR engines during the installation process, except for ABBYY FineReader Engine.

Important: You can only configure the selected OCR engine in Automation 360 IQ Bot On-Premises. OCR settings in Automation 360 IQ Bot Cloud cannot be edited as they are not accessible except for ABBYY FineReader Engine. You can edit the configuration settings for ABBYY FineReader Engine using the `appConfigurations` REST API.

You can select from the following:

Option	Description
Tesseract OCR 4	This is the default engine, unless changed in the <code>Settings.txt</code> file.
ABBYY FineReader Engine	To verify if ABBYY FineReader Engine is installed and available for use on your machine, check the <code>Settings.txt</code> file, the OCR Plug-ins folder for the SDK files, and the Optical character recognition drop-down list. Note: Also supported in IQ Bot [Local Device] package and IQ Bot Extraction package. <i>Use ABBYY FineReader Engine OCR engine in IQ Bot</i>
Microsoft Azure Computer Vision OCR engine	IQ Bot supports all languages supported by this OCR engine. <i>Use Microsoft Azure Computer Vision OCR engine</i>
Google Vision API	IQ Bot supports Google Vision API as an OCR engine and supports all languages supported by this engine. <i>Use Google Vision API OCR engine</i>
Tegaki API	IQ Bot supports his OCR engine to extract data specific to Japanese and Korean language documents. You need to download and use your private license to use Tegaki API. Note: Tegaki API OCR engine is not supported in Automation 360 IQ Bot Cloud. <i>Use Tegaki API OCR engine</i>

Option	Description
My PDF documents do not have images	<p>All the PDF documents that you upload are processed using the PDFBox OCR by default, regardless of the OCR engine you have specified or selected.</p> <p>If you are uploading non-PDF documents or PDF documents that contain images, clear the My PDF documents do not have images check box to ensure that the OCR engine that you have specified or selected is used to process the documents.</p> <p>The My PDF documents do not have images check box is enabled by default. To disable this feature, see Disable PDFBox option.</p>

Tip: If IQ Bot is unable to extract data from low quality or handwritten documents, troubleshoot the issue:

[IQ Bot unable to extract data from low quality and Handwritten documents \(A-People login required\)](#)

Note: Use the following files to change the OCR settings:

- AbbyyImagePreProcessingSettings.json
- LanguageCodeToAbbyyLanguageCode.json
- TegakiOCREngineSettings.json
- Azure3OCREngineSettings.json
- GoogleOCREngineSettings.json
- AzureOCREngineSettings.json

[How to change OCR Settings in IQ Bot \(A-People login required\)](#)

Edit a learning instance

Edit a learning instance to change its name, description, add additional training documents, or include additional fields for extraction.

You can only edit a learning instance on Staging. So ensure you move any learning instance in Production environment to Staging to edit it.

1. On the **Learning Instances** page, click a learning instance.
2. Click the **Edit** icon to edit the learning instance.
3. Optional: Update the description field.
4. Optional: Change or update the learning instance name.

When you change the name of a learning instance, the following changes occur:

- A separate folder with the new learning instance name is created in the configured output directory to store the .csv files of processed documents.
The previous folder containing the .csv files before the learning instance name was changed remains as is in the output folder.
- When you migrate a learning instance with an updated name using overwrite or remove options, it is updated in the source environment after the .iqba file is imported.
- An entry in the audit logs is created for this activity.

5. Optional: Click **Browse** to select additional training documents.

The file names of the documents that you upload should not start with special characters, such as the hyphen (-).

6. Optional: Select additional fields and table columns to add to the learning instance for data extraction.
7. Use the **New groups creation setting** field to restrict creation of new groups or set the threshold for the number of groups.

Note: The **New groups creation setting** field only applies to the documents in Production. However, this field option is not applicable for IQ Bot [Local Device] and IQ Bot Extraction packages.

For more information, see [Limit the creation of document groups](#).

8. Optional: Use the **Default validations group** option to select a default group for document validations.

All new documents use the custom logic and validations defined in the default group. Validation rules from this default group are applied when a document does not belong to any of the existing group. If you delete the selected default group, the validation rules are not applied to any of the new documents that were supposed to use this group.

Note: If you select a default group, you can only change it to another group. However, you cannot select **Select default validation**, which is the default setting.

9. Click **Save** to view a confirmation message.
10. Click **Yes, proceed with field addition** to upload, analyze, and classify the selected training documents (if any) that were added to the learning instance.
The classification of documents remain unaffected by the newly added fields.

All additional fields become available in all the bots and appear as optional fields in the selected learning instance. The bots must be retrained for these fields.

See [Errors generated while editing learning instances](#).

Limit the creation of document groups

Limit the number of new document groups that the Classifier can create when a learning instance is in production.

You can only edit a learning instance that is in staging. If the learning instance is in production, you must revert it to staging.

When documents are uploaded to a learning instance, the Classifier sorts the documents into document groups based on the layout, which is the order in which the fields appear on the page. If a document is uploaded to a learning instance in production and the document does not match the layout of any of the document groups, the Classifier creates a new group for that document.

Use the following steps to either configure a limit for the number of total document groups in the learning instance, or opt to disallow the Classifier from creating new document groups.

1. Navigate to **LEARNING INSTANCES**, select a learning instance, and click **Edit**.

2. Select from the following options:

Option	Description
Select the Never create new groups check box	<p>No new groups are created, irrespective of the number of document uploads. The uploaded documents are sent directly to the Validator.</p> <ul style="list-style-type: none"> • This check box is deselected by default. • When this option is selected, the Threshold to create new groups field is disabled. • You can create new groups manually by uploading them to the learning instance in staging.
Set a value for the Threshold to create new groups field	<p>When you set a threshold value, IQ Bot does not create a group for the uploaded documents till it reaches the defined value. Till the set threshold value is reached, all documents are sent to the Validator.</p> <ul style="list-style-type: none"> • By default, the value is set to 10 for all new learning instances. • You can set a value of up to 10 digits. • IQ Bot does not allow you to enter non-numerical characters, zero, or floating points.

3. Save your updates, which are then reflected in the **Summary** tab.

The **Summary** tab displays all the staging and production details. The information is updated based on any applied setting in the **New groups creation setting** section.

For new learning instances, unless you set the minimum threshold in the **New groups creation setting** section, IQ Bot applies the default set value of 10 and does not create groups for the first 9 uploaded documents.

4. For existing learning instances, you can set the minimum threshold in the **Learning Instance > Edit** page. The new threshold is applied to all documents from then onward.

All existing learning instances, even after upgrade, will continue with a threshold as 1.

All changes take effect only on the documents uploaded in production after the setting is edited.

If you change the setting to a new threshold or never create new groups with an existing learning instance, this check will be performed only on the next document uploaded in production.

In the production environment, all classified documents that do not belong to any group and do not meet the minimum threshold requirement are sent to the Validator. You can update the values and make necessary corrections. However, all fields are optional and are text data type. The user can **Save current document** without making any corrections, or choose the **Mark as Invalid** option.

Errors generated while editing learning instances

Use case scenarios and error messages generated while editing a learning instance are explained in this topic.

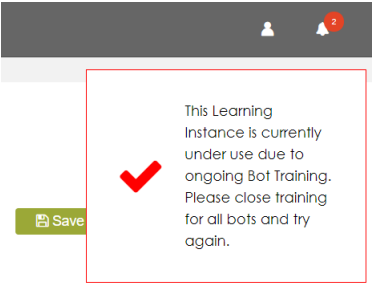
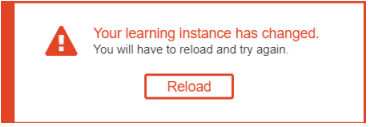
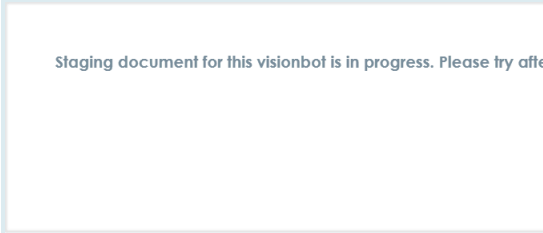
Case	Details	Message
Bot in training	Learning instance is in use because of ongoing bot training and you edit the same instance A) User 2 is editing the same learning instance	
Case 1: Simultaneous editing of same learning instance	Example for case 1: User 1 uploads a document to the same learning instance. User 2 adds a field when editing the same learning instance.	
Run and edit the same bot	Run the bot and then edit the same bot using the same user login or two different user logins.	

Delete a learning Instance

Use the **Learning Instances** page to delete a learning instance from the **View Details** page.

You cannot delete a learning instance that is in the production environment. To edit a learning instance, do the following:

1. On the **Learning Instances** page, click the learning instance or **View Instance Details** icon to show the **Summary** tab.
2. On the details page, : click the **Edit** icon. The learning instance becomes available for editing.
3. To delete the learning instance, click the **Delete Instance** button. A confirmation message appears.
4. Enter the learning instance name in the field and delete the learning instance.

Important:

Unless you have already exported the learning instance as a backup, the following occurs after you delete a learning instance:

- It is permanently deleted and cannot be restored.
- All the associated bots are deleted and cannot be reused.

- You cannot reuse a deleted name for a learning instance to create a new one.

Disable PDFBox option

The PDFBox option is enabled by default. Disable the option when you are training hybrid PDF documents containing images and text.

The PDFBox option works best with completely digital documents only. When using hybrid documents containing images and text, our recommendation is to disable the PDFBox option for better document classification.

Note: The PDFBox option is enabled in the system by default. Ensure that the PDFBox is kept enabled only if you plan to process digital documents, otherwise processing will fail.

If PDFBox is enabled, you can process the following PDF types:

- **Vector and Hybrid** PDF can be processed using PDFBox
- **Raster** PDF can be first processed using PDFBox, and if no segment is found then the PDF is processed again using Document Image OCR

There are two ways in which you can disable/enable the PDFBox option in IQ Bot:

- Directly in the UI during the creation of a learning instance. In the **Create new learning instance** page go to **Advanced Settings > Optical character recognition** and disable/enable the **My PDF documents do not have images** check-box.
- In the `Setting.txt` file described as follows:

1. Navigate to `C:\Program Files (x86)\Automation Anywhere IQ Bot\Configurations`.
2. Open the `Setting.txt` file, and change `PDFBoxOCREnabled=true` to `PDFBoxOCREnabled=false`

This turns off the processing of uploaded documents by PDFBox for new learning instances (after applying this change), and does not apply to the existing learning instances. IQ Bot will use your selected OCR engine for PDF documents as well.

Note: When PDFBox is disabled, ensure that your PDF document is less than 60 pages.

3. After updating the `Setting.txt` file, execution of `stoppedanduninstalled` and `installedandstartedstart` of IQ Bot services is not required.

Train a learning instance

Use the staging environment to train a learning instance and extract data from sample documents. Review each field to verify whether the correct value is extracted and where necessary, map the correct field.

When you upload sample documents while creating a learning instance, the Classifier analyzes and categorizes these documents into logical groups. The system creates a bot for each document group, which you must train to extract data from specific fields in the sample documents.

The following steps provide an overview of the training process:

Step 1: Open the Designer

From the **My Learning Instances** page, open a learning instance and click **Edit bot** or **Create bot** to start training the learning instance.

Step 2: Map the document fields

For an introduction to the components, see [Introduction to the Designer](#).

In the **Fields** section, click each form field to verify whether the correct value is extracted. If the value is incorrect or if the field was not found (indicated by a grayed-out check icon next to the field), you must remap the field.

- [Map a field](#)
- [Delete mapping in the Designer](#)

Step 3: Map the check boxes (if applicable)

If you configured the learning instance and uploaded sample documents containing check boxes or option buttons, see [Extract data from check boxes or check box groups](#)

Note: Check boxes and check box groups can be extracted as either a form or table field depending on whether the check box appears one time or on a recurring basis in the document.

Step 4: Map the table fields

Review each table field to ensure that the correct column name is identified in the **Column Value** field. If IQ Bot did not find the correct Column Name, remap the column name by using the same approach as you did for the form fields. Then, configure the table settings. [Map a table](#)

If the document contains more than one table, define the additional tables:

1. Add all the table fields to the **Additional table/repeated fields** section of a learning instance. [Edit a learning instance](#).
2. Map the additional table fields. [Add multiple tables in Designer](#).

To establish a relationship between the fields of the different tables, see [Define one or more linked fields in a child table](#).

Step 5: Review the training results

Click **See extraction results** to check the extracted data from the document group. [Preview extracted data](#)

If not all of the fields are extracted, try resizing the mapping areas for those fields.

Alternatively, train the bot by using a different document. [Change the training document for a group](#)

Step 6: Save the bot

Click **Save and go to next group** to train the bot for the next document group.

A menu appears, with the option to **Cancel**, **Save**, or **Save and send to Production**.

Note: We recommend that you test the bot (see next step) before sending it to production.

You can view the status of all the bots in all your learning instances from the **BOTS** tab. [Manage IQ bots](#)

Step 7: Test bot extraction capabilities

Navigate to the **BOTS** tab and click **Test bot**.

The bot processes the remaining documents in the document group based on the trained document. To see the bot performance, review the values in the **Learning instance summary** page, particularly the straight-through processing (STP) metric. [Review the learning instance details](#)

If the STP number is low, you can either retrain the bot, such as by resizing the mapping areas or train the bot on a different document. [Change the training document for a group](#)

Step 8: Send the bot to production

When you are satisfied with the extraction accuracy of the bot, switch it to production mode. Then, switch the learning instance to production mode. Once a learning instance is in production mode, IQ Bot is ready to begin processing documents in real time: classifying the uploaded documents to the document groups with bots in production and either extracting data or sending the document for manual validation.

From the **Learning Instance Details** page, click the switch at the top right to move the learning instance into production mode. [Set learning instance to Production](#)

Note: If you want to retrain a bot, both the learning instance and the bot must be in staging mode.

Related concepts

[About the Classifier](#)

Learn about how documents are classified and the factors that affect classification.

Introduction to the Designer

The Designer is the user interface where you train bots to extract data from uploaded sample documents. The Designer contains auto-mapped fields and table columns, where you can edit the existing mapping or add new fields and tables.

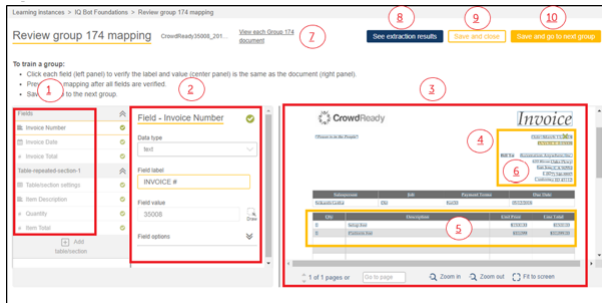

Highlighted areas are:

1. **Fields panel:** List of fields selected for extraction during Learning Instance creation. Fields successfully found are indicated with a green check mark.
2. **Field Details panel:** Details for the highlighted field in the Fields Panel, including data type and extracted value.
3. **Document Image panel:** Rendered image of the document with image view controls
4. **Form fields:** A field that has a single value in the document, such as the invoice number or invoice date.
5. **Table fields:** A field with values that appear more than one time in a document, such as the item description or quantity.
6. The blue boxes indicate System Identified Regions (SIRs) where IQ Bot found extractable data.
7. The training document can be changed by clicking **View each Group (#) document**.
8. The extraction can be tested using **See extraction results**.
9. **Save and close:** Saves the changes and returns to the Learning Instance details page.
10. **Save and go to the next group:** Saves changes, allows the Group to be set to Production mode, and moves to the next available Group.

Note: If you have multiple files in a group and one of the document is deleted, then you will see an error message **Unable to load document** and you will not be able to change the document for training in the Designer. When the entire multi-page document is deleted or corrupted, you will not be able to navigate between the pages. If you click the next page button, then the **Loading document** screen is displayed.

Change the training document for a group

During document training, look at unique document layouts available in a group, and choose a different document than the default one chosen by IQ Bot Designer, that is more representative of documents across that group. That helps maximize straight-through processing (STP).

Follow the steps to choose a different document from a document group.

1. User can see the **View each Group 'x' document** button in the Designer training page next to the document name.
The **View each Group 'x' document** button is disabled if there is a single document in the group.
2. Click the **View each Group 'x' document** button to display the previous and next arrows that will let you move to another document. You can also cancel out of the task.
Choosing a different document as the group's training document will clear all mapping from the previous document. IQ Bot displays a warning message stating the same.
3. Select a new document and click the **Change the training document** button to see a message confirmation stating: *If you change the training document for this group, any mapping from the previously trained document will be lost. Do you want to change the training document for <group name> to <document name>?*
4. Choosing **No, cancel** takes you back to the Designer, whereas confirming the message **Yes, change** loads and launches the new document with auto-mapped fields.
5. Click **See extraction results** to view extracted data from the new document.

Tasks performed from Bot page

This page lists all the available bots for a learning instance, and enables you to perform tasks such as run, change the status, or launch the IQ Bot Designer.

Create a bot to extract text from a document. Define the field labels and values in a document so that the system can learn from it and automatically process other documents in the document group..

Monitor the progress and status of all bots created for a learning instance and set the status from Staging to the Production environment.

Testing a bot verifies that the bot can reach the required accuracy based on the training. It also runs it against all the sample documents associated with that category or group and benchmarks document and field accuracy. Test a bot only in the Staging environment.

Note:

- To view the updated document and field accuracy, refresh the **Bots** page and click the bot name. The updated document and field accuracy appear in the details area.
 - You cannot edit a bot that another user is already editing.
-

Various bot states

The status of a bot is dependent on the state of the learning instance as well as the bot. The table below shows the relationship between learning instance state, bot state, and bot status.

Learning Instance State	Bot State	Bot Status
Staging	Staging	Training

Learning Instance State	Bot State	Bot Status
Staging	Production	Ready
Production	Staging	Training
Production	Production	Active
Created	Not created	No listing

Delete a bot

The following are some key points:

- Clicking the **Delete bot** button displays a message asking if you want to delete the Bot. Selecting yes displays a success message in the Learning Instance details page. The **Summary** tab shows the updated information in the **Staging** and **Production** results sections for the **Groups found** and **Bots created** fields.
- You can delete a Bot in Staging only. Once deleted, the Bot does not display in the Learning Instance details page or the Bot listing page.
 - All associated staging documents are removed from the system.
 - All associated unprocessed production documents get moved to the Validator for processing.

Note: A new Bot is created when the same documents are uploaded again to Staging or Production.

- On re-uploading the deleted documents from the learning instance, the system classifies the documents and displays the groups again with the **Create Bot** option for each group. Clicking the **Create Bot** option creates the Bot and you can see it in the **Create Bot** details page.
- In case of backend exceptions, such as disruption of Services, the system does not let you delete the **Bot**. Instead, it displays an error message saying that an unexpected error has occurred.

Related tasks

[Create your first bot](#)

Perform the following steps to create your first bot that prints the message, `Go be great!`, the Automation Anywhere version of `Hello World!`

Improve output quality using OCR confidence

Improve the output quality of the IQ Bot platform using the system-identified region (SIR) and optical character recognition (OCR) confidence by comparing it to a predefined threshold.

Confidence-based validation is useful for a text type field and for Date or Number fields because it helps route a document, with contentious values, for a human to view despite the fields satisfying the set validation criteria.

Enable OCR confidence-based validation

Note: This option is applicable only if you selected Tesseract OCR when creating the learning instance.

This feature is disabled by default. To enable this feature, open the `Settings.txt` configuration file available in `<IQ Bot Installation Folder>\Configurations\`, and set the desired threshold value in the `ConfidenceThreshold` property. For this example, set the character-level confidence

threshold value to 99, that is `ConfidenceThreshold=99`. When this feature is disabled, the default value is set to 0, signifying that the feature is disabled.

Note: The confidence threshold value is uniformly applicable across all the learning instances.

How OCR confidence-based validation works

In a document if a field's SIR character level confidence is lower than that of the set confidence threshold, the validation for that field fails, resulting in the failure of that document.

Note: If a field value fails due to a validation rule (for example, Invalid Number Format) other than an OCR confidence validation failure, you see that tooltip, and not the tooltip for *Low confidence*.

While training a document, a confidence-based validation failure against a field appears in an orange box during preview if no other validation errors exist for that field. Other validation errors take precedence over OCR character-level confidence validation.

Troubleshoot: If the OCR engine is not able to identify SIRs for Chinese language PDF documents, troubleshoot the issue:

- [Data objects \(SIRs\) are not identified by OCR for Chinese PDF documents \(A-People login required\)](#)
 - [How to convert PDF files to TIFF files \(A-People login required\)](#)
-

Map a field

When you are training a learning instance, if a field value was extracted incorrectly or if the field was not found, you must remap the field.

If you have not done so already, first create a learning instance with sample documents. [Create a learning instance](#)

For an introduction to the components, see [Introduction to the Designer](#).

The Designer image display panel contains blue boxes that surround text, date, or number type data. Each of these blue boxes is a system identified region (SIR) that indicates that IQ Bot has identified that region as containing extractable data. Perform the following steps to map a field to teach IQ Bot to extract data from that field (for example, the invoice number) from a specific region (for example, the top-right side of SIR).

Note: These steps apply only to text, number, and date data types. IQ Bot also supports check boxes. For more information, see [Extract data from check boxes or check box groups](#).

1. Select a field and specify the data type from the **Data type** list.

Note: If a field value contains a mix of letters and numbers, such as invoice number, select the **Text** option.

2. In the image display panel, click the field from where you want to extract data.
IQ Bot tries to identify and autopopulate the corresponding field value in the field details panel.

Tip: Use the pipe symbol (|) to add field aliases, which represents alternative text that might be present in an SIR. For example, if the recipient's information is in a field labeled `Sold to` in some of the documents and in `Ship to` in other documents, enter `Sold to | Ship to` as the field label.

- Optional: Drag the corners of the green-bounded box to resize the mapping area.

Alternatively, draw a new mapping area by holding and dragging the cursor.

When you resize any value region or create your own value region using select, its position is fixed relative to the field label. The value for that field is always searched in that relative region.

Reset a fixed field region defined by the user in the autodetected mode by clicking the close button at the top-right corner of the field.

For additional information, see [What are the different ways to map form fields in IQ Bot \(A-People login required\)](#).

- Optional: If the column value is not consistently available in the training documents, expand the **Field options** section and select **Optional**.
- Optional: Add validation patterns or custom logic.

[Designer validation patterns](#) | [Adding custom logic to improve automatic extraction in production](#)

Review each field to verify whether the correct value is extracted. Then, proceed to mapping table fields. See [Map a table](#).

Use list validation to improve accuracy of a text field

Setting validations while defining any field or table column while mapping the document class helps validate a field or table column against predefined parameters so that you can be warned if any mismatch is found during the data digitization process.

Enter each text value in a separate line.

- The bot validates extracted value of field/table column against this predefined list and checks for any mismatch found during the **See Extraction Results** phase.
- Besides validating, the process also helps auto correct the extracted values.
- Errors in validation are marked with a red border and can be seen in the **See Extraction Results** phase. Move your cursor over the error to know the error type.

If list validation value is **Adam**, and the extracted value is **Adem**; the extracted value will be auto corrected to **Adam**. In this example, there is a 75% match of characters; and threshold for match is at least 66%.

Use validation patterns/lists to flag discrepancy in extracted data

Use validation patterns/lists to flag discrepancies in extracted data and prevent incorrect data from going through.

When a date/number format pattern is explicitly specified, the date/number is auto corrected.

See the following examples:

Table 5: Example of date format pattern

Incorrect OCR Data	Pattern	Auto-Correction
15 10-2015	dd-mm-yyyy	15-10-2015

Table 6: Example of number format pattern

Incorrect OCR Data	Pattern	Auto-Correction
123 4567	9999999	1234567

Map a table

IQ Bot uses column names as reference points when extracting values from tables. As part of training a learning instance in the Designer, you must map the column names and configure the table settings.

Create a learning instance and map all the form fields in the Designer. [Map a field](#)

1. Skipping the **Table settings** section, click the first table column in the **Table fields** section.
2. Click the name of the column from where you want to extract data in the image display panel.

There are two ways to map the column values:

- **Option 1:** For a basic table that is contained within one page, map the column name to the **Column value** field.
- **Option 2:** If the table spans multiple pages, we recommend mapping the **Column value** field to an entry in that column that has the greatest height and width among the entries in that column.

Depending on which mapping option you choose, IQ Bot autopopulates the **Column value** field in the field details panel with either the name of the selected column or the value of the selected table entry. In addition, the selected SIR in the document is highlighted with yellow color for easy identification.

3. Optional: Drag the corners of the green-bounded box to resize the mapping area.

Alternatively, draw a new mapping area by holding and dragging the cursor.

When you resize any value region or create your own value region using select, its position is fixed relative to the field label. The value for that field is always searched in that relative region.

Reset a fixed-field region defined by the user in the autodetected mode by clicking the close button at the top-right corner of the field.

Tip: For additional information, see [How to map tables in IQ Bot \(A-People login required\)](#)

4. Expand the **Field options** section and select **Required** or **Optional**. Use the optional value if the column value is not consistently available in the training documents.
5. Optional: Provide validation patterns.

[Designer validation patterns](#)

Configure the **Table settings** section. Ensure that you map all the other fields in the document before populating this section.

6. Review the selected option in the **Best field for table/repeated section** field. IQ Bot autodetects the table field that best defines the height of the rows in the table. You can select a different column from the list.

Other columns are extracted in reference to this column. For example, if the **Best field for table/repeated section** has five rows, then a maximum of five rows will be extracted from the other columns.

Note: Ensure that this field does not contain multiple lines or is empty.

7. Optional: Map a field label for the **End of table indicator** field to specify where to stop extracting data from that table.

For example, an invoice might contain the subtotal, sales tax, and total in the table, but because each of these fields has only one value per document, they should not be extracted as part of the table.

Provide the name of the first field that appears where the table ends, for example, `Total` or `Grand Total`.

Provide the value for the **End of table/section indicator** field in any of the following ways:

- In the Image display panel, select an SIR to populate that text value as the **End of table/section indicator**.
- Alternatively, type a value directly into the **End of table indicator/section** field, in the middle panel.

Tip: Use the pipe symbol (|) to add field aliases, which represent alternative text that might be in an SIR. For example, `Subtotal | Subtotal Amounts` refers to Subtotal OR Subtotal Amounts.

For an example of how to map one table for extraction in a document that contains multiple tables, see [Mapping a table in a page with many tables](#).

8. **If you mapped a table value for the Column value field (option 2 in step 2):** Expand the **Advanced table options** section and select **Stop extraction at "end of table indicator"**.
9. Optional: Enter custom logic.

[Adding custom logic to improve automatic extraction in production](#)

Click **See extraction results** to check the training results for table data and remap the fields if required. [Preview extracted data](#)

Mapping a table in a page with many tables

This example guides you in using the **Extract Table Summary Rows** and **End of table indicator** fields to extract one table in a page that contains many tables.

If you have not already done so, create a learning instance and map all the form fields in the Designer.

[Map a field](#)

In this example, a page in a document contains more than one table, but the objective is to extract only one of the tables. User is in the Designer training a bot, with at least one table having duplicate or similar regions matching those of another table. **Extract Table Summary Rows** functionality does not impact data extraction irrespective of whether user specifies the **End of table indicator** value.

1. Create two tables with similar or duplicate areas. For example, one table with *claims total* and other with *record details* related to *line number*.
2. Map all table columns related to *line number*.
3. Map all value columns without table label, but related to *claims total*.
Claim totals table has duplicate or similar areas like another table related to *line number*. So the *billed amount* column is a duplicate area for both tables.
4. Map one column of *claims total* table with the *claims total* label, as at least one column label is required for data extraction for a table.
5. Click on **See extraction results** to see duplicate rows that have duplicate or similar areas on *claims total* table. For example, When single page has multiple claim totals records.
6. Click **Back to training** to return to the training page.
7. Navigate to **Claim totals table > table settings**, and check the box for **Extract Table Summary Rows** label under **Advance Table Options**.
8. Enter value for **End of table indicator** and click on **See extraction results**.
9. User can see rows in *claims total* table related to *claims total* only.

10. Click on **Export to CSV** to open the file.
11. User can see table related to *claims total* extraction, as seen in preview.
12. Next, set the learning instance, and bot to production and upload some files related to the bot.
 - If the bot does not have any validation errors, the user can see *claims total* table as per mapping in production CSV file.
 - If the bot has some validation errors, the user can see *claims total* table as per mapping in the Validator.

Add multiple tables in Designer

If the sample documents contain more than one table, you must map the columns and configure the table settings for each table.

Create a learning instance and map all the fields in the Designer. [Map a field](#)

Map the columns for the first table. [Map a table](#)

Add multiple tables in the Designer to extract their value and validate them. Move one or more table fields from one table to another to train extraction. To add tables do the following:

1. In the **Table fields** panel, click **Add Table**.
2. Select the columns to add from the **Available columns** list and click the arrow to add to the new table column list.
3. Map the column names and values as you did for the first table, then configure the **Table settings** section.

Resources

<https://fast.wistia.net/embed/iframe/czqkzc8nwn>

Click **See extraction results** to check the training results for table data and re-map the fields if needed. [Preview extracted data](#)

Define one or more linked fields in a child table

In the Designer, define one or more linked fields/sections in a child table, to link parent and child tables in a flexible way.

Use the *linked fields in a child table* feature in Designer to create table links, and a hierarchy of table links among parent and child tables. This helps efficient data extraction of the linked fields besides easy linking among tables. Foreign key data extraction allows the following relationships only:

- Link single parent row to a single child row (one-to-one linking).
- Link single parent row to multiple child rows (one-to-many linking).

Note: IQ Bot does not support linking of check boxes.

Use the feature for documents with a list of names or IDs with specific information on each. For example, documents from an electric company with a list of customers and their billing/usage information. Or a document with a list of student names displaying their test scores. Create multiple tables and link the common fields thus allowing efficient and accurate data extraction. IQ Bot supports linking of up to 50

columns and unlimited rows. However, data extraction from rows spanning across multiple pages is not supported.

- **Single parent-child table field/section linking:**

In the **Table/Repeated Section** of the Designer, choose one or more fields/sections from a parent table to link to a child table.

1. Click **Table Settings** in the child table and click on **Link Table Fields** and select the parent table from the drop-down list of table names. This displays the available column options in the parent table you can choose to link to.
2. Select the columns you want linked and click the downward arrow to link the columns to the child table.
3. The linked columns display under **child table > Table Settings > Linked to (table name)**.
4. When previewing the extracted data (click **See extraction results**), the linked fields from the parent table show up in the extreme left columns of the child table.

- **Multiple hierarchical table field/section linking:**

When linking table 1, 2, and 3 in a hierarchy, link in a way so that table 1 is the parent of table 2, and table 2 is parent of table 3. All three tables would be linked. Child table 3 would display linked fields from table 2 and 1. IQ Bot supports hierarchy linking up to six tables at a time.

Note: For table 3, you can only choose fields from table 2 that are not from table 1.

When previewing the extracted data for child table 3 (click **See extraction results**), the extreme left columns show linked fields from table 1. The next columns show linked fields from table 2.



Attention: For successful linking, the child table must be at the same or lower level than the parent.

Extract data from check boxes or check box groups

Train a bot to extract data from a single check box or a group of check boxes.

A check box is a user interface object that allows you to make a binary choice - select or leave unselected. IQ Bot supports extracting data from check boxes or radio buttons marked with a tick, cross, or dot. In addition to square check boxes and round radio buttons, IQ Bot supports triangle and rhombus outlines.

When IQ Bot processes documents with a check box, it extracts either a **Yes** (check box selected) or **No** (check box not selected) value.

You can also combine multiple check boxes into a single group, for example a payment methods group that contains check boxes for cash, credit card, and check. When IQ Bot processes documents with a check box group, it includes the group name in the extraction results.

Recurring check boxes or groups

By default, IQ Bot extracts check box values as a form field. However, if a check box or group appears on a recurring basis in the uploaded documents, you manually select the **Column** option so that IQ Bot extracts the values as table fields. This enables IQ Bot to extract values from the subsequent occurrences. Otherwise, IQ Bot will only extract the check box value the first time it appears.

1. Click the field you want to map from the left panel.

2. In the center panel, in the **Data type** drop-down field, select value as **check box** or **checkbox group**.
 - **To extract data from single check box or check box groups**, click the **Field label** field and then click the corresponding value in the document in the right pane.
 - **Extract data from recurring check box or check box groups**, click the **Column name** field and then click the corresponding value in the document in the right pane.
3. To extract the check box value, draw an outline around the check box excluding the value.
 - **For a single check box**, use the **Draw** tool to draw over the check box or select the auto-mapped check box segment.
 - **For a check box group**, use the **Draw** tool to draw over the region covering all the check boxes in that group.
4. **For single check boxes or check box groups:** Verify the extracted data either in the **Field value** field in the Designer or click **See Extraction Results** to see the extracted data.
For recurring check boxes or check box groups: You can only view the extracted data by clicking **See Extraction Results**; the extracted data is not shown in the Designer.
5. Optional: To add an individual check box to a check box group, select the desired value from the **Checkbox group** drop-down menu.
6. When you are done configuring the check boxes, click **Save and close** or **Save and go to next group**.

<https://fast.wistia.net/embed/iframe/5twla2e5jm>

Preview extracted data

Click **See Extraction Results** to review the extraction accuracy of the bot. This is the only way to see extraction results for table data, since the Designer does not show extracted table data during training. Alternatively, click **Export to CSV** to review the data in a CSV file.

The extraction result window displays the following information:

- Successfully mapped fields and the extracted values.
- Table headers and the values for each row.
- Extraction errors, which are highlighted within a red box. Hover on the error to learn more, such as if there was a validation error or lack of OCR confidence.

Note: The time required to display the extraction results can vary based on the complexity of the Python logic that you have created.

Important: A training document can pass in spite of an error flagged by the validation pattern. Sometimes we want a validation pattern to flag an error, so it would not pass specific documents at a later stage in production; instead enter them in the manual validation queue.

Close the window to return to the Designer.



Attention: If you upload 30 documents and all documents are classified into one group, you can see only one document for each unique layout.

Export data to a CSV file

You can export the extracted data to a CSV file for ease of review. When you click **Export to CSV**, the current document is downloaded to your device. To download other documents you must navigate to them using the < and > buttons.

The data in the downloaded CSV file is displayed exactly how it will appear when IQ Bot downloads data from a successfully processed document from a learning instance in production mode.

Review the learning instance details

Review various details of a learning instance such as associated groups, environment status, staging and productions results, total number of tested documents, modified date and so on.

On the **My learning instances** page, select a learning instance and use the following tabs to review the details:

- **Document Groups**- Contains a list of the document classification groups for the learning instance.
When you create a learning instance and upload documents to train, documents are automatically categorized in the same document group based on their content and classified accordingly. These are termed as classification groups. A bot is more likely to succeed extracting text across documents in a group with similar content.
- **Summary**- Contains various details about the learning instance such as Staging and Production results, current environment that the selected learning instance is in, total number of associated groups and bots, and so on.

Note: The system does not automatically refresh (auto-refresh) the **My learning instances** unless the user loads a screen or clicks the **Refresh** button, thereby manually refreshing data on a page. This feature helps reduce the response time for loading new data or performing any action in IQ Bot.

Related concepts

[Review the dashboard](#)

The dashboard summarizes the performance report and provides document processing information in a graphic format.

Delete mapping in the Designer

Delete mapping of field labels and field values, selecting the **X** delete symbol next to the mapped label or value.

The following use cases explain the delete field labels and value mapping options in the Designer.

Delete a field label and its mapped value:

Select a field label in the middle panel and click the **X** delete symbol of the bound box in the document view to delete both, label and value mapping . The label and the value from the middle panel gets deleted as well. The mapping check mark in the left and middle panels turns from green to gray indicating incomplete mapping.

Delete field value:

Select the field value and click the **X** delete symbol of the mapped box in the document view, to delete the mapped value. The value from the middle panel gets deleted as well. The check mark in the left and

Delete auto mapped value fields:

middle panels turns from green to gray indicating incomplete mapping.

The **X** delete symbol of the mapped box in document view is not visible till user resizes or manually maps it.

For a form field, when a user deletes a resized or manually mapped box around a the field value, IQ Bot repopulates the original auto mapped value.

For a table/section field, that same behavior does not apply, as a user has the option to map a table/section field name but not a field value, and vice versa.

Delete a field label/value with or without auto mapped value:

Select a field label/value with or without auto mapped value. The field label bound box displays in the document with an **X** delete symbol allowing users to delete the label.

Delete field label mapping with validation pattern:

In spite of deleting a field label, the validation pattern that was assigned to the field remains in place.

Delete option ('X') when bounded box reaches space limit:

If the label/field value bounded box in the document view covers a bigger area, extending to the edge of or beyond the document view, the 'X' delete symbol appears in the nearest corner of the box.

Note: The field value box in the middle panel is disabled and users cannot enter text manually.

Designer validation patterns

IQ Bot Designer allows you to validate a field and table column against a set of predefined parameters so that you can be warned if any mismatch is found during data digitization process.

Validate a field or table

Validate a field or table column against the following predefined parameters of validation options:

- Start With / End With
- Pattern
- Lists
- Formulas

IQ Bot classifies documents into groups based on similar content, structure, and layout, which is easily identifiable. The sample documents for training are chosen based on these criteria as well. When you launch the Designer to train your learning instance, IQ Bot loads and displays a sample document from each classified group in the document pane.

Tip: In the Designer set the validation parameters by defining any field and or table column during document training.

<https://fast.wistia.net/embed/iframe/2kp2mo8dpq>

Starts With and Ends With

While all validations can be set at the time of Design definition, you can set **Starts with/Ends with** and **Pattern** validations during training.

To validate whether data in a field starts or ends with a certain value, use the **Starts With** and **Ends With** validation option fields. While defining the design of a field or table column, you can specify whether the data is part of the selected field.

- Start with a certain value using a Starts With field
- End with a certain value using an Ends with field

If the Start With value is "IN" and extracted value is "1N7646464", then validation fails. While if End With value is 2017 and the extracted date value is 10-Aug-2017, the validation passes.

Pattern

A pattern helps define an acceptable format for data.

Validate data in the field or table column against a specific pattern. While defining the field or column in the Design view, specify a pattern of the data in the selected field.

Specify a pattern for date, number, or text fields based on the different available patterns. Reference the tables below for common examples:

Text

Field	Pattern	Notes	Description
Email	<code>^([a-z0-9_\.-]+)@([\da-z_\.-]+\.[a-z\.\.]{2,6})\$</code>	This regular expression validates emails like john@ado.com.	The Email field supports regular expressions.
Phone Number	<code>^(\\(\\+?[0-9]*\\)?[0-9_\\-\\(\\)]*\$</code>	This regular expression validates phone numbers like (+64) 38 3235393.	The Phone Number field supports regular expressions.
Website	<code>^([a-zA-Z0-9]+(\\.[a-zA-Z0-9]+).*)\$</code>	This regular expression validates websites like www.domain.com.	The Website field supports regular expressions.
Number string	<code>^[0-9]{1,45}\$</code>	This regular expression validates a string with numbers 0 - 9 and limit length to 45.	The Number string field supports regular expressions.
Alpha-numeric	<code>^[A-Za-z0-9_@./#&;+-]*\$</code>	This regular expression validates a string containing alphanumeric values like INV-001.	The Alpha-numeric field supports regular expressions.

Number

Field	Pattern	Notes	Description
Number string	<code>^[0-9]{1,45}\$</code>	This regular expression validates a string with numbers 0 - 9 and limit length to 45.	The Number string field supports regular expressions.

Auto Correction for date and number fields

This is one of the built-in features of IQ Bot for date and number format types. It performs automatic validation and correction based on the defined pattern , even when the date/number in the scanned document is incorrect.

Note: Auto correction is only supported for special patterns.

The following table illustrates the auto-correction of an incorrect date and numbers by IQ Bot.

	Incorrect OCR value	Pattern	Auto-Correction	Description
DATE	12 <i>F3B</i> 2 0 1 5	dd mmm yyyy	12 <i>FEB</i> 2015	In the first example, IQ Bot auto corrects incorrect OCR " F3B " to " FEB ".
	15 10-2015	dd-mm-yyyy	15-10-2015	In the second example, IQ Bot auto corrects "15 10-2015" to "15-10-2015".
NUMBER	123 4567	9999999	1234567	In the first example, the extra space between "3" and "4" is deleted after validation against the pattern.
	12.34,S67.12	99,99,999.00	1234567.12	In the second example, the alphabet "S" is corrected as "5".

Note: English language numeric value with at least one digit to the left and two consecutive digits to the right (for example, 1.23) gets auto corrected if there is a space found between the decimal and the digits. For example, values 1 . 23 or 1. 23 or 1 .23 get auto corrected to 1.23.

To use this feature, add Pattern (in validation options) to the selected date and number format fields.

Special number patterns

A special pattern consists of a Prefix, a Number Pattern, and a Suffix. Use for each is explained as follows:

- **Prefix:** Any symbol or a text string that is appended before the Number Pattern.
- **Suffix:** Any symbol or a text string that is appended after the Number Pattern.
- **Number Pattern:** Number pattern has two parts:

- **Integer-part:**

They are represented by nines (9s).

The 9s in the integer part represents integer pattern and separators such as commas, spaces, and so on.

- **Fractional part**

They are represented by zeros.

If you need two fractional number, then it will be represented by two zeros.

Specifying fractional part is optional.

Format of numbers defined for validating numeric data.

IQ Bot supports prefixes and suffixes to make processing and validation of data easier. Specifying a suffix and prefix in the pattern and in the numeric fields is optional. Even if you do not specify the suffix or prefix, IQ Bot auto corrects and includes the required currency symbols and units of measure for the numeric fields as prefix or suffix. If you specify the currency symbols and units of measurements in the pattern and in the numeric data, IQ Bot deletes the currency symbol and unit of measure from the data.

Note: IQ Bot automatically recognizes these currency symbols: \$, ¥, £, ₹, €, Rs, USD, EUR, CAD, AUD, GBP, and INR. We recommend specifying valid currency symbols in the data.

IQ Bot supports prefixes and suffixes to make processing and validation of data easier. Specifying a suffix and prefix in the pattern and in the numeric fields is optional. Even if you do not specify the suffix or prefix, IQ Bot auto corrects and includes the required currency symbols and units of measure for the numeric fields as prefix or suffix. If you specify the currency symbols and units of measurements in the pattern and in the numeric data, IQ Bot deletes the currency symbol and unit of measure from the data.

Note: IQ Bot automatically recognizes these currency symbols: \$, ¥, £, ₹, €, Rs, USD, EUR, CAD, AUD, GBP, and INR. We recommend specifying valid currency symbols in the data.

Examples of special number patterns

Pattern	Example
Supported patterns	Supported format for numeric patterns: <ul style="list-style-type: none"> • Decimal (India) • Decimal (US, UK, Australia and others) • Number (India) • Number (US, UK, Australia and others) • Normal Decimal • Normal Number

Pattern	Example
9,999,999.00	2,597.23
9.999.999,00	7.562.597,23
9 999 999.00	2 597.23
9 999 999,00	7 562 597,23
9999999,00	2597,23
9999999.00	7562597.23
99,99,999.00	75,26,569.56
\$ 9.999.999,00	\$ 7.562.597,23
\$9 999 999.00	\$7 562 597.23
9 999 999,00 \$	2 597,23 \$
€ 9999999,00	€ 7562597,23
€9999999.00	€7562597.23
99,99,999.00 €	75,62,597.23€
EUR 9,999,999.00	EUR 7,562,597.23
EUR9 999 999.00	EUR7 562 597.23
9999999,00 EUR	62597,23 EUR
9.999.999.00	62.986.51
9, 999, 999. 00	232, 510. 68

Special date patterns

Supported date separators include /(forward slash), -(dash), space, .(dot), and ,(comma).

- **d** - Numeric day of the month, from 1 through 31 (eg. 5, 15 etc.)
- **dd** - Numeric day of the month, from 01 through 31 (eg. 05, 15 etc.)
- **m** - Numeric month (eg. 1 for January)
- **mm** - Numeric month (eg. 01 for January)
- **mmm** - First 3 letters of the month (eg. NOV for November)
- **mmmm** - Full name of the month (eg. June)

Examples of special date patterns

Pattern	Example
mm-dd-yy	01-31-18
mmm-dd-yyyy	Jan-31-2018
mmmm dd, yyyy	January 31, 2018
Mmmm d, yyyy	January 9, 2018

Pattern	Example
D M YY	9 5 15
D MM YY	9 11 15
D MMM YY	7 MAR 15
D MMMM YY	7 MARCH 15
M DD YYYY	5 05 2018
D/MM/YY	5/05/18
M/D/YY	9/5/15
DD / M / YYYY	05 / 9 / 2018
MMM / DD / YY	MAR / 05 / 18
D-MMMM-YY	09-APRIL-18
M-D-YY	5-5-18
MM-D-YY	11-5-18
MMM-DD-YYYY	NOV-13-2018
DD - M - YYYY	13 - 5 - 2019
MMMM - DD - YY	OCTOBER - 05 - 18
D.MMMM.YYYY	05.APRIL.2018
MMMM.DD.YYYY	APRIL.05.2018
D . M . YY	5 . 5 . 18
D . MM . YY	5 . 05 . 18
DD . MMM . YY	05 . JUL . 18
M . DD . YYYY	5 . 11 . 2018
MMMM . DD . YY	MAY . 13 . 13
YYYY-MM-DD	2018-01-27
YYYY/MM/DD	2017/07/27

Lists

While defining a field or table column in the Design view, you can specify a list as part of validation option for a selected field or table column. The extracted value of the field is validated against this predefined list during Preview and Test Run.

You can only specify list validation when format of field or table column is "Text". If the lookup returns multiple values for a word, the value is not auto corrected and the validation fails.

To specify list validation, do the following:

1. Select the validation type as **List** from the **Validate** drop-down menu.

2. Type a predefined list and click **Define** to save.
Each value in the list should be in a separate line.

If the extracted value does not match any value in the predefined list, the field is considered to have failed validation.

Formulas

Specify a formula as part of validation options for a selected field or table column. Use basic arithmetic, comparative, logical, and functional operations.

Tip: We recommended using functional operators instead of mathematical operators when validating fields and tables for better accuracy.

When formulating an expression remember the following:

- All function names must be in capital letters.
- All formulas must result in either a true or false validation.
- Field and column names are case sensitive when used within formulas. If field is defined as *Qty* in design, using *qty* or *QTY* in formula results in an invalid formula.
- For variable declaration or manipulation, ensure not to use certain keywords that are reserved for formulating an expression, including SUM, SUB, DIV, MUL, COLSUM, IF.

Mathematical Operators

Operations	Description	Syntax
+	Addition	Field/Column_Name1 + Field/Column_Name2
-	Subtraction	Field/Column_Name1 - Field/Column_Name2
*	Multiplication	Field/Column_Name1 * Field/Column_Name2
/	Division	Field/Column_Name1 / Field/Column_Name2

Comparative Operators

Operations	Description	Syntax
==	Equal To	[Current Field/Column Name] == [expression comprised of one or more field/column name or fixed numeric values] For example, AMOUNT == MUL(QUANTITY, UNIT_PRICE)

Operations	Description	Syntax
>=	Greater than or Equal To	[Current Field/Column Name] >= [expression comprised of one or more field/column name or fixed numeric values] For example, TOTAL_BILL_AMOUNT >= AMOUNT_PAID
<=	Less than or Equal To	[Current Field/Column Name] <= [expression comprised of one or more field/column name or fixed numeric values] For example, AMOUNT_PAID <= TOTAL_BILL_AMOUNT
>	Greater Than	[Current Field/Column Name] > [expression comprised of one or more field/column name or fixed numeric values] For example, BILL_AMOUNT > 0
<	Less Than	[Current Field/Column Name] > [expression comprised of one or more field/column name or fixed numeric values] For example, DISCOUNT_PERCENTAGE < 100
!=	Not Equal To	[Current Field/Column Name] ! = [expression comprised of one or more field/column name or fixed numeric values] For example, DEBIT_AMOUNT != 0

Logical Operators

Operations	Description	Syntax
&&	And: Field/Column is valid if all conditions are true	<p><Current Field/Column Name> <operator 1> <expression 1> && <Current Field/Column Name> <operator 2> <expression 2></p> <p>For example, DISCOUNT_PERCENTAGE >= 0 && DISCOUNT_PERCENTAGE <=100</p>
	Or: Field/Column is valid if any one of the given conditions is true	<p><Current Field/Column Name> <operator 1> <expression 1> <Current Field/Column Name> <operator 2> <expression 2></p> <p>For example, DISCOUNT_PERCENTAGE >= 0 DISCOUNT_PERCENTAGE == 'Net'</p>
!	Not: Converts a true expression to false and also the other way round	<p>!<expression></p> <p>For example, !(AGE < 18) ==> valid when AGE is not less than 18</p>

Functional Operators

Operations	Description	Syntax
SUM	Summation: gives result of addition of one or more field/column/fixed-number values	<p>SUM(n1,n2,...,nN)</p> <p>For example, SUM(SUB_TOTAL, SERVICE_TAX, EDUCATION_CESS) ==> equivalent to SUB_TOTAL plus SERVICE_TAX plus EDUCATION_CESS</p>
SUB	Subtraction: gives result of subtraction of one or more field/column/fixed-number values from the first specified value	<p>SUB(n1,n2,...,nN)</p> <p>For example, SUB(SUB_TOTAL, TOTAL_DISCOUNT, ADJUSTMENTS) ==> equivalent to SUB_TOTAL minus TOTAL_DISCOUNT minus ADJUSTMENTS</p>

Operations	Description	Syntax
MUL	Multiplication: gives result of multiplication of one or more field/column/fixed-number values	MUL(n1,n2,...,nN) For example, MUL(QTY_IN_BOX, UNIT_PRICE, SHIPPED_BOXES) ==> equivalent to QTY_IN_BOX multiply-with UNIT_PRICE multiply-with SHIPPED_BOXES
DIV	Division: gives result of division of one or more field/column/fixed-number values from the first specified value	DIV(n1,n2,...,nN) For example, DIV(AMOUNT, SHIPPED_BOXES, UNIT_PRICE) ==> equivalent to AMOUNT divide-by SHIPPED_BOXES divide-by UNIT_PRICE
COLSUM	Sum of a given Column in a table: gives result after evaluating given expression for each row of specified table and adding them all together	COLSUM("<table-name>", "<expression to evaluate for each row of specified table- name>") For example, FINAL_TOTAL == COLSUM("LINE_ITEMS", "MUL(QTY, UNIT_PRICE)") Say there are 3 rows for table LINE_ITEMS, then FINAL_TOTAL should be equal to MUL(QTY1, UNIT_PRICE1) + MUL(QTY2, UNIT_PRICE2) + MUL(QTY3, UNIT_PRICE3) where, QTY1 is QTY value in row 1, similarly UNIT_PRICE1 is UNIT_PRICE value in row 2, and so on for other rows as well.

Adding custom logic to improve automatic extraction in production

Enter the logic in the IQ Bot Designer to improve text extraction and validation, and to reduce the number of documents entering the Validator that requires RPA post processing.

Overview

For Automation 360 IQ Bot Cloud, there is an identified list of Python libraries and packages that are safe to use for the Custom Logic feature. Use only these packages to ensure security for your cloud infrastructure, file systems, databases, and network resources: [List of Pandas Libraries which are supported and not supported on Automation 360 IQ Bot \(A-People login required\)](#)

Keep in mind the following:

- Custom logic executes in a sequential order across all tables and fields.
- Applying custom logic might increase the extraction time per document.
- Automation 360 IQ Bot validation rules apply over the extracted values processed by the custom script.
- Custom script only works on the extracted data and does not influence the OCR extraction quality.
- Always test your Python script before processing documents in a learning instance in production

The custom logic feature helps clean up extracted values ahead of the validation step but does not replace all the post-processing currently done using the TaskBot. In addition to adding inline scripts, users can use the Python scripts in a central location, import those as modules, and call functions to reduce the amount of Python code at the field or table level.

Restriction: If the number of characters in the Python code along with other information exceeds 32000, and when this code is sent to the back-end as a Windows runtime argument for the process, the execution fails, and does not display any error message.

Resources

<https://fast.wistia.net/embed/iframe/czgI6jtvvw> <https://fast.wistia.net/embed/iframe/r3r3pm1j86>

To learn more, search for *Using Custom Logic in IQ Bot* course in *Automation Anywhere University: RPA Training and Certification (A-People login required)*.

Next step

Using scripts, in the IQ Bot Designer add the **Form fields** and **Table fields**.

Form fields

Add scripts in Designer for form fields.

The *List validation via external file* can be implemented as a part of the field custom logic using python scripts directly in the Designer.

1. In the IQ Bot Designer, left-hand panel, highlight a form field whose extraction/validation you aim to improve further.
2. In the middle panel, scroll down to **Field options** > **Logic**.
3. In that **Logic** section, toggle between **fullscreen** and **smallscreen** for ease of use.
4. Add code to modify IQ Bot's extracted text value. See example below:

```
# variable that stores the value: field_value

# import the Python regular expression library, re
import re

# call the regular expression library's method, findall, to extract the
date value only
field_value = re.findall(r'\d{2}-\d{2}-\d{4}', field_value)[0]
```

5. Select **Test Run** to test your script and see the results before vs. after.

```
value_before: 2018/11/09 B210
value_after: 2018/11/09
```

Table fields

Add scripts in Designer for table fields.

1. In IQ Bot Designer, left-hand panel, highlight **Table/section settings** for the table whose extraction/validation you aim to improve further.
2. In the middle panel, scroll down to **Logic**.
3. In the **Logic** section, toggle between **fullscreen** and **smallscreen** for ease of use.
4. Add code to modify the extracted table values, which are stored as a Python dictionary in a user variable called *table_values*. See example below.

Each row has a Guid (Global unique identifier), which allows IQ Bot to auto track rows that are added and deleted. If you add a row, you need not enter a Guid. IQ Bot will handle this automatically.

```
# variable that stores the value: table_values

# convert from dictionary to dataframe
df = pd.DataFrame.from_dict(table_values)

# print dataframe before update
print(df)

# Item_Description: drop rows with a missing value
df = df[(df["Item_Description"] != "")]

# Quantity: extract first part of the string, the numeric part only
df['Quantity'] = df['Quantity'].str.split(' ', 1).str[0].str.strip()

# print dataframe after update
print(df)

# convert back from dataframe to dict to override what IQ Bot stores
table_values = df.to_dict()
```

5. Select **Test Run** to test your script and see the results before vs. after.

```

      Item_Description                                Guid
product_id      Quantity Item_Total
0      wafer, NO172  43ea78f4-7b9b-413a-83ce-89d671478d6c  2
COMS5A-18090220      4.00 PCS      5,840.00
1  Visual Inspection +  cc774f5f-2507-4a15-8e45-7b2abf84fabe
      1.00 EA      65.00
2
Total - 4.00PCS GR:      5,905.00      5% VAT :
3
Total -      KGD:      0.00
      2dc642a7-8e6e-4bc6-9672-85afff8c21db

      Item_Description                                Guid
product_id      Quantity Item_Total
0      wafer, NO172  43ea78f4-7b9b-413a-83ce-89d671478d6c  2
COMS5A-18090220      4.00      5,840.00
1  Visual Inspection +  cc774f5f-2507-4a15-8e45-7b2abf84fabe
      1.00      65.00
```

6. If you select **See extraction results** or save the bot, your script is saved.

Use cases and examples

These are some use cases the Designer script feature supports.

For examples of user scripts and use cases, see: [IQ Bot custom logic use cases and examples](#)

Following are some use cases:

- Query an extracted value vs. a database in an ERP system to validate values.
- Extract "0123456" from "PO 0123456".
- Remove table rows that contain "Page x of y".
- Extract the currency from one table field (for example: Item Total) and save in an empty table field.
- Extract the product number from a table field (for example: Item Description).
- Extract the zip code from an address.
- Query a REST service (for example: add NLP, retrieve data from an outside system, and so on).
- Return a Boolean yes/no value on whether handwriting exists for a field.

Pre-installed Python packages

To facilitate ease of use and consistent behavior across servers, IQ Bot auto installs Python v3.11.0 and some popular Python packages mentioned as follows.

Table 7: Pre-installed Python packages

Main package	Version	URL
difflib	In-built Python with installer	https://docs.python.org/3/library/text.html
io	In-built Python with installer	https://docs.python.org/3/library/io.html
re	In-built Python with installer	https://docs.python.org/3/library/text.html
sqlite3	In-built Python with installer	https://docs.python.org/2/library/sqlite3.html
string	In-built Python with installer	https://docs.python.org/3/library/text.html
stringprep	In-built Python with installer	https://docs.python.org/3/library/text.html
sys	In-built Python with installer	https://docs.python.org/3/library/sys.html
textwrap	In-built Python with installer	https://docs.python.org/3/library/text.html
unicodedata	In-built Python with installer	https://docs.python.org/3/library/text.html
DateTime	4.3	https://pypi.org/project/DateTime/
pandas	0.24.2	https://pypi.org/project/pandas/
inflection	0.3.1	https://github.com/jpvanhal/inflection
dateutils	0.6.6	https://pypi.org/project/dateutils/

Main package	Version	URL
tabulate	0.8.3	https://pypi.org/project/tabulate/
numby	1.16.4	https://pypi.org/project/numpy/
json	2.0.9	https://docs.python.org/3/library/json.html
requests	2.22.0	https://github.com/kennethreitz/requests
psycpg2	2.8.3	https://pypi.org/project/psycpg2/
pymongo	3.8.0	https://pypi.org/project/pymongo/
pyodbc	4.0.26	https://github.com/mkleehammer/pyodbc
opencv-python	4.1.0.25	https://pypi.org/project/opencv-python/
Pillow	6.0.0	https://github.com/python-pillow/Pillow
cx_Oracle	7.1.3	https://github.com/oracle/python-cx_Oracle
<hr/> Note: As of Build 16667, this module is replaced by oracledb. See Upgrading from cx_Oracle 8.3 to python-oracledb <hr/>		
oracledb	1.2.1	https://github.com/oracle/python-oracledb
Python Arabic Reshaper	2.0.15	https://github.com/mpcabd/python-arabic-reshaper

Additional Python packages

To allow further empowerment, you can add more Python libraries for use in IQ Bot.

1. Open the `Command Prompt`.
2. In the `Command Prompt`, change directory to IQ Bot's Python dictionary. For example: `C:\Python354-x86-IQBot`.
3. Install your Python package there. For example: `pip install PyArabic`.
4. In **IQ Bot Designer** > **Logic**, you can import and use that Python package.
5. If step 4 does not work, then stop/uninstall and then install/start services.

Extract data using magnetic ink character recognition

Use the magnetic ink character recognition (MICR) OCR feature with ABBYY FineReader Engine version 12.2 support to extract MICR data from financial checks.

Note: Documents in Non-Latin based languages cannot be processed if MICR is enabled on ABBYY FineReader Engine OCR version 12.3 and 12.4.

- Ensure that ABBYY FineReader Engine is installed in the plug-ins folder: \OCR Plugins\ABBYY SDK \12\ . . .
- From the C:\Program Files (x86)\Automation Anywhere IQ Bot (version)\Configurations folder, open the Settings.txt file, change *OCREngine=Tesseract4* to *OCREngine=Abbyy*, and save the file.

Note: A system restart is not required.

The MICR feature is supported with ABBYY FineReader Engine versions 12.2 .

1. Set ABBYY FineReader Engine in your `settings.txt` file as the primary OCR engine.
2. Navigate to the IQ Bot\Configurations\AbbyyImagePreProcessingSettings.json file.
3. Update these parameters:
 - `TextTypes = 129`
 - `DetectTextTypesIndependently =true`

The MICR feature is activated in the system.

- Create a learning instance and add form fields to extract MICR data from financial checks such as **MICR** and **Pay to** fields.
- Scan and upload a check to IQ Bot for training. In production, upload the financial checks for accurate MICR data extraction.
- In the Designer, map the MICR data in the financial check for extraction.
- In production, upload the financial checks for accurate MICR data extraction.

Set learning instance to Production

After you have trained a learning instance on Staging to extract data from documents with high accuracy, you can move the learning instance to Production. This enables you to deploy the learning instance on production documents for real time data extraction.

Use the **Set instance to production** button to move a learning instance to Production. When you move a learning instance to the Production environment, a confirmation message appears. To confirm, click **Yes, send to production**. Learning instances in the Production environment are identified by the **Production** label next to their name.

Tip: You can also use the **My Learning Instances** page to move a learning instance to Production.

Note: During the production process, you must not move the learning instances or bots from Staging to Production or vice-versa.

Manage learning instances

A learning instance is an IQ Bot structure that describes the data in a single document type, for example an invoice. It contains information such as the language used in the document and the fields to extract.

A learning instance can be either in **staging** or **production** mode. These modes determine whether the learning instance is a draft or live version.

Staging

In the staging mode, you can create and edit learning instances, upload sample documents,

and train bots to extract data from the sample documents you uploaded. You can test and improve the accuracy of a learning instance and its bots before deploying it to production mode.

Note: Because the data generated by learning instances in the staging mode is based on sample documents, it is kept separate from data pertaining to learning instances in production mode. For example, sample documents are not counted against your organization's purchased pages. For more information, see [Review the dashboard](#).

Production

In the production mode, a learning instance can automatically process real business documents, extract data, and send documents requiring manual validation to the validation queue.

To find out which mode a learning instance is in, navigate to the **LEARNING INSTANCES** tab, where the **My learning instances** page displays the learning instances in the environment. Each learning instance has a toggle in the **Actions** column, which indicates whether it is in staging (toggle to the left and is colored gray) or production (toggle to the right and colored orange).

Instance name	ID	Provider	# of IQ Bots	# of Files	Training %	Actions
IQBotDemo		Tesseract4 OCR	1	1	0%	
IQBotDemoDLCA		MicrosoftAzureAPI OCR	1	2	100%	

Based on the mode that a learning instance is in, different user types contribute to IQ Bot. For example, in the staging mode, the Data engineer creates learning instances and the Bot builder builds supporting RPA bots, and in the production mode, the Validator manually corrects the fields in the documents that IQ Bot could not process. To learn more about how each user contributes to IQ Bot, see [IQ Bot process overview](#).

Note: The following are the file size restrictions in each stage:

- In staging, you can upload a maximum of 150 documents of 10 MB file size per learning instance.
- In production, you can upload a maximum of 50 MB file size per document. However, the maximum number of documents allowed per learning instance depends on the license.
- There are no limitations on the number of pages per document in a pdfbox OCR.
- You can upload 60 pages per document in an image-based OCR.
- With the Tesseract4 OCR, there is a known limitation that restricts the number of pages per document to fewer than 60 pages.

The learning instance lifecycle

The staging and production modes are independent from the IQ Bot environment when it comes to the traditional DevOps workflow of separate development, testing, and production environments. A learning instance can be in either mode in any of the environments in the development life cycle.

Note: When you transfer a learning instance, it remains in the mode in which it was exported. For example, if you export a learning instance in staging mode from the development environment and import

it to the testing environment, the learning instance will still be in staging mode and it will not perform document processing automatically.

The following image shows the typical lifecycle of a learning instance:

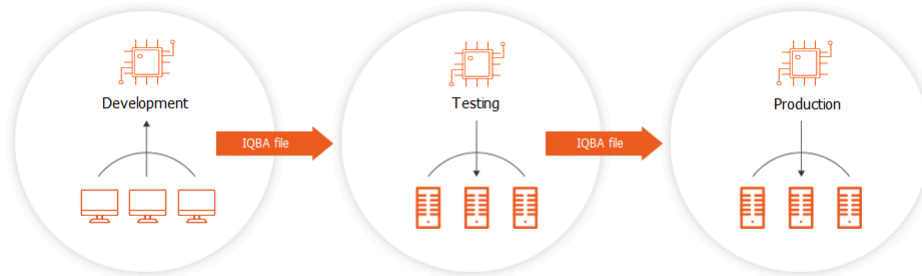

You can transfer learning instances across environments by using the Migration Utility. This helps you to avoid having to recreate similar learning instances and better manage the lifecycle of the associated bots. To learn more, see [Migrate learning instances](#).

Rotate the external key

The Control Room supports using CyberArk to store keys for encrypting and decrypting IQ Bot data. A user with the **AAE_IQ Bot Admin** role can change the object name in IQ Bot to start the key rotation process.

- The IQ Bot must have been connected with CyberArk during installation. See [Installing IQ Bot in Custom mode](#).
- Update the password in the CyberArk vault to generate the new key. Note the new key name because you will provide it in IQ Bot.

1. Navigate to **Administration > Key rotation**.

Most of the fields in the **Key rotation** page are auto-filled with the connection details you provided during installation.

2. In the **Object name** field, provide the new key name from CyberArk.

3. Click **Rotate key**.

The IQ Bot retrieves the new key from the CyberArk vault and encrypts data with this new key. When the encryption process completes, a success message appears.

If the encryption process is not successful, use the key rotation synchronizer to recover from the error.

Use the IQ Bot Validator

Use the Validator to manually validate documents from which IQ Bot could not extract data.

When IQ Bot processes documents in a learning instance that is in production mode and encounters one of the following scenarios, IQ Bot sends that document to the Validation queue.

- Data is not readable, such as blurry text or dark background.
- Data is missing from a required field.
- Document failed an automated processing rule.
- Fields did not meet the set optical character recognition (OCR) confidence threshold.

Note: To learn more about how field-level OCR confidence can be used to improve the quality of STP output, see [Improve output quality using OCR confidence](#).

A user with the **AAE_IQ Bot Validator** role opens the Validator window, where they correct the flagged fields.

Once all the fields in the document are corrected, IQ Bot finishes processing the document and exports the data to a .CSV file in the Learning Instance success folder.

Note: If a document required manual validation, it is excluded from the straight-through processing (STP) metric. For more information on the dashboard metrics, see [Review the dashboard](#).

As you work on a document in the Validator queue, if you leave the Validator queue or log out of IQ Bot, the lock on the document is released, allowing other users to access or validate the document.

Validator interface overview

The Validator interface opens with the first document from the validation queue. The data requiring validation distinguished with red text or outlined in red boxes.

Note: An empty page with a notification message appears in the following scenarios:

- If no files are available in the validation queue.
 - If a file does not exist in the validation queue.
 - If another user is working on the remaining file in the validation queue.
-



Validator

Search by filename

Group 13 - Invoice8.tiff - 2 document(s) remaining

Fields	<input type="checkbox"/> Hide successful fields
Invoice Date	05/07/12
Invoice Number	359
Invoice Total	275.52

Table-repeated-section-1		
Item_Description	Item_Total	Quantity
Coleman Montana 8 Tent		

1

1. Provide the values for fields IQ Bot could not extract

Click the empty text field, then select the blue-bounded box in the document that contains the data to extract. After you select a box, the data is

2. Fields awaiting validation are outlined in red

highlighted in yellow and a green outline appears, which you can resize or reposition to include all the data that you want to extract.

3. Add or delete a row

In the example above, the table fields **Item total** and **Quantity** require manual entry.

To insert or delete a row, hover over the ellipses to show the icons for adding or deleting table rows.

4. Mark document as invalid

Removes the document from the validation queue and saves a copy of the document to the Invalid folder. Click [here](#) to mark a document as invalid, then select from the following reasons:

- Fields missing
- Tables missing
- Wrong values

5. Save current document

After you have validated all the fields, click [here](#) so IQ Bot can finish processing this document.

6. Skip to next file

Skip a file without correcting the errors in the current document.

Linked tables in the Validator

Some pages in a document might contain more than one table. When there is a relationship between the tables, such as in the example page below, where a parent table contains patient information and child tables contain additional information related to that patient, these are called **linked tables**.

In the example page below, the red box outlines the parent table and each of the blue boxes outline a child table.

Patient Name: Irrfan Khan		Patient Account No: AASPL_3100	
Member ID: IQ_Bot0001		Claim ID: Cognitive_123XXX	
Date of Birth: 07 Jan 1967		Claim Status: PAID	
Provider Name: Cognitive			
Gender: <input checked="" type="radio"/> Male <input type="radio"/> Female <input type="radio"/> Other		Type of payment: <input type="checkbox"/> Cash <input type="checkbox"/> Cheque <input checked="" type="checkbox"/> Bank Account	

Line	Date of service	Rev Code	Units	Billed Amount	Allowed Amount	Discount /Penalty	Net A
1	02/02/18	0211	1	100.00	100.00	0.00	100.0
2	03/02/18	0221	5	500.00	500.00	0.00	500.0
3	03/02/18	0200	3	300.00	300.00	0.00	300.0
Claim Totals			9	900.00	900.00	0.00	900.00

Payment Mode (If Bank Account):
 Net Banking
 Debit Card
 Credit Card

Type of Card (Only for Debit or Credit card) Payment:
 Master Card
 Visa Card

◆ Paid

To successfully validate a page with linked tables, add the fields from the child tables to same **table-repeated** section as the parent table.

If shared fields between the linked tables do not match values, the Validator does not let you complete validation and save your changes. This functionality helps avoid manual validation errors that can occur when there is a mismatch of field values between the parent and child tables. The Validator shows an error message and prevents the save.

Note: In Validator, if you mark an already corrupted document as invalid then that document is lost in the IQ Bot system. Instead, you will see a placeholder image and you must refresh the page to go to the next document. This applies to single page as well as multi-page documents. When the entire multi-page document is deleted or corrupted, you will not be able to navigate between the pages. If you click the next page button, then the **Loading document** screen is displayed.

Using the Validator

Open the Validator user interface from the **LEARNING INSTANCES** tab. If a learning instance contains documents that require validation, there will be a document icon with a red exclamation mark in the Actions column. Click the document icon to launch the Validator.

Note: Only users with an assigned Validator role can view the Validation page. For more information, see [IQ Bot user personas and roles](#).

<https://fast.wistia.net/embed/iframe/htsfxuq4t2>

Review the dashboard

The dashboard summarizes the performance report and provides document processing information in a graphic format.

The report appears when you log in to the IQ Bot. The information shown consists of: document classification, straight-through processing (STP), accuracy, and human validation for information on actions for a specific learning instance so you can focus on areas that require attention.

The IQ Bot dashboard is divided into two primary areas:

- **My Totals**
- **My Learning Instances**

My Totals area

My totals is a display area of the Dashboard that provides a quick overall view of the status of all learning instances in the Production environment.

View the following information in the **My Totals** area:

- **Documents Processed:** The total number of files processed in the production environment.

Note: If a file is corrupt and cannot be opened, it is not included in this count.

- **Pages purchased:** The number of pages purchased in the current license period.

For example, if 4000 pages were purchased before Dec 31, 2020 and another 20,000 pages were purchased between January 1, 2021 and February 28, 2021, the pages purchased metric shows a count of 20,000 pages, not 24,000. This is because 4000 of the pages were purchased before the license validity period.

Note: This metric is visible only to users with the **AAE_IQ Bot Admin** role or a custom role with the **View administration** permission.

- **Pages uploaded:** The number of pages uploaded to a learning instance in the production environment in the current license period. When the license is renewed, the value reverts to zero.

This metric is different from the documents processed metric because one document can contain multiple pages. Additionally, the metric count includes pages that were uploaded but have not completed processing.

Note: In releases prior to Automation 360 v.23, this metric reflected the number of pages uploaded to learning instances in the production environment from the time of IQ Bot installation.

- **Straight-through processing (STP):** The percentage of total number of uploaded files that were successfully processed without manual intervention.
- **Accuracy:** The field accuracy, which is a percentage value of fields that have been accurately identified. This includes fields whose Optical Character Recognition (OCR) confidence levels exceed the confidence threshold that were set.

My Learning Instances area

View details of learning instances you have created that are in the Staging and Production environments.

View information for learning instances in the staging environment:

- Name of the learning instance
- The domain or type of documents. For example, invoices and receipts.
- Number of documents in the learning instance
- A graphical representation of trained documents showing the details in percentages

View information for learning instances in the production environment:

- Number of files processed
- Straight-Through Processing (STP) percentage of files that were successfully processed without manual intervention
- Field accuracy in percentages

Important: Sometimes, the number of documents in the Dashboard and in the Learning Instance summary page do not match the number of documents submitted for processing. This can occur when documents are classified into groups that are not in production. Documents in this category are not processed (by design), leading to a mismatch between the number of processed documents and the number of total documents. In such a case, if these groups are moved to production, the total numbers of documents will match.

Performance report page

The performance report page displays the details of a learning instance in the production environment.

Navigate to **My learning instances > Production** button to view the **Performance report** page showing details of all learning instances in the production environment.

Note: The **Performance report** page is not available for learning instances that are in the staging environment.

The top right corner of the performance report page displays the percentage of bots trained for the learning instance. The following is an example of how to interpret the percentage information.

Cathy has uploaded 10 documents and has created three bots for the learning instance:

- Bot1
- Bot2
- Bot3

Of these, three documents are a part of Bot1, four documents of Bot2, and three documents of Bot 3. When Cathy sets Bot1 into the production environment, the label displays 33% as the percentage of bots trained for the learning instance, which means that 3 out the 10 (33%) uploaded documents (for Bot1) have been trained.

Performance report details

In the **My learning instances** area, click any displayed information to bring up the **Performance report** page. The following sections describe the information for each displayed section of the performance report.

Instance totals and Processing results

The instance totals and processing results area shows the following information for a learning instance:

- Number of files uploaded for the learning instance – total number of files uploaded that need to be processed.
- Number of files processed for the learning instance - number of files that was processed by a bot.
- Number of files successfully processed for the learning instance – includes files that were successfully processed by a bot without human intervention.
- Number of files sent to validation for the learning instance – files flagged with one or more errors that need human intervention for review.
- Number of files validated for the learning instance – number of files that were reviewed by an individual and the results were saved.
- Number of files marked as invalid for the learning instance – number of files that were reviewed by an individual and marked as invalid.

Classification results

The **Classification** area provides a statistical display of the field representation graphically.

Accuracy results

The **Accuracy** area provides a graphical representation of the field types.

Validation

The **Validation** area provides the following information:

- A statistical representation of the corrections made to individual fields during the process of validating a document.
- A statistical representation of the average time spent to validate a group.

Custom domains in IQ Bot

A domain contains information about the language of the documents and the data fields that the system extracts from the documents. The IQ Bot environment includes seven domains; users with the **AAE_IQ Bot Admin** role can also create and import custom domains to the **Domains** tab.

If your documents contain specialized fields, you can create a custom domain with these fields to make learning instance creation quicker. Otherwise, the learning instance creator must manually define each specialized field, every time they create a new learning instance.

For example, for documents from the pharmaceutical industry, you might add fields like prescription name, dose, or delivery format to the custom domain. Likewise for financial industry documents, you might add fields for margin, call price, or limit order.

The **Domains** tab displays all available domains for use in the system and their associated languages. Besides out-of-box domains offered by IQ Bot, you can also create a custom domain and import it into IQ Bot.

Create a custom domain (A-people login required)

When creating a learning instance using a custom domain:

- The languages assigned to the domain when creating the domain is displayed and is available for selection from the **Primary language of documents** drop-down list.

- The fields that were selected when creating the custom domain are displayed in the **Fields to extract** section of the create **New instance** page.

You can import or export a domain using the **Import** or **Export** option in the **Domains** tab.

Note: Domains are created and saved with the `.dom` extension in the system.

Tip: Troubleshoot classification issue with Chinese language documents:

[Classification issue with Chinese Invoices \(A-People login required\)](#)

Import a domain

You import a domain for the following scenarios:

- Import a new domain.
- Import an existing domain from another system to your current system.

When you are ready to import a domain into your system:

1. Go to the system where you want the domain to be imported.
2. Click **Import new domain** in the **Domains** tab and select the `.dom domain` file in your local machine that you want to import.

The domain import success message is displayed in the **Domains** tab.

The imported domain appears for the selection in the **Document type** drop-down list of the create **New instance** page and is displayed in the domains list in the **Domains** page.

Export a domain

When you click the **Export** option next to a domain, it is exported to an output folder on your local drive. The exported domain is encrypted and is created with a `.dom filename` extension.

You export an existing domain from one IQ Bot system to import to another.

To export a domain from your IQ Bot system, do this: In the **Domains** list page, click the **Export** option next to the domain you want to export.

The system displays a success message for the exported domain.

The file is exported to a local output folder on your machine with a `.dom filename` extension.

Note: The domain files are encrypted for security.

Current limitations to the domain import and export actions

Important: Import or export of domains is independent of the migration action in the Migration Utility feature.

When you migrate learning instances that were created using a custom domain from one system to another, the field names and IDs must be the same in the target machine as well. Otherwise, even though the learning instances are imported, the custom domain will not be imported and the associated field

names and IDs for the custom domain will not work in the imported learning instance. If you run the imported learning instance on documents, the documents will not be classified.

Even if you import the custom domain to your new system, the field names and IDs will still not match as these are automatically generated by the system. Hence classification will fail. This is the current limitation of the Migration Utility feature using a custom domain.

Workaround: First import the .dom file to the target machine, then migrate the learning instances. Move all learning instances to the staging environment, and test them before moving the learning instance to the production environment.

Custom domain enhancements

Import custom domains in any order

When you migrate learning instances (created using a custom domain) from the staging server to the production server, migration fails unless you import the different versions of the custom domain in the same order as they were created.

As the capability to edit a custom domain to add additional fields and aliases was not available, the user had to create a new domain and add the additional fields and aliases to it. Then the user had to assign that new domain to the learning instance. So when the user wanted to use the new domain, they had to re-import the original and the new domain to the production server in the order they were created in.

Importing custom domain to IQ Bot production (A-People login required)

From release Automation 360 Build 5322, this restriction does not exist.

- You can edit and update an existing custom domain multiple times, and import them to the production server multiple times as well.
- You can import the custom domains in any order. The system successfully migrates the updated fields (form or table), and field aliases (variations of field values found in the training documents, associated with a field) to the production server.

Important: Perform all edits or updates to a custom domain in the staging server before importing it to the production server to avoid errors.

IQ Bot performs document classification based on the defined fields and aliases of the version of custom domain used when the learning instance was created.

Editing the same custom domain (with additional fields) changes the version of the custom domain. For new learning instances created using the new version of the custom domain, classification occurs on the updated fields as well. The edited fields (whether form or table fields) are displayed in the learning instance with a double asterisk next to them to help identify them.

Using IQ Bot for standard forms

Standard forms are fixed format type documents that usually contain a large number of fields with very little or no variation in the overall layout, which can include both hand-written and digital content. IQ Bot enables you to extract data from standard forms.

<https://fast.wistia.net/embed/iframe/c05s2zf3l4>

Some examples of standard forms are W-4 (Employee Withholding Certificate), income tax form, sale deed and partnership agreement. You can extract data from standard forms by customizing and building a model before setting it up in IQ Bot. A machine learning model is a file that can be trained to recognize certain types of patterns from documents. You can use a sample document with a set of data to train a model to recognize patterns.

Based on the associated role or permission defined by the Control Room administrator, you can then create a learning instance using a model for extracting data from standard forms.

Note: Users must have the Standard forms pages product license to upload documents for processing. For more information, see [Automation 360 licenses](#).

The following workflow describes the various stages and procedures for setting up data extraction from standard forms:

1. Evaluate your use case for standard forms.
[Evaluate your use case](#)
2. Review the type of standard forms extraction service that fits your requirement.
[Review extraction service](#)
3. Review the service implementation prerequisites.
[Review implementation prerequisites](#)
4. Set up and configure an extraction service.
[Set up extraction service](#)
5. Configure IQ Bot for the selected extraction service.
[Configure IQ Bot for extraction service](#)
6. Build a data extraction model.
[Build extraction model](#)
7. Log in to IQ Bot and create a learning instance.
[Create a learning instance for standard forms](#)
8. Add validation rules for standard forms learning instance.
[Define validation rules for standard forms learning instance](#)
9. Transfer the third-party extraction models
[Transfer third-party extraction service models](#)
10. Move standard forms learning instance across different IQ Bot environments.
[Transfer standard forms learning instance](#)
11. Upload documents in IQ Bot.
[Upload documents for standard forms learning instance](#)
12. Validate the processed documents for standard forms learning instance.
[Use the IQ Bot Validator](#)
13. Download the content extracted from standard forms.
[Download extracted content](#)
14. Review the performance report and document processing information.
[Review the dashboard](#)

Workflow map: Click the following schematic image to view the Standard forms workflow in an



interactive visual format:

1.

Related concepts

[IQ Bot user personas and roles](#)

Learn about the users that contribute to IQ Bot and the associated roles and licenses. IQ Bot users and roles are defined in the Control Room.

Evaluate your use case

Content extraction models can be integrated into IQ Bot for extracting data from specific type of documents.

Before you proceed further with standard forms, evaluate your use case to determine if the content extraction from standard forms suits your requirement. Use the following questions as a guide to determine whether your use case needs Standard forms processing

What are standard forms?

Fixed format type documents that have a defined template, with very little or no variation in the overall layout. Standard forms are also known as structured documents, are generally characterised by high density of information, and are typically official or legal forms. The following table illustrates some examples of standard forms:

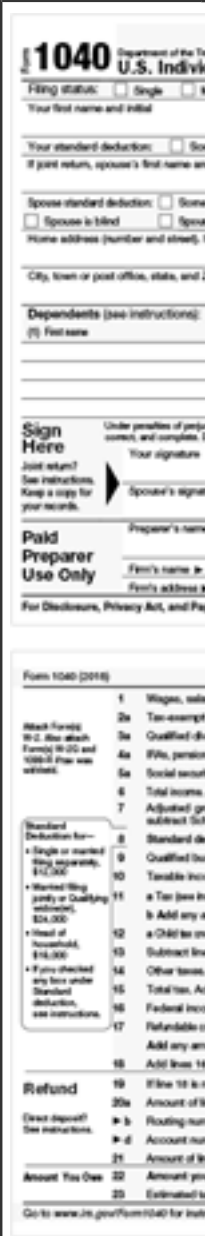
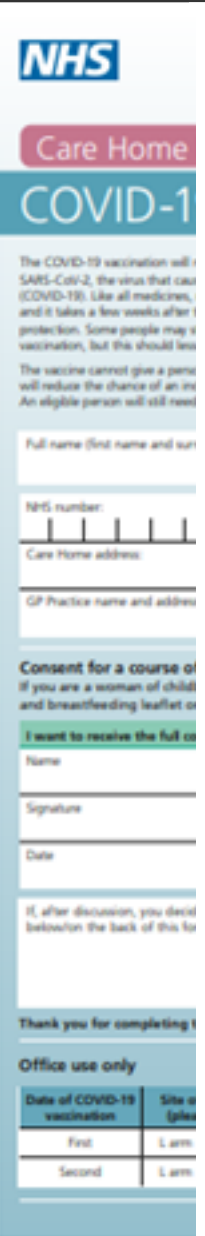
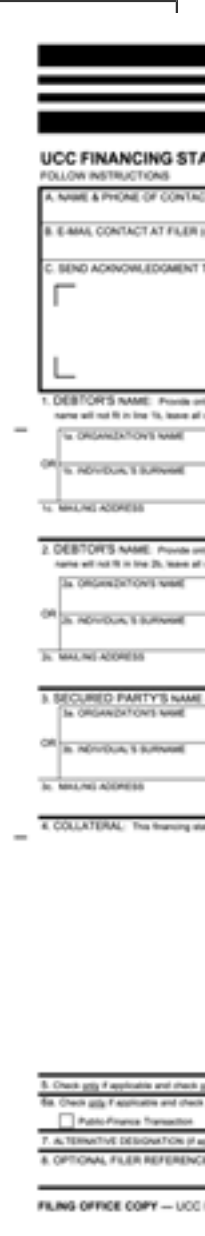
Tax form	Medical form	Legal form						
 <p>1040 Department of the Treasury U.S. Individual Income Tax Return</p> <p>Filing status: <input type="checkbox"/> Single <input type="checkbox"/> Married</p> <p>Your first name and initial</p> <p>Your standard deduction: <input type="checkbox"/> Standard <input type="checkbox"/> Itemized</p> <p>Spouse standard deduction: <input type="checkbox"/> Spouse <input type="checkbox"/> Spouse is blind <input type="checkbox"/> Spouse is blind</p> <p>Home address (number and street), if different from the above</p> <p>City, town or post office, state, and ZIP+4</p> <p>Dependents (see instructions): (1) First name</p> <p>Sign Here Under penalties of perjury, I declare that I prepared this return and its attachments truthfully and correctly, and I am not aware of any information that would require me to amend or disavow this return.</p> <p>Preparer's name Firm's name Firm's address</p> <p>Form 1040 (2018)</p> <p>1 Wages, salaries, tips, etc. 2 Tax-exempt interest 3a Qualified dividends 3b Dividends not reported to you 4a IRA, pension, or annuity payments 4b Social Security benefits 5 Total income 6 Adjusted gross income 7 Standard deduction 8 Qualified business income 9 Taxable income 10 Taxable income after credits 11 Tax (see instructions) 12 Add any other taxes 13 Subtract line 11 from line 10 14 Other taxes 15 Total tax 16 Federal income tax refundable 17 Add any other refundable taxes 18 Add line 16 to line 15 19 If line 18 is more than \$5,000, the amount of the refundable tax credit 20 Amount of refundable tax credit 21 Amount of tax 22 Estimated tax paid</p>	 <p>NHS</p> <p>Care Home</p> <p>COVID-19</p> <p>The COVID-19 vaccination will protect you from SARS-CoV-2, the virus that causes COVID-19. Like all medicines, it takes a few weeks after vaccination to start protecting you, but this should reduce your chance of getting the virus. The vaccine cannot give a person COVID-19. An eligible person will still need to wear a face mask and keep their distance from others.</p> <p>Full name (first name and surname)</p> <p>NHS number:</p> <p>Care Home address:</p> <p>GP Practice name and address:</p> <p>Consent for a course of COVID-19 vaccination If you are a woman of childbearing potential, you will be asked to sign a consent form before you start your course of vaccination. If you do not consent, you will not be vaccinated.</p> <p><input checked="" type="checkbox"/> I want to receive the full course of COVID-19 vaccination.</p> <p>Name: _____ Signature: _____ Date: _____</p> <p>Thank you for completing this form.</p> <p>Office use only</p> <table border="1"> <tr> <th>Date of COVID-19 vaccination</th> <th>Site of vaccination</th> </tr> <tr> <td>First</td> <td>L arm</td> </tr> <tr> <td>Second</td> <td>L arm</td> </tr> </table>	Date of COVID-19 vaccination	Site of vaccination	First	L arm	Second	L arm	 <p>UCC FINANCING STATEMENT FOLLOW INSTRUCTIONS</p> <p>A. NAME & PHONE (OF CONTACT AT FILER) (optional)</p> <p>B. E-MAIL CONTACT AT FILER (optional)</p> <p>C. SEND ACKNOWLEDGMENT TO: (Name and Address)</p> <p>1. DEBTOR'S NAME: Provide only debtor name (1a or 1b) (debtor name will not fit in line 1c, leave all of item 1 blank, check here <input type="checkbox"/>) 1a. ORGANIZATION'S NAME OR 1b. INDIVIDUAL'S SURNAME 1c. MAILING ADDRESS</p> <p>2. DEBTOR'S NAME: Provide only debtor name (2a or 2b) (debtor name will not fit in line 2c, leave all of item 2 blank, check here <input type="checkbox"/>) 2a. ORGANIZATION'S NAME OR 2b. INDIVIDUAL'S SURNAME 2c. MAILING ADDRESS</p> <p>3. SECURED PARTY'S NAME (or name of associate or affiliate) (3a. ORGANIZATION'S NAME OR 3b. INDIVIDUAL'S SURNAME) 3c. MAILING ADDRESS</p> <p>4. COLLATERAL: This financing statement covers the following collateral:</p> <p>5. Check <input type="checkbox"/> if applicable and check <input type="checkbox"/> one box: Collateral is: <input type="checkbox"/> Real Estate <input type="checkbox"/> Personal Property <input type="checkbox"/> Motor Vehicle <input type="checkbox"/> Public Finance Transaction <input type="checkbox"/> Manufactured Home <input type="checkbox"/> Leasehold Interest</p> <p>7. ALTERNATIVE DESIGNATION (if applicable) <input type="checkbox"/> Lessor <input type="checkbox"/> Lessee</p> <p>8. OPTIONAL FILER REFERENCE DATA:</p> <p>FILE IN OFFICE COPY — UCC FINANCING STATEMENT</p>
Date of COVID-19 vaccination	Site of vaccination							
First	L arm							
Second	L arm							

Does the layout of your documents vary across vendor?

Are the positions of the various data elements (checkboxes, tables, and so on) fixed in your documents?

Is the document a dynamic form? For example, you have documents where the values depend on other data elements.

Is the document in a supported language?

If yes, then this use case for content extraction using standard forms is not the best option.

If no, then these are not standard forms and this type of content extraction is not suitable.

If yes, then content from such documents cannot be processed using standard forms content extraction.

See [Azure Form Recognizer Supported Languages](#). If no, then the document cannot be processed as a standard form.

Does the documents have repetitive sections?	If yes, then this is not a standard forms use case. However, if there are a fixed number of such repetitive sections that do not vary between documents, then it can be processed as a standard forms.
Does your documents contain tables that have a different number rows and columns?	If yes, then these documents cannot be considered as standard form. The number of rows and columns have to be fixed for standard forms.
Can document layouts that vary per year be considered as standard forms? For example, a W-4 document in 2020 and W-4 document in 2021?	If the document layout does not vary within the same year or vary across organizations, then it can be considered as standard forms. If there are layout variations across years, then different standard form models must be used to process these documents.

Review extraction service

After you have confirmed that the documents you want to extract content from are standard forms, you can then plan the type of standard forms extraction service that fits your requirement.

The following technologies are available for processing standard forms:

IQ Bot extraction service

This is a template based extraction service that uses OCR and heuristics to extract content from standard forms. You have to train one template per standard form.

Guidelines for using IQ Bot extraction service

- Documents are of good quality (300 dpi)
- Document content is not very dense
- Input documents do not have any handwritten copies (limited support)
- Signatures are currently not supported
- Contains simple table layout (span within a page) with clear header, table boundaries, and so on
- Does not contain any tables or content that have checkboxes (limited support)
- Does not have any repeated sections (limited support)

Benefits of IQ Bot extraction service

- An integrated and simple out-of-the-box setup
- Various OCR engines to increase accuracy of extraction
- Complex layouts (repeated sections, continuous tables etc) can be extracted for specific cases (needs testing)
- Only requires IQ Bot license

Microsoft Azure Form Recognizer service

Third party technology, that provides custom built Artificial Intelligence (AI) models to extract content from standard forms. You can create custom models where documents can be labelled and trained.

Guidelines for using Microsoft Azure Forms Recognizer service

- Input documents:
 - can be dense (contain lot of details and information) and have a reasonable quality (>200 dpi)
 - can contain checkboxes and radio buttons
 - can have handwritten content
 - can contain signatures
 - can contain tables

The input documents can also contain tables that span over a single page. However, if the standard forms contain table that span across multiple pages, the content extraction can fail.

- None of the sections in the input documents are not repeated
- Documents that contain transpose tables

Benefits of Microsoft Azure Forms Recognizer service

- Diverse standard form type documents can be processed
- Auto detection feature can identify different types of tables such as header-less table, inverted tables, and so on
- Good support for handwritten forms

Review implementation prerequisites

After you have finalized the type of extraction service that suits your requirement, ensure that you review the prerequisites before proceeding with the implementation of the service.

IQ Bot extraction service

Review the operating system and database compatibility, database information, and various hardware and software requirements as part of prerequisites for using IQ Bot extraction service.

See [IQ Bot system requirements](#).

Microsoft Azure Form Recognizer service

Review the prerequisites of Microsoft Azure Form Recognizer service installation for standard forms.

- Cloud setup and installation

No additional configurations are required. However, based on the page processing volumes, the Transactions Per Second (TPS) must be increased for the Microsoft region where your service is running. Contact your Customer Success Manager (CSM) or Partner Enablement Manager (PEM) with the expected page volume and Microsoft region where the service is running to update the TPS.
- On-Premises setup and installation

[Pre-requisite for Azure Container on-prem installation for Standard Forms \(A-People login required\)](#)

Considerations for optimum performance

Review the considerations to capture the performance metrics of IQ Bot standard forms with a new Model containing more number of forms or table fields.

Test summary

- Performance test was run for 10000 COVID Form documents (two pages per document = 20000 pages) on a single node IQ Bot server using a single Bot Agent (using IQ Bot Extraction package). This test was conducted to benchmark the performance metrics such as processing time, Straight Through Processing (STP), validation, and documents processed (#successful processed pages/documents and #failed pages/documents).
- New Model (WalgreenComplete 3260b299-68b5-4118-87df-b313bd5c30f6) with 26 Form Fields & 8 Tables fields are trained and used for extraction.
- With new Model (WalgreenComplete 3260b299-68b5-4118-87df-b313bd5c30f6), all the documents were moving to validation during extraction. To get STP we marked below 5 fields as optional for this test: A2PatientSign, B2Date, B2Sign, Phone, InsuranceCard(Table)->Card Details.
- Total time take to process 20000 pages using single Bot Agent was 25 hours, 21 minutes, & 42 seconds. This was based on IQ Bot On-Premises Build 12350.
- Average time take to process single page using IQ Bot Extraction package on single Bot Agent is approximate 4.56 seconds.
- Achieved STP: 100% and Accuracy: 100%.
- During our test execution, the requests were served by Microsoft standard forms services hosted in us-west2 region.
- As confirmed, Microsoft team TPS (Transactions Per Second) supported by us-west2 region was 100 TPS

Note: KPI (Key Performance Indicators) like processing time, STP, accuracy might vary based on the regions where Microsoft standard forms service is hosted and its transactions per second (TPS) rate.

Infrastructure configurations

The following table lists the infrastructure configurations:

Server	Parameters	Values
Server 1 [Web Server]	Control Room	Windows Server 2019 → 8vCPU, 16 GB RAM, 512 GB Disk [Rackspace Platform]-uee
Server 2 [Database]	Database	Windows Server 2019 → 8vCPU, 16 GB RAM, 512 GB Disk [Rackspace Platform]
Server 3 [Application Server]	IQ Bot	Windows Server 2019 → 8vCPU, 16 GB RAM, 512 GB Disk [Rackspace Platform]
Server 4 [Client]	Bot Agent	Windows Server 2019 → 4vCPU, 8 GB RAM, 256 GB Disk [Rackspace Platform]

Product configurations

The following table lists the product configurations:

Parameters	Values
Automation Anywhere Enterprise	Automation 360 Build 12313
Bot Agent	21.80.10273
IQ Bot	A360.24.28441-20220311
IQ Bot Extraction package	1.0.0-20220307-024320
Database	Microsoft SQL Server Developer (64-bit)
Protocol	HTTPS
Network services	Non-Active Directory

Data configurations

The following table lists the data configurations:

Parameters	Values
Domain	Standard forms
Provider	Forms Extractor Type 1
Model	WalgreenComplete 3260b299-68b5-4118-87df-b313bd5c30f6
Document Type	Multi page PDF document
Pages	Two pages per document
Form Fields	26 [A2Date, A2PatientSign, Address, Age, B2Date, B2Sign, City, DOB, Email, FirstName, LTCFName, LastName, Phone, PrintName, Race-American, Race-Asian, Race-Black, Race-Native, Race-Other, Race-UnableToReport, Race-Unknown, Race-White, RefusedInformation, State, VaccinationType, Zipcode]
Table Fields	8 tables, 23 table fields Table1: DriversLicense[Issuance, LicenseNo]Table2: Ethnicity[Hispanic, NotHispanic, UnableToReport, Unknown]Table3: Gender[Female, Male]Table4: InsuranceCard[Card Details, Medical Card, Pharmacy Card]Table5: MedicareDetails[Medicare, Medicare PartB]Table6: PatientCardHolder[DontKnow, No, Question, Yes]Table7: PatientType[Resident, StaffMember]Table8: ScreeningQuestions[DontKnow, No, Question, Yes]
Configuration	COVID forms
# of Documents	10000
# of Pages	20000

Parameters	Values
Language	English

Test results

The following table lists the test results:

Parameters	Values
Total Documents Uploaded	10000
Total Pages Uploaded	20000
Total Processed documents	10000
Total Processed pages	20000
Success	10000 documents
Pending Review (Validation)	0
STP	100%
Accuracy	100%
Processing Time	<i>25 hours, 21 minutes, and 42 seconds</i>

Resource consumption data

The following table provides the resource consumption data:

Parameters	CPU Utilization in %	Memory Utilization in %
IQ Bot	Average: 3.4 Maximum: 26.8	Average: 70.9 Maximum: 78.9
Control Room	Average: 1.4 Maximum: 14.5	Average: 83.3 Maximum: 84.8
Database	Average: 3.3 Maximum: 20.6	Average: 91.5 Maximum: 94.1
Bot Agent (Extraction)	Average: 4.8 Maximum: 48.9	Average: 52.4 Maximum: 58.7

Set up extraction service

To extract content from standard forms, you must setup and configure an extraction service. Review this topic to understand how to setup each of the extraction service.

IQ Bot extraction service

No specific setup is required for content extraction through IQ Bot service. Ensure that you have access to an active IQ Bot environment so that you can create a learning instance.

See [Create a learning instance](#).

Microsoft Azure Form Recognizer service

1. Subscribe to Microsoft Azure service

Microsoft provides the Azure Form Recognizer service. This service enables you to build automated data processing software that can identify and extract specific content from documents. You must have Microsoft Azure subscription in order to access Azure resources (OCR, Form Recognizer), Automation Anywhere provides access to these resources through its subscription. Contact your Customer Success Manager (CSM) or Partner Enablement Manager (PEM) who will help you setup the services.

[Request access for Microsoft Azure resources \(OCR and Form Recognizer\) \(A-People login required\)](#)

2. Setup Microsoft Azure Form Recognizer service

a. For Cloud deployment

- If you have Automation Anywhere subscription, no additional configurations or changes are required.
- If you have Microsoft Azure subscription, review the following article to setup and configure your Microsoft Azure Form Recognizer for extracting content from standard forms.

[Setup Azure Form Recognizer and Storage \(Cloud\) \(A-People login required\)](#)

b. For On-Premises deployment

[Setup Azure Form Recognizer and Storage \(On-Premises\) \(A-People login required\)](#)

Configure IQ Bot for extraction service

IQ Bot must be connected to the extraction service for processing standard forms. The following section provides details on how to configure IQ Bot for the selected extraction service. However, your IT Service team can help you setup and configure the extraction service in IQ Bot.

IQ Bot extraction service

If you choose IQ Bot extraction service, no additional configurations are required.

Microsoft Azure Form Recognizer service

If you choose the Microsoft Azure Form Recognizer service, you must add Microsoft Form API and the corresponding configurations in IQ Bot.

[How to Setup and configure standard forms in IQ Bot \(A-People login required\)](#)

Create the model in Document Automation

In Automation 360 v.26, you can configure the extraction model in the Control Room:

[Create standard form in Document Automation](#)

Build extraction model

Data extraction model typically leverages Artificial Intelligence (AI) and Machine Learning (ML) technologies to accurately extract text, key-value pairs, and tables from documents.

IQ Bot extraction service

Requires no separate AI model as this will be done as part of creating and training a learning instance in IQ Bot.

See *[Create a learning instance](#)*.

Microsoft Azure Form Recognizer service

During your use case evaluation, Microsoft Azure Form Recognizer models can be created by Sales Engineering. But for any production deployment, contact Professional Services, or Partner Enablement Manager (PEM) at Automation Anywhere.

[How to Create and train Azure Form Recognizer model \(A-People login required\)](#)

The benchmarks for the time taken for labeling fields in the Microsoft Azure Form Recognizer service are as follows:

- Up to 30 fields: 1 hour
- 30 to 100 fields: 2 hours
- 100 to 400 fields: 4 hours

Note: While creating a model, ensure there are no duplicate model names. And while creating a table, ensure that the table name does not contain a space. For example, `Sales chart.xls`.

Transfer third-party extraction service models

Third party extraction models can be transferred from one subscription to another. Contact your Automation Anywhere Customer Success Manager (CSM) for assistance.

IQ Bot extraction service

If you are using IQ Bot extraction service, no changes required.

Microsoft Azure Form Recognizer service

- Transfer models from one On-Premises to another On-Premises environment.
Transfer models from one environment to another (On-Prem) (A-People login required)
- Transfer models from one Cloud to another Cloud environment.
Transfer models from one environment to another (Cloud) (A-People login required)

Note: You can transfer standard forms learning instance along with an associated model between your IQ Bot instances using API configurations. For more information, see [Transfer standard forms learning instance and associated model \(A-People login required\)](#)

Create a learning instance for standard forms

Learning instance is used in IQ Bot to extract, train, validate content from standard forms. Use the following instructions to create a learning instance for processing standard forms in IQ Bot

<https://fast.wistia.net/embed/iframe/2t9dimrlre>

Using IQ Bot extraction service

Ensure that you have access to an active IQ Bot environment so that you can create a learning instance.

See [Create a learning instance](#).

Using Microsoft Azure Form Recognizer service

1. From the **Document type** drop-down menu select **Standard Forms**.
2. In the **Standard form settings** tab, from the **Provider name** drop-down menu, select a provider for processing the form.
3. From the **Configuration type** drop-down menu, select the supported configuration.
This enables you to connect to one of the provider services configured during installation.
4. From the **Select Model** drop-down menu, select a pre-trained model for the selected configuration.

5. Click **Browse** to upload a reference document.

For example, if you have selected the configuration type and model as invoice, you can upload an invoice file that must be analyzed.

Note: The reference document is only a representation of the document type you want to extract data from.

6. From the **Fields to extract** tab, select the fields from where the values must be extracted.

The fields are displayed based on the selected Form set in the pre-trained model, and no additional fields can be added.

7. Click **Create instance and analyze**.

The system analyzes and sorts the document into logical group.

Note: Only one default group is created. The system-identified region (SIR) are not visible and all the training related fields are greyed out. As the standard forms learning instance contains pre-trained model, no additional training of the group is available. You can only add validation patterns and custom logic.

After you have created a learning instance, you must add a group specific to standard forms.

8. On the **Learning Instance details** page, click **Add group**.

9. Create group label as *<Standard Forms layout name>*.

For example, if you have W-4 documents for the year 2021, enter *W4_2021*.

10. Click **Save**.

11. Open the system generated group

12. Click **Delete Bot**.

System generated group is removed from the **Learning instance details** page

Edit a standard forms learning instance

As the learning instances created by using standard forms have pre-set configurations, you can edit only the name and the description. Also, you cannot edit instances in the production environment without moving them to staging.

Note: If you want to change the model associated with a learning instance, you must create a new model and follow these instructions:

1. Create another learning instance similar to the previous one.
2. Associate the new model with this learning instance.
3. Select all the fields you had selected in the previous learning instance.
4. Update the validation rules.
5. Move the learning instance to production and associate a bot with this learning instance.

-
1. On the **My learning instances** page, select the learning instance you want to edit.

You can also use the **Search** bar to locate the learning instance.

2. Click **Edit**.

3. Edit the name of the learning instance in the **Instance name** field.

The document classification options are not available as the standard forms use a pre-trained model and configurations.

4. Optional: Use the **Document Groups** tab to review the groups associated with the learning instance.

Note: The **Add group** button is not available as adding groups is not supported for a standard forms learning instance.

5. Optional: Click the **Summary** tab to review the learning instance.

Standard Forms details such as **Provider**, **Configuration**, and **Model** are available under this tab.

6. Click **Save**.

Changes made to the learning instance are updated on staging.

Define validation rules for standard forms learning instance

To prevent wrong or invalid data extraction, you can edit the bot associated with any standard forms learning instance and customize the validation rules.

You can only edit a bot on staging. So ensure that you move any bot that you want to edit to staging if it is in production.

Using IQ Bot extraction service

Use IQ Bot Designer to train a learning instance and extract content from sample documents. Review each field to ensure the correct value is extracted and where necessary, map the correct field.

For more information, see [Train a learning instance](#).

Using Microsoft Azure Form Recognizer service

1. On the **Bot** page, select the bot you want to edit.

You can also use the **Search** bar to locate the bot.

2. Click the **Edit Bot** icon.

3. In the **Field** column, click **Field options**.

4. Enter any custom validation rules in the fields under the **Validate Pattern** tab.

Documents that are not processed are moved to the **Validator**, and fields with errors are flagged. You can review the flagged fields in the Validator.

Use the IQ Bot Validator

5. Enter post processing logic under the **Logic** tab, and click **Save**.

6. Click **Save**.

The updated bot is saved on staging and you can move it to production.

Upload documents for standard forms learning instance

Upload your documents to IQ Bot for an existing standard forms learning instance for content extraction.

For extracting content from a single document, use the **Upload Document** action from IQ Bot package in RPA Workspace.

See. [Upload document action](#)

For content extraction from multiple or large number of documents, you can use the **Process documents** action from IQ Bot Extraction package in Control Room. Use the following instructions to upload multiple or large number of documents:

1. Drag the **Process documents** action into the workflow.
2. Click the **Learning instance name** drop-down menu and select a standard forms learning instance.
3. In the **Desktop folder** tab, enter the file path for the input folder or click **Browse** to select it.
4. Select the output folder from the **Output folder path** field.
5. Select the **Send documents to IQ Bot Validator for validation** check box.

Although the documents are processed using Bot Runners on your local machine, you must use this option if you want to validate the documents in the Validator

6. Click **Save**.

Download extracted content

After you have trained learning instance, use the **Download all documents** action from the IQ Bot package to download extracted content from standard forms.

1. Drag the **Download all documents** action from the **IQ Bot** package.
2. Click the **Learning instance name** drop-down menu and select a standard forms learning instance.
3. In the **Local output folder** field, provide a path to your local folder where you want to extract the content.
4. In the **IQ Bot Document status**, select the appropriate status for the documents:
5. Select **Delete files from the server after downloading** check box if you want to remove the files from IQ Bot server.
6. In the **Save the response to a variable** field, add a variable.

A variable value in this field provides information if the download was successful or the reason for a failure.

7. Click **Save**, and run the bot.

8. Navigate to the local output folder to review the downloaded files.

The output folder can have up to three subfolders:

- **Retrain:** Contains documents that were sent for validation.

These documents are stored in their original input format and you can train them by uploading them to your existing learning instance.

- **Success:** Standard form documents that have been processed successfully.

The output is a `.json` file. Tables in the input documents are auto extracted and saved as separate `.xls` file with the table name.

- **Validate:** Contains documents that require validation.

These documents will be available in the IQ Bot Validator and you can download the output separately.

Note: Depending on the content in the uploaded documents, you can also get the following additional subfolders:

- **Failed:** Documents that failed the validation process.
 - **Unprocessed:** Documents that could not be classified.
-

Transfer standard forms learning instance

A standard forms learning instance is similar to the regular IQ Bot learning instance that describes the data in a single document type, for example an invoice. It contains information such as the language used in the documents and the fields to extract.

- Ensure that the source and destination systems are running the same IQ Bot version. Learning instances from different IQ Bot versions cannot be imported because their database schema will not match.
- Back up your database before importing learning instances.
- Export the `.iqba` file from the source IQ Bot environment.
- Import the `.iqba` file into the destination IQ Bot environment

<https://fast.wistia.net/embed/iframe/eoegnd0xzn>

Related concepts

[Manage learning instances](#)

A learning instance is an IQ Bot structure that describes the data in a single document type, for example an invoice. It contains information such as the language used in the document and the fields to extract.

Export a standard forms learning instance

Standard forms learning instance can be used across similar IQ Bot environments. Export an existing learning instance to avoid creating another one with the same configurations.

IQ Bot administrator can use the following instructions to edit a standard forms learning instance:

1. Click **Administration > Migration**.
2. Click **Create Backup**.

Backing up your existing learning instance enables you to save and restore the configuration if required.

3. Select the learning instances that you want to back up and then click **Backup**.

4. Enter a name for the IQ Bot archive (IQBA) file.

The name of the archive file is appended with a time stamp to make it unique. You can download this file and export it to the target environment.

5. Click **Backup** to begin the export process.

The exported data file with the `.iqba` extension is available in the `BackupData` folder in your IQ Bot output directory.

Import a standard forms learning instance

Import an existing learning instance from a similar environment to avoid creating learning instances and associated bots multiple times. Use the Automation 360 IQ Bot Migration Utility feature to import any standard forms learning instances.

Ensure that you have migrated the associated configuration to the target server before importing a learning instance.

When you export an `.iqba` file, only a single document associated with every available bot (Group) training is exported.

1. Log in to IQ Bot as an administrator.

2. Click **Administration > Migration**.

A list of backed-up learning instances is displayed.

3. Click the **Import** icon under the **Actions** tab for the selected learning instance.

4. Select the import method, and click **Accept**.

The selected standard forms learning instance is imported and is displayed under in **My learning instances** page.

Document Automation

Document Automation is the new Cloud-native intelligent document processing solution that business users can set up to automatically read and process documents quickly using pretrained models and validation feedback.

Document Automation is fully integrated into Automation 360: Document Automation is installed as part of the Control Room, RPA bots are used to extract semi-structured data to automate document-centric business processes, and Automation Anywhere Robotic Interface manages the end-to-end extraction process and validation tasks.

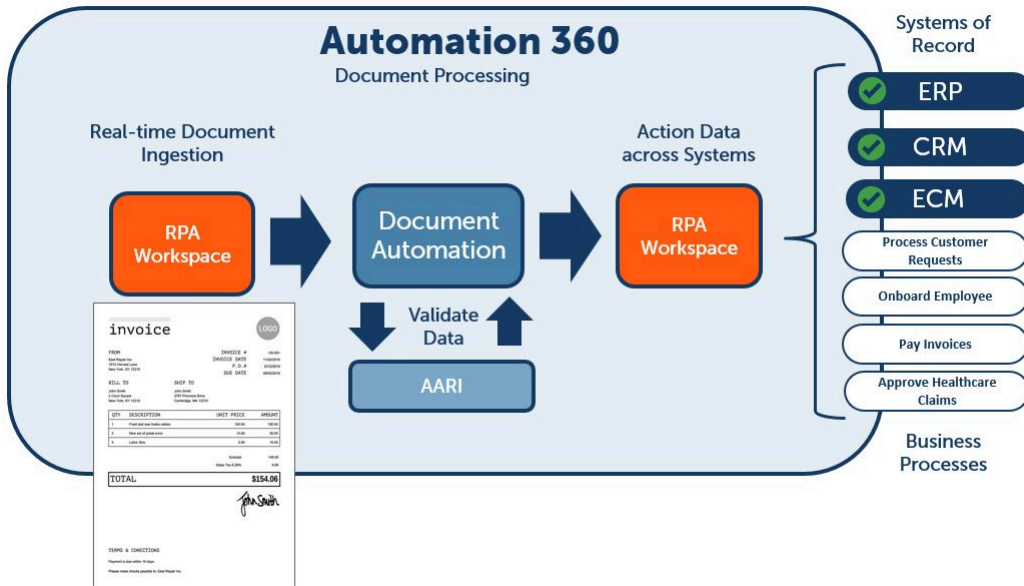

The Document Automation workflow enables users to scale their document processing operation. Users create learning instances that use Automation Anywhere or Google Document AI pre-trained models to process invoices, utility bills, and receipts. Once a learning instance is running in production, it automatically improves extraction accuracy based on feedback from manual validation.

To compare Document Automation features side by side with Automation 360 IQ Bot, see [Intelligent Document Processing solutions feature comparison matrix](#).

Set up the Document Automation environment

Document Automation is installed simultaneously with the Control Room and shares the Control Room database. There are no additional installation tasks for Control Room Cloud customers.

To get started using Document Automation, you must first configure users, roles, and devices, and connect the Control Room with Automation Anywhere Robotic Interface:

[Set up your Document Automation environment](#)

Note: To install Document Automation in an On-Premises server, note the following:

- The Control Room stores Document Automation output data.
- You must install the Control Room in a configuration that points to the location where Document Automation data is stored. Ensure there is sufficient storage space.
- The minimum necessary storage space depends on the processing volume, document size, and use case. As a guide: an environment that processes 100,000 pages per month, with a 30-day data lifespan, requires 500 GB of storage space.

Using Document Automation

Workflow map: Click the following schematic image to view the workflow in an interactive visual



format:

1.

The following is an overview of the end-to-end process to create, configure, and publish a learning instance in Document Automation:

Step 1: [Create a learning instance](#)

Log in to the Control Room as the learning instance creator user, and create a learning instance to extract values from documents.

Step 2: [Process documents](#)

Upload documents to the learning instance to test the model, fix validation errors, and verify the extracted data.

Step 3: [Build a bot to upload documents to Document Automation](#)

Build a bot that uploads documents from a source folder to Document Automation.

Step 4: [Publish the learning instance](#)

Check-in the learning instance assets (process, form, and bots) to the public repository. Then, deploy the process and bots to unattended Bot Runner devices to begin processing documents in real time.

After the process is deployed, incoming documents are processed, and Document Automation either extracts data from the documents or sends the documents for validation.

Step 5: [Validate the uploaded documents](#)

Log in as the Validator user, open the validation queue, and use the Validator to fix errors.

Related concepts

[Document Automation users](#)

With the required roles, permissions, and licenses, Document Automation users can perform various tasks. Users and roles are defined in the **Administration** tab.

Related tasks

[Set up your Document Automation environment](#)

Document Automation is installed simultaneously with the Control Room. Configure the users, roles, and devices, and connect the Control Room with Automation Anywhere Robotic Interface.

Related reference

[Document Automation FAQ](#)

Answers to frequently asked questions (FAQs) on the latest Automation Anywhere intelligent document processing solution, Document Automation.

Related information

[Document Automation Developer Training \(A-People login required\)](#)

Document Automation FAQ

Answers to frequently asked questions (FAQs) on the latest Automation Anywhere intelligent document processing solution, Document Automation.

Product FAQ

What pre-trained models are included?

Automation Anywhere offers invoices and Google Document AI offers invoices, utility bills, and receipts.

Does Document Automation have feature parity with Automation 360 IQ Bot?

Document Automation supports the following features from Automation 360 IQ Bot:

- Data extraction from text, number, date time, and check box fields
- Validation rules based on patterns, formulas, lists, and statements

Which browsers are supported?

Document Automation is supported on the same browsers as the Automation Anywhere Control Room: Google Chrome, Microsoft Internet Explorer, and Microsoft Edge.

Note: If you use Document Automation in Firefox, the user interface might not behave as expected.

What languages are supported?

Document Automation supports English, Dutch, French, German, Italian, Portuguese (Brazilian), and Spanish.

Note: Extraction for French, German, and Spanish language documents is currently in preview. Extraction results will improve in future releases.

You can process documents in other languages by creating and training a training a learning instance in Automation 360 IQ Bot and connecting it with Document Automation to process documents using Document Automation technology and workflow. For more information, see [Connect learning instance](#).

What file formats are supported?

Document Automation can process documents in the following file types:

- PDF
- JPG
- JPEG
- PNG
- TIF
- TIFF

Which licenses are necessary?

The IQ Bot Pages product licenses is necessary for processing documents. The Automation

Anywhere Robotic Interface license is necessary for processing documents in learning instances in production.

To send documents to Google Document AI for extraction, you must also have the `Doc AI Document` product license.

Note: To configure the Control Room with your Google Document AI license key, you must do these steps: [Configure key for Google Document AI](#). These steps are not necessary if you purchased `Doc AI Document` licenses through Automation Anywhere.

We provide a recommendation on configuring users with the minimum necessary roles and device licenses to perform specific tasks in [Document Automation users](#).

Users can connect their learning instances from Automation 360 IQ Bot to their Document Automation environment, which allows them to process documents using the Document Automation technology without having to rebuild the learning instances. For more information, see [Connect learning instance](#).

If you have connected a learning instance from Automation 360 IQ Bot to Document Automation, do not delete the learning instance from Automation 360 IQ Bot since it stores the training data.

We recommend you maintain Automation 360 IQ Bot in a version compatible with the associated Control Room.

Document Automation offers over 35 of the most common invoice fields, with the option to configure custom fields. To see all the possible fields when you are creating a learning instance, click **Show unused fields**.

Can learning instances be migrated from Automation 360 IQ Bot to Document Automation?

Are customers required to maintain their Automation 360 IQ Bot environments?

What learning instance fields are supported out of the box?

Processing and extraction FAQ

Which OCRs are supported?

The Automation Anywhere pre-trained model uses the ABBYY FineReader Engine or the Google Vision OCR.

I uploaded documents for processing, but nothing is happening.

The first time you process documents, the Document Extraction package downloads to the local device. This might cause a delay in document processing.

What should I do if a folder contains documents in multiple languages?

Use the IQ Bot Classifier package to sort the documents by language, then create a learning instance for each language.

How do I process documents using Google Document AI?

Document Extraction enables users to send their documents to Google Document AI for processing. To use this feature, users must have Document AI licenses that they either purchased from Automation Anywhere or provided their Google Document AI account credentials to the Control Room.

The process of creating, testing, and publishing is the same for learning instances using a Google Document AI model as for learning instances using a pre-trained model from Automation Anywhere.

Are multi-page tables supported?

Yes, Document Extraction supports extracting tables that span across multiple pages.

Is it possible to extract multiple tables from a document?

At this time, Document Automation can extract one table per document.

Where can I see the reason why data was not extracted from an uploaded document?

The AARI **Requests** tab holds the history for each uploaded document. Here, you can see the step at which extraction failed or if a Validator user marked the document as invalid.

Is currency extraction supported?

Yes, except for the rupee (₹).

Intelligent Document Processing solutions feature comparison matrix

Review the differences between Automation 360 IQ Bot and Document Automation by comparing the features in them.

	Automation 360 IQ Bot	Document Automation
Administration and setup		
Installation	Separate installer	Installed as part of the Control Room
Database administration	Separate database; requires additional effort for backups and maintenance	Uses the Control Room database; no additional backup or maintenance needed
Server configuration	Requires additional SSL configuration, RabbitMQ administration, HA and DR	Works out of the box
Learning instance configuration		
Alias management (keywords)	No way to add or remove field aliases for domains, only for document groups	Users can view, add, or remove field aliases for the learning instance
Confidence threshold	Does not work out of the box; server-level configuration	Helps to catch false positive outcomes; field-level configuration
Field order and field name customization	Not supported	Helps to improve validation efficiency

	Automation 360 IQ Bot	Document Automation
Field configuration	Must be done for every group	Needs to be done only one time for a learning instance
Ability to add and remove fields from the learning instance	No	Yes
Extraction capabilities		
Pre-trained models	Domains required training	Can process invoices, receipts, and utility bills
Handling document variations	Classifier relies on document layout and training. Documents uploaded with a new layout are sent to a new document group, which requires training. Some docs could not be classified.	Layouts are identified using an object detection model to find key-value pairs. It is not necessary to configure all the fields in a learning instance before uploading documents.
Training process	Each group needs to be manually trained before it can process documents	Learning instance extraction improves based on changes users make in the Validator
Output format	CSV only	CSV or JSON
Human review and validation		
Validation queue management	No	Use filters and search to find specific learning instances or documents
End-to-end automation		
Task bots	Must be manually created	Control Room automatically creates task bots for a learning instance
See status and history of uploaded documents	No	Yes
Customizable document processing workflow	No	Yes
Security		
Retention policy	No	Supported by AARI storage See Cloud storage retention policy
Secret management	No	Can use credential vault to store Google Document AI credentials

Set up your Document Automation environment

Document Automation is installed simultaneously with the Control Room. Configure the users, roles, and devices, and connect the Control Room with Automation Anywhere Robotic Interface.

1. Log in to Document Automation through the Control Room.
You will receive an email from Automation Anywhere with your URL and credentials. Open the Control Room URL in your browser, enter your credentials in the login screen, and click **Log in**.
2. Upload the Document Extraction package to the Control Room: *Upload the IQ Bot packages to the Control Room*
3. Create a custom role that allows users to check in and check out bots, manage packages, and validate documents.: *Create a custom role for Document Automation*
4. Create the users necessary to complete the end-to-end process of creating and publishing a learning instance: *Document Automation users*

Note: When creating the `Unattended Bot Runner` user, provide the device credentials. You will connect the `Unattended Bot Runner` to the device in the next step.

5. Configure the unattended Bot Runner user device and device pool to allow the learning instance to function in public mode:
 - a) Using Remote Desktop Protocol (RDP), open the virtual machine where the unattended Bot Runner will run.
 - b) Log in to the Control Room as the `Document Automation Admin` user you created previously.
 - c) Navigate to **Manage > Devices** and click **Connect local device**. Follow the steps in the wizard to connect the Control Room to your device.
 - d) Click **Refresh** to verify that your device is connected.
 - e) Click **Create device pool** and perform the following steps:
 1. Enter a name for the device pool.
 2. Click **Devices** and then the arrow to move the device to the **Selected** column.
 3. Click **Consumers** and then the arrow to move `aari-document-processor` to the **Selected** column.
 4. Click **Create device pool**.

You can perform the following steps in the virtual machine or you can return to your device. If you perform the following steps on your device, ensure that you log in to the Control Room as the `Document Automation Admin` user.

6. Open Automation Anywhere Robotic Interface to connect it with the Control Room.
 - a) Navigate to the AARI interface by adding `/aari` after your assigned Control Room URL.
 - b) Navigate to **Manage > Process > Global scheduler** and click **Edit**.
 - c) Select the `Scheduler` user that you created previously and click **Save**.
The following message is displayed: `Secure connection between AARI Web and Enterprise Control Room established successfully`

7. Create a team in AARI to grant the `Validator` user access to the documents awaiting validation.
 - a) Navigate to **Manage > Team > Create new team**.
 - b) Enter a team name.
 - c) Select the **Shared** request visibility.
 - d) In the **Users** field, add the `Validator` user that you created previously and click **Save**.

If users will create learning instances that use the Google Document AI model **and you did not purchase Google Document AI licenses through Automation Anywhere**, follow the steps to [Configure key for Google Document AI](#).

Log in to the Control Room as the `Learning instance creator` user and begin creating learning instances: [Using Document Automation](#)

Related tasks

[Installing additional licenses](#)

Upload new licenses to the Automation Anywhere Control Room to be distributed to users as required.

Related reference

[System default licenses](#)

Create a custom role for Document Automation

With a custom role, Document Automation users can check in and check out bots, manage packages, and validate documents.

1. Navigate to **Administration > Roles > Create role**.
2. Provide a name for the role, such as `aari-document-processor`.
3. In the Feature permissions page, select the following:
 - View my bots
 - Run my bots
 - Export bots
 - Import bots
 - Create folders
 - Rename folders
 - Cancel checkout

Packages

- View packages
- Manage packages

Automation Anywhere Robotic Interface

- Cross Team Read
- AARI Scheduler

4. In the Bots permissions page, select all the check boxes in the **Bots** row.
5. Click **Save** to create the role.

Create users and assign this custom role to them. For more information about the required users, refer to [Document Automation users](#).

Document Automation users

With the required roles, permissions, and licenses, Document Automation users can perform various tasks. Users and roles are defined in the **Administration** tab.

The following table contains information about each type of user that interacts with Document Automation. It includes a description of the tasks that each user performs, the required roles, permissions, and licenses, and links to the pages most relevant to that user. Use this page to guide you in creating the users in the table below: [Create a user](#)

Note: Some users require a custom role in Document Automation. This role grants users permissions to check in and check out bots, manage packages, and validate documents. For instructions on how to create a custom role, see [Create a custom role for Document Automation](#).

User	Description	Roles	License	Related links
Learning instance creator	Can create, edit, and delete learning instances, upload documents for processing, and check in or check out learning instances.	AAE_IQ Bot Services, AAE_Basic, and <code>aari-document-processor</code> custom role	Bot Creator	Create a learning instance in Document Automation Process documents in Document Automation Publish the learning instance
Document Automation Admin	Deploys the AARI process and RPA bots to the unattended Bot Runner, manages AARI teams, and assigns validation tasks to a team	AAE_Admin, AAE_Pool Admin, AAE_Locker Admin, and AAE_Robotic Interface Manager	--	Set up your Document Automation environment Create an AARI team and assign team roles to members Publish the learning instance
Scheduler	Enables the Control Room and AARI to connect learning instances in public mode to AARI processes. Note: This user is not associated with a real person.	AAE_IQ Bot Services, AAE_Basic, and <code>aari-document-processor</code> custom role	--	--

User	Description	Roles	License	Related links
Unattended Bot Runner	Runs the RPA bots for learning instances in public mode to upload, process, and download documents. Note: This user is not associated with a real person.	AAE_IQ Bot Services, AAE_Basic, and aari-document-processor custom role Note: Provide the device credentials when you configure this user. You will connect the Unattended Bot Runner user to the device in one of the steps in Set up your Document Automation environment .	Unattended Bot Runner, Automation Anywhere Robotic Interface, and the product licenses necessary to upload documents to learning instances in production: IQ Bot pages, standard forms, or Document AI Document processing product licenses	--
Validator	Validates documents that were processed by a learning instance in public mode.	AAE_IQ Bot Validator and AAE_Robotic Interface User	Automation Anywhere Robotic Interface	Validate documents in Document Automation

Related tasks[Create a user](#)

Create a user and assign their specific license based role.

[Create a role](#)

As an administrator, you can configure roles with permissions to access features and perform operations such as create, edit, or delete a bot in the Control Room, and assign the role to a user.

Related reference[Automation 360 licenses](#)

The **All Licenses** page displays detailed information about current product and device licenses.

Configure key for Google Document AI

If the learning instance uses a Google Document AI model **and you did not purchase Google Document AI licenses through Automation Anywhere**, follow these configuration steps.

- If you have not done so already, complete the steps to [Set up your Document Automation environment](#).
- Log in as the `Admin` user type. For more information about the user types, refer to [Document Automation users](#).

You will assign this role to a Credential Vault locker, which will allow the `Learning instance creator` user to securely provide the Google Document AI key to the **Extraction bot**, allowing the learning instance to send documents to Google Document AI for extraction.

Create a custom role to access the Credential Vault locker that holds the Google Document AI key:

1. Navigate to **Administration > Roles > Create role**.
2. Provide a name for the role, such as `doc-ai-credential-role`.
The `Manage my credentials and lockers` permission is automatically selected.
3. Click **Create role**.

Assign the role to the `Learning instance creator` and `Unattended Bot Runner` user types.

4. Navigate to **Administration > Users** and locate the users.
5. For each user, click **Edit user** and add the `doc-ai-credential-role`.

Create a credential to store the Google Document AI key:

6. Navigate to **Manage > Credentials > Create credential**.
7. Provide a name for the credential, such as `doc-ai-credential`.
8. Provide a name for the attribute, such as `ServiceAccount`.
9. Select the **Standard** input option and enter the Google Document AI API key in the **Value** field.
10. Click **Create credential**.

Create a locker to store the key and provide access to other users.

11. Navigate to the **Lockers** tab and click **Create locker**.
12. Provide a name for the locker, such as `doc-ai-locker`.
13. Select the `doc-ai-credential` and click the right arrow to move the credential to the **Selected column**.
14. In the **Consumers** tab and select the `doc-ai-credential-role` and click the right arrow to move the credential to the **Selected column**.
15. Click **Create locker**.

Log in as the `Learning instance creator` user type to do the following:

- Create a learning instance: [Create a learning instance in Document Automation](#)
- Provide the credential to the **Extraction bot**: [Configure Extract action to process documents in Google Document AI](#)

Related tasks

[Installing additional licenses](#)

Upload new licenses to the Automation Anywhere Control Room to be distributed to users as required.

Related reference

[System default licenses](#)

Create a learning instance in Document Automation

Begin processing documents by creating a learning instance to extract data from invoices, utility bills, or receipts. A learning instance is a structure that holds information such as document type, language, and the fields to be extracted.

- To create a learning instance, you must be a `Learning instance creator` user. See [Document Automation users](#).
- To create a learning instance that uses a Google Document AI model, you must create a credential and locker to hold your security token. See [Create credential](#) and [Create locker](#).

Note: When configuring the locker, you must add the `aari-document-processor` custom role as a locker consumer.

- The default OCR is ABBYY FineReader Engine. Alternatively, Cloud Control Room users can create a learning instance to process documents in Google Vision OCR.

Watch this video for the complete end-to-end process of creating a learning instance:

<https://fast.wistia.net/embed/iframe/saff87ggz4>

1. From the Control Room home page, navigate to **Manage > Learning Instances > Create Learning Instance**.
2. Enter a name and description for the learning instance.
Document Automation does not allow duplicate learning instance names, so the name you provide must be unique.
3. Select the document type: **Invoice , User-defined, Utility Bill, or Receipt**
Use the user-defined document type to process documents that are visually similar to invoices, such as purchase orders and sales orders, which contain key-value pairs and a table structure. In this document type, you create and configure all of the form and table fields.
4. Select the language.
Document Automation supports English, Dutch, French, German, Italian, Portuguese (Brazilian), and Spanish.

Note: Extraction for French, German, and Spanish language documents is currently in preview. Extraction results will improve in future releases.

5. **If you selected Invoice:** Select the provider.
If you selected the English language in step 4, **Automation Anywhere (Pre-trained)** is auto-selected.
6. For learning instances with the **Automation Anywhere (Pre-trained)** provider, you can opt in to send feedback to the system to improve extraction results. For more information, see [Data extraction in Document Automation](#)
7. Optional: Select the OCR provider. By default, Document Automation processes documents in ABBYY FineReader Engine.
Users with a Cloud Control Room can select to process documents in Google Vision OCR.
8. Click **Next**.

We recommend that you open a sample document side by side with the Control Room window as you configure the form and table fields.

Note:

- A form field is a type of field that occurs only once in a document.
- A table field is a type of field that reoccurs throughout a document, typically in the form of a table.

-
9. Configure the form and table fields for extraction.
Document Automation offers a standard set of form and table fields, many of which are not initially visible. You can search for a field by field name, field label, or data type.
To see the full list of fields, click **Show unused fields**. See the following video for a demonstration: <https://aa2019packagesdkfordocumentation.s3-us-west-2.amazonaws.com/videos/view-all-li-fields-iqbot.mp4>
Click a field to open the fields editor. You can edit most attributes of a field. You cannot edit the name and default aliases. Document Automation assigns default aliases, which are hardcoded keywords, to standard fields to help with extraction. You cannot modify or delete default aliases, but you can add aliases in the **Custom aliases** field. See the following video for a demonstration of creating a custom alias: <https://aa2019packagesdkfordocumentation.s3-us-west-2.amazonaws.com/videos/custom-alias-iqbot.mp4>
Mouse over the menu icon to the right of a field to access the up/down arrows. Use the arrows to rearrange the order of the fields for a more efficient manual validation. The order of the fields does not impact extraction.
To learn more about the other field attributes, review the table in the next step.

10. To add a field, click **Add a field** and complete the following fields:

Option	Description
Field name	Enter a field name that begins with an alphabetical character (A-Z or a-z). In standard fields, the field name is hardcoded and cannot be changed.
Field label	Enter a user-friendly name to help validators. For example, you can rename <code>Organization tax number</code> to a localized name, such as <code>VAT number</code> . The field label does not affect extraction.
Confidence	Set a threshold to reduce potential false positives. At the time of processing, the Document Automation engine assigns a score to each field in a document to indicate the certainty that the data was correctly extracted. If the document contains fields with a score that is lower than the confidence threshold, the document is sent to the validation queue. If you enter a high confidence threshold, more documents will be sent to the validation queue. If you enter a low confidence threshold, fewer documents will be sent to the validation queue. Supports values from zero to 100.
Data type	Choose from Address* , Text , Number , and Date . If the data in the field does not match the data type, the document is sent to the validation queue. Document Automation supports variations of the date format. * If you are configuring a learning instance with a user-defined document type, the form fields include the address data type, which extracts the entire structure of an address.
Required	Select one of the following: <ul style="list-style-type: none"> • Required: Field cannot be empty. • Optional: Field can be empty or not exist in the document.
Default aliases	No action is necessary for this field. Document Automation assigns default aliases, which are hardcoded keywords, to standard fields to help with extraction.
Custom aliases	Additional keywords to help Document Automation locate the field. For example, add country or region-specific names for fields such as <code>VAT number</code> as an alias to an <code>Organization tax number</code> custom field. <hr/> Note: Custom aliases must be unique. They cannot duplicate the default alias of another field. Exception: Form fields can have duplicate custom aliases as the table fields and vice versa. <hr/>
Validation rules	Depending on data type, create rules using patterns, formulas, lists, and statements such as starts or ends with. Formula validation Pattern validation

11. Click **Create**.

When a new learning instance is created, the Control Room creates a folder with the same name as the learning instance in the **Automation > Document Workspace** folder. The folder contains two bots (extraction and download), a process, and a

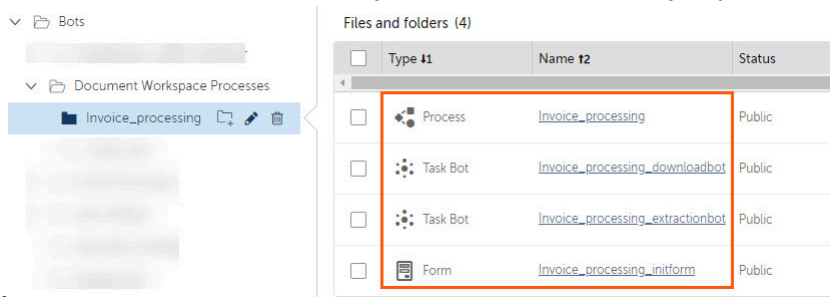

form.

- **Process:** Manages the process using if/else scenarios through which Document Automation extracts data from uploaded documents, assigns documents to users for validation, and downloads the extracted data. To learn more, see [About the AARI process in Document Automation](#)
- **Extraction bot:** Extracts data from defined fields in the uploaded documents.
- **Download bot:** Downloads the extracted data to a specific folder on the device or shared network.
- **Form:** Defines the input parameters that are sent to the process. Input parameters include the learning instance name, uploaded file, and output file path.

Upload documents to the learning instance, fix validation errors, and verify the extracted data: [Process documents in Document Automation](#)

Data extraction in Document Automation

Understand how the system improves extraction accuracy through user-provided changes in the Validator.

Improving extraction accuracy through validation

When a learning instance is created, the user has the option to enable this feature to send feedback to the learning instance based on user-provided changes in the Validator. In Document Automation, learning instances running in production mode can continuously "learn" whenever a user resizes or relocates the extraction region in the Validator.

Note: This feature is available only for Automation Anywhere pre-trained models.

The following graphic provides a visual overview of the process by which learning instances continuously receive feedback from validation:

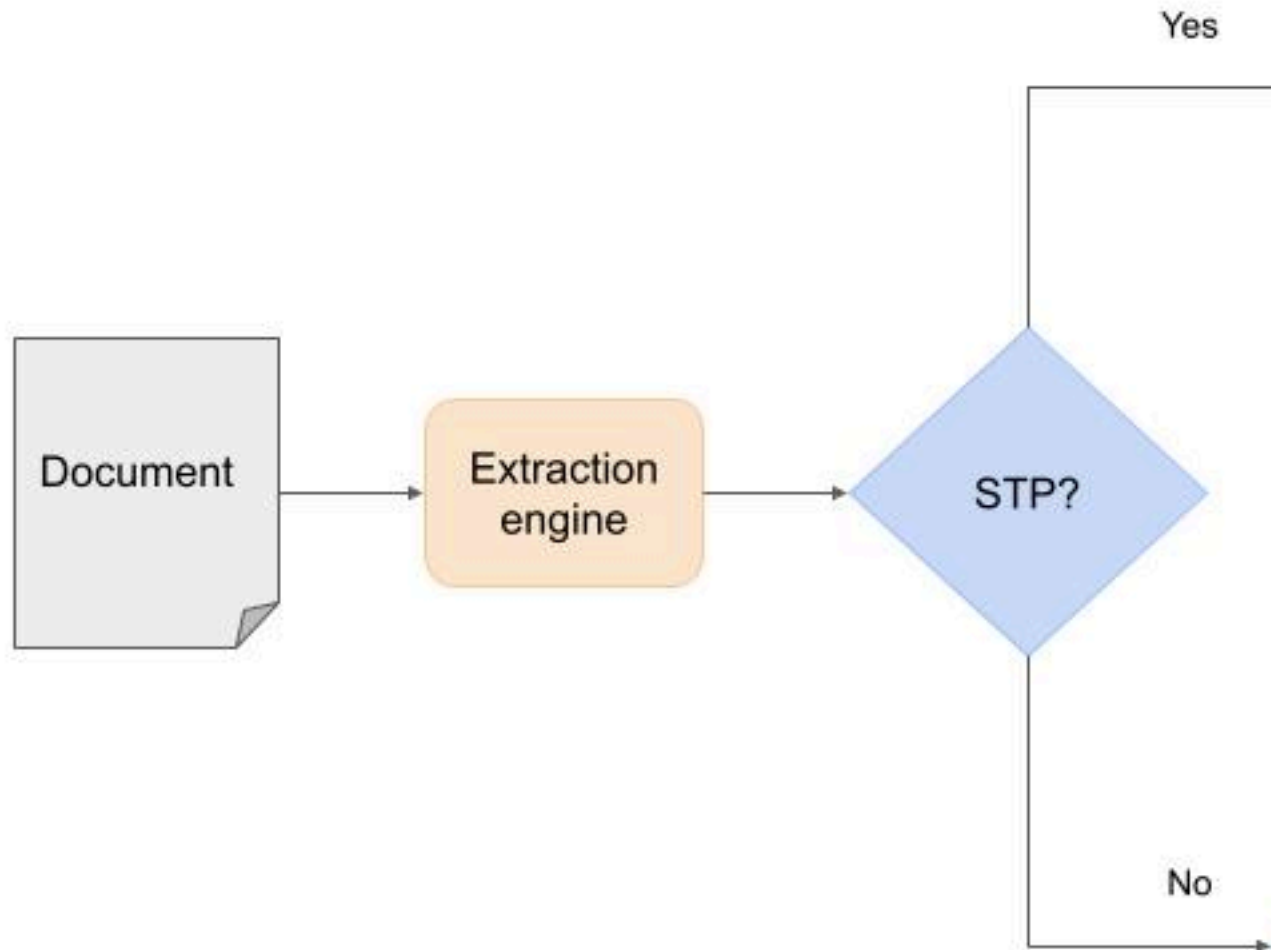

1. An uploaded document passes through the extraction engine.
2. If the learning instance successfully extracts the data, the document is added to the straight-through processing (STP) count and the extracted values are downloaded to a file in the `Success` folder.
If the learning instance can not extract the data, the system evaluates whether the document contains an unfamiliar layout.
3. If the learning instance does not recognize the document layout (new layout), the document is sent for manual validation where the user "teaches" the learning instance how to extract the data by setting the extraction region.

4. The extracted values are downloaded to a file in the `Success` folder and the changes are collected in a feedback file, which is sent to the feedback database.

Note:

- Feedback is only collected when the user changes the extraction region. If the user manually inputs text, the system does not collect feedback.
- The feedback file only contains data on the field location to improve extraction accuracy for subsequent documents.

If the learning instance recognizes the cluster, it retrieves previous feedback from the feedback database and uses it to extract data.

Using validation feedback to extract specific values in a table

As of Automation 360v.27, you can train a learning instance to extract data from a cell that contains more than one field.

For example, if a product description column also includes item number, you can outline the item number in the Validation interface. When the learning instance processes subsequent documents, it will extract the item number and ignore the product description.

Follow this process to configure a learning instance to extract specific values from a cell:

1. Create a learning instance using an Automation Anywhere pretrained model and select the option to send validation feedback: [Create a learning instance in Document Automation](#)
2. Upload a sample document: [Process documents in Document Automation](#)
3. In the Validator, locate the field and redraw the box to only surround the values that you want to extract.
4. After you click **Submit**, the information on the new extraction region is sent to the feedback database.
5. Upload more documents to test the accuracy of extraction. When you are satisfied with the results, proceed to preparing the learning instance to run in production: [Publish the learning instance](#)

How Document Automation identifies new layouts

Document Automation extraction is based on object detection. During document processing, the extraction engine identifies objects, or key-value pairs of the field and associated value. The engine creates a "fingerprint" of the document, which stores the sequence of the objects and each object's location in the document.

When a document is processed, if the engine recognizes the keys and their locations, the document is classified and extracted based on that existing fingerprint. Otherwise, the engine saves a new fingerprint of the keys and their locations.

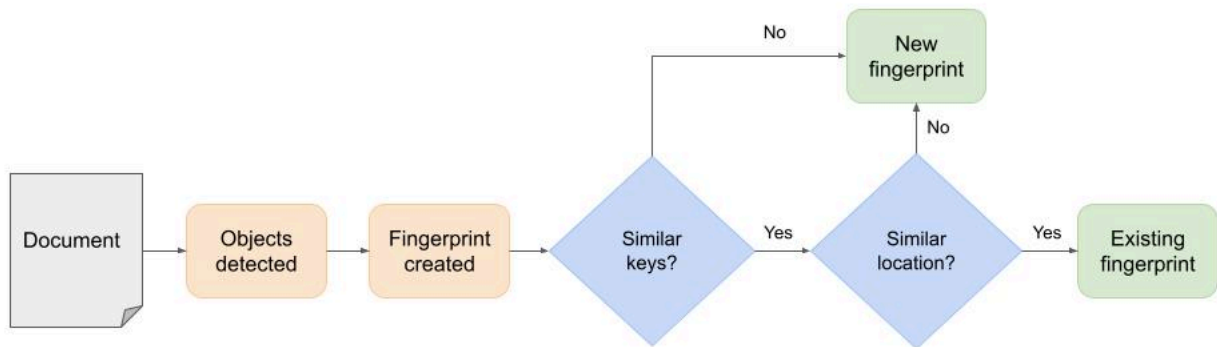

About the AARI process in Document Automation

Document Automation uses Automation Anywhere Robotic Interface technology to manage the end-to-end document extraction process. When you create a learning instance in Document Automation, the system also creates an AARI process. Review the following guide to understand the logic.

When a learning instance is in production, each incoming document creates a new request, which triggers the extraction process. If a document requires manual validation, AARI creates a validation task and assigns it to a validation team.

After the documents are processed, the **Download bot** downloads the extracted data to a file in the `Success` folder.

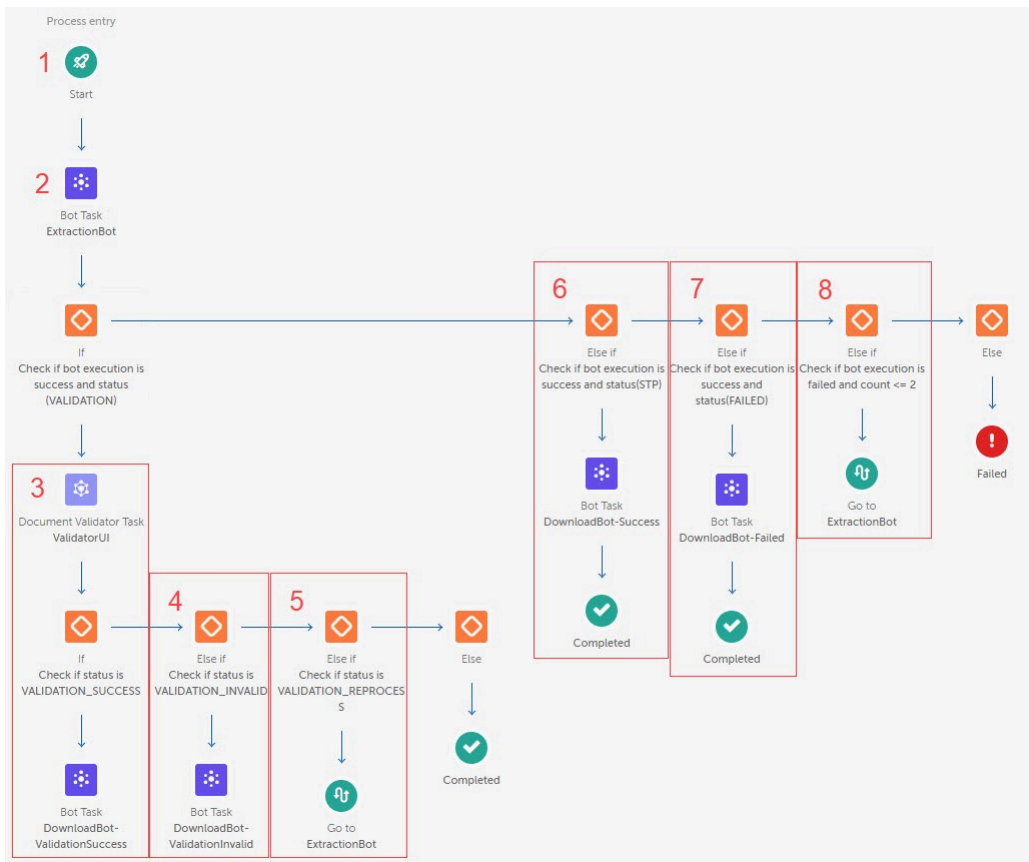

1. **Start:** The AARI form that defines the inputs, such as the learning instance name, uploaded documents, and output folder.
2. **Bot Task ExtractionBot:** Executes the RPA bot that processes input documents to extract data from them.
3. **Document Validator Task:** Opens the Validation user interface where the user can manually validate the fields in the document.
4. **Documents require validation:** The ExtractionBot tried to process the documents then sent the documents for validation, the documents were successfully validated, and the DownloadBot downloaded the extracted data to the `Success` subfolder.
Request status = `VALIDATION_SUCCESS`
5. **Invalid documents:** The previous process was interrupted at validation, where a user marked certain documents as **invalid**. These documents were downloaded to the `Invalid` subfolder.
Request status = `VALIDATION_INVALID`
6. **Reprocessed documents:** The previous process was interrupted at validation because the user clicked **Reprocess**. Documents were sent back to the ExtractionBot for reprocessing.
Request status = `VALIDATION_REPROCESSING`
7. **Documents are successfully processed:** The ExtractionBot successfully processed the documents, no documents required validation, and the DownloadBot downloaded the exacted data.
Request status = `success` and `STP`
8. **Processing failed:** The ExtractionBot failed to process the documents (for example: invalid format or could not read the file) and the file is saved to the `Failed` subfolder
Request status = `FAILED`

9. **Deployment failed:** The Control Room failed to deploy the ExtractionBot (for example: lost server connection). The Control Room makes three attempts.



Warning: We do not recommend deleting the process. If you unintentionally delete a process associated with a learning instance, do the following steps to recover the process:

1. Navigate to **Manage > Learning Instances** and mouse over the actions menu to the right of the learning instance.
 2. Click **Export**.
 3. Mouse over the actions menu to the right of the learning instance and click **Delete**.
 4. Click **Import** at the top of the page.
 5. Click **Browse** and select the .dw file you exported.
 6. When prompted, click **Overwrite** to generate a new process for the learning instance.
-

Process documents in Document Automation

Upload sample invoices to test the learning instance, verify the extracted data, and fix validation errors.

- If you have not done so already, [Create a learning instance in Document Automation](#).
- Verify that your device is connected to the Control Room: [Install Bot Agent and register device](#)
- If the learning instance uses a Google Document AI model **and you did not purchase Google Document AI licenses through Automation Anywhere**, you must provide your Google Document AI credentials to the **Extraction bot**. See [Configure key for Google Document AI](#)
- If the learning instance uses an Automation Anywhere model, ensure that each file is 50 MB or less.

If the learning instance uses a Google Document AI model, ensure that each file is 20 MB or less, with a maximum of 5 pages.

- Ensure that the sample documents are in one of the following supported document types:
 - PDF
 - JPG
 - JPEG
 - PNG
 - TIF
 - TIFF
- The default output format for the extracted data is CSV file. To change the output to JSON, see [Change output format from CSV to JSON](#).

Perform the following steps to upload sample invoices to the learning instance to test the data extraction capabilities of the learning instance.

1. Upload documents to test the learning instance:

See these steps in a video:

<https://fast.wistia.net/embed/iframe/1yr07vc2ua>

a) Click **Process documents**.

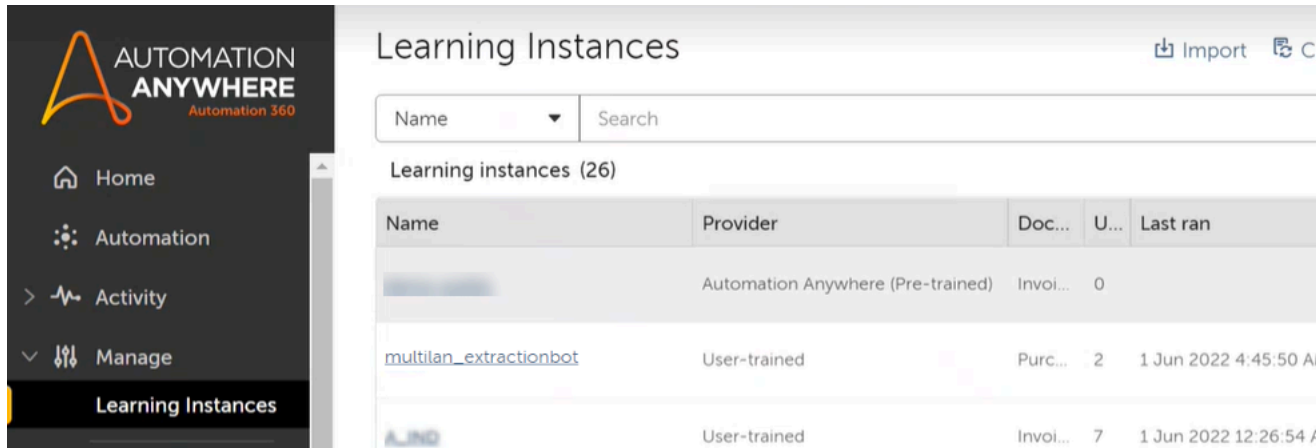

The screenshot shows the Automation Anywhere interface. On the left is a navigation menu with options: Home, Automation, Activity, Manage, and Learning Instances (selected). The main area displays the 'Learning Instances' table with 26 instances. The table has columns: Name, Provider, Doc..., U..., and Last ran. The instance 'multilan_extractionbot' is highlighted in blue. It is a 'User-trained' instance with 2 documents and a last run time of 1 Jun 2022 4:45:50 A.

Name	Provider	Doc...	U...	Last ran
[blurred]	Automation Anywhere (Pre-trained)	Invoi...	0	
multilan_extractionbot	User-trained	Purc...	2	1 Jun 2022 4:45:50 A
[blurred]	User-trained	Invoi...	7	1 Jun 2022 12:26:54 A

b) In the **Process Documents** window, click **Browse** to select the files to upload.

c) In the **Download data to** field, enter the file path that will hold extracted data.

When the process runs, it creates the following three folders in the provided file path:

- **Success:** Contains the extracted data in the specified format (CSV or JSON).
- **Invalid:** Holds documents marked invalid.
- **Failed:** Holds documents that could not be processed.

You can provide an output folder path based on one of the following options:

- **Option 1:** The local device path if you have set up document processing and validation on the same device.
This option is typically used when you are testing the learning instance.
- **Option 2:** The shared folder path if you have set up distributed validation on separate devices.
This option is typically used for published learning instances. For example, `\10.239.192.60\Sharepath\Output`.

d) Click **Process documents**.

The Bot Runner window appears. The window disappears when the documents are done processing. Refresh the **Learning instances** table to see the updated metrics.

If there is a value next to the **Validate documents** link, you must manually validate the document fields. Otherwise, proceed to step 3.

2. Fix the validation errorsa) Click **Validate documents**.

The AARI Task Manager opens in a new tab, with the first failed document in queue. For an introduction to the Validator user interface, see [Using the AARI Task Manager Validator for Document Automation](#).

b) Review each field to verify the data type and extracted value.

Document Automation supports the following data types: text, number, time, and check box

Alternatively, from the drop-down list on the right panel, you can select **Show fields that need validation**.

Note: When documents are awaiting validation, if you edit the learning instance, click **Reprocess** to reattempt extraction.

Reprocessing documents does not affect the uploaded documents metric.

c) Update the fields with errors.

Click the field or draw a box around the values that you want to extract.

For Automation Anywhere pre-trained models, you can configure the learning instance to extract specific values in a field and ignore others. For more information, see [Using validation feedback to extract specific values in a table](#).

<https://aa2019packagesdkfordocumentation.s3-us-west-2.amazonaws.com/videos/validation-iqbot.mp4>

- To skip a document without correcting errors, click **Skip** to proceed to the next document in the validation queue.
- To remove a document that cannot be processed, click **Mark as Invalid**.

d) After you make the necessary corrections, click **Submit** so that the document can finish processing.

The next document in queue appears. When all the documents are corrected, the system displays a message stating that no more tasks are available.

e) Close the tab to return to the **Learning Instances** page.**3.** Verify the output results:a) Open the file in the `SUCCESS` folder that contains the extracted data and review the results to ensure that it matches your use case.b) Optional: Review the **Learning Instance** dashboard.

The dashboard displays the total number of uploaded documents and the number of documents pending validation.

If the learning instance repeatedly cannot find a field or if characters are not correctly recognized (such as the letter "l" extracted as the number "1"), you can try changing the OCR to Google Vision OCR.

Build a bot that uploads documents from a source folder to the learning instance. Then, publish the learning instance assets (process, form, and bots) to the public repository so that the learning instance can be used in public mode to extract data from real documents, and validators can manually validate documents: [Publish the learning instance](#)

Related concepts

[Extracting data from check boxes](#)

Document Automation supports check box extraction for connected learning instances. The output varies depending on the selected data format.

Change output format from CSV to JSON

Data from successfully processed documents is available as a CSV file, by default. Change the output format by editing the download data action **before you begin uploading documents**.

If you have not done so already, [Create a learning instance in Document Automation](#).

To change the output format to JSON, perform the following steps:

1. Navigate to **Automation > Private tab > Document Workspace** and click the folder with the same name as the learning instance to configure the assets.
2. Open the process.

You must update the output format for `DownloadBot-ValidationSuccess` and `DownloadBot-Success`:

3. Click `DownloadBot-ValidationSuccess` and locate the **DocumentType** field.
4. Change `OUTPUT_CSV` to `OUTPUT_JSON`.
5. Repeat steps 3 and 4 to change the output format for `DownloadBot-Success`.
6. Click **Save**.

Upload documents to the learning instance: [Process documents in Document Automation](#)

Formula validation

Use basic arithmetic, comparative, logical, and functional operations.

Tip: We recommended using functional operators instead of mathematical operators when validating fields and tables for better accuracy.

When formulating an expression remember the following:

- All function names must be in capital letters.
- All formulas must result in either a true or false validation.
- Field and column names are case sensitive when used within formulas. If field is defined as *Qty* in design, using *qty* or *QTY* in formula results in an invalid formula.
- For variable declaration or manipulation, ensure not to use certain keywords that are reserved for formulating an expression, including SUM, SUB, DIV, MUL, COLSUM, IF.

Mathematical Operators

Operations	Description	Syntax
+	Addition	Field/Column_Name1 + Field/Column_Name2
-	Subtraction	Field/Column_Name1 - Field/Column_Name2
*	Multiplication	Field/Column_Name1 * Field/Column_Name2
/	Division	Field/Column_Name1 / Field/Column_Name2

Comparative Operators

Operations	Description	Syntax
==	Equal To	[Current Field/Column Name] == [expression comprised of one or more field/column name or fixed numeric values] For example, AMOUNT == MUL(QUANTITY, UNIT_PRICE)
>=	Greater than or Equal To	[Current Field/Column Name] >= [expression comprised of one or more field/column name or fixed numeric values] For example, TOTAL_BILL_AMOUNT >= AMOUNT_PAID
<=	Less than or Equal To	[Current Field/Column Name] <= [expression comprised of one or more field/column name or fixed numeric values] For example, AMOUNT_PAID <= TOTAL_BILL_AMOUNT
>	Greater Than	[Current Field/Column Name] > [expression comprised of one or more field/column name or fixed numeric values] For example, BILL_AMOUNT > 0
<	Less Than	[Current Field/Column Name] < [expression comprised of one or more field/column name or fixed numeric values] For example, DISCOUNT_PERCENTAGE < 100
!=	Not Equal To	[Current Field/Column Name] != [expression comprised of one or more field/column name or fixed numeric values] For example, DEBIT_AMOUNT != 0

Logical Operators

Operations	Description	Syntax
&&	And: Field/Column is valid if all conditions are true	<p><Current Field/Column Name> <operator 1> <expression 1> && <Current Field/Column Name> <operator 2> <expression 2></p> <p>For example, DISCOUNT_PERCENTAGE >= 0 && DISCOUNT_PERCENTAGE <=100</p>
	Or: Field/Column is valid if any one of the given conditions is true	<p><Current Field/Column Name> <operator 1> <expression 1> <Current Field/Column Name> <operator 2> <expression 2></p> <p>For example, DISCOUNT_PERCENTAGE >= 0 DISCOUNT_PERCENTAGE == 'Net'</p>
!	Not: Converts a true expression to false and also the other way round	<p>!<expression></p> <p>For example, !(AGE < 18) ==> valid when AGE is not less than 18</p>

Functional Operators

Operations	Description	Syntax
SUM	Summation: gives result of addition of one or more field/column/fixed-number values	<p>SUM(n1,n2,...,nN)</p> <p>For example, SUM(SUB_TOTAL, SERVICE_TAX, EDUCATION_CESS) ==> equivalent to SUB_TOTAL plus SERVICE_TAX plus EDUCATION_CESS</p>
SUB	Subtraction: gives result of subtraction of one or more field/column/fixed-number values from the first specified value	<p>SUB(n1,n2,...,nN)</p> <p>For example, SUB(SUB_TOTAL, TOTAL_DISCOUNT, ADJUSTMENTS) ==> equivalent to SUB_TOTAL minus TOTAL_DISCOUNT minus ADJUSTMENTS</p>

Operations	Description	Syntax
MUL	Multiplication: gives result of multiplication of one or more field/column/fixed-number values	MUL(n1,n2,...,nN) For example, MUL(QTY_IN_BOX, UNIT_PRICE, SHIPPED_BOXES) ==> equivalent to QTY_IN_BOX multiply-with UNIT_PRICE multiply-with SHIPPED_BOXES
DIV	Division: gives result of division of one or more field/column/fixed-number values from the first specified value	DIV(n1,n2,...,nN) For example, DIV(AMOUNT, SHIPPED_BOXES, UNIT_PRICE) ==> equivalent to AMOUNT divide-by SHIPPED_BOXES divide-by UNIT_PRICE
COLSUM	Sum of a given Column in a table: gives result after evaluating given expression for each row of specified table and adding them all together	COLSUM("<table-name>", "<expression to evaluate for each row of specified table- name>") For example, FINAL_TOTAL == COLSUM("LINE_ITEMS", "MUL(QTY, UNIT_PRICE)") Say there are 3 rows for table LINE_ITEMS, then FINAL_TOTAL should be equal to MUL(QTY1, UNIT_PRICE1) + MUL(QTY2, UNIT_PRICE2) + MUL(QTY3, UNIT_PRICE3) where, QTY1 is QTY value in row 1, similarly UNIT_PRICE1 is UNIT_PRICE value in row 2, and so on for other rows as well.

Pattern validation

A pattern defines an acceptable format for date, number, or text fields. Reference the tables below for common examples:

Text

Field	Pattern	Notes	Description
Email	^([a-z0-9_\. -]+)@([\da-z_\. -]+)\.([a-z\.\.]{2,6})\$	This regular expression validates emails like john@ado.com.	The Email field supports regular expressions.

Field	Pattern	Notes	Description
Phone Number	<code>^\((?\+?[0-9] * \)?)?[0-9_\- \\(\)]* \$</code>	This regular expression validates phone numbers like (+64) 38 3235393.	The Phone Number field supports regular expressions.
Website	<code>^([a-zA-Z0-9]+(\.[a-zA-Z0-9]+)+).* \$</code>	This regular expression validates websites like www.domain.com.	The Website field supports regular expressions.
Number string	<code>^[0-9]{1,45}\$</code>	This regular expression validates a string with numbers 0 - 9 and limit length to 45.	The Number string field supports regular expressions.
Alpha-numeric	<code>^[A-Za-z0-9_@./ #&+;+-]* \$</code>	This regular expression validates a string containing alphanumeric values like INV-001.	The Alpha-numeric field supports regular expressions.

Number

Field	Pattern	Notes	Description
Number string	<code>^[0-9]{1,45}\$</code>	This regular expression validates a string with numbers 0 - 9 and limit length to 45.	The Number string field supports regular expressions.

Connect learning instance

Connect to a learning instance in Automation 360 IQ Bot to process documents in that learning instance using the Document Automation workflow.

To perform this task, you must have one of the following roles:

- **AAE_IQ Bot Admin**
- **AAE_IQ Bot Services**
- A custom role with the **Connect learning instance** permission

Open the Document Automation and Automation 360 IQ Bot environments on the same device.

When you connect a learning instance that was created in Automation 360 IQ Bot, the system creates learning instance assets (RPA bots, AARI process, and form) to enable the learning instance to start processing documents in Document Automation.

Note:

- This feature is available only for Document Automation customers. It is not available in Community Edition.
- The Automation 360 IQ Bot environment must be associated with the Control Room where Document Automation is installed. In addition, Automation 360 IQ Bot must be in a version that is compatible with the Control Room.

- You can connect one learning instance at a time.

A connected learning instance can extract data from check boxes if your device is configured with the Microsoft Visual C++ 2019 Redistributable package: [Extracting data from check boxes](#)

1. Login to the Control Room as the `Admin` user. Navigate to **Manage > Learning Instances**. Click **Connect learning instance**. This takes you to **Connect Learning Instances from IQ Bot classic** page which contains a list of Automation 360 IQ Bot learning instances.
2. Select the learning instance from version Automation 360 IQ Bot to connect with. Move it from left to right. Click **Connect**.

Connect Learning Instances from IQ Bot classic

You can edit the Learning Instance only in IQ Bot

▼

🔍

Learning Instances (4) (1 selected) ↻

	Name	Document type
<input checked="" type="radio"/>	multilan_extractionbot	Invoices
<input type="radio"/>	S_MS	Purchase Orders
<input type="radio"/>	Z_T1	Purchase Orders
<input type="radio"/>	INT1	Invoices

Selected (0)

	Name
<input type="radio"/>	

→

←

Click here to move learning instance left to right

The newly-connected learning instance appears in the Learning instances table in private mode.

Note: The value in the Provider column indicates whether a learning instance was connected from Automation 360 IQ Bot or created in Document Automation.

- For a connected learning instance, the Provider column value is **User-trained**.

- For a learning instance created in Document Automation, the Provider column value is **Automation Anywhere (Pre-trained)**.

Note: You must maintain the Automation 360 IQ Bot server because it stores the configuration and training data for the connected learning instance.

- A connected learning instance can only be edited in Automation 360 IQ Bot. To edit the learning instance after connecting it, click the name in the Learning instances table and you will be redirected to open the learning instance in Automation 360 IQ Bot in a new window.
- To upload documents for processing, click **Process Documents**. [Process documents in Document Automation](#)

Extracting data from check boxes

Document Automation supports check box extraction for connected learning instances. The output varies depending on the selected data format.

A check box is a user interface object that allows you to make a binary choice - select or leave unselected. Document Automation supports extracting data from check boxes or radio buttons marked with a tick, cross, or dot. In addition to square check boxes and round radio buttons, Document Automation supports triangle and rhombus outlines.

Document Automation supports the extraction of group check boxes from connected learning instances. For more information on group check boxes, see [Extract data from check box groups in Automation 360 IQ Bot](#).

Note: To enable check box detection, you must install the Microsoft Visual C++ 2019 Redistributable package on the Bot Runner device where the documents are processed. [Download Microsoft Visual C++ Redistributable](#)

How the data is output

The possible output values are Yes, No, or No Checkbox Found. The output format depends on the format you selected [Change output format from CSV to JSON](#).

Note: Regardless of the document language, the output values are always in English.

Publish the learning instance

Check-in the process associated with the learning instance. Then, build a bot that uploads documents from a source folder to the learning instance and check it in to the public repository. Finally, deploy the process and bots to unattended Bot Runner devices to begin processing documents in real time.

For Bot Runner devices with a Windows 2012 server-based operating system:

1. Download and install the Windows Essential Media Pack from Microsoft.

2. Install the Media Foundation feature from the Windows Server Manager.
1. Publish the process.
 - a) Navigate to **Automation > Private tab > Bots > Document Workspace processes** and select the folder with the same name as the learning instance.
 - b) Mouse over the vertical ellipses to the right of the process to open the actions menu and click **Check in process**.
The **Check in Process** window opens with the bots and form auto-selected to also be checked in.
 - c) In the **Check in Process** window, add your comment and click **Check in**.
The process appears in the same folder structure in the public workspace.

See these steps in a video:

<https://fast.wistia.net/embed/iframe/Iyouw132o4>

2. Build the `Extraction-Scheduler` bot to automate uploading documents to the learning instance:
[Build a bot to upload documents to Document Automation](#)
3. Publish the `Extraction-Scheduler` bot.
 - a) Locate the `Extraction-Scheduler` bot in the private tab.
 - b) Mouse over the triple ellipses to the right of the bot to open the menu and click **Check in Task**

Private bots and files cannot be viewed by other people. If a bot or file has been checked out from the Public tab, other people, but cannot be edited.

The screenshot shows the Automation Anywhere interface. On the left, a sidebar titled 'Folders' has 'Bots' selected. The main area shows a search bar and a list of 'Files and folders (10)'. The list has columns for 'Type' and 'Name'. The items listed are:

	Type	Name
<input type="checkbox"/>	Folder	IQ Bot Processes
<input type="checkbox"/>	Folder	Sample bots
<input type="checkbox"/>	Task Bot	multilan_extractionbot

bot.

The **Check in Task bot** page opens with the bot auto-selected.

- c) Add a comment and click **Check in**.
4. Login as the `Document Automation Admin` user to deploy the process and bots to unattended Bot Runner devices: [Deploy the learning instance assets](#)

Once the process and `Extraction-Scheduler` bot are deployed, documents in the specified folder are uploaded to Document Automation, and Document Automation either extracts data from the documents or sends the documents for validation.

Navigate to **Activity > In progress** to see the status of the running bots.

Build a bot to upload documents to Document Automation

Build a bot to upload documents to a specific learning instance for processing and extraction.

- Ensure you have the name of the destination learning instance.
- If you have an adequate amount of Bot Runners connected. For instructions on connecting a Bot Runner, see step 5 of [Set up your Document Automation environment](#).

Note: You need a dedicated Bot Runner for this bot and additional Bot Runners for the `extraction` and `download` bots, depending on the average number of pages in the documents. Review the explanation below for more guidance on how many Bot Runners are needed.

- Decide on the scheduling interval for deploying this bot with a maximum interval of every thirty minutes.
- Determine the average number of pages in the documents awaiting upload.

This bot is necessary for end-to-end automation of the document extraction process. When deployed, the bot checks if there are enough Bot Runners to handle the documents, by comparing the number of files already uploaded against a calculated value. The calculation considers the number of Bot Runners, scheduling interval, and average number of pages in the documents.

Note: This step is important as it controls the number of documents being uploaded to ensure smooth processing and avoid overloading the Bot Runners, which might cause a time-out error.

To determine the number of Bot Runners needed, consider the following:

- One Bot Runner can process a single-page document in one minute.
- One Bot Runner can process a two-page documents in two minutes.
- One Bot Runner can process 1440 single-page documents in one day.
- Two Bot Runners can process two single-page documents in one minute.

Use this equation to determine how many Bot Runners are needed:

```
Number of Documents to Process per day * Average Number of Pages per
document / 1440 = Number of Bot Runners
```

Note: If the equation result is not an integer, you must round up to the next whole number to obtain an adequate number of Bot Runners. For example, if the equation result is 4.2, you will need 5 Bot Runners.

As an example, if you want to process 10,000 documents each day with an average of one page per document, you need seven Bot Runners:

```
10,000 documents * 1 page per document / 1440 = 7 Bot Runners
```

To build the bot, follow these steps:

1. Navigate to **Automation > Private tab** and click **Create a bot**.
Ensure you do not place the bot in the **Document Workspace** folder.
2. Provide a name for the bot, such as `Extraction-Scheduler`.

3. Create the following variables: *Create a variable*

Variable name	Description	Data type	Value
File_Count	Increments with each loop iteration to count the number of files uploaded for processing.	Number	0
Extraction_Device	Number of Bot Runner devices connected to the Control Room	Number	Enter the number of connected Bot Runner devices
Scheduler_Interval	Scheduling interval in minutes	Number	Enter the interval for which you will schedule this bot to run when you deploy it (minimum 2 min,maximum 30 min)
Average_Pages	Average number of pages per document		Enter the approximate average number of pages in the documents
FilesInFolder	Holds file name and extension	Dictionary	--
SourcePath	File path to the folder containing documents awaiting upload to Document Automation	String	Enter the file path
OutputPath	File path to the folder containing the extracted data and invalid or failed documents	String	Enter the file path where you want the extraction output

4. Insert a **Loop** action to iterate through all the documents in a specific file path.

- a) Double-click or drag the **Loop** action.
- b) Select the **For each file in folder** iterator.
- c) Insert the `SourcePath` variable into the **Folder path** field.
- d) Insert the `FilesInFolder` variable into the **Assign file name and extension to this variable** field.

5. Insert an **If** action to compare the number of documents uploaded for processing to the number of Bot Runner devices multiplied by a scheduling interval and divided by the average number of pages.

Note: You must include this equation to limit the number of files uploaded for processing at one time to ensure that the Bot Runners are able to process the documents.

- a) Drag the **If** action into the **Loop** container.
 - b) Select the **Number** condition.
 - c) Insert the `File_Count` variable into the **Source value** field.
 - d) Select the **Less than** operator.
 - e) Enter the following into the **Target value** field: `$Extraction_DeviceCount*$Scheduler_Interval$/$Average_Pages$`
6. Insert **If: Else** and **Loop: Break** actions to end the loop if the condition is not met:
- a) Drag the **If: Else** action beside the **If** action in the **Loop** container.
 - b) Drag the **Loop: Break** action into the **If: Else** container.
7. Insert an error handling mechanism to log any possible errors:
- a) Drag the **Error handler: Try** action into the **If** container.
 - b) Drag the **Error handler: Catch** action beside the **Error handler: Try** action.
 - c) Drag a **Delay** action below the **Error handler: Catch** action.
 - d) Set a delay of 10 seconds.
8. Configure actions to upload documents to the process associated with a specific learning instance.
- a) Drag the **AARI Web: Create a request** action below the **Error handler: Try** action.
 - b) Mark the **Set LearningInstanceName** option and provide the name of the learning instance where to send the documents.
 - c) Mark the **Set InputFile** option and enter `$SourcePath$/$FilesInFolder{name}$. $FilesInFolder{extension}$`.
 - d) Mark the **Set InputFileName** option and enter `$FilesInFolder{name}$. $FilesInFolder{extension}$`.
 - e) Mark the **Set OutputFolder** option and enter `$OutputPath$`.
 - f) Drag the **Number: Increment** action below the **AARI Web: Create a request** action.
 - g) Insert the `File_Count` variable into the **Number** and **Assign output to variable** fields.
The **Number** action increases the value of `File_Count` by one each time a file is uploaded to the learning instance. As long as the value in `File_Count` is less than the total in the equation you entered in step 5, the bot can run another loop iteration to upload another document to the learning instance.
9. Make a copy of the uploaded file to a different location on your desktop to keep track of which documents were successfully uploaded:
- a) Drag the **File: Copy Desktop file** action below the **Number: Increment** action.
 - b) Enter `$SourcePath$/$FilesInFolder{name}$. $FilesInFolder{extension}$` in the **Source file** field.
 - c) Provide the folder path where to copy the files.

- 10.** Remove documents after they are uploaded to Document Automation so they do not get re-uploaded in the next iteration:
 - a) Drag the **File: Delete** action.
 - b) Enter `$SourcePath/$FilesInFolder{name}$.FilesInFolder{extension}$` in the **File** field.

- 11.** Click **Save**.

The completed bot should resemble the one in the image below:

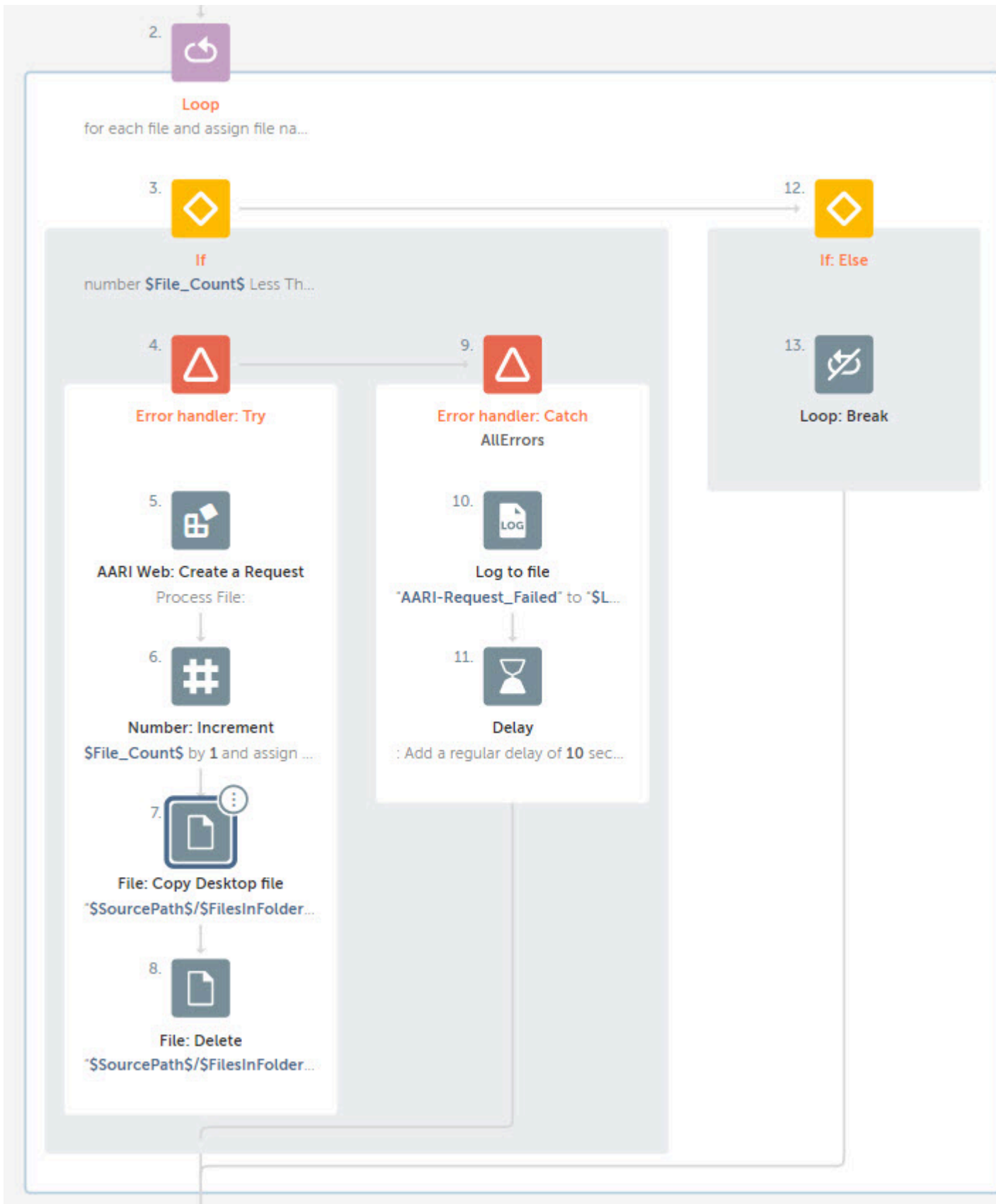

Publish the process and bot. See step 3 of *Publish the learning instance*

Deploy the learning instance assets

Deploy the process and RPA bots to the unattended Bot Runner devices, and assign the learning instance to a validation team. Here, you configure the learning instance assets to process documents in real time.

- The user who created the learning instance assets must check-in the process, form, and bots to the public repository. If you have not done so already, complete steps 1 and 2 of [Publish the learning instance](#).
- To deploy the learning instance assets, you must be an Admin user. See [Document Automation users](#).

1. Assign the a team of Validators to the process:.

- Open AARI by appending `/aari` to the Control Room URL.
- Navigate to **Manage > Process** and locate the process with the same name as the learning instance.
- Click the process to assign it to a team.
- Navigate to the **Request Creation** section and select the **by Bot** option.
- Navigate to the **Teams** tab and click the **Add** icon on the left side.
- Select the team and click **Add and save**.

2. Deploy the `Extraction-Scheduler` bot

See these steps in a video: <https://fast.wistia.net/embed/iframe/v93wkzjrbs>

- Return to the Control Room by removing `/aari` from the Control Room URL.
- Navigate to **Automation > Public tab** and locate the `Extraction-Scheduler` bot.
- Follow the steps to [Schedule a bot](#).
 - At the scheduling details section, select **Run repeatedly**.
 - Select the **Repeat every** option to schedule the bot on a recurring basis.

When you provide the desired interval and frequency, ensure that the interval matches the value in the `Scheduler_Interval` variable in the `Extraction-Scheduler` bot.

Note: If you are scheduling the bot to run starting today, you must repeat the steps two times to schedule the bot as follows:

- Schedule the bot with the desired start time for today, with an end time of 11:59pm on the same day.
- Schedule the bot to start tomorrow at 12:00am, with an end time of 11:59 on a future date.



Warning: If you do not follow this guidance, the bot will start running each day at the time you provided in the **Start time** field, instead of being scheduled to run for 24 hours of each day.

- When selecting a Bot Runner, deploy the `Extraction-Scheduler` bot to a different Bot Runner than the one running the process.

Note: A Bot Runner can run only one bot at a time. Ensure that you use separate Bot Runners for the process and the `Extraction-Scheduler` bot, so that the `Extraction-Scheduler` bot does not interfere with the `Extraction` and `Download` bots.

Once the process and `Extraction-Scheduler` bot are deployed, documents in the specified folder are uploaded to Document Automation, and Document Automation either extracts data from the documents or sends the documents for validation.

Navigate to **Activity** > **In progress** to see the status of the running bots.

Using the AARI Task Manager Validator for Document Automation

Document Automation uses Automation Anywhere Robotic Interface technology to manage the end-to-end document extraction process. Each incoming document creates a new request, which triggers the extraction process. If a document requires manual validation, AARI creates a validation task and assigns it to a validation team.

When you click the **Validate documents** link in the Learning instances page, the AARI Task Manager opens in a new tab, with the first failed document in queue.

Note: An empty page with a notification message appears in the following scenarios:

- If you are not assigned to any validation teams, and thus do not have access to learning instances.
 - If there are no files that require validation in the learning instances to which you have access.
 - If another user is working on the remaining file in the validation queue.
-

Tasks Table view Detail view **1**

▼ **6 filters applied**

My Completed tasks **2**

My Pending tasks

Unassigned tasks

Created date

Updated date

Status

Request title: test ×

Type: Validation ×

Task Created 3 of 3 ↓ ↑ **3**

163-8 Validation - RainbowTables2.pdf
📄 Pending

163-9 Validation - RainbowTables2 - Copy.pdf
📄 Pending

251-2 Validation - XYZ_CR_INV 1.pdf
📄 Pending

XYZ_CR_INV 1.pdf Page 1

XYZ Appliances

Remit to -
 XYZ Appliances
 Durham, NC 27600
xyzenterprises@gmail.com

Submit to -
 Maddison Quarter
 East Avenue
 NY, USA - 897654

Options:
 Services
 Products
 Both

Item Number	Description
24-301	Install (1) 4" Low Voltage Recessed Accent light to new control circuit
25-403	Install (2) 6" White Baffle Recessed Lights to new control circuit
26-101	Install Ceiling Fan Support Box to new control circuit

1. You can toggle between the Table and Detail views

Detail view: We recommend that you perform validation tasks in the **Detail** view because this view shows all the documents in the validation

queue side by side with the document that you are currently validating. Additionally, when you finish validating a document, the next document in the queue automatically opens.

Note: You can search for specific documents (tasks) in **Detail** view only.

Table view: Use the **Table** view see learning instance history. When you open a document from this view, the history for the learning instance that is processing this document appears in a pane on the left. Click the empty text field, then select the blue-bounded box in the document that contains the data to extract. After you select a box, the data is highlighted in yellow and a green outline appears, which you can resize or reposition to include all the data that you want to extract.

The Validator opens with certain filters enabled by default to show only the documents from a specific learning instance that need validation.

The documents that match the parameters you specified in the filters pane appear here.

You can switch between documents in the queue without completing validation for the current document.

Use the icons in the taskbar to hide the blue-bounded system identified regions, stack the document pane above the fields pane, or change the zoom levels.

Use the drop-down list to select between **Show all fields** to see all the document fields or **Show fields that need validation** to only show the fields that need your manual validation.

In the example above, the table fields **Item total** and **Quantity** require manual entry.

To insert or delete a row, hover over the ellipses to show the icons for adding or deleting table rows.

Skip a file without correcting the errors in the current document.

If the learning instance is edited while documents are awaiting validation, you must Reprocess the documents.

Removes the document from the validation queue and saves a copy of the document to the Invalid folder. Click here to mark a document as invalid, then select from the following reasons:

- Fields missing
- Tables missing

2. Filter the documents in your queue

3. Your documents queue

4. Customize your view

5. Toggle between the fields views

6. Fields awaiting validation are outlined in red

7. Add or delete a row

8. Skip to next file

9. Reprocess

10. Mark document as invalid

- Wrong values

For documents processed in a connected learning instance:

The Validator shows the group number for the document. If you are unsatisfied with the extraction results, you can retrain the learning instance in Automation 360 IQ Bot.

Validate documents in Document Automation

If a learning instance cannot extract data from a document (for example, blurry text, data does not match data type, or data is missing for a required field), it sends that document to the validation queue, where the `Validator` user manually provides the data.

The learning instance assets must be checked-in to the public repository.

The Validator is comprised of two panels with the document on the left side and the fields with extracted data on the right side.

In a window that is 1280 pixels or more, the panels are positioned side-by-side. Otherwise, the panel containing the fields and extracted data shifts below the panel containing the document, as demonstrated in this video:

<https://aa2019packagesdkfordocumentation.s3-us-west-2.amazonaws.com/videos/validator-scroll-iqbot.mp4>

Note: If a document contains tables with large number of rows or data fields (>1000), there might be a delay in the initial validation and the corresponding response time.

1. Log in as the `Validator` user.

2. From the Control Room home page, navigate to **Manage > Learning Instances**.

The Learning instances table displays details for each instance. The value in the **Validate documents** link indicates the number of documents awaiting manual validation.

3. Click **Validate documents**.

The AARI Task Manager opens in a new tab, with the first failed document in queue. For an introduction to the Validator user interface, see [Using the AARI Task Manager Validator for Document Automation](#).

4. Provide correct values to the fields that need validation.

See these steps in a video:

<https://fast.wistia.net/embed/iframe/m2au9ht6bf>

a) Select **Show fields that need validation** from the drop-down list in the right panel.

b) Click the field to extract.

c) In the document image, click the blue-bounded box containing the correct data or draw a box around the data you want to extract.

- To skip a document without correcting its errors, click **Skip** to proceed to the next document in the validation queue.
- To remove a document that cannot be processed, click **Mark as Invalid**.

5. After you make the necessary corrections, click **Submit** so the document can be processed and the extracted data downloaded.

The extracted values are saved to a file in the Success folder. The Validator shows the next document in queue. When all documents are corrected, the system displays a message stating that there are no more tasks available.

Export/Import learning instances

A user with the `IQ Bot Admin` role or with the `View and manage migration` permission can use the **Export** and **Import** buttons to move learning instances between Document Automation environments.

Export a learning instance

When you export a learning instance, a `.dw` file is downloaded to your desktop with the learning instance configurations, including the language, provider, and fields.

To export a learning instance, navigate to **Manage > Learning Instances** and mouse over the vertical ellipses to the right of the learning instance you want to export. Then, click **Export**.

Note: The process and bots associated with the learning instance are exported separately: [Export an AARI process](#) | [Export bots](#)

Import a learning instance

First, import the process and bots associated with the learning instance: [Import an AARI process](#). If you do not import the process, Document Automation will create a new process when you import the learning instance.

Note: Verify that the destination environment has the necessary licenses. See [Automation 360 licenses](#).

To import a learning instance:

1. Navigate to **Manage > Learning Instances** and click **Import** at the top of the page.
2. Click **Browse** to select the learning instance.

Note: If there is already a learning instance in this environment with the same ID number, the imported learning instance overwrites the existing one.

3. Select whether to pair the learning instance with an existing process or to create a new process.

<https://fast.wistia.net/embed/iframe/5gehd1sm0j>

Create standard form in Document Automation

Create a Standard Forms extraction model in the Control Room.

- Ensure your Control Room has the Document Automation Standard Forms (Number of pages) product license
- You must have the **AAE_IQ Bot Admin** or **AAE_IQ Bot Services** roles to complete this task
- Identify between five and fifteen training documents

1. In the Control Room, navigate to **Manage > Learning Instances** and click **Create model**. The **Projects** window opens in a new tab.
2. Click **Create project**.
3. Enter a name for the project, click **Browse** to upload documents to train the extraction model, and click **Create**.

4. Define the field tags:

- a) Click **Add new tag**.



- b) Enter a name for the tag. For example, Invoice no. or Invoice Date.

5. Define the table tags:

- a) Click **Configure table tag**.



- b) Enter a name for the table.
- c) For each column in the table, enter the name of the column under the **Column fields** section.

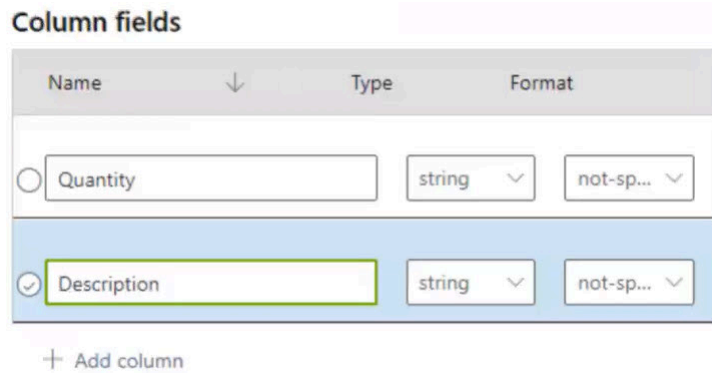

- d) When you are done entering the columns names, click **Save**.

6. Define the location of the data for each field:

- a) For the form fields, highlight the location of the data to extract, then click the respective field in the right panel.

<https://aa2019packagesdkfordocumentation.s3.us-west-2.amazonaws.com/videos/sf-define-field-location.mp4>

- b) For each row in the table, highlight the location of the data to extract, then click the respective table field on the right.

<https://aa2019packagesdkfordocumentation.s3.us-west-2.amazonaws.com/videos/sf-define-table-field-location.mp4>

- c) Click **Done**, then open the next document and repeat the steps to define the locations of the form and table fields.

7. Click the **Train model** icon, enter a name for the model, and click **Train**.



8. Click the **Analyze** icon, click **Browse for file**, and select a document to test the extraction model.

Next, [Create a learning instance for standard forms](#)

Note: You cannot edit an extraction model after associating it with a learning instance.

Using Document Automation for Standard Forms

Standard Forms are fixed format type documents that have a defined template, with little or no variation in the overall layout, and are typically official or legal forms, such as W-4 (Employee Withholding Certificate), income tax form, or sale deed.

The following is an overview of the end-to-end process to create the Standard Forms data model, configure the learning instance, and publish the learning instance to process documents autonomously, all within the Document Automation interface:

Note: Ensure you complete the steps to set up your Document Automation environment, which includes configuring users, roles, and devices, and connecting the Control Room with Automation Anywhere Robotic Interface: [Set up your Document Automation environment](#)

1. Evaluate your use case for Standard Forms.

[Evaluate your use case](#)

2. Set up and configure an extraction service.

[Set up extraction service](#)

3. Configure Document Automation for the selected extraction service.

[Configure Document Automation with Microsoft Azure Form Recognizer](#)

4. Build a data extraction model.

[Create standard form in Document Automation](#)

5. Create a learning instance with the Standard Forms data model.

[Create a learning instance for standard forms](#)

6. Upload documents to the learning instance to test the model, fix validation errors, and verify the extracted data.

[Process documents](#)

7. Build a bot that uploads documents from a source folder to Document Automation.

[Build a bot to upload documents to Document Automation](#)

8. Move Standard Forms learning instance across different Document Automation environments.

[Transfer standard forms learning instance](#)

9. Check-in the learning instance assets (process, form, and bots) to the public repository. Then, deploy the process and bots to unattended Bot Runner devices to begin processing documents in real time.

[Publish the learning instance](#)

10. Validate the processed documents for Standard Forms learning instance.

[Validate the uploaded documents](#)

Evaluate your use case

Consider the following parameters to determine if Standard Forms is right for your use case:

- The layout of your document remains the same across vendors.
- The positions of various data elements such as checkboxes, tables, and so on is fixed in your documents.
- You have documents where the values are independent of other data elements.
- Your document is available in a supported language. For more information, see [Azure Form Recognizer Supported Languages](#)
- Your document must have un-repetitive sections. In other cases, there must be a fixed number of such repetitive sections that do not vary between documents.
- Your documents contain tables that have the same number of rows and columns.
- The document layout remains the same within the same year, across different organizations.

Review extraction service

Once you have confirmed that the documents are standard forms, you can then plan the type of standard forms extraction service that fits your requirement.

The following technologies are available for processing standard forms:

Microsoft Azure Form Recognizer service

- Input documents can contain:
 - a lot of details and information and have a reasonable quality (>200 dpi)
 - checkboxes and radio buttons
 - handwritten content
 - signatures
 - tables

The input documents can also contain tables that span over a single page. However, if the standard forms contain table that span across multiple pages, the content extraction can fail.

- No section of the input document is repeated.
- Documents that contain transpose tables

Benefits of Microsoft Azure Forms Recognizer service

- Diverse standard form type documents can be processed.
- Auto detection feature can identify different types of tables such as header-less table, inverted tables, and so on.
- Good support for handwritten forms.

Set up extraction service

To extract content from Standard Forms, you must setup and configure Microsoft Azure Form Recognizer service.

1. Subscribe to Microsoft Azure service

Microsoft provides the Azure Form Recognizer service. This service enables you to build automated data processing software that can identify and extract specific content from documents. You must have Microsoft Azure subscription in order to access Azure resources (OCR, Form Recognizer), Automation Anywhere provides access to these resources through its subscription. Contact your Customer Success Manager (CSM) or Partner Enablement Manager (PEM) who will help you setup the services.

[Request access for Microsoft Azure resources \(OCR and Form Recognizer\) \(A-People login required\)](#)

2. Setup Microsoft Azure Form Recognizer service

For Cloud deployment

- If you have Automation Anywhere subscription, no additional configurations or changes are required.
- If you have Microsoft Azure subscription, review the following article to setup and configure your Microsoft Azure Form Recognizer for extracting content from standard forms.

[Setup Azure Form Recognizer and Storage \(Cloud\) \(A-People login required\)](#)

Configure Document Automation with Microsoft Azure Form Recognizer

Send an API request to connect Document Automation with the extraction service.

Note: You will need the following information:

- Authorization token. See [Authentication API](#)
- Microsoft Azure Form Recognizer endpoint
- Microsoft Azure Form Recognizer API key
- Microsoft Azure Blob storage URI

For Document Automation Cloud:

```
PUT <Cloud Host Url>/cognitive/v3/formrecognizer/config
Headers: X-Authorization - <IQBot Admin User Auth token >
Request Body:
{
  "formRecognizerApi": <Cognitive Service
Endpoint>,
  "formRecognizerKey": <Cognitive Service
apiKey>,
  "blobStorageSas": <Azure blob storage SAS Uri>
}
```

For Document Automation On-Prem :

```
PUT <On-Prem Machine ip> / Localhost:<port>/cognitive/v3/formrecognizer/
config
Headers: X-Authorization - <IQBot Admin User Auth token >
Request Body:
{
  "formRecognizerApi": <Cognitive Service
Endpoint>,
  "formRecognizerKey": <Cognitive Service
apiKey>,
  "blobStorageSas": <Azure blob storage SAS Uri>
}
```

Create a learning instance for standard forms

1. In the Control Room, navigate to **Create Learning Instances**.
The **Create Learning Instances** window opens in a new tab.
2. Add a name for the new learning instance to be created.
3. From the **Document Type** drop-down menu, select **Standard Forms**.

Note: The provider name is selected as **Microsoft Form Recognizer** by default.

4. For model selection, click **Browse** and search for a model using name or description filter.
5. Select your model and click **Next**.
6. To proceed further, you must select atleast one field:
 - Table
 - Forms

Note: Standard forms support multiple tables. However, Document Automation does not allow displaying multiple tables. Hence, the tables are displayed as **tablename:field name** under **Tables** tab.

7. Some other field attributes are as follows:

Option	Description
Field name	Enter a field name that begins with an alphabetical character (A-Z or a-z). In standard fields, the field name is hardcoded and cannot be changed.
Field label	Enter a user-friendly name to help validators. For example, you can rename <code>Organization tax number</code> to a localized name, such as <code>VAT number</code> . The field label does not affect extraction.

Option	Description
Confidence	<p>Set a threshold to reduce potential false positives.</p> <p>At the time of processing, the Document Automation engine assigns a score to each field in a document to indicate the certainty that the data was correctly extracted. If the document contains fields with a score that is lower than the confidence threshold, the document is sent to the validation queue.</p> <p>If you enter a high confidence threshold, more documents will be sent to the validation queue. If you enter a low confidence threshold, fewer documents will be sent to the validation queue.</p> <p>Supports values from zero to 100.</p>
Data type	<p>Choose from Address*, Text, Number, and Date.</p> <p>If the data in the field does not match the data type, the document is sent to the validation queue.</p> <p>Document Automation supports variations of the date format.</p> <hr/> <p>Note: If you are configuring a learning instance with a user-defined document type, the form fields include the address data type, which extracts the entire structure of an address.</p> <hr/>
Required	<p>Select one of the following:</p> <ul style="list-style-type: none"> • Required: Field cannot be empty. • Optional: Field can be empty or not exist in the document.
Validation rules	<p>Depending on data type, create rules using patterns, formulas, lists, and statements such as starts or ends with.</p> <p>Starts With and Ends With Pattern Lists Formulas</p>

8. Click **Create**.

When a new learning instance is created, the Control Room creates a folder with the same name as the learning instance in the **Automation > Document Workspace** folder. The folder contains two bots (extraction and download), a process, and a form.

Transfer standard forms learning instance

A standard forms learning instance is similar to the regular Document Automation learning instance that describes the data in a single document type, for example an invoice. It contains information such as the language used in the documents and the fields to extract.

- Ensure that the source and destination systems are running the same Document Automation version. Learning instances from different Document Automation versions cannot be imported because their database schema will not match.
- Back up your database before importing learning instances.
- Export the .dw file from the source Document Automation environment.
- Import the .dw file into the destination Document Automation environment.

Note: The incoming model of the source system must be available in the configuration of the target system.

Manage

As a Control Room administrator, create users and roles, and configure devices that access Automation 360. From the Control Room, you can also monitor and manage all activities to ensure a secure and seamless bot execution environment for your users.

Activity and audit log

Monitor and manage automations, such as bot execution, scheduled and event trigger activities using the Activity console (**Activity** from the left menu). You can also review and troubleshoot any failed activities using the Audit log console (**Administration** > **Audit log**).

See the following pages for more information:

- [Historical activity](#)
- [Scheduled activities](#)
- [Event triggers](#)
- [Audit log](#)

The following short video shows how to check your bot runs:

Users, roles, and permissions

You can configure users and roles (role-based access control or RBAC) to provide access to specific features and operations, based on their assigned roles. Creating users depends on whether the user is a non-Active Directory, Active Directory, or single sign-on (SSO) user from an IdP server.

- [Users](#)
- [Roles](#)
 - [Feature permissions for a role](#)
 - [Bot permissions for a role](#)
- [Credentials and lockers in the Credential Vault](#)

Devices and queues

A device is the machine through which a user connects to the Control Room to create or run bots. Manage devices that are registered to the Control Room from **Manage** > **Devices**.

A queue is a logical group of Work Items that are processed for automation by the Bot Runners from a pool based on priority selected in the device pool and sort criteria configured in the queue.

- [Devices](#)
- [Workload management](#)
- [Device pools](#)
- [Add queue, Bot Runner, and device pool](#)

Settings

After initial setup of the Control Room, you (as an administrator) might have to set up and edit some of the initial configurations to enable certain features. Go to **Administration** > **Settings** to configure and edit settings for bots, packages, devices, email, network, user authentication, security, Git repository, external key vault and so on.

The following image shows some of these

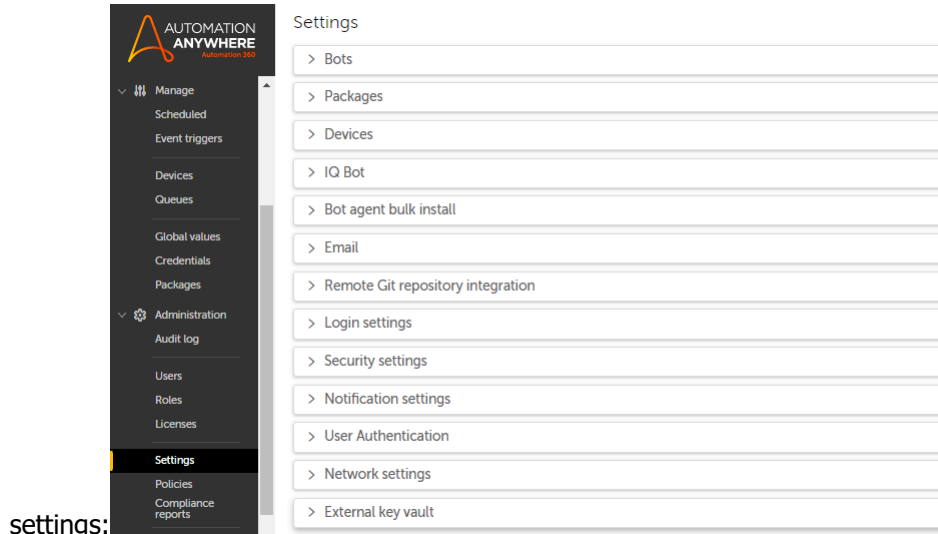

See [Settings](#).

See also

See the following pages for information on other features and settings:

- [Bot Lifecycle Management](#)
- [Code analysis](#)
- [CoE Manager](#)
- [Bot Store](#)

Related tasks

[Schedule a bot](#)

Schedule a bot to run at a specific time.

[Set up locker and assign credentials](#)

Create a role, credentials, and locker to share related sensitive values with a group of users, so they can use those values to build or run bots.

[Create a role](#)

As an administrator, you can configure roles with permissions to access features and perform operations such as create, edit, or delete a bot in the Control Room, and assign the role to a user.

[Create a user](#)

Create a user and assign their specific license based role.

[Set user device credentials](#)

To enable a device for running bots, set the local device credentials.

[Edit profile](#)

Manage user profiles.

[Installing additional licenses](#)

Upload new licenses to the Automation Anywhere Control Room to be distributed to users as required.

Activities

Monitor all ongoing automations and pause, stop, and resume them as required. Also, view the Bot Runner (attended or unattended) trigger deployments in queue.

In-progress activity

Depending on the permissions granted by administrators, as a user, you can view and manage bots and bot folders. With specific permissions, you can perform the following:

View everyone's activity from my folders

With run or schedule permissions on folders, you can view all bot activity started by other users from those folders. This will be a super set in the **View my activity** output.

Manage everyone's activity from my folders

With run or schedule permissions on folders, you can perform management activities, such as **Pause, Resume, and Stop** on all bot activity started by various users from those folders.

Based on the administrative permissions, you can apply various search parameters to monitor and find the required in-progress activities.

The following table describes various search parameters, their description, and possible values or examples to search the in-progress activities:

Parameter	Description	Possible values and examples
Status	Search for an activity based on its status.	<ul style="list-style-type: none"> • <i>Started</i> • <i>Active</i> • <i>Paused</i> • <i>Unknown</i> • <i>Paused for input</i> • <i>Pending execution</i> • <i>Queued</i>
Automation priority	Search for an activity based on the priority assigned to the automation.	<ul style="list-style-type: none"> • <i>Low</i> • <i>Medium</i> • <i>High</i>
Current action	Search for an activity based on the current action.	User-specified action name
Current bot	Search for an activity based on the name of a bot that is currently running.	User-specified bot name
Bot	Search for an activity based on the name of a bot.	User-specified bot name

Parameter	Description	Possible values and examples
Activity type	Search for an activity based on the activity type selected to run a bot.	<ul style="list-style-type: none"> • <i>Run Bot</i> • <i>Import queue files</i> • <i>Run bot with queue</i> • <i>Export bots</i>
Device	Search for an activity based on the device name on which it is running.	User-specified device name

Actions

You can pause, resume, stop, move, export, and refresh the activities or items by using the actions in the **Historical** page. Hover over the actions icon (vertical ellipsis) to enable and use the following actions:

Pause checked items

To pause the selected items

Resume checked items

To resume the selected paused items

Stop checked items

To stop the selected items

Move checked items to history

To stop the selected items

Move checked items to history

To move the selected activity from **In progress** to the **Historical** page.

Note: For Workload automation, you cannot **Stop**, **Pause/Resume**, or **Move checked items to history** if the TaskBot status is **Active** or **Unknown**.

Export checked items to CSV

To export selected items to a CSV file based on the following parameters:

- Filters
- Selection

Refresh table

To refresh the table with updated activity details

Customize columns

To show or hide specific columns



Attention: Multiple workload automation entries equaling the number of devices are shown on the **In-progress activity** page if the work items added to a queue are fewer than the number of devices available in a device pool. For details about a workload automation, see the **View queue details** page on the user device on which the workload automation is deployed.

Historical activity

You can search, view, and run previously created bots in the **Activity** > **Historical** page.

Search parameters

Based on the administrative permissions, you can apply various search parameters to monitor and find the required historical activities. The following table describes various search parameters, their description, and possible values or examples to search the historical activities:

Parameter	Description	Possible values and examples
Status	Search for an activity based on its status.	<ul style="list-style-type: none"> • <i>Completed</i> • <i>Failed</i> • <i>Stopped</i> • <i>Timed out</i> • <i>Unknown</i> • <i>Deploy failed</i> • <i>Run failed</i> • <i>Pending execution</i>
Item name	Search for an activity based on triggered item.	<p>A generic name in specif system format with combination of your bot name, date and time when you run the bot, and username by which you run the bot.</p> <p>For example, <i>recorder_Recorder_2.7.3-20220527-004608.2022</i></p>
Automation priority	Search for an activity based on the priority assigned to the automation.	<ul style="list-style-type: none"> • <i>Low</i> • <i>Medium</i> • <i>High</i>
Device name	Search for an activity based on the name of the device on which the activity is running.	User-specified device name
Bot name	Search for an activity based on the name of a bot.	User-specified bot name
User	Search for an activity based on the name of the user who created the activity.	User specified name

Actions

You can export, refresh, and customize the activity details in the **Activity** > **Historical** page.

Export checked items to CSV

To export selected items to a CSV file based on the following parameters:

- Filters
- Selection

Refresh table

To refresh the table with updated activity details

Customize columns

To show or hide specific columns



Attention: Multiple workload automation entries equal to the number of devices are shown on the **Historical activity** page, if the work items added to a queue are less than the number of devices available in a device pool. For workload automation details, refer to the **View queue details** page on the actual user device on which the workload automation was deployed.

View completed activity

You can view a list of all completed activities and corresponding information in the **Activity > Historical** page.

Completed activities

You can use the **Status** search parameter and view all the completed activities in the **Historical** page. You can export data in the table in CSV format, customize columns, and refresh the list in the table for the completed activities.

The retention period of bot execution information in the **Historical** page varies based on the deployment. The retention period for various deployments is listed in the following table:

Deployment	Retention period (Days)
Community Edition	30
Cloud	90
On-Premises	Unlimited (No automatic deletion)

Note:

- For On-Premises deployment, the bot execution information beyond the specified retention period is available in the audit log and these logs are not deleted.
- For Cloud deployment, see [Automation 360 Cloud Data Retention Policy](#).

Note:

- Specify search parameters for the same column using **OR** operator.
- Specify search parameters for different columns, the system searches using **AND** operator.

You can perform the following actions for a table of completed activities:

- Sort the column items in ascending or descending order.
- Drag-and-drop columns to move or change the column sequence.
- Resize the column width.

Activity details

The following table describes various details for completed activities:

Parameter	Description	Possible values and examples
Status	Search for an activity based on its status.	<i>Completed</i>
Item name	Search for an activity based on triggered item.	A generic name in specif system format with combination of your bot name, date and time when you run the bot, and username by which you run the bot. For example, <i>recorder_Recorder_2.7.3-20220527-004608.2022</i>
Automation priority	Search for an activity based on the priority assigned to the automation.	<ul style="list-style-type: none"> • <i>Low</i> • <i>Medium</i> • <i>High</i>
Device name	Search for an activity based on the name of the device on which the activity is running.	User-specified device name
Bot name	Search for an activity based on the name of a bot.	User-specified bot name
User	Search for an activity based on the name of the user who created the activity.	User specified name
Started on	The date and time when the activity was started.	For example, <i>19:01:24IST 2022-06-06</i>
Ended on	The date and time when the activity was ended.	For example, <i>19:01:40IST 2022-06-06</i>
Last modified	The time when activity was last modified.	For example, <i>57 minutes ago</i> or <i>3 weeks ago</i>
Modified by	The name of the user who changes the activity.	User-specified name

Actions

You can view any individual item using the following action:

View

View details of the completed activity.

Scheduled activities

Schedule bots to run on unattended Bot Runners from the **Scheduled** tab in the Control Room.

Overview

Edit, view, activate, deactivate, delete a schedule, export selected activity details to a CSV file, and search by activity name.

Perform the following actions on a column:

- Click a column to sort it in ascending or descending order.
- Use a drag-and-drop operation to move the column left or right.
- Move the mouse cursor to the end of the column and drag to re-size.

Schedule Actions

Perform the following tasks on an individual Schedule by moving your mouse over the **Actions** icon.

Schedule a bot

Schedule a bot to run at a specific time.

Ensure you are logged in to the Control Room as the administrator or a user with the following permissions:

- Schedule my bots to run
- Schedule permission at folder level for specific bots and their dependencies
- Access to run-as users (Bot Runners) that you can add to the schedule

Note: Automation will fail in the following cases:

- If any of the bot dependencies are missing.
- If you do not have folder privileges on the dependencies.
- If you do not have the scheduling permissions.

-
1. Navigate to **Manage > Scheduled**.
 2. Click **Run bot**.
 3. Click **Schedule bot**.

4. Add the scheduling details for the bot.

Note: The value of the **Start date** is always later than or equal to the current date. If the start date is the current date, the scheduled time cannot be less than the current time.

Option	Definition
Run once	<p>To run the bot at a specified time, enter the:</p> <p>Start date Default value is the current day.</p> <p>Start time Default value is roundup to the next half-hour.</p> <p>Time zone User's system time zone</p>
Run repeatedly	<p>To schedule a bot to run at specific time on a given day, enter the:</p> <p>Start date Default value is the current day.</p> <p>End date The default value field is blank.</p> <p>Start time Default value is roundup to the next half-hour.</p> <p>Time zone User's system time zone</p> <hr/> <p>Note:</p> <p>When the daylight saving is enabled and if the Start date is set for a schedule, the Start date is shown in the time zone to which it belongs to and not as per the user's current time zone. However, Next occurrence is shown in the time zone (user's system time zone) as per daylight saving time.</p> <p>For example, for a schedule created on 15th March in GMT time zone, the Start date is shown as Mar-15th which belongs to GMT time zone. Later, when daylight saving is ON and if you edit or view this schedule in the month of August in BST time zone, next occurrence is shown as current August month date which belongs to BST time zone.</p> <hr/>

- In the **Missed schedule setting** section, select **Redeploy the schedule again** to redeploy a schedule that was missed because of Control Room shut down.

When the **Redeploy the schedule again** option is selected, schedules missed because of Control Room shut down are automatically redeployed after the Control Room is restarted. An audit log entry is also added showing the **Event type** as `Schedule misfired`.

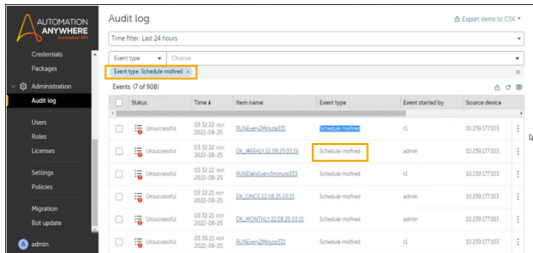

- Select the bot to schedule.
 - Latest version: Click **Latest version** tab to select the latest version of the bot.
 - Labeled version: Click **Production version** tab to select the labeled version of the bot.

Available bots are displayed along with any **Input values** and dependencies. If the production label option is selected for the parent bot, the corresponding dependent bots with the production label are also automatically selected. If any of the dependent bots do not have the production label applied, the latest version of the bot is selected.

- Select the Bot Runner user from the **Available bot runners** list. Use the following options to define the number of Bot Runners to use:
 - All bot runners:** Select to use all the selected Bot Runners.
 - Custom number of bot runners:** Select to customize the number of Bot Runners to use from the list of selected Bot Runners. The Control Room will then automatically select the configured number of Bot Runners from the list of available Bot Runners.

Note: If a run-as user (Bot Runner) does not appear in the list, ensure the user scheduling the bots is assigned a role that provides access to the appropriate run-as users.

- Click the right arrow (→) to add your selection.
- Optional: Select **Device Pools**.
Select the pool from the list of available device pools. If any of the selected run-as users does not have the bot running device, a device pool is required. You can select up to 25 device pools per schedule.
- Optional: Click the up or down arrow to set the selected device pools in preferred order.
When a is deployed, the selects the first available device based on the order in which you organized the device pools. If none of the devices are available at the time of deployment, the is queued.
- Enter the **Name**.
- Optional: Enter a description.
- Select the **Automation priority** from the **General** tab.
Set the priority to high, medium, or low based on your requirements for resource optimization. The default permission is set to medium.
- Click **Schedule bot**.

The **Schedule bot** option remains disabled until all the required items, such as bots, schedule details, and devices are selected.

The number of times a bot is deployed depends on the run-as users (Bot Runners) selected for the schedule. Consider the following scenarios:

- The number of run-as users selected is two, and both the users have the bot running device: The bot is deployed twice on the two run-as users and their bot running devices.
- The number of run-as users selected is three, and only one of the users has the bot running device. In this case, you must select the device pool. If the device pool has only two devices, the bot is deployed three times on both the devices in the device pool and also on the bot running device of the third user.
- The number of run-as users selected is three, and none of the three users has the bot running device: In this case, you must select the device pool. If the device pool has only two devices, the bot is deployed twice on both the devices in the device pool, and the third request for bot deployment is queued. The bot is deployed only when a device becomes available in the device pool.
- The number of run-as users selected is two, and none of the two users have the bot running device: In this case, you must select the device pool. If the device pool has four devices, the bot is deployed twice on any available two devices in the device pool.

Related concepts

[Bot permissions for a role](#)

Assign bot permissions when creating a role with the **View my bots** feature permission.

Related tasks

[Edit a scheduled activity](#)

Make changes to a schedule so that the automation is not skipped.

[Delete a scheduled activity](#)

Delete a scheduled activity.

Edit a scheduled activity

Make changes to a schedule so that the automation is not skipped.

Ensure that you are logged in to the as the administrator.

Edit the scheduled activity in order to:

- Change the schedule type, date, or time.
- Add or remove Bot Runners from the schedule.
- Change the retry settings.

Note: The system redeploys the bots and dependencies only if there are updates to the bots or its dependent files.

1. Hover over the **Actions** icon for the scheduled in the Activity table.
2. Click the **Edit** icon. (✎)
3. Make changes to the schedule details, bots, and devices, as required.

Option	Definition						
Run once	To run the bot at a specified time, enter the: <table> <tr> <td>Start date</td> <td>Default value is the current day.</td> </tr> <tr> <td>Start time</td> <td>Default value is roundup to the next half-hour.</td> </tr> <tr> <td>Time zone</td> <td>User's system time zone</td> </tr> </table>	Start date	Default value is the current day.	Start time	Default value is roundup to the next half-hour.	Time zone	User's system time zone
Start date	Default value is the current day.						
Start time	Default value is roundup to the next half-hour.						
Time zone	User's system time zone						

Option	Definition
<p>Run repeatedly</p>	<p>To schedule a bot to run at specific time on a given day, enter the:</p> <p>Start date Default value is the current day.</p> <p>End date The default value field is blank.</p> <p>Start time Default value is roundup to the next half-hour.</p> <p>Time zone User's system time zone</p> <hr/> <p>Note:</p> <p>When the daylight saving is enabled and if the Start date is set for a schedule, the Start date is shown in the time zone to which it belongs to and not as per the user's current time zone. However, Next occurrence is shown in the time zone (user's system time zone) as per daylight saving time.</p> <p>For example, for a schedule created on 15th March in GMT time zone, the Start date is shown as Mar-15th which belongs to GMT time zone. Later, when daylight saving is ON and if you edit or view this schedule in the month of August in BST time zone, next occurrence is shown as current August month date which belongs to BST time zone.</p>

4. Select Device pools.

Select the pool from the list of available device pools.

5. Optional: Click the up or down arrow to set the selected device pools in preferred order.

6. Optional: Change the Automation priority from the General tab.

7. Click Schedule bot.

The **Schedule bot** option remains disabled until all the required items, such as bots, schedule details, and devices are selected.

The number of times a bot is deployed depends on the run-as users (Bot Runners) selected for the schedule. Consider the following scenarios:

- The number of run-as users selected is two, and both the users have the bot running device: The bot is deployed twice on the two run-as users and their bot running devices.
- The number of run-as users selected is three, and only one of the users has the bot running device. In this case, you must select the device pool. If the device pool has only two devices, the bot is deployed three times on both the devices in the device pool and also on the bot running device of the third user.
- The number of run-as users selected is three, and none of the three users has the bot running device: In this case, you must select the device pool. If the device pool has only two devices, the bot is

deployed twice on both the devices in the device pool, and the third request for bot deployment is queued. The bot is deployed only when a device becomes available in the device pool.

- The number of run-as users selected is two, and none of the two users have the bot running device: In this case, you must select the device pool. If the device pool has four devices, the bot is deployed twice on any available two devices in the device pool.

Related tasks

[Schedule a bot](#)

Schedule a bot to run at a specific time.

[Delete a scheduled activity](#)

Delete a scheduled activity.

Delete a scheduled activity

Delete a scheduled activity.

Ensure that you are logged in to the as the administrator.

To delete a scheduled activity:

1. Hover over the **Actions** icon for the scheduled in the Activity table.
2. Click **Delete**.
Confirm or cancel.
3. Click **Yes, delete**.

Related tasks

[Schedule a bot](#)

Schedule a bot to run at a specific time.

[Edit a scheduled activity](#)

Make changes to a schedule so that the automation is not skipped.

Automatically select the number of Bot Runners users

Scale your automation by allowing Automation 360 to automatically select the Bot Runner users for specific tasks.

You can enable Automation 360 to automatically select the Bot Runner users for specific tasks:

- Scale automations easily
- Run bots concurrently
- Use resources efficiently

You can optimize Bot Runner users by selecting how many Bot Runners you want to use to run tasks concurrently. The system automatically selects the number of Bot Runner users that are available for the tasks. As a result, when you run or schedule an automation, the available run-as users are automatically selected from the specified list.

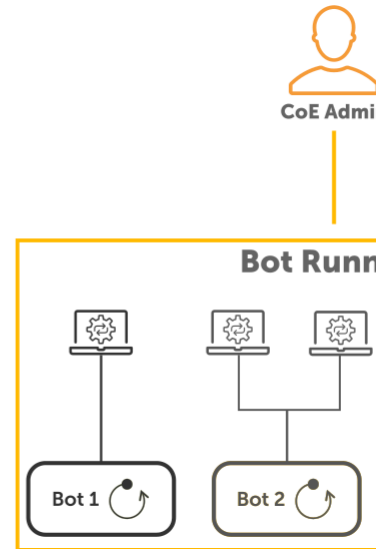
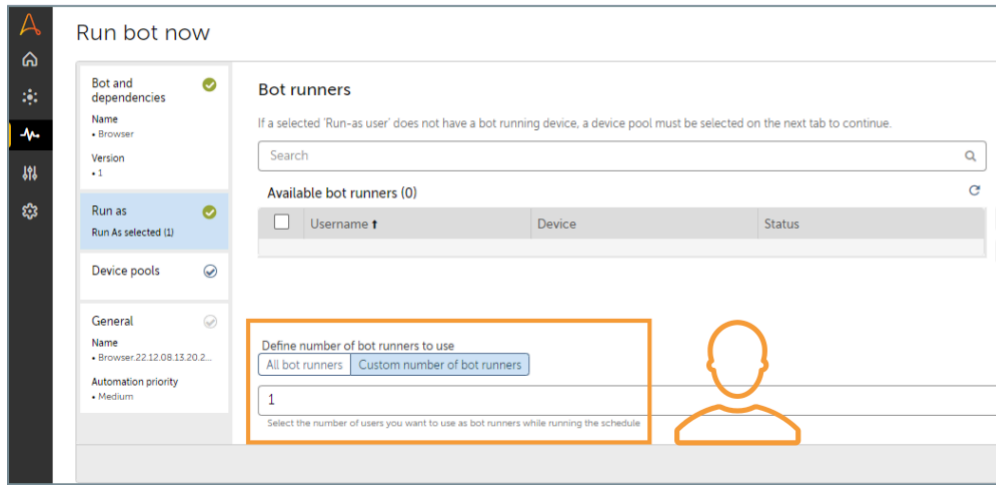

To customize Bot Runners, see [Schedule a bot](#).

Event triggers

An event trigger is a predefined action that runs an associated bot. All the bots with event triggers are listed under the **Event triggers** tab.

Available role permissions for event triggers

A Control Room administrator must provide the required permissions to ensure the associated users can access event triggers. The following table lists the available permissions:

Permission	Description
View event triggers	Select this permission if the users can only view the event triggers but not run or delete them.
Manage event triggers	<p>The Manage event triggers permission is available only if View event triggers is enabled. Select this permission if the users can:</p> <ul style="list-style-type: none"> Add an event trigger <hr/> <p>Note: Users associated with the Bot Creator license cannot add event triggers in the private workspace.</p> <hr/> <ul style="list-style-type: none"> Run a bot with event trigger Delete event trigger Associate an event trigger with a Bot Runner (attended or unattended) user or a role that is associated with one or more Bot Runner (attended or unattended) users.

Supported actions

In Automation 360, click **Manage > Event triggers** to view the table that lists all the available bots with event triggers. The following actions are available for this table.

- Enter a keyword from the `BOT_PATH` in the **Search** field to find an event trigger.
For example, if the bot path of an event trigger is `Bots\file--created--event--Salesinfo`, enter `Sales` in the **Search** field to find this event trigger.
- Use the **Run with event triggers** option to add event triggers.

Adding event triggers

- User can also delete any associated (active or inactive) event triggers.
- View the trigger status, bot path, user name, role, and modification details.

Optional: On the specific device, to view trigger details:

1. Open the **Task Manager > Details** tab.
2. Right-click on the column in the list of app entries.
3. Click **Select columns**.
4. Click **Command Line** item to enable the column.

Verify that the following Java processes are running to confirm that the triggers are active:

- Bot agent or node manager

Note: The name for this is **java.exe**

- Trigger listener

Note: The name for this is **javaw.exe**

Optional: To confirm that **java.exe** or **javaw.exe** are associated with a node manager or trigger listener, respectively:

1. Copy the details of this task
Press **CTRL+C** after you clicked the task name.
2. Paste the details to a notepad.
3. Verify the jar files.

Note: Node manager is **node-manager.jar** and the trigger listener is **triggerlistener.jar**

Consider a scenario where triggers are associated with a Bot Runner user who logs off or signs out of a device. This Bot Runner user must log in to the Control Room on that device in order to activate the associated triggers.

Related concepts

[Adding a trigger to run a bot](#)

Add triggers that can automatically run the selected bot whenever a specific event occurs. For example, clicking a specific button or using a combination of keystrokes.

Adding event triggers

Any bot with triggers can be associated with users or role to enable event trigger. Control Room user (or role) with **Manage event triggers** permission can add event triggers.

All the bots a user creates are displayed in the **Private** tab. When the user checks in a bot to a public folder, it is displayed in the **Public** tab.

A private event trigger is created when a user with the **Manage event triggers** permission adds a trigger to a bot but does not check in this bot to a public folder. Private event triggers are listed under the **Manage > Event triggers** page. However, if the user checks in the associated bot to a public folder, it is no longer displayed under the **Event triggers** page.

1. On the left pane, click **Automation**.
2. Click **Run bot**.
3. Click **Run with event triggers**.
4. Select the bot.
 - Latest version: Click **Latest version** tab to select the latest version of the bot.
 - Labeled version: Click **Production version** tab to select the labeled version of the bot.

If the production label option is selected for the parent bot, the corresponding dependent bots with the production label are also automatically selected. If any of the dependent bots do not have the production label applied, the latest version of the bot is selected.

5. Click the right arrow (→) to add your selection.
6. Click **Next**.
7. Select one of the following to link the bot:

Option	Description
Roles	Select the custom role you have created.
Users	Select the Bot Runner (attended or unattended) user who is associated with this custom role.

8. Click the right arrow (→) to add your selection.
9. Click **Next**.
10. Click **Run with event triggers**.

The selected bot is added to the **Event triggers** page under **Activity**.

Related concepts

[Working with bots](#)

Depending on the license and permission assigned to you, you can perform various bot operations and access the private and public workspaces in the Control Room.

Linking event triggers to a Bot Runner

An Control Room administrator or users with **Manage event triggers** permission can add event triggers by associating users or roles with a bot. This enables Bot Runner users to trigger the bot when they perform a specified event.

When a user with a Bot Creator license creates a bot and checks it in a repository, the bot is available in the **Public** workspace. An Control Room administrator or user with **Manage event triggers** permission and access to that **Public** workspace can then link an event trigger.

A Bot Runner (attended or unattended) user must log into the Control Room to start the event trigger, and can choose to log out after that event trigger is activated.

Optionally, administrator can also enable the auto-login feature in the Control Room for unattended Bot Runner users.

See [Configure auto-login settings](#).

Note: Among all the triggers, you can associate any trigger only with a user who has a Bot Runner license. Also, for a user with unattended Bot Runner license, if you associate triggers such as **Hot key**, **Interface**, or **Window**, the following conditions apply:

- The default device must not be in the logged-off or locked state.
- The user must be logged in to the device to perform the predefined task that can trigger the bot.

1. On the left pane, click **Automation**.

2. Click **Run bot**.

3. Click **Run with event triggers**.

4. Select the bot.

- Latest version: Click **Latest version** tab to select the latest version of the bot.
- Labeled version: Click **Production version** tab to select the labeled version of the bot.

If the production label option is selected for the parent bot, the corresponding dependent bots with the production label are also automatically selected. If any of the dependent bots do not have the production label applied, the latest version of the bot is selected.

5. Click the right arrow (→) to add your selection.

6. Click **Next**.

7. Select one of the following to link the bot:

Option	Description
Roles	Select the custom role you have created.
Users	Select the Bot Runner (attended or unattended) user who is associated with this custom role.

8. Click **Add event triggers**.

When the Bot Runner user logs in to Control Room and performs the trigger event, the bot is deployed. The event trigger will continue to work until one of the following changes occur:

- Associated bot is deleted from the public workspace.
- The linked Bot Runner user account is deleted.
- The default device is logged off.

Devices

The device is a machine through which a user connects to the Control Room to create or run bots. Manage devices that are registered to the Control Room through the **Devices** page located in the **Manage** tab.

Tasks performed from the Devices page

As a Control Room user with Bot Runner, Bot Creator, and Device pools privileges, use the **Devices** page to perform the following actions:

- View a list of devices registered and connected to the current instance of the Control Room.
- Create and view a list of device pools available from the current instance of the Control Room.
- Run bots immediately on selected Bot Runners.

If the device is already registered by another user other than the Bot Creator and the Bot Creator does not have the `Register device` permission or the associated device assigned to it, when you run a bot from the bot editor window, the deployment fails with an `insufficient permission error` message.

- Schedule bots to run on selected Bot Runners.
- Run bots on selected device pools.

Notes:

- Only an admin user has access to view all the devices in the Control Room. A non-admin user does not have access to view Bot Creators.
 - Only one Bot Creator can be logged in to a device to run bots at any one time. For a new user as a Bot Creator on the same device, the first Bot Creator has to be removed.
-

Devices

The **Devices** page lists all configured devices and the current state for each device listed. Devices are identified by IP and hostname. A device can be in one of the following states:

Connected

Device is logged in to the Control Room.

Note: Wait for 35 seconds for a device to show as connected in the devices list after you remove and re-register the device.

Disconnected

Device is not logged in to the Control Room.

Offline

Device has been unregistered or disabled by the Control Room administrator.

The following actions are enabled:

Connect local device

The Bot Agent is a lightweight application that enables you to run bots on your device by connecting the device to the Control Room. To run bots on a local machine, install the Bot Agent and add the local device to the list of enabled host devices.

Run bot now with checked items

Runs the bot on selected device.

Export checked items to CSV

Exports the data to a CSV file based on:

- Filters
- Selection

Refresh table

Refreshes the table contents to view the updated status.

Customize columns

Show or hide specific columns.

View and edit device

With the **View and manage ALL device(s)** permission, you can view and edit the following device settings:

- Name
- Status
- Bot Agent version
- Device pool name
- Nickname (optional)
- Description
- Device type (single user or multiple users)

In case of a multi-user device, you can edit the **Concurrent sessions supported** field.

- Add or edit device permissions
- Screen resolution

You can set the screen resolution by either selecting a value from the predefined resolution drop-down list or by selecting custom and entering the values.

- You can edit only the nickname, description, device type, and screen resolution fields.
- Ensure that you have selected the **Allow devices to override resolution settings** option in the Control Room settings for the device level resolution to take effect.

Note: The screen resolution settings are applicable only when you use RDP-based deployments. For regular deployments, a Windows session is created using the existing resolution settings of the device. In this case, the screen resolution set in the Control Room is ignored.

- Lifespan

Device lifespan can be **Persistent** or **Temporary**. Temporary devices are created to support non-persistent virtual desktop infrastructure (VDI) and are automatically deleted after a specified time when the device is disconnected from the Control Room. You can specify the time to automatically delete

temporary devices in the Control Room devices settings.

Persistent devices are created to support persistent virtual desktop infrastructure (VDI) and are not deleted after the device is disconnected from the Control Room.

- Auto-login settings

You can customize the auto-login settings for each device. Choose between the settings configured in the Control Room or at the selected device level to either create new user sessions or use existing user sessions after a bot finishes running.

- Installation type

This setting is based on whether the Bot Agent is installed at user level or system level on the user device.

- Deployment type

This setting is based on the user type and installation type. For single users installed at the system level, the default deployment type is regular. For multi-users installed at system level, the default deployment is RDP.

Preload packages

Use preloaded packages to download the most commonly used or customized packages on your local device. As the packages are saved offline on your device, when you run a bot, the system skips the package download process and starts executing the bot, thereby reducing the bot execution time. You can download specific versions of the package to the user device folder `C:\ProgramData\AutomationAnywhere\AAPreloadedPackages`.

Device pools

Device pools provide a logical grouping of similar Bot Runners to run bots with the work items from a queue. For example, group devices of a particular department or unit and create a device pool for it.

Related tasks

[Install Bot Agent and register device](#)

The Bot Agent is a lightweight application that enables you to run bots on your device by connecting the device to the Control Room. To run bots on a local machine, install the Bot Agent and add the local device to the list of enabled host devices.

[Set user device credentials](#)

To enable a device for running bots, set the local device credentials.

[Configure auto-login settings](#)

Configure auto-login settings in the Control Room to either create user sessions or reuse existing user sessions to reduce the bot startup time.

About multi-user devices

A multi-user device is any Windows terminal server device (Windows 2019, Windows 2016, Windows 2012, Windows 10 Enterprise on Azure) which enables multiple users to concurrently log in to a single device.

The multi-user device server enables multiple users to access the same operating system and share the hardware, performing the tasks for each user concurrently. In multi-user devices, bots are deployed using RDP.

Benefits of a multi-user device

A multi-user device ensure that each machine in an organization is fully used, reducing the hardware and software cost by enabling different users to access the same device. Bot Creator users and Bot Runner (attended or unattended) users can be configured on a multi-user device. The multi-user device also provides security and authentication for every user. Each user is assigned unique login credentials for the device and can access only the assigned applications and device settings.

Note: In a multi-user device, if two user sessions with the same device credentials try to deploy a bot, the deployment will fail for one of the user sessions. An appropriate failure message is recorded in the audit log.

Multi-user device in a device pool

A multi-user device can be part of a device pool and the device can be set as the default device for Bot Creator users and Bot Runner (attended and unattended) users.

Set as default device

As a licensed user, when you log in to a non-default device, you can set that device as your default device. You must have the **View and manage ALL device(s)** permission if you want to set another device that is not registered by you as your default device: To set it as the default device, follow these steps:

1. Click the device icon on the top-right of your screen.
2. Select the **Make default device** option from the menu.

If you do not have the necessary permission, a message prompt appears, stating that you will lose access to your current default device.

Configure RDP-based deployment for multi-user devices

RDP-based deployment is used for multi-user devices. When a bot is deployed for an unattended Bot Runner from the Control Room, the Control Room handles the unattended Bot Runner session through RDP and executes the bot.

Ensure that you are logged in to the Control Room as the administrator.

Ensure the following requirements are completed:

- Active Directory Domain Services are set up (**Optional**).
- Remote Desktop Services (RDS) are set up on the machine ready to host multiple (RDS) bot runner sessions (**Mandatory**).

- Active Directory/Local users are created (**Mandatory**).
- Users are provided access to RDS (**Mandatory**).

When registering your device, you can register it as a multi-user device.

1. Change device type to multiple users.

- a) Navigate to **Manage > Devices**.
- b) Hover over the actions menu (three vertical ellipses) located to the right of the device name and click the **Edit device** icon.
- c) Under **Deployment** tab, change the **Device type** to **Multiple users**.
- d) Enter a value for the **Concurrent sessions supported** field.

The maximum number of allowed concurrent sessions depends on your device license type and the hardware configuration. For example, consider that concurrent sessions is set to 10 and each bot requires 4 GB RAM for execution. If your system RAM is lower than this value, the bot execution might fail.

Also, if the maximum number of sessions allowed in your device is 10 and the multi-user device is set as the default device for 3 Bot Creator users and 2 attended Bot Runner users, then the value for the concurrent sessions supported will be 5. Therefore, at a time, only 5 bots can be deployed concurrently by the unattended Bot Runner users. So ensure that your hardware and device license type support the number of sessions you set.

- e) Click **Save changes**.

2. Set the RDP screen resolution.

This ensures your automation runs seamlessly during RDP-based deployment, even if the resolution of the screen varies between the Bot Runner and Control Room.

You can set it in the following ways:

- At the Control Room level: [Change screen resolution for Bot Runner session](#).
- At the device level: [Devices](#).

Note that you can update the screen resolution at device level only if the option to override screen resolution is enabled in **Administration > Settings > Devices**.

3. Configure the RDP settings.

- a) Select **Devices** option from **Administration > Settings**.
- b) Edit the **RDP settings for multiple user devices** field.
- c) Enter the **Port**.

Recommendation: Use the default port 3389 for RDP-based bot deployments.

- d) Enter the **RDP session timeout** value.
The default session timeout value is 60.
- e) Click **Save changes**.

4. By default clipboard data is shared across RDP sessions. Follow the below steps to prevent sharing of clipboard data across multi-user RDP sessions:
 - a) Select **Devices** option from **Administration > Settings**.
 - b) Edit the **Advanced options** field.
 - c) In the **RDP command options** field, enter `-clipboard`.
 - d) Click **Save changes**.

For more information about troubleshooting black screen and lock screen images, see

- [Black screenshot while running the bot in unattended mode \(A-People login required\)](#)
- [Black screen and lock screen images being captured \(A-People login required\)](#)

1. Create users in the Control Room.

These users can be unattended Bot Runners, Attended Bot Runners, or Bot Creators. You can select the multi-user option when you register the device for the first time. See [Create a user](#).

2. Associate the correct device and session login credentials based on the Active Directory users that you create before configuring the multi-user device settings.

You can register an Active Directory user one time as an admin user and the sessions are created when you deploy bots. You do not have to create an RDP session on the Bot Runners server and register the device under an Active Directory user name and user credentials.

3. Deploy the bots on parallel sessions.

Note: If the multi-user device per sessions count provided is less than the actual bot deployment, then the additional bot deployments are queued until the current deployments are in progress.

Convert an existing device to a multi-user device

If you have a server OS, multi-user OS, or hosted VMs such as AWS, Microsoft Azure, or VMware as the Bot Runner machine, you can convert your existing device to a multi-user device.

Ensure that you are logged in to the as the administrator.

Converting a device enables you to share the same device between Bot Runner and Bot Creator users because they can coexist in different sessions simultaneously. Also, multiple parallel executions of a bot can be performed on the same machine.

If you encounter Auto Login issues because multiple users are sharing the device or because it is a remote device, convert your device to a multi-user device.

If you have a single-user device and want to use RDP-based deployment, then set the **device type** as **Multiple users** and **Concurrent sessions supported** to **1**.

1. Navigate to **Manage > Devices**.
2. Hover over the actions menu (three vertical ellipses) located to the right of the device name and click the **Edit device** icon.
3. Under **Deployment** tab, change the **Device type** to **Multiple users**.
4. Enter a value for the **Concurrent sessions supported** field.

The maximum number of allowed concurrent sessions depends on your device license type and the hardware configuration. For example, consider that concurrent sessions is set to 10 and each bot

requires 4 GB RAM for execution. If your system RAM is lower than this value, the bot execution might fail.

Also, if the maximum number of sessions allowed in your device is 10 and the multi-user device is set as the default device for 3 Bot Creator users and 2 attended Bot Runner users, then the value for the concurrent sessions supported will be 5. Therefore, at a time, only 5 bots can be deployed concurrently by the unattended Bot Runner users. So ensure that your hardware and device license type support the number of sessions you set.

5. Click **Save changes.**

About device pools

Device pools are a logical grouping of devices or similar unattended Bot Runner machines on which you can run your workload management automations or scheduled unattended automations. For example, you can group the devices (system-wide type) of a specific department or unit and create a device pool.

Overview

You can use a device pool to restrict bot deployments to a specific set of devices that are available from your Control Room instance and take advantage of any device available in a device pool because any device in the device pool can run the bot.

You can also use a device pool to process work items from workload management queues. Workload management distributes work items across various devices in a device pool. This distribution of work items ensures efficient bot processing through optimal usage of devices and Automation 360 licenses. Device pools can contain different types of devices, such as single-user devices or multi-user devices.

You can share the device pool between multiple automations such as workload management, **Run bot**, and **Schedule bot**, thus improving the device utilization.

How a device pool works

When you deploy an unattended bot to a device pool at run time, system identifies the available devices from the pool. System starts with first device from the pool, if the first device is busy, it checks for next device and then the bot is automatically sent to the available device from the list of system-wide devices. As the other bots are deployed, they can run concurrently on the other devices in the device pool. By dynamically allocating devices when bots are deployed, bot deployments are executed quickly and efficiently.

High availability (HA) in device pools

Device pools provide built-in *High Availability* (HA) for the Bot Runner machines if your unattended license is free to use. You are not tied to a single Bot Runner machine, so if your Bot Runner machine is unavailable for any reason and your unattended license is free for deployment, your automation is not affected. The scheduled automation will automatically run on the next available Bot Runner machine, thereby providing high availability.

Note: Consider the following points when working with user credentials:

- Only one user credential can be attached to a licensed user.
- If all devices in a device pool are domain integrated and Active Directory users have access to all devices, licensed users can login to any device by using attached user credentials.

- For more information about running bots in device pool, see [Considerations for running a bot](#).
-

Managing device pools

As a device pool administrator, you can create, edit, and view all device pools that can be used for scheduling automations and workload management.

As a device pool owner or consumer, you can view only those device pools of which you are the owner or consumer. Only users with the **AAE_Queue Admin** and **AAE_Pool Admin** role can perform device management tasks.

Note: You have to create device pools to view those in the list.

To easily access your device pool, you can search by a device pool name.

- Click a column to sort it in ascending and descending order. You can sort up to three columns by holding the Shift key when you click two more columns. This enables you to sort two additional columns. The sorting is done on the entire table and not just the data that is currently visible to you. The last sorting is stored in memory applied by a user per session.
- Use a drag-and-drop operation to move the column left or right.
- Move your mouse cursor at the end of the column and drag to resize.

Create device pools

Create a device pool with a unique name and add Unattended Bot Runners to the device pool.

- Ensure that you have one of the following roles to view the **Device Pools** tab:
 - **Device pool owner**
 - **Device pool admin**
 - Ensure that you have a role with **Create device pools** permission to create a device pool.
-

Note: A Control Room administrator without device pool admin rights cannot view or create a device pool.

- To add a device in the device pool, you must install it as a system-wide device (Bot Agent).
 - After you add the device, you cannot add the same device to another device pool.
 - You can add only those Unattended Bot Runners that are not part of any other pool.
-

Restriction: Unattended Bot Runners that are a part of other device pools are disabled for selection.

- You can use the **Scheduled automations** and **Run with Queue automations** options to run bots on that device.
- You can add Control Room user roles as consumers. Only users with these roles can use the pool for any automation.
- You can select only those devices with the Bot Runner installed at the system wide.
- If the devices in a device pool are more than the number of work items added to a queue, multiple entries equal to the number of devices are shown in the Control Room **In-progress activity** and **Historical** pages. For details, refer to the **View queue details** page on the actual user device on which the workload automation is deployed.

To create a device pool, perform the following steps:

1. Navigate to **Manage > Device pools**.

2. Click **Create device pool**.
3. Enter the **Name**.
4. Optional: Enter a description.
5. Select the **Devices** from the list of .
6. Click the right arrow (→) to add your selection.
7. Click **Next**.
8. Select the Device Pool **Owners**.
9. Select user(s) from the **Available users** list.

Tip: Search the list of users based on their **Username, First name, or Last name**.

10. Click the right arrow (→) to add your selection.
11. Click **Next**.
12. Optional: Select the **Device Pool Consumers**.
Complete this step to enable device pool consumers to view the device pool when they run the automation for the bot with a queue by following the next set of steps.
13. Optional: Select a Role from the list of **Available roles**.
14. Click the right arrow (→) to add your selection.
15. Click **Create device pool**.

The device pools for which you have consumer privileges are listed in the **My Device Pools** page.

[View device pool details](#)

Related tasks

[Run bot with queue](#)

Collectively process all work items of a queue across all the Bot Runners present in one or more device pools.

View device pool details

As a Control Room user with device pool management privileges or as a device pool owner, you can view device pool details to ensure the information provided is correct and if required customize as per your automation requirement.

Ensure that you are logged in to the as the administrator.

Use the **Device pool details** page to view automations that are scheduled to run with or without workload. The following information is displayed as part of device pool data:

Automations

Shows the automations that are using the device pool and the order that is chosen to run those. This is shown as the default view. To find an automation quickly, use the search option using Status, Automation name, Queue, or Activity type.

You can perform the following actions on a table column:

- Click a column to sort it in ascending and descending order. You can sort up to three columns by holding the Shift key when you click two more columns. This enables you to sort two additional columns. The sorting is done on the entire table and not just the data that is currently visible to you. The last sorting is stored in memory applied by a user per session.

- Use a drag-and-drop operation to move the column left or right.
- Move your mouse cursor at the end of the column and drag to resize.

Devices

Shows list of unattended Bot Runner devices that are part of the device pool.

Owners

Shows list of device pool owners that are granted permission to view, edit, and delete the device pool.

[Create device pools](#)

Consumers

Shows the list of device pool consumers who are granted permission to view the device pool as an option to running automations.

[Create device pools](#)

General Details

Shows the last modified date and time, name of the user who modified device pool details, and the Object Type which is the component on which modification was done.

The **Scheduled Automations** tab is selected by default. Automations that are created using **Run bot now** or **Schedule bot** (upcoming schedules) on that device pool are listed.

The second tab, **Run with Queue Automations** lists the automations that are scheduled to run for **Workload** using the option **Run bot with queue**.

To view device pool details:

1. Navigate to **Manage > Device pools**.
2. Hover over the **Actions** icon for the device pool and select **View**.
Select each tab to view the related details.

[Edit device pools](#), or [Run bot with queue](#).

Related tasks**Create device pools**

Create a device pool with a unique name and add Unattended Bot Runners to the device pool.

Delete device pools

Delete a device pool comprising of unattended Bot Runners after your entity's automation goals are achieved and the device pools are no longer required.

Edit device pools

As a Control Room user with device pool management privileges or as a device pool owner, you can edit device pool details to customize your automation requirements.

- You must have **Device pool owner** or **Device pool admin** roles to edit a device pool.
- Users without **AAE_Admin** role must have the following permissions to edit a device pool:
 - **View and manage ALL device(s)** to add or delete the devices
 - **View Users and Roles basic information** to add or delete the owners and consumers
- To add a device in the device pool, you must install it as a system-wide device (Bot Agent).
- After you add the device, you cannot add the same device to another device pool.

When you open the device pool in edit mode, you can update the queue details such as Bot Runner, Owners, Participants, and Consumers.

1. Go to [Manage](#) > [Device Pools](#).

The **Device Pools** tab is visible only if you have **Device pool admin** role or you are an owner of any device pool.

2. Locate the device pool you want to edit, hover over the actions menu (vertical ellipsis), and click [Edit](#).

You can also edit the device pool details in view mode. For more information, see [View device pool](#)

The **Device pool details** page is displayed with the default **Scheduled Automations** tab.

3. Set the Queue Execution mode to edit workload automations.

Go to the **Run with queue automations** tab, then choose one of the following options to define the order in which your automations run in the queues:

- **Round robin:** Runs your automations at equal time intervals in the **Time slice** field. For more information, see [Round robin](#).
- **Priority as shown in table:** Runs your automations based on a priority defined in the priority table. For more information, see [Priority as shown in table](#).

4. Update the list of unattended Bot Runner devices that are included in the device pool.

5. Update the list of device pool owners who are granted permission to view, edit, and delete the device pool.

6. Update the list of device pool consumers who are granted permission to view the device pool.

7. Click [Save changes](#).

Related tasks

[Create device pools](#)

Create a device pool with a unique name and add Unattended Bot Runners to the device pool.

[Delete device pools](#)

Delete a device pool comprising of unattended Bot Runners after your entity's automation goals are achieved and the device pools are no longer required.

[View device pool details](#)

As a Control Room user with device pool management privileges or as a device pool owner, you can view device pool details to ensure the information provided is correct and if required customize as per your automation requirement.

Order of the automation queue

You can define the order in which your automations run in the queues.

This topic describes options of orders in which you can run the automation queues.

Round robin

This option runs your automations at equal time intervals specified in the **Time slice** field. You can set a **Time slice** in seconds, minutes, or hours and you can calculate or estimate the time for each automation, and then provide this number.

- The default time slice is **60 minutes**.
- The default time slice is **5 minutes**.
- The time slice cannot be set to zero.

Automations are executed for 60 minutes first, then the system checks for other automations in queue for execution. If there are other automations in the queue, that automation is paused and the next automation is executed. This method continues until all automations in the queue are executed.

Priority as shown in table

With this option, automations run based on a priority defined in the priority table. You can run automations in the order of priority and set the individual priorities for each of the queues. Priority 1 is the highest priority and that queue is processed first and completely by the device pool. Then the device pool moves onto the processing queue with Priority 2. When the queue with Priority 2 is processed completely, the device pool proceeds to processing queue with Priority 3, and so on. Automations are processed until all automations are consumed from the specified automation queue.

Note: This option is available only on the **Run with queue automations** tab.

Delete device pools

Delete a device pool comprising of unattended Bot Runners after your entity's automation goals are achieved and the device pools are no longer required.

Ensure that you are logged in to the as the administrator.

You can choose to delete your device pools in either of two ways:

- Delete one device pool
- Delete multiple or all device pools

If the device pool is being used for workload automation, you will not be allowed to delete it.

1. Navigate to **Manage > Device pools**.
2. Select the device pool(s) to delete.
Select the device pools to delete or select all device pools by selecting the **Select All** check box in the header.
3. Hover over the **Actions** icon for the device pool.
4. Click **Delete**.
Confirm or cancel.

Related tasks

[View device pool details](#)

As a Control Room user with device pool management privileges or as a device pool owner, you can view device pool details to ensure the information provided is correct and if required customize as per your automation requirement.

[Create device pools](#)

Create a device pool with a unique name and add Unattended Bot Runners to the device pool.

Customize device settings

Customize the settings for user devices at the device level such as device lifespan, auto-login, screen resolution, deployment, and other advanced options.

These configurations are available for editing only if the settings are enabled by the Control Room administrator.

1. Navigate to **My Devices > Edit devices**.
2. Select the setting tab for configuration at the device level:
 - a) Update the **Nickname** and **Description** parameters, and select either **Persistent** or **Temporary** in the **General Settings**.
Device lifespan can be **Persistent** or **Temporary**. Temporary devices are created to support non-persistent virtual desktop infrastructure (VDI) and are automatically deleted after a specified

time when the device is disconnected from the Control Room. You can specify the time to automatically delete temporary devices in the Control Room devices settings.

Persistent devices are created to support persistent virtual desktop infrastructure (VDI) and are not deleted after the device is disconnected from the Control Room.

- b) To update the settings for **Auto Login** to run bots on user sessions at the device level, select **Use custom settings**.

Either create new user sessions or use existing user sessions after a bot finishes running.

You can customize the auto login settings at the device level only if the allow a user to change these settings individually for each device in devices page option is enabled by the Control Room administrator.

- c) Update the **Screen resolution settings** for existing device sessions.

The screen resolution settings are used to begin user sessions at the resolution specified in this setting. You can customize the screen resolution settings at the device level only if the allows users to override the resolution option is enabled by the Control Room administrator.

Note that the screen resolution settings are applicable only when you use RDP-based deployments. For regular deployments, a Windows session is created using the existing resolution settings of the device. In this case, the screen resolution set in the Control Room is ignored.

Recommendation: When resolution-dependent packages are used to build bots, any difference in screen resolution between the Bot Creator and Bot Runner devices will affect the bots at runtime. Therefore, ensure that the resolution settings on devices match when you create and run bots. See [Screen resolution dependent packages](#).

- d) Update the **Deployment settings** for single or multiple user devices and use the **Use custom settings** option to set the threshold settings for CPU and memory utilization at the device level.

For single users installed at the system level, the default deployment type is regular; you can change this to RDP. For multiple users installed at system level, the default deployment is RDP. For single users installed at the user level and multiple users at the system level, you cannot updated the deployment type.

Note: If the Windows setting **Restrict Remote Desktop Services users to a single Remote Desktop Services session** is enabled for RDP in the local group policy, a user is connected

to an existing session instead of creating a new session when the user uses RDP to verify bot deployments.

For multiple user devices, additionally configure the **Concurrent sessions supported**. The minimum concurrent session value is **2**.

You can customize the threshold settings only if the enable threshold settings option is enabled by the Control Room administrator.

- e) Update **Log collection configuration** to configure log collection level, log file size, number of archived logs, and synchronize log collection settings.

Collect logs for three levels: information to collect messages that highlight the progress of the application, debugging information that is useful to debug an application, and tracing logs to capture application behavior in detail.

Define the maximum log file size for a single log file. A new log file is created after the file is archived.

Define the number of archived logs files that can be generated. The archived log file is retained for a day. For example, `Node_Manager-2022-Mar-30-1.log.zip`.

Set values and synchronize log collection configuration across devices from the Control Room to capture logs with more information or debug any observed behavior.

To configure the **Log collection configuration** settings, see [Configure log collection](#).

- f) Update the **Advanced Options** at the device level such as auto-login timeout, bot launcher JVM options, console readiness wait time, bot response wait time, RDP command options and log collection by selecting the **Use custom settings** option.

Note that you can customize these advanced options only if the allow changes in the edit device page option is enabled by the Control Room administrator.

- Auto-login timeout enables you to set a wait time for a bot to deploy. After this wait time, an error is shown.
- Bot launcher JVM options enable you to send dynamic properties supported for Java. For example, you can use this option to increase the memory of the bot launcher.
- Maximum simultaneous downloads enable you to set the number of simultaneous downloads. For example, 5 downloads including dependent files.
- Console readiness wait time enables you to set a wait time for the console to be displayed when you run a bot. After this wait time, an error is shown.
- Bot response wait time enables you to set a wait time for an active bot session. After this wait time, an error is shown.
- RDP command options enable you to provide different RDP-based commands, for example, ports-related commands.
- When the log collector option is selected by the Control Room admin, the device can send logs to the Control Room.

3. Click **Save changes**.

If the user device is offline, these changes take effect when the device reconnects to the Control Room.

Related concepts

[Configure default device settings](#)

Configure the device settings to automatically set a user's current device as the default device after the user logs in to the Control Room.

Related tasks

[Change screen resolution for Bot Runner session](#)

For user devices, you can set the screen resolution of the Bot Runners for every bot deployment through the RDP in the Control Room.

[Configure auto-delete temporary device settings](#)

Configure your device settings to automatically delete a temporary device when the device is disconnected from the Control Room after a certain time interval.

[Configure threshold settings for user devices](#)

Configure the CPU utilization and device memory threshold values to control the concurrent bot deployment on user devices based on resource utilization.

[Configure auto-login settings](#)

Configure auto-login settings in the Control Room to either create user sessions or reuse existing user sessions to reduce the bot startup time.

Packages

Users with the **Manage package** permission can upload and manage packages. Automation Anywhere provides you with the flexibility to decide which packages you want to make available to the Bot Creators for creating bots.

Users must have the appropriate administrative permission to view or manage action packages.

View packages

A user with **View packages** permission can view the packages that are available to Bot Creators. Go to the **Bots > Packages** page to view **All packages**.

The **All packages** page lists all the packages in the Control Room that are available for Bot Creators. Packages can have multiple versions.

Manage packages

A user with the **Manage packages** permission can add new packages to the Control Room and manage which packages versions are available in the Control Room.

Add packages from the **Bots > Packages > Add package**.

Manage packages from the **Bots > Packages > All packages > View package** page.

Set as default

Select a package and set it as the default. As soon as a package is set to default, it is the package that all Bot Creators in the Control Room use.

Disable

Disable a package so that users cannot use it to create new bots. Bots that were created using a disabled package continue to work.

Delete

Deleting a package removes the actions contained in the

package from the Control Room for all users.

Important: A package cannot be deleted if it is being used by a bot.

Note: It is recommended that Bot Creators update bots to use the latest version of a package.

Updates to packages by Automation Anywhere are available in each release of Automation 360. The latest updated package can be set to the default package by users and administrators with **Manage package** permission.

Note: When you upgrade to Automation 360 v.24, the Apache log4j2 library is no longer bundled in the command packages. However, older command packages, from Automation 360 v.23 and earlier, might continue to have the log4j2 library bundled within. If you want to use command packages without the log4j2 bundled within, we recommend that you use the newer Automation 360 v.24 packages in your tasks.

RBAC on packages

Based on the business requirements and expertise of developers, administrators can restrict package access for a simplified developer experience, along with the capability to enforce access policies for custom groups.

Overview

The RBAC feature helps you to set access at the package level to restrict usage and execution of packages to improve security. This feature can be applied to all package types, including custom packages where you can control assigning and managing the packages to your users.

RBAC access to packages applies only to the task of creating bots. If a user role does not have access to a particular package, these users cannot view the package on the **Actions** palette and therefore cannot use it when creating bots. However, these users can run bots (created by a different user who has access to the package) that uses the package.

- Each developer sees only the approved list of packages in their workspace.
- Some packages might be available for all users, while some are available only for certain groups.

The following image shows how RBAC can be set for user roles and groups:

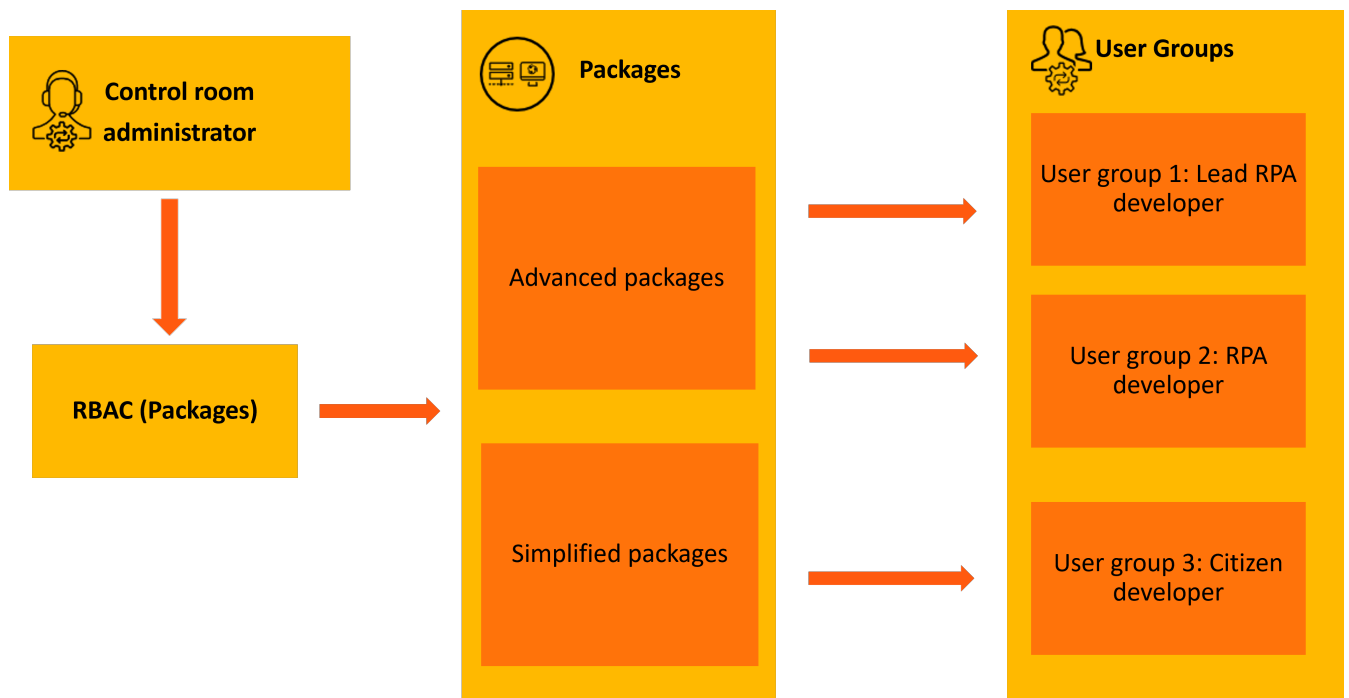

Benefits of packages RBAC

- **Centralized policy enforcement for secure, user-friendly developer access:** Role-based access to automation provides enhanced security, confidence, and ease of use for developers.
- **Enterprise-wide access policy:** Establish group-based package access with clear policies restricting package access to all the users or users with specific roles.
- **Access based on business needs:** Create required access groups, expose group-appropriate library of packages, and manage the phased rollout of package access.
- **Simplified automation for citizen developers:** Hide complex packages from the action palettes for citizen developers so that they can focus on easy-to-complete automation.
- **Automation reuse with compliance:** Enable users to create utility bots from complex packages to use as cloned bots in the a private workspace or inside public bots.

The following image lists the benefits of packages RBAC:

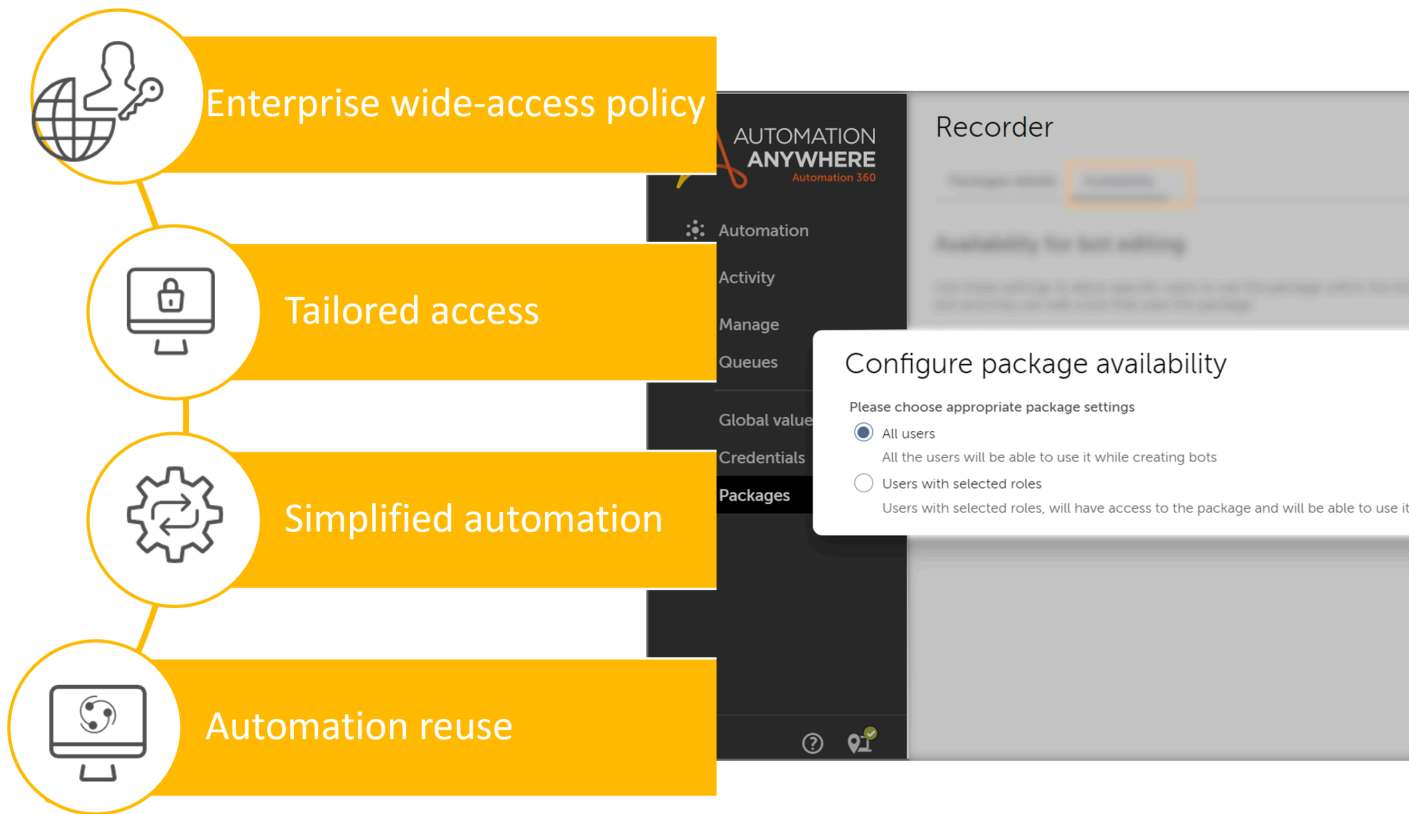

User types

Administrator

- Customizes packages so that they are accessible to developers based on the developers' expertise, skill, business group, and more.
- Creates custom groups and assign access per group.
- Rolls out packages in a phased manner to different types of developers.
- Provides better control over how packages are made available to developers. For example:
 - New developers can avoid causing security risks as they do not have access to complex packages.
 - Advanced developers can get broader access to packages.

An organization can enforce centralized control over package access and best practices through this feature.

Roles and permission required: Administrators with the **View Users and Roles basic information** and **Manage packages** permission.

Bot developer

- Gets a customized view of packages in their workspace.
- Simplified (easy-to-use) packages are enabled for Citizen Developers so that they can build a basic functional task bot using actions and packages available in their actions palette.
- Advanced developers can get access based on the entitlements or privileges provided by the administrator.

Roles and permission required: Users with the **View Users and Roles basic information** and **Manage packages** permission.

See the following video for an overview of how RBAC is configured:

<https://aa2019packagesdkfordocumentation.s3-us-west-2.amazonaws.com/videos/rbac-package-process.mp4>

Configure RBAC for packages

Restrict packages usage based on your business needs and roles for a secure and simplified developer experience. An administrator can customize access to packages based on developers' expertise, experience, and so on, while bot developers get a customized view of packages in their workspace based on their expertise and needs.

You must be an administrator or a user with the **View Users and Roles basic information** and **Manage packages** permission.

1. Log in to the Control Room.
2. Navigate to **Manage > Packages**.
3. From the list of packages, search for the package for which you want to give access to the users.
4. Click the selected package.

Packages

Download free bots and packages from [Bot Store](#)

Name

Packages (90)

Status	Name ↑	Vendor	Version	Bot agent (recommen...	Control Room (reco...	# of a
Enabled	AARI Web	Automation Anywhere	7.0.1-20220727-162102	21.134 or above	12316 or above	7
Enabled	Active Directory	Automation Anywhere	3.5.0-20220416-233339	20.11 or above	8750 or above	3
Enabled	Analyze	Automation Anywhere	2.4.4-20220615-020937	20.11 or above	8750 or above	2
Enabled	App integration	Automation Anywhere	4.8.0-20220616-123118	21.88 or above	10195 or above	3
Enabled	Application	Automation Anywhere	3.5.0-20220416-233350	20.11 or above	8750 or above	1
Enabled	Boolean	Automation Anywhere	2.5.0-20220118-153154	20.11 or above	8750 or above	6
Enabled	Bot Migration	Automation Anywhere	9.1.3-20220805-200018	21.220 or above	15224 or above	2

For example, when you click the **Recorder** package, the selected package window opens.

5. To allow specific users to use the package from the Bot editor, go to the **Availability** tab and click **Edit**.

6. On the **Configure package availability** page, choose one of the following options:
- **All user:** Select this option to allow the user to use the package while creating bots. By default, this option is selected for all the packages.
 - **User with selected roles:** Select this option if you want users with selected roles to access the package and use it while creating bots.

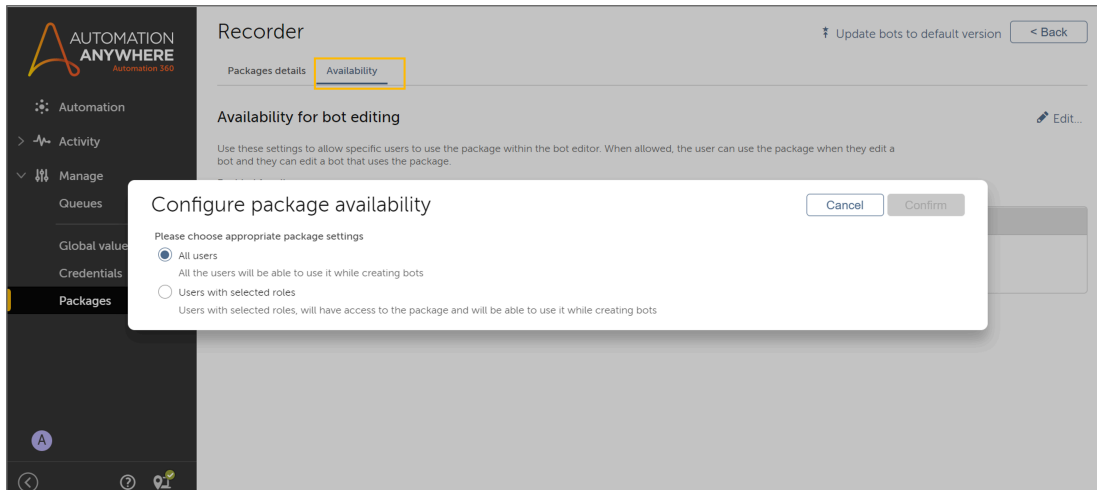

7. To configure access for specific users, perform these steps:
 - a) Select the **User with selected roles** option.
 - b) From the available roles, select the roles you want to assign.
 - c) Move the selected roles to the right panel.
This step enables you to define users who will have access to the package in the Bot editor.
 - d) Click **Confirm**.

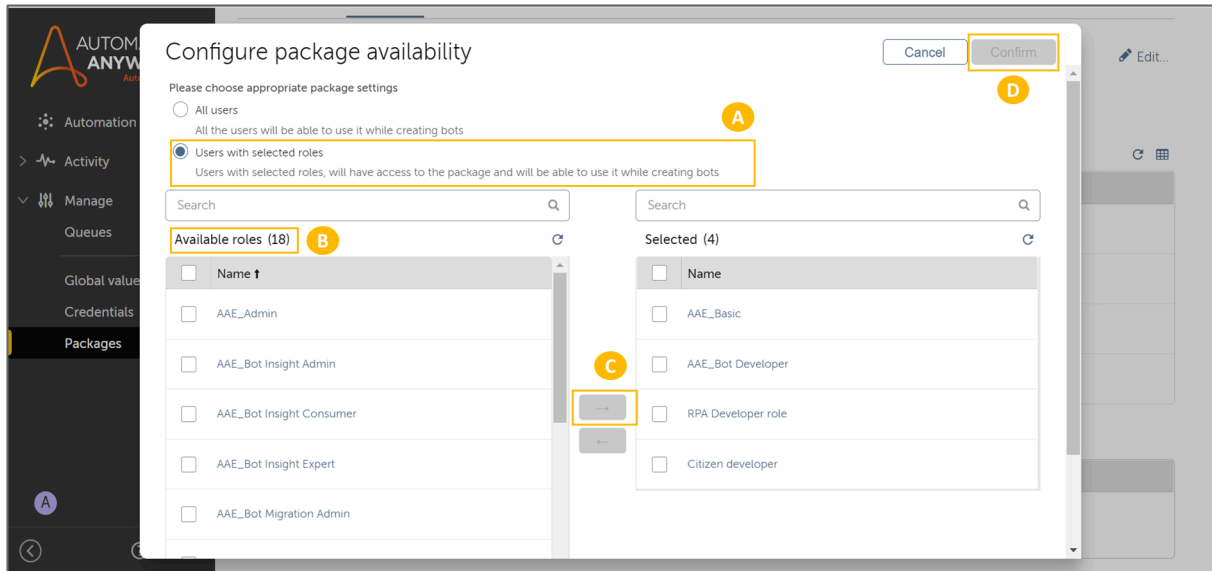

The availability tab shows the selected roles for whom the specific package is now enabled.

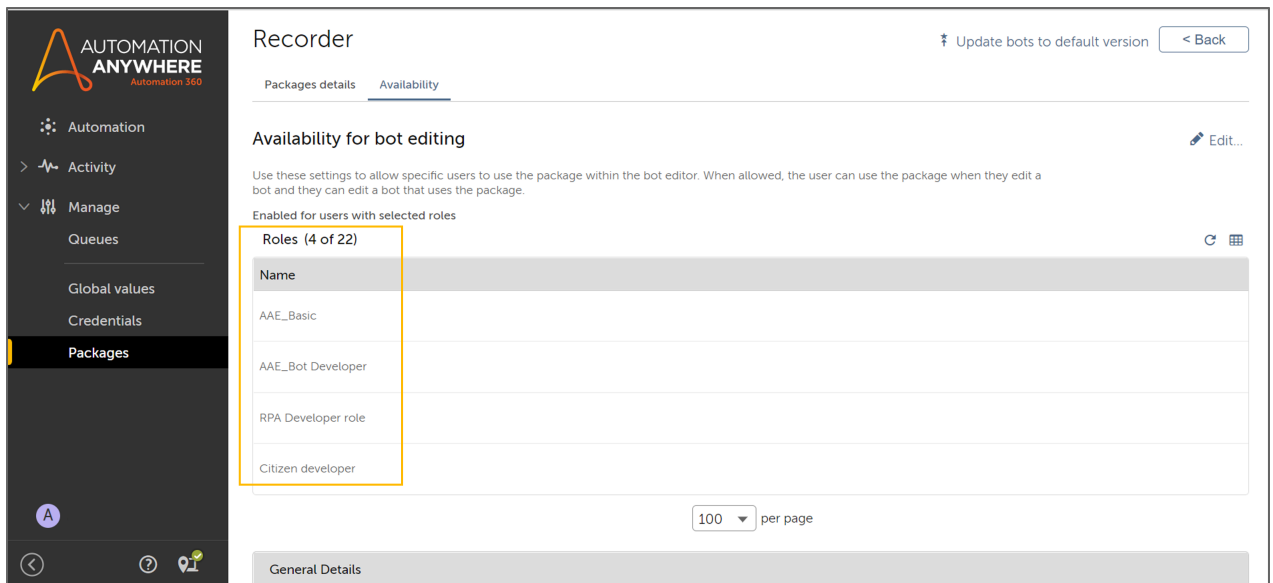

Packages RBAC for bot developer

As a Bot Creator (RPA developer) or Citizen Developer, you can create bots based on the packages that are available to you.

You can use only those package-defined actions, triggers, variables, and customized packages for which you have access. Your access to these packages are set by the administrator based on user roles. If you do not have access to a package, you cannot view that package on the **Actions** palette.

RBAC on packages applies when you create or edit bots in your private workspace. You cannot run bots with restricted packages directly. However, you can use a cloned bot as a sub bot in another main bot and run this bot in a public or private workspace.

When a bot contains packages (or packages that you cannot access), keep in mind these considerations:

- You cannot perform these bot actions:
 - Run a bot: Either a new bot or a checked-out bot with changes
 - Check in a bot

If you try to perform these actions, an error message is displayed that the bot contains packages that are restricted.

- While editing variables, you cannot use variable property options related to restricted packages.

An error message is displayed that the variable is related to a package that is restricted.

- You cannot run a bot with triggers:
 - From the Bot editor, when you run a bot with a trigger that contains a restricted package, see an error message is displayed that the bot with triggers contains a restricted package.
 - When a trigger event is configured for a user and a device, and the trigger event occurs on the device, access to the bot package is verified. If the bot contains a restricted package, the bot fails, and an audit log entry is recorded.

Add packages to the Control Room

Administrators can add packages to the Control Room for use by Bot Creators.

Ensure that you are logged in to the as the administrator.

You can add a package from either Bot Store or another source.

To add a package from a source other than Bot Store, follow these steps:

1. Navigate to **Manage > Packages**.
2. Click **Add package**.
3. Click **Browse**.
4. Locate and select the package to add to the Control Room.
Packages are Java Archive (JAR) files that contain actions used to create bots.
5. Click **Upload package**.
6. On the **Bots > Packages > Confirm package** page, choose any of the following options:
 - **Accept, enable and set as default:** Uploads and enables the selected package, and sets it to the default package for the Control Room.
 - **Accept and enable:** Uploads and enables the package, but the package is not set as the default package. Bot Creators have to specifically select non-default packages to use them for creating bots.
 - **Accept but disable:** Uploads and disables the new package.

Choosing **Reject** stops the upload process.

To add a package from Bot Store, see the following video:

7. After installation, click **Administration > Packages** to verify that the package is added.
When you add or update a package in the Control Room, a notification is also sent through the **Notifications** icon. This notification is sent to the Control Room users who have the **View package** permission. For more information, see [Add or update package](#) event notification.

Related concepts

[Build and test a demo package and bot](#)

This practical how to section demonstrates that creating, changing, and managing packages allow you to customize actions and efficiently manage packages for all Control Room users.

Related tasks

[Manage Control Room packages](#)

Manage packages in the Control Room by setting a package as default, disabling it, or deleting it.

Manage Control Room packages

Manage packages in the Control Room by setting a package as default, disabling it, or deleting it.

Ensure that you are logged in to the as the administrator.

To manage packages in the Control Room, users must have **Manage package** permission.

Package management actions apply to all users; however, the user can select specific package versions within a bot.

1. Navigate to **Manage > Packages**.
2. Hover over the **Actions** icon for the package.
3. Click **View**.
4. Choose any of the following options:

Option	Description
Set as default	Select a package and set it as the default. As soon as a package is set to default, it is the package that all Bot Creators in the Control Room use. Note: By default, new versions of packages become the default version and will only be used the first time that package is used in editing a bot. If a bot already uses the package, it continues to use an earlier version.
Disable	Disable a package so that users cannot use it to create new bots. Bots that were created using a disabled package continue to work.
Delete	Deleting a package removes the actions contained in the package from the Control Room for all users.

Important: A package cannot be deleted if it is being used by a bot.

Related concepts

[Packages](#)

Users with the **Manage package** permission can upload and manage packages. Automation Anywhere provides you with the flexibility to decide which packages you want to make available to the Bot Creators for creating bots.

Related tasks

[Add packages to the Control Room](#)

Administrators can add packages to the Control Room for use by Bot Creators.

Update bots to default package version

You can perform a bulk update to existing bots in the Control Room repository to set the default version for any package. This feature enables a quick update to a secure, stable package version across bots.

- To update bots to the default package version, ensure you have the **View packages permission** and the **permission to edit bots**.

When you begin the bulk update process, this action will update bots for which you have check-out permission and bots using the non-default version of the specific package.

- Verify the bots are compatible with the current default version of the package.
- When you updating bots to the default package version, ensure the bots are not checked out until the process is complete.
- Do not disable the package when the bulk update process is running.

Note:

- Updating bots in bulk to use the default package version might affect the performance of the Control Room repository or other Control Room features.
- When you perform bulk updates to existing bots to set the default versions for packages, ensure that you wait until the bulk update process for one package is completed and only then start updating another package.

1. Navigate to **Manage > Packages**.

2. Search for the package that you want to update across bots.

3. To set the default package version in all the bots in the public workspace, click **Update bots to default package version**.

4. In the **Update bots to default package version** window, enter the following information:

- **Activity name:** Name of the initiated process for bulk updating package version across all the bots.

On the **Audit** log page, when you select **Update default package to bot requested** or **Update default package to bot completed** to view the details of the item name, the activity name is displayed as a request name with its value.

- **Description:** Optionally provide a description for this activity.
- **Check-in comments:** This field is already populated with the version details of the package you are updating.

You can enter a meaningful comment that helps with any future reference. This check-in comment can be viewed on the **View history** page. For example, navigate to **Automation > Public > Folder > Task Bot**. Click the vertical ellipsis and select **View history Task Bot** to view the bulk check-in message for new versions of the bots created through the bulk update.

Note: Running the bulk update process will **not** impact any existing schedules or bot runs. For schedules, the bots with Production label applied will continue to deploy the production version and not the latest version.

5. Click **Update Bots**.

6. Click **Yes, continue**.

The system starts updating all the bots in the Control Room repository that uses the package. If any of the bots are not using the default version of the packages, these bots will be updated.

7. Navigate to **Administration > Audit log**.
8. On the **Audit log** page, search by the event type **Update default package**.
View information such as start of the requested process, individual bots that are being updated with the default package version, and the completion of the requested process. You can also view the following item names in the **Audit log** for this information:
 - **Update default package to bot requested**
 - List of bots that are being updated, for example, `Payrollprocess2022` bot
 - **Update default package to bot completed**
9. To view details about all the bots that were updated to use the default package version, copy the **Request ID** from the **Update default package to bot requested** page. On the **Audit log** page, search by **Request ID** filter and enter the value.
For example, use `d6adb0724340666e`. The **Audit log** page displays all the bots that are successfully updated through the **Update bots to default version** process. The list also includes bots that failed the update process.
10. To view the details of each item name on the **Audit log** page, perform the following steps:
 - a) Click **Update default package to bot requested** and view the following details:
 - **Event details:** Displays information such as details of the user who submitted the request, the user's device details, the request ID number, date and time of the initiated request, and the package version details that will be updated across all the bots.
 - **Update default package details:** Displays information such as the name of the request, change in package version, name of the package being updated, and the version of the package you are currently on.

Depending on the package, all bots using the selected package will be updated one by one.

- b) Click any bot to view the following information:
 - **Request name:** Displays the name of the initiated request.
 - **Bot path:** Displays the file or folder path where the bot is located.
 - **Package name:** Displays the name of the package.
 - **Old package version:** Displays the version the package was on previously.
 - **Target package version:** Displays the version to which the package is being updated.
 - **Old bot version:** Displays the older version of the bot.
 - **New bot version:** Displays the current version of the bot that is being updated.

During the bulk update process, some bots might fail to update the default package version. The failed bot displays an unsuccessful status on the **Audit log** page. For example, if the bots are checked out during the update package process, the package version update is not performed for these bots and they fail.
- c) Click **Update default package to bot completed** to view the information after the bulk update process is completed:
 - Number of bots that are successfully updated.
 - Number of bots that failed to update due to compile-time errors or bots that were checked-out during the update package process.
 - Number of skipped bots.

If the bots are using the same package version, they will display as skipped during the update process.

 - The old package package number and the target (default) package version number.

For an example of this procedure, see [Example of updating default package version across bots](#).

Administrator settings

Control Room administrators manage settings related to the database, Credential Vault, users, roles, action packages, licensing, and more.

Related tasks

[Create a role](#)

As an administrator, you can configure roles with permissions to access features and perform operations such as create, edit, or delete a bot in the Control Room, and assign the role to a user.

[Create a user](#)

Create a user and assign their specific license based role.

[Installing additional licenses](#)

Upload new licenses to the Automation Anywhere Control Room to be distributed to users as required.

[Create credential](#)

Create a credential and add the required attributes.

Audit log

View logs and details to record user activities.

Audit Log displays a read-only table of records of actions performed by users. These log records are searchable and exportable. Audit logs include both **Successful** and **Unsuccessful** actions attempted.

Actions

The following Audit log actions are enabled:

Note: Use your cursor to roll over the action button icons to identify specific functions.

Time filter

Users select from preset time filters or configure a custom time filter for log entries to view. The default time filter setting is **Last 24 hours**.

Search

Search the records. Select additional search filter criteria from the drop-down menu.

Tip: To search the exact phrase, enclose the search phrase within double quotes (for example, "Taylor-Finance-564").

Export checked items to CSV

Export the data to a CSV file based on filters and or selections.

Refresh

Refresh and view the updated status.

Customize columns

Show or hide specific columns.

View

To view details of a table entry, mouse over the entry to expand and click **Audit details**.

Audit log table

View the following audit details in the table.

Table item	Description
Status	Shows action status.
Time	Shows the date and time of the action performed.
Event Type	Shows the type of action performed.
Item Name	Shows the entity on which action was performed.
Event Started By	Shows the user that performed the action.
Source Device	Shows the device or machine name or IP address that was used to perform the action.
Source	Shows the component: Control Room, Enterprise Client or API, from where the action originated or was performed.
Request ID	Shows the unique identity number assigned to a specific set of user actions.

Bot life cycle audit logs

The entry shows the status of each stage of the bot life cycle.

Audit log entry	Success	Failure
Create automation	Bot was sent to the control room and was successfully compiled.	Check if the Control Room is up and running.

Audit log entry	Success	Failure
Bot Sent To Device	Control Room deployed the bot successfully on the specified device.	<p>Possible reasons for failure entry include:</p> <ul style="list-style-type: none"> • Check if you have configured the Node manager on the corresponding device correctly. • Check for the app Automation Anywhere Bot Manager in Add Remove Programs or in Control Panel > Uninstall a program. Try to reinstall by uninstalling and downloading the app again. • Try to reinstall by uninstalling and downloading the app again from Device Manager. • Ensure the device auto log in details are set correctly.
Run bot Deployed	The bot has started on the specified device.	<p>Possible reasons for failure entry include:</p> <ul style="list-style-type: none"> • Check if you have configured the Node manager on the corresponding device correctly. • Check for app Automation Anywhere Bot Manager in Add Remove Programs or in Control Panel > Uninstall a program. • Try to reinstall by uninstalling and downloading the app again from Device Manager. • Ensure device auto log in details are set correctly.

Audit log entry	Success	Failure
Run bot finished	Bot execution completed successfully.	Possible reasons for failure entry include: <ul style="list-style-type: none"> • Check for the bot execution progression in Activity In progress. • Check the code at the line where activity log has been paused for errors. • If it has paused at a message box, minimize all windows and check if the message box is in the background.
Bot Runner Session Continued	Control Room deploys the TaskBots in a sequence for the same RDP session.	
Bot Runner Session Released	When a task successfully completes the execution.	
Download file	Downloading to the Control Room.	
Upload file	Uploading a file to the Control Room.	
Bot Runner Session	Control Room gets the RDP session of Bot Runner machine.	

Syslog audit log

For on-premises deployments, the **SysLog Configuration** audit entry shows the Control Room server status when adding, editing, or deleting the system configuration. The Syslog details shows these attributes and their values:

- **Syslog Server Hostname:** Full qualified domain name (FQDN) or the IP address of the Syslog server used to deliver the log reports
- **Port:** Port used by the remote Syslog server to receive incoming Syslog records
- **Protocol:** TCP or UDP
- **Use Secure Connection:** TLS encrypted channel used to send Syslog records to the remote Syslog server

Audit log entry	Status	User action	SysLog details shows these attributes and their values
SysLog Configuration	Successful	Adds new values to an existing server	<ul style="list-style-type: none"> • Syslog Server Hostname • Port • Protocol • Use Secure Connection <p>For example: MyServer1.aa.com, 468, TCP, Enabled</p>
	Successful	Adds new values to multiple servers	<ul style="list-style-type: none"> • Syslog Server Hostname • Port • Protocol • Use Secure Connection <p>For example: MyServer1.aa.com, 468, TCP, Enabled MyServer2.aa.com, 333, TCP, Disabled</p>
	Successful	Edits existing server	<ul style="list-style-type: none"> • Syslog Server Hostname • Port • Protocol • Use Secure Connection <p>For example: Old Value MyServer1.aa.com, 468, TCP, Enabled New Value MyServer123.aa.com, 514, UDP, Disabled</p>

Audit log entry	Status	User action	SysLog details shows these attributes and their values
	Successful	Deletes existing server	<ul style="list-style-type: none"> • Syslog Server Hostname • Port • Protocol • Use Secure Connection <p>For example: MyServer1.aa.com, 468, TCP, Enabled</p>
SysLog Configuration	Unsuccessful	User attempted to save the system configuration; however, the Control Room was not able to save the configuration.	For an unsuccessful status, you can use the results to troubleshoot the issue. Examples: Invalid Protocol, or Could not save SysLog settings. Invalid Host.

External key vault audit log

For cloud deployments, the **External key vault configuration** audit entry shows the type of external key vault configured (if any). Automation Anywhere supports these external key vaults:

- AWS Secrets Manager
- Azure Key Vault
- CyberArk Password Vault

Based on the type of external key vault configured, the external key vault configuration details shows different attributes and their values.

Audit log entry	External key vault	User action	Configuration details shows these attributes and their values
External key vault configuration	AWS Secrets Manager	Adds a new AWS Secrets Manager when there was previously no external key vault.	<ul style="list-style-type: none"> External key vault value: Changes from no external key vault to AWS Secrets Manager. AWS Secrets Manager value is Enabled Region value is set to (for example) us-east-1
	CyberArk	Adds a new CyberArk Password Vault when there was previously no external key vault.	<ul style="list-style-type: none"> External key vault value: Changes from no external key vault to CyberArk. CyberArk value is Enabled Vault URL is the CyberArk AIM server CCP API URL and is set to (for example) https://<hostname:port_num>/ Application ID is the CCP API AppID and is set to (for example) AAERoom

Audit log entry	External key vault	User action	Configuration details shows these attributes and their values
	Azure Key vault	Adds a new Azure Key vault when there was previously no external key vault.	<ul style="list-style-type: none"> External key vault value: Changes from no external key vault to Azure Key vault. Azure Key vault value is Enabled Vault URL is the Azure Key Vault URL and is set to (for example) <code>https://user-db-vault.vault.azure.net/</code> Client ID is the (application) ID of an App Registration in the tenant and is set to (for example) <code>536145</code> Tenant ID is the Azure Active Directory tenant (directory) ID and is set to (for example) <code>89D12L</code>
External key vault configuration	Change from AWS Secrets Manager to CyberArk	User changes from one external key vault to another type.	External key vault value changes from AWS Secrets Manger to CyberArk

Automation Anywhere Robotic Interface (AARI) Audit logs

The entry shows the status of events relating to requests, teams, scheduler, process setups, bot setups, human tasks, and bot tasks that you have created, deleted, updated, submitted, or recovered.

Audit log entry	Success
AARI Team	<ul style="list-style-type: none"> When a team is created by a user When a team is edited by a user When a team is deleted by a user

Audit log entry	Success
AARI Request	<ul style="list-style-type: none"> When a request is deleted by a user When a request is recycled by a user When a request is recovered by a user
AARI Human Task	<ul style="list-style-type: none"> When a task is edited by a user When a task is submitted by a user When a task is canceled by a user When a task is assigned by a user to another user When a task is canceled (using a cancel type of action by a user or by a bot (AARI Web package))
AARI Bot Task	When the process launched a bot task
AARI Process	<ul style="list-style-type: none"> When a process is created When a process is edited by a user
AARI Bot Setup	<ul style="list-style-type: none"> When a new bot is added to the bot setup management When the bot setup management is modified When a bot is deleted by a user
Process Scheduler	When the scheduler configuration is modified

Audit events list

Review the list of audit events to identify the type of audit entries that are logged in the Control Room for Automation 360.

General audit entries

The following table shows a list of general audit entries and their descriptions (listed alphabetically):

Audit entries	Description
Accept end user license agreement	This action is logged when the user accepts the license agreement.
Activate automation	This action is logged when the user activates the schedule.
Add credential	This action is logged when the user creates credentials.
Add Global value	This action is logged when the user creates a new global value.
Add locker	This action is logged when the user creates the locker.

Audit entries	Description
Add manual dependency	This action is logged when the user adds manual dependency to a bot.
Add MFA token	This action is logged when the user adds the MFA (multi-factor authentication) token.
Allocate license	This action is logged when the user creates a user with a particular license (such as Bot Creator or Bot Runner) and when the user changes the license from Bot. This action is logged when the user creates a user with a particular license (such as Bot Creator or Bot Runner) and when the user changes the license from Bot Creator to Bot Runner and vice versa.
API-Key duration	This action is logged when the user changes the duration for how long a generated API-Key is valid to authenticate users.
Audit error	This action is logged when an audit error occurs.
Audit migration finished	This action is logged when migration is completed.
Audit migration started	This action is logged when migration is started.
Audit unset activity type	This action is logged when there is an unset activity type.
Automation complete	This action is logged when a schedule completes.
Auto-login credentials not set	This action is logged when auto-login credentials have not been set for the user.
BOT_AGENT_BULK_INSTALLATION	This action is logged when the user changes the option to generate a registration key to perform bulk installation of Bot Agents on multiple devices.
Bot runner session	This action is logged when a Bot runner session occurs.
Bot sent to device	This action is logged when a bot is sent to a device.
Bot sent to device failed due to configuration update	This action is logged when a bot fails to be sent to a device because a device configuration upgrade is in progress.
Bot validation setting	This action is logged when a user sets the bot validation setting.
Callback request	This action is logged when a callback is requested.
Callback URL validation failed	This action is logged when the callback URL is invalid and does not appear on the white list.
Certificate authentication configuration create	This action is logged when a user creates certificate authentication settings.

Audit entries	Description
Certificate authentication configuration update	This action is logged when a user modifies the certificate authentication configuration.
Certificate authentication TLS host configuration create	This action is logged when a user creates a certificate authentication TLS host server configuration.
Certificate authentication TLS host configuration reinstall	This action is logged when a user reinstalls a certificate authentication TLS host server configuration.
Certificate authentication TLS host configuration update	This action is logged when a user modifies a certificate authentication TLS host server configuration.
Change settings	This action is logged when the user changes any setting such as On to Off, or Off to On.
Check in	This action is logged when a check in occurs.
Check in request	This action is logged when a check in is requested.
Check out	This action is logged when a checkout occurs.
Check out request	This action is logged when a check out is requested.
Client log in	This action is logged when a client logs in.
Clone	This action is logged when a user clones an object.
Cloud burst mode	This action is logged when a cloud burst occurs.
Cloud-enabled provisioning success	This action is logged when a cloud is successfully provisioned.
Cloud-enabled provisioning failure	This action is logged when cloud provisioning fails.
Configure credential vault	This action is logged when a user configures a credential vault.
Connect credential vault	This action is logged when a user connects a credential vault.
Control Room configurations	This action is logged when a user edits general configuration settings to the Control Room.
Control Room upgrade available	This action is logged when an upgrade to the Control Room is available.
Control Room upgrade email notification	This action is logged when an email has been sent to indicate a successful upgrade to the Control Room.
Control Room upgrade failure	This action is logged when an upgrade to the Control Room has failed.
Control Room upgrade success	This action is logged when an upgrade to the Control Room has completed successfully.

Audit entries	Description
Create automation	This action is logged when the user creates a new schedule or runs a bot with a queue in workload management.
Create domain	This action is logged when the user creates a new domain.
Create draft of queue	This action is logged when the user saves the work item as draft in workload management.
Create folder	This action is logged when the user creates a new folder.
Create learning instance	This action is logged when the user creates a new learning instance.
Create package	This action is logged when the user creates a new package.
Create proxy credentials	This action is logged when the user creates new proxy credentials.
Create queue	This action is logged when the user creates a new queue in workload management.
Create queue failed	This action is logged when a queue creation fails.
Create role	This action is logged when the user creates a new role.
Create user	This action is logged when a new user is created.
Create work item	This action is logged when new work items are added to a queue.
Create work item failed	This action is logged when new work items failed to add to a queue.
Credential vault settings	This action is logged when a user defines credential vault settings.
Deactivate automation	This action is logged when the scheduled automation is deactivated.
Delete automation	This action is logged when the user deletes the schedule.
Delete bot	This action is logged when the user deletes a bot.
Delete credential	This action is logged when the user deletes credentials.
Delete device	This action is logged when the user deletes a device.
Delete file	This action is logged when the user deletes a file.
Delete folder	This action is logged when the user deletes a folder.
Delete Git settings	This action is logged when the user deletes Git repository settings in the Control Room.

Audit entries	Description
Delete Global value	This action is logged when the user deletes the global value.
Delete learning instance	This action is logged when the user deletes an existing learning instance.
Delete locker	This action is logged when the user deletes a locker.
Delete MFA token	This action is logged when the user deletes the MFA (multi-factor authentication) token.
Delete proxy credentials	This action is logged when the user deletes proxy credentials.
Delete queue	This action is logged when the user deletes the queue in workload management.
Delete queue failed	This action is logged when the user fails to delete a queue.
Delete role	This action is logged when the user deletes roles from the system.
Delete tenant BLM clean up	This action is logged when the Bot Lifecycle Management (BLM) performs clean up for a deleted tenant.
Delete user	This action is logged when the user delete users from the system.
Delete work item	This action is logged when the user deletes the work item from the queue.
Delete work item failed	This action is logged when the user fails to delete work items in a queue.
Deployment automation	This action is logged when a bot is deployed to run.
Deployment queued	This action is logged when a deployment has been queued to run.
Device acquired by user	This action is logged when the device has been acquired by the user.
Device configuration update initiated	This action is logged when the user initiates the device configuration update.
Device details updated	This action is logged when the device details have been successfully updated.
Device not available to acquire	This action is logged when the device is unavailable to be acquired by the user.
Device registered	This action is logged when the user registers a device.
Device update configured	This action is logged when the user changes the option to install or update the Bot Agent software.

Audit entries	Description
Device type update settings	This action is logged when the settings of a device type are updated.
Disable package	This action is logged when the user disables a package.
Disable user	This action is logged when the user disables another user in the system.
Domain credential reset	This action is logged when the user resets or reconnects to the Active Directory domain from the settings page.
Download bot	This action is logged when a user downloads a bot.
Download bot finished	This action is logged when the Bot Store completes downloading a bot.
Download file	This action is logged when a user downloads a file.
Edit bot	This action is logged when the user modifies a bot.
Edit domain	This action is logged when the user modifies a domain.
Edit learning instance	<p>This action is logged when the user edits any of the following settings of an existing learning instance:</p> <ul style="list-style-type: none"> • Edits the name • Edits or adds a description • Uploads staging documents • Adds new fields • Edits new group setting • Edits default validations groups setting
Edit role	This action is logged when the user modifies a role.
Edit role - folder permissions	This action is logged when a user changes the folder permissions of an existing role.
Edit settings	This action is logged when the user modifies settings.
Edit user	This action is logged when the user modifies another user.
Elasticsearch backup	This action is logged when the user provides a backup IP address in the Elasticsearch disaster recovery backup cluster.
Elasticsearch delete index	This action is logged when the user deletes an index from the Elasticsearch.
Email notification	This action is logged when email notification connection or authentication fails.

Audit entries	Description
Email notification settings	This action is logged when the user modifies email notification settings.
Empty pools	This action is logged when there are empty pool IDs.
Enable package	This action is logged when the user enables a package.
Enable user	This action is logged when the user enables another user in the system.
Execute automation	This action is logged when the user executes a bot.
Export bot	This action is logged when the user exports a bot.
Export domain	This action is logged when the user exports any of the domains from the IQ Bot application.
Export learning instance	This action is logged when the user exports a learning instance (<i>.iqba file</i>) through the migration utility.
Export queue	This action is logged when the user exports a queue from workload management.
Export request	This action is logged when the user generates an export request.
Export to csv	This action is logged when the user exports data to a csv.
Failed to acquire user or device	This action is logged when the device or user is unavailable to be acquired.
Failsafe status updated	This action is logged when a failsafe status has been updated.
File upload settings	This action is logged when the user changes the file upload settings to restrict or allow the upload of executable files to a malicious file upload.
First Administrator settings	This action is logged when a user configures the first Administrator user in the Control Room.
Force unlock bot	This action is logged when a user unlocks a bot.
GDPR report	This action is logged when a user enables GDPR (General Data Protection Regulation) reporting.
Generate API-Key	This action is logged when an Admin user generates an API key from the My Settings page, which can be used to obtain an authentication token. This audit entry shows the generate API key status as either Successful or Unsuccessful.

Audit entries	Description
Git push	This action is logged when the user synchronizes information between the built-in Git repository and the remote Git host.
Git restore	This action is logged when the user restores all of their bots and associated dependent files from the Git repository to a new database.
Git restore abort	This action is logged when the user aborts to restore all of their bots and associated dependent files from the Git repository to a new database.
Git restore reset	This action is logged when the user resets to restore all of their bots and associated dependent files from the Git repository to a new database.
Import bot	This action is logged when the user imports a bot.
Import domain	This action is logged when the user imports any new domains to IQ Bot.
Import learning instance	This action is logged when the user imports a learning instance (<i>.iqba file</i>) through the migration utility.
Import queue	This action is logged when the user imports a queue into workload management.
Import request	This action is logged when the user generates an import request.
Install license	This action is logged when the user installs or changes the license from the license page.
IP address access	This action is logged when the IP address has been accessed.
License migration	This action is logged when a license is migrated to another user.
License mode change	This action is logged when the user changes the license mode.
Load work items from file	This action is logged when the user selects a CSV or Excel file and uploads the work item in a queue.
Log in banner settings	This action is logged when an Admin configures banner text to display on the login page of the Control Room.
Migration finished	This action is logged when a migration completes.
Migration started	This action is logged when a migration begins.
Move automation to history	This action is logged when the user moves the selected activity to the Historical page.

Audit entries	Description
No access to pool	This action is logged when a user has no access to a device pool.
Override Global value	This action is logged when users override a global value with their own private value.
Password settings	This action is logged when an Admin configures password settings for the Control Room.
Read credential	This action is logged when the logged-in user accesses the credentials of another user for which they do have permission for because the user is not a consumer for the credential or a credential owner.
Read locker	This action is logged when the logged-in user accesses the locker of another user for which they do not have permission because they are not part of a locker as a member (owner, manager, participant, or consumer).
Register app	This action is logged when the user configures IQ Bot.
Release license	This action is logged when the user changes the license from Bot Runner to Bot Creator or Admin.
Release user license	This action is logged when the user changes the user license.
Remove manual dependency	This action is logged when the manual dependency is removed from a bot.
Rename folder	This action is logged when the user renames the folder.
Resend email verification	This action is logged when the email is resent for verification.
Reset password	This action is logged when the user resets the password.
Revert checkout	This action is logged when the user reverts a previous check out action.
Rollback	This action is logged when the user rolls back to a previous version.
Run as user in use	This action is logged when the user runs a bot as the user using the bot.
Run as user invalid	This action is logged when a user who tries to run a bot and use the bot is invalid.
Run automation	This action is logged when the user runs an automation.
Save allowed IP addresses	This action is logged when the allowed IP addresses have been saved.

Audit entries	Description
Schedule misfired	This action is logged when the Control Room services starts or the server is available after more than 15 minutes of scheduled deployment time.
Security Settings - External key Vault - Configuration	For cloud deployments, this action is logged when a user makes a change to the external key vault configuration. Automation Anywhere supports these external key vaults: AWS Secrets Manager, Azure Key Vault, and CyberArk. This audit entry shows the status as either Successful or Unsuccessful.
Security Settings - Network settings	This action is logged when the user changes the configuration of the allowed IP address from where the authentication is restricted.
Send bot to production	This action is logged when the user moves the bot from staging to production.
Send bot to staging	This action is logged when the user moves the bot from production to staging.
Send email	This action is logged when an email is sent.
Send learning instance to production	This action is logged when the user moves the learning instance from staging to production.
Send learning instance to staging	This action is logged when the user moves the learning instance from production to staging.
Session timeout settings	This action is logged when the settings of a session timeout is reached.
Set default device	This action is logged when the user sets the default device.
Set device credentials	This action is logged when the user sets the device credentials.
Set Git settings	This action is logged when the user sets remote Git repository settings in the Control Room.
Sync license	This action is logged when a license is synced.
SysLog Configuration	For on-premises deployments, this action is logged when a user adds, edits, or deletes Syslog server configuration. This audit entry shows the Control Room server recording the status as either Successful or Unsuccessful.
Temporary devices cleanup job	This action is logged when the temporary device runs its cleanup job.
Test proxy connectivity	This action is logged when proxy connectivity is tested.
Time out	This action is logged when an operation times out.

Audit entries	Description
Train bot	This action is logged when the user creates a training bot.
Transfer credential ownership	This action is logged when the locker admin transfers the ownership of the credentials.
Trigger bot run	This action is logged when a bot runs due to a trigger.
Trigger bot run fail	This action is logged when a bot fails to run due to a trigger.
Trigger delete	This action is logged when a trigger is deleted.
Trigger delete failed	This action is logged when the deletion of a trigger fails.
Trusted CA key store update	This action is logged when a user modifies the trusted CA key store for certificate authentication.
Unable to send bot device	This action is logged when a bot fails to be sent to a device.
Undo checkout	This action is logged when the user reverses a check out.
Unlock credential vault	This action is logged when the user unlocks the credential vault.
Unset default device	This action is logged when the user changes the default device.
Update app registration	This action is logged when the IQ Bot URL is updated in the settings page.
Update automation	This action is logged when the user edits the schedule automation.
Update callback URL failed	This action is logged when the callback URL list has failed to update.
Update callback URL successful	This action is logged when the callback URL list has been updated successfully.
Update credential	This action is logged when the user modifies the credentials.
Update device auto download packages	This action is logged when the device updates its auto download packages settings.
Update device credentials	This action is logged when the device updates its credentials.
Update device general settings	This action is logged when the device updates its general settings.
Update device log settings	This action is logged when the device updates its log settings.
Update device RDP settings	This action is logged when the device updates its RDP (Remote Desktop Protocol) settings.

Audit entries	Description
Update device resolution settings	This action is logged when the device updates its resolution settings.
Update Git settings	This action is logged when the user updates remote Git repository settings in the Control Room.
Update Global value	This action is logged when the user updates an existing public global value.
Update locker	This action is logged when the user modifies the lockers.
Update MFA role	This action is logged when the user modifies the MFA (multi-factor authentication) role.
Update MFA settings	This action is logged when the user modifies the MFA (multi-factor authentication) settings.
Update MFA token	This action is logged when the user modifies the MFA (multi-factor authentication) token.
Update MFA user	This action is logged when the user modifies the two-factor authentication for a user.
Update package	This action is logged when the user updates an existing package.
Update package settings	This action is logged when the user updates any package settings.
Update proxy credentials	This action is logged when the user updates existing proxy credentials.
Update queue	This action is logged when the user updates the existing queue (for example, adding new work items to the same queue).
Update queue failed	This action is logged when the user fails to update the existing queue (for example, adding new work items to the same queue).
Update settings	This action is logged when the user updates any setting in Control Room.
Update temporary devices auto delete settings	This action is logged when the temporary device updates its auto delete settings.
Update work item	This action is logged when the user edits a work item.
Update work item failed	This action is logged when work items fail to update.
UPDATE_DEVICE_ADVANCED_OPTIONS_SETTINGS	This action is logged when the user changes the device environment settings such as: global cache location, auto-login timeout duration, and so on.

Audit entries	Description
UPDATE_DEVICE_THRESHOLD_SETTINGS	This action is logged when the user changes enables or disables the threshold settings such as: CPU utilization, device memory threshold values, and so on.
UPDATE_DEVICE_LOG_SETTINGS	This action is logged when the user changes the log collection settings such as: log collection, log size, and so on.
UPDATE_GLOBAL_AUTO_LOGIN_SETTINGS	This action is logged when the user changes the auto-login settings in the Control Room to either create user sessions, or reuse existing user sessions to reduce the bot startup time.
Upload	This action is logged when a user imports a file.
Upload bot	This action is logged when a user uploads a bot.
Upload document	This action is logged when a user uploads a document.
Upload file	This action is logged when a user uploads a file.
Upload package	This action is logged when the user uploads a package.
Upload work items file	This action is logged when the user updates a queue and adds work items.
User Authentication configuration	This action is logged when the user changes the Control Room database or SAML user authentication configuration.
User multiple log in	This action is logged when the user logs in to the Control Room from different browsers with the same username.
User log in	This action is logged when the user logs in to the Control Room.
User log out	This action is logged when the user logs out of the Control Room.
Validate learning instance	This action is logged when the user validates (either corrects the document and saves it or invalidates the document) a document in the validator of a learning instance.
Version control settings	This action is logged when the user updates any version control settings.
Websocket proxy connection failure	This action is logged when the websocket proxy connection fails.

AD audit entries

The following table shows the list of AD audit entries and their descriptions (listed alphabetically):

Audit entries	Description
AD group mapping created	This action is logged when the user creates an AD role mapping.
AD group mapping deleted	This action is logged when the user deletes an AD role mapping.
AD group mapping updated	This action is logged when the user updates an Active Directory role mapping.
AD sync role empty	This action is logged when an Active Directory role assigned with sync operations is empty.
AD sync role conflict	This action is logged when an Active Directory role assigned with sync operations is in conflict with another role.
AD sync role system assigned	This action is logged when new Active Directory roles are assigned with sync operations.
AD sync role system deleted	This action is logged when Active Directory roles are deleted with sync operations.
AD sync role system updated	This action is logged when Active Directory roles are updated with sync operations.
AD sync user count	This action is logged when the Active Directory user counts are synced.
AD sync user deleted	This action is logged when the Active Directory synced users are deleted.
AD sync user out of license	This action is logged when the Active Directory synced users run out of available licenses.

Bot Insight audit entries

The following table shows the list of Bot Insight audit entries and their descriptions (listed alphabetically):

Audit entries	Description
Bot Insight add user dashboard	This action is logged when a new user dashboard is added to Bot Insight.
Bot Insight BLM dashboard export	This action is logged when a user exports a BLM (Bot Lifecycle Management) dashboard from Bot Insight.
Bot Insight BLM dashboard import	This action is logged when a user imports a BLM (Bot Lifecycle Management) dashboard into Bot Insight.
Bot Insight create dashboard	This action is logged when a user creates a dashboard in Bot Insight.
Bot Insight copy dashboard	This action is logged when a user copies a dashboard in Bot Insight.
Bot Insight delete dashboard	This action is logged when a user deletes a dashboard from Bot Insight.

Audit entries	Description
Bot Insight delete user dashboard	This action is logged when a user dashboard is deleted from Bot Insight.
Bot Insight end task	This action is logged when a task ends in Bot Insight.
Bot Insight get task data	This action is logged when task data is retrieved in Bot Insight.
Bot Insight get user dashboards	This action is logged when user dashboards are retrieved in Bot Insight.
Bot Insight load dashboard	This action is logged when a user loads a dashboard in Bot Insight.
Bot Insight operations	This action is logged when operations occur in Bot Insight.
Bot Insight publish dashboard	This action is logged when a user publishes a dashboard in Bot Insight.
Bot Insight registers dashboard	This action is logged when a user registers a dashboard in Bot Insight.
Bot Insight run data	This action is logged when data runs in Bot Insight.
Bot Insight save dashboard	This action is logged when a user saves a dashboard in Bot Insight.
Bot Insight search dashboard	This action is logged when a user searches a dashboard in Bot Insight.
Bot Insight start task	This action is logged when a task starts in Bot Insight.
Bot Insight update dashboard	This action is logged when a user updates a dashboard in Bot Insight.
Bot Insight profile update	This action is logged when a user updates a data profile in Bot Insight.

Bot Store audit entries

The following table shows the list of Bot Store audit entries and their descriptions (listed alphabetically):

Audit entries	Description
Bot Store add to My bots	This action is logged when a user adds a bot to their My bots.
Bot Store clean up	This action is logged when clean up is performed for a deleted tenant.
Bot Store download	This action is logged when a user starts to download a bot from the Bot Store.
Bot Store log in	This action is logged when a user logs in to the Bot Store.

Audit entries	Description
Bot Store submit bots	This action is logged when a user submits bots to the Bot Store.

Device pool audit entries

The following table shows the list of device pool audit entries and their descriptions (listed alphabetically):

Audit entries	Description
Device pool created	This action is logged when the user successfully creates a new device pool.
Device pool creation failed	This action is logged when the user fails to create a device pool.
Device pool deleted	This action is logged when the user successfully deletes a device pool.
Device pool deletion failed	This action is logged when the user fails to delete a device pool.
Device pool update failed	This action is logged when the user fails to update an existing device pool.
Device pool updated	This action is logged when the user edits an existing device pool (for example, add a new device or add a new customer role).

Device update audit entries

The following table shows the list of device update audit entries and their descriptions (listed alphabetically):

Audit entries	Description
Device update acknowledged	This action is logged when the device update has been acknowledged.
Device update already in progress	This action is logged when the device update is already in progress.
Device update completed	This action is logged when the device update has completed.
Device update disconnected	This action is logged when the device update has been disconnected.
Device update downloaded	This action is logged when the device update has been downloaded.
Device update failed and max retry reached	This action is logged when the device update has failed after the maximum number of retries has been reached.

Audit entries	Description
Device update failed and max retry reset reached	This action is logged when the device update has failed but device will continue to retry the update.
Device update initiated	This action is logged when the user initiates the device update.
Device update settings	This action is logged when the settings of a device are updated.
Device update started	This action is logged when the device update has started.
Device update unavailable	This action is logged when the device update has already occurred and been updated.
Device update unsuccessful	This action is logged when the device update has been unsuccessful.
Device update waiting for deployments to complete	This action is logged when the device update is waiting for deployments to complete.

Discovery bot audit entries

The following table shows the list of Discovery bot audit entries and their descriptions (listed alphabetically):

Audit entries	Description
Discovery bot cancel recording	This action is logged when the discovery bot successfully cancels a recording.
Discovery bot convert to bot	This action is logged when the discovery bot successfully converts to a bot.
Discovery bot create aggregated recording	This action is logged when the discovery bot successfully creates a new aggregated recording.
Discovery bot create opportunity	This action is logged when the discovery bot successfully creates a new opportunity.
Discovery bot create process	This action is logged when the discovery bot successfully creates a new process.
Discovery bot create process assignment	This action is logged when the discovery bot successfully creates a new process assignment.
Discovery bot create project	This action is logged when the discovery bot successfully creates a new project.
Discovery bot create recording	This action is logged when the discovery bot successfully creates a new recording.
Discovery bot create recording step	This action is logged when the discovery bot successfully creates a new recording step.
Discovery bot create recording step metadata	This action is logged when the discovery bot successfully creates metadata for a new recording step.

Audit entries	Description
Discovery bot delete aggregated recording	This action is logged when the discovery bot successfully deletes an aggregated recording.
Discovery bot delete opportunity	This action is logged when the discovery bot successfully deletes an opportunity.
Discovery bot delete process	This action is logged when the discovery bot successfully deletes a process.
Discovery bot delete process assignment	This action is logged when the discovery bot successfully deletes a process assignment.
Discovery bot delete project	This action is logged when the discovery bot successfully deletes a project.
Discovery bot delete recording	This action is logged when the discovery bot successfully deletes a recording.
Discovery bot delete recording step	This action is logged when the discovery bot successfully deletes a recording step.
Discovery bot delete recording step metadata	This action is logged when the discovery bot successfully deletes metadata for a recording step.
Discovery bot export opportunity	This action is logged when the discovery bot exports an opportunity.
Discovery bot migrate opportunity	This action is logged when the discovery bot migrates an opportunity.
Discovery bot update aggregated recording	This action is logged when the discovery bot edits an existing aggregated recording.
Discovery bot update aggregated recording json	This action is logged when the discovery bot edits an existing aggregated recording using json.
Discovery bot update opportunity	This action is logged when the discovery bot edits an existing opportunity.
Discovery bot update process	This action is logged when the discovery bot edits an existing process.
Discovery bot update process assignment	This action is logged when the discovery bot edits an existing process assignment.
Discovery bot update project	This action is logged when the discovery bot edits an existing project.
Discovery bot update recording	This action is logged when the discovery bot edits an existing recording.
Discovery bot update recording step	This action is logged when the discovery bot edits an existing recording step.
Discovery bot update recording step metadata	This action is logged when the discovery bot edits metadata for an existing recording step.

Run bot audit entries

The following table shows the list of run bot audit entries and their descriptions (listed alphabetically):

Audit entries	Description
Run bot disconnected	This action is logged when a user disconnects a running bot.
Run bot finished	This action is logged when a running bot finishes.
Run bot paused	This action is logged when a user pauses a running bot.
Run bot pre process failed	This action is logged when the pre-process to run the bot fails.
Run bot reconnected	This action is logged when a user re-connects a running bot.
Run bot resumed	This action is logged when a previously paused bot resumes to run.
Run bot stopped	This action is logged when a user stops a running bot.

Run bot local audit entries

The following table shows the list of run bot local audit entries and their descriptions (listed alphabetically):

Audit entries	Description
Run bot local hotkey finished	This action is logged when a running bot for a local hotkey finishes.
Run bot local hotkey paused	This action is logged when a running bot for a local hotkey pauses.
Run bot local hotkey resumed	This action is logged when a running bot for a local hotkey resumes.
Run bot local hotkey started	This action is logged when a running bot for a local hotkey starts.
Run bot local hotkey stopped	This action is logged when a running bot for a local hotkey stops.
Run bot local hotkey suspended	This action is logged when a running bot for a local hotkey is suspended.
Run bot local schedule finished	This action is logged when a running bot for a local schedule finishes.
Run bot local schedule paused	This action is logged when a running bot for a local schedule pauses.
Run bot local schedule resumed	This action is logged when a running bot for a local schedule resumes.

Audit entries	Description
Run bot local schedule started	This action is logged when a running bot for a local schedule starts.
Run bot local schedule stopped	This action is logged when a running bot for a local schedule stops.
Run bot local schedule suspended	This action is logged when a running bot for a local schedule is suspended.
Run bot local trigger finished	This action is logged when a running bot for a local trigger finishes.
Run bot local trigger paused	This action is logged when a running bot for a local trigger pauses.
Run bot local trigger resumed	This action is logged when a running bot for a local trigger resumes.
Run bot local trigger started	This action is logged when a running bot for a local trigger starts.
Run bot local trigger stopped	This action is logged when a running bot for a local trigger stops.
Run bot local trigger suspended	This action is logged when a running bot for a local trigger is suspended.

Run logic local audit entries

The following table shows the list of run logic local audit entries and their descriptions (listed alphabetically):

Audit entries	Description
Run logic local client finished	This action is logged when running logic for a local client finishes.
Run logic local client paused	This action is logged when running logic for a local client pauses.
Run logic local client resumed	This action is logged when running logic for a local client resumes.
Run logic local client started	This action is logged when running logic for a local client starts.
Run logic local client stopped	This action is logged when running logic for a local client stops.
Run logic local client suspended	This action is logged when running logic for a local client is suspended.

Run workflow local audit entries

The following table shows the list of run workflow local audit entries and their descriptions (listed alphabetically):

Audit entries	Description
Run workflow local client finished	This action is logged when running a workflow for a local client finishes.
Run workflow local client started	This action is logged when running a workflow for a local client starts.
Run workflow local client stopped	This action is logged when running a workflow for a local client stops.
Run workflow local schedule finished	This action is logged when running a workflow for a local schedule finishes.
Run workflow local schedule started	This action is logged when running a workflow for a local schedule starts.
Run workflow local schedule stopped	This action is logged when running a workflow for a local schedule stops.
Run workflow local trigger finished	This action is logged when running a workflow for a local trigger finishes.
Run workflow local trigger started	This action is logged when running a workflow for a local trigger starts.
Run workflow local trigger stopped	This action is logged when running a workflow for a local trigger stops.

Schedule bot audit entries

The following table shows the list of schedule bot audit entries and their descriptions (listed alphabetically):

Audit entries	Description
Schedule bot disconnected	This action is logged when a scheduled bot is disconnected.
Schedule bot ended	This action is logged when a scheduled bot ends.
Schedule bot paused	This action is logged when a scheduled bot pauses.
Schedule bot reconnected	This action is logged when a scheduled bot is reconnected.
Schedule bot resumed	This action is logged when a scheduled bot resumes.
Schedule bot stopped	This action is logged when a scheduled bot stops.

Export audit data to CSV

Export Control Room log related data to a CSV file.

- You must have the *View_user* permission to export the basic information about other users to the CSV file.
- The source and the target Control Room instances must be running the same version.

- The source and the target Control Room instances must be of the same setup type: SSO with SSO, AD with AD, and non-AD with non-AD.

You can export selected, filtered, or all audit log data to a CSV file by using the following options:

- Export checked items**
- Export filtered items**
- Export all items**

1. Navigate to **Administration > Audit log**.

A list of all the logs is displayed.

2.



Click the **Export items to CSV** drop-down menu.

3. Click one of the following required sub-menus:

- Export checked items:** Exports only the selected records.

Note: You must select items to use this option.

- Export filtered items:** Exports only records that are available after applying filters like *Status*, *Item name*, *Event type*, and so on.
- Export all items:** Exports all the available records.

Note: You can export a maximum of 100,000 records at a time.

The CSV file is exported and downloaded to your local system based on the selected option.

Note:

- If there is large number of audit logs to export, a message is displayed, informing that the export function is started and exported CSV file is available in the **Activity > Historical** page. For more information, see [Download exported CSV file](#).
- The time required to export data to a CSV file might vary based on the number of records being exported. A message appears on the screen if the time required to export the data is more than 2 seconds. The CSV file is available for download after it is generated.

Also refer to [Syslog server integration](#).

Download exported CSV file

When there is large number of audit log data to export, the export function starts and exported CSV file is available in the **Activity > Historical** page.

To download the exported CSV file,

1. Navigate to the **Activity > Historical** page and search for exported audit log by using the *Audit-*



Export keyword.

A list of all the exported audit log files is displayed.

- Click the required item name hyperlink to view the audit log details.

Status	Item name	Automation priority	Device name	Bot name	User
Run failed	Audit-Export: cr-audit-20220818-103015-botcreator	Medium	Picked at run time	-	tamur
Completed	Audit-Export: cr-audit-20220818-103015-botcreator	Medium	Picked at run time	-	tamur

- Click **Download exported zip file**.

Device	Name + Description
Device Picked at run time	Name Audit-Export: cr-audit-20220818-103015-botcreator
User botcreator	Description ...

The CSV file is downloaded to your local system as a zip file.

Users

As an administrator, you can create, view, edit, delete, and enable or disable a user. Creating users steps vary depending on whether the user is a non-Active Directory, Active Directory, or single sign-on (SSO) user from an IdP server.

Column actions

- Click a column header to sort by ascending or descending order.
- Drag and drop a column header to move the column left or right.
- Drag the end of a column corner to re-size.

Individual user actions

Perform the following tasks on an individual user:

View

Opens the **View user** page in read-only mode. It shows user details, assigned roles, and general details such as **Last Modified**, **Modified by**, **Object type**, and **User type**.

You can edit a user detail and enable or disable a user.

Edit

Opens the **Edit user** page in write mode. You can update user details, device login credentials, assigned roles, and device licenses.

When you edit a user, an email is sent notifying the user if SMTP is enabled.

Only user devices with the Bot Agent installed at the system level are available for selection as the default device.

Enable | Disable

Activates or deactivates the user. When you enable or disable a user, an email is sent notifying the user if SMTP is enabled.

Delete

Deletes the user. This is useful when users leave an organization or move to another role. This frees

both the device to which the user was attached and the allocated license.

When you delete a user, an email is sent notifying the user if SMTP is enabled.

Note: Before removing a user from the active RPA, administrators should make certain all unfinished development of bots are checked-in.

Table-level actions

Perform the following tasks by hovering the mouse over the icons at the top-right of the **User** table. These actions can be performed only at a table-level and not on individual items.

Create role with checked items	Adds a role and assigns the selected users. <i>Create a user</i>
Delete checked items	Deletes the selected users. You cannot delete a user who is currently logged in.
Export to CSV	Exports the selected users in the table in CSV format.
Refresh	Refreshes the table and reflects the latest data.
Customize columns	Select the columns to show or hide in the table.

Create a user

Create a user and assign their specific license based role.

Ensure that you are logged in to the as the administrator.

1. Navigate to **Administration > Users**.
2. Click **Create user**.
3. Enter the required general details as follows:

Field	Value
Enable User	Select for the user to be activated and log in immediately. <hr/> Note: If this option is not selected, user will be in the inactive state and cannot log in. <hr/>
Username	Enter a unique user name.
Description	Enter a description for the user.
First name	Enter the first name for the user. <hr/> Note: The number of characters allowed in the First name field is 50. <hr/>

Field	Value
Last name	Enter the last name for the user. <hr/> Note: The number of characters allowed in the Last name field is 50. <hr/>
Password	Enter and confirm a password for the user. Ensure that the password follows all the necessary password policies.
Email	Enter and confirm the email address for the user. If SMTP is enabled, an email is sent to this address to confirm the account. All important Control Room notifications are sent to this email address.

4. Select the required role from the list of **Available roles**.

5. Click the right arrow (→) to add your selection.

6. Select **Allow** to allow multiple sessions.

You must be Control Room administrator to set a user as a multi-login service user. It is possible to set a user as a multi-login user either in the UI or API, however a user may only access multiple sessions through the API.

7. Assign a device license to the user.

Note: When you logged in as administrator, you cannot allocate any device license to the user and **None** option is selected by default.

License	Privilege
None	The user can access the Control Room only.
Bot Creator- Development license	Enables user to create and run bots. Auto login is enabled by default.
Unattended Bot Runner - Run-time license	Users with this license can perform all automation tasks that attended users can perform. Additionally, this license can also be used for Control Room deployment, centralized scheduling, and API-based deployment.
Attended Bot Runner - Run-time license	Users with this license can run bots on their devices and use any event trigger associated with their user account or role. However, these users cannot schedule bots.
Citizen Developer - Development license	Users with this license can create and run bots (including bots with triggers) on their devices.

The **Bypass legal disclaimer** option is automatically enabled to allow the user to run bots on a device without having to manually acknowledge a disclaimer.

After you select a device license, the **Device login credentials** are enabled. If you have the **Attest device credentials** permission, you can choose to attest the device credentials for this user to

bypass credential validation when you deploy bots. The Bot Runner user should have an unlocked and active user session.

Note: This works only if the auto login setting **Reuse an existing session** is selected in the Control Room by the administrator.

8. Click **Create user**.

Watch the following video on how to create a user in Automation 360:

Create an Active Directory user

Add the Active Directory user by selecting the AD domain, providing AD environment details, and assigning a role and device license.

Ensure that you are logged in to the as the administrator.

Note: Before removing a user, administrators should make certain all unfinished development of bots are checked-in.

1. Navigate to **Administration > Users**.

2. In the **General Details** section, enter the following information:

- a) **Enable User:** Select this option so that the user can log in immediately.
- b) **Active Directory domain:** Select the active directory name for the user.
The list displays all the domains that are available in the Active Directory domain controller.

Note: Control Room Active Directory supports single forest multi-domain environment.

c) **Username:** Click **CHECK NAME IN ACTIVE DIRECTORY**.

- If the user name is present in the Active Directory database, the **First name**, **Last name**, **Email**, and **Confirm email** fields are automatically populated.

If the data is not automatically populated, enter the details in the fields.

Note: You can use reserved characters, such as the comma (,), in the username.

- If the username is not present in the Active Directory database, an error message is displayed. Contact the network administrator to resolve the issue.

If SMTP is enabled, the user is sent an email to this address to confirm the account. All important Control Room notifications will be sent to this email address. You can use the "@" character to accommodate email user names.

Note: To support SSO over SAML, the User Principal Name (such as in Azure Active Directory) must match the corresponding username in the control room.

3. Select the required role from the list of **Available roles**.

4. Assign a device license to the user.

Note: When you logged in as administrator, you cannot allocate any device license to the user and **None** option is selected by default.

License	Privilege
None	The user can access the Control Room only.
Bot Creator- Development license	Enables user to create and run bots. Auto login is enabled by default.
Unattended Bot Runner - Run-time license	Users with this license can perform all automation tasks that attended users can perform. Additionally, this license can also be used for Control Room deployment, centralized scheduling, and API-based deployment.
Attended Bot Runner - Run-time license	Users with this license can run bots on their devices and use any event trigger associated with their user account or role. However, these users cannot schedule bots.
Citizen Developer - Development license	Users with this license can create and run bots (including bots with triggers) on their devices.

The **Bypass legal disclaimer** option is automatically enabled to allow the user to run bots on a device without having to manually acknowledge a disclaimer.

After you select a device license, the **Device login credentials** are enabled. If you have the **Attest device credentials** permission, you can choose to attest the device credentials for this user to bypass credential validation when you deploy bots. The Bot Runner user should have an unlocked and active user session.

Note: This works only if the auto login setting **Reuse an existing session** is selected in the Control Room by the administrator.

5. Click **Create user**.

Citizen Developer user

A Citizen Developer is a business user who can create and run bots, and share these automated tasks with peers. Citizen Developer is typically not a technical expert but a specialist such as a marketing analyst, HR manager, and accounts manager.

Overview

Users with bot creation capability can create, edit, run, or schedule bots on their device. While users with bot execution capability can access a public folder to run or schedule published bots. Citizen Developer users combine these capabilities to create bots, access the public folder, and clone published bots and run them on their devices.

Capabilities

In an organization, an administrator typically creates the Citizen Developer role with the necessary bot permissions and specifies the database or folder access. The administrator assigns this role to existing or new users and allocates the Citizen Developer license to them.

A Citizen Developer user can then perform the following tasks:

- Create bots and run them on their devices.
- Add and delete event triggers for bots on their devices.

Citizen developer user can create a private event trigger. However, the associated bot must be checked in to a public folder for other citizen developer or Bot Runner users to access that event trigger.

- Publish their bots to the public folder where other Citizen Developer users can access them.
- Access the public folder and clone published bots (including bots with triggers).
- Customize cloned bots and run them on their devices.
- Check in bots from their devices to the public folder.
- Check out bots from the public folder.

The following image illustrates the capabilities of a Citizen Developer user:

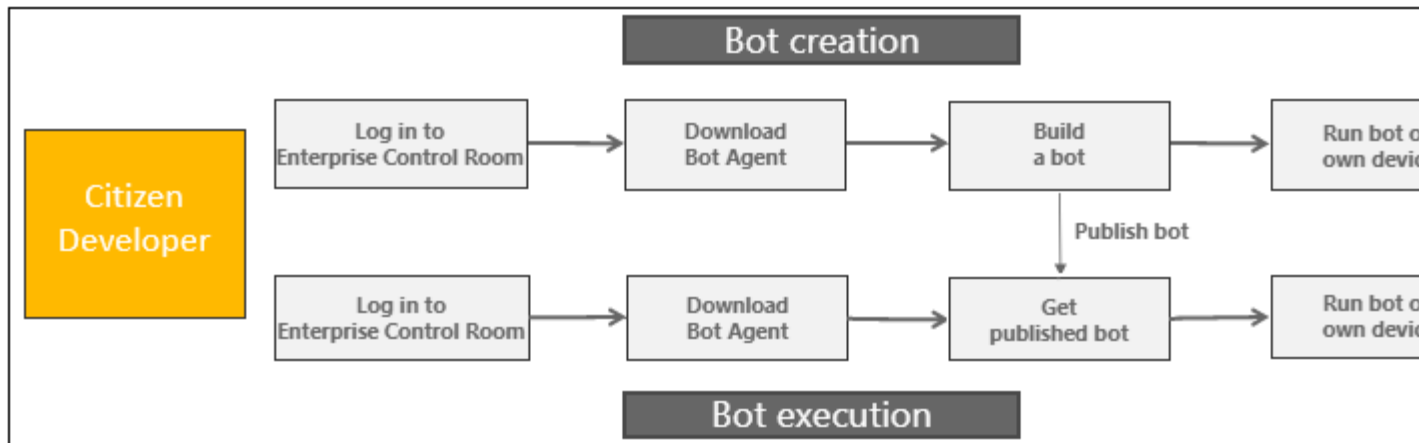

Example

Consider a scenario where an organization has Marketing and Finance teams. The administrator creates the following two Citizen Developer roles:

- CD (Marketing): provides access to all Marketing team folders
- CD (Finance): provides access to all Finance team folders

The administrator then assigns the Citizen Developer license to users within each team. Citizen Developer users with the CD (Marketing) role can create and run bots on their devices. When a user with the CD (Marketing) role publishes a bot to a public folder, other Citizen Developer users within the Marketing team can clone and run this bot on their devices.

Similarly, Citizen Developer users with the CD (Finance) role will have the same capabilities within the Finance team folders. However, users from one team cannot access any folders and published bots from the other team.

Related tasks

[Create a Citizen Developer user](#)

A Citizen Developer is a business user who can build and run bots on their devices, which then function as their digital assistants.

[Create a Citizen Developer role](#)

A Citizen Developer role enables the associated users to create and run bots on their registered devices.

[Adding event triggers](#)

Any bot with triggers can be associated with users or role to enable event trigger. Control Room user (or role) with **Manage event triggers** permission can add event triggers.

Related reference

[Automation 360 licenses](#)

The **All Licenses** page displays detailed information about current product and device licenses.

Create a Citizen Developer user

A Citizen Developer is a business user who can build and run bots on their devices, which then function as their digital assistants.

Ensure that you are logged in to the as the administrator.

1. Navigate to **Administration > Users**.
2. Click **Create user**.
3. Enter the following user details:
 - a) Select the **Enable User** option if you want the user to be able to log in immediately.
 - b) Enter a unique user name.
 - c) Optional: Enter a description for the user.
 - d) Optional: Enter the first name and last name.

Note: The number of characters allowed for the first and last name is 50.

- e) Enter and confirm a password for the user.
Ensure the password follows any necessary password policy.
- f) Enter and confirm the email address for the user.
If SMTP is enabled, the user is sent an email to this address to confirm the account. All Control Room notifications will be sent to this email address.
4. Select a Citizen Developer role from the list of **Available roles**.
If there is no Citizen Developer role available, create one in Control Room.

[Create a Citizen Developer role](#)

5. Click the right arrow (→) to add your selection.
6. Assign the Citizen Developer license to the user.
The license enables users access to the Control Room only and enables them to create and run bots.
The **Bypass legal disclaimer** option is automatically enabled to allow the user to run bots on a device without having to manually acknowledge a disclaimer.
7. Click **Create user**.

Multi-login user

A multi-login user can log in to multiple sessions of a Control Room through the API at the same time.

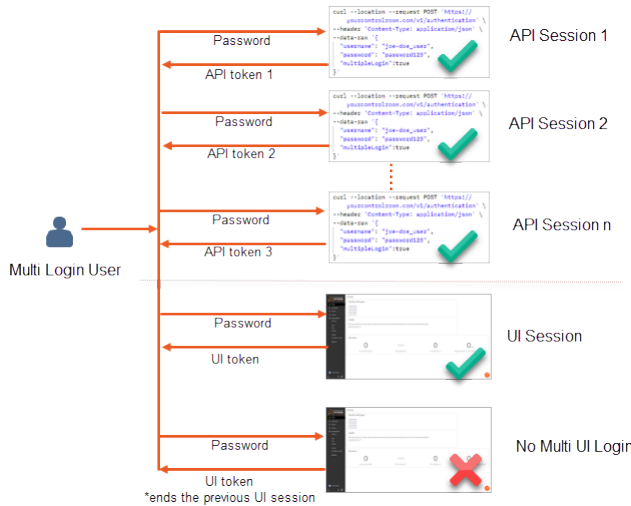

Note: Multiple sessions are not allowed for Control Room access through the UI.

A multi-login token is required if you want to configure a Control Room user to use different processes at the same time using multi tokens generate using the API. You need a Control Room administrator role to set a user as a multi-login service user. It is possible to set a user as a multi-login user either in the UI or API.

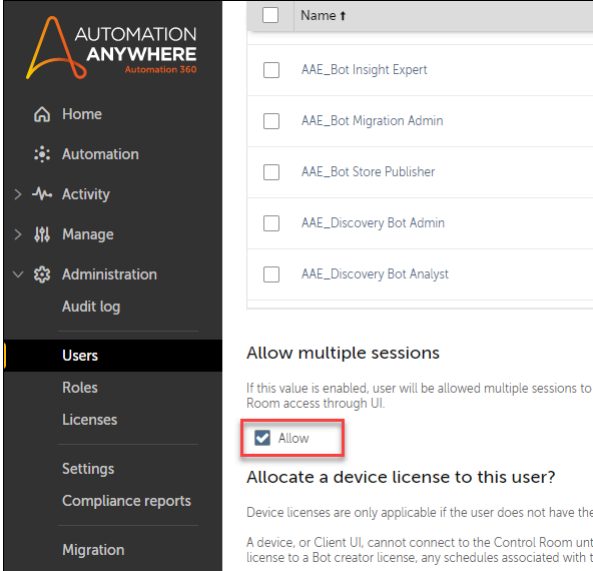
Authorize using UI	Authorize using API
<p>In the Control Room, go to Administration > Users and select Allow under Allow multiple sessions to enable multi-login.</p> 	<p>Using the <i>Authenticate (username and password)</i>: Request</p> <pre>POST http://{{ControlRoomURL}}/v1/authentication</pre> <p>Request body to generate multi-login token:</p> <pre>{ "username": "jdoe", "password": "mypassword@123", "multipleLogin": true }</pre>

Reset user password

The Control Room administrator generates an email process for the user to reset their password.

Ensure that you are logged in to the as the administrator.

The change password email process.

1. Navigate to **Administration > Users**.
2. Select user from the list.
3. Click the **Edit** icon. (✎)
4. Select **Send reset password email**.

Note: If there is no email server configured, follow these steps to reset the password for a user:

- a. Open the URL for the Control Room in your browser.
- b. Enter the user name, click **Forgot Password**, and follow the prompts to reset or change the password.
- c. Enter the user name, click the **Forgot Password** button, and follow the prompts to reset or change the password.

The selected user receives an email with the necessary instructions to reset the password.

Related tasks

[Log in to Automation Anywhere Control Room](#)

To log in to Automation 360, open the Control Room URL in your browser, enter your credentials in the login screen, and click **Log in**.

Roles

The Control Room enforces role-based access control. There are two types of roles: system and user-created.

Role-based access control (RBAC) gives users access to specific features, based on the assigned roles and the accessibility provided to the user. The benefits of creating roles include:

- Increased security through controlling users access according to their specified roles.
- Decreased need of customer support.
- Easy and accurate monitoring of the use and access of data by higher management, leading to better research management.

System roles

These roles are preconfigured with the permissions necessary to perform the tasks within the scope of that role. They cannot be modified or deleted.

System roles

User-created roles

Users create these roles and the roles can be customized. If a user-created role is created with all Control Room permissions, it is not considered a Control Room Admin role. Only the system-created **AAE_Admin** role has this privilege.

Create a role

Before removing a user role from the active RPA, administrators should make certain all unfinished development of bots are checked-in.

Create a role

As an administrator, you can configure roles with permissions to access features and perform operations such as create, edit, or delete a bot in the Control Room, and assign the role to a user.

Ensure that you are logged in to the as the administrator.

Assign specific permissions to each user. You cannot select users, if these users are deactivated by the Control Room administrator.

1. Navigate to **Administration > Roles**.

2. Click **Create role**.

3. Enter the **Name**.

4. Optional: Enter a description.

5. Select the feature permissions.

For more information about the available feature permissions by product, see [Feature permissions for a role](#).

6. Click **Next**.

7. Based on the option you select, perform the required action:

Option	Action
View my bots permission	Select the bots permissions. Bot permissions for a role
Run my bots permission	Select the Bot Runner devices.
View everyone's activity from my folders	View bot activity started by other users, from the folders where this user has run and or schedule permissions.
Manage everyone's activity from my folders	Manage bot activity, such as Pause , Resume , and Stop , started by different users from the folders where you have run and or schedule permissions.

8. Click **Next**.

9. Select user from the list.

10. Click **Create role**.

Related concepts

[Bot permissions for a role](#)

Assign bot permissions when creating a role with the **View my bots** feature permission.

Related reference

[System roles](#)

System roles are preconfigured with the permissions necessary to perform the tasks within the scope of that role. They cannot be modified or deleted. Administrators assign the roles to users to enable them to access features and perform operations in the Control Room.

Feature permissions for a role

A user with the **AAE_Admin** role or a custom role with the **Manage roles** permission can create and assign roles to users to provide them with access to features and operations.

We recommend that you create individual roles with specific permissions. You can then assign the limited roles to users with that specific permission requirement.

Automation Anywhere Robotic Interface (AARI)

Permission	Description
Cross Team Read	View all teams and see the team members
Cross Process Read	View all processes and see team members and managers
Team Management	Create and view teams, edit team names, descriptions, and process tags. Add new teams, team members, and assigned processes
Task Management	Submit and view tasks from processes that are assigned to the team
Case Management	Create and view requests from processes that are assigned to the team
Global Case Management	View process requests and tasks. Note: This permission does not grant the capability to create a request or submit a task
Global Process Management	View checked-in public processes and assigned managers and teams, edit process tags, and assign managers and teams Note: This permission does not grant the capability to create a process.
Global Team Management	View teams and assigned users, edit team names and descriptions. Add new processes, managers, and users to a team Note: This permission does not grant the capability to create a team.

API

Permission	Description
Bot Insight Data API	Allows access to Bot Insight RESTful APIs to the data logged by the Control Room and by a task during production runs.
Generate API-Key	Users can generate an apiKey that can be used in the Authentication API. <i>Authenticate (username and password)</i> Note: Users without the <code>generateapikey</code> permission can use APIs by authenticating using their username and password. <i>Authenticate (username and apiKey)</i>

Activity

Permission	Description
View my In progress activity	Allows users to view their own activity. <hr/> Note: All roles have this permission by default. <hr/>
Manage my In progress activity	Allows users to pause, resume, or cancel their own activity and move their finished activities to history.
View everyone's In progress activity	Allows users to monitor ongoing automations where the user has either run or schedule access on the respective bot.
Manage everyone's In progress activity	Allows users to pause, resume, or cancel their own activity and move their finished activities to history.
View my scheduled bots	Allows users to view their own schedules only.
Schedule my bots to run	Allows users to schedule their bots to run. In addition, users require permission to view and manage Bot Runners.
Edit my scheduled activity	Allows users to edit their own schedules only.
Delete my scheduled activity	Allows users to delete their own schedules only.
View and manage ALL scheduled activity from my Folders	Allows users to view, edit, and delete all the schedules on the bot folders to which they have access. It includes their own schedules and schedules created by other users too.
View and manage ALL scheduled activity	Allows users to view, edit, and delete all the schedules in the system. This includes the schedules that the user created or schedules created by other users.
Set automation priority to high	Allows users to set the automation priority to high to run and schedule bots. Automations with high priority are given preference over the medium and low priority automations so that you can run and schedule the high priority automations.

Audit log

Permission	Description
View everyone's audit log actions	Allows users to view all audit log activity for the Control Room.

Bots

Permission	Description
View my bots	<p>Allows users to view the bots they created and bots that were assigned to them.</p> <hr/> <p>Note: You must assign this permission before assigning any other bots permissions.</p>
Run my bots	Allows users to run the bots they created and bots that were assigned to them.
Export bots	Allows users to export bots and related bot dependencies for which they have download permission.
Import bots	Allows users to import bots and bot dependencies for which they have upload permission.
Label bots	<p>Allows users to create labels for a particular version of a bot. These labels allow the users to schedule, run, queue, export, and trigger bot development workflows with the version of their choice.</p> <hr/> <p>Note: The Set production version permission is redundant in Automation 360 although it might be displayed when you migrate bots from Enterprise 11. The Label bots permission is the equivalent of Set production version in Automation 360.</p> <p>If you want to select the Export bots option, you must select the Set production version permission in such cases. Also, if you want to provide the ability to set production version, you must select the Label bots permission.</p>
Create folders	Allows users to create folders within the folders that they have access to.
Rename folders	<p>Allows users to rename the folders to which they have access.</p> <hr/> <p>Note: Only empty folders can be renamed.</p>
Cancel checkout	Allows users to cancel bot checkout and unlock the file from the public repository.

Bot Store

Permission	Description
View Bot Store	Allows users to view Bot Store.
Add bots from Bot Store to My Bots	Allow users to add bot packages from Bot Store to their Control Room private workspace.
Submit bots to Bot Store	Allow users to submit bot packages to Bot Store.

Credentials and lockers

Permission	Description
Manage my lockers	Allows users to create and manage their own lockers.
Create standard attributes for a credential	Allows users to create a standard attribute for a credential that is shared across all users of that credential.
View and edit ALL credentials attributes value	<p>Allows users to view and edit their own masked attributes.</p> <hr/> <p>Note: You will not be allowed to edit other users credential attributes.</p> <hr/>
Bot Auto-Login Credentials API	Allow users to automate the login process to run bots remotely.

Note: A user with the `AAE_Locker Admin` role can view all credentials and lockers in the Control Room. See [System roles](#).

Dashboards

Permission	Description
View dashboards	<p>Allows users to view the dashboard.</p> <hr/> <p>Note: All roles have this permission by default.</p> <hr/>

Devices

Permission	Description
Register device	Allows users to register a local host device. Devices

Permission	Description
View and manage ALL devices	Allows users to view and manage all devices in the Control Room.
Attest device credentials	<p>Allows users to attest device credentials for Bot Runner users. You can deploy bots on user devices with unlocked and active user session without a system password to bypass credential validation.</p> <hr/> <p>Note: This permission works only if the auto-login setting Reuse an existing session is selected in the Control Room by the administrator.</p> <hr/>
Delete devices	Allows users to edit the devices that they have permission to see.
Edit the devices	<p>Allows users to edit the devices that they have permission to see.</p> <p>Allows you to view and manage all (registered and non-registered) devices from a specific accessible group.</p> <hr/> <p>Note: To view and manage registered and non-registered devices,</p> <ul style="list-style-type: none"> • The Control Room administrator must grant access to manage a specific set of devices. • You must select Devices from my device pool(s) to edit devices from device pools and Run as user(s) default device to edit Run as user(s) default device options in the Edit devices permission. <hr/>
View and manage myBot Creators, Bot Runners and device pools	<p>Allows users to view and manage Bot Creators, Bot Runners, and device pools.</p> <hr/> <p>Note: All roles have this permission by default.</p> <hr/>
Create device pools	Allows users to create and manage their own device pools.

Note: A user with the `AAE_Pool Admin` role can manage all device pools in the Control Room. See [System roles](#).

Discovery Bot process

Permission	Description
View assigned process	Allows users to view assigned processes. Note: This is the standard permission. You must assign this permission before assigning any process discovery permissions.
View all processes	Allows users to view all the defined processes.
Edit process	Allows users to create and edit processes.

Discovery Bot recording

Permission	Description
View all recordings	Allows users to view all recordings.
View own recording	Allows users to view their own recording. Note: You must assign this permission before assigning any of the following permissions.
Run recorder and create recording	Allows users to run the recorder and create recording.
Edit own recording	Allows users to edit their own recording.
Delete own recording	Allows users to delete their own recording.

Discovery Bot aggregation

Permission	Description
View all aggregation	Allows users to view all aggregations.
View own aggregation	Allows users to view their own aggregations. Note: You must assign this permission before assigning any of the permissions below.
Create or delete own aggregation	Allows users to create and delete aggregations.
Edit aggregation	Allows users to update aggregations.
View system generated aggregation	Allows users to view system aggregations.

Discovery Bot opportunity

Permission	Description
View all opportunities	Allows users to view all opportunities.
View opportunity	Allows users to view opportunities within assigned process. Note: You must assign this permission before assigning any of the permissions below.
Create or delete opportunity	Allows users to create and delete opportunities within the assigned process.
Convert to bot	Allows users to convert an opportunity to a bot.
Export opportunity	Allows users to export an opportunity.

Event triggers

Permission	Description
View event triggers	Allows users to view event triggers.
Manage event triggers	Allows users to view and manage event triggers. Note: You must assign the <code>view</code> permission before assigning this permission.

IQ Bot

Permission	Description
View IQ Bot	Allows users to view the default dashboards in the IQ Bot portal. Note: You must assign this permission before assigning any of the other IQ Bot permissions.

IQ Bot administration permissions

Permission ID	Description
View Administration	Allows users to access the Administration tab in the IQ Bot portal. Note: You must assign this permission before assigning any other administration permissions.
View and manage settings	Allows users to manage the IQ Bot portal advanced configuration settings.
View and manage migration	Allows users to access the migration utility to import and export learning instances in the IQ Bot portal.

IQ Bot domains permissions

Permission	Description
View domains	Allows users to view all domains in the IQ Bot portal. Note: You must assign this permission before assigning any other domain permissions.
Create domains	Allows users to create domains in the IQ Bot portal.
Import domains	Allows users to import domains in the IQ Bot portal.
Export domains	Allows users to export domains in the IQ Bot portal.

IQ Bot learning instance permissions

Permission	Description
View learning instances	Allows users to view their learning instances in the IQ Bot portal. Note: You must assign this permission before assigning any other learning instance permission.
View learning instances from the same role	Allows users to view learning instances created by other users with the same role in the IQ Bot portal.
View ALL learning instances	Allows users to view all learning instances in the IQ Bot portal.
Launch validator	Allows users to access the IQ Bot Validator to review and update documents with exceptions.

Permission	Description
Create learning instances	Allows users to create learning instances in the IQ Bot portal.
Edit learning instances	Allows users to edit learning instances in the IQ Bot portal.
Delete learning instances	Allows users to delete their learning instances in the IQ Bot portal.
Send learning instances to production	Allows users to send their learning instances to production in the IQ Bot portal.
Train learning instance groups	Allows users to train their learning instance groups in the IQ Bot portal.

Package manager

Permission	Description
View packages	Allows users to view packages.
Manage packages	Allows users to view and manage packages.

Licenses

Permission	Description
View licenses	Allows users to view the license details for the Control Room.
Manage user's device licenses	Allows users to assign device licenses to other users.
Install licenses	Allows users to install Automation 360 licenses for the Control Room.

Policies

Permission	Description
View policies	Allows users to view the policies which define how automations can be built.
Manage policies	Allows users to view and manage the policies which define how automations can be built.

Migration

Permission	Description
View migration	<p>Allows users to view new migrations, but not run them.</p> <hr/> <p>Note: You must assign this permission before assigning the <code>manage migration</code> permission.</p>
Manage migration	Allows users to view and run new migrations.
Allow a Bot Runner user to run migrations	Allows Bot Runner user to update the bot conversion status in the Control Room.

Settings

Note: Only a user with the `AAE_Admin` role has the capability to view and manage settings in the Control Room. See [System roles](#).

Users and roles

Permission	Description
View users	<p>Allows users to only view all other users in the system. They cannot create, edit, or delete users.</p> <hr/> <p>Note: You must assign this permission before assigning the <code>Create user</code>, <code>Update user</code>, or <code>Delete user</code> permission.</p>
Delete users	Allows users to delete other users the Control Room.
Create users	Allows users to create new users in the Control Room.
Edit users	Allows users to edit all users in the system.
View roles	<p>Users with this permission are able to view the roles in the Control Room.</p> <hr/> <p>Note: You must assign this permission before assigning the <code>Manage roles</code> permission.</p>
Manage roles	Allows users to view and manage all roles in the Control Room.
View users and roles basic information	Allows users to view basic information on users and roles in the Control Room.

Workload

Permission	Description
View and manage my queues	Allows users to view and manage their own schedules.
Create queues	Allows users to create and manage their own queues.
SLA Calculator	Allows users to calculate workload service-level agreements (SLA).

Note: A user with the `AAE_Queue Admin` role has all the workload permissions. In addition, the `AAE_Queue Admin` can manage all the queues in the Control Room. See [System roles](#).

Update Bot wizard permissions

You can assign feature permissions to access and convert a bot from Internet Explorer to Microsoft Edge with IE by using the **Update Bot wizard**. These permissions can be assigned from the **Administration > Roles > Create or edit roles** page.

Permission	Description
View bot update	Allows a user to view the status and summary of each bot update instance when the bots are converted on the Administration > Update Bot wizard page. However, the user cannot run the updates. To do that, a user needs the Manage bot update permission.
Manage bot update	Allows a user to run new bot updates by using the Update Bot wizard.
Allow a Bot Runner user to update bots	Allows Bot Runner users to send bot update status back to the Control Room so that it is visible in the Update Bot wizard report. This permission is assigned by default to the user with the AAE_Admin role.

Bot permissions for a role

Assign bot permissions when creating a role with the **View my bots** feature permission.

Permission	Description
Select all	Enables users to check in, check out, view, delete, run, and schedule bots.
Run/Schedule/Run and Schedule	Enables users to run and schedule bots when the role has the Run my bots and Schedule my bots to run feature permissions. Note: <ul style="list-style-type: none"> This permission is limited to running bots when the role has only the Run my bots feature permission.

Permission	Description
	<ul style="list-style-type: none"> This permission is limited to scheduling bots when the user has only the Schedule my bots to run feature permission.
Check in	Enables users to check in bot files or folders to the public workspace from their private workspace. When this permission is selected, the Clone and View content permissions are automatically enabled. These permissions can only be disabled by an user with the AAE_Admin role .
Check out	<p>Enables users to check out bot files or folders from the public workspace. It creates an editable copy of the bot in the private workspace. A bot can be checked out by one user at a time. When this permission is selected, the Clone and View content permissions are automatically enabled. These permissions cannot be disabled.</p> <p>Note: To check out dependent folders and files, you must have the Check out permission on the dependency folders.</p>
View content	<p>Enables users to view the contents of a bot. This permission applies to both the public and private workspaces. To create a copy of the cloned bot or file in the private workspace, you must have the View content permission on the same folder in the public workspace.</p> <p>Note: You must have the View content permission enabled to export a bot and its dependencies.</p>
Clone	<p>Enables users to create a read-only copy of the bot from the public workspace to their private workspace. A bot can be cloned by multiple users. The Clone permission must be assigned at the folder level for the bot in the public workspace. To clone a dependency folder, you must have the Clone permission on the dependency folder.</p> <p>Note:</p> <ul style="list-style-type: none"> If you have cloned a bot and the corresponding public folder is deleted, then there will be no classifications on the cloned bot in your private workspace. Copy, view, or delete permissions will be available at the bot level. You cannot move or rename a cloned bot in your private workspace. You must have the View content permission on the same folder in the public workspace to view the contents of your cloned bot in the private workspace.
Delete	Enables users to remove files and their dependencies from the public workspace.

Related tasks

[Create a role](#)

As an administrator, you can configure roles with permissions to access features and perform operations such as create, edit, or delete a bot in the Control Room, and assign the role to a user.

Create a Citizen Developer role

A Citizen Developer role enables the associated users to create and run bots on their registered devices.

Ensure that you are logged in to the as the administrator.

Although you can create a Citizen Developer role and assign additional custom bot permissions, ensure the role has all the feature permissions mentioned in this procedure.

1. Navigate to **Administration > Roles**.
2. Click **Create role**.
3. Enter the **Name**.
4. Optional: Enter a description.
5. Select the following feature permissions:

- Event triggers

Select the **View and manage my event triggers** option to allow the user to view, run trigger-based automation, or delete event triggers.

Note: The **View and Manage my event triggers** option is specific to the Citizen Developer license and can fail if it is assigned to users with Bot Creator or other licenses. Adding trigger events from the private repository is not supported.

- Bots

Select the **View my bots** option and the following permissions:

- **Run my bots**
- **Import bots**
- **Cancel checkout**

- Devices

Select the following permissions:

- **Register device**
- **View and manage ALL device(s)**
- **Edit the device(s)**

6. Click **Next**.
7. Click **Create role**.

A Citizen Developer role is created in the Control Room. You can create a Citizen Developer user and assign this role to that user.

[Create a Citizen Developer user](#)

Assign a role

Roles grant specific permissions to users, such as Bot Creators and Bot Runners.

Ensure that you are logged in to the as the administrator.

Assign specific permissions to each user. You cannot select users, if these users are deactivated by the Control Room administrator.

1. Navigate to **Administration > Roles**.
2. Click **Create role**.
3. Enter the **Name**.
4. Optional: Enter a description.
5. Set the required permissions for the role associated with this repository.
6. Click **Bots**.

7. Select the desired repository folder and grant associating permissions.

Option	Action
Select all	Grant all associated permissions for the repository.
Run	Permission to run bots from the repository.
Check in	Permission to import bots to the repository.
Check out	Permission to export the bot from of the repository.
Delete from Public	Permission to permanently remove bots from the Public repository.

8. Optional: Click **RUN AS**.

This is where administrators select the specific device this role will have access to.

9. Click **Create role**.

Assign this role to the appropriate Bot Creator users.

System roles

System roles are preconfigured with the permissions necessary to perform the tasks within the scope of that role. They cannot be modified or deleted. Administrators assign the roles to users to enable them to access features and perform operations in the Control Room.

Automation 360 roles

Role	Permissions	
<p>AAE_Admin</p> <p>This role allows access to all features, enables users to create other Admin users, and access to all folders and files in the public workspace, including permissions to Create/Edit/Delete Global Values. This is the only role that can access Control Room settings.</p>	<p>Dashboard</p> <p>Activity</p> <p>Event Triggers</p> <p>Bots</p> <p>Package Manager</p> <p>Devices</p> <p>Workload</p>	<p>View dashboards</p> <ul style="list-style-type: none"> • View and manage my in-progress activity • View and manage everyone's in-progress activity • View my scheduled bots • Schedule my bots to run • Edit my scheduled activity • Delete my scheduled activity • View and manage all scheduled activity from my folders • View and manage all scheduled activity <p>View and manage event triggers</p> <ul style="list-style-type: none"> • View and run my bots • Import and export my bots • Create and rename folders • Manage my credentials and lockers • Create standard attributes for a credential • Bot Auto-Login credential API <p>View and manage packages</p> <ul style="list-style-type: none"> • Register device • View and manage all devices • View and manage my Bot Runners, Bot Creators, and device pools <ul style="list-style-type: none"> • View and manage my queues • Administer all queues • SLA calculator

IQ Bot roles

Role	Permissions	
<p>AAE_IQ Bot Validator</p> <p>For a Bot Runner with an IQ Bot license. Permissions to access the IQ Bot Validator screen. Limited access to Control Room features.</p>	<p>Dashboard</p> <p>Activity</p> <p>Bots</p> <p>Devices</p> <p>Workload</p> <p>Audit Log</p> <p>Administration</p> <p>IQ Bot</p>	<p>View dashboards</p> <p>View my in-progress activity</p> <ul style="list-style-type: none"> • Manage my credentials and lockers • Create standard attributes for a credential <p>View and manage my Bot Runners, Bot Creators, and device pools</p> <p>View and manage my queues</p> <p>View all audit log actions</p> <p>View basic information about users and roles</p> <ul style="list-style-type: none"> • View IQ Bot • View learning instances • Launch validator
<p>AAE_IQ Bot Services</p> <p>Permissions to access the IQ Bot console. Limited access to Control Room features.</p>	<p>Dashboard</p> <p>Activity</p> <p>Bots</p> <p>Devices</p> <p>Workload</p> <p>Audit Log</p> <p>Administration</p> <p>IQ Bot</p>	<p>View dashboards</p> <p>View my in-progress activity</p> <ul style="list-style-type: none"> • Manage my credentials and lockers • Create standard attributes for a credential <p>View and manage my Bot Runners, Bot Creators, and device pools</p> <p>View and manage my queues</p> <p>View all audit log actions</p> <p>View basic information about users and roles</p> <ul style="list-style-type: none"> • View IO Bot

Bot Insight roles

See [Roles to access Bot Insight](#).

Discovery Bot roles

Role	Permissions	
<p>AAE_Discovery Bot Admin</p> <p>Allows access to view all Discovery Bot processes. Manages the creation, deletion, and editing of processes.</p>	<p>Dashboard</p> <p>Activity</p> <p>Bots</p> <p>Devices</p> <p>Workload</p> <p>Administration</p> <p>Discovery Bot</p>	<p>View dashboards</p> <p>View my in-progress activity</p> <p>Manage my credentials and lockers</p> <p>View and manage my Bot Runners, Bot Creators, and device pools</p> <p>View and manage my queues</p> <p>View information about users and roles</p> <ul style="list-style-type: none"> • View all processes • Edit process
<p>AAE_Discovery Bot Analyst</p> <p>Allows access to view and edit all approved recordings from assigned users for a given process. Permissions for system-generated aggregated view of recordings to view, create, edit, and delete views. Permissions to create, view, edit, and delete opportunities for assigned processes. Export the opportunity to a word document and convert to a bot.</p>	<p>Dashboard</p> <p>Activity</p> <p>Bots</p> <p>Devices</p> <p>Workload</p> <p>Administration</p> <p>Discovery Bot</p>	<p>View dashboards</p> <p>View my in-progress activity</p> <p>Manage my credentials and lockers</p> <p>View and manage my Bot Runners, Bot Creators, and device pools</p> <p>View and manage my queues</p> <p>View basic information about users and roles</p> <ul style="list-style-type: none"> • View assigned processes • View all recordings • View all aggregation • View own aggregation • Create or delete own aggregation • Edit aggregation • View system-generated aggregation • View opportunity • Create or delete opportunity

Automation Anywhere Robotic Interface roles

Role	Permissions	
AAE_Robotic Interface Admin	Dashboard	View dashboards
	Activity	View my in-progress activity
	Bots	Manage my credentials and lockers
	Devices	View and manage my Bot Runners, Bot Creators, and device pools
	Workload	View and manage my queues
	Administration	<ul style="list-style-type: none"> View and edit users View basic information about users and roles
	AARI	<ul style="list-style-type: none"> Cross team read Cross process read Global case management Global process management Global team management
AAE_Robotic Interface Manager	Dashboard	View dashboards
	Activity	View my in-progress activity
	Bots	Manage my credentials and lockers
	Devices	View and manage my Bot Runners, Bot Creators, and device pools
	Workload	View and manage my queues
	Administration	<ul style="list-style-type: none"> View and edit users View basic information about users and roles
	AARI	<ul style="list-style-type: none"> Team management Case management Task management

Export roles

You can export assigned users and **Run as user** roles to a CSV file to view folder permissions, and included in offline audits and records.

Ensure that you are logged in to the as the administrator.

You can export selected roles and their permissions to separate CSV files to view the following information:

- Role to user: Provides information about the users assigned to the role.
- Role to run-as user: Provides information about the run-as users assigned to the role.
- Role to permission: Provides information about the permissions assigned to the role.
- Role to folder permission: Provides information about the folder permissions assigned to the role.

You can download the CSV file with the exported roles from the **Activity** > **Historical** page.

1. Navigate to **Administration** > **Roles**.
2. Select the assigned users and **Run as user** roles that you want to export.
3. Click the **Export checked items to CSV** icon at the top-right corner of the table.
A message is displayed indicating that the exported CSV file is available from the **Activity** > **Historical** page.
4. Click **Continue**.
5. Navigate to the **Activity** > **Historical** page and search for exported roles activity.

Note: You can search for role activity by username. The role activity name uses the following format:
Role-Export: Roles_admin_03122022155910111.

6. Click the role activity that you want to download.
7. Click **Download exported zip file**.
The CSV file downloads to your local system as a zip file.

Manage Active Directory role mapping

An administrator or a user with permission to view and manage roles can view the details of the available Active Directory role mappings.

Ensure that you are logged in to the as the administrator.

By default, the Control Room will retrieve all security groups from the Users directory.

To create role mappings with filters for the `Users` directory along with other organizational units (OU), you must update the `um.properties` file. In the Control Room, the `Users` directory is considered similar to the OUs. Therefore, you must define the filter in the `um.properties` file.

For example, set the filter in the file as follows:

```
um.ldap.groupmapping.domain.filter='mydomain.com:OU1&groupFilter|
OU2&groupFilter|Users&groupFilter'
```

Note: Group filters such as `groupFilter` are optional.

In this example, by applying this change to the `um.properties` directs the Control Room to perform the following tasks:

1. Go to domain `mydomain.com`

2. Retrieve all security groups from Organization Unit OU1 that have the group name starts with groupFilter.
3. Retrieve all security groups from Organization Unit OU2 that have the group name starts with groupFilter.
4. Retrieve all security groups from Users directory that have the group name starts with groupFilter.

This setting ensures that the users from the organization units OU1 and OU2 will be retrieved in addition to the `Users` directory.

Recommendation: Use filters to narrow down the group display as displaying larger number of groups impacts the performance and makes troubleshooting difficult.

The filters defined in the `um.properties` file are stored in the database. When you update to a newer version of the Control Room, the Control Room references the filters stored in the database because the default `um.properties` file that comes with the installation will not contain these filters. If you define new filters in the default `um.properties` file, the Control Room references the filters defined in the `um.properties` file and overwrites the ones stored in the database.

Multiple Domain Mapping

Mapping supports multiple domains separated by a coma.

```
um.ldap.groupmapping.domain.filter='mydomain.com:OU1&groupFilter|
OU2&groupFilter|Users&groupFilter,mydomain2.com:OU3|OU4'
```

In the example above, the Control Room will perform the additional processes:

1. Go to domain mydomain2.com
2. Retrieve all security groups from Organization Unit OU3.
3. Retrieve all security groups from Organization Unit OU4.

Retrieving security groups from nested OUs

Example for retrieving security groups from nested OUs.

In the following *example* organization, consider "Marketing" as the parent OU with additional nested OUs and security groups located in each of these nested OUs.

- Marketing
 - Group 1
 - Group 2
 - US_OU
 - Group 3
 - California_OU
 - Group 4
 - NoCal_OU
 - Group 5
 - SoCal_OU
 - Group 6

By adding the following entry, Control Room will retrieve all groups, group1, group2, group3, group4, group5 and group6 from Marketing and the nested OUs.

```
um.ldap.groupmapping.domain.filter='mydomain.com:Marketing'
```

Note: Providing nested OU in the entry is not supported.

Active Directory role mapping

Navigate to **Administration > > Roles > Active Directory Role Mapping** and the page displays any role mappings that have been created in the Control Room. You can view or edit the role mappings. You can also create new role mappings or restart the role synchronization process between the Control Room and AD.

When enabled, this synchronization process is triggered once a day (1440 minutes) by default. You can trigger synchronizations in any interval by changing the number of minutes. We recommend that you set the interval settings larger than the default.

Recommendations:

- **Do not** use both **Import** and **Do not import** mappings in the same system because it may complicate use cases and make troubleshooting more difficult to correct any resulting issues.
- If both **Import** and **Do not import** mappings are defined and a user is part of both mappings, then the **Import** mappings take precedence over the **Do not import** mappings.

Consider these examples:

- AD Mapping A = Role A – Group A – Import users from this group into Automation 360
- AD Mapping B = Role B – Group B – Do not import users from this group

Where user D is part of both Groups A and B within Active Directory (AD).

User D will be created in Automation 360 and will be assigned Role A.

- AD Mapping A = Role A – Group A – Import users from this group into Automation 360
- AD Mapping B = Role B – Group B – Do not import users from this group
- AD Mapping C = Role C – Group C – Import users from this group into Automation 360

Where user D is part of all Groups A, B, and C within Active Directory (AD).

User D will be created in Automation 360 and will be assigned to either Role A or Role C based on which mapping the user was mapped to because only single mapping is supported at this time.

One or more available role mappings that match your search criteria appear in the **Role Mapping** table.

Note: The role mappings page displays only the list of mappings and does not validate the mappings by default. Because the changes in security groups and roles are infrequent and take more time in case of slow network or higher number of mappings, the page displays only the list of mappings. To configure default validation on the role mappings page, in the `um.properties` file, add the following entry: `um.ldap.groupmapping.sync.on.get.mappings=true`. Validation of role mappings occurs when you sync the role mappings between the Active Directory and the Control Room.

You can run automations either on the device which is set as your bot running device or from a device pool for which you have consumer privileges ([Create a user](#)). When using Active Directory role mapping, if you want any mapped Active Directory user to be able to use more than one device, you must configure a device pool ([Create device pools](#)).

Sync Active Directory role mapping

Manually or automatically synchronize (sync) role mappings between the Active Directory and Control Room.

Automatically synchronize Active Directory role mapping

By default, synchronizing between Active Directory and Control Room occurs by default at the time interval of 1440 minutes (one day). The time interval for synchronization can be changed in the Active Directory role mappings main page.

Recommendation: As this can be a time-consuming and an expensive operation, set the role synchronization time period to the default value of 1440 minutes (1 day).

Manually run or restart synchronizing Active Directory role mapping

To run or restart automatic synchronizing between the Active Directory and Control Room, do this: From the Control Room go to the **Active Directory role mappings** page and click the **Sync roles from Active Directory** option.

This starts the synchronizing process immediately and continues to run it automatically based on the time interval set.

Cancel automatic synchronizing Active Directory role mapping

To cancel automatic synchronizing between Active Directory and Control Room, do this: From the Control Room go to the **Active Directory role mappings** page and click the **Cancel Sync** option to turn off the periodic automatic sync.

Events that require Active Directory role mapping sync

Sync the role mappings whenever these events occur:

- Changes to AD groups

If any group that is mapped is deleted from the AD, the mappings must be validated before they are deleted because the group is no longer available.

- Update to the license file

Updating the license file can change the available roles. Mappings must be synchronized before updating the roles.

Note: After a sync, the user must wait a few seconds for the updated changes to appear.

Create Active Directory role mapping

When users are created, they automatically inherit the roles assigned to their Active Directory security groups. Create the mapping before synchronizing the user and roles during the user login or background process.

To complete the task, you must have **AAE_Admin** role assigned to you. Ensure you are logged in to the Control Room as the administrator.

In order to create a role mapping, as the administrator will have to provide the following information:

- Unique mapping name.
- The targeted domain where the security groups will pulling the credentials from (see um.properties for details).

Note:

In order to avoid to import a long list of users, a specific security group should be created on the AD side that has only the users who will access Control Room is recommended.

Map a single AD security group to one or more Control Room roles. Create any roles you want to use with the Active Directory security groups. You can also use the default roles available in the Control Room. .

Note: It is not recommended that the AAE_Admin role not be used.

1. Log in to the Control Room.
2. Navigate to **Administration > Roles**.
3. Click **Active Directory Role Mapping**.
4. Click **Create Role Mapping**.
5. Enter the **Name**.
6. Click the **Active Directory domain** drop-down and select an available domain.
7. Use the **Active Directory security group** field to search for a group.
For example, if you have a group named `Certified Publishers`, search for `Certified`. All the groups that contain `Certified` in their name are listed in **GROUPS**.
8. Choose whether **Import users** or **Do not import users**.

Option	Outcome
Import users	<p>All the users who are assigned for the selected security group will be created and assign the mapped roles and licenses in Control Room. If users already exist in Control Room, they will be updated with the latest roles and licenses from the mapping.</p> <p>If synchronization process is enabled and triggered, the existing Control Room users will have the updated roles and licenses from the mapping.</p> <p>If there are new users added to the security group on the Active Directory side, these users will be created in the Control Room.</p> <p>If there are users removed from the security group, these users will be deleted from Control Room.</p>

Option	Outcome
Do not import users	<p>After the role mapping is created; no user will be created in Control Room. How this mapping is being used in this deployment:</p> <ul style="list-style-type: none"> • On the Create user configuration page, when you create a new user, the role(s) will automatically be assigned to the new user if any of the user security group maps to the existing role mapping. • If synchronization process is enabled and triggered, any existing Control Room users whose security group maps to any role mappings will get the role assignment updated.

9. Click the right arrow (→) to add your selection.
10. Select the required role from the list of **Available roles**.
11. Click the right arrow (→) to add your selection.
12. Select the device licenses to assign to the security group.
License mapping is only supported when the **Import users** options is selected.

Note: The **Do not import users** option does not support license assignment. Administrators will be required to map the licenses manually for users.

You can run automations either on the device which is set as your bot running device or from a device pool for which you have consumer privileges ([Create a user](#)). When using Active Directory role mapping, if you want any mapped Active Directory user to be able to use more than one device, you must configure a device pool ([Create device pools](#)).

13. Click **Create Mappings**.

When the synchronization runs, all users with the assigned roles are updated.

Edit Active Directory role mapping

As an Automation Anywhere Control Room administrator, edit the Active Directory security group mappings assigned to roles in the Control Room.

Ensure that you are logged in to the as the administrator.

Ensure that the mapping name is unique and cannot be duplicated. If you rename a map with an existing mapping name, an error message appears stating that the same name already exists. Changes to mapping name or roles are updated in the audit log.

1. Navigate to **Administration > Roles**.
2. Click **Active Directory Role Mapping**.
3. Hover over the **Actions** icon for the role and select **Edit role mapping**.
4. Supply any required changes for Role Mapping.

Edit the roles by either adding or removing roles from the **Available roles** list, except Bot Insight roles. If you assign Bot Insight roles, an error message appears stating that the role mapping cannot be updated as it contains unsupported roles.

Note: The rest of the fields cannot be edited.

5. Click **Save changes**.

When the LDAP sync runs, all users with the assigned roles are updated.

Delete Active Directory role mapping

An administrator or a user with permission to view and manage role can delete role mappings listed in the Role Mapping table.

Ensure that you are logged in to the as the administrator.

1. Navigate to **Administration > Roles**.
2. Click **Active Directory Role Mapping**.
3. Hover over the **Actions** icon for the role and select **Delete role mapping**.
4. Click **Yes, delete**.

Settings

Use the **Settings** tab to configure the connection to the Credential Vault, enable email notifications, integrate the Control Room with a Git repository, enable secure recording mode, and configure user authentication.

Bots

- Secure recording mode ensures that sensitive data is not stored in the bots. When secure recording mode is enabled, the bots do not capture values of certain properties or store application images. You can enable this setting for some or all users of the Control Room.

Note: Secure recording mode only applies to bots that are created or edited after the mode is enabled.

Click **Edit** in the **Bots** tab to enable or disable secure recording mode. See [Secure recording](#).

- Bot validation performs an additional compile time validation on migrated bots at the preprocessing stage to save your time and effort. By default, the Bot validation feature is set to **Off**.

Note: You must be a Control Room administrator to view and edit the validation option.

Navigate to **Administration > Settings > Bots** and set the bot validation option to **On** to detect compilation errors with bots.

Validation happens at the time of running the bot, for new bots. For migrated bots, this check is performed immediately after bot migration, per configuration.

For example, if a parent bot calls a child bot and the child bot has compilation errors, these errors are displayed when you try to run the parent bot. This ensures that an error does not occur in the middle of an automation or make it an incomplete automation.

In the Bot migration results page, select a bot that needs review. Click the three dots under **Reason** tab to see the details. With the Bot validation feature set to **On**, the bots that have compile time errors are displayed as a separate line entry in the migration report.

Migrated bots with compilation errors are shown in **Successful with Review** section of the migration report and ensures that you can get a list of bots that require your attention.

Devices

When there is a new version of the Bot Agent, it is automatically updated.

IQ Bot

View the website address where IQ Bot is currently installed, if applicable. Click **Edit** to update the IQ Bot URL.

Email

All users have to confirm email accounts by clicking the confirmation link that they receive, set the password, and security questions before user can log in to the Automation Anywhere Control Room. By default, email notifications are disabled. Mouse over the **Edit** icon to make changes.

[Edit email notifications](#)

Git integration

Remote Git repository must support Git LFS (Large File Support). Bots are synced using standard Git push over HTTPS.

Login settings

For security, privacy, or any other pertinent announcement, you can provide an additional statement, such as consent text, in the **Login settings** section. The statement is visible to users every time they log in to the Control Room.

This statement on the login page is disabled by default. If you enable it, you can also provide an option (using a check box) for users to read and accept the statement before logging in to the Control Room.

Security settings

Passwords

Customize the password requirements for all Control Room users. The password must include the following:

- A number
- An alphanumeric letter
- A symbol
- A capital letter

For On-Premises users: The check-boxes are enabled, and the user can select or deselect the options.

For Cloud users: The check-boxes are disabled, and the user cannot select or deselect the options.

API-Key duration

The generated API-Key is used to authenticate users. You can customize how long the generated API-Key is valid to authenticate users until either:

- A selected duration is reached (in minutes or days), or
- A new API-Key is generated

Note: You determine the validity duration based on your organization's requirements. Maximum supported API-Key duration is 1 to 14,398,560 minutes, or 1 to 9,999 days.

Time-out session settings

You can enable settings to automatically time out users from the Control Room browser session after the specified minutes of inactivity. You can configure the inactivity time in the range of 10-60 minutes in the **Time-out session setting** field. You can configure the session using increments of 10 minutes. The default value is 20 minutes, which means you will be logged out of the session after 20 minutes of inactivity.

File upload settings

As an Administrator, you can restrict the upload of executable files (dll files, media type application/x-msdownload) to prevent a security breach. To use this feature, enable the **File upload settings** in **Administration > Settings > Security settings**.

Notification settings

Manage the notification settings for notification categories and channels. The notification settings defined by the Control Room administrator are applicable for all the Control Room users. Based on these defined settings, Control Room users will be notified about the events.

[Manage notifications for Control Room.](#)

User authentication

Configure the *Control Room* to authenticate users through the database option or switch to a SAML Identity Provider (IdP).

[Set up SAML authentication](#)

External key vault

External key vaults provide a way to securely store and retrieve credentials using a third-party key manager such as CyberArk, Azure, and AWS Secrets Manager.

Related tasks

[Set up SAML authentication](#)

Switch an authenticated environment Control Room database to a SAML identity provider (IdP).

[Edit email notifications](#)

Edit details about the email server to use for dispatching email notifications.

Package updates

The delivery of packages is developed to be separate from the main platform updates. This will help us respond quickly to changes and fixes required and provide the flexibility to deliver updates in packages, going forward.

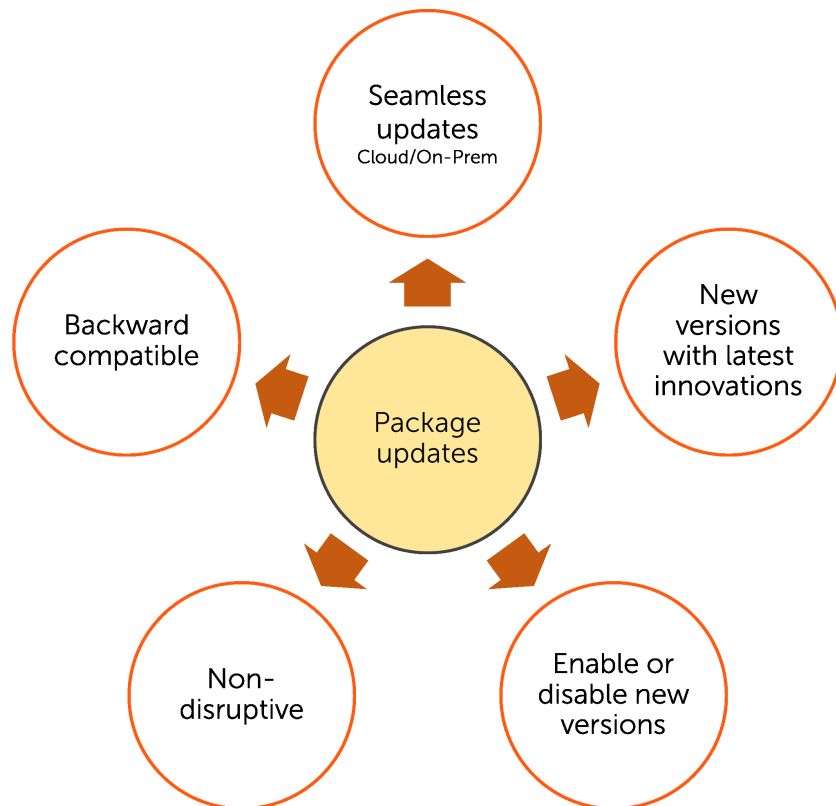

A new package and new package version is downloaded and installed if it is compatible with your Control Room version. Cloud users cannot turn off this automatic installation of a new package and new package version, but the package administrator can control the status of the new package version. Whereas for on-premises users, the automatic package download capability is disabled by default, but package administrators can enable it.

Note: From Automation 360 v.27, the automatic package download capability is enabled by default for On-premises new installation. As a package administrator, you can disable it.

This capability is enabled differently for Cloud and On-Premises Control Room instances, as listed in the following table:

Seamless package update capability	Cloud Control Room	On-Premises Control Room
Download packages from Automation Anywhere Cloud	Enabled by default and cannot be disabled.	Disabled by default and can be enabled. <hr/> Note: From Automation 360 v.27, it is enabled for new installation and can be disabled.
Set downloaded package to default version	Enabled by default and can be disabled.	Enabled by default and can be disabled.

Note: After the Automation 360 v.27 upgrade, when a new package (first version) is added to the Control Room and if in the setting for packages you selected **Disable** for the new version of package, you will see that such package will have status as **Enabled and set as default** instead of **Disable**.

- **Cloud users:** [Automatic package updates for Cloud Control Room](#)
- **On-Premises users:** [Automatic package updates for On-Premises Control Room](#)

We recommend bot developers always use the latest version of the packages because that version provides the latest innovations and all the code and security fixes from previous versions. Note that this capability does not impact existing bots, which continue to run unchanged. Bots developed with a particular package version will continue to do so unless explicitly changed by the bot developer. However, if you want to modify existing bots to use the default version of a package, you can use the feature **Update bots to default package version**.

[Update bots to default package version](#)

Automatic package updates for On-Premises Control Room

Configure the On-Premises Control Room settings to get package updates from the Cloud automatically or only when the Control Room is upgraded manually.

Seamless package update capability is part of our effort to make innovations and enhancements readily available to you. This capability in the Automation 360 platform provides you predictable, qualitative, and non-disruptive access to the latest innovations and enhancements.

When this seamless update capability is enabled, the Control Room can download new packages and new versions of existing packages from Automation Anywhere Cloud when they are released on a regular and predictable release cadence. Newly downloaded package versions are automatically set as default packages so that customers can start using these package versions on an ongoing basis as the packages become available.

Note: To automatically download newly released package versions, the Control Room uses the following URL and port number:

- URL: `https://aai-artifacts.my.automationanywhere.digital/packages/<package-jar-file-name>`
- Port number: TCP 443 (HTTPS)

Note that this capability has no impact on existing bots. Existing bots continue to run unchanged. These new package versions are also backward-compatible with the existing platform version.

Configure packages for On-Premises

Ensure that you are logged in to the On-Premises Control Room as administrator.

1. Navigate to **Administration > Settings > Packages**.
2. Edit the **Packages** option.
The page opens in edit mode.
3. Select **On** to automatically download and install new packages from Automation Anywhere Cloud to the Control Room.

By default, **Automatically update packages from the cloud** is set to **Off**.

Note: From Automation 360 v.27, this capability is **On** for the new installation of the On-Premises Control Room.

When you enable this setting, the system checks for new packages every 12 hours and automatically installs them if new packages are available.

Note: The new package version is downloaded and installed only if it is compatible with your Control Room version.

4. Enable the settings to set the status of the new package.
This is applicable for new packages downloaded from the Cloud and the Control Room upgrade. By default, this setting is enabled and set as default.
 - **Enable and set as default:** Select this option to automatically set the new version of a package as the default version.
 - **Enable:** Select this option to manually set the default version after the package update.
 - **Disable:** Choose this option to automatically disable the new version of a package.
5. Save the settings.

Automatic package updates for Cloud Control Room

Configure the Cloud Control Room settings to get package updates from the Cloud automatically.

Ensure that you are logged in to the as the administrator.

When a new package or a new package version is released in the Cloud, the package version will automatically get installed on Control Room. This automatic installation of a new package version cannot be turned off by cloud users and can only control the status of the new package version after it is installed.

1. Navigate to **Administration > Settings > Packages**.
2. Edit the **Packages** option. The page opens in edit mode.
3. Enable the settings to set the status of the new package.
 - **Enable and set as default:** Select this option to automatically set the new version of a package as the default version.
 - **Enable:** Uploads and enables the package, but the package is not set as the default package. Bot Creators have to specifically select non-default packages to use them for creating bots.
 - **Disable:** Choose this option to automatically disable the new version of a package.
4. Save the settings.

Related concepts

[Preload packages](#)

You can preload packages on your local device to shorten the bot runtime.

Configure default device settings

Configure the device settings to automatically set a user's current device as the default device after the user logs in to the Control Room.

Edit general settings

Ensure that you are logged in to the as the administrator.

Configure the default device setting for temporary or non-persistent devices so that users of such devices users do not have to log in to the Control Room to mark their device as a temporary device.

1. Navigate to **Administration > Settings > Devices**.
2. Edit the **General** settings.
3. To automatically set a logged-in user's device as the default device, verify that the **Enabled** option is selected.
The option is selected by default. You can change it to **Disabled** if you do not want to set a logged-in user's device as the default device.
4. Save the settings.

Change the global cache location

If you do not want to use the default location of global cache, change it according to your requirements:

1. Navigate to **Administration > Settings > Devices**.
2. Edit the **Advanced options** settings.
3. Enter the new location for global cache. This option is available in the Control Room for all devices but can be used only by devices that have the **All Users/System Level (Recommended)** option, selected when installing the Bot Agent.

Note: If the specified path is not valid on the device, then the default path is used.

4. Save the settings.

Configure log collection

The log collection configuration enables you to collect log entries from the devices connected to the Control Room.

You can view the system log information on your device at the following locations:

- Bot Agent installed as admin user: `C:\ProgramData\AutomationAnywhere\BotRunner\Logs`
- Bot Agent installed as local user or non-admin user: `%userprofile%\AppData\Local\AutomationAnywhere\BotRunner\Logs`

The following logs are collected:

- Node manager logs
- Bot launcher logs
- Browser extension logs

You can choose to collect one of the following log-level information:

Note: In the production (**PROD**) environment, we recommend that you set the log file configuration level to **INFO** for optimal performance.

- **Info (default):** Informational messages that highlight the progress of the application
- **Debug:** Fine-grained information that is useful for debugging an application
- **Trace:** Captures every behavior of the application in detail

To configure individual device log collection configuration, see [Customize device settings](#).

1. Navigate to **Administration > Settings > Devices**.
2. Edit the **Log collection configuration** settings.
3. To configure the level of log collection, select **Info, Debug, or Trace**.
4. Set the maximum log file size between 1 MB and 100 MB.
5. Set the maximum number of log files between 1 and 500.
6. Save the settings.

Customize browser extension settings

You can customize the browser extension settings for user devices at the device level. Customizing the setting helps you to continue to use browser-based automations seamlessly even when there is an update to the browser extension.

- You must be a Control Room administrator to configure this setting.
- You must have installed Bot Agent version 21.222 or later.
- You must have installed the Bot Agent with installation type as system-wide.

By default, the Google Chrome and Microsoft Edge browser extensions are enabled on all Bot Agent devices. When this option is enabled, the browser extensions are automatically updated on all the connected devices through a single click.

1. In the Control Room, navigate to **Administration > Settings > Devices**.

2. In the **Browser extensions** settings, select **Edit** and then select one of the following options:
 - **Enabled:** Select this option to enable the Google Chrome or Microsoft Edge extensions on all the connected devices.
 - **Disabled:** Select this option to disable the automatic update of browser extensions. This option is applicable only when a Bot Agent is upgraded or a new Bot Agent is installed.
 - **Force disable Chrome and Edge extensions from all bot running devices:** Select this option when you want to manually upgrade the browser extension.

This option disables browser extensions on all the Bot Agent devices.

Note: Selecting this option might disrupt the functioning of your browser-based automation.

Consider the following when configuring the browser extensions option:

- If the **Browser extensions** option is selected and you disable this option when the **Force disable extension on all bot running devices** option is unselected, then the `ExtensionInstallForceList` group policy is not applied on the devices that are newly registered or upgraded. You will have to enable the extension manually on the newly registered or upgraded devices.
- If the **Browser extensions** option is selected and you deselect it, with the **Force disable extension on all bot running devices** option selected, the `ExtensionInstallForceList` group policy is deleted from all the Bot Agent devices and you must manually update the browser extension.
- If the **Browser extensions** option is unselected and you select it, the group policy changes are pushed to all the Bot Agent devices.

Note: Automation Anywhere does not interfere with the `ExtensionInstallForceList` group policy if it is already present on the system, However, if a key by name **1** is already present in the `ExtensionInstallForceList` folder, create a key name with the subsequent number, in this case, **2**. See [ExtensionInstallForcelist](#) for Google Chrome or [ExtensionInstallForcelist](#) for Microsoft Edge.

Switch device registration between Control Room instances

Configure the device settings in the Control Room to enable single-user devices to easily switch between different instances of the Control Room to run bots in multiple environments. This option enables you to register the Bot Agent on multiple Control Room instances without uninstalling the Bot Agent.

Ensure that you are logged in to the as the administrator.

- You must have the View and Manage ALL device permission to enable the switching option.
- You must enable the switching option on both Control Room instances.
- You can switch between Control Room instances only if the instances are on the same build.

For example, if one Control Room instance is on Build 9664 and another instance is on Build 8815, you cannot switch user device between the two Control Room instances. Both instances should be either on Build 9664 or Build 8815.

1. Navigate to **Administration > Settings > Devices**.
2. **Edit** the **General** settings.
3. Select **Enabled** to enable the local device as the default bot running device after a user logs into the Control Room.

4. Select **Enabled** to enable a single-user device to be switched to another Control Room without reinstalling the Bot Agent.

Additionally, the **Allow fast switching** option allows you to switch the Bot Agent with a single click.

Note: Fast switching is recommended only if there is no change in the network configuration when connecting to a new Control Room. The first time you switch the Bot Agent to a new Control Room, the device lifespan information (that is, whether the device is **Persistent** or **Temporary**) is copied over to the new Control Room. No other configuration information is copied over.

If this setting is not enabled, you must uninstall Bot Agent first and then reinstall it to switch device registration to different Control Room instances.

5. Optional: For additional security, you can enable the following setting in the **Validate device credentials** field to validate the device credentials prior to bot deployment:

- **Device credentials for all users:** Validates the device credentials for Bot Creator, attended Bot Runner, Citizen Developer, and unattended Bot Runner users.
- **Device credentials for un-attended bot runner users only:** Validates the device credentials for unattended Bot Runner users only.

6. Save the settings.

7. Log in as a Bot Creator user to a Control Room configured in a different environment to verify that users can switch between instances.

The **Connect device** option is available when you click the device icon in the Control Room panel.

Related tasks

[Switch Bot Agent to a different Control Room](#)

Switch the Bot Agent on a registered device to work with a different Control Room manually when you work on automations using different environments.

Change screen resolution for Bot Runner session

For user devices, you can set the screen resolution of the Bot Runners for every bot deployment through the RDP in the Control Room.

This task is performed by the user who wants to build and deploy . You must have the necessary rights and permissions to complete this task, and authorization to log in to the as the licensed user.

The RDP session is created using the set screen resolution during bot deployment.

1. Navigate to **Administration > Settings > Devices**.
2. Edit the **Resolution settings for a device session** field.
3. Set the resolution by either selecting a predefined value from the **Screen resolution** drop-down list or by selecting **Custom** and entering the values you want.

Note that the screen resolution settings are applicable only when you use RDP-based deployments. For regular deployments, a Windows session is created using the existing resolution settings of the device. In this case, the screen resolution set in the Control Room is ignored.

Recommendation: When resolution dependent packages are used to build bots, any screen resolution difference between the Bot Creator and Bot Runner device will impact the bots during runtime. Therefore, ensure the resolution settings on devices match when you create and run bots. See [Screen resolution dependent packages](#).

4. Select the **Do not allow devices to override resolution settings** option.
When you select this option, the resolution settings cannot be changed at the device level.
5. Click **Save**.

Screen resolution dependent packages

The screen resolution between the Bot Runner and Bot Creator device should be consistent as when resolution-dependent packages are used to build bots, any screen resolution difference between the Bot Creator and Bot Runner device will impact the bots during runtime.

Ensure the resolution settings on Bot Creator and Bot Runner devices match when you create and run bots. Review the table given below for information on the resolution-dependent packages and their attributes.

Package	Effects of display parameter changes	Resolution-dependent attributes
Image Recognition	<p>If we use the Image Recognition package in a computer that has a different resolution, scaling, or zooming than the resolution that was configured in the system, it can affect the output as it works on image pixel values and the features.</p> <p>For RDP machines, when you configure Image Recognition package in a different machine and run it on an RDP machine with same resolution and scaling, and if RDP is using a different display driver, the capture might not be accurate. It can render image with slightly different pixel values that can cause a reduction of matching percent.</p>	X, Y, width, and height
Mouse	<p>The Mouse > Click action requires X and Y co-ordinates to capture the UI element. If there is a change in screen resolution, scaling, or zooming, the coordinates might move, and it might click different coordinates. Due to this, the Click action will fail to capture the specific UI element. If you are using the RDP machine with the same resolution, scaling, or zooming then it will not create any issue as the Mouse package does not depend on the pixel value.</p>	X, Y
App Integration	<p>The App Integration > Capture area action requires X and Y co-ordinates to capture the text from a window. Any change in screen resolution, scaling, or zooming might cause change in the coordinates, and the correct text is not captured. In the RDP machine, use same resolution, scaling, and zooming so that you do not encounter any issues.</p>	X, Y, width, and height
Screen	<p>The Screen > Capture area action requires X and Y co-ordinates to capture the screenshot of the application window area. Use the same resolution and scaling in the RDP machine so that the output is not affected.</p>	X, Y, width, and height
OCR	<p>The OCR > Capture area action uses the X and Y co-ordinates to extract text from a specified area in the selected window. Ensure you have the same resolution, scaling, and zooming in the RDP machine so that extraction of the text is not affected.</p>	X, Y, width, and height

Configure auto-delete temporary device settings

Configure your device settings to automatically delete a temporary device when the device is disconnected from the Control Room after a certain time interval.

Ensure that you are logged in to the as the administrator.

1. Navigate to **Administration > Settings > Devices**.
2. Edit the **Temporary devices - auto delete settings**.
3. Use plus (+) or minus (-) to select the number of **Days, Hours, or Minutes** to wait before the temporary device should be deleted automatically.
The default time is 24 hours.
You can also manually delete the temporary device from the **My devices** page in the Control Room.
4. Save the settings.

Configure threshold settings for user devices

Configure the CPU utilization and device memory threshold values to control the concurrent bot deployment on user devices based on resource utilization.

Ensure that you are logged in to the as the administrator.

Based on the CPU utilization and device memory threshold values, you can determine whether to deploy bots on user devices. If the threshold value is the same or more than the value provided, bots are not deployed on user devices.

The default values for CPU utilization and device memory are based on the following parameters:

- When the frequency of data collection is 10 seconds, the system collects 6 data points in 1 minute.
- When time interval to upload data is 120 seconds, the system uploads 6 data points to the Control Room every 2 minutes.
- When the moving average time window is 2 minutes, the system uses the last 12 data points to calculate the average resource utilization.

1. Navigate to **Administration > Settings > Devices**.
2. Edit **Threshold settings for multi-user devices**.
3. Optimize the behavior for concurrent sessions by choosing one of the following options:
 - Do not enable threshold settings
Use this option to deploy bots on single-user devices.
 - Enable threshold settings to set the maximum values:
 - a. Enter the CPU and memory utilization frequency of data collection.
 - b. Enter the time interval to upload data.
 - c. Enter the moving average time window.
 - d. Enter the CPU threshold limit for new bot deployments on a device.
 - e. Enter the memory threshold limit for new bot deployments on a device.

Use this option to deploy on multi-user devices.

You can either enter the values or click the plus (+) or minus (-) signs to increase or decrease the limit.

4. Save the settings.

Configure auto-login settings

Configure auto-login settings in the Control Room to either create user sessions or reuse existing user sessions to reduce the bot startup time.

Ensure that you are logged in to the as the administrator.

Auto-login enables you to deploy a bot for unattended Bot Runners after automatically logging on to a machine and restoring the machine to its original locked/unlocked state after completing the deployment.

Configure auto-login settings to either create new user sessions or reuse existing sessions in the following scenarios:

- Before deploying a bot, some applications are kept running to accommodate a delay in the application launch.
- When Windows updates or Active Directory policy updates are pushed after a user logs in, changes in the automation environment might affect bot execution.
- Logging off from temporary or non-persistent devices stops bot execution.
- You can reuse existing user sessions when your company's IT policy prevents you from providing device user password for auto-login credentials.
- To bypass legal disclaimers on RDP-based deployments.

1. Navigate to **Administration > Settings > Devices**.
2. Edit the **Auto login settings**.
3. Optional: *External key vault setting*.

4. Choose how to run bots on user sessions by selecting one of the following options:

- **Always create a new session**

Select this option for desktop deployments where it is possible to create user sessions on devices.

- **Reuse an existing session**

Recommendation: Select this option for auto-login settings in the Control Room to use event triggers on unattended Bot Runners and to run bots when a device is locked or is in a disconnected state (such as RDP).

Available options to lock or unlock the session are:

- An existing locked session
- An existing unlocked session
- A disconnected session
- Allow users to change these settings for each device

Use this option for deployments on devices where it is not possible to create user sessions.

Note: When you use the **Reuse an existing session** option, ensure user sessions are available. If there is no existing user session, triggers and bot deployments will fail.

- **Reuse an existing session, if available**

Use this option if you must create a new session or reuse an existing session. If a session does not exist, create a new session and leave it unlocked for next user session after bots complete their run from the following:

- A new session
- An existing locked session
- An existing unlocked session
- A disconnected session

5. To allow a user to change the auto-login settings at the device level, go to **Administration > My Devices** and select **Allow changes**.

The **Do not allow changes** option disables the user-level auto-login settings for user sessions.

6. Save the settings.

Related reference

[Devices](#)

The device is a machine through which a user connects to the Control Room to create or run bots. Manage devices that are registered to the Control Room through the **Devices** page located in the **Manage** tab.

Add access IP addresses

Use this setting to limit user login access to the Control Room URL based on IP addresses or subnets that you specify in a list. You add IP address ranges using the Classless Inter-Domain Routing (CIDR) format, and you can add multiple CIDR ranges.

Note:

If a user attempts to log in to the Cloud Control Room using an IP address that is not included in the access list, an error message displays indicating invalid user or user credentials.

Ensure that you are logged in to the as the administrator.

You must have access to **Administration > Settings** page with view, add, or edit permissions.

Specify a list of IP addresses or IP subnets to permit access to the Cloud Control Room URL and API. If your network egress uses dynamic IP addresses, then the ranges you enter must include the entire range of dynamic IP addresses that can be assigned outbound traffic. For example, to specify a single IP address use, 10.10.10.12/32; or to specify an IP address range, use 192.168.20.0/24.

Note: When using SAML for authentication, use the network access capabilities of the Identify provider to restrict access to specific allowed IP addresses. Ensure all allowed IP addresses configured are removed before switching to SAML for authentication. For more information, please consult [Unable to Set up SAML authentication for Control Room \(A-People login required\)](#).

Perform the following steps to add an IP address or subnet to the list of permitted network access addresses:

1. Log in to the as the administrator.
2. Navigate to **Administration > Settings > Network settings**.
3. Click **Edit** to add to or edit the listed IP addresses.

Note: There is a limit of 25 independent entries in the access permitted table. An entry can be a single IP address or an IP subnet.

4. Enter the IP address information:

Option	Description
Single IP address	Enter the necessary IP address in x.x.x.x format.
Range of IP addresses	Enter the address in x.x.x.x format and specify the subnet mask.

5. Enter the **Name**.
6. Optional: Enter a description.
7. Click **Save changes**.

Related reference

[Add IQ Bot cloud server IP addresses to allowed list](#)

To ensure seamless connectivity of your IQ Bot cloud servers with the Cloud Control Room, specify a list or range of IP addresses that are allowed to access the Cloud Control Room URL.

[Add Automation 360 Cloud DNS to trusted list](#)

To ensure secure access to Automation 360 cloud services, add specific Automation Anywhere Domain Name System (DNS) to the safe recipients or trusted list.

Set callback URLs

You can specify valid callback URLs, enabling the Control Room to post the results of the task execution only to defined and secure URLs for more granular security over the network.

Ensure that you are logged in to the as the administrator.

As a Control Room administrator, you can configure and audit specific, permitted URLs for more granular control of the network access points. Only the Callback URLs can be used in bot deployment APIs.

1. Navigate to **Administration > Settings > Network settings > Deployment settings > Callback URL**.
2. Click the **Edit** icon. (✎)
3. Add the required URLs.
Use the **Add** option for more URL fields.

4. Click **Save**.

Set up SAML authentication

Switch an authenticated environment Control Room database to a SAML identity provider (IdP).

Note: SAML integration is irreversible. After it has been established, you cannot modify the configuration.

Ensure that you are logged in to the as the administrator.

Before you set up authentication for the Control Room, setup tasks (such as introducing credentials on a new system and importing users) might be required. If you import users, then you must also include matching user IDs, email addresses, first and last names, in both the Automation Anywhere credentials and matching records to log in after the SAML integration. For example, if using Okta as a SSO, then users must have matching IDs, email addresses, first name and last names in both Automation Anywhere and Okta to log in after the SAML integration.

You should have the required user information and certificate ready. Typical user information consists of user ID, first and last name, and an email address.

Note: You must validate the SAML IdP setup before you configure the Control Room. See [Configure the Control Room as a service provider](#).

After switching to SAML authentication environments, any users with non-SAML IdP formatted IDs will not be able to log in. You need to verify that any bots located in their private folders are exported so they can be imported back against their new user accounts.

Much of this configuration relies on third-party applications to create the necessary metadata. If you require more specific configuration information based on a specific provider, see [Configure SSO authentication with Okta](#).

To switch the Control Room to a SAML-authenticated environment, follow these steps.

1. Navigate to **Administration > Settings > User authentication**.
2. Select the **Use SAML** option.

Note: The **Use Control Room database** option is selected by default.

3. In the **Unique Entity ID for Control Room (Service Provider)** field, enter the entity ID.
4. In the **Encrypt SAML Assertions** field, select one of the following options:

Option	Description
Do not encrypt	SAML assertions are not encrypted.
Encrypt	SAML assertions are encrypted.

5. Optional: Enter the **Public key** and **Private key** values.

Note: Enter keys only if you require encrypted SAML assertions.

6. Click **Validate SAML Settings**.

The Control Room will log in through the SAML provider and redirect back to the **Control Room User Authentication** page.

When you click this option, you will be redirected to a SAML 2.0 service provider web page where you will be prompted to enter credentials and other data.

7. Log in to your provider when prompted.
8. Click **Save changes**.

Related tasks

[Configure the Control Room as a service provider](#)

A valid SAML IDP setup must be configured before the Control Room can be switched to a SAML-authentication environment.

Two-factor authentication

Two-factor authentication (2FA) provides an additional layer of defense against unauthorized users from accessing the Control Room. As an administrator, you can set up 2FA so that the users can validate their identity when logging in to the Control Room using both their user credentials and a second authentication factor.

How 2FA works

2FA is an additional authentication mechanism added to your login process. 2FA is disabled by default. The Control Room administrator configures the 2FA for either all users or users with specific roles. Once 2FA is enabled, it is applicable to all Control Room users that it is intended for.

When you are assigned a role that requires 2FA, you must set up an authenticator application on your mobile or other device and establish a connection between the authenticator application and the Control Room. On subsequent logins, you will be prompted to enter, along with the username and password, a time-based one-time password (TOTP) from the authenticator application to complete the Control Room login.

Note: 2FA is not supported for Control Room setup using Active Directory (AD) or SSO. 2FA is supported only when the Control Room is the authentication provider.

Components

Three main components are used in 2FA.

- **Authenticator application:** Installed on your mobile device, this application generates TOTP for verifying your identity. Any authenticator application that supports the TOTP protocol, such as DUO or Google Authenticator is supported.
- **Registered device:** This is the mobile or other device that you register with the Control Room during first login after 2FA is set up. The TOTP is generated through this registered device, which is required any time you log in to the Control Room. If your registered device is lost or unavailable, you must request the Control Room administrator to delete the device, and you can add another device later. Therefore, we recommend you to set up more than one device and register them with the Control Room.
- **Time-based one-time password:** This is a temporary password generated by an algorithm that uses the current time of the day as an authentication factor.

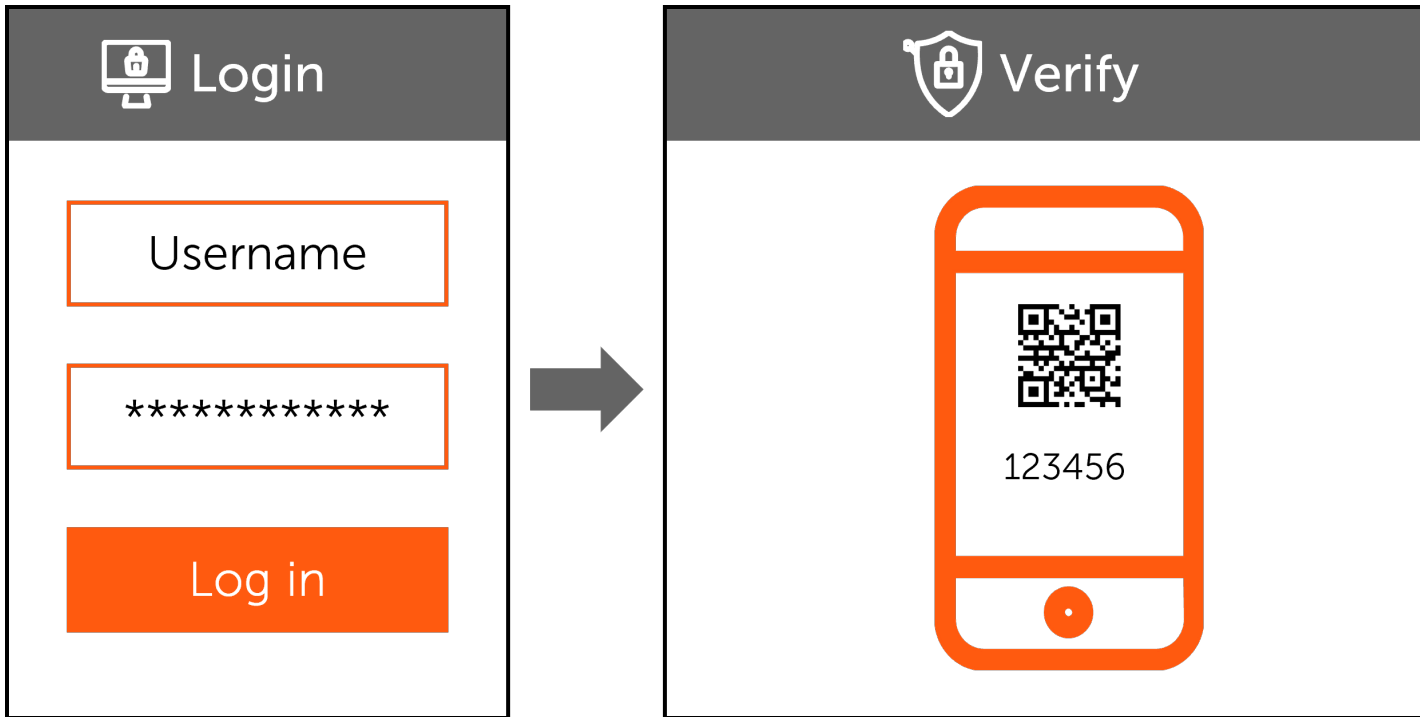

Set up 2FA

1. Enable 2FA in the Control Room.
 - a. Log in to the Control Room as an administrator.
 - b. Navigate to **Administration > Settings > Security settings > Two factor authentication.**
 - c. Click **Edit** to configure the settings.
 - d. Select **Enable**. This is not enabled by default.
 - e. Choose the settings based on your requirements:

Option	Action
All users	Select this option to enable 2FA for all users who have access to the Control Room.
Selected roles	To enable 2FA for users with specific roles: <ol style="list-style-type: none"> 1. From the Available roles column, search and select roles for which you want to enable 2FA. 2. Move these roles to the selected column.

- f. Save your changes.

2. **Optional:** If a user's registered (mobile) device is unavailable or changed, delete the device and register a new one.
 - a. Log in to the Control Room as an administrator.
 - b. Navigate to **Administration > Users**.
 - c. Select the user that you want to edit. Hover over the action menu (vertical ellipsis) located to the right of the username and click **View user**.
 - d. In the **Authenticators** section, select the device that you want to delete, click the delete icon, and confirm deletion.

3. Set up an authenticator application and establish a connection between the authenticator application and the Control Room.
 - a. Log in to the Control Room as a Citizen Developer or a Bot Creator (RPA Developer).

Ensure that you have an authenticator application set up on your mobile device. During your first login, a QR code is displayed.
 - b. Either scan the QR code using your authenticator application or manually enter the code displayed in the authenticator application.
 - c. Enter the name of your authenticator and the new code generated in your authenticator application.

This is a temporary code that is refreshed every few of minutes based on your authenticator application.
 - d. Click **Confirm**.

Follow the next steps in the login flow, change your password and set the security questions. You will be successfully logged in to the Control Room. On subsequent logins, you must enter the code generated in your authenticator application and confirm.

4. **Optional:** You can manage (add or delete) your authenticator device.
 - a. Log in to the Control Room as a Citizen Developer or a Bot Creator (RPA Developer).
 - b. On the **Home** page, click your username.
 - c. Navigate to **My settings > Two factor authentication**.
 - d. Click the plus (+) icon.
 - e. Perform steps [3.b](#) through [3.d](#).
 - f. **Optional:** Select the device that you want to delete, click the delete icon, and confirm deletion.

Configure Credential Vault Connection mode

Credential Vault is a centralized location for securely storing credential information used by bots.

Configure the **Connection mode** to connect to the Credential Vault using a **Master key**.

Note: Provide this key every time you start or restart the Control Room.

To configure settings for Credential Vault, select **Express** or **Manual** mode.

Express mode

Auto connect to the Credential Vault with the master key that is stored in the system during Control Room configuration.

Manual mode

Use this to manually connect to the Credential Vault using the master key that was available during Control Room configuration.

When switching modes, provide the **Master Key** in the field and click **Save** for the changes to take effect.

Tip: Restart the server machine (on which the Control Room is installed) or services to allow changes to take effect.

All updates to the Credential Vault **Connection mode** are captured in the **Audit Log**.

- If you are facing Credential Vault connection issues while accessing the Control Room URL, see [CR fails to load with the Error Code 'cv.validation.secure.cv.locked' \(A-People login required\)](#).
- If the Credential Vault is configured to connect to the Control Room in **Manual** mode, and the **Master Key** is not added within a certain time period (for example, within 2 minutes), the devices might disconnect from the Control Room.

For more information, see [Bot agent device status remains disconnected post restart of Control Room server after windows maintenance \(A-People login required\)](#).

Related tasks

[Set up locker and assign credentials](#)

Create a role, credentials, and locker to share related sensitive values with a group of users, so they can use those values to build or run bots.

Editing SQL user information

Edit MS-SQL configuration related settings, including username, password, database server name, database server IP and port numbers.

To perform this task, you must be a administrator and have the required rights and permissions.

Download the latest Control Room utility and make certain this utility installed on every sever where Automation 360 is running.

Note:

Users are required to make changes to the running configuration via the command line interface.

Note: Please stop all Automation 360 services on all nodes where a Control Room is installed before performing this task.

1. Open the command line prompt and navigate to the Automation 360 application.
For example, C:\Program Files\Automation Anywhere\jdk11\bin.
2. Follow the prompts from the utility to select the SQL database and enter the required credentials.

Note: The password will not be displayed on the console

3. Restart the Automation 360 services on the nodes.
The SQL user information has been successfully updated.

Syslog server integration

The Automation Anywhere Control Room supports ingesting tenants' audit log entries in Syslog format to any Syslog server.

Important: The options to specify or modify the Syslog configurations are available only for the On-Premises deployment.

By pushing syslog data to a Syslog server, you can integrate and leverage the advanced searching and reporting features of Syslog server solutions. When configured, the Control Room audit logs are forwarded to both the Transmission Control Protocol (TCP) and User Datagram Protocol (UDP) network protocols. You can use any syslog server. The following syslog servers are tested and certified by Automation Anywhere:

- Kiwi Syslog Server
- Splunk

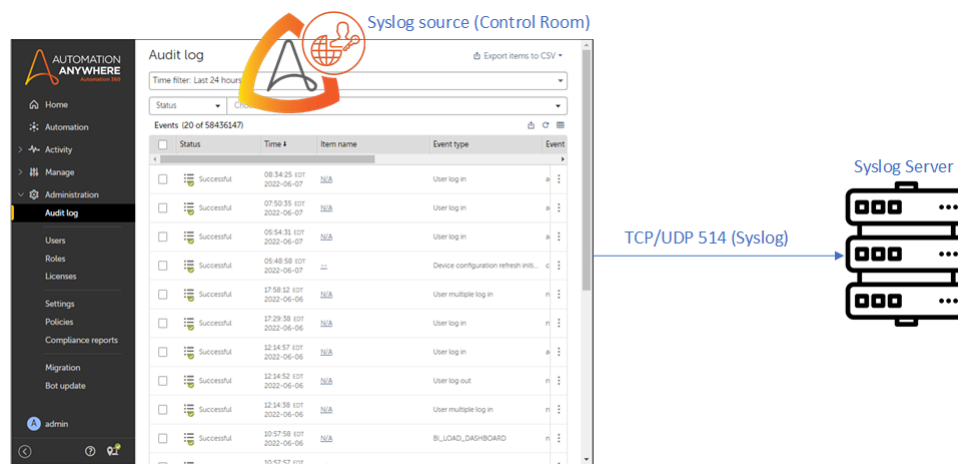

You can configure a Kiwi Syslog Server or a Splunk server that accepts data from a Control Room instance's syslog through a TCP or UDP port. The following example illustrates sending the Syslog data to Kiwi Syslog server through TCP or UDP ports.

Configure Kiwi Syslog Server

Solarwinds Kiwi Syslog Server is a widely used commercial Syslog server. Kiwi Syslog Server Free Edition can monitor Syslog for up to five devices. Download Kiwi Syslog Server Free Edition from the following link: [Kiwi Syslog Server Free Edition](#). After installation, perform the following steps to configure the Kiwi Syslog Server:

1. Navigate to **File > Setup > Inputs**.

2. To forward the logs through UDP, click **UDP**.

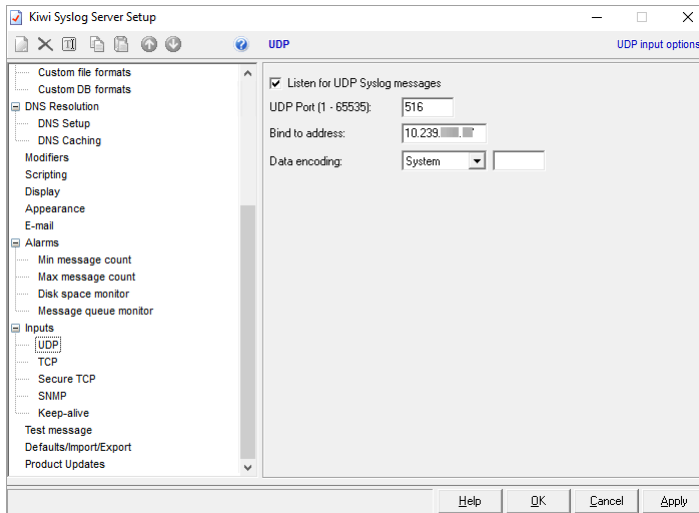

3. Enter the UDP port and the IP to which you want to forward the logs.

4. To forward the logs through TCP, click **TCP**.

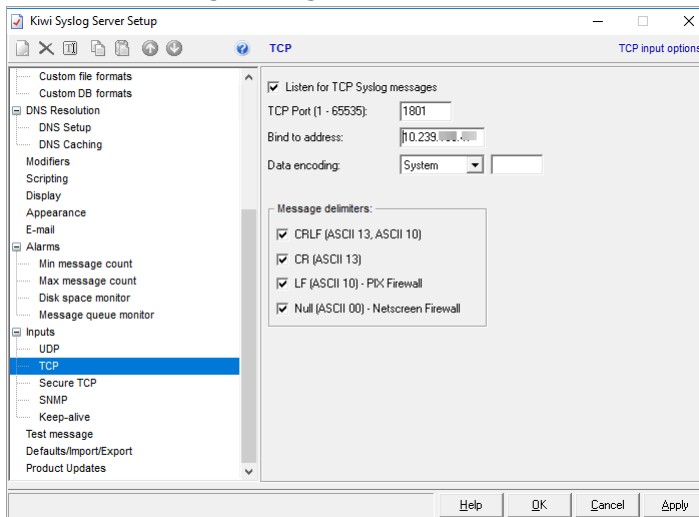

5. Enter the TCP port and the IP to which you want to forward the logs.

Configure Control Room to send Syslog on UDP or TCP

To configure the Control Room to send Syslog on UDP or TCP, perform the following steps:

Note:

To perform this task, you must be a administrator and have the required rights and permissions.

1. Navigate to Administration > Settings > Network settings.

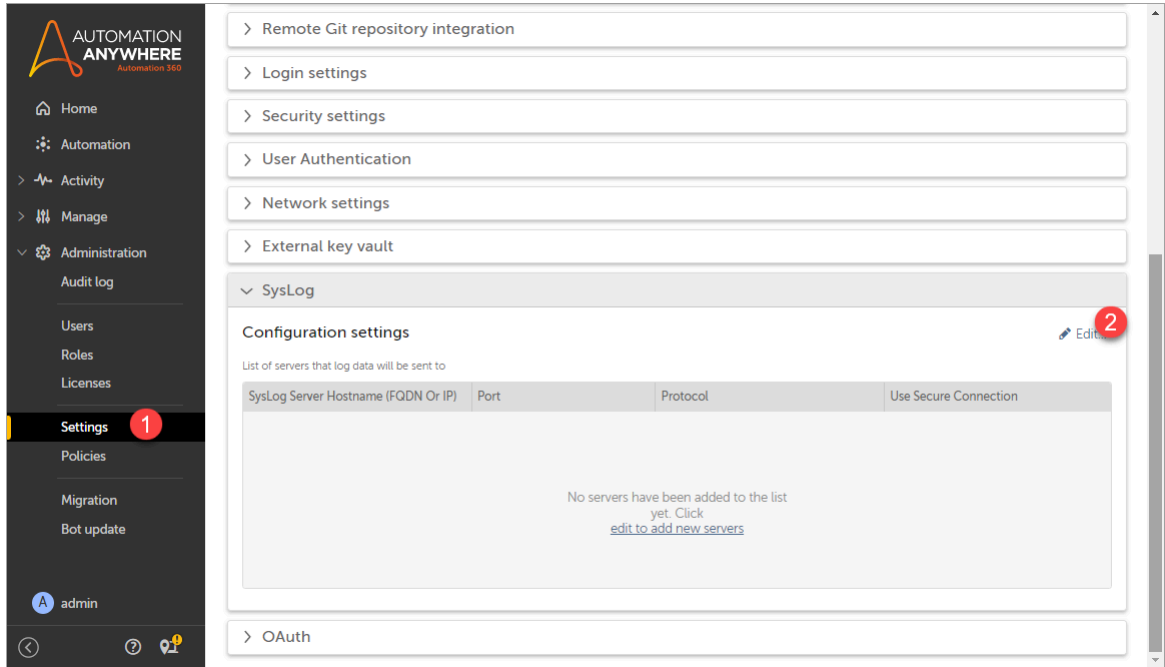

2. To add more Syslog servers, click the plus (+) sign.

3. Enter the Syslog server information.

Option	Action
Syslog server hostname	Fully qualified domain name (FQDN) or the IP address of the Syslog server to deliver the log reports.
Port	Port that the remote Syslog server uses to receive incoming Syslog records (for example, port 514).
Protocol	TCP or UDP.

Option	Action
Use Secure Connection	Use a TLS encrypted channel to send Syslog records to the remote server. This option is available for TCP only.

- a. To forward the logs to a UDP port, enter the UDP settings (IP, port, and select UDP from **Protocol** drop-down).

Note: For information about specific settings, see the Kiwi Syslog Server documentation.

The screenshot displays the Automation Anywhere management interface. On the left is a dark sidebar with the 'Automation Anywhere' logo and a navigation menu including Home, Automation, Activity, Manage, Administration, Audit log, Users, Roles, Licenses, Settings (highlighted), Policies, Migration, and Bot update. The main content area shows a list of settings: Email, Remote Git repository integration, Login settings, Security settings, User Authentication, Network settings, and External key vault. The 'SysLog' setting is expanded, showing 'Configuration settings' for a list of servers. There are three rows for SysLog server configuration. The first row is selected and has a red circle '4' next to the 'SysLog Server Hostname (FQDN Or IP)' field, which contains '10.239.'. The 'Port' is '516' and the 'Protocol' is 'UDP'. The second row has a red circle '3' next to the 'Protocol' dropdown menu, which is set to 'TCP'. The 'Port' is '1801' and the 'SysLog Server Hostname' is '10.239.'. The third row is empty, with a red circle '3' next to the 'Protocol' dropdown menu. Below the SysLog settings is the 'OAuth' setting.

- b. To forward the logs to an TCP port, enter the TCP settings (IP, port, and select TCP from **Protocol** drop-down) .

4. Click **Save changes**.

Verifying data in the Syslog Server

Reception of logs is verified in the Syslog Server. Perform the following steps to verify the data in Syslog Server:

1. Generate a Syslog event by logging in or logging out of the Control Room.

2. Verify the logs in the Kiwi Syslog Server.

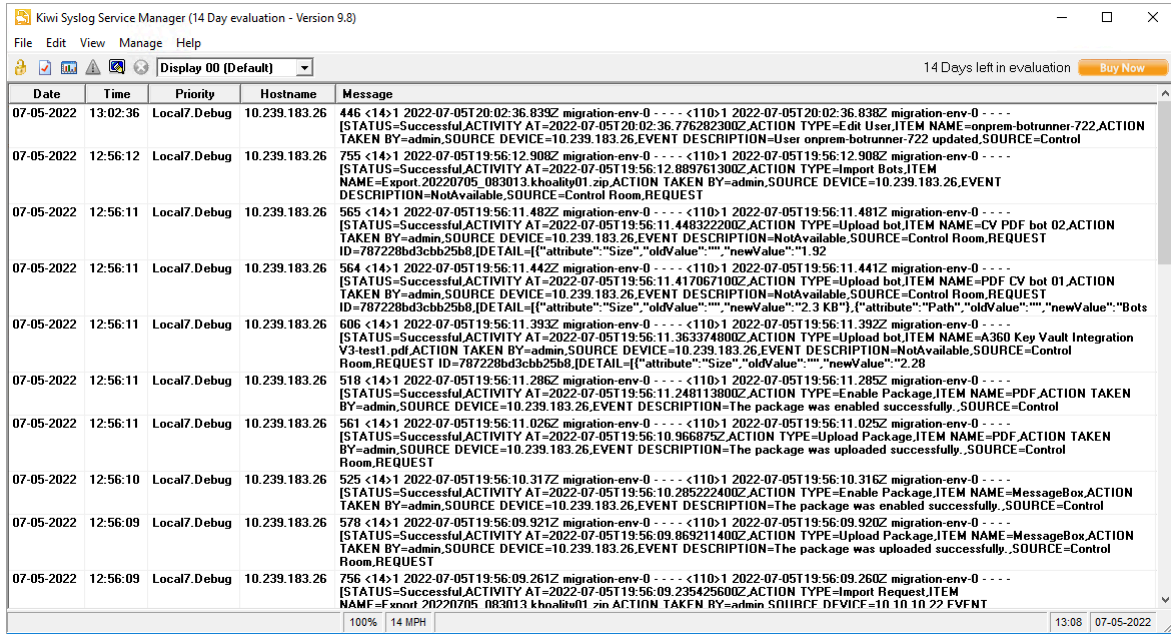

If you have configured Splunk [Splunk](#) as your Syslog server, then you will observe the syslog messages in the Splunk.

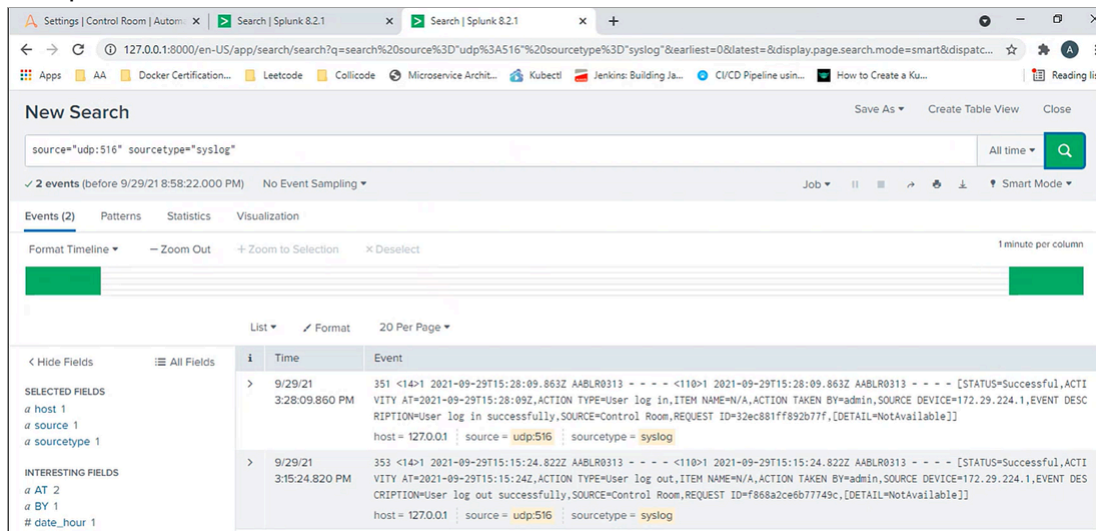

Edit email notifications

Edit details about the email server to use for dispatching email notifications.

Ensure that you are logged in to the [Administration](#) as the administrator.

Specify details about the email server you want to use and the events when the email notification must be sent. To configure **Email** settings, perform these steps:

1. Navigate to **Administration > Settings > Email**.
2. Click the **Edit** icon. (✎)
3. Select **Send email notifications**.

By default, the email notifications are disabled. You may choose not to send a verification ("Welcome") to the created/edited users.

4. Specify the details of the server that you want to use to send email notifications.

Option	Description
From this email address	Enter the email address that you want to use to send email notifications.
Email server host	Specify the email server that you want to use to send email notifications.
Email server port	Specify the email port that you want to use to send email notifications.
My server uses a secure connection (SSL/TLS)	Select the option if the server uses a secured connection.
My server requires authentication	Select the option if the server requires credentials for access, such as for an external credential vault.
Specify the Username and Password you want to use to access the server.	Specify the credentials.

Important: The options to specify or modify the email server details are available only for the On-Premises deployment.

5. Select any or all of the following options to specify the events when an email notification must be sent:

- **User initiates Forgot Password process from Login screen**
- **User information changes, to the user**
- **A user is activated, deactivated or deleted, to the user**
- **A Task Bot stops running because it is unsuccessful, to the user who started or scheduled it**
- **A BLM package is exported or imported, to the user who performed BLM export or import**
- **A checkin process fails**

Important: If the **Require verification** option is not selected, an email notification without verification link is sent to the specified email ID. You can log in to the Control Room without verifying the email ID and setting the login credentials.

6. Click **Save changes**.

Version control in Automation 360

Version control helps you to manage the changes that you make to files that include TaskBots, documents, reports, scripts, executable files, and workflows. With version control, you can track and monitor changes to your bot logic.

With version control, you can identify the version of a bot that you want to modify and compare your recent changes against the changes made to the bot previously. As a Control Room admin, you can configure version control in the Control Room settings.

Automation 360 includes version control capabilities, and you can use these capabilities irrespective of whether you have integrated your Control Room with Git. Review the capabilities available in Automation 360 and Git.

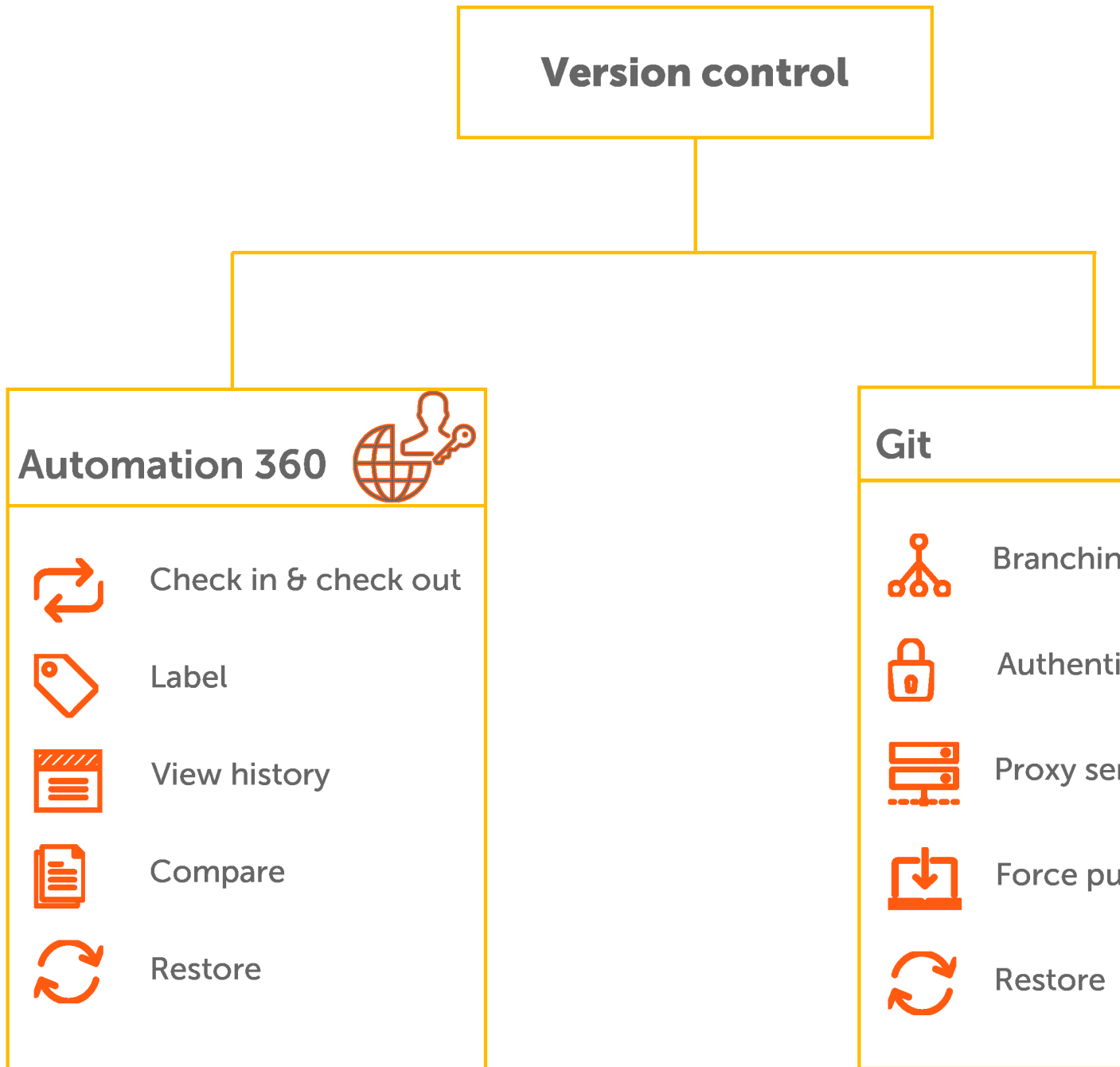

Version control in Automation 360

- **Check out and check in TaskBots:** You can check out one version of a bot (version 1) from public to your private workspace, make changes to it, and then check in the bot to the public workspace. This creates a new version (version 2) of the bot, which is the latest version. Every time you check out, make changes to, and check in a bot, a new version of the bot is created as the latest version.

Note: You can run either the latest version of a bot or the version that has the production label.

You can roll back to a particular version of a bot by selecting **Advanced options** in the check out action to select a specific version of the bot to check out. Also, you can select the dependencies to check out. By doing this, you can make changes to a specific version of a bot and its dependencies.

When you check in this bot, it becomes the latest version. For example, if the latest version of a bot is version 8 and you want to roll back to version 3, you must first check out version 3 of the bot and then check it back in, which creates version 9. This latest version, which is identical to version 3, is now available in the public workspace for bot operations.

[Check in a bot](#) | [Check out a single bot](#)

- **Label TaskBot:** You can also roll back to a specific version of a bot by assigning a label to that version of the bot. You can use this label to choose the version with which you want to perform certain bot operations. With the version of your choice, you can schedule, run, queue, export, and trigger bot development workflows.

[Assign label to a bot](#)

- **View TaskBot history:** You can view the version history of your TaskBots in the public workspace. With **View history**, you can view the history of changes that have occurred in your TaskBots and identify the actions performed by a user. The list of all the versions of a bot is shown in reverse chronological order. The information displayed includes version number, check-in message, date and time of check-in, and the name of the user who checked in the version.

[View TaskBot version history](#)

- **Compare versions:** You can compare any two versions of your TaskBots to view the differences between those two versions.

[Compare bot versions](#)

- **Restore bots from Git:** Even if your Control Room is not integrated with Git, you can restore bots from Git to your public workspace. For example, if you have 50 bots in your public workspace and 75 bots in Git, you can restore the remaining 25 bots from Git to your public workspace.

Note: This restore option is available only for On-Premises deployments and not supported on Cloud deployments.

Version control with Git

If your Control Room is integrated with Git, all the versions of the bots and files in Automation 360 are synced with Git, and you can use the following additional capabilities:

- Integrate with a Git branch.
- Integrate with Git through SSH authentication.
- Integrate with Git through a proxy server.
- Restore bots or files to an empty public repository from an existing Git configuration.
- Configure force push when connecting to Git.

[Integrating Control Room with Git repositories](#)

Integrating Control Room with Git repositories

Git integration with the Control Room ensures one-to-one mapping of the bots checked in to the public workspace of the Control Room and the remote Git file structure. Git commits enable you to enforce security, compliance, and code standards, and ensures that an organization's established best practices can be applied to their bot development processes.

The Control Room has Git Client that is connected to the Git repository that stores the file history of your public workspace. Each time a bot developer performs a bot check-in:

- The bot and the dependent files are checked in to the public workspace.

- The Control Room creates a commit that contains all the contents of the particular check-in within the Git repository.
- The comment entered in the check-in process is used as the Git commit message and the user details are recorded as the author of the Git commit.
- The Bot definitions are stored as JSON files in the Git repository.

Note: The Git repository must be configured to have write access only to the Control Room and not to any other Git client.

Supported Git repositories

You can configure the Control Room to replicate the built-in Git repository with the remote Git host, and synchronize information using Git push. The following sources are certified for Git integration with the Control Room.

- GitHub
- BitBucket
- Azure DevOps

Configure HTTPS (username and password authentication) between the Control Room and the remote Git host. The Control Room and remote Git host use standard Git push protocol over HTTPS to send or receive data.

Exposing the files to your remote Git host enables you to review the bot code and files using third-party comparisons and static code analysis tools to help enforce compliance and maintain security standards.

Configure a remote Git repository in Control Room

Configure a remote Git repository in the Control Room so that you can version all the bots and their dependencies and store them in the Git repository. In addition to the local Automation 360 repository in the Control Room, the remote Git provides a backup for the bots and their dependencies.

- In order to configure a remote Git repository in the Control Room, ensure that you have the `AAE_Admin` role.
- Based on your region, configure your network firewall to add outbound NAT gateway IP addresses to the allowed list.

[Automation 360 IP addresses for external integrations](#)

Note:

- The Git repository must be configured to have write access only to the Control Room and not to any other Git client.
- You cannot upload files greater than 100 MB to the Git repository.

-
1. In the Control Room, navigate to **Administration > Settings > Remote Git repository integration**.
 2. Click **Edit**.

3. Choose one of the following authentication methods and perform the corresponding steps to set up your Git configuration:

Authentication method	Steps
HTTPS Authentication	<p>a. Enter the HTTPS repository path, including the username in the following format:</p> <pre>https://<username>@bitbucket.org/ companyname/product.git</pre> <hr/> <p>Note: Use the Git host that you want to obtain the Git repository address.</p> <hr/> <p>b. Enter the branch name.</p> <p>The changes are pushed to the branch selected. By default, the master branch is selected.</p> <p>c. Enter your Git repository password or a generated Git token.</p> <p>d. Re-enter the password or Git token to confirm.</p>
SSH Authentication	<p>a. Enter the SSH repository path in the following format:</p> <pre>https://git@bitbucket.org:companyname/ product.git</pre> <hr/> <p>Note: Use the Git host that you want to obtain the Git repository address.</p> <hr/> <p>b. Enter the branch name.</p> <p>The changes are pushed to the branch selected. By default, the master branch is selected.</p> <p>c. Enter your SSH authentication private key.</p> <p>You must create the private and public key pair by using the RSA algorithm.</p> <hr/> <p>Note: Ensure that the private key entered in the Control Room contains the following string: -----BEGIN RSA PRIVATE KEY----- AND -----END RSA PRIVATE KEY-----</p> <p>You must generate the public key and enter it in your Git server.</p> <p>See the following topics for steps on how to generate the public key depending on your server:</p> <ul style="list-style-type: none"> • Adding a new SSH key to your GitHub account • Set up an SSH key to your BitBucket account <hr/> <p>d. Optional: Enter the passphrase.</p>

4. Optional: Select the **Connect to Git via proxy** check box.
 - a) Enter the proxy host name or IP address.
 - b) Enter the port number.
 - c) Optional: Select the authentication check box and enter the user name and password.
5. Click **Connect and Save**.
The Control Room connects to the remote Git repository, and the following message is displayed: `Git integration settings successfully saved`. You can also check the audit log where the status for **Set git settings** is displayed as successful.

You can connect to the same Git repository with a different username in the Control Room. For more information, see [How to change the remote Git repository username in the control room \(A-People login required\)](#).

See the following video for an overview of Git:

Connect to Azure DevOps Git from Control Room

You can connect to Azure DevOps Git through the Control Room to check in and manage a bot and its dependent files to the remote Azure DevOps Git repository. It creates a back-up for all your checked-in bot and its dependent files on Azure DevOps.

- To connect to Azure DevOps Git from Control Room, ensure that you have the `AAE_Admin` role.
 - Make sure that you have an Azure DevOps account.
1. Log in to the Azure DevOps account.
 2. Create an Azure DevOps project. Provide a project name and description, select project visibility (public or private), and then click **Create**.
 3. Click **Repos**.
 4. Click **Generate Git Credentials**. Enter the username and the password or token. When you obtain a token to connect to Git, ensure that you have **Read** and **Write** permissions.
 5. Copy the Git repository path without any changes to **Administration > Settings > Git integration > Configuration > Setup Git integration > Edit > Git repository path (including username)** in the Control Room and enter the password/token.
 6. Click **Connect and Save**.
 7. To confirm whether your connection is successful, check in a file from the private repository to a public repository and verify that your changes are pushed to Azure DevOps Git repository.

Remove Git integration configuration

If there is no longer a need to synchronize the bot information stored in your Control Room with the remote Git host, you can remove or disable it.

Ensure that you have the `AAE_Admin` role assigned to you.

1. Navigate to **Administrators > Settings > Git Integration**.
2. In the **Git Integration** window, click **Edit**.
3. Select **Do not set up Git integration**.
4. Click **Connect and Save**.
This setting removes the remote Git configuration, and the Control Room will no longer push the Git history to the remote Git host.

Automation 360 IP addresses for external integrations

To ensure seamless connectivity of your Git instance, on premises key vault, or SIEM with the Cloud Control Room, configure your network firewall to include Automation Anywhere outbound Automation 360 IP addresses to the allowed list.

Based on your region, add the following outbound Automation 360 IP addresses to the allowed list:

Region	IP addresses
- Africa	<ul style="list-style-type: none"> • 13.244.57.44 • 13.244.197.159 • 13.244.185.72 • 54.228.5.1 • 54.228.48.30 • 54.217.103.248
- Australia	<ul style="list-style-type: none"> • 54.153.153.175 • 52.65.8.56 • 3.106.147.142
- Canada	<ul style="list-style-type: none"> • 35.203.94.19 • 34.152.28.44
- EU West 1	<ul style="list-style-type: none"> • 108.128.188.103 • 63.34.200.237 • 52.30.160.238 • 18.197.15.181 • 18.195.27.35 • 3.123.208.13
- EU West 4	<ul style="list-style-type: none"> • 35.204.101.230 • 34.141.232.185 • 34.141.55.27 • 34.141.57.227
India	<ul style="list-style-type: none"> • 3.7.60.137 • 3.6.235.61 • 13.232.116.48 • 18.136.73.65 • 52.77.203.34 • 18.136.8.15

Region	IP addresses
- Japan	<ul style="list-style-type: none"> • 18.177.157.130 • 18.176.174.19 • 3.114.196.205 • 54.169.202.27 • 52.221.25.42 • 18.140.96.19
- LATAM	<ul style="list-style-type: none"> • 54.94.241.48 • 18.229.39.93 • 52.67.153.170 • 34.195.218.48 • 3.211.67.78 • 3.228.163.41
- Middle East	<ul style="list-style-type: none"> • 15.185.153.52 • 15.185.181.122 • 157.175.32.98 • 52.213.112.204 • 54.154.112.221 • 34.242.58.85
- Sandbox Australia	<ul style="list-style-type: none"> • 34.151.71.179 • 35.189.24.10
- Sandbox EU West	<ul style="list-style-type: none"> • 54.228.82.108 • 54.73.17.42 • 54.228.85.241 • 3.122.33.207 • 35.156.216.8 • 18.159.235.149
- Sandbox US West	<ul style="list-style-type: none"> • 35.164.189.142 • 35.166.154.241 • 35.160.254.91 • 35.168.234.8 • 34.204.215.165 • 54.92.237.118
- Singapore	<ul style="list-style-type: none"> • 18.141.71.43 • 54.251.139.55 • 18.136.253.184 • 18.176.165.62 • 52.68.115.49 • 54.168.135.182

Region	IP addresses
- US Central	<ul style="list-style-type: none"> • 34.85.131.101 • 35.245.151.203 • 34.68.252.217 • 34.123.71.95
- US East	<ul style="list-style-type: none"> • 50.16.245.134 • 35.174.84.76 • 3.210.114.16 • 54.244.136.23 • 54.185.77.190 • 44.234.224.213
- US West	<ul style="list-style-type: none"> • 54.213.119.159 • 34.218.159.79 • 52.33.16.117 • 3.225.222.13 • 34.197.160.162 • 3.213.188.29
- Sandbox US Central	<ul style="list-style-type: none"> • 35.223.219.53 • 34.133.80.165 • 34.150.165.212 • 35.245.150.192
- Sandbox Singapore	<ul style="list-style-type: none"> • 13.251.176.239 • 54.169.33.175 • 46.137.201.87

Restore bots from Git repository

If your database is deleted or corrupted, you can restore all your bots and the associated dependent files from the Git repository to your new database. This restore option is available only for On-Premises deployments and not supported on Cloud deployments.

Ensure the following before you restore your bots from Git:

- You must have a backup of the bots on Git.
- You must have the **AAE_Admin** role assigned.
- The Git restore process requires some downtime. When the restore process is running, the following public workspace operations are disabled:
 - Check-out
 - Clone
 - Run and schedule bots
 - Run bots with queue
 - Import and export bots

- When the restore process is running, the check-in operation is not allowed from the private workspace. However, you can use the private workspace for the rest of the operations.
- You can restore your bots to your empty or non-empty repository.
- You cannot abort an ongoing restore process.

1. Log in to the Control Room as an admin user.
2. On the left pane, click **Automation**.
A list of available and forms is displayed.
3. Click the **Restore from Git** option in the **Public** workspace.
The **Restore from Git** dialog box appears, displaying a warning that all the public repository operations will be disabled during the Git restore process.
4. If you have duplicate files in the Git repository, select to either **Overwrite existing files** or **Skip existing files** in the Git repository.
5. Based on whether the repository is empty or non-empty, choose one of the following options:
 - To restore files to a repository that is not fully empty, enter your Git credentials for the associated repository.

Note: You cannot use the existing Git configuration for a partially filled repository.

- To restore files to a fully empty repository, you can choose the Git repository from which you want to restore your files.

Option	Action
Use existing git configuration settings	Select this option to restore your data from the Git repository configured with the Control Room. Note: Ensure you connect your Control Room to the remote Git repository from Administration > Settings > Remote Git repository integration .

Option	Action
Use manual settings	<p>Select this option to restore data from any other repository.</p> <ol style="list-style-type: none"> Enter the HTTPS repository path including the username in the following format: <code>https://<username>@bitbucket.org/companyname/product.git</code> Enter the branch name. Enter your Git repository password or a generated Git token. Re-enter the password or Git token to confirm. <hr/> <p>Note: If you are using the same settings as the existing Git configuration, you will encounter an error. To use the same configuration, first remove the remote Git repository integration setting in Administration > Settings > Remote Git repository integration before providing the same in this manual settings option.</p>

6. Optional: Select the **Connect to Git via proxy** check box.
 - Enter the proxy host name or IP address.
 - Enter the port number.
 - Optional: Select the authentication check box and enter the user name and password.

7. Click **Continue** to proceed with the restore process.

The system starts restoring the bots and the dependent files from Git. This process takes some time. After the restore process is completed successfully, you are automatically returned to the **Automation** page. The bots and the dependent files are restored in your new database, maintaining the original structure of the dependent files.

If the Git restore process fails after restoring some bots, you are redirected to the public workspace with the following options. Choose the required option to complete the restore process:

Option	Action
Revert restoration bots	<p>This option clears all the bots that were restored.</p> <hr/> <p>Note: This option will delete the public bots that were restored from the Git repository.</p>
Restart restoration	The Git restore process restarts from where it ended.
Keep only the restored files	This option retains whatever files were restored and will exit the restore process.

Usage statistics

Automation Anywhere collects usage statistics from Automation 360 for product improvements.

Usage statistics provides information on where users might be facing issues with the product, the most used or least used features, and so on. This information helps in product improvement which in turn helps in improving the customer experience.

By default, the **Usage statistics** option is enabled in the Control Room and usage data is collected. The data collected is stored in Automation 360 and the service provider cloud. The collected data is typically generic information such as anonymized user details, customer name, and user navigation workflows such as menus the users access and clicks.

An administrator can disable the **Usage statistics** option by changing the settings in the Control Room.

Note: The option can be disabled only for On-Premises deployments.

Disable usage statistics

An administrator can disable the **Usage statistics** option by changing the settings in the Control Room.

Ensure that you are logged in to the as the administrator.

1. Navigate to **Administration > Settings > General > Advanced settings**.
2. Click the **Edit** icon. (✎)
3. Select the **Disabled** option.
4. Click **Save changes**.

Set up instances for Cloud-enabled deployments

Manage trust relationship between the cloud-deployed Automation 360 Cloud-enabled instance and the On-Premises applications.

Ensure that you are logged in to the as the administrator.

For Cloud-enabled deployment, the initial welcome email that you received from Automation Anywhere contains:

- URL to the Automation Anywhere Cloud-enabled instance
- Provisioning token needed to establish trust connectivity with the Automation Anywhere Cloud Control Room

Automation Anywhere deploys and configures an Automation Anywhere Automation 360 Cloud instance for this Cloud-enabled deployment option. The customer then installs the On-Premises application within their infrastructure for storing and processing customer data. After this is complete, you install the On-Premises application within your infrastructure for storing and processing customer data.

1. Log in to the On-Premises Control Room as the administrator.
2. Navigate to **Administration > Settings > Cloud-enabled**.
3. Provide the provisioning token to connect to the Control Room.
4. Click **Save changes**.
5. Optional: Test the Cloud-enabled functionality.
Open a browser and enter the URL for the Cloud Control Room service instance. Click **Enter** to be redirected to the On-Premises Control Room.

Generate registration key to install Bot Agent in bulk

The Control Room administrator can generate a registration key to install the Bot Agent on multiple devices at a time in bulk.

Ensure you have set up the Microsoft Active Directory group policy to remotely install the Bot Agent on multiple devices.

Use Microsoft Active Directory Group Policy to remotely install software

Generate and copy the key for use in an installation script or as part of the Active Directory group policy to install the Bot Agent on multiple devices at a time.

Also, download the latest Bot Agent MSI installer file to your default downloads path to install the Bot Agent in bulk.

1. Navigate to **Administration > Settings**.
2. Select the **Bot agent bulk install** option.
3. Generate a new registration key for installation.

Note: Before you generate a new key, keep in mind that the new key invalidates the previous key and any entries or references to the previous key must be replaced with the new key value. Therefore, we recommend that you generate a new key only if the previous key is compromised.

- a) To launch the setting in edit mode, click the **Edit** option.
When you open this setting for the first time, the option **Generate a new key** is shown by default and the phrase `Key not set` appears.
 - b) To create a new registration key, select the **Generate a new key** option.
 - c) To install the Bot Agent using an installation script or through a Active Directory group policy, click **Copy to clipboard**.
 - d) Save the settings.
4. Replace the registration key:
 - a) To launch the setting in edit mode, click the **Edit** option.
The **Keep current key** option is displayed by default.
 - b) To generate a new registration key, select the **Generate a new key** option.
 - c) Select **Continue** on the **Current registration key replacement** message box.
 - d) To use the key, click **Copy to clipboard**.
 - e) Save the updates.
 5. To download the latest Bot Agent MSI installer file, click **Download installer**.
The Bot Agent installer MSI file is downloaded to your default `Downloads` folder.

Edit the Bot Agent MSI file to remotely install the Bot Agent on multiple devices.

Related tasks

[Perform bulk installation of Bot Agent on devices](#)

Edit the Bot Agent MSI file to bulk install (or silently install) the Bot Agent on permanent and temporary devices such as on-premises machines, virtual machines (VM), and non-persistent virtual desktop infrastructure (VDI), for example Citrix, in the Control Room.

Edit the Bot Agent installer file

Edit the Bot Agent MSI installer file to add the registration key and Control Room URL to remotely install the Bot Agent on multiple devices.

To perform this task, you must be a administrator and have the required rights and permissions.

Ensure the Windows 10 Software Development Kit including Orca and Control Room are installed on your device. You can install Orca from `C:\Program Files (x86)\Windows Kits\10\bin\10.0.18362.0\x86\Orca-x86_en-us.msi`.

Set up the Microsoft Active Directory group policy to remotely install the Bot Agent on multiple devices.

Use Microsoft Active Directory Group Policy to remotely install software

Edit the Bot Agent .msi file to enable the Control Room administrator to implement the auto-update Bot Agent policy.

1. Use the latest `AutomationAnywhereBotAgent.msi` file from the following locations:

- Download the file from the Control Room (**Administrator** > **Settings** > **Bot agent bulk install**).

The download option is available for On-Premises and Cloud deployments.

- Select the file from the `<application filepath>\crui\asset` folder. For example `C:\Program Files\Automation Anywhere\crui\asset`

This option is available only for On-Premises deployments.

2. Edit the `AutomationAnywhereBotAgent.msi` file using Orca tool.

3. Click the **Property** option.

4. Change the value for `AA_CRTOKEN` and `AA_CRURL`.

The `AA_CRTOKEN` uses the registration key and the `AA_CRURL` uses the Control Room URL for which the registration key is generated.

5. Save your changes.

Configure integration with SIEM

The Automation Anywhere Control Room supports security information and event management (SIEM) tools ingesting logs from your tenant's Audit logs.

With SIEM integration, audit logs can be sent to analytic tools, such as *Splunk*, *Qradar*, *Sumologic*, and *ArcSight*. By pushing audit log entries to SIEM tools, you can integrate and leverage the advanced searching and reporting features of SIEM solutions. When configured, the Control Room audit logs are forwarded to the configured SIEM server.

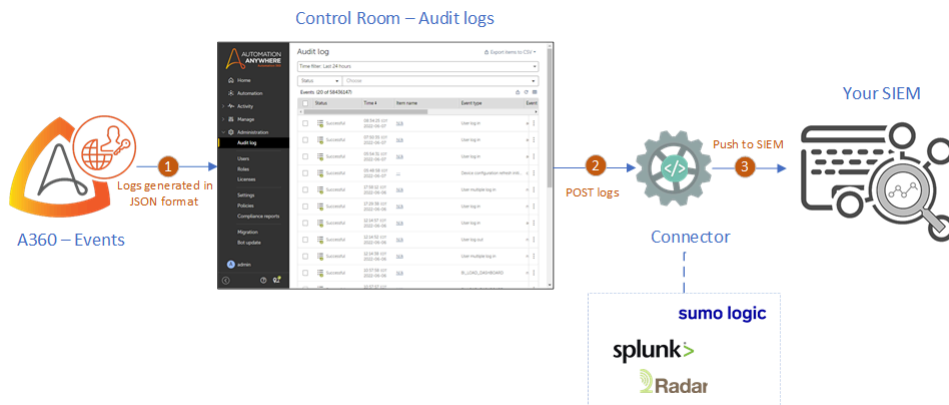

Configure an SIEM server step by step so that Automation 360 sends the audit messages to the SIEM server. In the following example, Sumo Logic is used as the SIEM provider. Use the same procedure to configure any other SIEM server.

Setting up Sumo Logic

Setup the Sumo Logic as a SIEM tool to collect logs.

To use Sumo Logic as a logging endpoint, you will need to create a Sumo Logic account, add a new source, and save the HTTP source URL.

To add a new source in the Sumo Logic website, perform the following steps:

1. After you create your Sumo Logic account, the Sumo Logic Setup Wizard appears. If you already have an account, you can access the wizard by selecting **Setup Wizard** from the **Manage** menu at the top of the Sumo Logic application. In the **Setup Wizard**, click **Set Up Streaming Data**

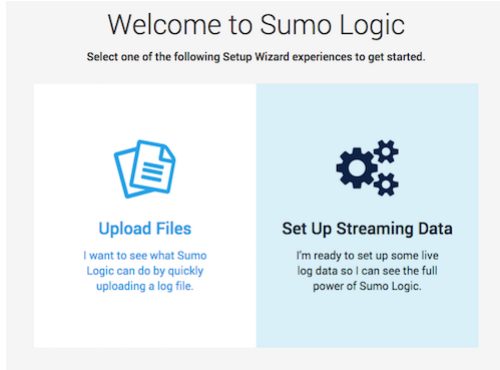

The **Select Data Type** window appears.

2. Click **All Other Sources**.

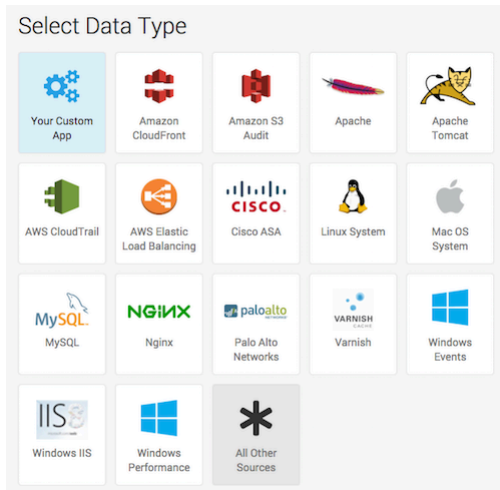

The **Set Up Collection** window appears.

3. Click **HTTP Source**.

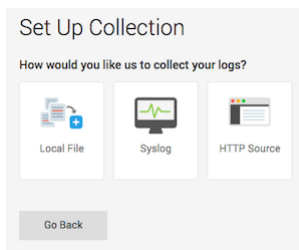

The **Configure Source: HTTP Source** window appears.

4. Enter a name in the **Source Category** (for example, Http Input), and select a timezone for your log files.

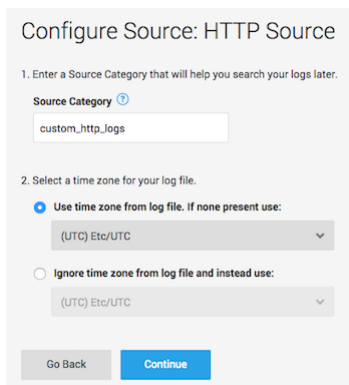

5. Click **Continue** to see a magic url such as the following:
`https://endpoint1.collection.us2.sumologic.com/receiver/v1/http/ZaVnA4dhaV0nFJAEMuwFDGEEZUnDedm7hYhkdUJSAE44bmKKp1mp4LsYDCr2MzTA0C21czkqjz9UVjC1mk41w`

6. Save this URL in an editor. You will need it when you add Sumo Logic as an SIEM logging endpoint.
[Adding Sumo Logic as an SIEM logging endpoint](#)

Adding Sumo Logic as an SIEM logging endpoint

To configure the server where audit logs will be sent, add the Sumo Logic as an SIEM logging endpoint.

Note:

To perform this task, you must be a administrator and have the required rights and permissions.

1. Navigate to Administration > Settings > SIEM Integration Configuration.

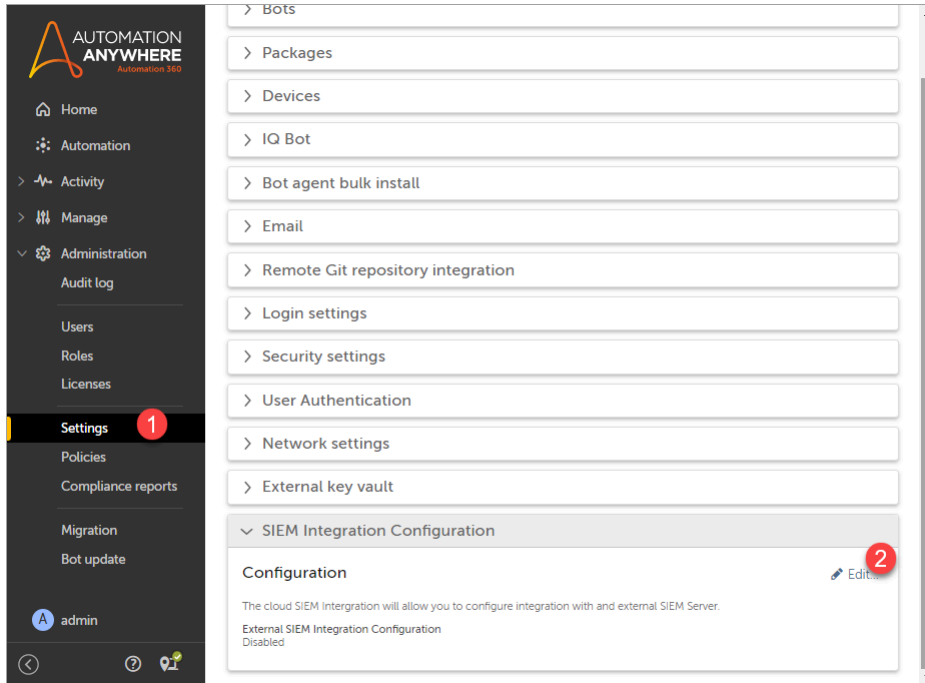

2. Click the Edit icon. (✎)

3. Select Enabled and paste the SIEM server endpoint that you copied previously, from Adding Sumo Logic as an SIEM logging endpoint.

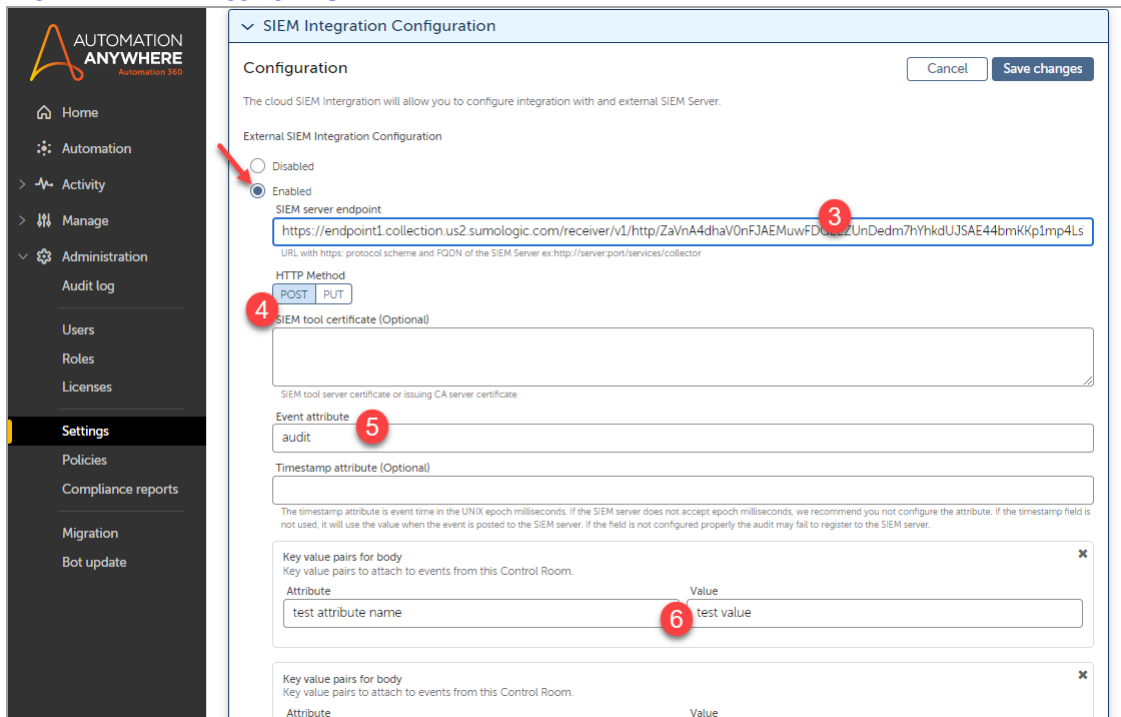

Note: Ensure that you refer to your SIEM provider's documentation to get the information regarding the HTTP headers and requirements around JSON attributes (request body).

4. Select **POST** HTTP method, because Sumo Logic accepts the inputs as a POST method.

Note: The SIEM tool certificate is optional and depends on the SIEM provider. Some SIEM providers require you to enter a valid SIEM tool certificate.

5. Enter a name for **Event attribute**(for example, audit). All the log messages will be logged under this category and will act as key to locate all the event logs.

Note: The timestamp attribute is an optional field and depends on the SIEM provider's mapping for this field. For example, Splunk requires the value to be *time* and mapped to one of its timestamp fields. The maximum length allowed is 256 characters. All special characters are allowed except the backslash (\) and double quotation marks ("). These characters have to be escaped.

6. Click on plus (+) sign to enter a few **key-value pairs for body** (static attributes) that are sent out along with the logs. The key-value pairs also take special characters as inputs. You will be able to configure a maximum of 50 attributes.

7. Click on plus (+) sign to enter a few **key value pairs for header** to be sent with every event data log. The header data is specific to the SIEM provider. For example, with Sumo Logic, it supports header names starting with the letter X (for example, X-Sumo-Fields). You will be able to configure a maximum of 50 headers.

For more information about header data, see the corresponding SIEM provider's documentation.

Verifying data in Sumo Logic

Reception of audit logs are verified using the Sumo Logic web interface. One way to do this is to search for events using the name of the collector and source.

Perform the following steps to verify the data in Sumo Logic:

1. Generate an audit log by generating an event. For example, create a user ([Create a user](#)).
2. Go to [Audit log](#) to see the entry in the logs.

In Sumo Logic, you will notice the event logged in the source that you configured when setting up Sumo Logic. [Setting up Sumo Logic](#)

3. Navigate to **Manage Data > Collections**
4. On the **Collection** tab, click **Open in Log Search** icon next to the respective log source.

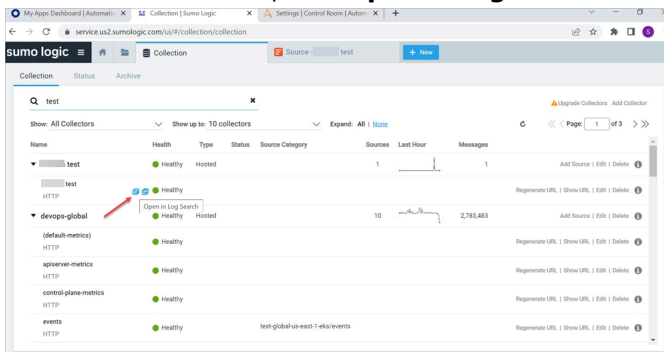

It displays events filtered by collector and source. A user creation event in JSON format sent to Sumo Logic through HTTPS is displayed.

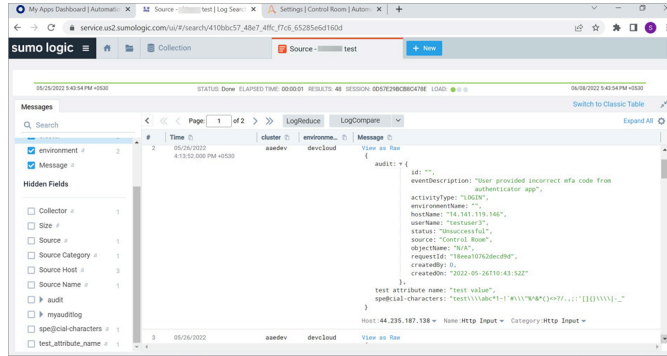

Use AuthConfig App to enable OAuth2 services

As an Organization Administrator with access to CALM (Automation Anywhere app hosted on Salesforce), you use the AuthConfig App to manage the relationship between a set of Automation 360 Control Room instances and our OAuth2 (Open Authorization) services.

Note: The availability of this feature is based on your region.

You use OpenID tokens (issued by Salesforce) to authenticate to the AuthConfig App.

Token overview

Automation Anywhere and the AuthConfig App support the following token types:

- **Control Room registration token:** The AuthConfig App generates this token which you enter in the **OAuth Settings** panel of the Automation 360 Control Room. The Control Room registration token establishes the identity of your Control Room to the AuthConfig App. After you register and enable the token, the Control Room can consume access tokens to call APIs.
- **Access token:** A JSON web token generated from an authorization provider after authenticating with an Identity Provider (IdP). Access tokens contain claims that provide information to a resource server. API calls use access tokens to enable an authorized client to gain access to data on the resource server.
- **Refresh token:** Refresh tokens provide a method to get new access tokens without having to collect and authenticate credentials every time an access token expires.

The AuthConfig App generates Control Room registration tokens to enable OAuth2 services. The following diagram shows how a registration token flows between the AuthConfig App and the Automation 360 Control Room:



1. The Administrator uses the AuthConfig App to generate a registration token.
2. The registration token is stored in the database.
3. The Administrator enters the generated registration token into the **OAuth Settings** in the Automation 360 Control Room.

4. The registration token is stored in the database.
5. The registration token is then sent to the AuthConfig App where if the token matches the token stored in the database, the Control Room is registered.

Benefits

You use the AuthConfig App to:

- Enable or disable OAuth2 services for an Automation 360 Control Room (On-Premises or Cloud).
- Configure an Identity Provider (IdP) configuration using a SAML authentication connection for your organization to use with OAuth2 services.
- Generate registration tokens for each Control Room to securely enable OAuth2 services.

For details about accessing automations in a web scenario with AARI Extensions and using a custom widget through Google Chrome extensions, click [here](#).

Prerequisites

Before you use the AuthConfig App:

- Create your Automation Anywhere community (Apeople) credential: [A-People home page \(login required\)](#).
- From the Automation 360 Control Room:
 - To enable an IdP authenticated user to use an access token to call a Control Room API, you must also add the IdP authenticated user as a Control Room user.
 - To use access tokens, you must register and enable Control Room instances with OAuth2 services.

After you complete the prerequisites, you can [access the AuthConfig App](#).

Access the AuthConfig App

The AuthConfig App generates Control Room registration tokens to enable OAuth2 services.

To access the AuthConfig App:

1. Log in to the Automation 360 Control Room as the Administrator.
2. To obtain the AuthConfig App login URL, you can either:
 - From the Control Room, navigate to: **Administration** > **Settings** > **OAuth**, and then click the link provided in the Registration text area, or
 - Copy and paste this URL (default URL) into a browser window: `https://oauthconfigapp.automationanywhere.digital`
3. The **AuthConfig App Log in** dialog box displays:

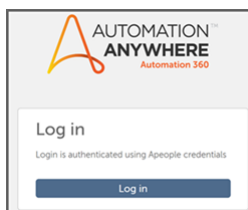

Click **Log in** to log in with your existing Apeople credentials. You are re-directed to the [A-People home page \(login required\)](#) page.

4. From the A-People home page, enter your credentials (username and password) and click **Log in**. You

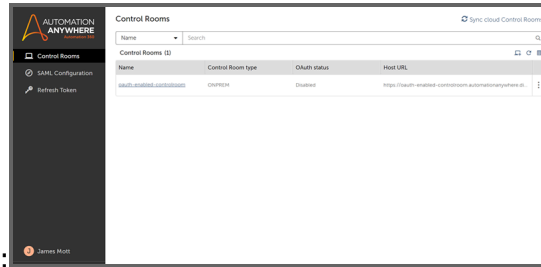

are re-directed to the AuthConfig App page:

From AuthConfig App page, you can:

- [Review existing On-Premises and Cloud Control Room instances to enable OAuth2 services](#)
- [Configure SAML](#)
- [Manage refresh tokens](#)

To log out of the AuthConfig App:

1. Click your username profile at the bottom of the page to open the **Log Out** dialog box:

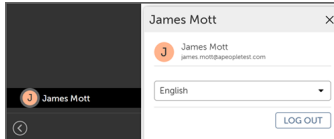

2. Click **Log Out**.

Review Control Rooms

If not already displayed on the AuthConfig App page, select **Control Rooms** on the left side of the page to display a list of all your On-Premises and Cloud Control Rooms.

If new Control Room instances were added through CALM (Automation Anywhere App hosted on Salesforce), click **Sync cloud Control Rooms** at the top of the page to update and display them in the list.

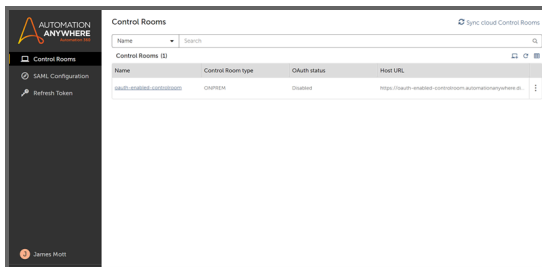

Note: If you delete a Cloud Control Room from the AuthConfig App (which still has a valid license in Salesforce), then the Cloud Control Room will re-appear in the Control Room list after syncing.

From the **Review Control Room** page, you can:

- [Generate a registration token for a Control Room](#)
- [Enable or disable OAuth2 services for a Control Room](#)
- [Add or delete an On-Premises Control Room](#)

Generate a registration token for a Control Room

To generate a registration token for a Control Room:

1. Click the Control Room name or hover over the actions menu (three vertical ellipses) located to the right of the Control Room name and click the **Binoculars** icon. The Control Room details page displays.
2. To generate a registration token for the Control Room to enable OAuth2 services, click **Generate**

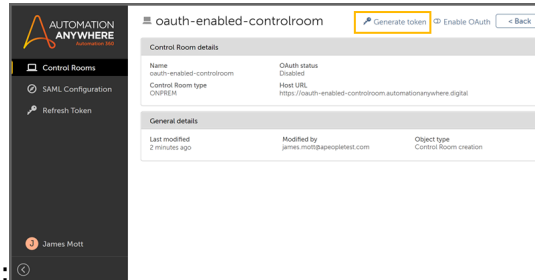

token at the top right of the page:

3. A confirmation message displays asking if you want to generate the token. The generated token is required to register your Control Room tenant with OAuth2. Click **Generate**.
4. A dialog box displays the newly generated registration token. Click **Copy token**.

Note: You should store this token in a safe place for future use. You cannot retrieve this token after you close the window.

5.

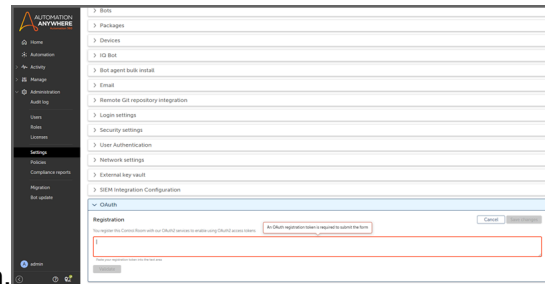

Navigate to: **Administration > Settings > OAuth2**. In the text area, paste the token you copied to register the Control Room with our OAuth2 services to enable using OAuth2 access token.

6. Click **Validate** and review the data to ensure that it matches the Name and Host URL you were expecting.
7. Click **Save changes**.

This registers the AuthConfig App with the selected Control Room.

Enable or disable OAuth2 services for a Control Room

To enable or disable OAuth2 services for a Control Room:

1. Click the Control Room name or hover over the actions menu (three vertical ellipses) located to the right of the Control Room name and click the **Binoculars** icon. The Control Room details page displays.

- By default, the OAuth2 services for a Control Room are disabled. To enable OAuth2 service, click the

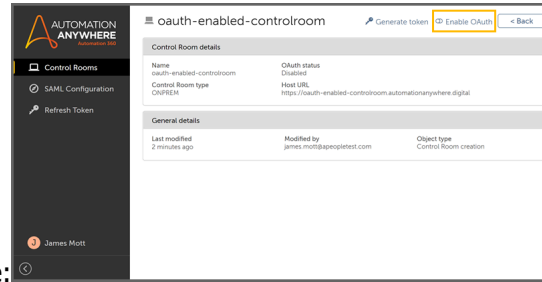

Enable OAuth toggle at the top right of the page:

The OAuth status changes to **Enabled**.

- Click **< Back** to return to the Control Room list.

Add or delete an On-Premises Control Room

Note: You cannot add a Cloud Control Room because it is consumed automatically by the AuthConfig App.

To add an On-Premises Control Room:

- Click the **Add Control Room** icon at the top right of the page:

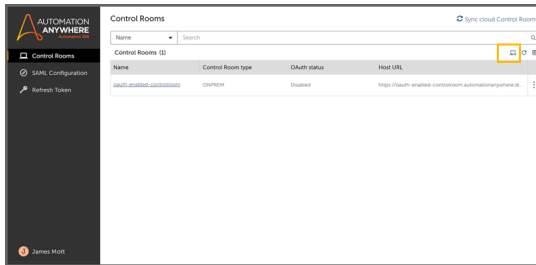

- The **Add an On-Premises Control Room** dialog box displays:

Add an On-premises Control Room Cancel Submit

Name

Host URL

eg. https://...

- Enter a unique **Name** and **Host URL** (for example: `https://digital.automationanywhere.com/nextbank`) for the new On-Premises Control Room. The host URL you enter must match the URL you provided to your external OAuth client (for example: Pixiebrix).
- Click **Submit** when finished.

To delete an On-Premises Control Room:

1. Hover over the actions menu (three vertical ellipses) located to the right of the Control Room name and click the **Delete** icon:

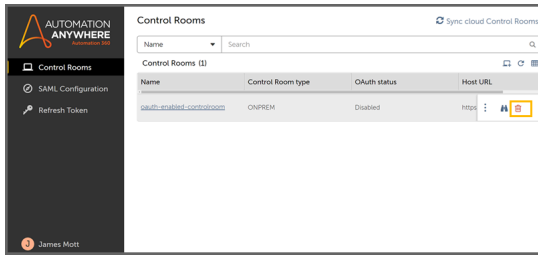

2. A confirmation message displays asking if you want to permanently delete the Control Room. Click **Yes, delete** to remove the registered Control Room from the AuthConfig App.

Configure SAML connection details

You configure SAML to authenticate to your Identity Provider (IdP) to obtain OAuth access tokens.

To configure SAML connection details:

1. From **AuthConfig App** page, select **SAML Configuration** on the left side of the page.
2. Click **New SAML configuration** at the top of the page.
3. The **New SAML configuration** dialog box displays:

- a. Enter the connection name and sign-in URL from your external Auth Provider.
- b. Enter your Identity Provider's (IdP) public key or click **Browse** to search for it. The public key validates the IdP's signed response.
- c. Click **Create**.

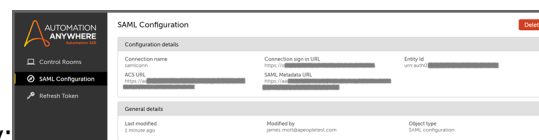

The connection name configuration details display:

The ACS (Assertion Creation Service) URL directs your IdP where to send its SAML response after authenticating a user, and the Entity ID is the unique identifier of the IdP.

To delete the SAML configuration, click **Delete** at the top right of the page. A confirmation message displays asking if you want to delete the SAML configuration.

Note: If you delete the SAML configuration, Control Room users will not be able to obtain new access tokens using our OAuth2 service.

Click **Delete** to continue.

Manage refresh tokens

One SAML connection can have multiple tokens.

To manage the refresh tokens:

1. From **AuthConfig App** page, select **Refresh Token** on the left side of the page. The Refresh Token

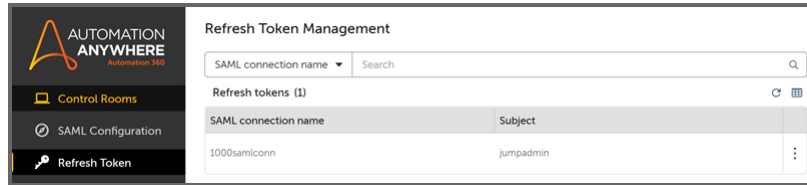

Management page displays:

2. You can enter SAML connection name or subject search parameters in the **Search** box.
3. To revoke a refresh token, hover over the actions menu (three vertical ellipses) located to the right of the token name and click the **X (Revoke)** icon.
4. A confirmation message displays asking if you want to revoke the token.

Note: By revoking the refresh token, the associated application will not be able to obtain a new access token using the refresh token.

Click **Revoke**.

Code analysis

Code analysis enables you to evaluate a program without running the code. In Automation 360, the code analysis feature analyzes the code and displays a list of violations based on a set rules. You can review and fix any coding or stylistic errors for your automation.

Code analysis enables you to form certain code structures with which you can implement coding best practices and make the code maintainable, reliable, efficient, and secure.

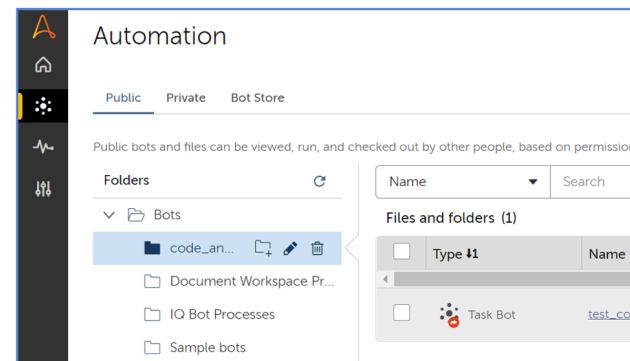
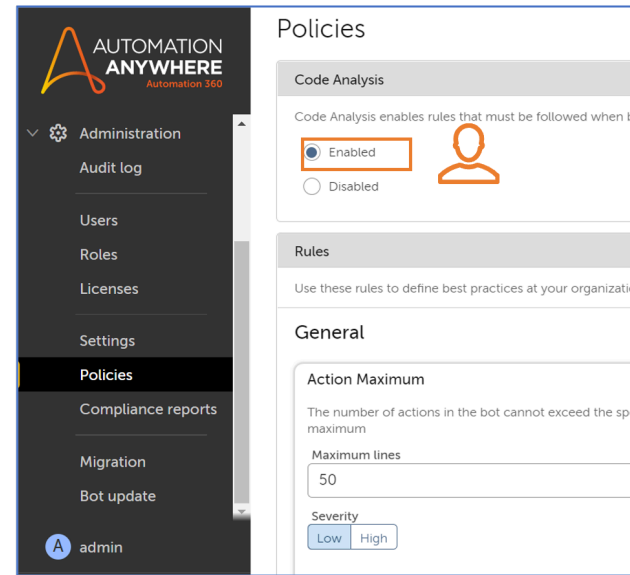
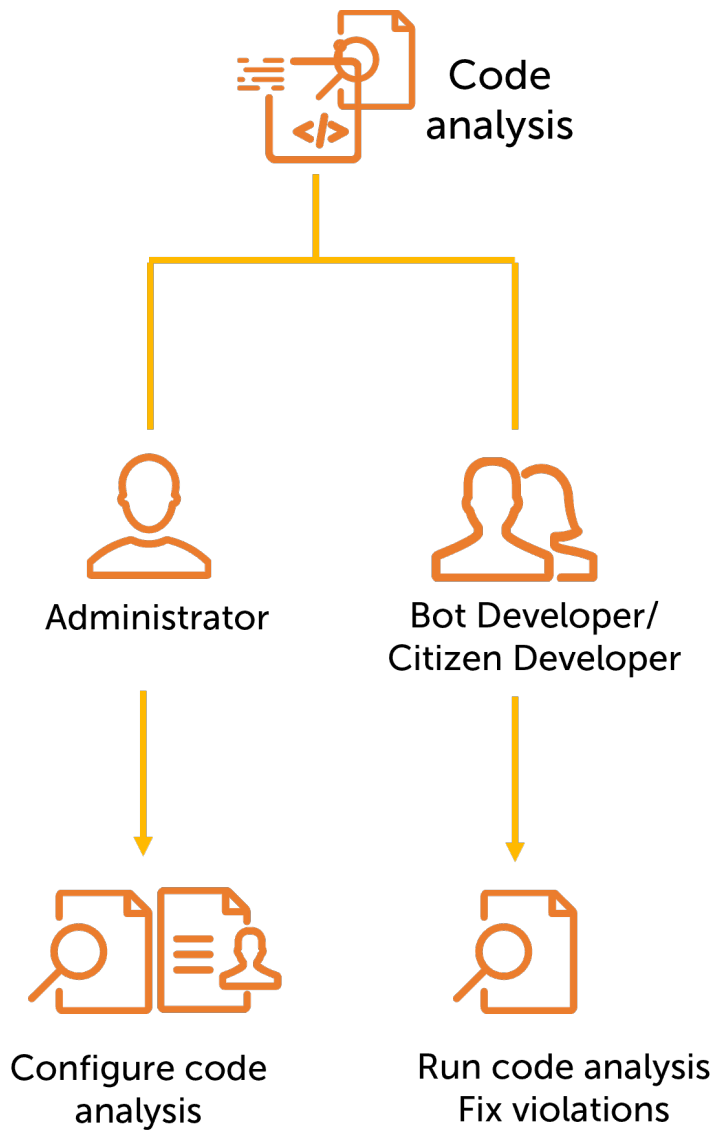

Benefits

Code analysis provides you the following benefits:

- Implement coding best practices by enforcing certain coding conventions.
- Authorize Citizen Developer to introduce new automations.
- Enable complex automations to be more accessible.
- Improve code readability and quality.
- Control the structure of your automation code.
- Improve productivity of the developer and the platform as good coding practise improves the automation quality over time.

Code analysis for user roles

Lead RPA Developer (Administrator)

Configure code analysis policies that define coding best practices in the organization. Monitor

and report the status of code quality based on adherence to these policies. Code analysis enables certain coding practices and principles to be enforced which in turn helps with the following:

- Facilitate the development of automation by a larger pool of business personnel, for example, a Citizen Developer who might not have strong software development skills.
- Improve maintenance of automations by reducing code complexity and improving readability.
- Improve reliability of automations by reducing errors.
- Improve security and compliance of automations by enforcing secure coding practices.
- Reduce production time and costs of automation.

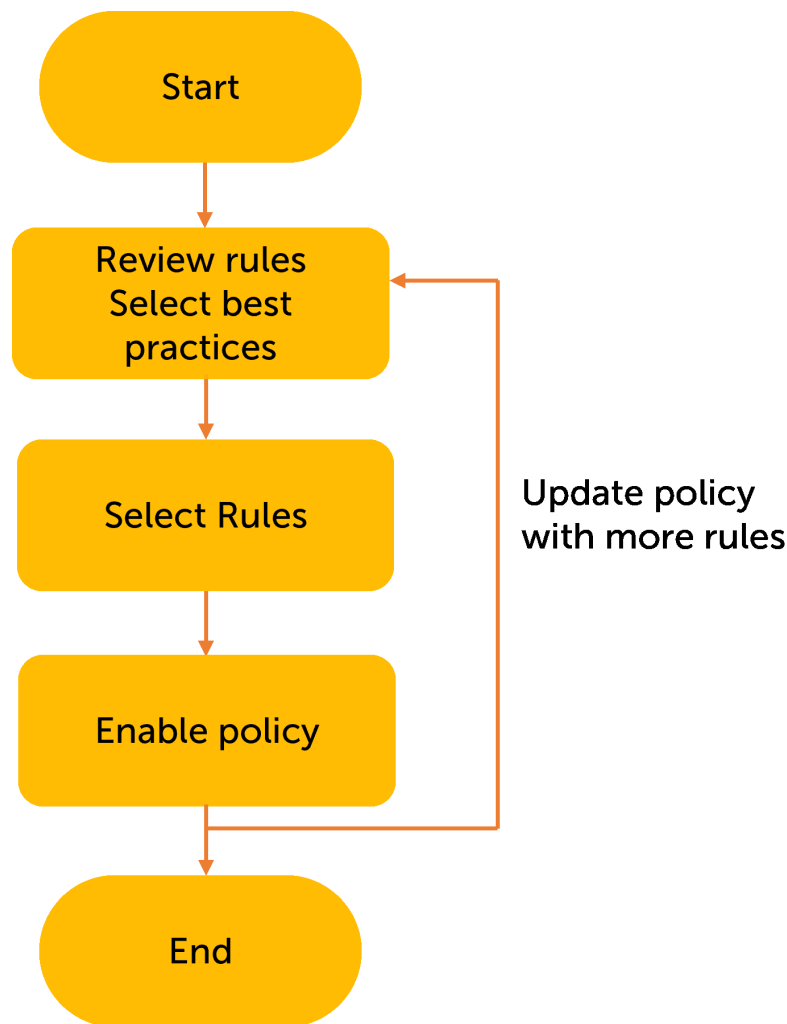

Citizen Developer or RPA Developer

Code analysis provides guidance to develop automations that meet organizational requirements for the following:

- Error reduction

- Code readability and maintenance
- Code security

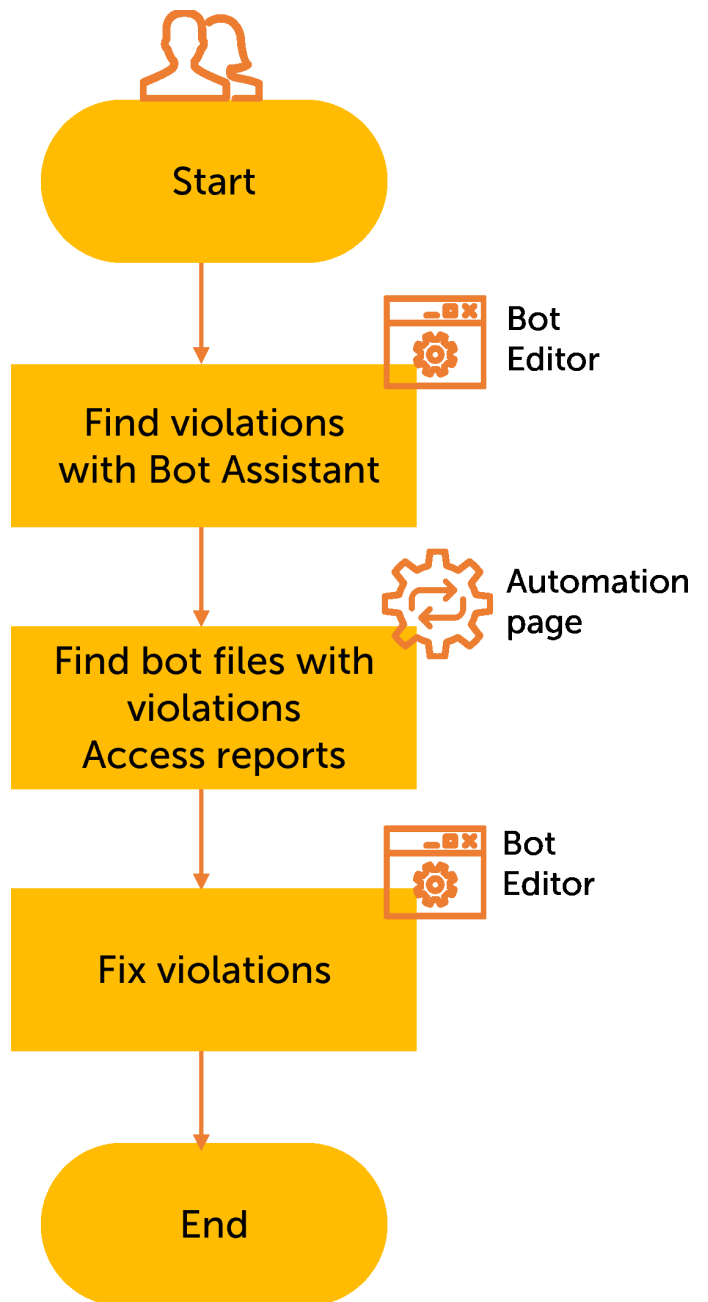

See the following video for an overview of how code analysis is configured:

<https://aa2019packagesdkfordocumentation.s3-us-west-2.amazonaws.com/videos/code-analysis.mp4>

Permissions

You require the following permissions to set up a code analysis policy.

- **View policies:** Allows you to view the code analysis policy that defines how you can build your automations.

- **Manage policies:** Allows you to view and edit the code analysis policy that defines how you can build your automations.

Components

- **Policy editor:** Contains a global policy for all Control Room users.
- **Rules:** As the foundation of code analysis, rules help to evaluate bot code. Rules can be simple or complex depending on the evaluation that is performed. Rules include coding practices that can be verified. They apply to packages and actions in the automation code. A rule consists of a unique RULE_CODE and a description to indicate the nature of evaluation to be performed on the code.

Code analysis rules

Rules are the foundation of code analysis. They are used to evaluate the bot logic. Rules can be simple or complex depending on the evaluation performed. Rules include coding practices that can be verified. They apply to packages and actions in the automation code.

A rule consists of a unique RULE_CODE and a description which indicates the nature of the evaluation to be done on the code. You can use the severity levels (low or high) to emphasize the criticality of the rule.

The following table lists the rules and their description that can be used with code analysis:

Rule code	Group	Title	Rule description
ACT-GEN-001	Actions, general	Action Maximum	The number of actions in the bot cannot exceed the specified maximum
ACT-GEN-002	Actions, general	Try-Catch Coverage	All the non-comment actions within the bot logic must be within a Try/Catch block.
ACT-GEN-003	Actions, general	Infinite Loop Detection	Mandates the check for infinite loops in the bot logic
VAR-NMG-001	Variables, naming	Variable Name Pattern	Variable names must match the specified naming pattern
VAR-NMG-002	Variables, naming	Variable Name Length	Variable names must be within the specified minimum and maximum character length
VAR-USG-001	Variables, usage	No Unused Variables	All the variables must be used within the bot
ACT-COM-001	Actions, comments	Mandatory Header Comment	The first action in the bot must be a Comment action
ACT-COM-002	Actions, comments	Comment Coverage	The number of Comment actions must be equal to or greater than the specified percentage of total command actions
VAL-HCV-002	Values, hard coded values	No Hard Coded Delay	The delay time in the Delay action must be set using a variable
VAL-HCV-003	Values, hard coded values	No Hard Coded File Path	The file or folder path must be set using a variable

Rule code	Group	Title	Rule description
VAL-HCV-004	Values, hard coded values	No Hard Coded Email Address	The command action field must not contain a hard-coded email address
ACT-ERR-001	Actions, error handling	No Empty Catch	The catch block cannot be empty
ACT-ERR-002	Actions, error handling	Mandatory Catch Logging	The catch block must contain a Log to File action
ACT-ERR-003	Actions, error handling	Mandatory Catch Screen Capture	The catch block must contain a Screen capture action
ACT-ERR-004	Actions, error handling	Mandatory Catch Line Reference	The catch block error must contain the reference line number
ACT-LOG-001	Actions, logs	Log to file coverage	The bot logic must contain the specified ratio of Log to file actions

Reviewing code analysis results

As a Bot Creator (RPA developer) or Citizen Developer, you can use code analysis to check and fix any coding errors in your bots. You can develop automation based on configured code analysis policies and predefined rules.

With code analysis, you can improve the reliability of your bots by implementing coding best practices such as variable naming conventions, comment coverage, and error handling. Building bots conforming to the predefined guidelines or rules helps you to identify possible errors during bot development. This reduces bot failures in the production environment. You can run code analysis in both your private and public workspaces and view the results.

With code analysis (available from the Bot editor), you get the following benefits:

- Run code analysis as required.
- Get tooltip guidance for compliance with rules
- Integration with Bot Assistant for accounting and guidance.

Code analysis results

To view the results of code analysis, go to the **Automation** page, and check the **Code Analysis results**. This column shows a summary status of the code analysis results for each automation file. The following details of each status are available:

- **N/A:** Code analysis does not apply to the object because the object is a folder or is not a bot file.
- **Not Scanned:** Code analysis has not been run on the bot.
- **High severity:** The bot has at least one high severity violation.
- **Low severity:** The bot has at least one low severity violation, but no high severity violations.
- **No violations:** There are no code analysis violations in the bot.

The following image shows an example result from code analysis:

and files cannot be viewed by other people. If a bot or file has been checked out from the Public tab, it can be viewed and run by you, but cannot be edited.

Name		Search							
Files and folders (5)									
<input type="checkbox"/>	Type	Name	Status	Source version	Code Analysis results	Size	Last modified	Modified	
<input type="checkbox"/>	Folder	bulk_checkin	N/A	N/A	N/A	N/A	3 minutes ago		S
<input type="checkbox"/>	Task Bot	Excel find text which is no...	New	N/A	Not scanned	16.39 KB	23 minutes ago		S
<input type="checkbox"/>	Task Bot	test_code_analysis	Checked out	3	High severity	2.75 KB	21 hours ago		S
<input type="checkbox"/>	Task Bot	test_migration	New	N/A	Low severity	1.27 KB	24 minutes ago		S
<input type="checkbox"/>	Task Bot	test1	New	N/A	Not scanned	2.32 KB	24 minutes ago		S

100 per page

Note: The status of the bots in the code analysis results column is set to not scanned for the following scenarios:

- The bot is edited in the private workspace.
- Code analysis is disabled by the administrator or there is a change in any of the rule configuration.

Reviewing results in Bot editor

When you create a bot or modify an existing bot and then save the bot in the Bot editor, code analysis is initiated in the background, and the results are displayed in the Bot Assistant. The code analysis header shows the total count of violations in the bot. You can expand the code analysis option, select a specific object and view the following attributes:

- Applicable object: Displays the bot, variable, action, and action attribute.
- Rule code: Unique RULE_CODE ID.
- Severity: High or low.
- Rule text: Description to indicate the nature of evaluation to be performed on the code.

The following image shows an example of code analysis displayed in the Bot Assistant:

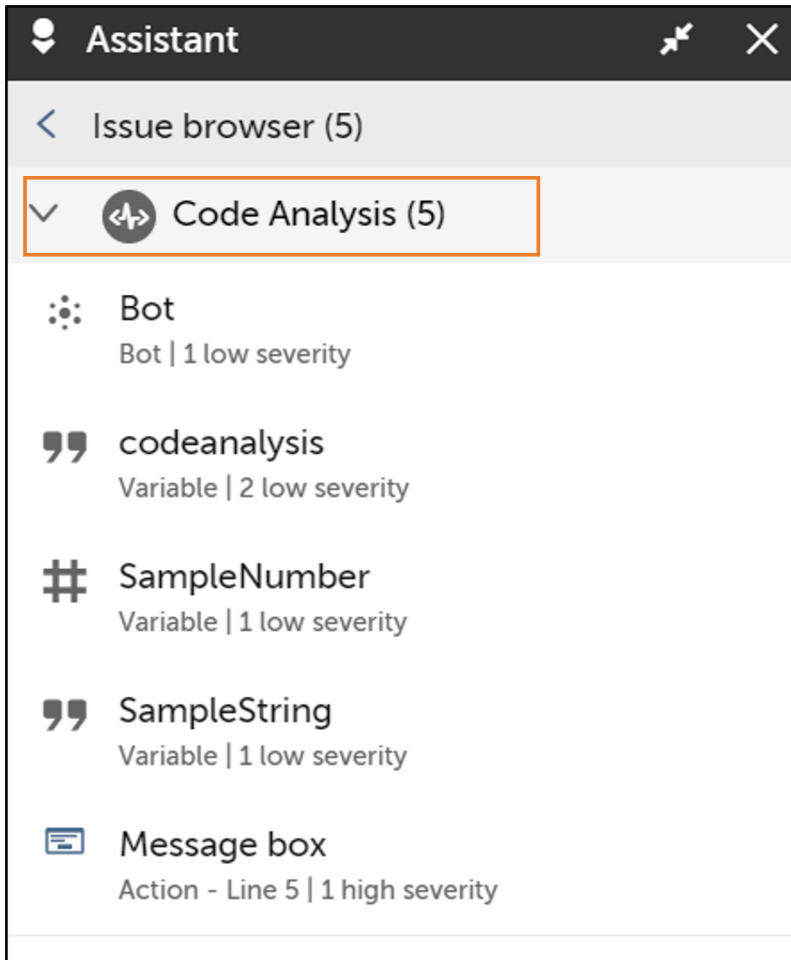

The code analysis results are displayed in the following order:

Attribute	Rules violated
Bot	<ul style="list-style-type: none"> • Mandatory header comment • Comment coverage • Action maximum
Variable	<ul style="list-style-type: none"> • Variable name pattern • Variable name length • No unused variables
Action	<ul style="list-style-type: none"> • No hard-coded delay • No hard-coded file path • No hard-coded email address • No empty catch • Mandatory catch logging • Mandatory catch screen capture

The code analysis header displays the count of objects with a violation error within the bot. Each object can have either low or high severity. The violation is displayed with the attribute followed by the line

number and the severity. All the high severity errors are displayed first. Navigate to the corresponding line in the bot that has the violation, rectify the violation, and save the bot.

You must save the bot to see the latest code analysis results in the Bot Assistant.

System-created variables

Variables created by the system such as input or output variables, package-suggested variables, or auto-generated variables (window variables) use the default variable naming case convention from code analysis or Pascal case if no format is defined in code analysis rule.

Audit log

When code analysis is initiated either by saving a bot or running code analysis in the Bot editor, the information is captured in the audit log. The following details are captured:

- Bot name
- User information
- The method through which code analysis is initiated (save option or run code analysis option)
- Time taken for the code analysis to run including details such as the number of code lines if captured by code analysis process
- Total number of violations
- Details of the violations

Code analysis reports

You can access the code analysis report from the **Automation** page after running code analysis. The report is in the form of a downloadable CSV file.

You must have **View content** permission to download the code analysis results in CSV format.

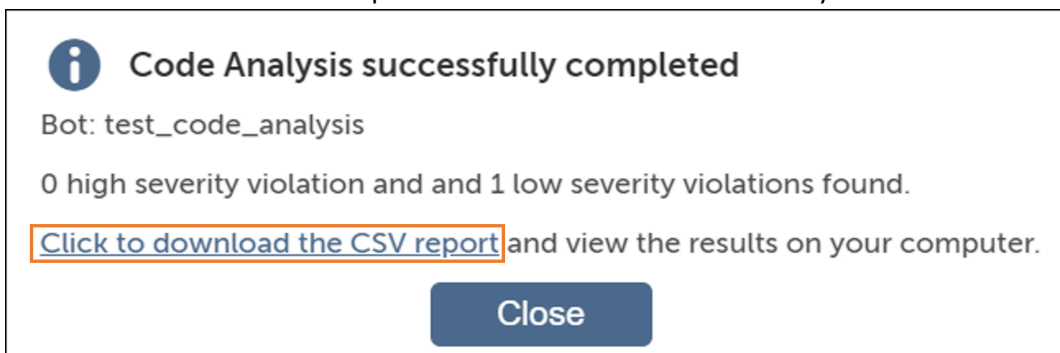

The image shows a notification box with a blue information icon on the left. The text inside the box reads: "Code Analysis successfully completed", "Bot: test_code_analysis", "0 high severity violation and and 1 low severity violations found.", and "Click to download the CSV report and view the results on your computer." The link "Click to download the CSV report" is highlighted with a red border. At the bottom center of the box is a blue button with the text "Close".

The report contains the results of the code analysis policy. It details the violation, the location of the violation, and the bot file location. The code analysis report consists of the following:

- Rule code
- Rule error message description (with location of bot file as appropriate)
- Location of the bot

The following image shows an example code analysis

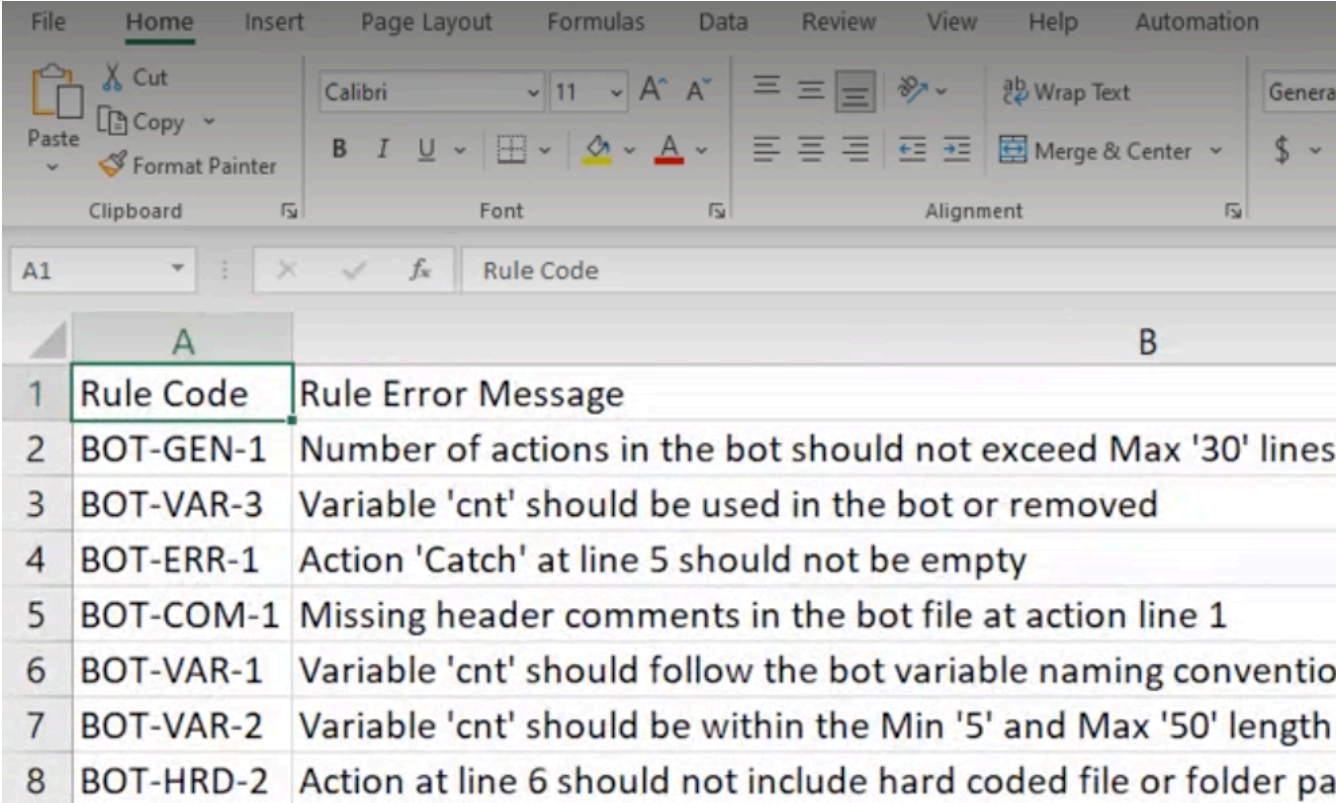

	A	B
1	Rule Code	Rule Error Message
2	BOT-GEN-1	Number of actions in the bot should not exceed Max '30' lines
3	BOT-VAR-3	Variable 'cnt' should be used in the bot or removed
4	BOT-ERR-1	Action 'Catch' at line 5 should not be empty
5	BOT-COM-1	Missing header comments in the bot file at action line 1
6	BOT-VAR-1	Variable 'cnt' should follow the bot variable naming convention
7	BOT-VAR-2	Variable 'cnt' should be within the Min '5' and Max '50' length
8	BOT-HRD-2	Action at line 6 should not include hard coded file or folder path

report:

Configure code analysis policy

As an administrator or a user with view and manage policy permissions, you can configure code analysis policies to define coding best practices to improve reliability of automations by reducing errors.

Ensure that you have the following permissions:

- View policies
- Manage policies

1. Log in to the Control Room as an administrator.
2. Navigate to **Administration > Policies**.
3. Click **Enabled** in the **Status** section.
By default, this feature is not enabled.
4. Set up one or more rules in the **Rules** section.

Note: You must set at least one rule to enable the code analysis feature.

5. Select the **Severity** as either **Low** or **High** to highlight the criticality of the rule.
After the policy is enabled, it is applied to all the users globally.

Whenever the policy is updated, a prompt is displayed indicating that the policy is updated, and the code analysis results page contains details about the bots that have violations.

The following video displays how to configure the code analysis policy: <https://aa2019packagesdkfordocumentation.s3-us-west-2.amazonaws.com/videos/configure-code-analysis.mp4>

Run code analysis

As a Bot Creator (RPA developer) or Citizen Developer, you can run code analysis to evaluate your bots for any coding errors. You can develop automations based on the code analysis policies and predefined rules.

You must have **View content** permission to download the code analysis results in CSV format.

- You can run code analysis only on bots that are error-free. If your bots contain errors, the **Run Code Analysis** option is not enabled. Resolve the errors in your bot to see the **Run Code Analysis** option.
- Code analysis automatically runs on all the bots with the **Not Scanned** status in the public workspace, thereby providing visibility on the coding best practices for all the bots in the public repository. Code analysis runs every five minutes and scans 1000 bot files in five minutes.
- Code analysis is not invoked on API bot files.
- **Run code analysis in the private workspace:**
 - a) On the **Automation** page, select the bot, click the actions menu (vertical ellipsis), and click **Run Code Analysis**.
A message is displayed indicating that code analysis is successfully completed, along with a file link with the result of the code analysis.
 - b) Click the file link to analyze the result of code analysis.
A CSV file with the result of code analysis is displayed.
 - c) Click **Close**.
- **Run code analysis in the public workspace:** Run code analysis by choosing one of the following options:

Option	Steps
Run Code Analysis	<ol style="list-style-type: none"> 1. On the Automation page, select the bot, click the actions menu (vertical ellipsis), and click Run Code Analysis. 2. Select the version of the bot for which to run code analysis: <ol style="list-style-type: none"> a. Latest version b. Product label 3. Click Continue. A message is displayed indicating that code analysis is successfully completed, along with a file link with the result of code analysis. 4. Click the file link to analyze the result of code analysis. A CSV file with the result of code analysis is displayed. 5. Click Close.

Option	Steps
View history Task Bot	<ol style="list-style-type: none"> <li data-bbox="766 214 1461 310">1. On the Automation page, select the bot, click the actions menu (vertical ellipsis), and click View history Task Bot. All the versions of the selected bot are displayed on top showing the latest version. <li data-bbox="766 407 1461 579">2. Select a version of the bot, click the actions menu (vertical ellipsis), and click Run Code Analysis. A message is displayed indicating that code analysis is successfully displayed, along with a file link with the result of code analysis. <li data-bbox="766 596 1461 672">3. Click the file link to analyze the result of code analysis. A CSV file with the result of code analysis is displayed. <li data-bbox="766 688 1461 718">4. Click Close.

The following video shows the two ways of running code analysis in the public workspace: <https://aa2019packagesdkfordocumentation.s3-us-west-2.amazonaws.com/videos/run-ca-public-workspace.mp4>

Manage licenses

The Automation Anywhere Control Room provides an automated mechanism for tracking the use of licensed software across multiple Control Room instances and share these permissions in real-time.

All licenses

Automation Anywhere Control Room administrators view, share, and manage user license entitlements across multiple Control Room instances from a single Control Room. Navigate to **Administration > License** to view a summary of product licenses followed by License Summary table.

Note:

To perform this task, you must be a administrator and have the required rights and permissions.

License Cloud services

To edit and or update the license settings, via the License Cloud service, **Click Edit license settings** and supply the necessary information on the **Edit** page.

For more information on this subject, see these resources:

- [Licenses and cloud services](#)
- [Managing Cloud and file licenses](#)
- [View and edit Cloud Control Room instances](#)

License summaries

The License Summary table details the status of all licenses deployed, or available to be deployed, across any active Control Room. The details displayed are from the point-of-view of the current Control Room to which you are logged into. This real-time access to license information from multiple deployments across the network enable a seamless integration for allocation of needed RPA resources as the need arises.

Updating licenses from a server

To add licenses for users, select the desired method of accessing the license by clicking **Install license from server** or **Install license from file**.

Installing additional licenses

Upload new licenses to the Automation Anywhere Control Room to be distributed to users as required.

Ensure that you are logged in to the as the administrator.

Designate the source of the license (server or filepath) to load into the Control Room. You may also take advantage of the License Cloud services from this page if enabled. Please see [Licenses and cloud services](#) for more information.

1. Navigate to **Administration > Licenses**.
2. Select **Install license from server** or **Install license from file** or **Edit license settings**.

Choose installation source.

Option	Action
Install license from server	<ol style="list-style-type: none"> a. Supply the unique Control Room GUID. b. Click Install license from server.
Install license from file	<ol style="list-style-type: none"> a. Browse to and select the license. b. Click Install license from file.
Edit license settings	<ol style="list-style-type: none"> a. Enter you unique GUID in the filed provided.

3. Click **Save changes**.

Related reference

[Users](#)

As an administrator, you can create, view, edit, delete, and enable or disable a user. Creating users steps vary depending on whether the user is a non-Active Directory, Active Directory, or single sign-on (SSO) user from an IdP server.

[System roles](#)

System roles are preconfigured with the permissions necessary to perform the tasks within the scope of that role. They cannot be modified or deleted. Administrators assign the roles to users to enable them to access features and perform operations in the Control Room.

[Settings](#)

Use the **Settings** tab to configure the connection to the Credential Vault, enable email notifications, integrate the Control Room with a Git repository, enable secure recording mode, and configure user authentication.

Stop and start Control Room services on Linux

Review the instructions and service names to stop and restart Automation Anywhere Control Room services on Linux.

Log in to your Automation Anywhere Control Room server.

1. If you just finished installing A2019, use the following command to display the status of all Control Room services:

```
sudo systemctl status control*
```

Browse through the output. If any of the services are not actively running, you can manually start the service with the following command (see the next step for specific service names):

```
sudo systemctl start <servicename>
```

Note: If more than one service is not running, you can use the script in the next step to start all the services.

For other Linux installation issues, contact Automation Anywhere support: [Open a support case \(A- People login required\)](#).

2. Optional: Create a script from the following code, such as `startallaae.sh`, to start all the Control Room services.

This sample script lists the Control Room services that need to be restarted. You can restart the services in any sequence.

The `sleep` commands allow each service to complete startup before the next service is started.

Note: `controlroomdiscoverybot.service` is only installed by default starting in Automation 360 version 16.

```
echo Starting elasticsearch
sudo systemctl start controlroomelasticsearch.service
sleep 30
echo Starting botcompiler
sudo systemctl start controlroombotcompiler.service
sleep 30
echo Starting control room caching
sudo systemctl start controlroomcaching.service
sleep 30
echo Starting backend service
sudo systemctl start controlroombackend.service
sleep 30
echo Starting reverse proxy
sudo systemctl start controlroomreverseproxy.service
sleep 30
echo Starting messaging
sudo systemctl start controlroommessaging.service
sleep 30
echo Starting iq bot
sudo systemctl start controlroomiqbot.service
sleep 30
echo Starting discovery bot
sudo systemctl start controlroomdiscoverybot.service
sleep 30
```

```

echo Starting aari
sudo systemctl start controlroomaari.service
sleep 30
echo Starting storage
sudo systemctl start controlroomstorage.service
sleep 30
echo Starting ml services
sudo systemctl start controlroomdiscoverybotml.service
sleep 30

```

Assign execute permission to the script and run it: `sudo ./startallaae.sh`

3. To stop a single service, use the following command: `sudo systemctl stop <servicename>`.

Optional: To stop all services for maintenance or other requirements, create a script, such as `stopallaae.sh`, to stop the Control Room services.

```

sudo systemctl stop controlroommessaging.service
sudo systemctl stop controlroomreverseproxy.service
sudo systemctl stop controlroombackend.service
sudo systemctl stop controlroomcaching.service
sudo systemctl stop controlroombotcompiler.service
sudo systemctl stop controlroomelasticsearch.service
sudo systemctl stop controlroomiqbot.service
sudo systemctl stop controlroomdiscoverybot.service

sudo systemctl stop controlroomaari.service
sudo systemctl stop controlroomstorage.service
sudo systemctl stop controlroomdiscoverybotml.service

```

Assign execute permissions to the script and run it: `sudo ./stopallaae.sh`

Control Room log files

Various types of information about the Control Room are captured in different log files. You can analyze these log files when the Control Room or a bot encounters an error and identify the root cause for that error.

Overview

The log files capture information about the errors encountered by various components of the Control Room such as the Bot Store, devices, and license. You can use the information in the log files to identify the root cause of an error and resolve that error.

Log file locations

The Control Room log files are available at `C:\ProgramData\AutomationAnywhere\Logs` on the machine on which you have installed the Control Room. The log files are named `WebCR_<COMPONENT-NAME>`, for example, `WebCR_BotStore`, `WebCR_Devices`, and `WebCR_License`.

You can refer the following log files for the Control Room.

WebCR.log

Contains log entries related to the initialization of the Control Room and messages, if any.

WebCR_UserManagement.log

Contains log entries related to the user management module.

WebCR_Ignite.log	Contains log entries related to the Apache Ignite or caching system.
WebCR_ServerRepository.log	Contains log entries of the server repository related functions.
WebCR_CredentialVault.log	Contains log entries of Credential Vault related function calls.
WebCR_Hibernate.log	Contains log entries related to the Hibernate system, ORM mapping and Query system, ActiveMQ messaging subsystem, and so on.

On the Bot Runner machine (on which the Bot Agent is installed), the log files are available at C:\ProgramData\AutomationAnywhere\BotRunner\Logs. You can refer the following log files for the Bot Runner machine.

NodeManager.log	Contains log entry details of the interaction with the Bot Agent and the log entry of every message sent to the Bot Agent.
BotLauncher.log	Contains log entry details of the bots that are deployed on this machine.
TriggerListener.log	Contains log entry details of any triggering activities that occur in bots with triggers.

The corresponding configuration XML files are available at C:\Program Files\Automation Anywhere\Bot Agent\config.

Workload management

The workload management module enables users to upload Microsoft Excel and CSV files to the Control Room so that it feeds the records from the files into the bot deployments.

These records contain highly sensitive information, for example, PII, PCI, PHI, and more. This data is carefully protected by the data encryption key and is at rest in the file share and database.

Divide your automations into small, logical Work Items from the **Workload** page. Process the Work Items simultaneously to ensure that your automation goals are achieved with optimum resource utilization.

Prerequisites

To manage your workload automation, ensure that you are allocated a combination of any or all of the following roles and permissions:

Feature type	Privileges
User roles	<ul style="list-style-type: none"> AAE_Queue_Admin AAE_Pool_Admin
Activity permissions	<ul style="list-style-type: none"> View my in progress activity View my scheduled bots Schedule my bots to run View and manage all scheduled activity from my folders

Feature type	Privileges
Device permissions	<ul style="list-style-type: none"> View and manage my Bot Creator, Bot Runner, and device pools Create device pools Administer all device pools
Bots permissions	<ul style="list-style-type: none"> View my bots Run my bots
Workload permissions	<ul style="list-style-type: none"> View and manage my queues Create queues Administer all queues

Database

Workload automations are supported on the following databases:

- SQL
- PostgreSQL
- Oracle

Other resources

Workflow map: Click the following schematic image to view this workload management workflow in an



interactive visual format:

1. [Workload management process](#)

Watch the following video on how to use the Workload feature in the Control Room:

Related tasks

[Attach work item template to TaskBot](#)

Attach a work item template to a TaskBot to use the TaskBot in workload automation.

[Use Work Item variables](#)

You can use the Work Item variables to pass the Work Item attributes or values to the TaskBot from the Control Room when you run the bot with the option **Run bot with queue**.

Related reference

[Workload package](#)

The Workload package enables you to insert work items in a queue for workload automation. It also enables data chaining between multiple queues. You can orchestrate multiple bots, and enable optimal device utilization through the queuing mechanism of workload management.

Create workload queues

A queue is one of the main building blocks of Workload Management. A queue holds data known as Work Items for further processing. The system distributes these Work Items to individual unattended Bot Runners in a device pool for processing.

For workload automation create and attach a work item template to a bot, create device pools, add Bot Runners to the pool, create queues, add queue owners, participants, or consumers, define the work item structure, insert work items, and finally run the automation with the queue.

Note: In a multi-user environment, if there are two queues A and B, and multiple work items are in queue A, the device will process work items in queue A first, and then move to queue B. To process both the queues in parallel in a multi-user environment, you must perform one of the following actions:

- Add another device to the existing device pool.
- Create another device pool on the same device.

See the following table for details of the tasks you can perform as a queue owner, participant, or consumer.

Owners	Participants	Consumers
<p>Can perform</p> <ul style="list-style-type: none"> • View the queue • Edit the queue • Add other owners, participants, or consumers to the queue • Add work items to the queue 	<p>Can perform</p> <ul style="list-style-type: none"> • View the queue • Add work items to the queue 	<p>Can perform</p> <ul style="list-style-type: none"> • View the queue • Run bot with queue
<p>Cannot perform: Run bot with queue</p>	<p>Cannot perform: Run bot with queue</p>	<p>Cannot perform: Add work items to the queue</p>

Queue owners and participants: Note that queue owners can edit a queue (change the queue name, description, add or remove owners, participants, or consumers), but participants cannot edit the queue.

You can create a workload queue in one of the following modes:

- [Express mode](#)
- [Standard mode](#)

Express mode

To create queues in express mode with default parameters for workload automation in the Control Room. For more information, see [Create express queues using default workload parameters](#).

Standard mode

The following diagram describes the flow in which you can create a workload queue in standard mode.

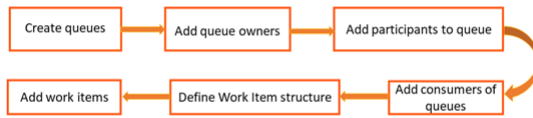

To create a workload queue in standard mode,

1. *Create queues*

Create queues that hold specific sets of data your bot is expecting for automation. To create queues, an Control Room administrator assigns the **AAE_Queue Admin** role with **View and manage my queues**, **Create queues**, **Administer all queues**, and **View my in progress activity** permissions.

2. *Add queue owners*

Add queue owners who can create, edit, and view queues.

3. *Add participants to queue*

Add queue participants from different roles defined in the Control Room. This is an optional step.

4. *Add consumers of queues*

Add queue consumers from different roles defined in the Control Room. This is an optional step.

5. *Define Work Item structure*

Define the Work Item structure for processing in a queue. This enables you to manually upload the Work Items from the system in the absence of ready data in a file.

6. *Insert Work Items*

Add Work Items from an Excel or CSV file to the queue after you define the structure.

Related tasks

[Run bot with queue](#)

Collectively process all work items of a queue across all the Bot Runners present in one or more device pools.

[Attach work item template to TaskBot](#)

Attach a work item template to a TaskBot to use the TaskBot in workload automation.

Create express queues

Create queues with default parameters for workload automation using the express queue option in the Control Room.

Ensure that you are logged in to the as the administrator.

You must have the **Create queues** permission to create queues using the express mode.

When you create a queue with default parameters, note the following:

- All .CSV file columns will be available in a workload bot.
- The first 10 columns of the .CSV file will be displayed in the queue.
- All data type will be text.

- Queue sorting will not be available.
1. Navigate to **Manage > Queues**.
 2. To create queues with default workload parameters, click **Create express queue**.
 3. Enter the queue name.
The queue name is the same as the workitem template name by default.
 4. Optional: Enter the queue description.
 5. To select a data file in `.csv` format, click **Browse**.
 6. Click **Create**.
The queue is saved and available for workload automation in the **Queues** list.
You can now view queue details, edit a queue, and run a bot with queue.

Related tasks

[View queue details](#)

Use the **View queues details** page to view the details of a particular queue.

[Edit queues](#)

Edit a queue using two methods - from the **Queues** list, or from the **View queue** page.

[Run bot with queue](#)

Collectively process all work items of a queue across all the Bot Runners present in one or more device pools.

Create queues

Create queues that hold specific sets of data your bot is expecting for automation. To create queues, an Control Room administrator assigns the **AAE_Queue Admin** role with **View and manage my queues**, **Create queues**, **Administer all queues**, and **View my in progress activity** permissions.

Ensure that you are logged in to the as the administrator.

A queue is processed until all work items are completed. When new work items are added to the queue, the Reactivation Threshold value specifies the minimum number of new work items required to resume queue processing. Work items are those items with a **Ready to Run** status.

Create a queue by providing details such as the queue name, queue owners, participants, consumers, work item structure, and auto-retry for failed work items.

Note: You can choose to **Create draft of queue** and add the remaining information later.

1. Navigate to **Manage > Queues**.
2. Click **Create queue**.
3. Enter the **Name**.
4. Optional: Enter a description.
5. Set the **Reactivation Threshold** to resume queue processing.
Default threshold is **1** (one).
6. Optional: Select the average **Time required for a person to complete one work item:**
 - **seconds**
 - **minutes**
 - **hours**
 - **days**

7. To process the failed work items, specify the **Max auto retry attempt**.

The failed work items are processed for the specified number of times after all the work items in a queue are processed.

The default value of **Max auto retry attempt** is 0 which means the auto retry is not attempted by default. The maximum **Max auto retry attempt** value is 10.

Note: The failed work items are processed at the end of the staging queue for auto retry.

Based on the specified **Max auto retry attempt** number, the **Queues** page shows the remaining auto-retry attempts in the **Retries left** column.

8. Click **Next**.*Add queue owners***Related tasks***Edit queues*

Edit a queue using two methods - from the **Queues** list, or from the **View queue** page.

Delete queues

Delete a selected queue, multiple selected queues, or all queues of work items.

Add queue owners

Add queue owners who can create, edit, and view queues.

Ensure that you are logged in to the as the administrator.

Queue owners are allowed to edit the queue and add new work items to the queue.

The queue creator is the default queue owner and is able to add other Control Room users as queue owners, if required.

- 1.** Select user(s) from the **Available Users** list from the **Owners** tab.
- 2.** Click the right arrow (→) to add your selection.
- 3.** Click **Next**.

Add queue participants

Add participants to queue

Add queue participants from different roles defined in the Control Room. This is an optional step.

Ensure that you are logged in to the as the administrator.

Participant roles can add new work items and view the queue. However, they are not allowed to edit other queue properties.

- 1.** Select role(s) from the **Available Roles** list from the **Participants** tab.
- 2.** Click the right arrow (→) to add your selection.
- 3.** Click **Next**.

Add consumers of queues

Add consumers of queues

Add queue consumers from different roles defined in the Control Room. This is an optional step.

Ensure that you are logged in to the as the administrator.

There are certain mandatory checks that are to be done for unattended bots to be deployed from Control Room to a device:

- The device where the bot is to be deployed should be set as a default device to only the specific bot runner account.
- Ensure that all necessary privileges have been granted to the Bot Runner.
- Ensure that nobody is signed into the device at the time of bot deployment with the Run As permission from a different device.
- Ensure that the console is currently inactive on default device.

Queue consumers can view the queue and all the work items in the queue. In addition, they can use this queue for running bots on Unattended Bot Runners.

1. Select role(s) from the **Available Roles** list from the **Consumers** tab.
2. Click the right arrow (→) to add your selection.
3. Click **Next**.

Define Work Item structure

Define Work Item structure

Define the Work Item structure for processing in a queue. This enables you to manually upload the Work Items from the system in the absence of ready data in a file.

Define a Work Item structure using any one of the following methods:

1. Using an Excel/CSV file.
2. Using an existing work item template.

3. Manually

Remember: The work flow to process Work Items differs for a queue based on the method that you choose in the **Define Work Item Structure** tab.

1. Select a method to add header columns for Work Item processing:

- **Use an Excel/CSV file:** Add the header columns from an existing Excel or CSV file. *You can point to the Excel spreadsheet or CSV file you are using in one or more TaskBots you will run in this queue.*

a. Enter a unique name for the Work Item structure in the **Work item template** field.

For example, if the queue contains employee information, you can specify the **Work item template** as Employee Data.

b. Select a column for inclusion in the Work Item structure from the list of column names. The columns are defined based on the header rows of the selected Excel or CSV file. A maximum of ten (10) columns are allowed for selection and viewing in the Control Room.

For example, you can select column headers Employee Name, Employee ID, and Designation. You can then select the **Data Type - Text, Number, or Date** for that column. You can also choose to view these columns being processed in the **Activity** page.

Note:

- The system allows you to filter/sort Work Items on the columns for viewing the Work Item data in the Control Room.

Actions allowed on view queue page

- When you upload work items from an xls or xlsx file with data type as text, the Excel file column populated with a date in any format (for example, 8/6/2019) is converted to its corresponding workload management date format (for example, Sat Jun 08 00:00:00) in the Control Room Work Item. However, the same is not applicable to a csv file.

c. Select up to three columns for sorting in an ascending or descending order.

When the system processes the Work Items from the queue, it uses the sort criteria specified to retrieve the work items in that order. For example, to process paylips with first Employee

ID followed by Employee Name from 1 to n and A to Z, specify Employee ID and Employee Name in an ascending order.

Note: Work items are processed on sorting order internally. For example, if you add 3 work items **a, c, b** to be sorted by name, then on the user interface they will be shown as **a, c, b**. However, the work items will be processed as per the sorting order **a, b, c**.

- **Use work item template:** Add header columns by searching for an **Existing work item template** or from the **Available work item templates**.

This allows you to pass the values or attributes from the template to a TaskBot with the help of Work Item variables when you use the option **Run bot with queue**.

Tip: Search for an existing Work Item template when there are a large number of templates available for selection.

Use Work Item variables

- **Manually:** Define the Work Item structure manually. You do not have to select from an existing structure.
 - a. Type a name for the Work Item structure in the **Work item template** field.
For example, if the queue contains employee information, add the **Work item template** as Employee Data.
 - b. Add column header names for the Work Item and select the data type for each column: **Text**, **Number**, or **Date**
 - c. Select the display and sorting for the columns in the Control Room.
When the system processes the Work Items from the queue, it uses the sort criteria specified to retrieve the work items in that order. For example, to process payslips with first Employee ID followed by Employee Name from 1 to n and A to Z, specify Employee ID and Employee Name in an ascending order.

2. Click **Next** to add the Work Items.

Insert Work Items

Related reference

[Work item status and actions](#)

Based on the Work Item status, you can do only certain actions on a Work Item.

Insert Work Items

Add Work Items from an Excel or CSV file to the queue after you define the structure.

Ensure that you are logged in to the as the administrator.

Add Work Items from an Excel or CSV file to the queue.

Note: When you upload work items from an xls or xlsx file with data type as text, the Excel file column populated with a date in any format (for example, 8/6/2019) is converted to its corresponding workload management date format (for example, Sat Jun 08 00:00:00) in the Control Room Work Item. However, the same is not applicable to a CSV file.

You can also add Work Items later by editing the queue, see [Edit queues](#).

1. Click **Browse**.

2. Select the Excel or CSV file.
3. Optional: Select the **Disallow duplicates** check box.

Note:

- Only unique work items from the CSV file are added. If the CSV file contains any duplicate work items, then the entire CSV file is ignored.
- This option is available only when you create a new queue.

Create queue Cancel

General ✔

Name

- test

Threshold

- 1 work item(s)

Time it takes

- --

Owners ✔

- 1 user selected

Participants ✔

(optional)

- 1 role selected

Consumers ✔

(optional)

- 1 role selected

Define work item structure ✔

Get column headers from:

- Loan-Q

Work items structure ✔

Work item template

- Loan-Q
- 6 columns

Add work items ✔

(optional)

Do you want to add work items now?

This is an optional step. You can add an Excel/CSV file (with headers) with work items now or later.

Choose an Excel/CSV file

Select a file...
Browse...

Disallow duplicates

4. Click **Create queue**.

- Now that you have created a queue, it is now ready for deployment from a bot.

Run bot with queue

- Manage Work Items of a queue to fix the discrepancies before queue processing and reduce your automation-related errors.

Manage Work Items

Run bot with queue

Collectively process all work items of a queue across all the Bot Runners present in one or more device pools.

To run a bot with queue, ensure that you are allocated a combination of any or all of the following roles and permissions:

Feature type	Privileges
User roles	<ul style="list-style-type: none"> • AAE_Queue_Admin • AAE_Pool_Admin
Activity permissions	<ul style="list-style-type: none"> • View my in progress activity • View my scheduled bots • Schedule my bots to run • View and manage all scheduled activity from my folders
Device permissions	<ul style="list-style-type: none"> • View and manage my Bot Creator, Bot Runner, and device pools • Create device pools • Administer all device pools
Bots permissions	<ul style="list-style-type: none"> • View my bots • Run my bots
Workload permissions	<ul style="list-style-type: none"> • View and manage my queues • Create queues • Administer all queues

To **Run bot with queue**, note the following:

- You can run bots only on unattended Bot Runners. You cannot run bots on attended Bot Runners from the Control Room.
- The bots have to be checked in to the public folder in order for the bots to qualify to be run with queue.
- Work item sorting is done on the batch added to the queue. For example, if you add 2 batches of work items **a, c, b** and **a, c, b** to be sorted by name, the work items will be processed for queuing as **a, b, c** and **a, b, c**.

- If you use the same device pool for inserting and processing work items for the same queue, you will see duplicate entries in the **In-progress activity** and **Historical** page. To resolve this issue, use one device pool to insert work items and a different device pool to process work items in a queue.

Use the **Run a bot with queue** option from any of the following pages:

- Activity > In progress**
- Manage > Scheduled**
- Manage > Devices**
- Manage > Device pools**
- Manage > Queues**

The procedure for running a bot with a queue is the same in all these pages.

1. Select the bot to run with queue.
 - Latest version: Click **Latest version** tab to select the latest version of the bot.
 - Labeled version: Click **Production version** tab to select the labeled version of the bot.

Available bots are displayed along with any **Input values** and dependencies. If the production label option is selected for the parent bot, the corresponding dependent bots with the production label are also automatically selected. If any of the dependent bots do not have the production label applied, the latest version of the bot is selected.

2. Optional: Select **Run with administrative privileges** if the bot has actions that require administrative privileges to run.
3. Select a queue with which to run the bot.

Note: Ensure the following to see the list of available queues:

- You do not have the AAE_Admin role
- Your role is added to **Queue > Consumers**
- The bot and queue work item templates are identical

-
4. Optional: Set the queue running time.
 - a) Click **Add running time** in the **Processing time** tab.
 - b) Select the days from **Days of the week** field.
 - c) Enter the **Start time** and **End time**.
 - d) Click **Add time** to add another time period for the days selected.
You can add up to three time periods which cannot overlap with each other.
 - e) Click **Add running time** to add another running time and provide the day and time details.
You can add up to three running times. If the running time is not set, the queue runs for 24 hours.
 - f) Optional: Click **Remove running time** to delete any running time.
 5. Select the Bot Runner user from the **Available bot runners** list.
To enable a device, it must be connected to the Control Room.

Note: If a device does not appear in the list, ensure the user running the bots is assigned a role that provides access to the appropriate Run-As Users.

6. Optional: Select the option to run on bot running devices.

If you want to select Bot Runners that are mapped one-on-one with their default (single-user) devices, select the **Run on bot running devices** option. This option enables the Work Items to be deployed only to the user's default device, whereby the security policy does not allow a user to log in to any other device or when applications for automation are installed on the default device.

If you select this option, ensure that all the default devices are part of the same device pool when you select from the **Device Pool** tab.

Tip: Do not select this option if the run as users (Bot Runners) are configured to use multiple devices. In that configuration, if any device in the pool is processing an automation, the run as user can log in to another device, and the work items will be processed on that device. This enables optimal utilization of licenses (run as user) and devices.

For information on scenarios for choosing bot running devices for run as users, see [Considerations for running a bot](#).

7. Select Device pools.

Select the pool from the list of available device pools.

8. Optional: Click the up or down arrow to set the selected device pools in preferred order.

When a is deployed, the selects the first available device based on the order in which you organized the device pools. If none of the devices are available at the time of deployment, the is queued.

9. Select the Automation priority from the General tab.

Set the priority to high, medium, or low based on your requirements for resource optimization. The default permission is set to medium.

10. Click Run bot with queue.

Note: If a user who created the WLM automation using the **Run bot with queue** option is deleted, the automation is also affected and queues cannot be processed.

The following video demonstrates how to run a bot with queue.

<https://aa2019packagesdkfordocumentation.s3-us-west-2.amazonaws.com/videos/run-bot-with-queues-specific-time.mp4>

Related tasks

[View automation of a queue](#)

Use the **View activity in progress** page to view the automation details of the selected queue, **Pause**, **Resume**, or **Stop** the in-progress automation.

Related reference

[Concurrent bot deployments and executions](#)

Review the information on the maximum number of concurrent bot deployments and executions for On-Premises deployment.

Add TaskBots and dependent files

Add a TaskBot, and review the input values and dependent files for the automation.

1. Navigate to Activity > Scheduled, Bots > My Bots, or Workload > Queues page.**2. Click Run bot with queue**

The **Activity > Run bot with queues Create** page is displayed.

3. Enter a name for the automation.**4. Optional: Enter a description.**

For example, you can describe the purpose of running the TaskBot with a queue.

5. Go to the folder that contains the required TaskBot.
6. Select a TaskBot to process in the queue from the list.
 - Latest version: Click **Latest version** tab to select the latest version of the bot.
 - Labeled version: Click **Production version** tab to select the labeled version of the bot.

By default, the Bots folder is selected.

Tip: Use the search field to find a TaskBot quickly.

The **Input values** and **Dependencies** options are displayed at the bottom of the page.

If the production label option is selected for the parent bot, the corresponding dependent bots with the production label are also automatically selected. If any of the dependent bots do not have the production label applied, the latest version of the bot is selected.

7. Optional: Select the **Input values** check box to add the values of variables to the bot during runtime. This is enabled only if the selected TaskBot has **Input values**.

Note: In workload automation, input to the bot is provided by the workload queue, the input type variable is not supported in workload automation.

8. Optional: Review the list of dependent files, if available. This list is enabled only if the selected TaskBot has dependencies. The TaskBot dependencies that are uploaded in the Control Room are available only for review.
9. Click **Next** to add a queue, Bot Runner and device pool.

Add queue, Bot Runner, and device pool

If the selected TaskBot does not contain a work item template, an error message appears at the top of the page. The TaskBot also shows an icon to indicate a missing work item template.

Define Work Item structure

Related reference

[Bot dependencies](#)

Bots dependencies are files and other bots that are required to run that bot successfully.

Add queue, Bot Runner, and device pool

Add a queue, Bot Runner, and device pool to the automation from the **Run bot with queue** page.

Ensure that you are logged in to the as the administrator.

Automation processes are queued until the specified **Run as user** and devices become available. Queuing permits other automation processes for that specific **Run as user** until the specified device becomes available. Any **In use** queues are shown as disabled in the **Available queues** list.

You can deploy the automation on the number of users that you choose with the **Run as** option and not on the total number of devices available in a device pool. Select only those queues that are not in use.

Note: You cannot use multiple queues to add Bot Runners.

1. Select a **Queue** from the **Queues** list. The queues for which you have consumer access and same work item template as the selected bot are listed.
2. Click **Next**.

3. In the **Run as** tab, from the **Available bot runners** list, select a **Bot Runner**.

a) Optional: Select the **Run on bot running devices** option.

If you want to select Bot Runners that are mapped one-on-one to their default (single-user) devices, select the **Run on bot running devices** option. This option enables the Work Items to be deployed only to the user's default device, whereby the security policy does not allow a user to log in to any other device or when applications for automation are installed on the default device.

If you select this option, ensure that all the default devices are part of the same device pool when you select from the **Device Pool** tab in Step 5.

Tip: Do not select this option if the run as users (Bot Runners) are configured to use multiple devices. In that configuration, if any device in the pool is processing an automation, the run as user can log in to another device, and the work items will be processed on that device. This enables optimal utilization of licenses (run as user) and devices.

For information on scenarios for choosing bot running devices for run as users, see [Considerations for running a bot](#).

4. Click **Next**.

5. In the **Device pool** tab, select a **Device Pool** from the **Available device pools** list.

6. Click **Add**.

The queue and device pool are added to the run bot with the queue list.

7. Optional: Click **Remove** to replace the queue or the device.

8. Click **Run bot with queue**.

The queue status changes to `In use` on the **Queues** page.

Related concepts

[Considerations for running a bot](#)

There are certain considerations you have to keep in mind when running a bot.

Manage workload queues

For workload maintenance tasks such as view the details of queues to pause, stop, or resume its automation, edit the queues, manage the work items in the queue, and delete the queues.

Note: In a multi-user environment, if there are two queues A and B, and multiple work items are in queue A, the device will process work items in queue A first, and then move to queue B. To process both the queues in parallel in a multi-user environment, you must perform one of the following actions:

- Add another device to the existing device pool.
 - Create another device pool on the same device.
-

Workload maintenance tasks

For workload automation maintenance, do the following (in any order):

[View queue details](#)

Use the **View queues details** page to view the details of a particular queue.

[Edit queues](#)

Edit a queue using two methods - from the **Queues** list, or from the **View queue** page.

Delete queues

Delete a selected queue, multiple selected queues, or all queues of work items.

Manage Work Items

Manage Work Items of a queue to fix the discrepancies before queue processing and reduce your automation-related errors.

Related reference[Actions allowed on view queue page](#)

Use different actions such as sorting, searching, or filtering on the table view of the queues.

View queue details

Use the **View queues details** page to view the details of a particular queue.

Ensure that you are logged in to the as the administrator.

Permissions required:

1. **Queue Owner** or **Queue Participant** or **Consumer** rights
2. **View and manage my Queues** feature permission
3. A user with **AAE_Admin** role can view all the queues and manage (pause, resume, and stop) all the WLM automations.

Note: If you are not an owner, participant, or consumer of that queue, you can view only queue names and not the queue details.

The **View queues** page shows the following queue details:

- **New** when the work item is added to the queue recently.
- **On hold** when the work item is deferred from processing by a Queue owner, participant, or consumer.
- **Failed** when the work item processing failed on an unattended bot.
- **Completed** when the work item is successfully processed by a Bot Runner or marked Completed by a queue owner, participant or consumer.
- **Data error** when there is an error in loading data from the file.
- **Active** when the work item is currently being processed or staged for processing.
- **Ready to run** when the work item is successfully processed for execution does not have any data errors and can be staged for processing.

Queue contents in different tabs such as:

1. **Work Items:** This is the default view. This allows you to view all work items in a tabulated form. You can use the filter to view specific work items. For example, all work items with status as **Completed**. You can **View, Edit,** or **Delete** the individual work items in each row. You can also change the status of the work items in bulk. For example, change the status of all the work items in **Data error** to **On hold**.
2. **General:** View the **Reactivation Threshold** and **Time** required to complete one work item.
3. **Owners:** View the user names of queue owners who can edit the queue and add new work items.
4. **Participants:** View the user names of queue participants who can add new work items and view the queue.
5. **Consumers:** View the user names of consumers who can view the queue and all the work items in the queue. In addition, they can use this queue when running bots.

6. Work Item Structure: View the work item structure that you defined when creating the queue.

Tip: Edit any of these details by either clicking the **edit this queue** link or the **Edit** button. Also, delete the queue by clicking the **Delete** button.

1. Navigate to **Manage > Queues**.
2. Hover over the **Actions** icon for the queue.
3. Click **View**.

[View automation of a queue](#)

Related concepts

[Manage Work Items](#)

Manage Work Items of a queue to fix the discrepancies before queue processing and reduce your automation-related errors.

Related tasks

[Create queues](#)

Create queues that hold specific sets of data your bot is expecting for automation. To create queues, an Control Room administrator assigns the **AAE_Queue Admin** role with **View and manage my queues**, **Create queues**, **Administer all queues**, and **View my in progress activity** permissions.

[Edit queues](#)

Edit a queue using two methods - from the **Queues** list, or from the **View queue** page.

[Delete queues](#)

Delete a selected queue, multiple selected queues, or all queues of work items.

Related reference

[Actions allowed on view queue page](#)

Use different actions such as sorting, searching, or filtering on the table view of the queues.

Edit queues

Edit a queue using two methods - from the **Queues** list, or from the **View queue** page.

Ensure that you are logged in to the as the administrator.

Permissions required:

1. **AAE_Queue Admin** role.
2. **Queue Owner** rights to edit queues that you created.
3. **Queue Participant** rights to edit queues that are created by other queue owners.

You are allowed to edit a work item only if it is in **New**, **Data error**, **On hold**, **Ready to run**, or **Failed** state.

Edit a queue from the **View queue** page or from the **Queues** list.

1. Navigate to **Manage > Queues**.
2. Hover over the **Actions** icon for the queue.
3. Click the **Edit** icon. (✎)
4. Click one of the following options to launch the **Edit Queue** page.
 - **edit this queue** link.
 - **Edit** button.

5. Edit the queue details, such as queue name (applicable only if in draft), description, work items, threshold and time values, auto retry attempt (applicable only if queue is not in use), owners, participants, and consumers.
-

Note:

- The Work Item structure cannot be edited after it is defined.
 - When you edit a queue and set new auto retry number, the new number is only applicable to the new failed work items. If the queue owner changes the auto retry attempt value to a number less than the existing number, the work item will not be retried.
 - The queue name must be unique and not be shared by another queue.
-

6. Upload a file for the work item that will be used for processing in this queue.
The **Work Items** tab is shown by default.
-

Tip: You can search for a work item quickly based either on **Status** or **Status details** using the search option.

7. Click **Browse**.
 8. Select the file to upload.
-

Note: You can upload only an Excel or CSV file.

9. Optional: Put work items on hold.

a) Select the work items and click **On hold** from the table level icons list.

Work items

Automation name: N/A Bot name: N/A Device pool: N/A

Time filter: Custom

Start date (IST +05:30): 11-18-2022 Start time: 12:00 am End date (IST +05:30): 11-25-2022

Status: Choose

Work items (1996 of 1996) 2 checked

	S. ↑	Id	Invoice Id	Customer Name	Amount	ema
<input type="checkbox"/>		6205	--	Murali7	1111116	sgras
<input checked="" type="checkbox"/>		6206	--	Murali8	1111117	sgras
<input checked="" type="checkbox"/>		6207	--	Murali9	1111118	sgras
<input type="checkbox"/>		6208	--	Murali10	1111119	sgras

b) In the **To update** screen, select one of the following options:

- **Indefinitely:** The work item is put on hold until you manually move it for re-processing.
- **Until:** The work item is put on hold until the specified date and time. Enter the **Date**, **Time**, and **Time zone** in their respective fields.

- c) Click **Yes, change**.
The selected work items are put on hold.

Note: The column **On hold until** in the **Edit queue** page displays the work item hold status (indefinitely or specific date and time). The status of the work items which are not on hold are shown as **N/A**.

- 10.** Click **Save changes**.
11. Edit the name and save the changes made to the queue.
An edit successful message appears.

Related concepts

[Manage Work Items](#)

Manage Work Items of a queue to fix the discrepancies before queue processing and reduce your automation-related errors.

Related tasks

[Create queues](#)

Create queues that hold specific sets of data your bot is expecting for automation. To create queues, an Control Room administrator assigns the **AAE_Queue Admin** role with **View and manage my queues**, **Create queues**, **Administer all queues**, and **View my in progress activity** permissions.

Related reference

[Actions allowed on view queue page](#)

Use different actions such as sorting, searching, or filtering on the table view of the queues.

Delete queues

Delete a selected queue, multiple selected queues, or all queues of work items.

You must have the following rights and permissions to complete the task. Ensure you are logged in to the Control Room as the administrator. To complete the task, you must have **AAE_Queue Admin** role and **Queue Owner** permission assigned to you.

Note: You cannot delete a queue if it is being used for processing a work item. An error message appears for that particular queue.

1. Log in to the Control Room.
2. Go to **Manage** → **Queues**.
3. Use one of the following options to delete selected or multiple queues:

Option	Steps
Delete selected queue	<ol style="list-style-type: none"> a. Hover over a queue to delete. b. Click the Actions menu. c. Click the Delete button. A confirmation message to permanently delete the queue appears. d. Click Yes, delete to confirm or No, cancel to discard the action. A confirmation message appears after you delete the queue.
Delete multiple selected or all queues	<ol style="list-style-type: none"> a. Select the check box of required queues or select the check box given in the header to select all queues. b. Click the Delete button above the header. A confirmation message to permanently delete multiple queues appear. c. Click Yes, delete to confirm or No, cancel to discard the action. A confirmation message appears after you delete the queue.

Related tasks

[View queue details](#)

Use the **View queues details** page to view the details of a particular queue.

[View automation of a queue](#)

Use the **View activity in progress** page to view the automation details of the selected queue, **Pause**, **Resume**, or **Stop** the in-progress automation.

[Edit queues](#)

Edit a queue using two methods - from the **Queues** list, or from the **View queue** page.

Actions allowed on view queue page

Use different actions such as sorting, searching, or filtering on the table view of the queues.

Searching and filtering

For ease of access, apply search parameters to **ID**, **Start Time**, **Work item result**, **Status**, and **Queue Name** columns.

- Specify the search parameters in the search bar for **Queue Name**. When you specify search parameters for the same column, the system searches using **OR** operator. When you specify search parameters for different columns, the system searches using **AND** operator.
- Choose the search parameters from a list in the search bar for Work Item **Status**.
- Apply filters to **Work Item Result** to quickly track the final status of the work item. For example if the work item was completed or skipped.
- Use the **Work Item ID** to search for specific work items and combine with the **Start Time** to monitor the progress of the work items that you search based on the **ID**. The **Start Time** filters the list of all work items that start between two given **Start Date** and **Start Time**. For example, all work items started between 01/08/2021 13:00 hrs. and 31/08/2021 15:00 hrs.

Note: Use a hyphen (-) as separator between IDs as any other symbol gives an error. For example, 100-250.

Table items

The following describes the list of items that can be viewed in the table:

Table Item	Description
ID	Shows the system generated id for a work item. When a work item is added to a queue, system generates an id for that work item.
Status	Shows Work item status: Use the View queues details page to view the details of a particular queue.
Start Time and End Time	Shows the work item's processing start/end time and date.
Modified by	Shows the name of the last user who had modified the work item.
Last Modified	Shows the time and date when the work item was modified last.

Note: Apart from the above system generated columns, the fields that you define in your work item are also displayed as columns.

Actions on table column

Use the following actions on a table column:

- Click a column to sort it in ascending and descending order. You can sort up to three columns by holding the Shift key when you click two more columns. This gives you the option of sorting two additional columns. This way the sorting is done on the entire table and not just the data that is currently visible to you. The last sorting is stored in memory applied by a user per session.
- Drag a column to the left or right
- Move your mouse cursor at the end of the column and drag to re-size

Actions on work items

Use the following tasks on specific work items:

Table Item	Description
Refresh	Allows you to refresh the table contents so that you can view the latest work item status
Delete	Allows you to delete one or multiple work items.
Mark complete	Allows you to mark one or more work items as Complete whose status is On hold, Data Error, or Ready to run.
New	Allows you to mark one or more work items as New whose status is On hold, or Data Error
On hold	Allows you to mark one or more work items as On hold whose status is New
Customize columns	Allows you to show or hide specific columns. By default, all columns are displayed including the ones defined in the work item.

Alternately, select work items and use the following actions. Note that these actions can be performed only at a table level and not on individual work items.

Table Item	Description
View	Allows you to view details of selected work item.
Edit	Allows you to edit details of selected work item. You can see this icon only if you are the Queue Owner or Participant or Consumer and the status of the work item is Unsuccessful, On hold, or Data error
Delete	Allows you to delete the selected work item. Note that if a work item is in Active state, you are not allowed to delete it.

Related tasks

[Define Work Item structure](#)

Define the Work Item structure for processing in a queue. This enables you to manually upload the Work Items from the system in the absence of ready data in a file.

View automation of a queue

Use the **View activity in progress** page to view the automation details of the selected queue, **Pause**, **Resume**, or **Stop** the in-progress automation.

You must have the following rights and permissions to complete the task. Ensure you are logged in to the Control Room as the administrator. To complete the task, you must have the following permissions assigned to you:

- **AAE_Queue Admin** role
- **Queue Consumer** or **Queue Participant** rights
- **Manage everyone's In progress activity** feature permission
- **View and manage all scheduled activity from my folders** activity permission (if you have access to the folder which has the WLM bot)
- **View and manage all scheduled activity** permission (if you do not have access to the folder which has the WLM bot)

Note:

- Though the **View automation** page is accessible from the **Workload** module, the page is launched from the **Activity** module.
- You cannot **Pause/Resume** or **Stop** actions directly from the **Activity > In progress** page. For these actions, the **Manage > Queues > View automation** action is used.

-
1. Log in to the Control Room.
 2. Go to **Manage** → **Queues**.
 3. Hover over a queue with status **In use**.
 4. Click the Actions menu (vertical ellipsis) and select **View automation**. This launches the **Activity > Run bot with queue > View** page.
 5. Choose one of the following options to view automation of a queue:

Options	Description
Automation details of the queue	<ul style="list-style-type: none"> • The Bot name, path, dependencies, and if it requires administrative privileges to run in the Task Bot tab. • The Queue used to run the automation in the Queue tab. • Bot Runner details such as username, device, and user status in the Run as tab. • Details of the device pool in use to run the automation in the Device pool tab. • Details such as number of work items that were active, failed, pending, or completed processing in the Run history tab.

Options	Description
Pause	<p>The system pauses the distribution of work items from this queue to available bot runners in the device pool.</p> <hr/> <p>Note: Until you resume this automation, any work items with Ready to Run status from this queue are not sent for processing.</p> <hr/>
Resume	The system starts distributing the work items from this queue.
Stop	<ul style="list-style-type: none"> The system stops distributing the work items from the queue associated with this automation. Select No, cancel to return to the details page or Yes, stop to stop the work item processing and return to the Queues page.

[Edit queues](#)

Related tasks

[View queue details](#)

Use the **View queues details** page to view the details of a particular queue.

[Delete queues](#)

Delete a selected queue, multiple selected queues, or all queues of work items.

Export queues

Export queues for flexible usage that ensures efficient processing of WLM automations. With export queues feature, you can reuse queues across environments such as Dev, QA, and production.

- You must have the **AAE_Queue_Admin** role to export queues.
- Ensure that the target Control Room user has create users, create roles, and install license permissions.
- The source and target Control Room instances must be running the same version.
- The source and target Control Room instances must be of same setup type: SSO with SSO, AD with AD, and non-AD with non-AD.
- To receive an email notification on successful export of a queue, ensure that the following notification is selected in **Administration > Settings > Email: A BLM package is exported or imported, to the user who performed BLM export or import**.

For more information see [Edit email notifications](#).

When exporting a queue, consider the following factors:

- You can export only the queues that are in the *Not in use* state. The queues in the *New* or *Draft* state cannot be exported.
- Before you export a queue, you must pause all the running WLM automations or queues.
- All the queue entities associated with the queue, for example, general settings, owners, participants, consumers, Work Item structure, and optionally Work Items are exported to your Control Room.

To export a queue, perform the following steps:

1. Navigate to **Manage > Queues**.

2. Select the required queue and click **Export queues**.
3. In the **Export queues** page, select a queue that you want to export, click the right arrow (→), and then click **Next**.

You can select the **Include work items** option to export work items along with the queues. By default, the **Include work items** option is not selected.

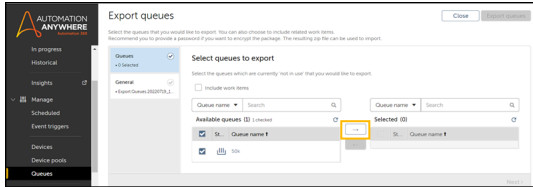

Note: When you export a queue along with a large number of work items, the export or import process might take time up to 30 minutes.

4. In the **General** section on the left pane, perform the following steps:
 - a) Required: Specify an **Export name** for the queue that you want to export.
 - b) Optional: Specify a password for the exported queue.
If you specify a password, confirm the password in the **Confirm password** field.

5. Click **Export queues**.

The selected queue is exported and available in the **Activity > Historical** page. The exported queue is in the following file format: *Queue Export:Export.Queues.20220715_162251.<<username>>*

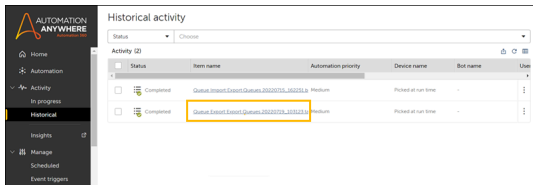

Note: If Automation 360 is email-enabled and the **A BLM package is exported or imported, to the user who performed BLM export or import.** notification in **Settings > Email** is selected, an email notification is sent to your registered email ID. The email body contains a link to the **Activity > Historical** page to download the exported queue.

6. Select the queue and click **Download exported zip file**.

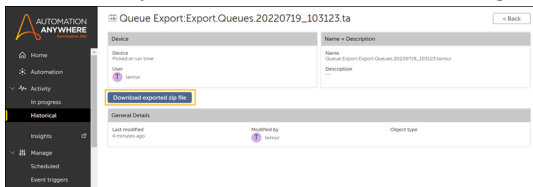

The exported queue zip file is downloaded to your local system, with details such as *Queue general settings, Queue work item template, and Work items* (if included during export).

Note: Data such as queue *owners, consumers, and participants* is not exported.

Import queues

Import queues for flexible usage that ensures efficient processing of WLM automations. You can also import queues along with work items.

- You must have the **AAE_Queue_Admin** role to import queues.

- Users and roles associated with the queues are imported, and the license assigned to the users is also imported.
- Ensure that the target Control Room user has create users, create roles, and install license permissions.
- Ensure that queue names are unique for importing. Queues with the same name are skipped and not imported in the target Control Room.
- The source and target Control Room instances must be running the same version.
- The source and target Control Room instances must be of same setup type: SSO with SSO, AD with AD, and non-AD with non-AD.

When importing a queue, consider the following factors:

- Before you import a queue, you must pause all the running WLM automations or queues.
- Users and roles associated with the queues are imported. Licenses (for example, Bot Creator and Bot Runner) that are assigned to the users associated with the queues are also imported.
- All the queue entities associated with the queue, for example, general settings, owners, participants, consumers, Work Item structure, and optionally Work Items are imported to your Control Room.
- When you import Work Items with the queues, the state of the Work Items (Completed, Failed, Data error, and so on) are maintained in your target Control Room.

To import a queue, perform the following steps:

1. Navigate to **Manage > Queues**.
2. Select the required queue and click **Import queues**.
3. In the **Import queues** page, click **Browse** to select the required queue from your local system.
4. Optional: Enter a password for the queue that you want to import.

If a queue already exists in your environment, you can select one of the following options:

- **Skip the queue (don't import it):** The selected queue is skipped and is not imported.
- **Make a copy of the queue (a suffix of "copy" will be added to the queue name):** A copy of selected queue is created and imported to your environment, with *copy* suffixed to the name of the queue.

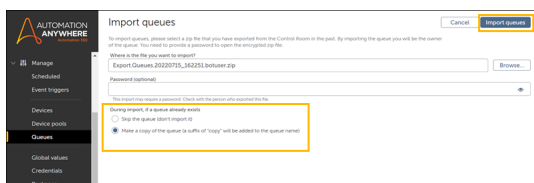

5. Click **Import queues**.

The selected queue is imported and available in the **Manage > Queues**

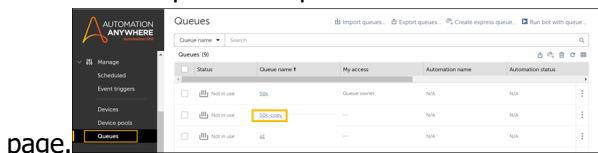

page.

Manage Work Items

Manage Work Items of a queue to fix the discrepancies before queue processing and reduce your automation-related errors.

Permissions required

You need any of the following permissions to manage the work items:

1. **AAE_Queue Admin** role
2. **View and manage my Queues** feature permission
3. **Queue Owner, Queue Consumer, and/or Queue Participant** permissions

Work item status and actions

Based on the Work Item status, you can do only certain actions on a Work Item.

Work item - status and actions

The following table provides a description of each Work Item status and the action you can do on a Work Item having that status:

Work Item Status	Description	Actions
New	New Work Item is added	View, Edit, and Delete
Ready to run	Work Item is successfully processed for execution	View, Edit, and Delete
Active	Work Item is currently being processed	View
Completed	Work Item successfully processed by a Bot Runner	View and Delete
Failed	Work Item processing has failed to execute on unattended Bot Runners	View and Edit
Data Error	Data type mismatch when adding Work Items to the queue	View, Edit, and Delete
On hold	Work Item is deferred for use by the Queue admin	View, Edit, and Delete

Related tasks

[Edit work items](#)

Use the **Queues** page or the **Work item** page to edit the work items of a queue.

[Define Work Item structure](#)

Define the Work Item structure for processing in a queue. This enables you to manually upload the Work Items from the system in the absence of ready data in a file.

View work items

View work items with a status of Completed, Unsuccessful, On hold, Active, or Data Error in the **View work item** page.

Ensure that you are logged in to the as the administrator.

From the **Workload > Queues** page, you can perform the following actions on either one queue or multiple queues, including:

- **Delete:** This will delete the work item permanently.
- **Mark complete:** This will mark the work item as complete.
- **Re-process:** This will mark the work item in **New** state.
- **On hold:** This will mark the work item as **On hold**.

Note: The **Start time** and **End time** are shown when the work item is being processed.

Select a queue to **View**, **Edit**, or **Delete** a queue.

1. Navigate to **Manage > Queues**.
2. Hover over the **Actions** icon for the queue.
3. Click **View**.

[Edit work items](#)

[Delete work items](#)

Related reference

[Work item status and actions](#)

Based on the Work Item status, you can do only certain actions on a Work Item.

Edit work items

Use the **Queues** page or the **Work item** page to edit the work items of a queue.

Ensure that you are logged in to the as the administrator.

You can edit a work item only if it is in a **New**, **On hold**, **Data error**, or **Failed** state.

1. Navigate to **Manage > Queues**.
2. Hover over the **Actions** icon for the queue.
3. Click the **Edit** icon. (✎)
4. Select one of the following options to filter the work items.
 - **Status**
 - **Id**
 - **Name**
 - **Work item result**

5. Change the work item status to **Mark complete**, **Defer**, or **Re-process** in the **Work item attributes and automation details** section.

You can reprocess the failed Work Items by editing and modifying from **Failed** to **Re-process**.

The system will set the status to **Data Error** during the data load if there is any issue with the data. For example, if a user enters a text value for a number field, or an invalid date string for an attribute of date type, the status will be displayed as **Data Error**.

[Work item status and actions](#)

6. Click **Save changes**.

[Delete work items](#)

Delete work items

Delete work items one at a time or **in bulk** in the **View work item** page.

Ensure that you are logged in to the as the administrator.

You can delete a work item only if it is in a **Data error**, **On hold**, **Ready to run**, **Complete**, or **Failed** state. For work items in the **Ready to run** state, the work item should not be in a queued state. To delete such work items, **Pause** the automation.

Note: You can also delete a work item one at a time or **in bulk** using the **Delete** option provided above the Work items table.

1. Navigate to **Manage > Queues**.
2. Select the queue.
3. Hover over the **Actions** icon for the queue.
4. Click **Delete**.
Confirm or cancel.

Related reference

[Work item status and actions](#)

Based on the Work Item status, you can do only certain actions on a Work Item.

Export work items to CSV file

Export work items to a CSV file for offline audits and records. The CSV file with the exported work items is available for download in the **Activity > Historical** page.

- You must have the **AAE_Queue_Admin** role to export or import work items.
- The source and the target Control Room instances must be running the same version.
- The source and the target Control Room instances must be of the same setup type: SSO with SSO, AD with AD, and non-AD with non-AD.

You can export selected, filtered, or all work items to a CSV file by using the following options:

- **Export checked items**
 - **Export filtered items**
 - **Export all items**
1. Navigate to **Manage > Queues**.
 2. Click the required queue and go to the **Work items**.
A list of available work items is displayed.

3.

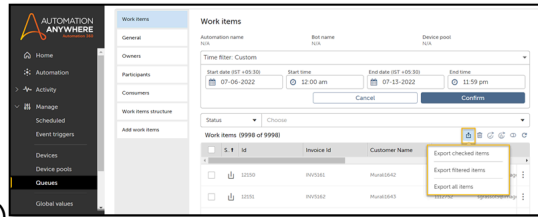

Click the **Export items to CSV** icon. (📄)

4. Click one of the following required options:

- **Export checked items:** Exports only the selected work items

Note: You must select items to use this option.

- **Export filtered items:** Exports only the filtered work items
- **Export all items:** Exports all the available work items

A message is displayed, informing that the exported CSV file is available in the **Activity > Historical** page.

5. Navigate to the **Activity > Historical** page and search for exported work items activity.

Note: You can search for a work item activity by the username. The work item activity name is in the following format: *Work items Export:cr-work-items-20220713-104704.csv*. You can change the work item activity name by using **File > Save**.

6. Select the work item activity and click **Download exported CSV file**.

The CSV file is downloaded to your local system as a zip file.

Workload guidelines

To optimally use your work items and queues in Automation 360, review the guidelines.

Do's

- Ensure that the queue has at least 2 owners so that there is no deadlock if an owner is deleted or disabled.
- If work items are added frequently to a queue, set the reactivation threshold to 1 so that when a work item is added, the work item is added quickly.
- Up to 10 work item columns can be displayed in the Control Room. Use this feature to get maximum visibility in to your work item data.
- Optimally use work item values that can accept up to 1000 characters, especially for work item result values.
- To prioritize certain work items, ensure that you sort the work item data when you create queues.
- To insert work items in a loop, use the `v3/wlm/workitems` API because this API accepts a list of work items in JSON format.
- Ensure that the time (clocks) in all the machines in a cluster are synchronized. This is important for the Apache Ignite cache server to function properly.
- Persistent and continual database connectivity is critical for the functioning of workload automation. Therefore, ensure that you perform a periodic network scan or use tools that can detect or avoid network issues.

- Apply the pagination filter to retrieve more than 200 work items when you retrieve them using the work item API.

```
"page" :
      {
        "offset":0,
        "length":1000
      }
```

Don'ts

- To ensure the system works efficiently, do not use the `v3/WLM/workitems` API in a loop to insert work items in bulk.
- If the Bot Runner is part of a device pool, do not create local schedules on that Bot Runner so that the Bot Runner runs only the work items.
- If a user has a queue in use, do not remove the **Run bot** permission from that user (role).
- If a work item is in progress, do not shut down a Bot Runner.

To take a Bot Runner offline for maintenance, ensure that you pause the queue and verify no work item is in progress on the Bot Runner.

- If a work item queue is being processed, do not stop or restart the Automation Anywhere Control Room Service. Instead, pause the queue automation, and then restart the service.

Working with repositories, credentials and roles

Control room administrators configure repositories for Bot Creators to develop RPA bots. Administrators create roles, assign users, and grants permission to action packages used in creating bots.

This topic is intended for experienced Automation Anywhere Automation 360 users.

Administrator tasks

Control room administrators setup repositories for Bot Creators to develop bots. For this process, administrators create users and assign these users specific roles, such as Bot Creators or Bot Runners. Bot Creators are granted access to specific RPA action packages to create, test, and run bots. Completed bots are transferred to the public repository for other users to deploy. The following is a breakdown of control room administrator related tasks to complete this process.

Set up your bot repository

Administrators create repositories for Bot Creators to develop , test, and debug bots. After configuring the repository, the administrator creates the role for the Bot Creator.

Assign a role

Roles grant specific permissions to users, such as Bot Creators and Bot Runners.

Create your users and assign their licensed roles

Create or otherwise edit the user information to assign the licensed role for accessing repositories, packages, and bot building tools and functionality.

Add packages to the Control Room

Administrators can add packages to the Control Room for use by Bot Creators.

Set up lockers and credentials in Credential Vault

The credentials assigned are typically those where the administrator is granting some internal, business-related access to a Bot Creator or Bot Runner for RPA development, for example to a Salesforce account.

Bot Creator task

Bot Creators often require access to protected data to automate a process. Each Bot Creator is given credentials governing the data they are permitted to access. The administrator creates the credential and assigns it to individual users by configuring specific roles for the Bot Creator to access those credentials. Bot Creators must add their own specific attributes to the credentials after they have been assigned by the administrator.

Manage user credentials

Bot Creators and Bot Runners rely on credentials to access necessary data relevant to the bot building process.

This task is performed by the user who wants to build and deploy . You must have the necessary rights and permissions to complete this task, and authorization to log in to the as the licensed user.

Bot Creators often require access to protected data to automate a process. Each Bot Creator is given credentials governing the data they are permitted to access.

Note: Administrators are required to have created the necessary roles and entitlements assigned to the user in order to update and use any granted permissions.

1. Navigate to **Bots > Credentials > My Credentials**.

Select the credential to view and or manage.

2. Click **Edit**.

The configurable fields for the credential are displayed, based on the user granted permissions.

For example, a bot is built that requires the authentication username and password to log in to a specific URL. The user will create a custom credential for this operation by amending the credential governed by the administrator, adding the additional security details. This way, the Bot Creator can authorize only that protected data deemed necessary for the automation.

3. Click **Save changes**.

Set up your bot repository

Administrators create repositories for Bot Creators to develop and build bots.

Ensure that you are logged in to the as the administrator.

Administrators create repositories for Bot Creators to develop , test, and debug bots. After configuring the repository, the administrator creates the role for the Bot Creator.

1. Log in to the as the administrator.

2. On the left pane, click **Automation**.

3. Click **Create subfolder**.

4. Provide the repository folder name and navigation path.

This repository folder is where the bots created by Bot Creators will be stored.

Important: Based on limits requirement in the Windows operating system (primarily Windows Server 2019 and 2016), ensure your folder, file names, and the nested folder structure is not long; otherwise, your bot execution or repository backup can be impacted.

5. Click **Create folder**.

Create roles for users. Roles grant specific permissions to users, such as Bot Creators and Bot Runners.

Create your users and assign their licensed roles

Create a user and assign their specific license based role.

Ensure that you are logged in to the as the administrator.

Create or otherwise edit the user information to assign the licensed role for accessing repositories, packages, and bot building tools and functionality.

1. Navigate to **Administration > Users**.
2. Click **Create user**.
3. Enter the required general details as follows:

Field	Value
Enable User	Select for the user to be activated and log in immediately. Note: If this option is not selected, user will be in the inactive state and cannot log in.
Username	Enter a unique user name.
Description	Enter a description for the user.
First name	Enter the first name for the user. Note: The number of characters allowed in the First name field is 50.
Last name	Enter the last name for the user. Note: The number of characters allowed in the Last name field is 50.
Password	Enter and confirm a password for the user. Ensure that the password follows all the necessary password policies.
Email	Enter and confirm the email address for the user. If SMTP is enabled, an email is sent to this address to confirm the account. All important Control Room notifications are sent to this email address.

4. Select the required role from the list of **Available roles**.

5. Click the right arrow (→) to add your selection.

6. Select **Allow** to allow multiple sessions.

You must be Control Room administrator to set a user as a multi-login service user. It is possible to set a user as a multi-login user either in the UI or API, however a user may only access multiple sessions through the API.

7. Assign the device Bot Creator license to the user.

The Bot Creator license enables user to create and run bots. Auto login is enabled by default.

Note: When you logged in as administrator, you cannot allocate any device license to the user and **None** option is selected by default.

License	Privilege
None	The user can access the Control Room only.
Bot Creator- Development license	Enables user to create and run bots. Auto login is enabled by default.
Unattended Bot Runner - Run-time license	Users with this license can perform all automation tasks that attended users can perform. Additionally, this license can also be used for Control Room deployment, centralized scheduling, and API-based deployment.
Attended Bot Runner - Run-time license	Users with this license can run bots on their devices and use any event trigger associated with their user account or role. However, these users cannot schedule bots.
Citizen Developer - Development license	Users with this license can create and run bots (including bots with triggers) on their devices.

The **Bypass legal disclaimer** option is automatically enabled to allow the user to run bots on a device without having to manually acknowledge a disclaimer.

After you select a device license, the **Device login credentials** are enabled. If you have the **Attest device credentials** permission, you can choose to attest the device credentials for this user to bypass credential validation when you deploy bots. The Bot Runner user should have an unlocked and active user session.

Note: This works only if the auto login setting **Reuse an existing session** is selected in the Control Room by the administrator.

8. Click **Create user**.

Update the Bot Creator packages and grant permissions to this user to build, test, and run bots. For more information, see

- [Automatic package updates for On-Premises Control Room](#)
- [Automatic package updates for Cloud Control Room](#)
- [Feature permissions for a role](#)
- [Bot permissions for a role](#)

Bot Lifecycle Management

The Bot Lifecycle Management feature enables you to move a bot from one environment to another. For example, you can move a bot from the development or testing environment to the production environment.

Overview

Bot Lifecycle Management easily integrates with the DevOps workflow, which supports separate development, testing, acceptance, and production environments and enables you to move bots along with their dashboards from one environment to another.

Bot Lifecycle Management provides a framework for continuous testing and deployment of bots and their dependencies in separate software development life cycle (SDLC) environments, allowing bots to seamlessly transition between lifecycle stages defined by an organization before they are released to production.

You can use the feature to move bots within different environments and help you prevent failure or disruption of data. You have to export a bot from one environment and then import it to another environment to move it between environments. You can also bundle all the dependencies of a bot when transitioning it through the different environments.

The following image shows a typical Bot Lifecycle Management workflow:

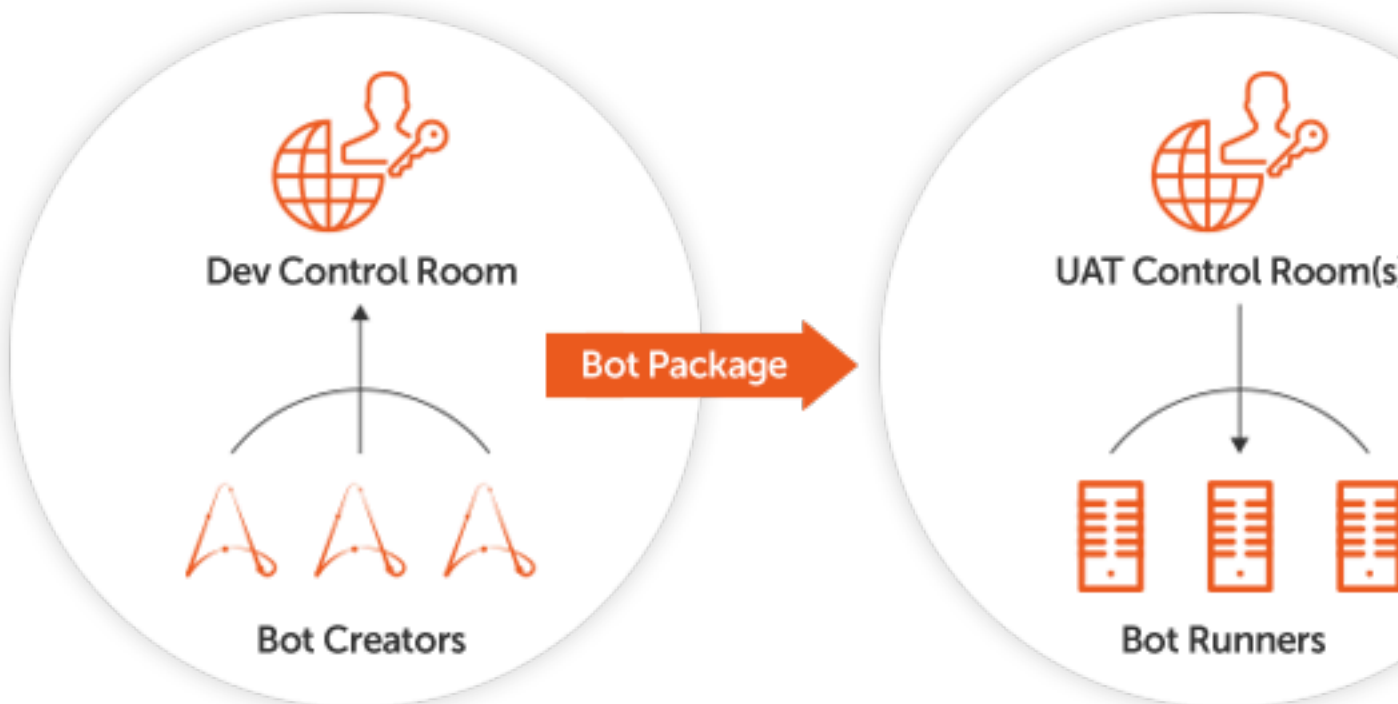

What is exported across environments

The following entities are included when you perform an export operation from one Control Room to another:

- Bot files

- Dependent files
- Action packages and dependencies
- Bot Insight dashboards

The following entities are **not included** when you perform an export from one Control Room to another:

- Credentials and credential lockers
- Workload management queues
- Bot Runner accounts and permissions

Permissions required to export and import bots

To export bots from the Control Room, you must have the following permissions:

- **Export bot** and **View packages** feature permissions
- **Check in** or **Check out** folder permissions

To import bots to the Control Room, you must have the following permissions:

- **Import bot** and **Manage package** feature permissions
- **Check in** folder permission

Importing Enterprise 11 bots when migrating to Automation 360

You can import your Enterprise 11 bots from the Enterprise 11 Control Room instance to Automation 360. This method enables you to consolidate the Enterprise 11 bots from multiple Control Room repositories to a single Automation 360 repository. After importing the bots to Automation 360, use the Bot Migration Wizard to convert the bots to the Automation 360 supported format (.bot).

Modes to import and export bots

You can use one of the following two modes to import and export bots across different Control Room instances. Choose a method that best suits your environment and requirements.

Manual mode

Involves exporting and importing bots using the user interface.

[Export bots](#) | [Import bots](#)

Automated mode

Involves exporting and importing bots programmatically using Control Room APIs.

[Export files using API](#) | [Import files using API](#)

Moving a bot

To move a bot from one environment to another, follow these steps:

1. Export the bot from the Control Room in the source environment.
2. Import the bot into the Control Room in the destination environment.

Related concepts

[Bot Lifecycle Management API](#)

Use the Bot Lifecycle Management API to export and import bots with dependent files and command packages for comprehensive automation lifecycle management. Users can export bots from public workspace and import to a private workspace in another Control Room and check into a public workspace.

Guidelines for exporting and importing bots

Review the guidelines before you export or import bots.

Guidelines for exporting bots

- Export the action packages along with the bot because the packages in the target Control Room to which you are importing the bot might be different.
- Export the bots folder-wise by moving all the bots from one folder first before moving to the next folder. So do not select the bots from the different folders
- Ensure your SMTP (email) server is integrated with the Control Room so that you can receive a link to the exported package through email.

[Email server settings](#)

- Ensure that the source and target Control Rooms have the same set of global values.
- Ensure that the source and target Control Rooms have the same set of lockers and credentials that are referred in the bots.

Guidelines for importing bots

- **Recommended:** When importing bot from the **Automation** page, use the **Skip the bot or file (don't import it)** option because you might want to check the bot first before overwriting it with the imported bot.
- **Recommended:** First import the bots to your private repository (if you are a bot developer), verify the bot, and then check it in to the public workspace.
- The bot directory path is case-sensitive, so ensure that the export and import paths use the same letter case in the Control Room.
- Before importing a bot file of size 200 MB or more, check your load balancer configuration. In few environments, the bot import might fail with an error.

Export bots

You can export a bot from one Control Room to another.

- Only bots in the public workspace can be exported. To export bots, first check these bots into the public workspace before exporting them to the private workspace.
- Ensure that you have the `View package` permissions.
- Ensure that you have the `View content` rights at the folder level from which you want to export the bots.
- Ensure that the version of Control Room and packages in the source and target Control Room are same for export as well as import.

Review the guidelines before you export bots.

[Guidelines for exporting and importing bots](#)

Recommendation: To efficiently use the Control Room disk size, as a Control Room administrator, delete the old export packages from `C:\ProgramData\AutomationAnywhere\Server Files\BLM` on the Control Room machine.

1. On the left pane, click **Automation**.
A list of available and forms is displayed.
2. Click **Export bots** icon in the public workspace.
3. Select the bot you want to export.
 - Latest version: Click **Latest version** tab to select the latest version of the bot.
 - Labeled version: Click **Production version** tab to select the labeled version of the bot.
4. Click **Next**.
The bot and its dependencies are ready for export and displayed in the **Review Dependencies** window. If the production label option is selected for the parent bot, the corresponding dependent bots with the production label are also automatically selected. If any of the dependent bots do not have the production label applied, the latest version of the bot is selected.
5. Click **Next**.
All related packages are displayed.
6. Select the necessary packages associated with the bot to export.
Select **Exclude bot packages** to remove all packages from the export.
7. Optional: Enter a password in the **Create password** field.
Password enhances the security for your bot or file when exporting from one Control Room to another.
8. Re-enter the password in the **Confirm password** field.
9. Click **Export bots and files**.
All the selected bots are exported into a `zip` file.

Based on the result (failure or success) of the export bot functionality, a notification is also displayed in the Control Room **Notifications** icon. For more information, see [Export bot](#) event notification.

Note: If you have analytics bots in your Control Room, all the Bot Insight dashboards (default, custom, and published) associated with the bots are also exported into the `zip` file.

If you have configured SMTP, an email is sent that contains a link to the `zip` file of the exported package.

If you have not configured SMTP, perform the following steps to access the link to the `zip` file of the exported package:

- a) Navigate to **ACTIVITY > Historical**.
- b) Search and view the historical activity of the exported package.
- c) Click **Download exported zip file**.
A link to download the `zip` file is displayed.

10. Use the link to download the `zip` file and save it to a location for importing it to another Control Room.

Import the bots into an Control Room.

Related tasks

[Import bots](#)

You can import bots with their dependencies from one Control Room to another. The source environment can be Automation 360 Control Room, Enterprise 11, or Enterprise 10 Control Room instance.

[Export files using API](#)

You can export bots with their dependent files using the Export API.

Related reference

[System roles](#)

System roles are preconfigured with the permissions necessary to perform the tasks within the scope of that role. They cannot be modified or deleted. Administrators assign the roles to users to enable them to access features and perform operations in the Control Room.

Import bots

You can import bots with their dependencies from one Control Room to another. The source environment can be Automation 360 Control Room, Enterprise 11, or Enterprise 10 Control Room instance.

- Ensure that the following rights are enabled to import bots:
 - Import bots permission
 - Create folder permission, if it is required
 - Check-in to public workspace permission if you are importing to the public workspace
- Ensure that the version of Control Room and packages in the source and target Control Room are same for export as well as import.
- You must have a Bot Creator license to import bots either into the private workspace or public workspace.

You can import bots into the public workspace if you have the required permissions, regardless of your license.

- To import the Enterprise 11 bots into your Automation 360 Control Room, consider the following additional requirements:
 - You must have the required `aapkg` package that you created using the Bot Lifecycle Management export feature in the Enterprise 11 Control Room instance.
 - The `aapkg` package must be present in the same Automation 360 machine where you want to import the Enterprise 11 bots.
 - You can import the password protected `aapkg` packages using the Bot Lifecycle Management Import API only.

[Import files using API](#)

- Review the guidelines before you import bots.

[Guidelines for exporting and importing bots](#)

- To import bots from one Control Room to another, use the exported `zip` file (or `aapkg` file, in case of Enterprise 11 or Enterprise 10 bots). If the SMTP is configured, you will receive a link to download the `zip` or `aapkg` file on your configured email address. If SMTP is not configured, you can access the download link by navigating to **Activity** > **Historical** page.

Note: You can import the Enterprise 11 bots (`.aapkg` file) with or without the dependent MetaBots only into the public workspace. If you are importing the file into the private workspace, ensure that the dependent MetaBots dependencies are included.

1. On the left pane, click **Automation**.
A list of available and forms is displayed.
2. Click **Import bots**.

3. Browse and select the required `zip` file or `aapkg` file based on your source environment:

Source environment	Action
Automation 360 bots	Select the required <code>zip</code> file.
Enterprise 11 or Enterprise 10 bots	Select the required <code>aapkg</code> file.

4. Select the private workspace or public workspace based on your following source environment:

Source environment	Action
Automation 360 bots	<p>You can select either the private or public workspace as required.</p> <p>If you have analytics bots in your source Automation 360 environment, then all the associated Bot Insight dashboards are also imported based on the following selection:</p> <ul style="list-style-type: none"> • If you select the private workspace, you can view only default and custom dashboards. To view published dashboards, you must check in the bots to the public workspace. • If you select the public workspace, you can view only published dashboards. To view default and custom dashboards, you must check out the bots to the private workspace.
Enterprise 11 or Enterprise 10 bots	<p>Select the public workspace.</p> <p>This selection enables you to migrate Enterprise 11 or Enterprise 10 bots to the Automation 360 environment later during migration.</p>

5. Optional: Enter the password in the **Password** field.

If your exported bot or file is password protected, you will be prompted to enter a password. Obtain the password from the user who has exported this bot or file.

6. If some of the files that are being imported from the package are already available in your Control Room, choose one of the following options:
- **Skip the bot or file (don't import it)**
 - **Overwrite the bot or file with the imported one**

7. Click the **Import bots** option.

8. After the import is complete, based on your source environment, navigate to the corresponding repository to find and use the imported bot:

Source environment	Action
Automation 360 bots	Navigate to the corresponding workspace (private or public, based on your selection in Step 4).

Source environment	Action
Enterprise 11 or Enterprise 10 bots	<p>Navigate to the public workspace in the Bots > My Tasks folder or Bots > My Metabots folder.</p> <hr/> <p>Note: Enterprise 11 and Enterprise 10 bots are imported in <code>.atmx</code> and <code>.mbot</code> format. Use the migration wizard to convert the Enterprise 11 and Enterprise 10 bots files to the <code>.bot</code> format, which is supported in Automation 360.</p> <p>Migrate Enterprise bots</p> <hr/>

Related tasks

[Export bots](#)

You can export a bot from one Control Room to another.

[Import files using API](#)

You can import bots with their dependent files using the Import API.

Related reference

[System roles](#)

System roles are preconfigured with the permissions necessary to perform the tasks within the scope of that role. They cannot be modified or deleted. Administrators assign the roles to users to enable them to access features and perform operations in the Control Room.

Credentials and lockers in the Credential Vault

The Credential Vault securely stores sensitive information such as passwords, account numbers, and social security numbers in credentials and lockers for use in automation tasks. It facilitates role-based access for users of a Control Room and ensures that sensitive values are not stored in bots or on devices.

The Credential Vault consists of two main features: credentials and lockers.

Best Practices:

- Each credential should contain a single password used for authentication to a specific system.
- The credential may have additional attributes such as user name or hostname depending upon what is required in the authentication process that the credential is used for.
- Credentials for applications that process data which requires the highest confidentiality have the least number of consumers where credentials for applications that require lower confidentiality can have a higher number of consumers. Segregate credentials based on applications and data confidentiality.
- Lockers are created to hold credentials that are related to a specific business purpose or class of application based on confidentiality.

Credentials

A credential holds the sensitive information in attributes. An attribute can have a value that is standard for all users or it can accept a user-input value. For example, an `Email` credential can hold three attributes: `host name` (standard value), `username` (user input), and `password` (user input).

By default, all users can create, manage, and use their own credentials. A user is granted access to another user's credentials by receiving access to a

Lockers

locker that holds the credential. If the credential requires a user-input value, it appears in the **CREDENTIAL REQUESTS** tab.

A credential must be assigned to a locker to be used for building and running a bot.

A locker specifies which users can view, modify, or access the credentials. For example, a human resources (HR) locker can hold `Email`, `Database`, and `Training website` credentials and allow only specific employees of the HR department to use the credentials in their bots.

A user with either the `AAE_Locker Admin` role or a user-created role with the **Manage my credentials and lockers** permission configures lockers, adds credentials, and grants access to other users.

Benefits of using the Credential Vault

Apart from providing a secure and centralized location for storing credentials, using the Credential Vault also:

- Minimizes credential fraud.
- Provides an environment to enable improved security.
- Enables businesses to adhere to the processes and credential management compliance standards.
- Offers increased automation opportunities with secure data applications.

Related concepts

[RBAC for Credential Vault credentials management](#)

Credentials created in the Control Room are used across Bot Creators and Bot Runners.

[Configure Credential Vault Connection mode](#)

Credential Vault is a centralized location for securely storing credential information used by bots.

Set up lockers and credentials in Credential Vault

Assign credentials to lockers for Bot Creators to access during the bot building process.

Ensure that you are logged in to the `as` as the administrator.

The credentials assigned are typically those where the administrator is granting some internal, business-related access to a Bot Creator or Bot Runner for RPA development, for example to a Salesforce account.

Note: Credential and attribute names are not case-sensitive and are stored as "lower-case".

1. Navigate to **Manage > Credentials**.
2. Click **Create credential**.
3. Enter the **Credential name** and a **Description** for the configured credential or select **External key vault**.
If integrating with an external key vault, then proceed to [Select External key vault](#).
4. Enter the **Attribute name** and supply the **Description** for the attribute.

5. Select one of the following **Input** options:

Input	Value
Standard	Enter the value. All users see the same credential value set by the credential owner.
User-provided	The value field is not available because the values are not preset during creation. Only users of the locker containing this credential can provide the value.

6. Set **Security** for the attribute.

Note: When the **Masked** option is selected, the attribute value is marked as a password-only attribute and shown as asterisk (*) characters for security purpose.

7. Click **Create credential**.
 8. Click the **MY LOCKERS** tab.
 9. Click **Create locker**.
 10. Enter the **Name**.
 11. Optional: Enter a description.
 12. Click **Create locker**.

Set up locker and assign credentials

Create a role, credentials, and locker to share related sensitive values with a group of users, so they can use those values to build or run bots.

Do the following to set up the locker and assign credentials:

1. *Create a role*

Define a role and assign permissions to access various features for building bots.

Note: You must have the **AAE_Admin** role or the **Manage roles** permission to create a role and assign it to users.

2. *Create credential*

Create a credential and add the required attributes.

Note: You must have the **Manage my credentials and lockers** and **Create standard attributes for a credential** permission to create a credential and attributes.

3. *Create locker*

Create a locker to group similar credentials and share with other users.

Note: You must have the **AAE_Locker Admin** role or the **Manage my credentials and lockers** permission to create a locker and assign users and roles to it.

Related concepts

[RBAC for Credential Vault credentials management](#)

Credentials created in the Control Room are used across Bot Creators and Bot Runners.

Related tasks

[Edit a credential](#)

Modify credential details and add or remove attributes.

[Edit a locker](#)

Add or remove credentials, owners, managers, participants, or consumer roles.

Create credential

Create a credential and add the required attributes.

This task is performed by the Automation Anywhere Control Room administrator. You must have the necessary rights and permissions to complete this task. Ensure you are logged in to the Control Room as the administrator, or a user with either the `AAE_Locker_Admin` role, or a user-created role with the **Manage my credentials and lockers** permission to configure lockers, add credentials, and grants access to other users.

Assign the credential when adding the credential details. If no locker was created, create a locker and then assign the credential. Add up to 50 attributes to a credential.

1. Log in to the Control Room as the administrator.
2. Navigate to **Manage > Credentials** and click **Create credential**.
3. Enter the **Credential name** and a **Description** for the configured credential or select **External key vault**.

If integrating with an external key vault, then proceed to [Select External key vault](#).

4. Enter the **Attribute name** and supply the **Description** for the attribute.
5. Select **External key vault**.

If integrating with an external key vault, such as AWS, Microsoft Azure, or CyberArk, enter the required credentials for the specified external vault as follows:

AWS	Enter the secret name.
CyberArk	Enter the object name.
Microsoft Azure	Enter the secret name.

6. Select one of the following **Input** options:

Input	Value
Standard	Enter the value. All users see the same credential value set by the credential owner.
User-provided	The value field is not available because the values are not preset during creation. Only users of the locker containing this credential can provide the value.

7. Set **Security** for the attribute.

Note: When the **Masked** option is selected, the attribute value is marked as a password-only attribute and shown as asterisk (*) characters for security purpose.

8. Optional: Select **Use attribute ONLY on Password or Masked fields**.

This option ensures that bots input the attribute value only into fields that are identified as password fields.

Note: When this option is selected, an attribute is available only for the commands in Automation Anywhere Enterprise client that support credential variables and where the fields are of **Password** type.

9. Click **Create credential**.

Assign this credential to a locker.

Edit a credential

Modify credential details and add or remove attributes.

A credential can be edited by the owner when the credential is not assigned to a locker. If a credential input type is user-provided, then locker consumers can edit the credential to input a value.

Role-based access and locker permissions

Note: A user with the **AAE_Locker Admin** role can assign a credential to a new owner. For more information, see *Transfer credential ownership*.

1. Navigate to **Manage > Credentials**.
2. Hover over the **Actions** icon for the credential.
3. Click the **Edit** icon. (✎)
4. Edit the credential.

If the email notification setting is enabled and credentials are added to a locker, then all the locker consumers receive an email.

The maximum limit of credential attributes that is allowed is 50. If you have upgraded to the current version and have migrated credentials that have more than 50 attributes, when editing that particular credential, the following message displays: `Credentials can only have a maximum of 50 attributes`. To continue, remove the additional attributes that cannot be saved and add those to a new credential.

5. Click **Save changes**.

Related reference

[Credential Vault email notifications](#)

When the email notification setting is enabled, it ensures that users are notified of any changes to credentials and lockers.

Transfer credential ownership

A user with the **AAE_Locker Admin** role can transfer a credential to a different owner.

A credential can only be reassigned to a different owner if it is in a locker. The new owner can be either the locker owner, manager, or participant.

1. Navigate to **Manage > Credentials**.
2. Use the search bar to find the credential.
3. Hover over the vertical ellipses to the right of the credential.
The actions menu opens.
4. Click **Transfer credential ownership**.
A list of users with access to the locker appears,
5. Select the new credential owner.
6. Click **Yes, submit**.

Create locker

Create a locker to group similar credentials to share with other users.

You must either have the `AAE_Locker_Admin` role or **Manage my credentials and lockers** permission and the necessary permission to View Users and Roles.

Note: You must have the View Users and Roles basic information permission to view information about other users to add them as locker owners/Managers/participants. Without this permission, an "Access denied" error will occur.

See [RBAC for Credential Vault credentials management](#)

There is **no limit** on the number of credentials that can be stored in a locker. A credential can only belong to one locker. See [Create credential](#). Credentials are further divided in logical groups called lockers.

To create a locker, follow these steps:

1. Navigate to **Manage > Credentials**, and then click the **Lockers** tab.
2. Click **Create locker**.
3. Enter the **Name**.
4. Optional: Enter a description.
5. Select the **Credentials** to add to the locker or select **External key vault**.
6. Enter **External key vault** credentials.

If integrating with an external key vault, such as AWS, Azure, or CyberArk, enter the required credentials for the specified external locker:

AWS	Enter the prefix of secrets stored in the locker.
CyberArk	Enter the safe name where the credential lockers are stored.
Azure	Enter the prefix stored in the locker.

7. Click **Next**.
8. Add the **Owners**.
9. Click **Next**.
10. Optional: Add the **Managers** and click **Next**.

A locker must have at least one owner. The locker owner can edit, view, and delete a locker and also add or remove other owners.

The locker manager can view, edit and delete the locker, and add participants but cannot add owners or managers to the locker.

11. Optional: Add the **Participants** and click **Next**.

A locker participant has access to view a locker and add their own credentials to a locker.

Note: A **locker participant** does not have access to or visibility of credentials created by other users.

12. Add the Consumers.

Select one or more roles. Users with these roles have access to the locker. System-created roles are not shown in the **Consumers** list.

Type	Permission
Standard	Locker consumers can view the locker and all the credentials inside the locker. All consumers see the same credential value set by the credential owner.
User-provided	Locker consumers can input their information in user-provided credentials with user-provided attributes.

13. Click Create locker.

If the email notification setting is enabled, users receive an email confirming the locker name and their permissions to that locker.

Edit a locker

Add or remove credentials, owners, managers, participants, or consumer roles.

Only a locker owner, locker manager, or locker admin can edit a locker. To edit a locker, follow the steps mentioned below:

Note: Credential, owner, managers, participants, and consumers are separate entities associated with the locker to grant permission. These are not locker entity attributes and modifying these does not change locker objects. Therefore when you edit these fields inside a locker, the locker object is not modified and thereby locker's last modified field is also not updated.

1. Navigate to **Manage > Credentials**, and then click the **Lockers** tab.
2. Hover over the **Actions** icon for the locker.
3. Click the **Edit** icon. (✎)
4. You can make changes to the following:

Option	Description
Credentials	Add or remove credentials that are assigned to a locker.
Owners	Add or remove locker owners. <hr/> Note: A locker must have at least one owner. <hr/>
Managers	Add or remove locker managers.
Participants	Add or remove locker participants.
Consumers	Add or remove locker consumers.

If email notification setting is enabled and credentials are added to a locker, then all the locker consumers will receive an email.

5. Click **Save changes**.

Credential Vault email notifications

When the email notification setting is enabled, it ensures that users are notified of any changes to credentials and lockers.

Overview

Email notifications are sent for the following scenarios:

Credential is added to a locker

When credential is added to a locker, a notification is sent to all consumers of the locker to their email address registered in the Control Room. The email consists of a link to the credential that is added to the locker. The consumers are redirected to edit the credential page wherein they input the credential value.

Member is added or removed from a locker

An email notification is sent when a new member (co-owner or participant) is added to a locker or removed from the locker as a member of participant.

Change in permission for locker members

When a locker owner/admin grants or removes locker membership permissions from a locker, an email notification is sent to the locker members at their email address. This ensures that members are notified of their membership changes within the locker.

Locker consumer gets added or removed from a role assigned to a locker, or consumer role gets added or removed from a locker

When a role assigned to a locker is modified by addition or removal of users, an email notification is sent to the new or existing user at their email address so that the consumers are notified that credentials are pending for their input in the locker. Also when a new role added to a locker or an existing role is revoked from the locker, an email notification is sent to the new or existing consumers at their email address so that the consumers are made aware of the changes.

External key vaults for Automation 360

External key vaults provide a secure, encrypted storage space for sensitive data used by RPA. Customers' sensitive data can be accessed and used by their RPA platform by storing the data in a corporate-approved key vault, such as CyberArk Password Vault, AWS Secrets Manager, or Azure Key Vault.

Automation Anywhere provides a secure key vault called Credential Vault. Requirements for external key vault usage are generally related to certain compliance standards and corporate security policies implemented by your IT and IT security groups. As part of their data security policies, these groups select and maintain corporate key vault services, and define the standards for the protection of sensitive data. The Automation 360 Control Room leverages external key vaults to store credentials for security and compliance.

Note: External key vault integration is not supported on Oracle Database.

Users and roles

The following users typically configure and work with external key vaults:

RPA Administrators

RPA Administrators who have **AAE_Admin** and **AAE_Locker_Admin** roles with permissions to administer Automation 360 Control Room and Credential Vault instances. The RPA Admin works with the customer External Key Vault Admin.

Customer External Key Vault Administrators

Customer External Key Vault Administrators who are responsible for the administration and management of the external key vault tasks (for example, setting up, managing, and creating access policies).

Benefits

The Automation Anywhere Credential Vault is secure and provides deep integration with the RPA platform. However, because corporate IT must provide secure data services as part of their IT security policies, the RPA platform might be required to use external key vault technology to comply with corporate standards.

External key vaults enable the RPA platform to fully comply with corporate requirements and can provide these additional benefits:

- Deep integration with the Identity Provider (IdP) and corporate authentication platforms such as single sign-on (SSO) and Directory Services (such as Microsoft Active Directory).
- Support of password rotation and synchronization with the systems used with the RPA platform.
- Administration of the key vault and security best practices are performed by the IT group who manages the external key vault instead of the RPA administrators. As a result, the RPA platform becomes a consumer of the credential service.

Guidelines

External key vault integration guidelines support the operation of the RPA platform relating to the coordination, configuration, and consumption of credentials and sensitive data from the external key vault technology.

- **Coordination:** Establish designated contacts for the key vault and RPA platform technologies and identify the individuals responsible for communicating operational guidelines, security policy, and compliance requirements for credential management.
- **Configuration:** Designated contacts collaborate on the use case implementation and configuration requirements of the RPA platform and the external key vault.
- **Consumption:** Based on which use cases are implemented, designated contacts monitor the integration of the RPA platform and the external key vault and coordinate credential rotation and naming requirements.

Integrating external key vault with Control Room

Automation Anywhere Control Room supports these external key vaults: CyberArk Password Vault, AWS Secrets Manager, and Azure Key Vault.

Use cases

The following use cases are supported:

Control Room bootstrap

Retrieval of credentials used by the Control Room to authenticate to supporting services such as database and Control Room software service account.

Control Room system

Retrieval of credentials used by the Control Room for Active Directory (AD) and email (SMTP) integration.

Agent auto-login

Retrieval of credentials used by the RPA platform to launch automations on designated Automation 360 Bot Agent devices.

Agent automation

Retrieval of credentials that the automation (bot) uses during runtime to perform authentications to the applications that are being automated.

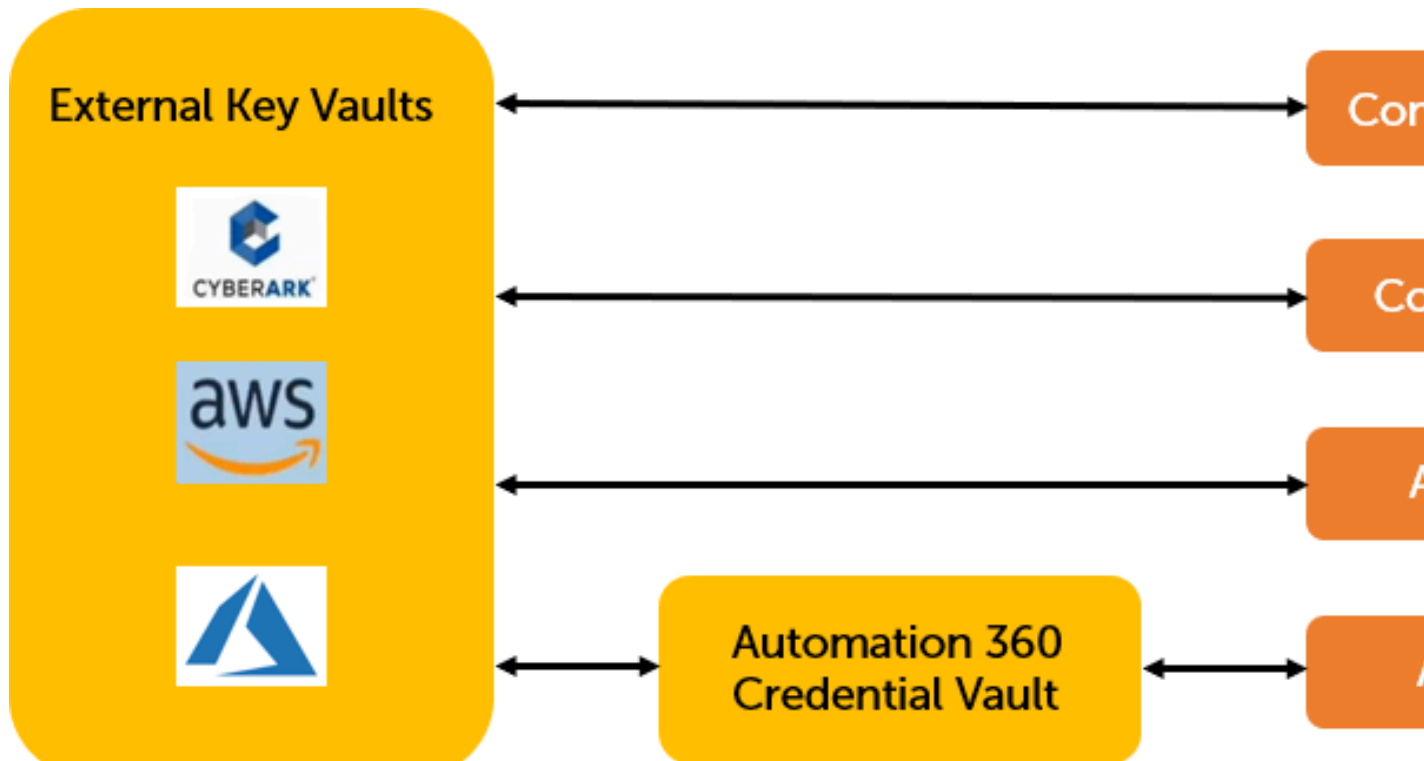

Plan your integration

Before you integrate your external key vault with the Automation 360 Control Room, you need to develop an overall external key vault strategy.

The answers to these questions will help determine the integration requirements for the external key vault.

What type of Automation 360 Control Room deployment do you have: On-Premises or Cloud?

- **On-Premises:** The Control Room and external key vault are hosted at the customer's site and environment.

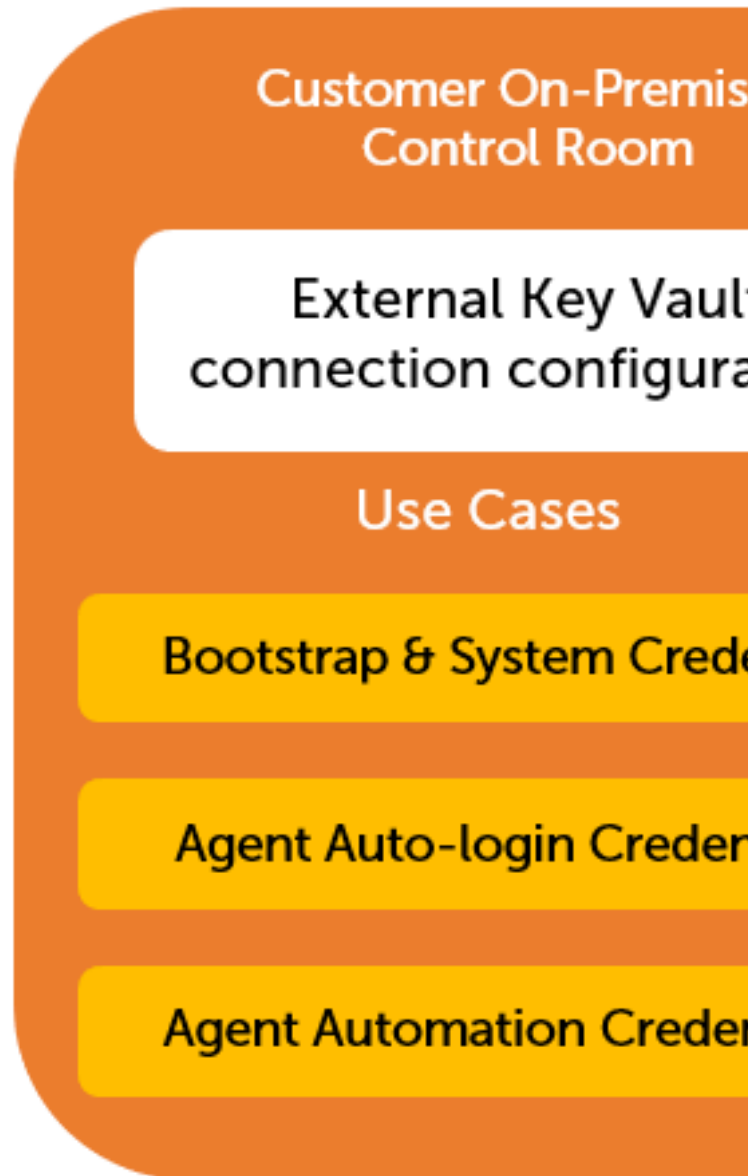

The external key vaults might contain these external key vaults hosted within the customer

site (customer-controlled datacenter or environment):

- CyberArk Password Vault – Customer On-Premises environment
- AWS Secrets Manager – Customer AWS environment
- Azure Key Vault – Customer Azure environment

You can configure the external key vault connection during initial installation or post-installation using the key vault utility.

- **Cloud:** The Control Room is hosted on the Automation 360 Cloud environment and the external key vault is hosted within the customer site (where the customer-controlled datacenter is either On-Premises or in a Cloud environment such as AWS):

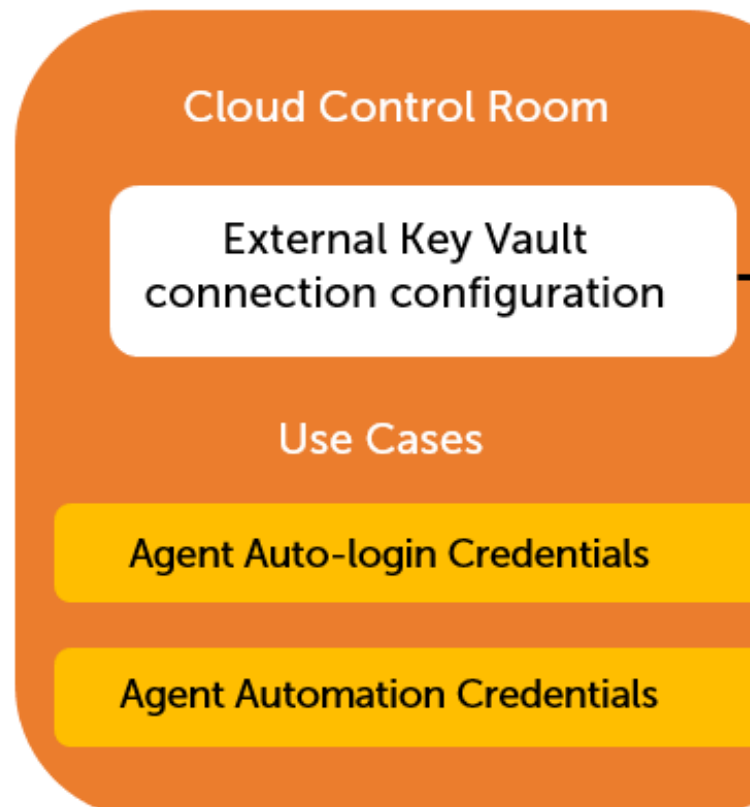

The key vault in the customer network requires connection to the Automation 360 Cloud Control Room. You configure the connection to the external key vault from the Automation 360 user interface. Customer network perimeter configuration is required.

What type of third-party external key vault do you have?

CyberArk Password Vault, AWS Secret Manager, or Azure Key Vault.

Each external key vault has their own specific requirements. Review all configuration requirements with RPA and external key vault administrators before starting the integration.

What type of credentials do you need to retrieve from the external key vault based on the supported use cases?

By integrating the Automation 360 Control Room with your external key vault, you can retrieve credentials that support these use cases:

Use case	Credentials	Supported deployment	Credential caching	Credential rotation
Control Room bootstrap	Used to authenticate the database and (optionally) start the Control Room services (Service account)	On-Premises only	Caches the retrieved values	You should rotate the database credential during scheduled downtimes
Control Room system	Used to authenticate to Active Directory (AD), Service account, and SMTP	On-Premises only	Caches the retrieved values	You should rotate the AD, Service account, and SMTP credentials during scheduled downtimes
Agent auto-login	Used by Bot Agent to perform auto-login on a Bot Agent device before launching an automation	On-Premises and Cloud	Does not cache values from external key vault	Always retrieves the latest available credential rotated in the external key vault

Use case	Credential	Supported deployment	Credential caching	Credential rotation
Agent automation	Used by the automation to authenticate to the applications being automated	On-Premises and Cloud	Does not cache values from the external key vault	Always retrieves the latest available credential rotated in the external key vault

Coordinate with external key vault admin team

To ensure a productive, efficient, and rapid integration with the external key vault, you must coordinate with the external key vault administration team and exchange the technical requirements of the RPA platform. By carefully planning and coordinating with the external key vault administration team, you can quickly integrate the Automation Anywhere Control Room with the external key vault and avoid time-consuming troubleshooting issues.

We suggest you follow these guidelines to structure your integration process:

- Review the supported credential use cases to determine which credentials the RPA platform requires to retrieve from the external key vault.
- Schedule a kick-off meeting with the external key vault administration team to exchange information for these details:
 - Which key vault to use?
 - Which use cases to configure?
 - What are the credential naming conventions required by the RPA platform?
 - How are the credentials configured and updated on the external key vault?
 - Does the external key vault have multiple instances (multiple instances of the external key vault can be used for different Automation Anywhere Control Room instances)?
 - Who are the designated contacts for the RPA platform and key vault administration?

- Review the configuration requirements for the Control Room:
 - Are you installing a new Control Room with key vault integration?
If so, then review the installation procedure for the external key vault integration.
 - Are you configuring an existing Control Room to use external key vault integration for the first time?
If so, then review the key vault utility usage procedure to configure key vault integration post-installation.
 - Is the Control Room an Automation 360 Cloud Control Room that will connect to an on-premises key vault?
If so, then you must coordinate with your IT networking team to configure connectivity between the Cloud Control Room and your internal network.
 - Review the external key vault configuration procedure and note all integration settings requirements:
 - Key vault configuration requirements to configure on the external key vault before integration
 - Control Room operating system configuration
 - Authentication method that the Control Room will use to connect to the external key vault
- Schedule integration meetings to coordinate these configuration and set up tasks for the Control Room and external key vault administrators:
 - Configuration of the key vault connection
 - Configuration of each use case
 - Testing of each use case

Note: These integration meetings should be ongoing until you have configured and tested all use cases.

- Add the external key vault integration to regular IT cadence meetings to monitor the operation of the Control Room and the external key vault, specifically credential rotation coordination.

External key vault naming conventions

Specific authentication credentials and external key vaults have restrictions on the use of certain characters in usernames, phrases, and other text. Also, there are different naming conventions to follow based on the external key vault and the credential use cases: Agent auto-login or Agent automation.

Agent auto-login naming conventions

- **CyberArk:** All Agent auto-login credentials are retrieved from the specified safe name and assumed to exist within the Auto-login Credential Safe.
- **AWS Secrets Manager and Azure Key Vault:** All Agent auto-login credentials must adhere to the required naming conventions detailed on this page.

If the Control Room performs an auto-login credential retrieval but no credential exists in the Auto-login Credential Safe that matches that user name, then the auto-login will fail. For any unattended automations, all robotic or digital worker user IDs must have an auto-login credential configured for each Control Room user within the external key vault.

The Control Room retrieves auto-login credentials based on the object naming convention within the external key vault. The Control Room searches for an object where the object name (the credential name in the external key vault) matches the Control Room username for which it is performing auto-login.

The prefix `autologin_` is required as part of the naming convention for auto-login credentials for all external key vaults: CyberArk, AWS, and Azure. The name of the auto-login credential in the external key vault must contain `autologin_` followed by the Control Room username. In some cases, certain key vaults have restrictions on the characters that can be used in credential object names. Additionally, to support how different use cases encode credentials, Automation 360 requires that certain characters be reserved or encoded.

The following table lists examples of the object naming conventions expected in the Control Room:

Control Room username	Expected object name format
ABCD\user123	autologin_ABCD--user123
user123@rpa.abcd.com	autologin_user123-40-rpa-2e-abcd-2e-com

Note: For On-Premises customers using AD authentication, you must format auto-login usernames using the UPN format or `domain\username` postfix.

For auto-login credentials, keep these in mind:

- The object name in the external key vault must contain `autologin_` as a prefix.
- The auto-login credential names must map to the Control Room username (login ID) for the credential being retrieved.

Some external key vaults have usage restrictions of certain characters, such as backslash (\) and ampersand (@) in the secret name (object name), and restrictions on how special characters are interpreted within API calls. If the user ID contains special characters, then you must encode the secret name (object name) in the external key vault using ASCII code character substitutions, as listed in the following table.

This character	Changes to this ASCII code character substitution
\ (backslash)	--
- (dash)	-2d-
_ (underscore)	-5f-
@ (ampersand)	-40-
. (period)	-2e-

Note: Except for the backslash being mapped to double dashes, the dash, period, underscore, and ampersand are mapped using their ASCII code bracketed in dashes.

Agent automation naming conventions

Agent automation credentials are credentials retrieved by the automation during runtime and used by the automation bot to authenticate with applications. Automation credentials retrieved from external key vaults are mapped in the Automation Anywhere Credential Vault using the **External Key Vault** option when configuring lockers and credentials.

The Automation Anywhere locker is mapped to either of the following:

- Safe Name (CyberArk)

- Secret Name Prefix (AWS and Azure)

A credential is mapped to either of the following:

- An Object Name (CyberArk)
- A Secret Name body (AWS and Azure)

Note: You can map any Automation Anywhere locker to any CyberArk Safe Name. The Safe Names used to map Automation Credentials should be distinct from the Safe Name used for auto-login.

To support the Automation Anywhere user-defined credentials functionality, you can create credentials using a Control Room_username postfix because these credentials are retrieved based on the user context of the running bot. If you do not create user-defined credentials, then the automation bot credential retrieval process retrieves the system credential.

Note: For On-Premises customers using AD authentication, you must format Agent automation usernames using the UPN format or `domain\username postfix`.

External key vaults prohibit different special characters in secret names. As a result, you must encode some characters in the credential (secret) name in the external key vault based the type of external key vault (CyberArk, AWS, or Azure) you are using and its specific requirements.

CyberArk Password Vault automation example

The following table shows CyberArk external key vault examples using naming conventions for automation.

Note: The Safe Name maps to the locker for the Control Room, and the Object Name maps to the credential for the Control Room.

Automation credential example	Safe Name	Object in locker	Control Room username
System credential in locker mapped to Safe Name	finance	glaccess	None - system credential
User-defined credential in locker mapped to Safe Name	finance	glaccess_ABCD--RPA--user123	ABCD\RPA\user123
User-defined credential in locker mapped to Safe Name where username is encoded with ASCII mapping	finance	glaccess_ABCD--RPA-2e-user123	ABCD\RPA.user123

AWS Secrets Manager automation example

The following table shows AWS Secrets Manager external key vault examples using naming conventions for automation.

Note: The AWS Secret Name Prefix maps to the locker for the Control Room, and the AWS Secret Body maps to the credential for the Control Room.

Automation credential example	AWS Prefix	AWS Secret Body	Secret in AWS	Control Room username
accounting_pdf System credential in locker mapped to AWS Secret Name prefix <code>accounting</code>	accounting	pdf	accounting_pdf (system)	None - system credential
accounting_pdf_ABCD--user123 User-defined credential in locker mapped to AWS Secret Name prefix <code>accounting</code>	accounting	pdf	accounting_pdf_ABCD--ABCD\user123	ABCD\user123

Azure Key Vault automation example

The following table shows Azure Key Vault external key vault examples using naming conventions for automation.

Note: The Azure Prefix maps to the locker for the Control Room, and the Azure Secret Body maps to the credential for the Control Room.

Automation credential example	Azure Prefix	Azure Secret Body	Secret in Azure	Control Room username
accounting_cv1 System credential in locker mapped to Azure Secret name prefix <code>accounting</code>	accounting	cv1	pdf-5f-cv1 (system)	None - system credential
accounting_cv1_ABCD\user123 User-defined credential in locker mapped to Azure prefix	accounting	cv1	pdf-5f-cv1-5f-ABCD--user123	ABCD\user123

When deploying Azure credentials, the Azure Key Vault character underscore (`_`) is a reserved character and cannot be used in credential names. You must substitute any underscore (`_`) usage with the ASCII code value `5f` bracketed by dashes:

This character	Changes to this ASCII code character substitution
\ (slash)	--

This character	Changes to this ASCII code character substitution
- (dash)	-2d-
_ (underscore)	-5f-
@ (ampersand)	-40-
. (period)	-2e-

Integrating CyberArk Password Vault with Automation 360

You can integrate Automation 360 to retrieve credentials from the CyberArk Password Vault. The credentials become resident within the CyberArk Password Vault where they are managed, rotated, and synchronized.

You integrate the Automation 360 Control Room by connecting it to the CyberArk Password Vault through the CyberArk Central Credential Provider (CCP) APIs. No additional licensing is required to integrate with the CyberArk Password Vault or use the CCP APIs.

Recommendation: We recommend that you control access to the CyberArk Password Vault through an IP address.

You can integrate Automation 360 with the CyberArk Password Vault using either of these deployments:

- Cloud
- On-Premises

The following diagram shows an Automation 360 Cloud deployment where the Control Room is hosted on AAI Cloud:

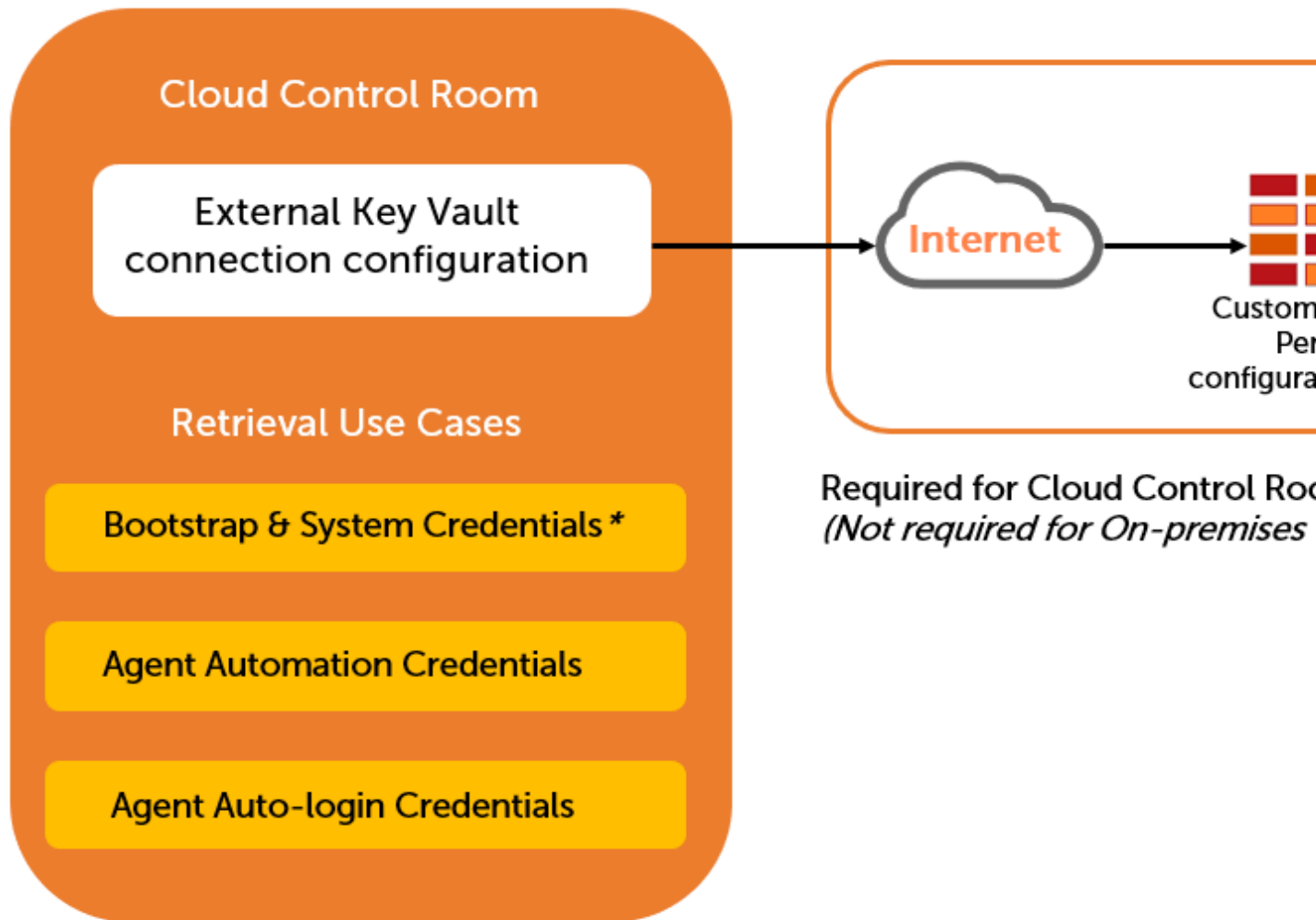

**On-premises only*

For On-Premises deployments, you deploy the following:

- Control Room as software within your customer environment.
- Bot Agent within your customer environment where automations run and access customer applications.

Important: You can edit the external key vault connection settings through the user interface in Cloud deployments only. External key vault settings in On-Premises deployments are only configurable during installation or with the key vault utility post-installation.

CyberArk Password Vault integration requirements

- [Install CyberArk Central Credential Provider](#)
- [Implement X.509 client certificate authentication method](#)
- [CyberArk Central Credential Provider API configuration requirements](#)
- [Review CyberArk Credential terminology and identifiers](#)
- [Define CyberArk application ID](#)
- [Provision accounts in CyberArk Password Vault](#)
- [Set up access to the application and password providers](#)

Install CyberArk Central Credential Provider

You must install and configure the CyberArk Central Credential Provider on the CyberArk server. See [CyberArk Central Credential Provider installation](#).

Implement X.509 client certificate authentication method

An X.509 client certificate is a type of digital certificate used by client systems to make authenticated requests to a remote server and uses the widely accepted international X.509 public key infrastructure (PKI) standard to verify that a public key belongs to the user, computer, or service identity contained within the certificate.

The Automation 360 Control Room uses a client certificate as the authentication method when connecting to the CyberArk CCP APIs.

This authentication method is highly secure and leverages the system's truststore to store the client certificate, server certificate, and private key. The truststore is a certificate storage location provided by the operating system's software and it contains the issuing Certificate Authority's (CA) certificate. You can import individual server certificates into the truststore. However it is more efficient to import the issuing Certificate Authority (CA) certificate.

The following image provides an overview of certificate-based authentication:

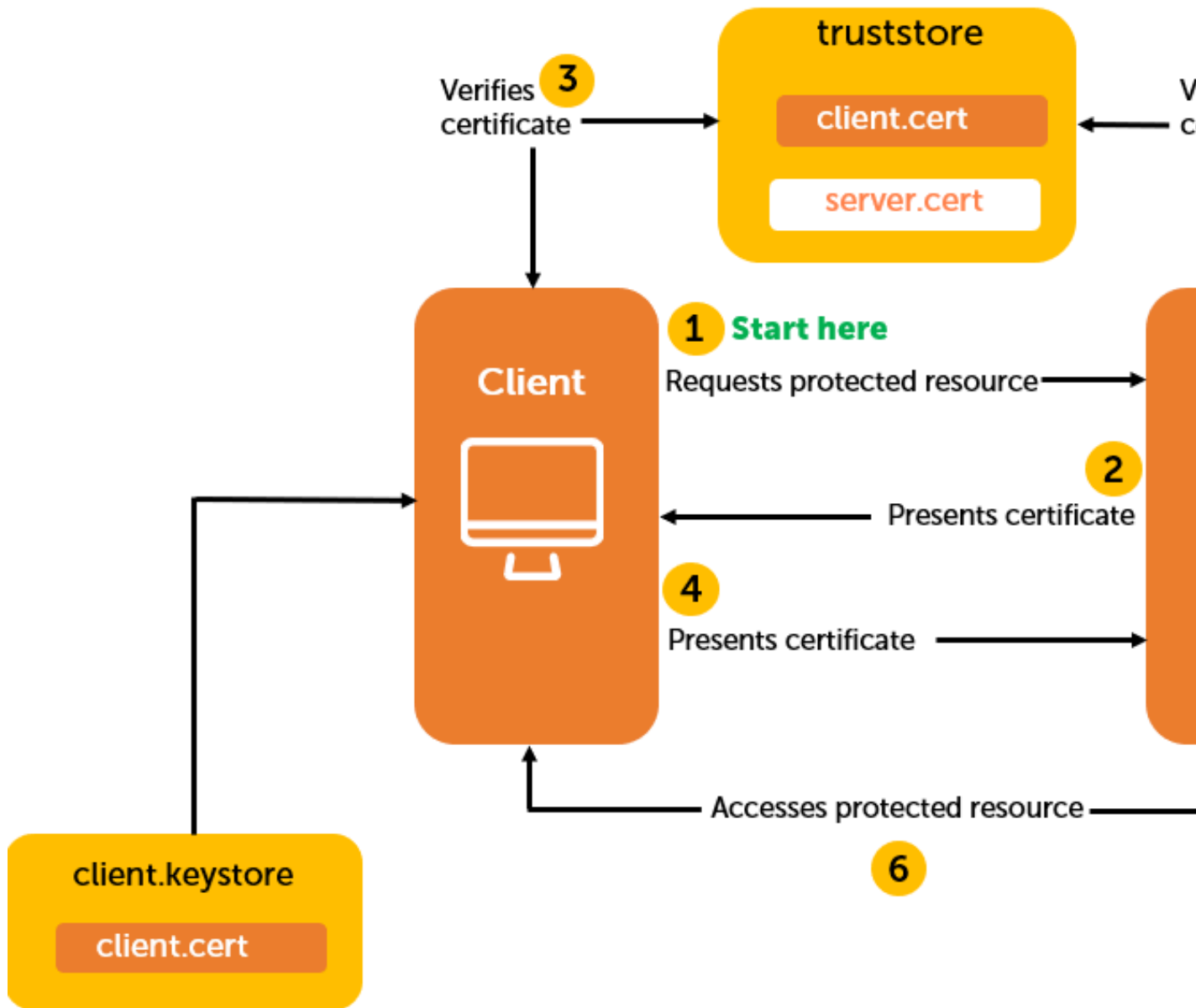

1. The client (Automation 360 Control Room) sends a request to the CyberArk AIM server (protected resource).
2. The server then responds by sending a certificate back to the client.
3. The Automation 360 Control Room verifies the certificate sent by the CyberArk AIM server by validating it against the trusted server certification information stored in the public part of the Control Room truststore.
4. After validating the information in the truststore, the Automation 360 Control Room resends the certificate back to the CyberArk AIM server.
5. The CyberArk AIM server then validates the certificate sent by Automation 360 Control Room against the trusted client certification information stored in the public part of the AIM server truststore

Because client certificates (those with their private key) are generally distributed in password protected format, the certificate file (using .p12 format, such as: `c:\PATH\aaeCyberArkCertificate.p12`) requires a passphrase.

6. Both parties (client and server) gain access to the protected resources if the certificates pass validation based on the following:
- The Control Room certificate must be trusted by the CyberArk AIM server
 - The Control Room must trust the certificate on the CyberArk AIM server
 - The Subject field in the certificate matches the calling system's Fully Qualified Domain Name (DNS Name)
 - The certificate has not expired

Important: As part of the integration planning phase, coordinate certificates and requests for certificates. You will have to request that certificates be issued by the Public Key Infrastructure (PKI) team before you can begin integration configuration. The certificate files are stored in the PKI folder and accessed with the Control Room passphrase when required. The Control Room passphrase is stored encrypted in the `keyvault.properties` file.

CyberArk Central Credential Provider API configuration requirements

You must have network connectivity between the Automation 360 Control Room and the CyberArk AIM server. The Automation 360 Control Room is connected to the CyberArk Password Vault through the CyberArk Central Credential Provider (CCP) APIs for both On-Premises or Cloud deployments.

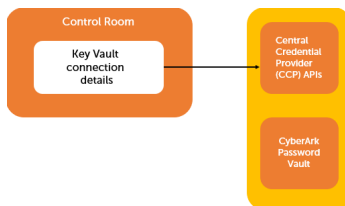

Note: No additional licensing is required to use the CCP APIs.

To use the CCP API, you must set these required parameters:

- Automation 360 v.20 (supports bootstrap credentials with On-Premises deployment only)
- Automation 360 v.21 or later (supports all bootstrap and system use cases for On-Premises deployments, auto-login, and automation credentials for both On-Premises and Cloud deployments)
- The Control Room Key Vault contains these connection details:
 - CCP API vault connection URL – For example: `https://<host:port>/AIMWebService/api/Accounts?`
 - CCP API AppID – You must configure the CyberArk AIM server with an Application ID (AppID). For example: `AACompanyControlRoom1`.

See [Define CyberArk application ID](#).

- X.509 client certificate with private key issued to the Automation 360 Control Room (The Control Room Fully Qualified Domain Name is in the Subject: field of the certificate) and configured with the CyberArk AIM server for authentication. For example: `c:\PATH\aaeCyberArkCertificate.p12`

Note: The `.p12` format is required.

Review CyberArk Credential terminology and identifiers

CyberArk and Automation Anywhere use different terminology to describe and identify credentials:

Description	CyberArk	Automation Anywhere
Where credentials are stored	object	credentials
Primary partitioning of the key vault	safe (contains objects)	locker (contains credentials)

- Credentials in CyberArk are stored in objects, and each object is contained in a safe. A single CyberArk instance can have multiple safes, where each safe has access controls for users.
- Credentials in Automation Anywhere are stored in lockers, where each locker has access controls for Control Room users.

CyberArk identifies credentials by safe name AND object name. The CCP API uses a CyberArk safe name and CyberArk object name to access credentials within the CyberArk Password Vault (the credential must exist in CyberArk).

The following is a code sample CCP API call and corresponding response:

```
https://<host:port>/AIMWebService/api/Accounts?
AppID=BillingApp&Query=Safe=Billing;Object=MonthlyBilling
```

Response

```
{
  "Content": "",
  "PolicyID": "CyberArk",
  "CreationMethod": "PVWA",
  "Folder": "Root",
  "Address": "address tbd",
  "Name": "Application-CyberArk-address tbd-vb",
  "Safe": "aa_vb_safe",
  "DeviceType": "Application",
  "UserName": "vb",
  "PasswordChangeInProgress": "False"
}
```

The credential value or secret (for example, the password) is stored in the `Content` attribute and the User ID (the Control Room user name, for example `vb`) is stored in the `UserName` attribute.

Define CyberArk application ID

Automation 360 integrates with CyberArk Password Vault through the CyberArk Central Credential Provider (CCP) API. The application ID (AppID) is a required configuration parameter.

As a CyberArk Administrator, use the CyberArk Password Vault Web Access (PVWA) interface to define the application ID by following the specified procedure to prepare the CyberArk AIM server for integration with the Control Room. See [CyberArk Password Vault Web Access](#).

1. You must log in as a user allowed to manage applications on the CyberArk platform (requires Manage Users authorization).
2. From the **Applications** tab, click **Add Application**.

3. From the **Add Application** panel, enter the following information:

Option	Action
Name	Specify the unique name (ID) of the application. We recommend using a name based on the Control Room name or function, for example: AACompanyControlRoom1.
Description	Enter a short application description used to help identify it.
Business owner	Enter contact information about the application's business owner.
Location	Select the application location in the Vault hierarchy. If a location is not selected, the application will be added in the same location as the user who is creating this application.

4. Click **Add** to add the new application and display it on the **Applications Details** page.
5. From the **Applications Details** page, select the **Allow extended authentication restrictions** check box to specify an unlimited number of machines and Windows domain OS users for a single application.

6. From the **Authentication** tab, click **Add** to add details to the new application.

A list of available authentication characteristics are displayed, which the Credential Provider uses to verify before retrieving the application password.

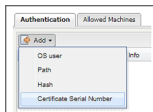

7. **Optional:** Select **OS user** and enter the name of the user who will run the application, and then click **Add** to add the OS user to the list of users in the **Authentication** tab.
8. Select **Certificate Serial Number** and enter the certificate serial number for the Control Room client certificate, and then click **Add**.
9. (Automation 360 recommended): From the **Allowed Machines** tab, click **Add**, and specify the IP/ host name/DNS address where the application is allowed to run and request passwords.

CyberArk AIM uses this address to ensure that only applications which run from specified machines can access their passwords.
10. Click **Add** to add the IP address to the list of allowed machines.

Provision accounts in CyberArk Password Vault

Before an application can function, you must give the application access to existing user accounts or to new user accounts to provision in the CyberArk Password Vault.

Use the Password Safe to provision the privileged user accounts required by the application. You can provision accounts using one of these methods:

- **Manually** add accounts one at a time, and then specify all the account details.
- **Automatically** add multiple accounts using the Password Upload feature. To add account automatically, you must have authorization to the **Add accounts** feature in the Password Safe.

For details about adding and managing privileged accounts, see [Privileged Access Manager - Self-Hosted](#).

Set up access to the application and password providers

After the user accounts have been provisioned by CyberArk, you must set up access to both the application and to CyberArk Application Password providers who are serving the application.

From where the Central Credential Provider is installed, add the provider user and application users as members of the Password Safes (where the application passwords are stored). You can add the users using one of these methods:

- Manually from the **Safes** tab
- By specifying the Safe names in the CSV file when adding multiple applications

To add users as safe members, from the **Add Safe Member** dialog box, add the provider as a safe member with these access authorizations selected, and then click **Add**:

- Retrieve accounts (Access)
- List accounts (Access)
- View Safe Members (Monitor)

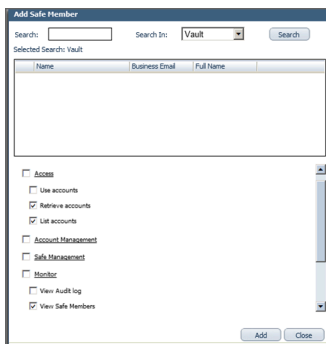

Note: When installing multiple providers for the CyberArk Password Vault integration, we recommend that you first create a group for them, and then add that group to the safe with the same selected access authorizations.

To add application (AppID) as a safe member, perform these steps:

1. From the **Add Safe Member** dialog box, add the (AppID) as a safe member with Retrieve accounts (Access) selected as the access authorization.
2. Click **Add**.

If the safe is configured for object level access, ensure that both the provider user and the application have access to the passwords to retrieve. For details about adding and managing privileged accounts, see [Privileged Access Manager - Self-Hosted](#).

On-Premises integration using CyberArk Password Vault

As an Automation 360 administrator, you can configure the CyberArk On-Premises integration using one of these methods: initial installation or post-installation using a command-line interactive key vault utility.

Within the On-Premises installation wizard, bootstrap credential retrieval from external key vault configuration options are only available if you first configure the key vault connection. The configuration options vary based on the external key vault you select.

Note: If you are using CyberArk in an Automation 360 Cloud deployment, then the CyberArk external key vault must be reachable from the Cloud Control Room through the network perimeter firewall rules. For external firewall rules configuration details, see [Automation 360 IP addresses for external integrations](#).

Choose your integration method:

- [Initial installation](#)
- [Post-installation using key vault utility](#)

On-Premises initial installation using CyberArk Password Vault

Using the initial installation method, you can connect and configure the external key vault connector, service account credential (Active Directory master password), and bootstrap (database) credential identifier.

Note: You must select Microsoft SQL Server Authentication as the database; other database authentication methods are not supported for this use case.

The initial installation supports a `password-less` installation regarding the Control Room bootstrap credentials. The password-less installation identifies the bootstrap credentials by the Safe name and Object name within CyberArk.

You can configure the SMTP and AD credential identifier to retrieve from the external key vault using the Automation 360 user interface.

1. After you start the Automation 360 installation wizard, select **On-premises** as the **Deployment Option** and click **Next**.
2. Accept the license agreement and click **Next**.
3. Select **Custom** as the **Installation Type Preference** and click **Next**.
4. Accept the default locations for the destination folders and click **Next**.

5. To connect and configure the external key vault integration, select **CyberArk**.

- a) In the **Vault URL** field, enter the CyberArk AIM server CCP API URL (for example: `https://<hostname>:<port_num>/`).

Note: To access the CCP APIs, the Control Room will automatically append `/AIMWebService/api/Accounts?` to the vault URL you enter. As a result, you must configure the Web Service on the CyberArk AIM server as `AIMWebService`.

- b) In the **Application ID** field, enter the CCP API AppID (for example: `AAEControlRoom`).
- c) Enter the path to the CyberArk AIM server certificate (in `.pem` format using `.p12`) issued to the Control Room server (The certificate Subject: field contains the Control Room fully qualified domain name (FQDN)).

This certificate must be trusted by and configured within CyberArk.

- d) Click **Upload Certificate** to store on the Automation 360 Control Room server.
- e) Enter the certificate file passphrase used to access the Control Room certificate file.
- f) Optional: If the issuing Certificate Authority (CA) of the CyberArk server certificate *is not* trusted by the Control Room, then enter an optional server certificate.

This is the server certificate for the CyberArk server without a private key (the certificate Subject: field contains the CyberArk AIM Server FQDN). The installer will add the optional CyberArk Server certificate to the truststore used by the Control Room.

- g) Click **Next**.

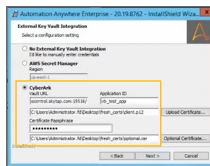

6. Accept the default settings from the **TLS Configuration** dialog box and click **Next**.

7. From the **Service Credentials** dialog box, select an option to specify the **Safe name** and **Object name** from CyberArk instead of manually entering the user name and password for the **Service Account** used by the Control Room.

8. Click **Service Account (retrieve credential from external key vault)**, and then enter the **Safe name** and **Object name** values.

The installer will query CyberArk for the credential to validate that the object exists in the specified safe.

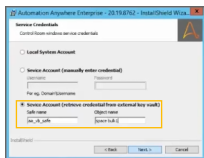

Note: If the **Service Account** option to specify **Safe name** and **Object name** is not available, then this indicates that the CyberArk Password Vault was not previously configured and connected properly as the external key vault. Contact your AAI Support team or review.

See also: [Troubleshooting external key vaults](#).

9. Click **Next**.

10. From the **Database Server** dialog box, select your **Database Server** and enter the name of your Control Room database, and then click **Next**.

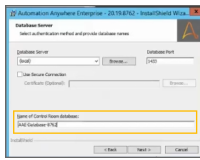

11. From the **Database Authentication** dialog box, select an option to specify the **Safe name** and **Object name** from CyberArk instead of manually entering the user name and password the Control Room uses to authenticate to the database.
- Click **SQL Server authentication (retrieve credential from external key vault)**, and then enter the **Safe name** and **Object name** values.

Note: Enter the same **Safe name** you previously entered for the **Service Account** safe name.

- Click **Next** to continue and complete the initial installation.

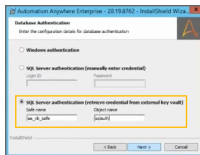

After you successfully complete the initial installation, the Automation 360 Control Room can access and retrieve credentials within the CyberArk Password Vault.

On-Premises post-installation using CyberArk Password Vault

You use the command-line interactive key vault utility during a **scheduled system downtime and you must stop all running Control Room services**. You should coordinate any key vault configuration changes that might impact connectivity parameters (such as App ID, vault URL, port numbers, and certificate) during downtimes with the CyberArk administrative team.

Note: If you use the key vault utility to disable CyberArk Password Vault integration, you must first unmap any mapped credentials that are in use.

Using the post-installation method, you can perform these actions:

- Modify or configure the external key vault connection parameters.
- (If not configured during initial installation) Modify or configure the service account credential (Active Directory master password).
- (If not configured during initial installation) Modify or configure the database (bootstrap) credential identifier (retrieved when authenticating the database).

Note: Retrieving bootstrap credentials from an external key vault might cause the Control Room to fail if the external key vault is not accessible during boot-up, or if the external key vault is not accessible when the Control Room refreshes database connections and authenticates users with Active Directory.

- Recover the Control Room for these reasons:
 - By modifying the external key vault connection parameters, the service account, and database credential safe and object identifiers.
 - If CyberArk Password Vault connection parameters changes caused the Control Room to experience connectivity issues.
 - When credential identifiers for bootstrap passwords change.

You can address any initial configuration settings that were not set correctly and recover the system.

You can configure and edit SMTP and AD credential identifiers to retrieve information from the external key vault from the Automation 360 Control Room by navigating to **Administration > Settings > Active Directory**.

1. Run the key vault utility for the CyberArk Password Vault

Note: You must import the CyberArk server certificate (the certificate issued to the CyberArk server) to the Java truststore before invoking the dB utility commands. The certificate can be in `.cer` (PEM) format and does not contain a private key.

To run the key vault utility and update key vault connection settings:

- As the Control Room administrator, access the Automation Anywhere Control Room installation directory that was created during the initial Automation 360 installation.
For example: `C:\Program Files\Automation Anywhere\Enterprise`
- Download the latest version of the key vault utility. To download the jar file used to update the directory, open a browser and access the A-People site: [A-People Downloads page \(Login required\)](#).

Note: If DB authentication is configured to use external key vault, the utility returns the following exception: Database currently configured to retrieve credentials from key vault. Update database authentication to WINDOWS/SQL to proceed further and exit.

The utility requests the user to confirm the action: Disable/update of key vault might impact functionalities using key vault (for example, Active Directory configuration, Email Settings configuration). Make sure to update these settings (if any). Are you sure you want to continue?

- Enter `y` to continue.
- Enter the following:

```
> jdk11\bin\java -jar certmgr.jar -appDir . -importTrustCert <Full path of the certificate>
```
- Add these `jvm` arguments to the command to run the key vault utility:
 - `-Djavax.net.ssl.trustStore="C:\Program Files\Automation Anywhere\Enterprise\pki\trust\store.ks"`
 - `-Djavax.net.ssl.trustStorePassword=changeit --module-path lib -jar crutils.jar -configPath "C:\Program Files\Automation Anywhere`

```
\Enterprise\config" -action [UPDATE_KEY_VAULT_CONFIGURATION or
UPDATE_DB_AUTHENTICATION_CONFIGURATION]
```

You can update either of these configuration actions:

- Enter `UPDATE_KEY_VAULT_CONFIGURATION` to edit the CyberArk key vault configuration.
- Enter `UPDATE_DB_AUTHENTICATION_CONFIGURATION` to change to database authentication using external key vault.

2. Based on which configuration action you used, choose the appropriate action:

- **Update key vault configuration for CyberArk:** If you entered `UPDATE_KEY_VAULT_CONFIGURATION` as the configuration action:
 - After the utility loads the current key vault configuration and properties, and this prompt is displayed: Enter key vault [AWS/CYBERARK/AZURE/NONE] :, enter `CYBERARK`
 - At the Please enter Vault URL: prompt, enter (for example): `https://services.uscentral.skytap.com:19516`
 - At the Please enter Application ID: prompt, enter (for example): `AAEControlRoom`
 - At the Please enter Certificate path: prompt, enter (for example): `C:\Users\Admin\Downloads\client_combined_cert_key_Adminat1234.p12`

Note: The client certificate issued to the Control Room for authenticating to CyberArk must be in `.p12` (pkcs#12) format with the private key.

 - At the Passphrase will not be displayed on the console Passphrase: prompt, enter your passphrase.

The key vault utility runs. If the configuration was successful (the utility was able to connect to the external key vault using the configured parameters), these messages are displayed on the console:

```
Connection configurations valid
Key Vault configurations successfully updated
```

- **Update database authentication for CyberArk:** If you entered `UPDATE_DB_AUTHENTICATION_CONFIGURATION` as the configuration action:
 - After the utility loads the current database configuration information, this prompt is displayed:

```
Database authentication configurations loaded
Currently configured database authentication [SQL]

Change database authentication. Available options:
WINDOWS: Connect to database using windows authentication
SQL: Connect to database using SQL server authentication, manually
enter username and password
KEY_VAULT: Connect to database using SQL server authentication,
retrieve username and password from external key Vault
```

```
Enter database authentication [WINDOWS/SQL/KEY_VAULT]:
```

Enter KEY_VAULT

- b. At the Please enter Safe name: prompt, enter (for example): aa_vb_safe
- c. At the Please enter Object name: prompt, enter (for example): Database-MSSql-administrator-admin

The key vault utility runs. If the database configuration was successful (the utility was able to connect to CyberArk, retrieve the designated credential and then use the credential to connect to the database), these messages are displayed on the console:

```
Database Credentials are valid
Database authentication configurations successfully updated
```

Cloud integration using CyberArk Password Vault

You connect and integrate the external CyberArk Password Vault to the Automation 360 Control Room.

The following image shows CyberArk Cloud integration with the Control Room:

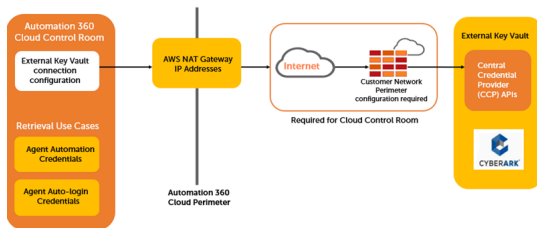

You must configure the customer network perimeter firewall to allow access to the `CyberArk_CCP_hostname:port` from the Automation 360 Cloud AWS NAT Gateway IP addresses.

The following table provides an example of how to configure the customer perimeter firewall:

From	To	Protocol used
Control Room in Automation 360 Cloud: Three AWS NAT Gateway IP addresses	CyberArk_CCP API_hostname:port For example: cyberarkpww.dev.abcd.com:4043	TLS Encrypted CCP API (TLS mutually authenticated)

For more details, see [Automation 360 IP addresses for external integrations](#).

For Cloud integrations, you can configure the Control Room and external key vault integration using the Automation 360 Control Room user interface.

The Agent auto-login and Agent automation use cases are only supported on Automation 360 Cloud Control Room instances. Neither of these use cases affect the Control Room boot sequence or Control Room functionality.

Note: Bootstrap and service account credential retrieval use cases are not supported on Cloud Control Room instances because the database and services are managed internally by Automation Anywhere.

There is no compliance use case (requirement) for these credentials to be stored in the customer external key vault.

1. Gather the specific CyberArk information required to configure the external key vault connector using the Automation 360 Control Room.

Item	Description
Vault URL	<p>The CyberArk AIM server CCP API URL (for example: <code>https://<hostname:port_num>/</code>)</p> <hr/> <p>Note: To access the CCP APIs, the Control Room will automatically append <code>/AIMWebService/api/Accounts?</code> to the vault URL you enter. As a result, you must configure the Web Service on the CyberArk AIM server as <code>AIMWebService</code></p>
Application ID	<p>The CCP API AppID (for example: <code>AAEControlRoom</code>).</p> <p>For details, see Define CyberArk application ID.</p>
Certificate file	<p>Enter the path to the client certificate issued to the Control Room server.</p> <p>This certificate file is a CyberArk authentication file (.p12 extension) that contains the certificate and its private key. CyberArk admins configure this file on the CyberArk server. After configuring the certificate file, it is used to authenticate every client request that is sent from the Automation 360 Cloud Control Room to the CyberArk server. For more information, see Choose a certificate file.</p> <p>The certificate will be issued to the Cloud Control Room (Subject: field of the certificate will contain fully qualified domain name (FQDN) of the Control Room) by the customer internal certificate authority.</p>
Certificate file password	A password used to open the certificate file.

Item	Description
Server certificate - PEM format	<p>(Required for Cloud integration): The server certificate without the private key of the CyberArk AIM server (Subject: field of the certificate will contain the FQDN of the CyberArk AIM server).</p> <p>This server certificate is a public certificate for the URL where CyberArk is hosted. This certificate is in the PEM text format and contains the Subject Alternative Names (SAN) on which the CyberArk is listening to requests. For more information, see CyberArk CACert.</p>

- Log in to the Automation 360 Control Room as the Administrator.
- From the Control Room, navigate to **Administration** > **Settings** > **External key vault** .
- Click the **Edit** icon to open the **Configuration settings** pane.
- Click **CyberArk** and then enter the specific CyberArk information described in the preceding table.
- Click **Save changes** to connect the external key vault.

CyberArk credential retrieval use cases

You can retrieve CyberArk credentials for these use cases: bootstrap, system, auto-login, and automations.

Retrieve Control Room bootstrap credentials with CyberArk

The Automation 360 Control Room uses bootstrap credentials to access supporting services such as database, service account, and Active Directory (AD). You configure these credentials during the initial On-Premises installation or post-installation (using the key vault utility) by specifying the safe name and object name.

The following images shows the process of retrieving the Control Room bootstrap credentials with CyberArk:

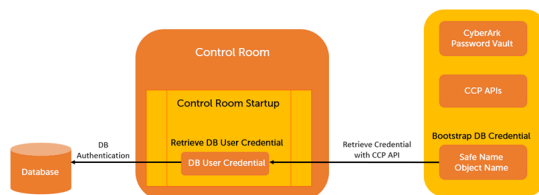

When required during the bootup sequence or normal operations (such as refreshing a service authentication), the Control Room uses the key vault connection to retrieve the credential and perform the required authentication.

Note: You must select the Microsoft SQL Server Authentication for this use case; other database authentication methods are not supported for bootstrap.

Retrieve Control Room system credentials with CyberArk

Note: You can configure the service account only during the initial installation.

If you configured an external key vault during the initial installation, you can then use the Automation 360 user interface (post-installation) to configure SMTP and Active Directory (AD) credentials.

1. Log in to the Automation 360 Control Room as the Administrator.
2. From the Control Room, navigate to: **Administration** > **Settings** > **Email Settings**.
3. You can map the AD Master Account credential from the external key vault, configure external credentials, or set to manual (switch modes of AD Master Account credential retrieval).

Retrieve auto-login credentials with CyberArk

Auto-login credentials are used to authenticate to an Automation 360 Bot Agent device and start an active Windows session. Robotic Process Automation (RPA) requires an active Windows session to function. Auto-login occurs prior to the automation running when automations are launched from a remote Bot Agent device.

The following image shows the process of retrieving the auto-login credentials with CyberArk:

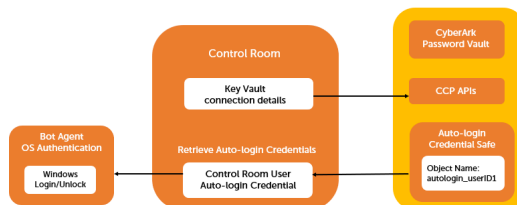

A Control Room administrator can manually launch or schedule a job to launch an automation on a Bot Agent device by specifying these details:

- Automation (bot) name
- Device name
- User context

The system performs auto-login to the specified device with the user name and password associated with the user context, and then runs the automation on the device.

To configure retrieval of auto-login credentials from the external key vault, perform these steps:

1. Log in to the Automation 360 Control Room as the Administrator.
2. From the Control Room, navigate to **Administration** > **Settings** > **Devices**.
3. Scroll down to the auto-login settings section and click **Edit**.
4. If you previously configured CyberArk as the external key vault connection, click **Enabled** to retrieve the auto-login credentials from that external key vault.

If this option is disabled, then the external key vault connection was not configured.

Note: If you disable auto-login from the external key vault, then credentials are retrieved using the AAI Credential Vault and its stored credentials instead.

5. Enter the Safe name (for example: AA_Auto-login_Safe).

The safe name you enter is also known as the *Auto-login Credential Safe*.

Note: You can only define a single safe to retrieve auto-login credentials, so all auto-login credentials must be in the designated safe.

6. Click **Save changes**.

If successful, then the auto-login settings successfully saved message is displayed.

CyberArk auto-login credential example

For this auto-login credential retrieval example, consider a Control Room user who wants to deploy a bot on a device as a specific user. This example uses the following details:

- Automation (bot) name run on a device = `ProcureToPayGeoEast`
- Agent device name = `WinVDI1138`
- Agent user context = `roboticworker2112@automation.abcd.com`

The following image shows this an example of retrieving auto-login credentials with CyberArk:

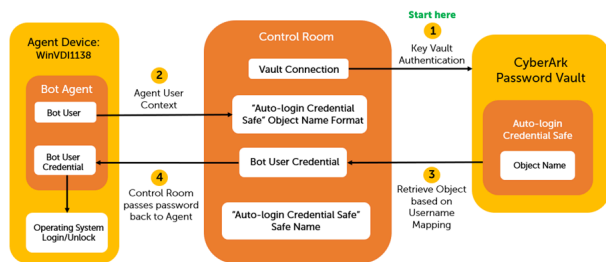

Before starting the automation, ensure the following:

1. The Control Room connection details have been successfully configured, and the Control Room uses these connection details to connect to CyberArk and performs authentication.
2. The Control Room queries the Bot Agent device running on device `WinVDI1138` to check if there is an active Windows (operating system) session currently on device `WinVDI1138`, and if that session belongs to Agent user `roboticworker2112`.
If there is an existing session on the device for user `roboticworker2112`, then there is no need to perform auto-login and the bot continues with the deployment.
3. However, if there is an no active session or if there is an active session that does not belong to `roboticworker2112`, then the Control Room retrieves the auto-login credential from the CyberArk Password Vault.
4. The Control Room passes the credential (password) to the Bot Agent. The Bot Agent performs a Windows login on device `WinVDI1138` as `roboticworker2112` (first, logging off any other user login session) using the auto-login credential for `roboticworker2112`. The automation (Bot) `ProcureToPayGeoEast` then starts to run on device `WinVDI1138` as `roboticworker2112`.

Retrieve automation credentials with CyberArk

Automation credentials are variables used by bot developers within automation (bot) actions that define and retrieve data from encrypted storage. The automation uses the credentials to authenticate to

applications (for example: finance application). Automation credentials are retrieved by the Automation 360 Bot Agent during runtime. Within CyberArk, a safe is a locker, and an object is a credential.

The following image shows the process of retrieving automation credentials with CyberArk:

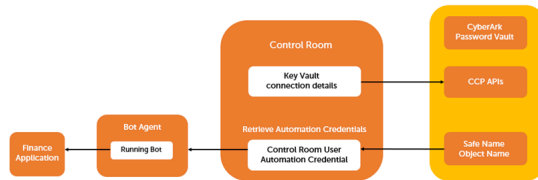

Automation credentials retrieved from the CyberArk Password Vault are mapped in the Automation Anywhere Credential Vault. The Credential Vault supports these two types of automation credentials:

System credentials

Credentials where the value returned by the credential variable is the same for any automation that uses that variable.

User-defined credentials

Credentials where the value returned by the credential variable is distinct based on the user context in which the automation is running.

For both system credentials and user-defined credentials, the bot developer specifies the same credential variable within the bot code. Then, the system determines which credential to retrieve during bot runtime.

User-defined credentials simplify automation development by enabling bot developers to write code using a single credential variable where the RPA platform substitutes the value returned during runtime with a unique user-specific value. Developers can avoid writing duplicate code with different user-specific credential variables.

The following image shows the relationship between the Automation Anywhere Credential Vault objects and the CyberArk credentials for system and user-defined credentials:

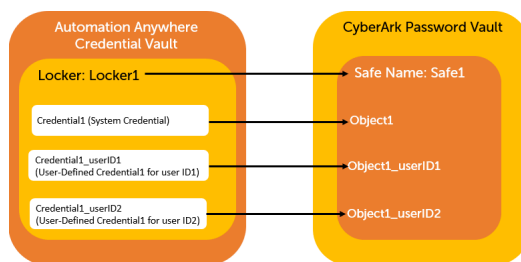

- The Control Room locker (`Locker1`) is mapped to the CyberArk safe name (`Safe1`).
- The Control Room system credential (`Credential1`) is mapped to the CyberArk object (`Object1`).

As an administrator, you create and configure a locker and credentials using the external key vault feature in the Automation 360 Control Room. Within the Control Room, an administrator maps the Automation Anywhere locker (`Locker1`) to a safe name (`Safe1`) and maps the credential (`Credential1`) to an object name (`Object1`). The credentials available to Control Room users are determined by what is configured in the external key vault (CyberArk Password Vault).

If you want to use user-defined credentials with the CyberArk integration, then the CyberArk administrator must create objects for each user-defined credential by naming those objects with the `Control Room_username` postfix. During runtime, the RPA platform retrieves the object name that is named with a postfix that matches the user context (user-defined credential) in which the automation is running. If there is no user-defined credential, then the RPA platform retrieves the object name without a username postfix (and uses the system credential).

Note: You can map any Automation Anywhere locker to any CyberArk Safe Name. However, any safe names you use to map automation credentials should be distinct from the safe names you use for auto-login.

As an administrator, you can use the access controls in the Automation 360 Control Room to separate access to credentials by providing users access to a locker. You control access to credentials by assigning different Control Room users to different roles and then associating different lockers with those roles. By mapping different CyberArk safes to different lockers, access to credentials in the CyberArk safes is mapped to and enforced by the access controls in the Control Room.

Note: The same permissions and privileges (assigned through roles) in the Control Room apply to credentials mapped to the external key vault.

CyberArk automations credentials retrieval example

To configure automation credentials retrieval and integrate with the CyberArk Password Vault, you first create a locker and then create credentials.

To create a locker to integrate with the CyberArk Password Vault, perform these steps:

1. From the Automation 360 Control Room, navigate to **Manage > Credential**.
A user with **Manage my credentials and lockers** permissions is authorized to create credentials.
2. From the **Credentials** tab, select **Create Locker**.
3. Enter a name for the locker.
This name is local to the Control Room and does not have any dependency on the CyberArk safe name.
4. Click **External Key Vault** and enter the CyberArk safe name in the **Safe name** field (for example: `Finance_Safe`).
5. Click **Next**.
6. Configure Owners, Managers, Participants, and Consumers for the locker.
7. Click **Create locker**.
See [Create locker](#).

The Control Room is now ready to retrieve credentials and enforce access controls on the mapped CyberArk safe. To continue, you now create the credentials.

To create a credential to integrate with the CyberArk Password Vault, perform these steps:

1. From the Automation 360 Control Room, navigate to **Manage > Credentials**.
A user with **Manage my credentials and lockers** permissions is authorized to create credentials.
2. From the **Credentials** tab, select **Create Credential**.
3. Enter the credential name in the **Credential name** field.
This name is local to the Control Room and does not have any dependency on the CyberArk safe name.
4. Click **External key vault** below the name field.
5. From the list of available lockers, select the appropriate locker that was previously mapped to the safe name for the credential you are now mapping to the object (credential).
6. Enter the CyberArk object name in the **Object name** field.

7. Click **Validate and retrieve attributes.**

The system validates the mapping by attempting to retrieve from the CyberArk Password Vault the combination of safe name (locker) and object name (credential). Within the safe name mapped to the locker, Automation 360 expects objects to use the correct naming conventions. . See [External key vault naming conventions](#).

If validation fails, then no object exists in the CyberArk Password Vault with the name that matches the combination of safe name (locker) and object name (credential).

When the system successfully retrieves the object details, it will display the CyberArk Password Vault object attributes (the fields within the secret).

8. From the list of attributes, select attributes to map to the credential.**9. Click **Create credential.****

If successful, then the credential successfully created message is displayed.

Integrating Azure Key Vault with Automation 360

You integrate the Automation 360 Control Room to retrieve credentials from the Azure Key Vault. The credentials become resident within the Azure Key Vault where they are managed, rotated, and synchronized.

You can integrate Automation 360 with the Azure Key Vault using either of these deployments:

- Cloud
- On-Premises

The following diagram shows an Automation 360 Cloud deployment where with Azure Key Vault:

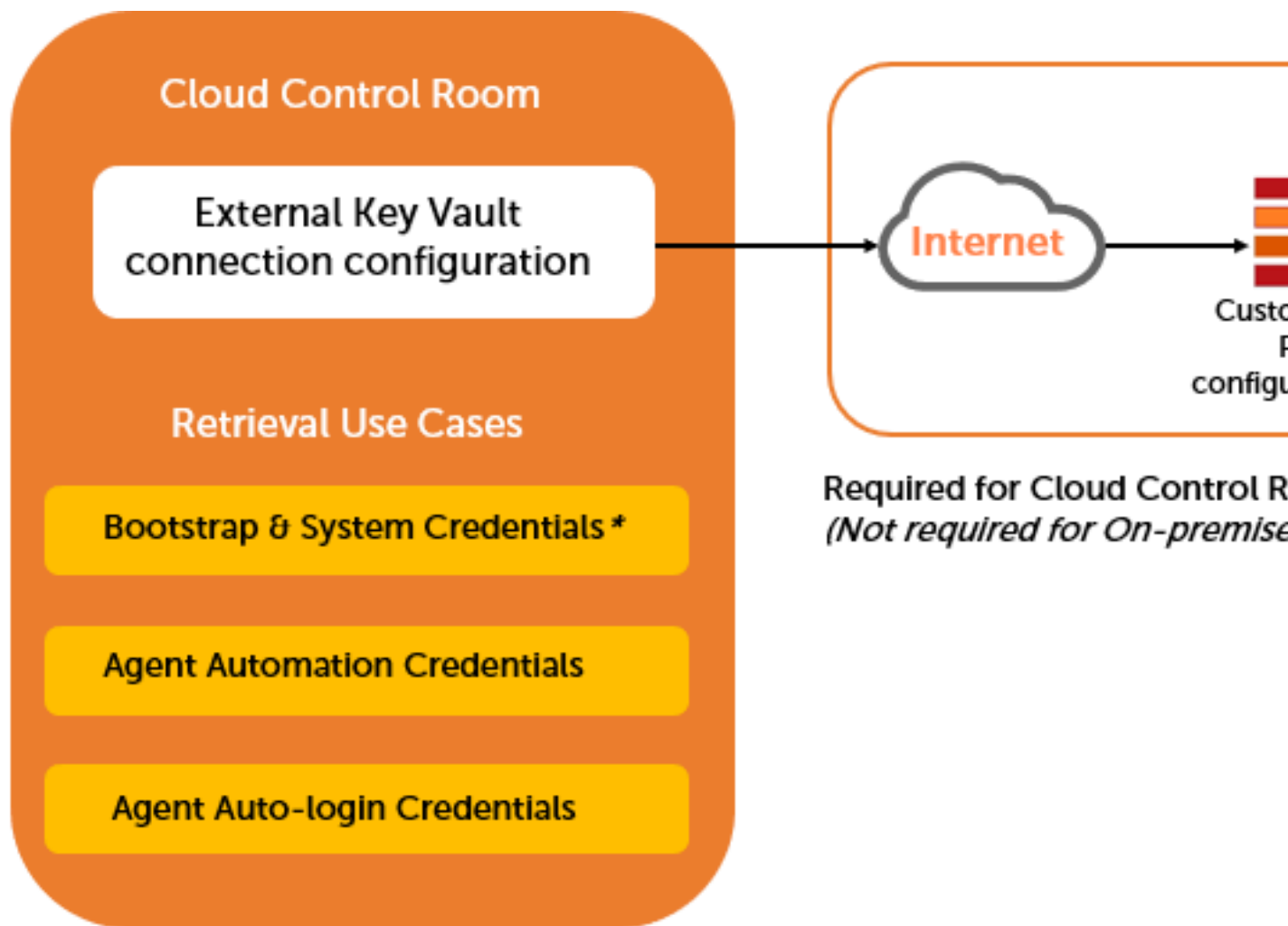

**On-premises only*

For On-Premises deployments, you deploy the following:

- Control Room as software within your customer environment.
- Bot Agent within your customer environment where automations run and access customer applications.

Important: You can edit the external key vault connection settings through the user interface in Cloud deployments only. External key vault settings in On-Premises deployments are only configurable during installation or with the key vault utility post-installation. Customers will need to ensure connectivity to the external key vaults from their On-Premises deployed Control Room instances.

On-Premises integration using Azure Key Vault

As an Automation 360 administrator, you can configure the Azure On-Premises integration using one of these methods: initial installation or post-installation using a command-line interactive key vault utility.

Within the On-Premises installation wizard, bootstrap credential retrieval from external key vault configuration options are only available if you first configure the key vault connection. The configuration options vary based on the external key vault you select.

Choose your integration method:

- [Initial installation](#)

- [Post-installation using key vault utility](#)

On-Premises initial installation using Azure Key Vault

Using the initial installation method, you can connect and configure the external key vault connector, service account credential (Active Directory master password), and bootstrap (database) credential identifier.

Note: You must select Microsoft SQL Server Authentication as the database; other database authentication methods are not supported for this use case.

You can configure the SMTP and AD credential identifier to retrieve from the external key vault using the Automation 360 user interface.

1. [Configure the Azure Key Vault requirements from the Microsoft Azure portal.](#)
2. [Integrate the Azure Key Vault and Automation 360 Control Room.](#)
3. [Set up the authentication type for Automation 360 Control Room users and Azure Key Vault.](#)

After you successfully complete the initial installation, the Automation 360 Control Room can access and retrieve credentials within the Azure Key Vault.

Configure Azure Key Vault requirements for initial installation

Before you can integrate the Automation 360 Control Room with the Azure Key Vault, you must configure Azure Key Vault requirements using the Microsoft Azure portal.

1. Sign in to the Microsoft Azure portal: [Azure portal](#)
2. Create a key vault in Azure.
See [Quickstart: Create a key vault using the Azure portal.](#)
3. From the Azure Home page, navigate to **Home > selected key vault**. Generate or import secrets for the use cases you will be using with the Azure Key Vault.
For example, if you will be using the bootstrap use case, you should generate a secret that contains the correct database credential that the Control Room will use to authenticate to the database.
4. Collect the following required Azure environment variables that must be set in the environment of the Control Room Server Microsoft operating system:
 - **AZURE_CLIENT_ID:** The client (application) ID of an App Registration in the tenant.
 - **AZURE_CLIENT_SECRET:** A client secret that was generated for the App Registration.
 - **AZURE_TENANT_ID:** The Azure Active Directory tenant (directory) ID.
5. After you set the environment variables in Azure, you must then add them to the Server Environment on the Automation 360 Control Room:

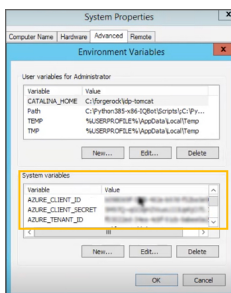

The Azure Key Vault has a flat name space with no organizational containers. There is no safe or locker within the Azure Key Vault and all credentials are stored together in the same container. Credentials are stored in objects which only have a secret name.

For RBAC policies and best practices, see [What is Azure RBAC?](#)

Integrate Azure Key Vault and Control Room

After you configured the Azure Key Vault requirements using the Microsoft Azure portal, you can integrate the Azure Key Vault and the Automation 360 Control Room.

1. After you start the Automation 360 installation wizard, select **On-premises** as the **Deployment Option** and click **Next**.
2. Accept the license agreement and click **Next**.
3. Select **Custom** as the **Installation Type Preference** and click **Next**.
4. Click **Change...** to change the destination folder of where to install Automation 360. Browse to select the folder destination you want and click **Next**.
5. To connect and configure the external key vault integration, select **Azure**.

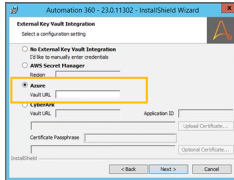

6. In the **Vault URL** field, enter the Azure Key Vault URL (for example: `https://user-db-vault.vault.azure.net/`).
7. Accept the default settings from the **TLS Configuration** dialog box and click **Next**.
8. From the **Service Credentials** dialog box, select an option to specify the **Azure Secret name** used by the Control Room and click **Next**.

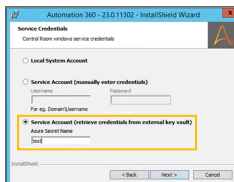

9. From the **Database Authentication** dialog box, select an option to specify the **Secret name** from Azure instead of manually entering the secret name the Control Room uses to authenticate to the database.

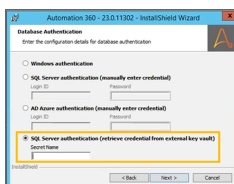

- a) Click **SQL Server authentication (retrieve credential from external key vault)**, and then enter the Azure **Secret Name** value.
- b) Click **Next** to continue and complete the initial installation.

After you successfully complete the initial installation, the Automation 360 Control Room can access and retrieve credentials within the Azure Key Vault.

Set up authentication type for Azure Key Vault

After you complete the initial installation and configure Azure Key Vault as the external key vault, you can set up the authentication type for Automation 360 Control Room users in the Initial Setup (this occurs directly after the initial installation completes).

1. From the **Authentication type for Control Room users** dialog box, click **Active Directory**.

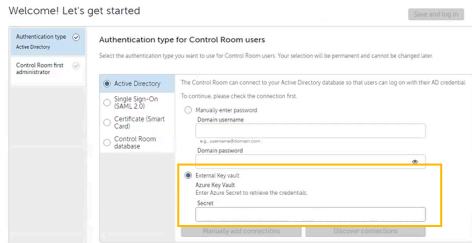

2. Optional: Configure the Active Directory integration credential (this is the credential that the Control Room uses to authenticate users with Active Directory) to be retrieved from Azure Key Vault. Click **External Key vault** and enter the Azure secret to retrieve credentials in the field (for example: userAD).
3. Click **Discover connections**. The available domains and sites display.
4. Click **Next** and continue to create the Control Room first admin. Save the Admin user information. The Control Room will attempt to retrieve the credential from the Azure Key Vault and then authenticate to the Domain Controller. If this fails, cause might be one of the following:
 - There is no secret with that name in the Azure Key Vault
 - There is a secret with that name, but it does not contain a username and password that is authorized for authentication with Active Directory

You can now log in to the Control Room as admin and add users and roles.

Note: The passwords within the Azure Key Vault are masked so ensure that you copy and save them after you create them.

On-Premises post-installation using Azure Key Vault

You use the command-line interactive key vault utility during a **scheduled system downtime and you must stop all running Control Room services**. You should coordinate any key vault configuration changes that might impact connectivity parameters (such as `AZURE_CLIENT_ID`, `AZURE_CLIENT_SECRET`, and `AZURE_TENANT_ID`) during downtimes with the Azure administrative team.

Note: If you use the key vault utility to disable Azure Key Vault integration, you must first unmap any mapped credentials that are in use.

Using the post-installation method, you can perform these actions:

- Modify or configure the external key vault connection parameters.
- (If not configured during initial installation) Modify or configure the service account credential (Active Directory master password).
- (If not configured during initial installation) Modify or configure the database (bootstrap) credential identifier (retrieved when authenticating the database).

Note: Retrieving bootstrap credentials from an external key vault might cause the Control Room to fail if the external key vault is not accessible during boot-up, or if the external key vault is not accessible when the Control Room refreshes database connections and authenticates users with Active Directory.

- Recover the Control Room for these reasons:

- By modifying the external key vault connection parameters, the service account, and database credential safe and object identifiers.
- If Azure Key Vault connection parameters changes caused the Control Room to experience connectivity issues.
- When credential identifiers for bootstrap passwords change.

You can address any initial configuration settings that were not set correctly and recover the system.

You can configure and edit SMTP and AD credential identifiers to retrieve information from the external key vault from the Automation 360 Control Room by navigating to **Administration > Settings > Active Directory**.

1. Run the key vault utility for the Azure Key Vault: To run the key vault utility and update key vault connection settings:

- a) As the Control Room administrator, access the Automation Anywhere Control Room installation directory that was created during the initial Automation 360 installation.
For example: `C:\Program Files\Automation Anywhere\Enterprise`
- b) Download the latest version of the key vault utility. To download the jar file used to update the directory, open a browser and access the A-People site: [A-People Downloads page \(Login required\)](#).

Note: If DB authentication is configured to use external key vault, the utility returns the following exception: Database currently configured to retrieve credentials from key vault. Update database authentication to WINDOWS/SQL to proceed further and exit.

The utility requests the user to confirm the action: Disable/update of key vault might impact functionalities using key vault (for example, Active Directory configuration, Email Settings configuration). Make sure to update these settings (if any). Are you sure you want to continue?

- c) Enter `Y` to continue.
- d) Enter the following:

```
> jdk11\bin\java -jar certmgr.jar -appDir . -importTrustCert <Full path of the certificate>
```
- e) Add these `jvm` arguments to the command to run the key vault utility:
 1. `-Djavax.net.ssl.trustStore="C:\Program Files\Automation Anywhere\Enterprise\pki\trust\store.ks"`
 2. `-Djavax.net.ssl.trustStorePassword=changeit --module-path lib -jar crutils.jar -configPath "C:\Program Files\Automation Anywhere\Enterprise\config" -action [UPDATE_KEY_VAULT_CONFIGURATION or UPDATE_DB_AUTHENTICATION_CONFIGURATION]`

You can update either of these configuration actions:

- Enter `UPDATE_KEY_VAULT_CONFIGURATION` to edit the Azure Key Vault configuration.
- Enter `UPDATE_DB_AUTHENTICATION_CONFIGURATION` to change to database authentication using external key vault.

2. Based on which configuration action you used, choose the appropriate action:

- **Update key vault configuration for Azure:** If you entered `UPDATE_KEY_VAULT_CONFIGURATION` as the configuration action:
 - a. After the utility loads the current key vault configuration and properties, and this prompt is displayed: `Enter key vault [AWS/CYBERARK/AZURE/NONE] :,` enter `AZURE`
 - b. At the `Please enter Vault URL:` prompt, enter (for example): `https://user-db-vault.vault.azure.net/`

The key vault utility runs. If the configuration was successful (the utility was able to connect to the external key vault using the configured parameters), these messages are displayed on the console:

```
Connection configurations valid
Key Vault configurations successfully updated
```

- **Update database authentication for Azure:** If you entered `UPDATE_DB_AUTHENTICATION_CONFIGURATION` as the configuration action:
 - a. After the utility loads the current database configuration information, this prompt is displayed:

```
Database authentication configurations loaded
Currently configured database authentication [SQL]

Change database authentication. Available options:
WINDOWS: Connect to database using windows authentication
SQL: Connect to database using SQL server authentication, manually
enter username and password
KEY_VAULT: Connect to database using SQL server authentication,
retrieve username and password from external key Vault

Enter database authentication [WINDOWS/SQL/KEY_VAULT]:
```

Enter `KEY_VAULT`

- b. At the `Please enter Secret name:` prompt, enter (for example): `testDB`

The key vault utility runs. If the database configuration was successful (the utility was able to connect to Azure, retrieve the designated credential and then use the credential to connect to the database), these messages are displayed on the console:

```
Database Credentials are valid
Database authentication configurations successfully updated
```

Cloud integration using Azure Key Vault

For Cloud integrations, you can configure the Control Room and external key vault integration using the Automation 360 Control Room user interface.

The Agent auto-login and Agent automation use cases are only supported on Automation 360 Cloud Control Room instances. Neither of these use cases affect the Control Room boot sequence or Control Room functionality.

Note: Bootstrap and service account credential retrieval use cases are not supported on Cloud Control Room instances because the database and services are managed internally by Automation Anywhere.

There is no compliance use case (requirement) for these credentials to be stored in the customer external key vault.

1. Gather the specific Azure information required to configure the external key vault connector using the Automation 360 Control Room.

Item	Description
AZURE_CLIENT_ID	The client (application) ID of an App Registration in the tenant.
AZURE_CLIENT_SECRET	A client secret that was generated for the App Registration.
AZURE_TENANT_ID	The Azure Active Directory tenant (directory) ID.
AZURE_CLIENT_CERTIFICATE_PATH	The path to a PEM certificate used during the authentication instead fo the client secret.

2. Log in to the Automation 360 Control Room as the Administrator.
3. From the Control Room, navigate to **Administration** > **Settings** > **External key vault** .
4. Click the **Edit** icon to open the **Configuration settings** pane.
5. Click **Azure** and then enter the specific Azure information described in the preceding table.
6. Click **Save changes** to connect the external key vault.

Azure credential retrieval use cases

You can retrieve Azure credentials for these use cases: bootstrap, system, auto-login, and automations.

Retrieve Control Room bootstrap credentials

Note: This use case applies to On-Premises deployments only.

The Automation 360 Control Room uses bootstrap credentials to access supporting services such as database, service account, and Active Directory (AD). You configure these credentials during the initial On-Premises installation or post-installation (using the key vault utility) by specifying the object name.

The following image shows the process of retrieving the Control Room bootstrap credentials with Azure:

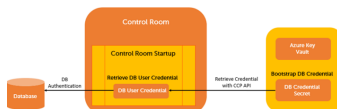

When required during the bootup sequence or normal operations (such as refreshing a service authentication), the Control Room uses the key vault connection to retrieve the credential and perform the required authentication.

Note: You must select the Microsoft SQL Server Authentication for this use case; other database authentication methods are not supported for bootstrap.

Retrieve Control Room system credentials

Note: This use case applies to On-Premises deployments only, and you can configure the service account only during the initial installation.

If you configured an external key vault during the initial installation, you can then use the Automation 360 user interface (post-installation) to configure SMTP and Active Directory (AD) credentials.

1. Log in to the Automation 360 Control Room as the Administrator.
2. From the Control Room, navigate to: **Administration** > **Settings** > **Email Settings**.
3. You can map the AD Master Account credential from the external key vault, configure external credentials, or set to manual (switch modes of AD Master Account credential retrieval).

Retrieve auto-login credentials

Note: This use case applies to both On-Premises and Cloud deployments.

Auto-login credentials are used to authenticate to an Automation 360 Bot Agent device and start an active Windows session. Robotic Process Automation (RPA) requires an active Windows session to function. Auto-login occurs prior to the automation running when automations are launched from a remote Bot Agent device.

The following image shows the process of retrieving the auto-login credentials with Azure:

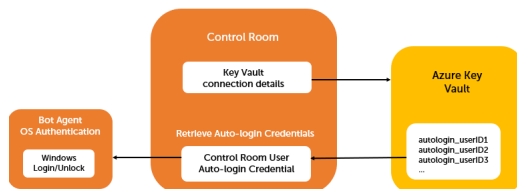

A Control Room administrator can manually launch or schedule a job to launch an automation on a Bot Agent device by specifying these details:

- Automation (bot) name
- Device name
- User context

The system performs auto-login to the specified device with the user name and password associated with the user context, and then runs the automation on the device.

You must have a secret for each Control Room user for whom the auto-login credentials will be retrieved from the external key vault, and the secret name in the Azure Key Vault **must match** the Control Room username.

To configure retrieval of auto-login credentials from the external key vault, perform these steps:

1. Log in to the Automation 360 Control Room as the Administrator.
2. From the Control Room, navigate to **Administration** > **Settings** > **Devices**.
3. Scroll down to the auto-login settings section and click **Edit**.

- If you previously configured Azure Key Vault as the external key vault connection, click **Enabled** to retrieve the auto-login credentials from that external key vault.

If this option is disabled, then the external key vault connection was not configured.

Note: If you disable auto-login from the external key vault, then credentials are retrieved using the AAI Credential Vault and its stored credentials instead.

- The Azure Key Vault has a flat name space without any organizational containers, so you do not need to enter a Safe name. Click **Save changes**.

If successful, then the auto-login settings successfully saved message displays.

Auto-login naming conventions

The Control Room retrieves auto-login credentials based on the object naming convention within the external key vault. The Control Room searches for an object where the object name (the credential name in the external key vault) matches the Control Room username for which it is performing auto-login.

The prefix `autologin_` is required as part of the naming convention for auto-login credentials for all external key vaults: CyberArk, AWS, and Azure. The name of the auto-login credential in the external key vault must contain `autologin_` followed by the Control Room username. In some cases, certain key vaults have restrictions on the characters that can be used in credential object names. Additionally, to support how different use cases encode credentials, Automation 360 requires that certain characters be reserved or encoded.

The following table lists examples of the object naming conventions expected in the Control Room:

Control Room username	Expected object name format
ABCD\user123	autologin_ABCD--user123
user123@rpa.abcd.com	autologin_user123-40-rpa-2e-abcd-2e-com

Note: For On-Premises customers using AD authentication, you must format auto-login usernames using the UPN format or `domain\username` postfix.

For auto-login credentials, keep these in mind:

- The object name in the external key vault must contain `autologin_` as a prefix.
- The auto-login credential names must map to the Control Room username (login ID) for the credential being retrieved.

Some external key vaults have usage restrictions of certain characters, such as backslash (\) and ampersand (@) in the secret name (object name), and restrictions on how special characters are interpreted within API calls. If the user ID contains special characters, then you must encode the secret name (object name) in the external key vault using ASCII code character substitutions, as listed in the following table.

This character	Changes to this ASCII code character substitution
\ (backslash)	--
- (dash)	-2d-
_ (underscore)	-5f-

This character	Changes to this ASCII code character substitution
@ (ampersand)	-40-
. (period)	-2e-

Note: Except for the backslash being mapped to double dashes, the dash, period, underscore, and ampersand are mapped using their ASCII code bracketed in dashes.

Azure auto-login credential example

For this auto-login credential retrieval example, consider a Control Room user who wants to deploy a bot on a device as a specific user. This example uses the following details:

- Automation (bot) name run on a device = `ProcureToPayGeoEast`
- Agent device name = `WinVDI1138`
- Agent user context = `rpouserCR1@abcd.com`

The following image shows this an example of retrieving auto-login credentials with Azure:

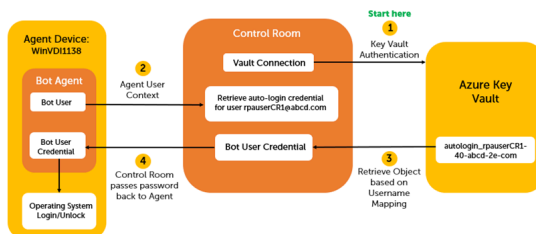

Before starting the automation, ensure the following:

1. The Control Room connection details have been successfully configured, and the Control Room uses these connection details to connect to Azure and performs authentication.
2. The Control Room queries the Bot Agent device running on device `WinVDI1138` to check if there is an active Windows (operating system) session currently on device `WinVDI1138`, and if that session belongs to Agent user `rpouserCR1`.

If there is an existing session on the device for user `rpouserCR1`, then there is no need to perform auto-login and the bot continues with the deployment.

3. However, if there is an no active session or if there is an active session that does not belong to `rpouserCR1`, then the Control Room retrieves the auto-login credential from the Azure Key Vault.
4. The Control Room passes the credential (password) to the Bot Agent. The Bot Agent performs a Windows login on device `WinVDI1138` as `rpouserCR1` (first, logging off any other user login session) using the auto-login credential for `rpouserCR1`. The automation (Bot) `ProcureToPayGeoEast` then starts to run on device `WinVDI1138` as `rpouserCR1`.

Retrieve automation credentials

Note: This use case applies to both On-Premises and Cloud deployments.

Automation credentials are variables used by bot developers within automation (bot) actions that define and retrieve data from encrypted storage. The automation uses the credentials to authenticate to applications (for example: finance application). Automation credentials are retrieved by the Automation 360 Bot Agent during runtime.

The following image shows the process of retrieving automation credentials with Azure:

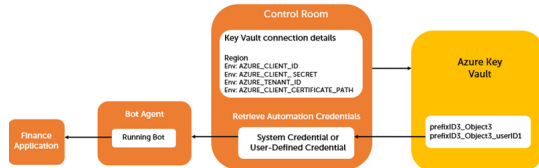

Automation credentials retrieved from the Azure Key Vault are mapped in the Automation Anywhere Credential Vault. The Credential Vault supports these two types of automation credentials:

System credentials

Credentials where the value returned by the credential variable is the same for any automation that uses that variable.

User-defined credentials

Credentials where the value returned by the credential variable is distinct based on the user context in which the automation is running.

For both system credentials and user-defined credentials, the bot developer specifies the same credential variable within the bot code. Then, the system determines which credential to retrieve during bot runtime.

User-defined credentials simplify automation development by enabling bot developers to write code using a single credential variable where the RPA platform substitutes the value returned during runtime with a unique user-specific value. Developers can avoid writing duplicate code with different user-specific credential variables.

The following image shows the expected naming convention for Azure credentials:

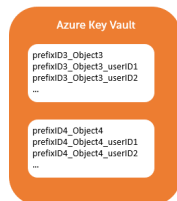

The diagram shows six secrets in the Azure Key Vault which can be mapped to two credentials within the Control Room Credential Vault

- Object3
- Object4

For example, you can map a locker in the Control Room to either `prefixID3` or `prefixID4`. Then, you map the secret to a credential. For each credential, the secrets will be consumed (retrieved by the Control Room) as a system-defined credential (without username postfix) and two user-defined credentials (one each for the Control Room users whose usernames are `User1ID1` and `User1ID2`).

Note: Within the Control Room Credential Vault, the name of the locker and the name of the credential are arbitrary and local to the Control Room. You map these names to specific secrets in the external key vault.

Within Azure Key Vault, each automation credential is stored with a name that contains specific identifiers including: a prefix, object identifier, and an optional postfix which identifies a username. This is a required naming convention that assures retrieval of the correct credential. The name of the secret (the credential)

in Azure Key Vault encodes information about the mapping within the Automation Anywhere Credential Vault.

As an administrator, to map a Control Room to Azure Key Vault, you create and configure a locker and a credential using the external key vault option within the **Create Locker** and **Create Credential** features in the Automation 360 Control Room:

- You configure a locker in the Credential Vault to map to an Azure secret name prefix.
- You configure credentials in the Credential Vault that map to an Azure secret object identifier (optional postfix for user-defined credential).

During runtime, the RPA platform retrieves the secret that is named with a postfix that matches the user context (user-defined credential) in which the automation is running. If there is no user-defined credential, then the RPA platform retrieves the secret without a username postfix (system credential).

The Control Room implements access controls to the external credentials through permissions within roles. You control access to credentials by assigning different Control Room users to different roles and then associating different lockers with those roles.

The following image shows the Control Room Credential Vault locker and credential mapped to an Azure secret:

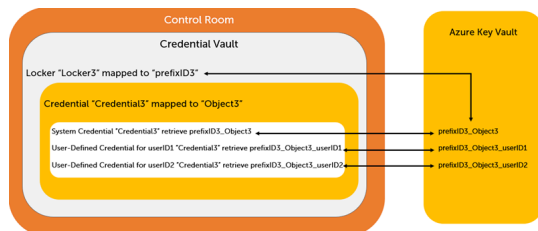

Important: When creating an externally mapped credential, you must place the credential in the appropriate externally mapped locker (the locker is mapped to the prefix in the secret name). The Azure secret name will have a naming convention: `Prefix + Secret_Name_Body + Postfix` (optional for user-defined credentials).

Note: The same permissions and privileges (assigned through roles) in the Control Room apply to credentials mapped to the external key vault.

Automation naming conventions

The following table shows Azure Key Vault external key vault examples using naming conventions for automation.

Note: The Azure Prefix maps to the locker for the Control Room, and the Azure Secret Body maps to the credential for the Control Room.

Automation credential example	Azure Prefix	Azure Secret Body	Secret in Azure	Control Room username
accounting_cv1 System credential in locker mapped to Azure Secret name prefix accounting	accounting	cv1	pdf-5f-cv1 (system)	None - system credential
accounting_cv1_ABCD\user123 User-defined credential in locker mapped to Azure prefix	accounting	cv1	pdf-5f-cv1-5f-ABCD--user123	ABCD\user123

When deploying Azure credentials, the Azure Key Vault character underscore (`_`) is a reserved character and cannot be used in credential names. You must substitute any underscore (`_`) usage with the ASCII code value `5f` bracketed by dashes:

This character	Changes to this ASCII code character substitution
\ (slash)	--
- (dash)	-2d-
_ (underscore)	-5f-
@ (ampersand)	-40-
. (period)	-2e-

Azure automations credentials retrieval example

To configure automation credentials retrieval and integrate with the Azure Key Vault, you first create a locker and then create credentials.

To create a locker to integrate with the Azure Key Vault, perform these steps:

- From the Automation 360 Control Room, navigate to **Manage > Credential**.
A user with **Manage my credentials and lockers** permissions is authorized to create credentials.
- From the **Credentials** tab, select **Create Locker**.
- Enter a name for the locker (for example, `Locker3`).
This name is local to the Control Room and does not have any dependency on the Azure secret name.
- Click **External Key Vault** and enter the Azure secret name prefix (for example: `prefixID3`). You must name secrets within the Azure Key Vault using the name prefix for the configuration of the mapping to complete successfully.
- Click **Next**.
- Configure Owners, Managers, Participants, and Consumers for the locker.

7. Click **Create locker**.

See [Create locker](#).

The Control Room is now ready to retrieve credentials and enforce access controls on all Azure secrets with the prefix `prefixID3`. To continue, you now create the credentials.

To create a credential to integrate with the Azure Key Vault, perform these steps:

1. From the Automation 360 Control Room, navigate to **Manage > Credentials** .

A user with **Manage my credentials and lockers** permissions is authorized to create credentials.

2. From the **Credentials** tab, select **Create Credential**.

3. Enter the credential name in the **Credential name** field.

This name is local to the Control Room and does not have any dependency on the Azure secret name.

4. Click **External key vault** below the name field.

5. From the list of available lockers, select the appropriate locker that was previously mapped to the secret name prefix for the secrets you are now mapping to the credential.

6. Enter the Azure `Secret_Name_Body` in the **Secret name** field (for example: `Object3`).

7. Click **Validate and retrieve attributes**.

The system validates the mapping by attempting to retrieve from the Azure Key Vault a secret with the name `Prefix_Secret_Name_Body` (for example: `prefixID3_Object3`).

If validation fails, then no secret exists in the Azure Key Vault with the name that matches the combination of locker (prefix) and credential (`Secret_Name_Body`). In this example, there is no secret in the Azure Key Vault named `prefixID3_Object3`.

When the system successfully retrieves the secret, it will display the Azure Key Vault secret attributes (the fields within the secret).

8. From the list of attributes, select attributes to map to the credential.

9. Click **Create credential**.

If successful, then the credential successfully created message displays.

Integrating AWS Secrets Manager with Automation 360

You integrate the Automation 360 Control Room to retrieve credentials from the AWS Secrets Manager. The credentials become resident within the AWS Secrets Manager where they are managed, rotated, and synchronized.

You can integrate Automation 360 with the [AWS Secrets Manager](#) using either of these deployments:

- Cloud
- On-Premises

The following diagram shows an Automation 360 Cloud deployment where with AWS Secrets Manager:

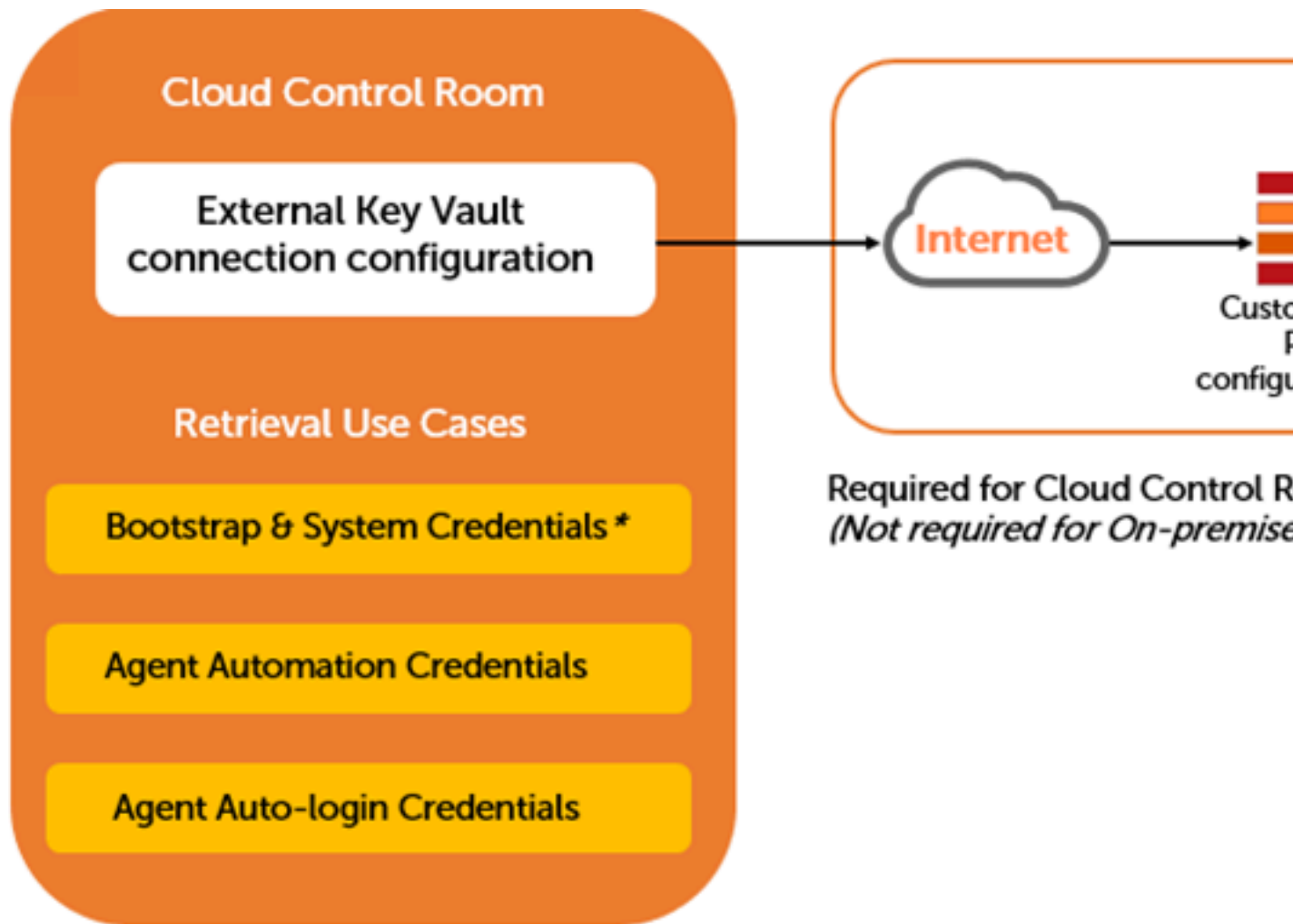

**On-premises only*

For On-Premises deployments, you deploy the following:

- Control Room as software within your customer environment.
- Bot Agent within your customer environment where automations run and access customer applications.

Important: You can edit the external key vault connection settings through the user interface in Cloud deployments only. External key vault settings in On-Premises deployments are only configurable during installation or with the key vault utility post-installation. Customers will need to ensure connectivity to the external key vaults from their On-Premises deployed Control Room instances.

On-Premises integration using AWS Secrets Manager

As an Automation 360 administrator, you can configure the AWS On-Premises integration using one of these methods: initial installation or post-installation using a command-line interactive key vault utility.

Within the On-Premises installation wizard, bootstrap credential retrieval from external key vault configuration options are only available if you first configure the key vault connection. The configuration options vary based on the external key vault you select.

Choose your integration method:

- [Initial installation](#)

- [Post-installation using key vault utility](#)

On-Premises initial installation using AWS Secrets Manager

Using the initial installation method, you can connect and configure the external key vault connector, service account credential (Active Directory master password), and bootstrap (database) credential identifier.

Note: You must select Microsoft SQL Server Authentication as the database; other database authentication methods are not supported for this use case.

You can configure the SMTP and AD credential identifier to retrieve from the external key vault using the Automation 360 user interface.

1. [Configure the AWS Secrets Manager requirements](#) from the AWS Administrative Console.
2. [Integrate the AWS Secrets Manager and Automation 360 Control Room.](#)
3. [Set up the authentication type for Automation 360 Control Room](#) users and the AWS Secrets Manager.

After you successfully complete the initial installation, the Automation 360 Control Room can access and retrieve credentials within the AWS Secrets Manager.

Configure AWS Secrets Manager requirements for initial installation

Before you can integrate the Automation 360 Control Room with the AWS Secrets Manager, you must configure AWS Secrets Manager requirements using the AWS Administrative Console.

1. Use the AWS Administrative Console to collect these AWS environment variables which you must set in the environment of the Control Room Server Microsoft Operating System:
 - **AWS_ACCESS_KEY_ID**
 - **AWS_SECRET_ACCESS_KEY**
 - **AWS_SESSION_TOKEN**



2. After you set the environment variables in AWS, you must then add them to the Server Environment

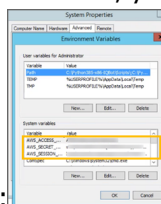

on the Automation 360 Control Room:

The AWS Secrets Manager has a flat name space with no organizational containers. There is no safe or locker within the AWS Secrets Manager and all credentials are stored together in the same container. Credentials are stored in objects which only have a secret name.

Integrate AWS Secrets Manager and Control Room

After you configured the AWS Secrets Manager requirements using the AWS Administrative Console, you can integrate the AWS Secrets Manager and the Automation 360 Control Room.

1. After you start the Automation 360 installation wizard, select **On-premises** as the **Deployment Option** and click **Next**.
2. Accept the license agreement and click **Next**.

3. Select **Custom** as the **Installation Type Preference** and click **Next**.
4. Accept the default locations for the destination folders and click **Next**.
5. To connect and configure the external key vault integration, select **AWS Secret**

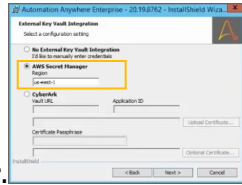

Manager.

6. In the **Region** field, enter the AWS region code (for example: `us-east1`) and click **Next**.
7. Accept the default settings from the **TLS Configuration** dialog box and click **Next**.
8. Accept the default settings from the **Service Credentials** dialog box, and click **Next**.
9. From the **Database Authentication** dialog box, select an option to specify the **Secret name** from AWS instead of manually entering the secret name the Control Room uses to authenticate to the

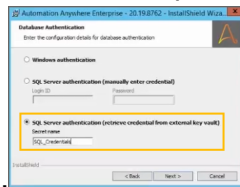

database.

- a) Click **SQL Server authentication (retrieve credential from external key vault)**, and then enter the **Secret Name** value.
- b) Click **Next** to continue and complete the initial installation. The installer will query AWS Secrets Manager for the credential to validate that the secret exists.

After you successfully complete the initial installation, the Automation 360 Control Room can access and retrieve credentials within the AWS Secrets Manager.

Set up authentication type for AWS Secrets Manager

After you complete the initial installation and configure AWS Secrets Manager as the external key vault, you can set up the authentication type for Automation 360 Control Room users in the Initial Setup (this occurs directly after the initial installation completes).

1. From the **Authentication type for Control Room users** dialog box, click **Active**

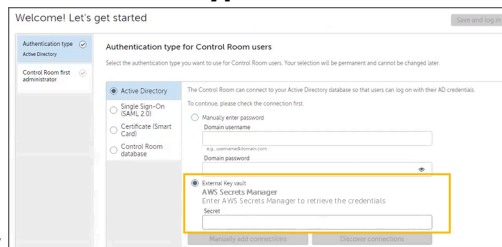

Directory.

2. You can optionally configure the Active Directory integration credential (this is the credential that the Control Room uses to authenticate users with Active Directory) to be retrieved from AWS Secrets Manager. Click **External Key vault** and enter the AWS secret to retrieve credentials in the field (for example: `userAD`). The Control Room will attempt to retrieve the credential from the AWS Secrets Manager and then authenticate to the Domain Controller. If this fails either:

- There is no secret with that name in AWS Secrets Manager, or
- There is a secret with that name, but it does not contain a username and password that is authorized for authentication with Active Directory.

3. Click **Discover connections**. The available domains and sites display.

4. Click **Next** and continue to create the Control Room first admin. Save the Admin user information.

You can now log in to the Control Room as admin and add users and roles.

On-Premises post-installation using AWS Secrets Manager

You use the command-line interactive key vault utility during a **scheduled system downtime and you must stop all running Control Room services**. You should coordinate any key vault configuration changes that might impact connectivity parameters (such as `AWS_ACCESS_KEY_ID`, `AWS_SECRET_ACCESS_KEY`, and `AWS_SESSION_TOKEN`) during downtimes with the AWS administrative team.

Note: If you use the key vault utility to disable AWS Secrets Manager integration, you must first unmap any mapped credentials that are in use.

Using the post-installation method, you can perform these actions:

- Modify or configure the external key vault connection parameters.
- (If not configured during initial installation) Modify or configure the service account credential (Active Directory master password).
- (If not configured during initial installation) Modify or configure the database (bootstrap) credential identifier (retrieved when authenticating the database).

Note: Retrieving bootstrap credentials from an external key vault might cause the Control Room to fail if the external key vault is not accessible during boot-up, or if the external key vault is not accessible when the Control Room refreshes database connections and authenticates users with Active Directory.

- Recover the Control Room for these reasons:

- By modifying the external key vault connection parameters, the service account, and database credential safe and object identifiers.
- If AWS Secrets Manager connection parameters changes caused the Control Room to experience connectivity issues.
- When credential identifiers for bootstrap passwords change.

You can address any initial configuration settings that were not set correctly and recover the system.

You can configure and edit SMTP and AD credential identifiers to retrieve information from the external key vault from the Automation 360 Control Room by navigating to **Administration > Settings > Active Directory**.

1. Run the key vault utility for the AWS Secrets Manager: To run the key vault utility and update key vault connection settings:

- a) As the Control Room administrator, access the Automation Anywhere Control Room installation directory that was created during the initial Automation 360 installation.
For example: `C:\Program Files\Automation Anywhere\Enterprise`
- b) Download the latest version of the key vault utility. To download the jar file used to update the directory, open a browser and access the A-People site: [A-People Downloads page \(Login required\)](#).

Note: If DB authentication is configured to use external key vault, the utility returns the following exception: `Database currently configured to retrieve credentials from key vault. Update database authentication to WINDOWS/SQL to proceed further and exit.`

The utility requests the user to confirm the action: `Disable/update of key vault might impact functionalities using key vault (for example, Active Directory`

configuration, Email Settings configuration). Make sure to update these settings (if any). Are you sure you want to continue?

c) Enter `Y` to continue.

d) Enter the following:

```
> jdk11\bin\java -jar certmgr.jar -appDir . -importTrustCert <Full path of the certificate>
```

e) Add these `jvm` arguments to the command to run the key vault utility:

1. `-Djavax.net.ssl.trustStore="C:\Program Files\Automation Anywhere\Enterprise\pki\trust\store.ks"`
2. `-Djavax.net.ssl.trustStorePassword=changeit --module-path lib -jar crutils.jar -configPath "C:\Program Files\Automation Anywhere\Enterprise\config" -action [UPDATE_KEY_VAULT_CONFIGURATION or UPDATE_DB_AUTHENTICATION_CONFIGURATION]`

You can update either of these configuration actions:

- Enter `UPDATE_KEY_VAULT_CONFIGURATION` to edit the AWS Secrets Manager configuration.
- Enter `UPDATE_DB_AUTHENTICATION_CONFIGURATION` to change to database authentication using external key vault.

2. Based on which configuration action you used, choose the appropriate action:

- **Update key vault configuration for AWS:** If you entered `UPDATE_KEY_VAULT_CONFIGURATION` as the configuration action:
 - a. After the utility loads the current key vault configuration and properties, and this prompt is displayed: `Enter key vault [AWS/CYBERARK/AZURE/NONE] :,` enter `AWS`
 - b. At the `Please enter Vault URL:` prompt, enter (for example): `https://services.uscentral.skytap.com:19516`

The key vault utility runs. If the configuration was successful (the utility was able to connect to the external key vault using the configured parameters), these messages are displayed on the console:

```
Connection configurations valid
Key Vault configurations successfully updated
```

- **Update database authentication for AWS:** If you entered `UPDATE_DB_AUTHENTICATION_CONFIGURATION` as the configuration action:
 - a. After the utility loads the current database configuration information, this prompt is displayed:

```
Database authentication configurations loaded
Currently configured database authentication [SQL]

Change database authentication. Available options:
WINDOWS: Connect to database using windows authentication
SQL: Connect to database using SQL server authentication, manually
enter username and password
KEY VAULT: Connect to database using SQL server authentication,
retrieve username and password from external key Vault
```

```
Enter database authentication [WINDOWS/SQL/KEY_VAULT]:
```

```
Enter KEY_VAULT
```

- b. At the Please enter Secret name: prompt, enter (for example): testDB

The key vault utility runs. If the database configuration was successful (the utility was able to connect to AWS, retrieve the designated credential and then use the credential to connect to the database), these messages display on the console:

```
Database Credentials are valid
Database authentication configurations successfully updated
```

Cloud integration using AWS Secrets Manager

For Cloud integrations, you can configure the Control Room and external key vault integration using the Automation 360 Control Room user interface.

The Agent auto-login and Agent automation use cases are only supported on Automation 360 Cloud Control Room instances. Neither of these use cases affect the Control Room boot sequence or Control Room functionality.

Note: Bootstrap and service account credential retrieval use cases are not supported on Cloud Control Room instances because the database and services are managed internally by Automation Anywhere. There is no compliance use case (requirement) for these credentials to be stored in the customer external key vault.

1. Gather the specific AWS information required to configure the external key vault connector using the Automation 360 Control Room.

Item	Description
AWS_ACCESS_KEY_ID	The AWS environment variable that specifies an AWS access key associated with an IAM user or role.
AWS_SECRET_ACCESS_KEY	The AWS environment variable that specifies the secret key associated with the access key.
AWS_SESSION_TOKEN	The AWS environment variable that specifies the session token value that is required if you use temporary security credentials retrieved directly from AWS operations.
Region	A separate geographic area that AWS uses to house its infrastructure.

2. Log in to the Automation 360 Control Room as the Administrator.
3. From the Control Room, navigate to **Administration > Settings > External key vault**.
4. Click the **Edit** icon to open the **Configuration settings** pane.
5. Click **AWS** and then enter the specific AWS information described in the preceding table.
6. Click **Save changes** to connect the external key vault.

AWS credential retrieval use cases

You can retrieve AWS credentials for these use cases: bootstrap, system, auto-login, and automations.

Retrieve Control Room bootstrap credentials

Note: This use case applies to On-Premises deployments only.

The Automation 360 Control Room uses bootstrap credentials to access supporting services such as database, service account, and Active Directory (AD). You configure these credentials during the initial On-Premises installation or post-installation (using the key vault utility) by specifying the object name.

The following image shows the process of retrieving the Control Room bootstrap credentials with AWS:

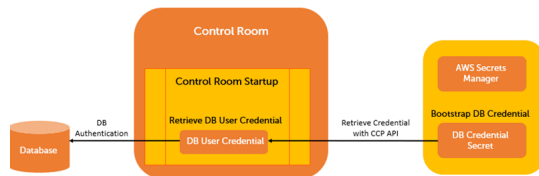

When required during the bootup sequence or normal operations (such as refreshing a service authentication), the Control Room uses the key vault connection to retrieve the credential and perform the required authentication.

Note: You must select the Microsoft SQL Server Authentication for this use case; other database authentication methods are not supported for bootstrap.

Retrieve Control Room system credentials

Note: This use case applies to On-Premises deployments only, and you can configure the service account only during the initial installation.

If you configured an external key vault during the initial installation, you can then use the Automation 360 user interface (post-installation) to configure SMTP and Active Directory (AD) credentials.

1. Log in to the Automation 360 Control Room as the Administrator.
2. From the Control Room, navigate to: **Administration** > **Settings** > **Email Settings**.
3. You can map the AD Master Account credential from the external key vault, configure external credentials, or set to manual (switch modes of AD Master Account credential retrieval).

Retrieve auto-login credentials

Note: This use case applies to both On-Premises and Cloud deployments.

Auto-login credentials are used to authenticate to an Automation 360 Bot Agent device and start an active Windows session. Robotic Process Automation (RPA) requires an active Windows session to function. Auto-login occurs prior to the automation running when automations are launched from a remote Bot Agent device.

The following image shows the process of retrieving the auto-login credentials with AWS:

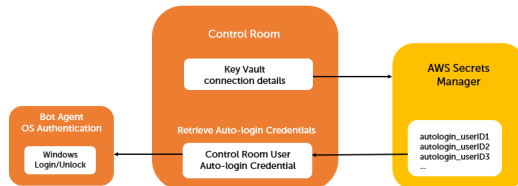

A Control Room administrator can manually launch or schedule a job to launch an automation on a Bot Agent device by specifying these details:

- Automation (bot) name
- Device name
- User context

The system performs auto-login to the specified device with the user name and password associated with the user context, and then runs the automation on the device.

You must have a secret for each Control Room user for whom the auto-login credentials will be retrieved from the external key vault, and the secret name in the AWS Secrets Manager **must match** the Control Room username.

To configure retrieval of auto-login credentials from the external key vault, perform these steps:

1. Log in to the Automation 360 Control Room as the Administrator.
2. From the Control Room, navigate to **Administration > Settings > Devices**.
3. Scroll down to the auto-login settings section and click **Edit**.
4. If you previously configured AWS Secrets Manager as the external key vault connection, click **Enabled** to retrieve the auto-login credentials from that external key vault.

If this option is disabled, then the external key vault connection was not configured.

Note: If you disable auto-login from the external key vault, then credentials are retrieved using the AAI Credential Vault and its stored credentials instead.

5. The AWS Secrets Manager has a flat name space without any organizational containers, so you do not need to enter a Safe name. Click **Save changes**.

If successful, then the auto-login settings successfully saved message displays.

Auto-login naming conventions

The Control Room retrieves auto-login credentials based on the object naming convention within the external key vault. The Control Room searches for an object where the object name (the credential name in the external key vault) matches the Control Room username for which it is performing auto-login.

The prefix `autologin_` is required as part of the naming convention for auto-login credentials for all external key vaults: CyberArk, AWS, and Azure. The name of the auto-login credential in the external key vault must contain `autologin_` followed by the Control Room username. In some cases, certain key vaults have restrictions on the characters that can be used in credential object names. Additionally, to support how different use cases encode credentials, Automation 360 requires that certain characters be reserved or encoded.

The following table lists examples of the object naming conventions expected in the Control Room:

Control Room username	Expected object name format
ABCD\user123	autologin_ABCD--user123

Control Room username	Expected object name format
user123@rpa.abcd.com	autologin_user123-40-rpa-2e-abcd-2e-com

Note: For On-Premises customers using AD authentication, you must format auto-login usernames using the UPN format or `domain\username` postfix.

For auto-login credentials, keep these in mind:

- The object name in the external key vault must contain `autologin_` as a prefix.
- The auto-login credential names must map to the Control Room username (login ID) for the credential being retrieved.

Some external key vaults have usage restrictions of certain characters, such as backslash (\) and ampersand (@) in the secret name (object name), and restrictions on how special characters are interpreted within API calls. If the user ID contains special characters, then you must encode the secret name (object name) in the external key vault using ASCII code character substitutions, as listed in the following table.

This character	Changes to this ASCII code character substitution
\ (backslash)	--
- (dash)	-2d-
_ (underscore)	-5f-
@ (ampersand)	-40-
. (period)	-2e-

Note: Except for the backslash being mapped to double dashes, the dash, period, underscore, and ampersand are mapped using their ASCII code bracketed in dashes.

AWS auto-login credential example

For this auto-login credential retrieval example, consider a Control Room user who wants to deploy a bot on a device as a specific user. This example uses the following details:

- Automation (bot) name run on a device = `ProcureToPayGeoEast`
- Agent device name = `WinVDI1138`
- Agent user context = `rpauserCR1@abcd.com`

The following image shows this an example of retrieving auto-login credentials with AWS:

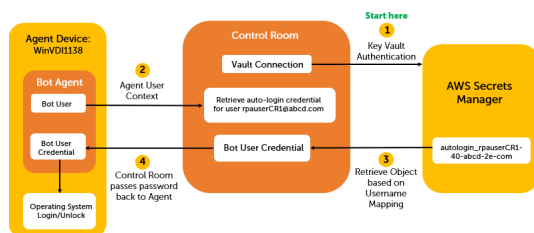

Before starting the automation, ensure the following:

1. The Control Room connection details have been successfully configured, and the Control Room uses these connection details to connect to AWS and performs authentication.
2. The Control Room queries the Bot Agent device running on device `WinVDI1138` to check if there is an active Windows (operating system) session currently on device `WinVDI1138`, and if that session belongs to Agent user `rpauserCR1`.

If there is an existing session on the device for user `rpauserCR1`, then there is no need to perform auto-login and the bot continues with the deployment.

3. However, if there is an no active session or if there is an active session that does not belong to `rpauserCR1`, then the Control Room retrieves the auto-login credential from the AWS Secrets Manager.
4. The Control Room passes the credential (password) to the Bot Agent. The Bot Agent performs a Windows login on device `WinVDI1138` as `rpauserCR1` (first, logging off any other user login session) using the auto-login credential for `rpauserCR1`. The automation (Bot) `ProcureToPayGeoEast` then starts to run on device `WinVDI1138` as `rpauserCR1`.

Retrieve automation credentials

Note: This use case applies to both On-Premises and Cloud deployments.

Automation credentials are variables used by bot developers within automation (bot) actions that define and retrieve data from encrypted storage. The automation uses the credentials to authenticate to applications (for example: finance application). Automation credentials are retrieved by the Automation 360 Bot Agent during runtime.

The following image shows the process of retrieving automation credentials with AWS:

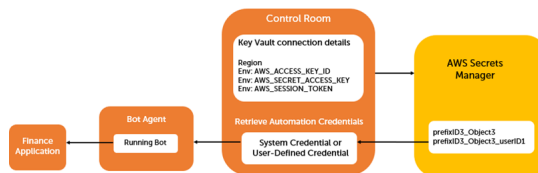

Automation credentials retrieved from the AWS Secrets Manager are mapped in the Automation Anywhere Credential Vault. The Credential Vault supports these two types of automation credentials:

System credentials

Credentials where the value returned by the credential variable is the same for any automation that uses that variable.

User-defined credentials

Credentials where the value returned by the credential variable is distinct based on the user context in which the automation is running.

For both system credentials and user-defined credentials, the bot developer specifies the same credential variable within the bot code. Then, the system determines which credential to retrieve during bot runtime.

User-defined credentials simplify automation development by enabling bot developers to write code using a single credential variable where the RPA platform substitutes the value returned during runtime with a unique user-specific value. Developers can avoid writing duplicate code with different user-specific credential variables.

The following image shows the expected naming convention for AWS credentials:



The diagram shows six secrets in the AWS Secrets Manager which can be mapped to two credentials within the Control Room Credential Vault

- Object3
- Object4

For example, you can map a locker in the Control Room to either `prefixID3` or `prefixID4`. Then, you map the secret to a credential. For each credential, the secrets will be consumed (retrieved by the Control Room) as a system-defined credential (without username postfix) and two user-defined credentials (one each for the Control Room users whose usernames are `User1ID1` and `User1ID2`).

Note: Within the Control Room Credential Vault, the name of the locker and the name of the credential are arbitrary and local to the Control Room. You map these names to specific secrets in the external key vault.

Within AWS Secrets Manager, each automation credential is stored with a name that contains specific identifiers including: a prefix, object identifier, and an optional postfix which identifies a username. This is a required naming convention that assures retrieval of the correct credential. The name of the secret (the credential) in AWS Secrets Manager encodes information about the mapping within the Automation Anywhere Credential Vault.

As an administrator, to map a Control Room to AWS Secrets Manager, you create and configure a locker and a credential using the external key vault option within the **Create Locker** and **Create Credential** features in the Automation 360 Control Room:

- You configure lockers in the Credential Vault that map to an AWS secret name prefix.
- You configure credentials in the Credential Vault that map to an AWS secret object identifier (optional postfix for user-defined credential).

During runtime, the RPA platform retrieves the secret that is named with a postfix that matches the user context (user-defined credential) in which the automation is running. If there is no user-defined credential, then the RPA platform retrieves the secret without a username postfix (system credential).

The Control Room implements access controls to the external credentials through permissions within roles. You control access to credentials by assigning different Control Room users to different roles and then associating different lockers with those roles.

The following image shows the Control Room Credential Vault locker and credential mapped to an AWS secret:

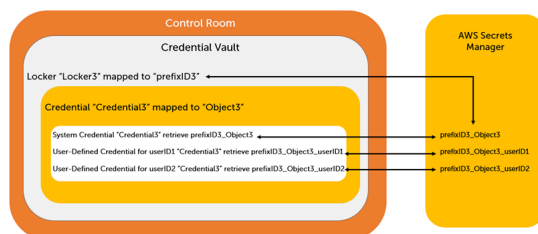

Important: When creating an externally mapped credential, you must place the credential in the appropriate externally mapped locker (the locker is mapped to the prefix in the secret name). The AWS

secret name will have a naming convention: `Prefix + Secret_Name_Body + Postfix` (optional for user-defined credentials).

Note: The same permissions and privileges (assigned through roles) in the Control Room apply to credentials mapped to the external key vault.

Automation naming conventions

The following table shows AWS Secrets Manager external key vault examples using naming conventions for automation.

Note: The AWS Prefix maps to the locker for the Control Room, and the AWS Secret Body maps to the credential for the Control Room.

Automation credential example	AWS Prefix	AWS Secret Body	Secret in AWS	Control Room username
accounting_pdf System credential in locker mapped to AWS Secret name prefix accounting	accounting	pdf	accounting_pdf (system)	None - system credential
accounting_pdf_ABCD\user123 User-defined credential in locker mapped to AWS Secret Name prefix accounting	accounting	pdf	accounting_pdf_ABCD\user123	accounting\user123

AWS automations credentials retrieval example

To configure automation credentials retrieval and integrate with the AWS Secrets Manager, you first create a locker and then create credentials.

To create a locker to integrate with the AWS Secrets Manager, perform these steps:

1. From the Automation 360 Control Room, navigate to **Manage > Credential**.

A user with **Manage my credentials and lockers** permissions is authorized to create credentials.

2. From the **Credentials** tab, select **Create Locker**.

3. Enter a name for the locker (for example, `Locker3`).

This name is local to the Control Room and does not have any dependency on the AWS secret name.

4. Click **External Key Vault** and enter the AWS secret name prefix (for example: `prefixID3`). You must name secrets within the AWS Secrets Manager using the name prefix for the configuration of the mapping to complete successfully.

5. Click **Next**.
6. Configure Owners, Managers, Participants, and Consumers for the locker.
7. Click **Create locker**.
See [Create locker](#).

The Control Room is now ready to retrieve credentials and enforce access controls on all Azure secrets with the prefix `prefixID3`. To continue, you now create the credentials.

To create a credential to integrate with the AWS Secrets Manager, perform these steps:

1. From the Automation 360 Control Room, navigate to **Manage > Credentials**.
A user with **Manage my credentials and lockers** permissions is authorized to create credentials.
2. From the **Credentials** tab, select **Create Credential**.
3. Enter the credential name in the **Credential name** field.
This name is local to the Control Room and does not have any dependency on the AWS secret name.
4. Click **External key vault** below the name field.
5. From the list of available lockers, select the appropriate locker that was previously mapped to the secret name prefix for the secrets you are now mapping to the credential.
6. Enter the AWS `Secret_Name_Body` in the **Secret name** field (for example: `Object3`).
7. Click **Validate and retrieve attributes**.

The system validates the mapping by attempting to retrieve from the AWS Secrets Manager a secret with the name `Prefix_Secret_Name_Body` (for example: `prefixID3_Object3`).

If validation fails, then no secret exists in the AWS Secrets Manager with the name that matches the combination of locker (prefix) and credential (`Secret_Name_Body`). In this example, there is no secret in the AWS Secrets Manager named `prefixID3_Object3`.

When the system successfully retrieves the secret, it will display the AWS Secrets Manager secret attributes (the fields within the secret).

8. From the list of attributes, select attributes to map to the credential.
9. Click **Create credential**.
If successful, then the credential successfully created message displays.

Changing external key vault to another

If you did not integrate the external key vault during the initial installation and you want to configure it without re-installing, you must use the key vault utility. Also, to change the external key vault connection details or to change the bootstrap credentials, you must use the key vault utility.

You use the key vault utility for each of these scenarios:

- To initially configure the external key vault connection if it was not configured during initial installation and you do not want to re-install the external key vault.
- To change external key vault connection details:
 - Example 1: CyberArk Password Vault is migrating to a server with a different name
 - Example 2: CyberArk Password Vault authentication certificate is changing
 - Example 3: You want to change from one AWS Secrets Manager instance to another
 - Example 4: You want to change from one Azure Key Vault instance to another

- The Automation 360 Control Room is malfunctioning because the external key vault connection has changed, and the Control Room is no longer able to retrieve credentials from the external key vault.
- The Control Room is malfunctioning because the credentials defined for bootstrap or Active Directory integration have changed names.
- To change the KEY_VAULT from one external key vault to another, or to NONE, you must first manually set the database and service account credentials that are currently being retrieved from the external key vault.

For example, to change from an AWS Secrets Manager key vault to a CyberArk Password Vault, you must perform these actions:

1. Set the external KEY_VAULT attribute to NONE.
2. Set the external key vault to the new key vault type.

This following table provides guidelines on acceptable state changes for the KEY_VAULT attribute:

New key vault	Original key vault			
	AWS	CyberArk	Azure	None
AWS	Yes	No	No	Yes
CyberArk	No	Yes	No	Yes
Azure	No	No	No	Yes
None	Yes	Yes	Yes	Yes

- To change from an AWS Secrets Manager key vault to a CyberArk Password Vault (or vice-versa), you must first change the KEY_VAULT attribute to NONE.
- To change an AWS Secrets Manager key vault or a CyberArk Password Vault to NONE, ensure that the database is not connected with the KEY_VAULT attribute.

Verify external key vault configuration

Use the Automation 360 Control Room to verify external key vault configuration and database authentication changes you made using the key vault utility.

1. Log in to the Automation 360 Control Room as the administrator.
2. Go to **Administration > Settings > General > Configuration settings**.
3. Go to the **Control Room Database & Software** tab and scroll down to the Control Room database information to verify its details.
4. Navigate back to **Settings > External key vault** and review its configuration settings for external vault, vault URL, and Application ID.
5. Navigate back to **Settings > Email**, and click the **Edit** icon to open the **Notifications** pane.
6. Scroll down to verify that the external key vault settings reflect the SMTP credential identifier in the external key vault
7. Click **Close**.

Troubleshooting external key vaults

You can use the `keyvault.properties` file and application log files to review configuration and integration information for external key vaults.

Use the `keyvault.properties` file

You can use the `keyvault.properties` file to review configuration attributes for these external key vaults:

- CyberArk Password Vault
- AWS Secrets Manager
- Azure Key Vault

The following `keyvault.properties` file shows an example with the CyberArk Password Vault:

```
keyvault.type=CYBERARK_PASSWORD_VAULT
keyvault.cyberark.ccp.url=https://services-uscentral.skvtap.com:19516/
keyvault.cyberark.ccp.appid=wb_test_app
keyvault.cyberark.ccp.client.certificate.path=D:\\CyberArk\\client_combined_cert_key_Adminat123.p12
keyvault.cyberark.ccp.client.certificate.passphrase=Password
```

To review the AWS Secrets Manager `keyvault.properties` file, enter these AWS attributes (for example):

- `keyvault.type=AWS_SECRETS_MANAGER`
- `keyvault.aws.region=us-west-2`

Note:

- The certificate passphrase attribute contains the encrypted Control Room certificate file passphrase. **Do not** modify the certificate passphrase attribute directly; instead, you should use the key vault utility.
- You can modify the `keyvault.properties` file. However, any modifications will require a service restart. So we recommend that you always use the key vault utility to make modifications.

Use the application log files

You can use these application log files to review external key vault integration information:

- `WebCR_CredentialVaultlog`
- `WebCR_RestException`

You can use these log messages to troubleshoot external key vault integration or configuration issues:

Log message description	Cause or reason
Unable to send an email	Retrieved SMTP credential is incorrect.
Unable to connect to SMTP server because either your SMTP username or password is incorrect	
Logs indicate failure connecting to LDAP	Failure to authenticate through Active Directory.

Log message description	Cause or reason
WebCR.log file shows database connectivity error, and the Control Room fails to boot up correctly	Retrieved database password is incorrect.
Either your username or your password is incorrect	Retrieved auto-login credential is incorrect for the user (correlates to the bot deployment log for user ID).
Logs indicate connection failure to CyberArk	A possible certificate expiry issue exists if failure occurs after a period of proper functioning for (3, 6, or 12) months.
Unable to retrieve secret, and detail exception will have cause	<p>A non-existent credential identifier (safe name, object name, or secret name) is in use. Might also indicate the credential identifier was removed from the external key vault (if it was previously working properly).</p> <p>Might also indicate that the key vault connection is down or unreachable. Or, connection details (API URL, AppID, certificate, region name, AWS keys) are incorrect, have been changed on the key vault, or expired.</p>

Notifications

Notifications is a built-in mechanism in the Automation 360 Control Room, which notifies users about various events. It is a centralized notifications repository in Automation 360 for all users to track relevant events.

The Notifications mechanism provides simplified information about possible risks, warnings, information, and success statistics of the Automation 360 platform and automation events. With the notifications feature, you can monitor, respond, reduce, and resolve critical risks in much quicker way. It allows you enable required event categories and be notified for the enabled events.

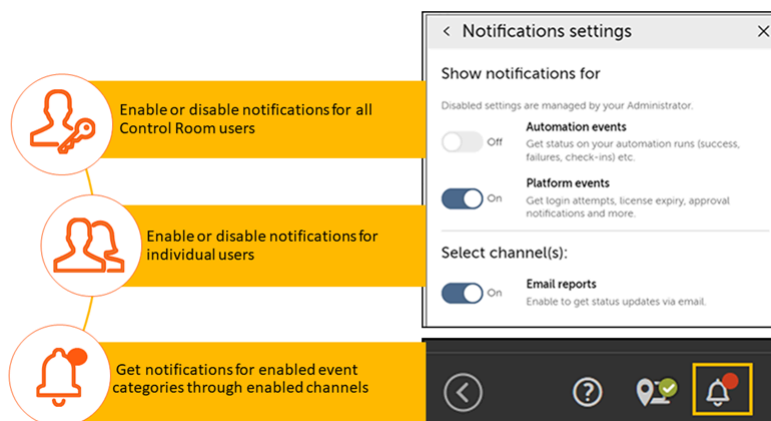

Benefits

Notifications provide the following benefits:





- Maintain all the notifications from a centralized repository.
- Enhance ability to respond to critical or warning notifications.
- Stay organized with automated notifications to reduce and avoid future risks, and take possible actions.
- Improve productivity of users and the platform by being notified about updates such as Bot export and add or update package.
- Save time and increase notification efficiency because of a single centralized events repository.
- Increase relevance of notifications delivery through multichannel communication.
- Notify Automation 360 users about events through email report or instant email notification.

Prerequisites

- The Control Room administrator must enable the **Administration > Settings > Notification settings** to receive notifications. For more information, see [Manage notifications for Control Room](#).
- Control Room users must enable the required settings from the **Notifications** repository to receive notifications. For more information, see [Enable or disable event categories](#).

Components

- **Notification icons and navigation:**

- : Indicates no new notification.
- : Indicates new notification.
- : Indicates hover over action on the notification icon.
- : Indicates select action on the notification icon.

- **Notifications panel:**

The in-app notification panel provides a comprehensive view of all the event notifications with notification summary and details. For more information, see [Getting started with Notifications](#).

- **Severities:**

The in-app notification panel displays and categorizes all notification information in the following severities:

Critical	Notifies about high-risk events, which can stop or impact execution of scheduled tasks or processes.
Warning	Notifies about cautionary events, which can be interrupted, not running as expected, or completed with minor recoverable errors.
Info	Notifies about platform or functionality updates, such as updates to packages and bot export.
Success	Notifies about events that are completed successfully.

- **Settings:**

Enable and disable the notifications for **Automation runtime events** and **Platform** events. You can also enable **Email report** channel to receive notifications through email.

Getting started with Notifications

Notifications provide an automated method of managing notifications through a centralized repository.

When you enable required event categories, you receive notifications through the notifications repository.

New notifications display with the (🔔) icon.

To start working with notifications, set preferences for the following event categories and notification channels:

Event categories

Events are at the core of the monitoring framework. Users must be able to monitor event continuously, and receive constant notifications. Automation 360 provides notifications for the following events:

Automation events

This category notifies you about bot-related events. These event notifications are sent to users based on the permissions defined in the Automation 360 platform, and those users who have performed specific tasks, such as export bot.

The following table lists is an example of the automation event and its severity:

Event name	Severity	Users notified for the event
Bot export successful	Success	Control Room user who exported the bot
Bot export unsuccessful	Critical	Control Room user who exported the bot

Platform events

This category notifies you about events related to the Automation 360 updates. These event notifications are sent to users based on their role and permissions defined in the Control Room.

The following table lists an example of platform events and their severity:

Event name	Severity	Users notified for the event
Add or update package	Success	All Control Room users

The following example shows an export bot event notification with the **Success** severity:



AUTOMATION ANYWHERE
Automation 360

- Home
- Automation
- Activity
- Manage

doctest

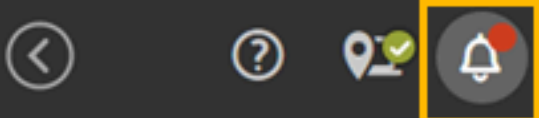

Home

Getting started

Notifications

Critical 0 Warning 0 Info 0

Bots/files exported and archived success

Archived file name
Export.20221123_122921.vbirla

Export start time
06:59:27 2022-11-23

Message
Download the archived file from: A

Hide details

Bots/files exported and archived success

Notification channels

Notifications are sent through integrated channels used to organize and manage the notifications. Automation 360 send notifications through the following channels:

Notifications panel

This is the default notification channel. The notifications panel provides a summarized view of all event notifications. It categorizes notifications based on severity, and then sorts them in each category by date showing the most recent notification first. The count on each severity tab (**Critical**, **Warning**, **Info**, and **Success**) shows the number of unread notifications. For more information, see [Notification summary and details](#).

Note: These notifications are available in the Control Room for maximum of seven days.

Email notifications

These notifications generate emails to the opted-in users only. There are two types of email notifications:

- **Instant notifications:** Instant email notification is sent to a user's registered email address.

The following sample shown an email sent for an instant notification:

From: Quality Assurance Team <quality_assurance_team@xyz.com>
Sent: 18 October 2022 17:15
To: John Doe <john.doe@xyz.com>
Subject: Automation Anywhere Control Room Instant Alert.

Hello,

You have the following email report from your Control Room administrator for <https://doctest.supremomono.com>

Severity	Report
	Category: Automation events
SUCCESS	Alert raised: 18 Oct 2022 00:29:14
	Alert Description: Bot ran successfully

Thanks and go be great,
Automation Anywhere team
www.AutomationAnywhere.com

- **Email report:** Email report notification is sent to a user's registered email address twice a day at a fixed time.

The following sample shows an email sent for an email report:

From: Quality Assurance Team <quality_assurance_team@xyz.com>
 Sent: 12 October 2022 13:30
 To: John Doe <john.doe@xyz.com>
 Subject: Automation Anywhere Control Room Alerts.

Hello,

You have the following email report from your Control Room administrator for <https://doctest.supremomono.com>

Summary Report - 11 Oct 2022 18:24 PM - 11 Oct 2022 18:24 PM

Severity	Notifications
CRITICAL	0
WARNING	0
INFO	0
SUCCESS	3

Severity Level	Category	Alert raised	Alert Description
SUCCESS	Platform events	11 Oct 2022 18:24:28	A new automation package version bot-command-ufiorms:2.27.1-20220829-103421 has been added in the control room. Please consider using it in your automations.
SUCCESS	Platform events	11 Oct 2022 18:24:37	A new automation package version bot-command-igbot-preprocessor:2.2.4-20220729-133815 has been added in the control room. Please consider using it in your automations.
SUCCESS	Platform events	11 Oct 2022 18:24:37	A new automation package version bot-command-igbot:2.2.0-20220729-134136 has been added in the control room. Please consider using it in your automations.

Thanks and go be great,
 Automation Anywhere team
www.AutomationAnywhere.com

Note: Notifications that are sent as **Instant notifications** are not included in the **Email report** and vice-versa. Based on the event type, notifications are sent either as **Instant notifications**, or **Email report**. You cannot configure these notifications.

Notification summary and details

After you enable the required event category, corresponding event notifications are sent through the **Notifications** repository. By expanding the notification summary, you can view the notification details.

Note: Every event notification does not have notification details. Sometimes the notification summary provides all of the event information, for example, notifications about package updates with the **Info** severity.

The following image is a sample event notification with **Success** severity:

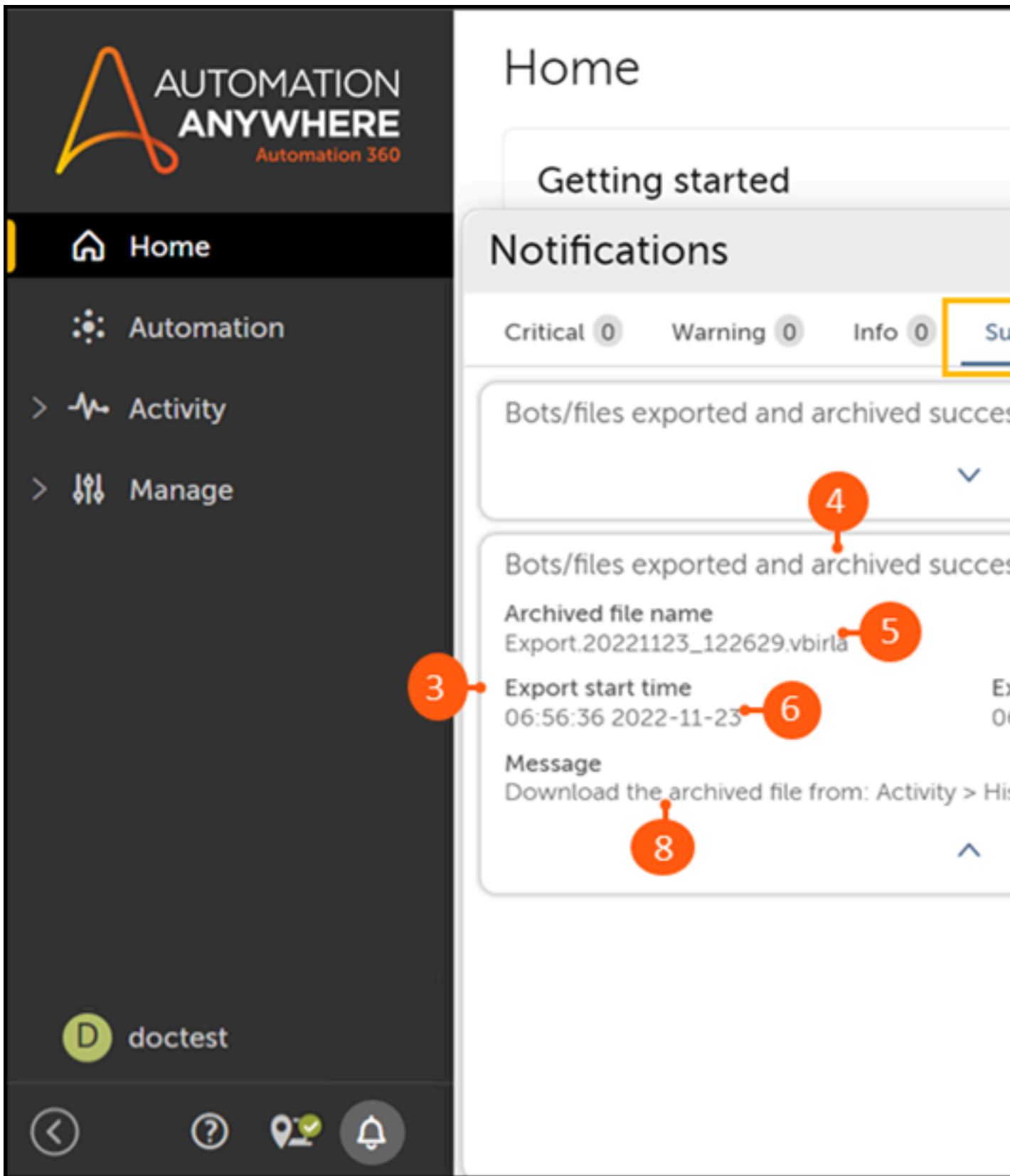

The following table describes the fields in the sample event notification (as numbered in the previous example):

Field/Option	Description
1	Event severity
2	Notification summary
3	Notification details
4	Event description
5	Exported or archived file name Note: This field and description varies based on the event severity.
6	Event start date with time stamp
7	Event end date with time stamp
8	Message that describes the root cause of the event and next possible action (if applicable) to take

Note: The notification summary and details information varies based on the event type and severity.

Manage notifications for Control Room

Manage notifications for the Control Room by enabling various notification categories and channels.

Ensure that you are logged in to the Control Room as an administrator.

You can manage notification settings for all the Control Room users and view the audit log information to track user activities.

Note: All the event categories are disabled by default.

<https://aa2019packagesdkfordocumentation.s3-us-west-2.amazonaws.com/videos/admin-settings.mp4>

To manage notifications for various events, perform the following steps:

1. Navigate to **Administration > Settings > Notification settings**.
2. To enable or disable the required event categories, click **Edit**.
3. Enable the required event categories. For more information about which event category to enable, see [Event categories](#).
4. Click **Save changes**.

Note:

- Event categories that are enabled by the administrator are applicable to all the Control Room users.
 - Notifications audit logs to track user activities are available at the **Administration > Audit log** page. For more information, see [Audit log](#).
-

Manage notification channels

Manage notification channels through which you want to notify all the Control Room users.

- Ensure that you are logged in to the Control Room as an administrator.

- For On-Premises users, navigate to **Administration > Settings > Email** and enter an email address in the **From this email address** field to manage emails. For more information, see [Edit email notifications](#).

After you enable the required event categories, enable the required notification channel through which Control Room events are notified to the opted-in users. This feature helps you to notify users through email about events such as a planned maintenance activity. It is useful when you have a dedicated support team for managing the RPA operations.

Note: The email channel is disabled by default.

To manage a notification channel and send an email report, perform the following steps:

1. Navigate to **Administration > Settings > Notification settings**.
2. Click **Edit** to enable or disable the required notification channel.
3. Enable the required notification channel. For more information about notification channels, see [Notification channels](#).

Note: Notification channels enabled by an administrator are applicable to all the Control Room users.

4. Specify the email address or email distribution list to whom you want to send the email report.

Note:

- You can specify multiple email addresses and email distribution lists separated by comma.
- You can send an email notification to a specific email distribution list.
- You cannot send email notifications to public domain addresses such as gmail.com, yahoo.co.in, and so on.

-
5. Click **Save changes**.

Enable or disable event categories

You can enable or disable the required events categories to receive notifications, and manage necessary notification traffic in the Control Room.

Ensure that the required event category is enabled by Control Room administrator.

<https://aa2019packagesdkfordocumentation.s3-us-west-2.amazonaws.com/videos/user-settings.mp4>

To enable the event category:

1. Click the **Notifications** (🔔) icon.
2. Click the Settings (⚙️) icon in the **Notifications** window.
3. Enable the required event category and close the **Notifications settings** window. For details about which event category to enable, see [Event categories](#).

Note: The Control Room administrator manages the disabled event categories.

Enable email report channel

You can use the email report channel to notify Control Room users about various events through emails.

Ensure that the required email report channel is enabled by Control Room administrator.

Email notifications are sent as an instant notification or email report based on the event severity identified by the Automation 360 platform. The email report channel is disabled by default.

To enable the email report channel:

1. Click the **Notifications** (🔔) icon.
2. Click the Settings (⚙️) icon in the **Notifications** window.
3. Enable the **Email report** option to receive email notifications.

An email report, containing the Control Room URL and time duration when the report was generated, is sent to the specified email addresses or email distribution list.

Note: When you enable the email report channel, consider the following information:

- If the Control Room administrator does not enable the **Email report** channel, then individual users cannot enable or disable this option. As a result, individual users cannot be notified through emails.
- If the Control Room administrator disables the **Email report** channel for a certain duration (for example, maintenance activity over weekend), individual users cannot receive email reports for that duration.
- The email report is sent to all email addresses and distribution lists specified by the Control Room administrator based on the enabled event categories.
- If an event is critical and marked for instant notification, then an email notification is sent immediately when the event occurs. Otherwise, it is sent as a part of the email report but the email notification not included in both instant notification and email report.
- A single email report is sent for all bot events.
- An email report is sent twice a day, at a fixed time that is 8 AM (PST) and 4 PM (PST).

Capabilities supporting notifications

With Notifications, you are notified about specific events in Automation 360, such as bot execution tasks and updates to platform and functionalities.

Automation 360 supports notifications for the following capabilities:

Export bot

When a bot is exported, you are notified about this automation event. Based on the result (failure or success) of export bot functionality available in the platform, you are notified with the corresponding event details and severity level (**Critical**, **Warning**, **Info**, or **Success**). This notification is sent only to the user who exported the bot.

Add or update package

When a package is added or a new package version is released in the Control Room, you are notified about this platform event. This notification is sent to all the Control Room users who have the **View package** permission. Based on your role and package permissions, you can view event notifications. For package versions information, see [View package versions available in the Control Room](#).

Note: For custom packages, a notification is sent only to the corresponding customer and not to all the Control Room users.

Edit My settings

The **My settings** page provides user profile specific information.

My profile

Each RPA user is required to have an active profile in the Control Room to built, run and schedule the deployment of bots as well as for security authorization. Profile information includes user names, email addresses, passwords, and so on.

To access this information, click the **My Settings** navigation tab.

The **My Settings** page displays an expandable **My profile** tab that shows specific and configurable user details. Click the **Edit** icon to update this profile information.

Related tasks

[Edit profile settings](#)

Update your user profile settings in the Control Room.

Edit profile settings

Update your user profile settings in the Control Room.

Ensure that you are logged in to the as the administrator.

Each RPA user is required to have an active profile in the Control Room to built, run and schedule the deployment of bots as well as for security authorization. Profile information includes user names, email addresses, passwords, and so on.

1. Navigate to **My Settings**.

The **My Settings** page displays the expandable **My profile** tab for specific and configurable user details. Click the **Edit** icon to update this profile information.

2. Update any or all of the general details for your profile.

Option	Description
First name	Maximum character length is 50.
Last name	Maximum character length is 50.
Contact email	Maximum character length is 255.
Change password	8-15 characters: a-z (lowercase), A-Z (uppercase), 0-9, and the following special characters are allowed: @, -, _ , !, #, \$, %, ., and &

3. Click **Save changes**.

CoE Manager

Automation Anywhere CoE Manager helps you achieve visibility into your end-to-end automation lifecycle while accelerating the pipeline generation. It helps scale the automation programs more quickly and efficiently, while maximizing the value realization from the investment in your automation program.

CoE Manager is available out of the box and requires minimal configurations for first-time use. In addition to program management capabilities, it provides a consistent and repeatable way of assessing automation opportunities in order to minimize variations and maximize return on investment (ROI). ROI can be measured in terms of time and cost saved as well as user-defined KPIs such as operational agility, cash flow, sustainability, and so on.

CoE Manager is powered by Shibumi platform, a leading provider of enterprise program management solutions.

<https://aa2019packagesdkfordocumentation.s3-us-west-2.amazonaws.com/videos/aa-coe-manager.mp4>

Benefits

CoE Manager helps you in the following ways:

- Scale automation programs more quickly and efficiently.
- Forecast business results, identify metrics for success, and track them through the entire automation lifecycle.
- Create single view of portfolio status, risks, and interdependencies.
- Informed decision making with timely and accurate data.
- Assess all automation ideas across expected savings, strategy alignment and automation complexity to enable prioritization.
- Reduce manual effort on multi-level tracking, computing, and reporting.
- Maximize the value (ROI) from your automation investment.
- Boost the value of the pipeline of automation opportunities to build the business case for additional investment.

Capabilities

CoE Manager is a cloud-based platform which helps manage the automation pipeline and delivery.



Business User



Developer

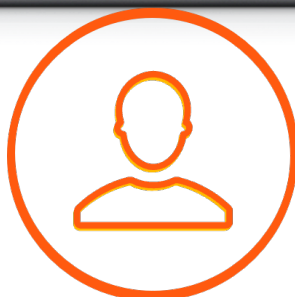

CoE Leader

For everyone who is interested in accelerated automation success

Key capabilities of CoE Manager are:

- Accelerate the automation lifecycle journey with a purpose-built automation CoE management solution where everyone can share automation ideas.
- Enable the leadership team to make focused decisions by providing dashboards that help maximize the ROI from the automation program.
- Enable tracking and managing the pipeline by tracking automation program data, set targets, and tracking the progress. It helps manage the pipeline from idea to delivery to value realization.
- Track automation ROI via native integration with Automation Anywhere.
- Seamless reporting via dashboards and automated report creation.

- Efficient governance with role-based access control with in-built approval workflows and user notifications.

Components

The CoE Manager includes the following components:

- **Dashboard:** Provides graphical insight to help you view the adoption and progress of the automation program. It displays information on idea velocity, opportunities by stage, forecasted savings versus program target, value by stage, as well as benefits at various stages.
- **Opportunities:** Displays all opportunities across idea, pipeline, in-progress, and deployed stages.
- **Ideas:** Displays new opportunities submitted into CoE Manager.
- **Pipeline:** Displays approved opportunities.
- **In Progress:** Displays opportunities currently in design/build stage.
- **Deployed:** Displays opportunities that are live.
- **Risks:** Track program risks and their resolutions.
- **Reporting:** View and export the status of entire automation program or drill-down into each business unit.
- **Admin:** Configure program details and targets, questionnaire and weightages, cost estimates, benefit types, and so on.

Getting started with CoE Manager

CoE Manager provides clear visibility into the backlog of automation ideas, their position in the lifecycle, and how much value they will deliver back to the business. The following is a high-level overview of how to get started with CoE Manager:

Add the following email domains to your email client's safe-senders list to ensure users receive the notifications generated by CoE Manager.

- APP environment (North America) - notifications come from @mail.app.shibumi.com
- EU environment (Europe and India) - notifications come from @mail.eu.shibumi.com
- AP environment (Asia-Pacific) - notifications come from @mail.ap.shibumi.com

Administrator

- Configure your CoE Manager for first-time use: CoE Manager provides program-level administration tabs to tailor the solution for your use.

[Configuration instructions for admin](#)

- Add users: Add participants to specific roles within your CoE Manager.

[Roles and user management](#)

- Register and access CoE Manager: You must be invited to use CoE Manager. When you respond to your first invitation, you will set up a login account. You will use this account for all future use.

[Creating and managing your account](#)

- Link Control Room: Link up to three Control Room in your CoE Manager.

[Integrate CoE Manager with Control Room](#)

- Customize your CoE Manager: The CoE Manager provides several program-level administration tabs to tailor it as per your requirement.

[Customize the CoE Manager](#)

- Register a digital worker within the CoE Manager: You can review digital worker information from the **Deployed** tab and add automations directly on an opportunity. To register a digital worker with an

opportunity, you can either use the **Opportunities** tab to search for the opportunity you would like to update or use the search option (magnifying glass icon) on the Navigation Sidebar.

Automation Anywhere
 ☆ CoE Manager
 < Dashboard **Opportunities** Ideas Pipeline In Progress Deployed Risks Reporting Admin - Program Admin - Advanced Admin - Tech

Create Opportunity

RPA Opportunities

Oppor... ↑	Business ...	Overall Sco...	Alignme...	Total Savings	Total Costs	Complexity	Implementati...	Stage
*Foster Huma...	HR	63%	68%	220,736	21,000	1 - Low	Nov 12, 2022	2 - Pipeli
*Onboarding ...	HR	76%	52%	241,800	15,000	2 - Medium	Aug 16, 2022	4 - Depl
*Streamline R...	Finance	84%	72%	152,064	36,000	3 - High	Oct 28, 2022	3 - In Pr
*Weekly Data...	Finance	85%	84%	172,800	15,000	2 - Medium		4 - Depl
Accounts Pay...	Finance	87%	68%	303,000	10,000	1 - Low	Oct 27, 2022	4 - Depl
Accounts Pay...	Sales	60%	28%	96,500	15,000	2 - Medium		5 - Retir
Adjust Prepari...	HR	66%	80%	24,300	30,000	3 - High		1 - Idea
Approval Flo...	Finance	69%	72%	91,200	15,000	2 - Medium		2 - Pipeli
Auto-populat...	Sales	72%	72%	88,400	30,000	3 - High	Sep 2, 2022	3 - In Pr
Auto-track th...	HR	35%	28%	8,184	15,000	2 - Medium	Jan 13, 2023	3 - In Pr

Once you navigate to the opportunity, you can update the information on the **Execution Tracking** tab. This tab is only available for opportunities that are in-progress, deployed, or completed.

Automation Anywhere › CoE Manager › HR
 ☆ *Onboarding of temporary/part-time workers
 Opportunity Summary Details Activities **Execution Tracking** Workflow History *Metrics

Execution Details

Cost per Execution Failure: 7,500
 Deployment Notes: --

Task Bot

Name ↑	Automation ID	Estimated Execution Hou...	Include in Successful Exe...	Incl
Master Bot	123456888	5.00	<input checked="" type="checkbox"/>	<input checked="" type="checkbox"/>
Onboarding Process - Part Ti...	38071	1.00	<input checked="" type="checkbox"/>	<input checked="" type="checkbox"/>
Onboarding Process - Tempo...	38071	1.00	<input checked="" type="checkbox"/>	<input checked="" type="checkbox"/>

Add Task Bot

To create an automation process, click the blue plus button displayed at the top right of the automation processes list. Enter the name and automation ID. After creating the process, you can add the cost per failure.

Note: The Automation ID is same as Bot ID from Automation Anywhere (see example below).

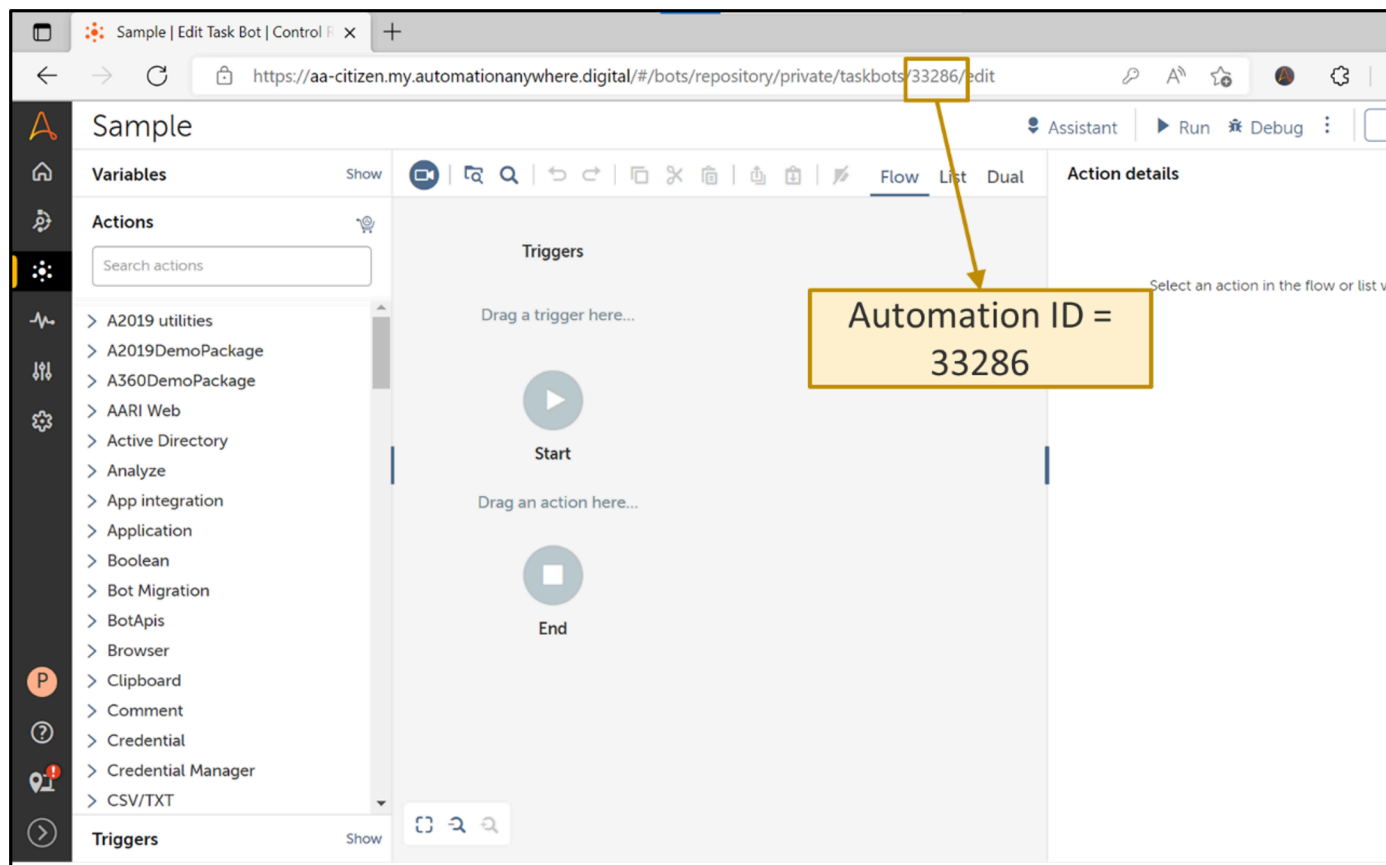

Once a process is created, the associated KPIs will be displayed in the execution metrics section.

Any user

- Create and manage opportunity: Submit an opportunity, build a business case for it, and track its progress through the approval stage gates.

[Create and manage opportunity](#)

Integrate CoE Manager with Control Room

You can integrate the CoE Manager with the Control Room to monitor your automations and calculate the savings achieved. You can link up to three Control Room instances with one instance of CoE Manager.

To link a Cloud Control Room to the CoE Manager, follow the steps mentioned below.

1. Create a custom role with the following permissions:
 - View everyone's activity
 - Generate API-Key
2. Create a user and assign the custom role created above.
3. Generate API Key for the user.
4. Log in to the CoE Manager by providing your **Email Address** and **Password**.
5. Navigate to **Admin-Tech** tab.
6. Click the placeholder URL in the **Automation Anywhere URL** column.
7. Click **Edit** in the **Automation Anywhere URL** field and enter the Control Room URL.

8. Enter the username in the **Automation Anywhere Username** field.

9. Enter the API key in the **Automation Anywhere API Key**.

10. Click **Save**.

The **Enabled** column automatically changes to **Yes** when you save the URL, username, and API key.

Customize the CoE Manager

The CoE Manager provides several program-level administration tabs to customize it as per your requirements. You must have an admin role to customize the CoE Manager.

Admin - Program

In the **Admin – Program** tab, you can configure general settings for the overall program.

Program Details

Program Details

Program Start Date 01/01/2022	Program End Date 12/31/2025
Currency Symbol \$	Primary Benefit Currency
Number Format Thousands ▼	Number Suffix K
Formatted Decimal Places 2 ▼	Assign Intake Score No
Track Program Risks? Yes ▼	Show Opportunity Gantt Chart

Indicate which target value(s) should be used in calculating the overall score for opportunities

Opp Target - Overall Score Calculation Use Both	
Opp Target - Amount Saved 40000	Opp Target - Hours 160

Option	Details
Program Start and End Dates	Displays the start and end dates for the program.
Currency Symbol	Displays the currency symbol alongside savings values. This setting applies to all opportunities.
Primary Benefit Measure	Displays the primary quantitative measure for the CoE Manager as either hours or currency. For example, if you select currency, the program dashboard tab displays forecasted savings on the top-left corner of the page. If you select hours, the program dashboard tab displays the forecasted hours saved.
Number Format	Controls how large numbers are abbreviated. The options are full number, thousands, and millions.
Number Suffix	Automatically assigned based on the number format selected, has a value of K for thousands and M for millions.
Formatted Decimal Places	Specifies how many decimal places to display in numbers formatted with M or K based on the number format selection described above.
Assign Intake Submitter as Opp Owner	Determines whether the system should create an account for the user submitting the opportunity. This is applicable for users who currently do not have an account with the CoE Manager. If set to Yes , the email address in the opportunity submission form is used to create the user account. Ensure the email domain is whitelisted within the CoE Manager.
Track Program Risks	Specifies whether or not to show the risks tab at the program level.

Option	Details
Show Opp Activities As	Specifies how opportunities activities are displayed on the activities tab. You can choose between a List and a Gantt-Chart.
Opp Target – Overall Score Calculation	Choose whether you want to use amount or hours to calculate opportunity targets.
Opp Target – Amount and Hours Saved	Specifies the target amount and hours saved for individual opportunities. For calculating the Overall Score for an opportunity, the percentage achievement toward these targets as well as the business alignment percentage is used.

Weighted Benefit per Stage

Weighted Benefit per Stage

Stage 1 Weight

0%

Stage 2 Weight

25%

Stage 3 Weight

50%

Stage 4 Weight

100%

Determines the weightings to calculate the weighted benefits for opportunities at each stage in CoE Manager. The weighted benefit is calculated by multiplying the estimated value for each opportunity with the corresponding factor to reflect the confidence of the benefit being achieved. Typically, opportunities in the idea stage are weighted lightly and gain in weighted value as they progress toward

Colors	deployment. The weighted value is used to estimate total program savings. Specifies the hexadecimal color codes to use for highlights in the system. The alert color is applied when highlighting severe issues, the warning color is applied when highlighting developing issues, and the normal color is applied for normal operations. The neutral color is applied as a default color in non-alert situations.
Advanced Views	Sets the visibility of the admin tabs. For more information, see: <ul style="list-style-type: none">• Admin - Advanced• Admin - Users• Admin - Tech Integrate CoE Manager with Control Room
Complexity Cost Estimates	Specifies the default implementation cost estimate to be assigned for an opportunity when either a low, medium, or high complexity assessment is specified for that opportunity. You can override the default cost estimate by typing a new value in the implementation cost field on the details tab for the opportunity.
Business Unit List and Opportunity Sources	Lists the business units and opportunity sources for the automation program. Use the Create Business Unit and Create Opportunity Source buttons at the top of the section tabs respectively to create the business unit and opportunity sources.
Monthly Targets	Lists the program and business unit targets. You can enter the targets for the program as a whole and individual business units in this list.

Admin - Users

In the **Admin - Users** tab, you can manage role assignments on individual opportunities.

Opportunity Role Assignments

Opportunity	Role
*Foster Human Resources Metrics	Owner
*Onboarding of temporary/part-time workers	Collaborator
	Collaborator
	Owner
*Streamline Reviewing and Reconciling Transactions	Owner
*Weekly Data Reconciliation	Admin
	Owner
Accounts Payable Automation	Collaborator
	Collaborator
	Owner

Displays the list of opportunities and their participants along with the role of the participant (owner, admin, or collaborator) in that opportunity.

Admin - Tech

In the **Admin - Tech** tab, you can manage the integration of automation platforms for the program.

Configure non-firewalled Control Rooms

Enabled integrations run every four hours starting at 2AM UTC. If any settings are missing (URL, Username, API Key) the integration will be automatically disabled.

Control Room Integrations

Automation Anywhere U... ↑	Automation Anywhere Us
Control Room URL 3	
https://aa-saleseng-us-4sbx.clou...	coemgr_systemuser
https://product.aaedev.supremo...	coemanager_cr_user

You can integrate up to three Cloud Control Room instances with the CoE Manager.

Admin - Advanced

In the **Admin - Advanced** tab, you can define the detailed prompts for additional benefits, complexity and strategic alignment questions for automation opportunities. You can also specify the display icons across the CoE Manager.

Label Settings

You can change the labels for workstream, complexity and strategic alignment attributes in the details section of an opportunity.

Opportunity - Addl Benefit Types

Defines up to five categories of benefits in the additional benefits section on the details tab for opportunities. You can track benefit amounts and comments for each benefit category for the opportunities.

Opportunity - Complexity

Defines up to five complexity questions, weighting for each question and the scoring scale. You can rate each opportunity on a scale from none to very high to drive a complexity score (based on the weightings) for the opportunity.

Opportunity - Strategic Alignment

Defines up to five strategic alignment questions and the weighting for each question. You can rate each opportunity on a scale from none to very high to drive an alignment score (based on the weightings) for the opportunity.

Icon Preview

CoE Manager comes preconfigured with the preferred icons and color schemes. You can

Icon Assignment

customize these using Font Awesome icons to highlight key measures for individual opportunities as well as aggregated information. The **Browse Icons** button allows you to browse Font Awesome icons on their website. The **Icon Preview** entry loads the specified Font Awesome icon (based on an icon ID from the Font Awesome website) in the panel to the right.

Defines the icons to be displayed throughout CoE Manager by using Font Awesome icon IDs from the Font Awesome website.

Export and Import

You can bulk import opportunities into a program. Click the **Export** button to download the opportunity template. This is a pre-filled template with existing opportunities in the CoE Manager. To add new opportunities, follow the below steps:

1. Open the downloaded template and delete the existing data.
2. For each row of new opportunity to be created, enter the data as outlined below:
 - Column A: Default to `Opportunity_t`
 - Column B: Do not fill
 - Column C: Enter the **Business Unit** for the opportunity being created
 - Column D to AE: Fill the details as required
3. Save the excel file.
4. Click the **Import** button.
5. Browse and select the file and click **Import**.

Configure CoE Manager for Single Sign-On (SSO)

Use the SSO option to enable the CoE Manager authentication through an identity provider (IdP) using Security Assertion Markup Language (SAML) 2.0 protocol.

SAML SSO login setup

Before configuring the CoE Manager, ensure you have completed the following requirements:

1. Download the Service Provider (SP) metadata for your respective CoE Manager region using the links provided below:
 - US environment: [Test](#) | [Prod](#)
 - EU environment: [Test](#) | [Prod](#)
 - AP environment: [Test](#) | [Prod](#)

2. Configure your Identity Provider (IdP) with the metadata obtained from the previous step and in SAML assertion, provide the following:
 - Email, First Name, Last Name, and NameID
 - Redirect URL for IdP-initiated login as a relay-state parameter
3. Provide the IdP metadata and the attribute names received from IdP (Email, Last Name, and First Name) to the Automation Anywhere support team.

Login workflow

SAML SSO login can be configured using one of the following methods:

- **Service provider-initiated login:** The SP-initiated login starts with the CoE Manager and is triggered when a user attempts to access the application through a URL. SP-initiated login requires a redirect to the appropriate IdP to ensure proper authentication before access is granted to the service or to any specific object. Depending on whether SSO is configured as mandatory or optional, your login workflow will vary. See below for more information.
- **Mandatory SSO:** After SSO is enabled, enter your email address in the CoE Manager login page and click **Next**.

As the CoE Manager is a multi-tenant application, you must use an email address to determine the IdP to be redirected to. This email address can be from any domain associated with your organization. CoE Manager will redirect to the IdP based on the entered email domain. For example, if your organization is Acme Corp, you might have acme.com and acmeent.com as associated domains. In this event, any address with @acme.com and @acmeent.com will redirect to the IdP when you click **Next**. You will be redirected back to the CoE Manager page after IdP authentication.
- **Optional SSO:** On the login page, enter the email address and click **Next**. Instead of being automatically redirected to the IdP, you will be prompted to either enter a password or select the option to log in with SSO, which will be sent to your IdP for authentication.

Note:

- CoE Manager supports deep linking with SSO. After clicking the link, you should enter your email address in the CoE Manager login page. You are then redirected to the IdP for authentication. After authentication, you are redirected to the URL initially requested.
 - CoE Manager creates a cookie after successfully logging in to the application using SSO. This ensures the subsequent logins to CoE Manager will bypass the username and password screen and redirects to the appropriate SSO login page automatically. You can also override the cookie by navigating directly to the CoE Manager login page, that is `https://<region>.shibumi.com/shibumi/login`.
 - A user account is automatically created after successfully logging in to the CoE Manager using SSO for the first time.
-
- **IdP-initiated login:** With IdP-initiated login, you can access the CoE Manager directly through the IdP (without a login page being displayed). When CoE Manager is launched using this method, you are taken directly to your organization's CoE Manager home page or to a URL provided by the IdP as a relay state parameter.

Account provisioning

CoE Manager provisions user accounts as needed for organizations with enabled SSO. Accounts are generated when:

- A user is assigned a role on an object in CoE Manager
- A user is invited to a CoE Manager work item
- A user first attempts to access CoE Manager

The typical account provisioning sequence would be for a user to be invited into a work item in CoE Manager by an existing user. This triggers the auto-provisioning of their account. If this is not done, when the user attempts to access CoE Manager the first time the account is provisioned, the user will not have access to any work items. This can be a confusing experience. Therefore, it is a recommended best practice to ensure that the users are invited to participate in a work item prior to the first access.

Note: User accounts are not imported in bulk from the IdP. Users are not automatically added or removed from the CoE Manager instance when a person joins or leaves the organization.

When a user is authenticated via an IdP, their first and last name are updated in CoE Manager to reflect the attribute values supplied in the SAML payload (the mapping of first name and last name to attributes is part of the SAML configuration in CoE Manager and in IdP).

Using CoE Manager

CoE manager provides a structured and consistent way of assessing all submitted opportunities, thereby increasing confidence in the quality of automation pipeline.

Work item basics

CoE Manager is composed of Opportunities, Business Units (referred to as workstreams by Shibumi), and a Program. In CoE Manager, these are all called work items. They are places to review and add information. Each of these work items are made up of tabs and sections.

[Work item basics](#)

Roles and user management

Users are assigned to specific roles, and the role determines how the user interacts with CoE Manager. In CoE Manager, all users have inherited permissions, which means that the permissions extend below where they have access.

[Roles and user management](#)

Workspace

CoE Manager workspace is divided into Navigation Sidebar, Header, and Work Area.

[Workspace overview](#)

Personas and available actions

CoE Manager personas represent the people within your organization who participate in your automation program. The titles given to these personas might not match the job titles used within your organization. Use the goal descriptions to help you map your organization titles to the CoE Manager personas. Once you have mapped your positions to the CoE Manager personas, the topics

to cover column (in Persona overview link below) highlights the solution activities most applicable to the persona. Persona-specific support site articles are available through the persona column hyperlinks.

[Persona overview](#)

Review automation program status

Review up-to-date program data in a single location to drive decision making.

[Reporting](#)

CoE Manager FAQ

For details and questions on the CoE Manager powered by Shibumi platform, review this FAQ.

Overview

What is CoE Manager?

CoE Manager (powered by Shibumi) is a cloud-based solution to manage the automation pipeline, delivery, and benefits of the automation program.

Why do I need CoE Manager?

CoE Manager helps you take control of your end-to-end automation lifecycle while accelerating pipeline generation. It helps CoEs to scale automation programs more quickly and efficiently driving core Automation Anywhere deployments and maximize the value (ROI) from your automation investment. CoE Manager elevates the value of the pipeline of automation opportunities to build the business case for additional investment.

I already have an existing app for managing my automation pipeline. Do I still need CoE Manager?

CoE Manager is a purpose-built automation CoE management solution that provides advanced capabilities to drive automation success and comes with a native integration with Automation Anywhere. It eliminates the manual overhead required in a homegrown tool and allows CoEs to focus on accelerating the automation pipeline instead.

Is CoE Manager a SaaS solution?

Yes, CoE Manager is hosted in Shibumi's cloud infrastructure. Shibumi uses AWS as their cloud provider. Currently, CoE Manager/Shibumi RPA accelerator is hosted in the AWS zones in North America, Germany, and Australia.

Which compliance standards does CoE Manager support?

Automation Anywhere and Shibumi are committed to maintaining compliance with key global information security and regulatory standards, including:

- Service Organization Control (SOC) 2, Type 2 certification
- CSA Cloud Controls Matrix standards compliance

What data retention policies, if any, are in place?

- EU Model clauses supported

Shibumi retains customer information for as long as the account is active, or for as long as it is needed to provide a customer or sponsoring organization with specific requested services.

Do I need Automation Anywhere to use CoE Manager?

No. CoE Manager can work independent of Automation Anywhere. However, Actual ROI information cannot be recorded in COE Manager unless it is linked with an Automation Anywhere Control Room.

What is the Opportunity Lifecycle enforced by CoE Manager? Can it be modified?

All opportunities in CoE Manager follow a tollgate process comprised of 4 stages given below:

- Stage 1: Idea
- Stage 2: Pipeline
- Stage 3: In progress
- Stage 4: Deployed

These four stages are not configurable by an administrator or end user. However, they can be customized by Automation Anywhere for your implementation of CoE Manager if desired. Contact your Automation Anywhere representative to explore this.

Can I use CoE Manager to manage my automation pipeline outside of Automation Anywhere?

Yes.

Does CoE Manager support single sign-on?

Yes, the CoE Manager supports full SAML or SAMLv2 integration into any IDP or SSO solution such as Okta.

Get started**How do I activate CoE Manager?**

Contact your Automation Anywhere representative if your organization has not yet purchased CoE Manager. Each SKU will represent a unit of one CoE Manager instance for an unlimited number of users per year.

How do I access CoE Manager?

Depending on the region from where CoE Manager was purchased, you can access CoE Manager through one of below links.

- [North America](#)
- [Europe](#)
- [APJ](#)

Note: Your account should already be setup in CoE Manager before you logging in. For the account

setup process, refer to [Getting started with CoE Manager](#).

Is there an integration between CoE Manager and Automation 360?

Yes, you can link up to three Automation 360 Cloud Control Room to a CoE Manager enterprise instance. This allows CoE Manager to collect bot activity data to monitor automation executions and calculate achieved savings. For an On-Premises environment, a bot will be provided to push data from an On-Premises Control Room to the COE Manager cloud.

Which version of Automation Anywhere is CoE Manager compatible with?

CoE Manager integrates with Automation 360 Cloud Control Room out of the box and integrates with On-Premises environments through a digital worker. For further details, refer to [CoE Manager](#).

Does CoE Manager require any third-party software applications?

No.

What are the hardware requirements for CoE Manager?

CoE Manager is a cloud-based solution accessible via a browser and does not need any hardware setup.

Which browsers does the CoE Manager support?

Google Chrome, Mozilla Firefox, Microsoft Edge, and Safari.

Can CoE Manager integrate with third-party reporting tools?

Yes. Contact your Automation Anywhere representative to explore this.

Can CoE Manager integrate with third-party process/task mining tools?

Yes. Contact your Automation Anywhere representative to explore this.

Does CoE Manager support APIs?

Yes. CoE Manager/Shibumi exposes create, read, update, and delete capabilities through its GraphQL API.

Can I customize dashboards?

Yes. This feature will be enabled in a future product release.

Can I export the dashboard and reports?

Yes. You can export to Excel or CSV wherever applicable. Export to PDF will be enabled in a future release.

Can I add new business units to manage my automation opportunities?

Yes. You can create as many business units as you need. Ability to add sub-business units will be provided in a future release.

How do I assign opportunity to a user?

You can assign the opportunity to a user as given below:

1. Open the opportunity.
2. Click the **Avatar** icon on the top right.
3. Enter the email address of the user you want to add.
4. Select the role and click **Add**.

I am unable to login into CoE Manager. What do I do?

Contact your CoE Manager administrator to start a password reset.

My organization already uses Shibumi. Can I use CoE Manager with Shibumi license?	No. A new license needs to be purchased from Automation Anywhere to use the CoE manager.
Can I do a bulk upload of automation opportunities?	Yes.
Where do I report a problem with CoE Manager?	For reporting any unexpected or deficient functionality, submit a support ticket to Automation Anywhere.
Can the email branding be changed to customer's requirements?	This feature is not currently available.
Can I rename, copy, move, or delete an opportunity?	Yes, you can access these options from the three vertical dots icon on the top right.

Bot Store

You can access Bot Store from the Control Room. From Bot Store, you can download bots or packages to your Control Room repository.

There are two ways for you to get bots and packages from Bot Store into your Control Room:

- You can load items directly from Bot Store to your Control Room, without needing to download the items locally. For details, see [Directly import bots and packages from Bot Store to Control Room](#).
- You can download items from Bot Store locally, then import them to your Control Room, even if your Control Room is not connected to the internet. For details, see [Download locally and import bots and packages from Bot Store to Control Room](#).

Resources: To learn more, see [Automation Anywhere Bot Store Learning Trail \(A-People login required\)](#).

Related concepts

[Bot permissions for a role](#)

Assign bot permissions when creating a role with the **View my bots** feature permission.

Access Bot Store from the Control Room

As a Bot Store registered user, you can log in to Bot Store from the Control Room.

You must have valid Bot Store credentials to access Bot Store from the Control Room. If you do not have valid Bot Store credentials, you must register with Bot Store.

1. Log in to the Control Room.
2. Click the **Bot Store** tab.
Bot Store opens in a separate window (<https://botstore.automationanywhere.com>).

3. Log in using your Bot Store credentials.

In the Control Room, you can see **My downloads** under the **Bot Store** tab.

Watch the following video on how to find bots on Bot Store.

Related concepts

[Bot Store](#)

You can access Bot Store from the Control Room. From Bot Store, you can download bots or packages to your Control Room repository.

Related tasks

[Submit bots or packages to Bot Store](#)

You can submit bots or packages from the Control Room to Bot Store. If your bot includes dependencies, submit all dependencies. Submit a demo bot that demonstrates the use of the package.

[Directly import bots and packages from Bot Store to Control Room](#)

You can load items directly from Bot Store to your Control Room without the need to download the items locally.

Submit bots or packages to Bot Store

You can submit bots or packages from the Control Room to Bot Store. If your bot includes dependencies, submit all dependencies. Submit a demo bot that demonstrates the use of the package.

You must have a system-created **AAE_Bot Store Publisher** role in order to submit bots or packages to Bot Store. See [System roles](#).

1. Download the A2019 Bot Store Bot template from GitHub: [A2019 Bot Store Bot Template](#).
2. Log in to the Control Room.
3. Log in to Bot Store using the Bot Store credentials.
4. On the left pane, click **Automation**.
A list of available and forms is displayed.
5. Click **Public** workspace and select the **Bot Store** folder.
6. In the **Automation** page, move your mouse over the **Action** toolbar and click **Submit to Bot Store**.
 - a) In the **Submit to Bot Store** page, review the dependencies that will be bundled with your bot (including a parent bot) and make changes as required. In addition, ensure that the bot and all dependent bots and files are in the same folder to submit to Bot Store.
 - b) Click **Next** to review the **Bundled packages** to ensure all packages are included with your submission.
 - c) If the bot you want to submit and the bundled package look complete, click **Submit**.
When choosing a name for your bot or package, ensure it is unique and descriptive so it is easily searchable on Bot Store.
Alternatively, click **Back** to go back.
When you submit your files, the system displays the following message: `<bot/package name> submission is in progress. Go to Bot Store > My Submissions` to complete your submission form. You will receive a confirmation email when the submission is completed.
 - d) Click **Take me to Bot Store** to complete your submission form in Bot Store.

When you resubmit files to Bot Store, it overwrites the previously submitted files, which are in a **Draft** status.

- It can takes three to five business days for review and approval of your bot or package.
- For any questions on bot and package submissions, contact [Contact Bot Store Support](#) or select the **Have questions about submitting a bot** option on Bot Store pages.

Related concepts

[Bot Store](#)

You can access Bot Store from the Control Room. From Bot Store, you can download bots or packages to your Control Room repository.

Related tasks

[Access Bot Store from the Control Room](#)

As a Bot Store registered user, you can log in to Bot Store from the Control Room.

[Directly import bots and packages from Bot Store to Control Room](#)

You can load items directly from Bot Store to your Control Room without the need to download the items locally.

Directly import bots and packages from Bot Store to Control Room

You can load items directly from Bot Store to your Control Room without the need to download the items locally.

You must have a system-created **AAE_Bot Developer** role in order to download bots or packages to your Control Room repository. See [System roles](#).

1. Navigate to Bot Store site.
2. Log in with your A-People credentials to download from Bot Store.
3. Select a bot or package.
Once you have selected your bot, you are redirected to a detailed bot page.
4. Click the **Get Bot** button.
A confirmation window prompts you to confirm the request.
5. Click **Ok, Get Bot** to confirm the request.
You can choose from the **Add to Control Room** or **Download as a zip file** options.
 - The **Add to Control Room** option requires you to specify your Control Room URL.
 - The **Download as a zip file** option requires you to save the bot locally on your device and confirm the location path for your download to begin.
6. Select the **Add to Control Room** option to load the bot directly to your Control Room.
7. Enter your Control Room URL.
8. Log in to the Control Room.
9. Navigate to the **Automation** page.
10. Open your **Bot Store** tab.
11. Click **Add to RPA Workspace** in the **Action** toolbar.
The following message appears: `If you have any files already installed in private workspace, they will be overwritten.`
12. Select **Yes, continue** to overwrite an existing file and continue with the installation, or select **No, cancel** to cancel your download.
The installation status of the selected file changes to `Installed`.
13. Verify the downloaded bots in your Bot Store folder of the private workspace.
The custom packages downloaded from Bot Store are available in the **Packages** repository. You can navigate **Bot Editor > Action Palette**.
14. Verify that the downloaded packages have been enabled in the **Packages** repository. If the packages are not enabled, then go to individual packages and enable them.

Watch the following video on how to download a Bot Store bot to your Control Room.

Related concepts

[Bot Store](#)

You can access Bot Store from the Control Room. From Bot Store, you can download bots or packages to your Control Room repository.

Related tasks

[Access Bot Store from the Control Room](#)

As a Bot Store registered user, you can log in to Bot Store from the Control Room.

[Submit bots or packages to Bot Store](#)

You can submit bots or packages from the Control Room to Bot Store. If your bot includes dependencies, submit all dependencies. Submit a demo bot that demonstrates the use of the package.

Download locally and import bots and packages from Bot Store to Control Room

You can download items from Bot Store locally then import them to your Control Room, even if your Control Room is not connected to the internet.

You must have a system-created **AAE_Bot Developer** role in order to download bots or packages to your Control Room repository. See [System roles](#).

1. Navigate to Bot Store site.
2. Log in with your A-People credentials to download from Bot Store.
3. Select a bot or package.
Once you have selected your bot, you are redirected to a detailed bot page.
4. Click the **Get Bot** button.
A confirmation window prompts you to confirm the request.
5. Click **Ok, Get Bot** to confirm the request.
You can choose from the **Add to Control Room** or **Download as a zip file** options.
 - The **Add to Control Room** option requires you to specify your Control Room URL.
 - The **Download as a zip file** option requires you to save the bot locally on your device and confirm the location path for your download to begin.
6. Select the **Download as a zip file** option
You can save the bot locally on your device and when you confirmed the location path, your download begins.
7. Log in to the Control Room.
8. Navigate to the **Automation** page.
9. Click **Import bots**.
10. Click **Browse**.
11. Select your downloaded zip file at the location path you saved.
12. Specify the option to have your bot in the **Public** or **Private** tab.
13. Click **Import** to import the downloaded bot.
14. Navigate to the **Public** or **Private** tab that you specified.
15. Open your **Bot Store** folder.

16. Access the bot.

You can now use the bot from Bot Store to start your automation experience.

To use a Bot Store package, open the bot you want to edit and access package from the **Actions** panel.

Note: For users who want proxy access to Bot Store, you can reference this knowledge base [article](#) for a workaround.

Getting started with Private Bot Store

Use Private Bot Store to view and submit bots and bot use cases within your company. Use admin tools to review and publish bots and manage users.

The following is a high-level overview of how to get started with Private Bot Store:

1. The Private Bot Store support team creates admin users for your company.
2. Optionally, the support team helps you set up SAML-based SSO or Active Directory Federation Services (ADFS) integration.
3. Admin users grant other users Private Bot Store access and permissions. (It is automated if you use SAML-based SSO or ADFS).
4. Users create bot listings and submit them for approval.
5. Admin users can approve or reject the submitted bots.
 - If approved, the bot listing is published and is available on Private Bot Store for other users within the organization to view.
 - If rejected, the bot author receives feedback on what has to be updated. The bot author updates the bot and resubmits it.
6. Other employees within the company access the published bot listings and use them in their automation tasks.

Related concepts

[Private Bot Store](#)

Private Bot Store is a secure internal bot marketplace for a company to post and share details and documentation for all internally developed bots. Employees can easily discover internal bots and commands to reuse in addition to all of the bots from the Automation Anywhere Bot Store vendors.

Set up A-People user access to Private Bot Store

A-People user access and management is included out-of-the-box with Private Bot Store. Within Private Bot Store, your company admin can manage users. Other users with granted permissions can access Private Bot Store with the same credentials they use for public Bot Store and other Automation Anywhere sites.

- **Set up A-People user access**

After your first admin users get access to Private Bot Store, they can add additional users. Any Private Bot Store user with admin access can manage users from the **Private Bot Store - User Access Settings** page.

- **Add new users individually or in bulk**
 - a) Navigate to **User Access Settings**.
 - b) Click **Add Users**.
 - c) Enter the email addresses for the users you want to add.
Invited users will receive an invitation email with instructions to set up their account.
- **Change user permission level**

Only admin users can modify permission levels by selecting the correct level in the **Access** panel.
- **Delete users**

Select **Delete** in the **Actions** panel.

Related tasks

[Submit and approve bots using Private Bot Store](#)

Use Private Bot Store to submit, review, and approve detailed bot listings for all of the bots your team has built.

Set up SAML user access to Private Bot Store

Use SAML-based single sign-on (SSO) or Active Directory access to ensure that your Private Bot Store user access is updated automatically when users join or leave your company. Users can log in to Private Bot Store using the same credentials they use for other applications.

- **Set up SSO or Active Directory Federation Services (ADFS) user access**

The Private Bot Store support team will help you set up **SSO** or **Active Directory** user access.

 - Provide details about Private Bot Store in your identity provider (IdP) settings.
 - Provide the Private Bot Store support team some information about your system.

The Private Bot Store support team will verify the information and complete the integration.

After the integration is completed, your Private Bot Store user access will be managed automatically by your SSO or ADFS user access.
- **Change user permission level**

Admin users can change a user's permission level by navigating to the Private Bot Store **Settings** page and updating user permissions.

Admins can only modify a user permission level if a user is an active Private Bot Store user.

Related tasks

[Submit and approve bots using Private Bot Store](#)

Use Private Bot Store to submit, review, and approve detailed bot listings for all of the bots your team has built.

Submit and approve bots using Private Bot Store

Use Private Bot Store to submit, review, and approve detailed bot listings for all of the bots your team has built.

- **Submit internal bots:**

To submit a new bot:

- a) From Private Bot Store, click **My Submissions**.
- b) Click **Add New Bot**.
- c) Enter all the required fields, such as bot description, benefits, and requirements.
- d) Review the documentation examples for each field and follow the suggested guidelines.
- e) Click **Submit** or click **Save** to save the bot before submitting it.
After you submit your bot, your Private Bot Store admin team receives an email to review the bot.
Your bot will be published or it might be send back for an update and resubmission.

- **Review internal bot submissions**

Private Bot Store admin users approve or reject bot submissions before they can be published.

- a) As an admin user, navigate to Private Bot Store and click **All Submissions**.
- b) Click **Review Bot** to review each submitted bot.
- c) Approve or reject the submitted bot:
 - **Approve and publish a bot:** On the **Review Bot** page, click **Approve** to publish the bot.
 - **Reject the bot and request updates:** On the **Review Bot** page, click **Reject** to reject the bot and send feedback to the bot submitter with instructions for updates.

Submit and manage bot ideas using Private Bot Store

Use Private Bot Store to submit, manage, and prioritize bot ideas for your development requirements.

- **Submit bot ideas**

- a) From Private Bot Store, click **Suggest Bot Idea**.
- b) Fill in all the fields about your bot idea, with as much detail as possible.
- c) Click **Submit**.
After you submit the bot idea, your admin team will review and prioritize it. The admin team might contact you for more information about your bot idea.

- **Manage bot ideas**

Private Bot Store admin users can manage and prioritize bot ideas.

- a) As an admin user, navigate to Private Bot Store and click **Manage Bot Ideas**.
- b) Click **Review** to review each submitted bot idea.
- c) Edit any of the fields as required.
- d) Select a **Bot Priority** level for the bot idea.
- e) Click **Save**.
- f) Click the **Mail** icon to contact the bot idea submitter to request additional details.

Watch the following video on how to submit a bot idea to Bot Store.

Custom filter management in Private Bot Store

Create your own filters and tags to organize your automations in Private Bot Store using the custom filter management page.

Custom filter management enables you to perform the following activities:

- Rename any of the default filters such as **Applications** and **Departments**, and tags (specific categories) such as **Excel** and **Finance**.
- Add up to six of your own custom filters.
- Add your own custom tags, with up to three nested layers of tags, for example, 2021 > Q1 > January.
- Select which filters you want to appear first in your Private Bot Store navigation.
- Select up to five top tags to appear first under their filter.

The custom filters are displayed throughout Private Bot Store, including:

- In the top navigation, filters on the left, and search results.
- On the listing submission form, where bot builders can select custom tags for their bots.
- On bot detail pages, where users can see how each bots is categorized.

Edit filters

1. You must have an admin user permission to access the **Manage Filters** page in Private Bot Store.
2. Navigate to **Private Bot Store > Manage Filters > Admin Tools > Manage Filters**.
3. Edit the default filters to match your company terminology.

Whenever possible, use default filter names, such as **Departments**, rather than creating your own filters. As a result, all the existing bots are already tagged and you do not have to tag them again.

4. Under **Actions**, click the **Rename Filter** action (pencil icon) to rename the filter.
5. Click **Add Filter** to add a new filter. Enter the name for the new filter.

You can add up to six custom filters.

6. Select a filter and click **Reorder entry** on the left and place the filter into your desired order.

The filter order is reflected in the Private Bot Store navigation and the filter panel.

7. Click the delete (X) action in the right column to delete any custom filter.
You cannot delete default filters.

Edit tags

1. Navigate **Admin Tools > Manage Filters > Actions** select a filter and click the tree icon **Add and Edit Tags** action.
2. Select a tag and click the tree icon to **Add Child Tag** within a tag. Enter a new child tag name.
You can add up to three layers of nested tags.
3. Click the **Rename Tag** action to rename any tag.
For the default tags, the original **Tag Name** continues to appear in the **Default Name** column for your reference.
4. Select up to five **Top Tag** in the left column to display those tags at the top of the list within each filter.
Use this for your company most-used applications or other important bot categories. Other than the selected **Top Tag**, tags are displayed in alphabetical order.
5. Click the delete (X) action to delete any custom tag.
You cannot delete the default tags.

Optimize

Bot Insight is an analytics platform that provides real-time, interactive, and smart insights about business processes and operational intelligence. Bot Insight is available with out-of-the-box dashboards that you can start using instantly. These dashboards provide analyzes to measure the performance of your digital workforce and predict and solve preventable business problems.

Business analytics through Bot Insight

Automation Anywhere Bot Insight processes real-time and interactive insights about business processes, and provides operational intelligence. Access the bots, and manage and instrument them to gather business analytics and insights, and publish dashboards.

1. *Create and edit bots*

The cloud-based bot editor provides tools, packages, and actions to create bots to automate processes.

2. *Instrument the bot for analytics*

Business analytics provides information about the transactional analytics for the data that is logged by the variables that are tagged in a task. The information provided can be about the total sales in a month, invoicing and payment trends, insight about new customers, and quote-to-order ratio.

3. *Access Bot Insight*

Access Bot Insight to perform the business analytics.

4. *Customize dashboards and widgets*

Dashboards represent the RPA infrastructure in the form of meaningful visuals and charts, so that you can analyze, interpret, and take action on the updates that are important to you. The dashboards display dynamically updated information of active users, registered clients, failed tasks, apps, bots, bot schedules, workflows, queues, and the overall status of devices.

5. *Publish a business analytics dashboard*

Publish a dashboard to display the production data generated by the task. The analytics consumers who primarily analyze and interpret data can access the published dashboard.

To learn more, search for the *Managing RPA Reports Using Automation 360* course in [Automation Anywhere University: RPA Training and Certification \(A-People login required\)](#).

Related concepts

[Bot Insight dashboards](#)

The Bot Insight dashboards provide dedicated graphical insight to help you view your bot information.

Related tasks

[Run your first bot](#)

Run a bot from the same device that you used to create the bot.

Related reference

[Analyze package](#)

Use the actions in the **Analyze** package to specify the actions and variables to use in the Bot Insight dashboard and widgets. The **Analyze** package enables you to perform transactional analytics for the data that is logged by the variables when the bot runs.

Accessing Bot Insight

This section provides information about how to access Bot Insight.

To use Bot Insight, the Control Room must have the Bot Insight license applied, and you must be logged in as a user with one of the following roles:

1. AAE_Bot Insight Expert
2. AAE_Bot Insight Consumer
3. AAE_Bot Insight Admin

Access Bot Insight from the Control Room

Access Bot Insight to interactively analyze bot data and enhance bot widgets.

Access Bot Insight from the Control Room in one of the following ways:

- From the Control Room, select **Dashboard**.
 - a) Locate the **Insights** tab.
 - b) In the **Insights** tab, click **Explore Bot Insight**.
The Bot Insight window appears.
- On the left panel, click **Automation**. A list of available bots and forms is displayed.
 - a) In the **Automation** page, click **PUBLIC** to view the public bots that can be viewed, run, and checked out by other people, based on the permissions set by the administrator.
 - b) Click **PRIVATE** to view your bots and files.

Note: Private bots and files cannot be viewed by other users. If a bot or file is checked out from the **PUBLIC** tab, it can be viewed and run by other users. However, the bots and files cannot be edited by other users.

- c) Select your bot from the **Files and Folders** menu.
Alternatively, enter the search parameters in the **Search Name** field and search for your bot.
- d) Open the bot and click **Analyze**.
The Bot Insight window appears.

Roles to access Bot Insight

The Control Room restricts Bot Insight access to users with certain roles.

Access to the dashboard depends on the user roles assigned to a user and the access permission granted to those user roles. See [Role-Based Access Control](#).

System-generated access is provided to all user types for Bot Insight. Admins can customize the Bot Insight experience by assigning a user-generated role to users. Each role includes a permission set, designed to specialize Bot Insight features to make analytics more simple or comprehensive. Admins

should evaluate user tasks and functions to assign the role most appropriate to fulfill user responsibilities, based on the following details.

Note: Various types of dashboards can be accessed for quick insights. Common types are listed below. For more details on dashboards, see [Dashboards overview](#)

- The **system-generated** dashboard is also known as a **Default** type.
- The **user-generated** dashboard is also known as a **Custom** type.
- The **Published** dashboard is also known as the **Production** type.
- When a published dashboard is saved by a user, the dashboard copy is known as a **custom production** type.

Apart from Bot Creators, users with the following roles have access to business analytics dashboards:

Bot Insight Admin

Use this role to perform the following operations in Bot Insight:

- Access Bot Insight API
- Analyze the Data Profile of the task data for which the dashboard report is generated.
- Analyze and save the system-generated dashboards.
- Analyze, save, publish, and delete the user-generated dashboards and publish dashboards.
- Bookmark, compare, and share the dashboards.

Bot Insight Expert

Use this role to perform the following operations in Bot Insight:

- Analyze the data in the dashboards that are deployed in the production environment.
- Save the system-generated dashboards.
- Analyze, save, publish, and delete the user-generated dashboards and publish dashboards.
- Bookmark, compare, and share the dashboards.

Bot Insight Consumer

Use this role to perform the following operations in Bot Insight:

- Analyze the data in the dashboards that are deployed in the production environment.
- Bookmark, compare, and share the publish dashboards.

Role-based access control in Bot Insight

Role-based access control (RBAC) enables a Control Room administrator to restrict access to the various components of Bot Insight.

The Control Room administrator can grant access to various user roles based on your requirements. When adding a user, you assign appropriate roles to that user. A user will have access to the components and folders based on the roles assigned to them.

Requirements

Before you publish the dashboard, ensure that the following requirements are met:

- The bot resides in the Public workspace for which you want to publish the dashboard.
- You have the **View my bots** and **Check in** permissions to the folder that contains the corresponding tasks. You need these permissions to move your bots from Private workspace to Public workspace.

RBAC for business analytics

Dashboards for business analytics are available for the tasks that are enabled for analytics. The Control Room administrator and users who have access to a task can view the dashboards for those tasks. You can access the dashboard for a task from the **Insight** tab in the **DASHBOARD** section of the Control Room and from the **ANALYZE** tab in the Workbench.

To view the Bot Insight dashboards, you must be granted access to the folder containing the corresponding tasks.

For example, you have created various tasks related to sales and accounting and stored them in the Sales and Accounts folder. If you want to grant access to the sales-related tasks to members of your sales department, you need to provide them access to the Sales folder. The same applies to grant access to the accounts-related tasks in the Accounts folder.

The following table illustrates the access the various members of the Sales and Accounts team will have:

	Sales_Dep			Accounts_Team	
	John	Mark	Dave	Smith	Micheal
Access to the Sales folder	Yes	Yes	Yes	No	No
Sales1	Yes	Yes	Yes	No	No
Sales2	Yes	Yes	Yes	No	No
Access to the Accounts folder	No	No	No	Yes	Yes
Accounts1	No	No	No	Yes	Yes
Accounts2	No	No	No	Yes	Yes
Accounts3	No	No	No	Yes	Yes

Bot Insight dashboards

The Bot Insight dashboards provide dedicated graphical insight to help you view your bot information.

Dashboards display meaningful visuals and charts so that you can analyze, interpret, and take action on the updates that are important to you. You can use dynamically updated information about active users, failed tasks, apps, bots, bot schedules, workflows, queues, and the overall status of devices to create custom dashboards and widgets.

Note: You must use the Analyze package version 2.3.0-20210922-121532 or later to generate the dashboard when running analysis. This package version is available from Automation 360 v.23.

Perform the following steps to apply the package.

1. From the Control Room, select **Manage > Packages > Analyze**.

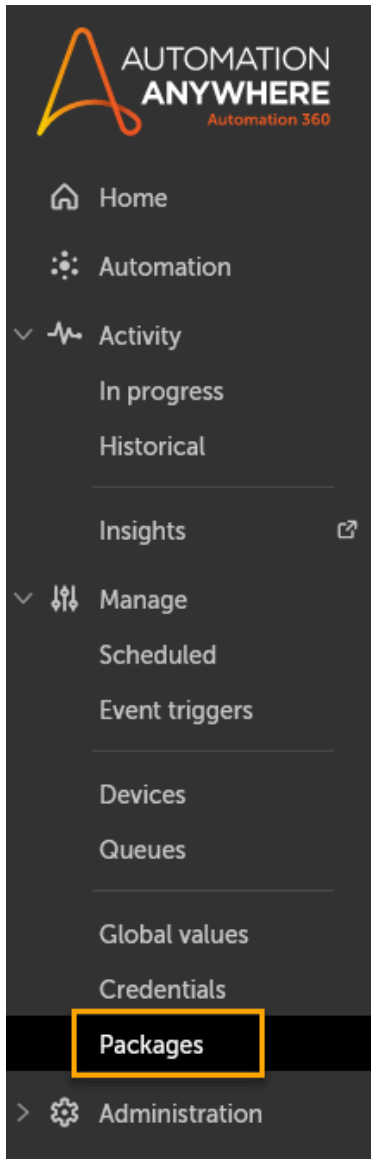

Analyze

This page shows the package details of the selected version. You can also select a different package v

Versions

2.4.2-20220414-053004



Enabled

2.4.2-20220414-053004 Default

2.4.0-20220118-153149

Actions

Actions (2)

> Close

> Open

General Details

Last modified
22 hours ago

2. Change the Analyze package version to 2.3.0-20210922-121532 or later.
3. Save your changes.
4. Run the bot and ensure the change to dashboard generation.

Note: For changes to be applied to the public workspace, **checkIn** your bot before running analysis.

When you create and run a bot, Bot Insight automatically creates a default dashboard in the collection: My dashboards. If you have a parent bot and a child bot, Bot Insight creates a separate dashboard for each of the bots.

When you deploy and run a bot on the Bot Runner machine, Bot Insight aggregates all the information related to that bot. The published dashboard for that bot displays the aggregated bot information.

Note: Some data might not populate in a widget if bots were created in Automation 360 v.12 or earlier versions. See the following article for troubleshooting: [Bot Insight dashboard not populating data in specific widgets \(A-People login required\)](#).

My dashboards displays the following dashboards:

- [Operations dashboard](#)
- [Business dashboard](#)

Note: You must have either the `AAE_Bot Insight Admin` or the `AAE_Bot Insight Consumer` role assigned to you to view the published dashboard.

Viewing Bot Insight dashboards

The Bot Insight dashboards provide customizable widgets for you to gain insights in specific scenarios. You can view information about your bots on the Bot Insight dashboards from the Control Room.

When you tag variables for analytics in a task and then run the task, Bot Insight generates the analytics dashboard. By default, the system-generated dashboard has the same name as that of the task. You can customize this dashboard to your requirements.

Business analytics provide information on the transactional analytics for data that is logged by the variable tagged in a task. The information provided can be about total sales in a month, invoice, payment trends, new customer insights, or quote-to-order ratio. You can select your dashboard from the **Select a Dashboard** drop-down menu to view the analytics.

Bot Insight provides the following dashboards:

- **Configure**

The system-generated dashboards are available in the **Configure** tab in the Bot Insight window.

- **Analyze**

The customized dashboards can be published and are available in the **Analyze** tab in the Bot Insight window.

- **Operation**

The **Operation** dashboard provides information about bots that are created, deployed, or scheduled to run across different Bot Runner machines. You can use the information to enhance productivity and take measures based on real-time information for RPA deployments.

1. Log in to the Control Room with one of the following roles:

- `AAE_Bot Insight Admin`
- `AAE_Bot Insight Expert`
- `AAE_Bot Insight Consumer`

2. Click **Explore Bot Insight** from the **Insights** tab.

The Bot Insight dashboard appears in a new window.

Viewing Insights

You can view information about business data in Bot Insight.

Click **Insights** from the **Analyze** tab to view information about interesting facts on business data.

The Insight dashboard provides information about business data that is logged through Bot Insight without the need to analyze the dashboards. It provides a snapshot of data that you can use to enhance your bot productivity. This feature highlights important facts that are inferred from within the business process data logged by the bots.

A bot created to process orders displays the following information:

- Total processing cost
- Process time
- Monthly payment
- Total payment

The dashboard provides information about the difference between the calculated metric values for a specific time interval:

- Yesterday
- Last 7 days
- Last 30 days

The Insight dashboard enables you to configure the variance thresholds for indicating metric-level health.

Perform the following steps to configure the variance thresholds:

1. Click **Settings**.
2. In the **Variance Threshold** window, move the slider to the left or the right to adjust the variance threshold.
 - Move the slider to the left for a **Poor** metric health level.
The poor metric level health is represented in red.
 - Move the slider to the right for a **Good** metric health level.
The good metric level health is represented in green.
3. Enter the values in the **Fair** field to set the **Fair** metric health level.
4. Select the **Switch poor and good** check box to switch between the **Poor** and **Good** metric health levels.
5. Click **Save**.

Operations dashboard

The Bot Insight Operations dashboard provides information about bots that are deployed on different Bot Runner machines and bot statistics based on performance. You can use this information to enhance productivity and take measures based on real-time information for RPA deployments.

The Operations dashboard provides visual insight into various operational aspects of bots and displays hyperlinks to the following dashboards:

- Bots Dashboard
- Audit Dashboard
- Device dashboard

Note: Ensure that you have the **AAE_Admin** role to view all bots information in the operations dashboards.

These dashboards appear as the Default dashboards and are automatically created by Bot Insight based on the variables that are used in the bot. You can use the **Save As** function to save the Default

dashboard as a Custom dashboard. You can also add widgets from the Visualizations menu to your custom dashboards.

Using widgets

Bots Dashboard

You can view information about the bots that are created, deployed, scheduled, and running across various Bot Runner machines.

The dashboard displays the following bot information:

- **Total Bot Runs:** Displays the total number of times the checked-in bots executed from the Bot Runner machines. (The number displays the total number of bots that have run successfully and failed to run).
- **Total Completed (Success):** Displays the number of bots that have ran successfully.
- **Total In Progress:** Displays the number of in-progress bots.
- **Total Failed:** Displays the number of bots that had failed to deploy or run.
- **Weekly Bot Status:** Displays the weekly status of bots that are scheduled to run.

Tip: You can hover over the widget to view the number of bots that have run successfully, failed to deploy, and failed to run. It also displays the weekly bots statistics percentage.

- **Failure Reasons:** Displays reasoning information on bots that had failed.

Note: The **Error Message** field displays a snapshot of the original error message and extensive details on why the bot failed. You can export the error messages and logs to a CSV file, which you can later use to troubleshoot.

Audit Dashboard

This dashboard displays various widgets that provide information about Control Room events. Users with the `View everyone's audit log actions` permission have access to view the audit information captured in the Control Room.

System roles.

The dashboard displays the following information:

- **Event Distribution by Activity Type**
- **Event Distribution by User Name**
- **Event Distribution by Source**
- **Event Distribution by Control Room Source**
- **Event Distribution by Workbench Source**

You can perform the following actions in the Operations dashboard:

- Enter the name of the dashboard in the **Search** text box to access a dashboard.
- Click the **Favorite** tab to bookmark your dashboard.
- Double-click the **Favorite** menu to remove bookmarks.

You can view information in the following tabs:

- **Total Views:** Displays the number of users who viewed a particular dashboard.
- **Last Refreshed:** Displays the time and date of when a particular dashboard was last refreshed.

You can click the arrow next to the Operations dashboard tabs to organize the dashboards to your requirements.

You can customize the widgets in the Operations dashboard. You can perform the following functions:

- [Working with Bot Insight dashboards](#)
- [Comparing dashboards](#)
- [Sharing a dashboard](#)
- [Taking a screenshot of a dashboard](#)
- [Downloading a PDF file from a dashboard](#)

Device Dashboard

The Device dashboard displays various widgets that provide information about resource utilization of the machines on which bots are executed.

The dashboard provides key metrics to analyze the status and utilization of devices. It also displays the activity history of the bots that are deployed on the machines.

The dashboard displays the following information:

- **Online Devices:** Displays the number of Bot Runner machines that are active or online at a point in time.
- **Offline Devices:** Displays the number of Bot Runner machines that are inactive or offline at a point in time. Devices can be online even though no bots are deployed on them.
- **Bot Schedules on Devices:** Displays the number of bots that are scheduled to run on all the Bot Runner machines.
- **Device Utilization%:** Provides the overall time used by bots that are executed across all the Bot Runner machines. You can view and analyze the utilization information by date using the following criteria:
 - Bot duration
 - Unit: %
 - Group 1: Start date time of a bot (interval: day)
 - Group 2: device name

There is no limit on the number of devices that can be displayed on the dashboard.

- **Device Activity History:** Provides information about the execution history of bots deployed on each Bot Runner machine. The Device Activity History table provides the following information:
 - Device name
 - Bot name
 - Bot duration (milliseconds)
 - Start date time of a bot
 - End date time of a bot
 - Status

When the Group1 and Group 2 fields have date type variables and you select **Bot Duration** as a metric, the **Percentage (%)** option appears as an additional option for **Bot Duration Unit**. Based on the selected group interval, the percentage is calculated for the bot duration.

Example: When you select the parameters in the following fields as:

- Group By or Sub By: Date
- Interval: Year
- Metric: Bot Duration
- Bot Duration Unit: Percentage (%)
- The percentage calculated for bot duration is:

$$(10000/1000ms * 60s * 60m * 24h * 365days) * 100 = \%$$

Note: The percentage calculation of the bot duration is available in all the widgets, except datatable and maps.

- **Top Error Messages:** Provides information about the error messages for any bot failure and the frequency of occurrence.

Business dashboard

The Bot Insight Business dashboard provides information about the Bot Insight data and statistics based on bot performance. You can use this information to enhance your productivity and take measures based on real-time information for RPA deployments.

The Business dashboard provides visual insight into the various business aspects of the bots. From this dashboard, you can access both the Default and Custom dashboards.

Bot Insight automatically creates the Default dashboard based on the variables that are used in the bot. You can use the **Save As** function to save the Default dashboard as a Custom dashboard. You can also add widgets from the **Visualizations** menu to your custom dashboards.

Using widgets

In the Custom dashboard, Bot Insight enables you to export data from a dashboard widget to CSV files.

Exporting data from a dashboard widget

You can perform the following actions in the Business dashboard:

- Enter the name of the dashboard in the **Search** text box to access a dashboard.
- Click the **Favorite** tab to bookmark your dashboard.
- Double-click the **Favorite** menu to remove bookmarks.

The dashboard displays the following bot information:

- **Bot Name:** Displays the name of bots that are associated with the business dashboards.
- **Total Views:** Displays the number of users who viewed a dashboard.

- **Last Refreshed:** Displays the time and date on which a particular dashboard was last refreshed.
- **Modified By:** Displays the name of the user who had last modified the dashboard.

You can click the arrow next to the Business dashboard tabs to organize the dashboards to your requirements.

In the **Dashboard Name** tab, select the dashboard that you want to access to view the dashboard. You can also enter the name of the dashboard in the **Search** text box to access the dashboard directly.

Click **Rank** in the **Distinct Count** row to view the rank of each variable. You can view the string data type values that are logged by a variable for the maximum or minimum number of times. This further enhances your ability to verify that the data is logged correctly in the bot.

Viewing ranks of string datatype values

The Business dashboard widgets displays the following information:

- The total number of variables
- The comparison between number variables and transaction status
- The comparison between number variable distribution and transaction status
- A bar chart representing the distribution between the number variables and string variables
- A pie chart representing the relationship between variables in numbers and strings

The Profile dashboard displays bot variables and the transaction data. The Task Name table displays the variable name, display name, data type, inclusion details, maximum, minimum, average, sum, distinct count for the date, string, and number variables.

The Transaction Data table displays the variable name, display name, data type, inclusion details, minimum, maximum, average, sum, and distinct count metrics for the following parameters:

- **Machine Name**
- **Transaction Name**
- **Transaction Start Time**
- **Transaction End Time**
- **Total Transaction Duration** (Start Time - End Time)
- **Transaction Status** (In Progress or Completed)
- **User Name** (User who runs the bot)

You can use the **Preview Data** option to view the total number of records maintained for each variable. When you create and run a bot with multiple **Transaction Blocks** with **Analyze, Open, or Close** commands, all the tagged business variables are displayed in the **Transaction Names** menu.

You can customize the widgets in the Business dashboard. You can perform the following functions:

- *Working with Bot Insight dashboards*
- *Comparing dashboards*
- *Sharing a dashboard*
- *Taking a screenshot of a dashboard*
- *Downloading a PDF file from a dashboard*

Document Workspace dashboard

The Document Workspace dashboards provide visualizations of learning instance performance and quality metrics as well as validation operations metrics.

Users with access to Document Automation can view and customize the Document Workspace dashboard without additional permissions.

The Document Workspace dashboard contains eight widgets, which contain visualizations of learning instance data. The widgets are customizable:

- You can reposition a widget by dragging and dropping it into a new location.
- You can apply filters, such as by specific learning instance or time frame. [Adding a dashboard filter](#)
- You can click a data point in a widget to "drill down" or filter the metrics in that widget. See the following video: <https://aa2019packagesdkfordocumentation.s3.us-west-2.amazonaws.com/drill-down-feature.mp4>

Document Workspace widgets

Widget	Description
Accuracy % statistics for document fields	A horizontal stacked bar chart that shows the straight-through processing percentage for each field in the learning instances
Extraction time per documents	A horizontal stacked bar chart that shows the average extraction time per learning instance in milliseconds
Number of uploaded documents	A line chart that tracks the total number of files uploaded each day
Number of uploaded pages	A line chart that tracks the total number of pages uploaded each day
STP% over learning instance name	A horizontal bar chart that shows the straight-through processing percentage for each learning instance
STP% over timeline	A line chart that tracks the straight-through processing percentage for all the learning instances by day
Validator performance by weighted average validation time	A horizontal bar chart that shows the weighted average time each Validator user spent performing manual validation per document.
Validator performance by # of documents validated	A horizontal stacked bar chart that shows the number of documents each Validator user validated per day

Dashboard filters

Use the following dashboard filters to customize the metrics included in the dashboard:

- Learning Instance Name

Note: By default, both public and private learning instances are included in the dashboard

- Document Type
- Page Count
- Created On

Note: When you set a filter, it is applied to the entire dashboard. To apply a filter to a specific widget, open the **Widgets** menu and select which widgets to apply the filter:

The screenshot shows the 'Dashboard Filter' interface. On the left, there are three filter categories: 'Attributes' (with 'Learning Instance Name' and 'Document Type' listed), 'Numeric' (with 'Page Count'), and 'Time' (with 'Created On'). The 'Document Type' filter is selected. On the right, the 'Dashboard' view shows a widget titled 'Extraction time per documents'. A modal window titled 'Document Type' is open, showing options to 'Include' (selected) or 'Exclude' document types. Below this is a search bar 'Search Document Type' and a list of document types: 'Document Type', 'Invoices', 'Receipts', 'User-defined', and 'Utility Bill'. At the bottom of the modal, there is a 'Widgets' section with a 'Show' button and a large 'APPLY' button.

Related tasks

[Sharing a dashboard](#)

You can share the link to view a dashboard through email using the **Share via email** option.

[Downloading a PDF file from a dashboard](#)

You can download the data available in the dashboard as a PDF file.

[Taking a screenshot of a dashboard](#)

You can take a screenshot of the data available in the dashboard.

AARI dashboard

Use the AARI dashboard in Bot Insight to view various widgets that provide information about requests created from published processes in Automation Anywhere Robotic Interface (AARI).

Overview

The dashboard provides statistics and shows information about created requests for each process, which can vary from a simple summary to a complex cross-departmental view. You can use this real-time information to make process-related operational decisions. For example, consider a scenario where a manager can get a high-level activity overview of completed and pending tasks in the payroll process, which can then help the manager take necessary actions about the process.

From the AARI dashboard, you can access both the Default and Custom dashboards. Bot Insight automatically creates the Default dashboard from the variables used in the process. You can use save the Default dashboard as a Custom dashboard if required. You can also add widgets from the visualizations menu to your custom dashboards.

Based on RBAC, the following users have access to view the data on the dashboard:

- **AAE_Robotic_Interface_Admin** can view all data inside AARI on the web interface across all teams.
- **AAE_Robotic_Interface_Manager** can view all data inside AARI on the web interface for their own teams.

What you can view in AARI dashboard

The dashboard helps you to visualize and track the number of requests that are open, completed, canceled, or failed.

The dashboard also provides the following capabilities:

- **Heat map chart:** Visualize data about the percentage of request created for each process for a day. You can specify the dates by function (day) to get specific information using the following criteria:
 - Group1: created date (interval: day)
 - Group 2: process name
 - Metric: request created in percentage (%) for each process
- **Request activity history:** This table provides the execution history of the processes deployed on each Bot Runner machine. It includes information such as the following:
 - Process name
 - Username
 - Request details such as the status, ID, end time and start time, duration
 - Total human and bot duration
 - Total human and bot tasks
- **Stacked bar chart:** Analyze the average duration taken by each process for human and bot tasks. For example, consider that there are two processes named API Test-Form 1 and API Test-Form 2 in the bot

task type. For each process, the chart shows the average time (in seconds) taken for its execution. You can view and analyze this information using the following criteria:

- Group 1: task type (human and bot)
- Group 2: process name
- Metric: duration (average)

Editing a data profile

You can modify the data profile of both the Default and Custom Business dashboards without modifying the bots.

You can edit the data profile and regenerate the dashboard based on the new data profile. You can edit the display name of a variable, change its data type, and exclude it from the dashboard.

Bot Insight provides smart data profiling for information about countries, states, and zip or postal codes. Bot Insight analyzes the information provided in the variables and automatically identifies the information as:

- Country (country code or country name)
- State (state code or state name)
- Zip code (five-digit zip code)

You can edit the data profile to convert the above parameters from numeric format to string format (country and state) based on your requirements. You can convert the zip code to either string or numeric format, and use the information to create widgets (world and US map widgets) in the Bot Insight dashboard.

1. Open the Bot Insight dashboard.
2. Click **Profile**.
The **Profile** window appears, displaying all the variables that you have tagged during the bot creation.
3. Click **EDIT**.
4. Specify a new name for a variable in the **Display Name** field.
5. Select an option from the **Datatype** drop-down list to specify a new data type for a variable.
You can change the datatype of a numeric variable to string, string to country, state, and zip code.

Note: Changes to the **Data Type** parameter cannot be reverted.

6. Clear the **Inclusion** check box to exclude the variable from the dashboard. Select **Inclusion** to include a variable from the dashboard and configure how the initial SMART dashboard is generated.
You can view the minimum, maximum, average, sum, and last value for the numeric values, but not for the string and timestamp variable types.
7. Click **Save and Generate Dashboard** to save the changes and generate the dashboard with the updated value.

Bot Insight dashboard filter

The Bot Insight dashboard filter enables you to apply filters across your dashboards to display the filtered data. You can save and publish the custom dashboards with preset filters.

Filters in the Bot Insight dashboard enables you to choose different views of the data. You can apply and save filters in a dashboard to preserve the filtered view. The filtered view displays the same view the next time you view the dashboard.

Dashboard filters enables different combinations of data in a single dashboard. The filter eliminates the need for separate dashboards for different users. A single-filtered dashboard allows you to serve data requirements for a wide range of users.

You can access the dashboard filter from both the Operations and Business dashboards. You can click each item in the filter list to view the parameters. You can search for a specific parameter in the **Search Automation Name** field in the **All** tab. You can select parameters based on whether to include or exclude them in the filter. The selected parameters appear in the **Selected** tab.

When you apply a specific filter, the visual indicator in the dashboard displays the name of the applied active filter. You can delete a dashboard filter by clicking the delete icon. When you publish a custom dashboard with the applied the dashboard-level filters, the published dashboard contains the same filters. You can click **Widgets** in the widget window to apply dashboard widgets.

The Bot Insight dashboard provides the following filters:

- **Attributes:** This filter enables you to include or exclude specific parameters of a given attribute. This can be the bot name, device name, or user name.

For example, you can use the parameters:

- **Model Version** to differentiate the payload and to determine if an upgrade is required in the dashboard. You can also use it as a filter so that the dashboard works correctly even with different job execution pay loads.
- **Job type** to identify the type of task such as TASK(Bot Run), WORKFLOW, WORKORDER, WLM_TASK
- **Automation Name** to provide a name when running or scheduling the bot
- **Object Name** to identify the name of the entity for which the audit action is recorded. For example, to identify the username when the user is edited or created or the bot name when the bot is edited or created.
- **Numeric:** This filter enables you to select a specific duration for which you can get the numerical statistics of the bot. For example, this can be the **totalLines** that is processed by the bot, or the duration during which the bot was active.
- **Time:** This filter enables you to select a single date, or a range of dates to analyze the variables that are categorized under time and date. This can be the bot start time or end time.

Related concepts

[Operations dashboard](#)

The Bot Insight Operations dashboard provides information about bots that are deployed on different Bot Runner machines and bot statistics based on performance. You can use this information to enhance productivity and take measures based on real-time information for RPA deployments.

Adding a dashboard filter

To create a dashboard filter, select a field containing the information type you want to filter and define the return of the data. The filtered view is preserved so that the same view is displayed the next time you view the dashboard.

1. Open the dashboard to which you want to add a filter.
2. Select the parameter based on your requirements in the **Attributes** tab, .
The parameter window appears.
 - a) Enter the name of the variable in the **Search** field.
The variable appears in the **All** tab. Select the variable that you want to add in the filter. The selected variable appears in the **Selected** tab.
 - b) Choose one of the following options:
 - Click **Include** to include the variable in the dashboard filter.

- Click **Exclude** to exclude the variable in the dashboard filter.

c) Click **Apply**.

The **Attributes** filter is added to the dashboard.

3. Select the parameter in the **Numeric** tab.
4. Perform these steps in the selected parameter window:
 - a) Select the condition that you want to specify in the filter.
 - b) Enter the minimum and the maximum values.
 - c) Click **Apply**.

The **Numeric** filter is added to the dashboard.

5. Select the parameter based on your requirement in the **Time** tab.
6. Perform these steps in the selected parameter window:
 - a) Select a specific date, or a range of dates.
 - b) Click **Apply**.

The **Time** filter is added to the dashboard.

Related reference

[Customizing a dashboard](#)

Log in to Bot Insight with the `AAE_Bot Insight Expert` role to customize the information displayed in the system-generated dashboard to make it more relevant for an analytics consumer.

Working with Bot Insight dashboards

You can save or delete a Bot Insight dashboard when required. You can also delete a user-created dashboard.

When you delete a dashboard, it does not impact the data associated with that dashboard. You can delete dashboards that are available in the **Analyze** and **Configure** tabs of the Bot Insight window. The dashboards available in the **Analyze** tab are the published dashboards. Therefore, if you delete a dashboard from the **Analyze** tab, it will no longer be available for other users.

- Save a dashboard:
 - a) Open the dashboard that you want to save.
 - b) From the **Actions** menu, select **Save as**.
The **Save Dashboard** window appears.
 - c) In the **Dashboard Name** field, enter the name for the dashboard.
 - d) In the **Dashboard Description** field, enter the description of the dashboard.
 - e) Click **Save**.
Click **Save As** to save a default dashboard as a customized dashboard.
- Open the dashboard you want to delete.
 - a) Click **Delete** on the toolbar.
 - b) Click **Okay**.

Comparing dashboards

You can compare dashboards that belong to two separate processes, or the same process with different filters. The dashboards selected for comparison appears as a side-by-side view to enable you to obtain better insights.

- Compare dashboards:
 - a) Open the dashboard that you want to compare.
 - b) Navigate to **Actions > Compare** in the **Bots Dashboard**.
Your dashboard is now in compare mode. The dashboard you have opened appears in both the **Left View** and **Right View**. You can apply widget filters to your dashboard at any time.
- Apply widgets to your dashboards:
 - a) Click the **Filter** option from your dashboards, represented by the three dots in the corner.
The **Filter** window now appears and shows the available widgets.

Note: The **Filter** option next to the **Close** option accesses the same **Filter** window. You can also expand or minimize the **Filter** window.

- b) Select the **Left View** or **Right View**.
- c) Select the **Attributes**, **Numeric**, or **Time** widgets that you want to apply.
- d) Optional: Click **Clear All** to reset all your widget selections.
- e) Click **Apply** to confirm.
You can now compare your dashboard with widgets.

Customizing a dashboard

Log in to Bot Insight with the `AAE_Bot Insight Expert` role to customize the information displayed in the system-generated dashboard to make it more relevant for an analytics consumer.

To make changes in a Bot Insight dashboard, create a copy of the dashboard, and then update the copy.

After you create customized dashboards for a bot, you can make changes to the tagged variables. You can delete and add variables based on your requirements. By default, the standard dashboard always displays the latest data profile. We recommend you use the system-generated standard dashboard, and then create customized dashboards from it. Data profile updates are highlighted with a red dot in the following scenarios:

- When there are data profile updates.
 - The variables that are newly added display the message `NEW`.
 - The variables that are deleted display the message `DELETED`.
- When the customized dashboard data profile does not match that of the standard dashboard.

Related tasks

[Editing a data profile](#)

You can modify the data profile of both the Default and Custom Business dashboards without modifying the bots.

Viewing ranks of string datatype values

Among string datatype values, you can view the ranking based on the maximum and minimum number of times each string datatype value has been used, as logged by a variable. With this information, you can better verify whether the data logged in the bot is correct.

1. Open the dashboard for which you want to edit the data profile.
2. Click the **Profile** tab.
3. Click **Rank** within the **Distinct Count** column.

The **Distinct Count** column displays the number of unique values logged by a variable.

Note: The **Rank** option is only available for the variables that log values of string datatype. A message appears displaying the top five values that are logged for the maximum number of times in the variable.

4. Select **Bottom** from the list to display the five values that are logged the least number of times in the variable.
5. Select an option from the list to display five or ten values in the message box.

Previewing data

You can view all the variable data associated with a task using the **Preview Data** option.

1. Open the dashboard for which you want to preview the data.
2. Click the **Data Profile** tab.
3. Click the **Preview data** option.

A new window appears displaying all the variable data associated with that task.

Verifying data populated in a custom dashboard

After you create a custom dashboard that contains new widgets or customized widgets from the system-generated dashboards, you can verify the data that is populated in the dashboard.

1. Open the task for which you want to verify the data in Bot Insight.
2. Click **Run** on the toolbar.
3. Click the **ANALYZE** tab.
The system-generated dashboard for the task appears.
4. Click the **Analyze** tab in the Bot Insight window and search for the customized dashboard for which you want to verify the data.
5. Select the dashboard from the search results.
The dashboard appears.
6. Click the **Data Profile** tab and verify the data for the dashboard.

Publishing a business analytics dashboard

Bot Insight enables you to publish a business analytics dashboard that is generated for a task. You can publish both the Custom and Default Business dashboards.

Before you publish a dashboard, ensure that the particular bot resides in the Public folder in the Control Room.

1. Open the dashboard that you want to publish.

2. Customize the dashboard based on your requirements and verify the content and presentation formats.
3. Click **Publish** on the toolbar.
4. Specify a name for the dashboard, and then click **Okay**.
The dashboard is now published and available to display the production data generated by the task. The dashboard updates the data each time a task runs in the production environment from the Control Room on a regular basis.
In the Control Room, ensure that you deploy the bot in the Bot Runner device so that the published dashboards are populated with data.

Related tasks

Import bots

You can import bots with their dependencies from one Control Room to another. The source environment can be Automation 360 Control Room, Enterprise 11, or Enterprise 10 Control Room instance.

Save a published dashboard

You can publish a Bot Insight business analytics dashboard that is generated for a task. You can also save a copy of the published dashboard when required.

Ensure you have the **AAE_Bot Insight Admin** or **AAE_Bot Insight Expert** roles assigned to you.

1. Open the Bot Insight Window.
2. Click the **Business** tab and search for the dashboard for which you want to save a copy of custom production dashboard.
3. Select the dashboard from the search results.
The selected dashboard appears
4. Select the **SaveAs** from the **Action** menu to save the default **Production** dashboard as a **Custom Production** dashboard.
5. In the **Save Dashboard** window, specify a name for the dashboard and click **Okay**.
You can add widgets from the **Visualizations** menu to your custom production dashboard.
You can add, delete, change visualization, apply filters, and so on to customize the dashboard.

Delete a published dashboard

You can publish a Bot Insight business analytics dashboard that is generated for a task. You can also delete a published dashboard when it is not longer required.

Ensure you have the **AAE_Bot Insight Admin** or **AAE_Bot Insight Expert** roles assigned to you.

You cannot delete a default **Production** dashboard if child (custom production dashboards) are associated with it. You must first delete the custom production dashboard and then delete the default **Production** dashboard. However, you can delete a **Custom Production** dashboard.

1. Open the Bot Insight Window
2. Click the **Business** tab and search for the dashboard you want to delete.
3. Click **Delete** from the **Action** menu.
4. Click **Okay** to confirm the deletion.

Reviewing data in a published dashboard

You can review the data available in a published dashboard.

1. Open the Bot Insight window.
2. Search for the dashboard for which you want to view the data.
3. Select the dashboard from the search results.

The selected dashboard appears.

4. Review the data available in the dashboard.

The dashboard reflects the data processed by the task in the production environment.

5. Export the entire dashboard in PDF or PNG format for offline consumption and review.

Sharing a dashboard

You can share the link to view a dashboard through email using the **Share via email** option.

1. Open the dashboard that you want to share.

2. Click **Share via email** on the toolbar.

The email client configured on your system appears. The email client contains a link to access the dashboard.

3. Specify the email address of the recipients and send the email.

Downloading a PDF file from a dashboard

You can download the data available in the dashboard as a PDF file.

1. Open the Bot Insight window.

2. Search for the specific dashboard.

3. Select the dashboard from the search results.

The selected dashboard appears.

4. Review the data available in the dashboard.

5. In the **Actions** menu, click **Download PDF**.

6. In the **Download PDF** window, navigate to the location on your local disk drive.

7. Click **Save**.

Note: Due to a limitation within the third-party recharts library, you might observe labels overlapping issue with data in downloaded PDF.

Taking a screenshot of a dashboard

You can take a screenshot of the data available in the dashboard.

1. Open the Bot Insight window.

2. Search for the dashboard for which you want to view the data.

3. Select the dashboard from the search results.

The selected dashboard appears.

4. Review the data available in the dashboard.

5. In the **Actions** menu, click **Screenshot**.

6. In the **Download PDF** window, navigate to your local disk drive location.

7. Click **Save**.

Using Bot Insight

Use Automation Anywhere Bot Insight to track bot data for analytics.

Automation Anywhere bots are built, run, and monitored in the Control Room. Bot Insight accesses real-time business insights and digital workforce performance data to leverage content-level productivity data

from the bots that are deployed. Data is logged for business analytics who has Attended and Unattended Bot Runner license .

Log in to Automation Anywhere Control Room as an `AAE_Bot Insight Expert` or `AAE_Bot Insight Consumer` to interactively analyze bot data and enhance bot widgets.

In the Control Room, select the Bot Insight tab, to do the following tasks:

- **Interactively analyze the bot data** in the dashboards.
- **Refine and enhance widgets** in the Bot Insight dashboards *before they are published* for wider consumption and deployed to production.

Business analytics

Business analytics provide information about the transactional analytics for the data that is logged by the variable tagged in a task. The information provided can be about the total sales in a month, invoicing and payment trends, insight about new customers, or quote to order ratio.

When you tag variables for analytics in a task, and run the task, Bot Insight generates the analytics dashboard . By default, the generated dashboard has the same name as that of the task. You can customize the system generated dashboards based on your requirement.

Configuring a task for business analytics

To configure a business analytics automation task, enable analytics (using the **Analyze: Open** and **Analyze: Close** actions) and tag the variables that are of interest for data analysis.

To configure a task for business analytics in an existing bot:

1. Log in to the Control Room.

Note: Ensure that you have the Bot Creator license assigned to you.

2. In the **Automation** pane, select the folder that contains the task for which you want to enable analytics.

The **Actions** palette appears in the left-hand side. See [Actions palette for bot creation](#).

3. Build a bot.

For more information about building and editing a bot, see [Get started building bots](#).

4. Insert the **Analyze: Open** action at the beginning of the transaction.
5. Insert the **Analyze: Close** action at the end of the transaction.

The **Analyze: Close** menu lists all the variables in the transaction. Select the variables that are tagged in the transaction to process business analytics.

Note: This feature enables you to deselect variables that might raise potential privacy concerns, such as social security numbers or bank account details.

6. Click **Apply**.
Click **Reset** to reset the variable selection.
7. Click **Save**.

- Click **Run**.
The **Bot Run Successfully** message appears.

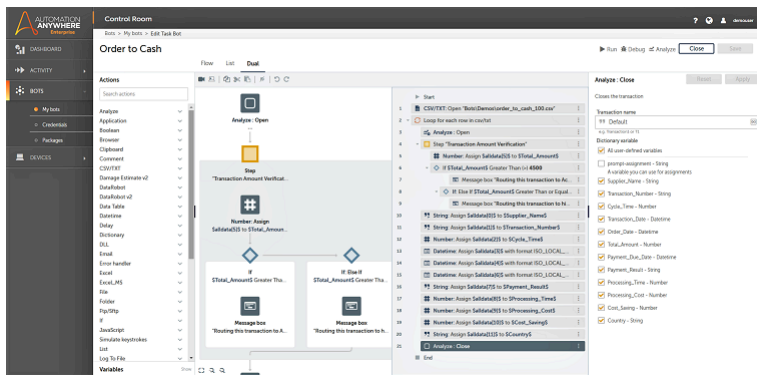

- Click **Analyze**.
The Bot Insight window appears.
- Select a bot from the **Select a Dashboard** drop-down list.
Click the arrow to view the list of bots.

Using widgets

The Bot Insight dashboard provides a host of highly customizable widgets that you can use to gain insights for specific scenarios.

When you select a particular bot, the default widgets automatically appear in the **Dashboard** window. You can select the widgets and reposition them in the dashboard. To search for specific information, use the **Smart Filter** function. You can enter the search parameters in the **Smart Filter** field.

You can also use multiple filters to search for data the widgets should display. Enter the filters, search parameters, separated by a comma in the **Smart Filter** field. You can create, move, rename, and edit the widget properties in a dashboard, based on your requirements.

The available options are:

- Chart filters
- Chart style
- Metric-based filters
- Comparison metrics

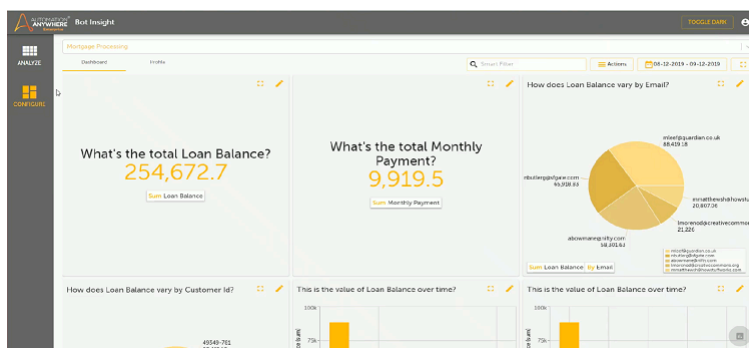

You can group information by dates and use the **Date Interval** to view when a particular bot was active.

The following **Date** type options are available:

- **Hour**

- **Day**
- **Week**
- **Month**

Adding a dashboard widget

You can add custom widgets to the Bot Insight dashboard based on your requirements.

1. Open the dashboard.
2. Click the  icon.
The **Add Visualization** window appears.
3. Select a widget that you want to add in the dashboard. See [Bot Insight visualizations](#) .
The **Selected Chart** window appears.
4. **Optional:** Click the **Switch Widget** button to change widgets.
5. Click **Next**.
The **Construct Your Query** window appears.
6. Enter the query information to construct your dashboard. For reference to create a widget query, see [Configuring a Line Bar Chart query](#).
7. Click **Next**.
The **Ready to build** window appears.
8. Click **Confirm**.
The widget appears in the dashboard.

Bot Insight visualizations

The Bot Insight dashboards provide customizable widgets that you can use to gain insights for specific scenarios.

Bot Insight offers the following visualization widgets:

- **Gauge Chart**
- **KPI**
- **Vertical Bar Chart**
- **Line Bar Chart**
- **Clustered Line Bar Chart**
- **Horizontal Bar Chart**
- **Vertical Stacked Bar Chart**
- **Horizontal Stacked Bar Chart**
- **Vertical Clustered Bar Chart**
- **Horizontal Clustered Bar Chart**
- **Heat Map**
- **Pie Chart**
- **Donut Chart**
- **Line Chart**
- **Scatter Chart**
- **Bubble Chart**
- **Datatable Chart**
- **World Map**

- **US Map**

The **Pie Chart** widget enables you to visualize data in a circular statistical graphics that is divided into slices.

Note: Due to a limitation within the third-party recharts library, the data labels in a pie chart are overlapping if it contains many slices. As a result, the labels in a pie chart are not clear and are shown only when you hover over the slices.

The **Heat Map** widget enables you to visualize data as a heat map chart. You can specify the dates by function (day, week, month, or year) to drill down to specific information. This map displays all the possible available combinations of variable values in the X and Y axes. Blank heat map blocks appear if there the value attached to the variable is 0. The color of the heat map block depends on the value of the information displayed. A new window with all the relevant information appears when you hover your mouse over a particular heat map block.

The **Datatable Chart** widget enables you to view and analyze information about all the logged data in a tabular chart. You can select the attributes and metrics based on your requirement. All the available attributes and metrics are selected by default.

The **World Map** widget provides information about the data variables and enables you to drill down to specific information:

1. Country
2. State
3. Zip Code
4. Latitude
5. Longitude

The **US Map** widget provides the following information about the data variables and enables you to drill down to specific information:

1. Country
2. State
3. City
4. Zip Code

The **Line Bar Chart** and the **Clustered Line Bar Chart** widgets enable you to view and analyze information about your metrics and attributes. You can input two metrics and one attribute in **Line Bar Chart** widget, while in the **Clustered Line Bar Chart** widget, a **Sub group** option enables you to add one more attributes if necessary.

The widget displays a line bar graph aggregated by group values when only one attribute is selected or a clustered line bar graph aggregated by subgroup values when two attributes are selected. It displays group sectioning which forms multi-axes labels . You can use **Date** types as interval options, grouped by **Day**, **Week**, **Month**, **Quarter**, and **Year**, with the **Day** set as default.

[Configuring a Line Bar Chart query](#)

Related tasks

[Adding a dashboard widget](#)

You can add custom widgets to the Bot Insight dashboard based on your requirements.

Configuring a Line Bar Chart query

You can construct a custom query based on specific parameters to apply to your widget for line bar and clustered line bar charts.

After you are in the **Construct Your Query** window, follow these steps to select parameters to apply to your widget:

- Construct your query settings.

The query settings vary from widget to widget, but the selection process remains the same.

a) Enter the title of your widget in the **Chart Title** field.

b) Select a metric option in the **Metric** or **Select Metrics** field.

For **Line Bar Chart** and **Clustered Line Bar Chart**, the **Metric** field is renamed to **Y1 Axis** and **Y2 Axis**.

c) Select an aggregated value in the **Aggregated By** field.

For **Line Bar Chart** and **Clustered Line Bar Chart**, the **Aggregated By** field is renamed to **Y1 Aggregated By** and **Y2 Aggregated By** with the same options.

d) Select a value from the **Group By** or **Group 1** field.

e) Select a secondary value from the **Sub Group By** or **Group 2** field.

Note: The **Sub Group By** or **Group 2** field is not available in the **Line Bar Chart**. For the **Metric**, **Group By** and **Sub Group By** fields, the first value is shown as the default value.

f) Select a date value in the **Date Interval** field.

Note: This field appears when you select the Date Type variable in the **Group By** and **Sub Group By** fields.

- Construct your advanced query settings.

You can enable more options to any widgets that support advanced settings.

a) Click **Advanced Settings**.

The settings display the default values. You can change the value of the fields if required.

b) Select a limit value in the **Limit** or **Group Limit** field.

c) Select a sort value in the **Sort By** or **Group Sort By** field.

d) Select a sort order value in the **Sort Order** or **Group Sort Order** field.

e) Select a secondary limit value in the **Sub Group Limit** or **Group 2 Limit** field.

f) Select a secondary sort value in the **Sub Group Sort By** or **Group 2 Sort By** field.

g) Select a secondary sort order value in the **Sub Group Sort Order** or **Group 2 Sort Order** field.

Note: The **Sub Group Limit**, **Sub Group Sort By** and **Sub Group Sort Order** fields are not available in the Line Bar Chart.

Editing a dashboard widget

You can edit the dashboard widget properties based on your requirements.

You can resize and save the widgets in the Bot Insight dashboard based on your requirements. When you resize a dashboard widget, other widgets in the dashboard are automatically adjusted to fill in the available layout.

Note: Bot Insight allows you to resize widgets in the standard and the customized dashboards. However, it does not allow you to save the widgets after resizing in the standard dashboard.

1. Open the dashboard widget.
2. Click the **Edit** button.
The **Edit** window appears.
The **Edit** menu offers the following options:

Chart Title	Renames the chart
Metric	Changes the units
Aggregate By	Changes the aggregation method
Group By	Changes the parameters based on which the widgets are grouped together

3. Click the bottom of a widget to change the attribute of the chart displayed within the widget.
4. Click **Save As** to save the widget.

Drilling down information in dashboard widget

You can drill down information from a dashboard widget based on your requirement. Select the options available in the drop-down list to view specific information in the dashboard widgets.

To use the drill down function feature in the Bot Insight dashboard widget, do the following:

1. Open the dashboard and select the widget.
2. Right-click to view the **Drill Down** menu.
Drill Down menu sample for a mortgage analytics processing bot :

- **Gender**
- **Mortgage Type**
- **Customer ID**
- **Company Name**
- **Email**
- **Loan Due Date**
- **Loan Origin Date**

Note: Bot Insight dynamically generates the **Drill Down** menu options based on the variables you tag when creating the bot.

Renaming a dashboard widget

You can rename a dashboard widget based on your requirement. The default name of a dashboard widget is based on the type of information that the widget displays.

To rename a widget in the Bot Insight dashboard, do the following:

1. Open the dashboard for the widget to edit.
2. Rollover and click the **Edit** button.
The **Edit Chart** window appears.
3. In the **Chart Title** field, enter the name of the widget.
4. Click **Next**.
The **Ready to build! Click Finish** window appears.
5. Click **Finish**.
The **Widget Updated** message appears.

Exporting data from a dashboard widget

You can export data from the Bot Insight **Custom Business** dashboard widgets to CSV files based on the requirement.

1. Open the dashboard.
2. Identify the widget.
3. Click the **Actions** icon.
4. Click **Export**.
The CSV file is automatically saved in your local drive as `Chart name_summary_dd_mm_yyyy`.

Data connector for Power BI

The data connector for Power BI enables you to establish a secure connection to Power BI, and generate and visualize data analytics. You can connect to the Bot Insight APIs in Power BI and apply specific parameters for each of the APIs.

The connector transforms the Bot Insight API responses to data visualizations in Power BI. The data connector for Power BI enables you to perform the following functions in Power BI:

- Authenticate and connect to the Control Room.
- Connect to APIs.
- Generate API responses.
- Transform the API responses to create a data model.
- Create visuals, charts or graphs, to represent the data.
- Create reports.
- Share reports with other users on Power BI.

You can access the following APIs from Power BI:

- `getaudittrialdata`
- `getbotrundata`
- `gettaskvariableprofile`
- `gettasklogdata`

Note: Automation Anywhere Power BI connector is certified and available as part of the Microsoft Power BI Desktop August release. The connector is available in the **Other** section of the **Get Data** dialog box in Power BI.

To update your Power BI to the latest certified release version and use the connector plug-in, manually deploy the data connector in Power BI. This enables you to retrieve information from the Bot Insight API for data analytics.



Trouble: When you attempt to refresh the data in a Microsoft Excel worksheet, an authentication error can occur from multiple simultaneous attempts through open windows and tabs. To avoid this error, perform the following steps:

1. In the Power BI desktop application, navigate to **File > Options and settings > Options**.
 2. From the Current File section, select **Data Load**.
-

Note: Do not select **Data Load** from the Global section.

3. Disable the check box for **Enable parallel loading of tables**.
-

Related reference

[Bot Insight API](#)

Users with the `AAE_Bot_Insight_Admin` or `AAE_Admin` role and the `Bot_Insight` license can access the Bot Insight API to retrieve business and operations data.

Related information

[Microsoft Power BI](#)

Deploy Power BI connector

Deploy the data connector in Power BI to retrieve information from the Bot Insight API to enable data analytics.

The connector can now be accessed directly from the Power BI desktop application. Ensure you meet the following prerequisites.

- You should be using Power BI desktop version 2.92.943.0 or above.
- You know your Automation Anywhere Control Room version.
- You have your Control Room credentials.
- You have your Control Room URL.

The following steps describe how to deploy the connector.

1. From your Power BI desktop application, select **Get data**.
2. In the search field, type and select `Automation Anywhere`.
3. Click **Connect**.
4. From the Login dialog box, enter your Control Room version and URL.
5. Enter your Control Room credentials.
6. Click **Connect**.

[Configure Power BI connector](#)

Configure Power BI connector

Configure the data connector in Power BI to retrieve information from the Bot Insight API to enable data analytics.

Ensure that you have the `Bot Insight Admin`, or `AAE_Admin` role assigned to you in the Control Room.

Notice: A `Bot Creator` license is required to generate a default dashboard with **tasklogdata** for Power BI.

Note: The Power BI Connector is supported with Database Authenticated Control Room and Active Directory authentication.

1. Log in to the Power BI.
2. Click **Get Data**.
The list of all the Power BI certified connectors appears.
 - For information about how to access non-certified custom connectors, see [Connector extensibility in Power BI](#).
 - When you update the dataset of two or more datasets, you might observe the **Authentication 500 Internal server error**. For resolving this error, see [Automation 360 | Authentication 500 Internal server error while refreshing in power BI \(A-People login required\)](#).
3. Select Automation Anywhere and click **Connect**.
4. In the **Automation Anywhere - Login** window, enter the following information:
 - a) In the **Control Room Version** drop-down menu, select the version of the Control Room.
 - b) In the **Control Room Host** field, enter the IP address or the host name of the Control Room server.
 - c) In the **Bot Insight Host** field, enter the IP address or host name of the Bot Insight server.
5. Click **OK**.
6. In the **Automation Anywhere Login** window, enter your Bot Insight user name and password.
To provide the credentials for Active Directory authentication, you must enter the domain name delimited by a double backslash (\\) along with the user name in the **User name** field. For example:
`domain name\\user name`.
7. Click **Connect**.
The Bot Insight APIs are authenticated and the authorization tokens are generated. The Bot Insight APIs are loaded dynamically from Swagger, along with the applicable request parameters.
8. Select the required Bot Insight API from the **Navigator** menu and enter the information in the respective fields.
9. Click **Load**.
The API retrieves specific information from the server.
To learn how to retrieve information from Bot Insight APIs in Power BI, see [Bot Insight API](#).
10. Click **Transform Data** to convert the structured JSON response to a visual data model.

Related information

[Transform, shape, and model data in Power BI](#)

[Create reports and dashboards in Power BI](#)

[Collaborate, share, and integrate across products with Power BI](#)

Example: Retrieve information in Power BI using business information API

The Power BI connector enables you to access the Bot Insight API from Power BI. This example task shows you how to retrieve information from the Bot Insight API and build data visualizations in Power BI.

1. Open Power BI.
2. Open the **Navigator** window, and log in to the Control Room by entering the credentials.
3. In the **Display Options** menu, select **fx Business Information**.
The **API** window appears.
4. In the **botName** field, enter the name of the bot, or the task for which you want to visualize the analytical data.
To enter multiple bot names, separate each name with a comma.
For example, *SalesAPAC,SalesEMEA,SalesUS*.
5. In the **pageNo** field, enter the offset value for the rows or records that you want to retrieve.
 - If page = 0, and limit =1000, then rows 0 -1000 will be retrieved.
 - If page = 1, and limit =1000, then rows 1001 -2000 will be retrieved.
6. Optional: In the **fromDate** field, enter the date from when you want to retrieve the information.
Format: *yyyy-mm-dd*, or *yyyy-mm-ddTh:m:s.ms z* (2020-02-20T12:45:23.000z)

- Note:** If you do not enter a date, the API will return all available data.

7. Optional: In the **toDate** field, enter the date till when you want to retrieve the information.
Format: *yyyy-mm-dd*, or *yyyy-mm-ddTh:m:s.ms z* (2020-03-21T15:45:32.000z)

- Note:** If you do not enter a date, the API defaults to the current date.

8. In the **limit** field, enter the number of rows or records you want to retrieve.
9. Click **Apply**.
Power BI displays the data visualization.

Configure Tableau web data connector in Bot Insight

The web data connector in Tableau enables you to establish a secure connection with Automation 360 and to extract, visualize, and analyze data from Bot Insight.

- Ensure that your user name is registered in the Control Room and that you have **Bot Insight Admin** or the **AAE_Admin** role assigned to you.
- Ensure you have access to the desktop or public version of Tableau software.

Note: Single sign-on is not currently supported for Bot Insight. Connectors only work with the following authentication mechanisms.

- Control Room database based authentication
- Active directory based authentication

The Web data connector in Tableau enables you to perform the following functions in Tableau:

- Authenticate and connect to the Control Room.

- Connect to Bot Insight APIs for business and operational information.
 - Use business and operational information to create a data model.
 - Create charts or graphs to represent the data.
 - Create reports and share them with other users on Tableau.
1. Open Tableau.
 2. Select **Web Data connector** from the **Connect** option in **Data** tab.
 3. In the **Web Data Connector** window, enter your Automation Anywhere URL in web data connector field: <control room url>/tableau/Login.html
 4. In the **Automation Anywhere - Login** window, enter the following information:
 - a) In the **Control Room Version** drop-down menu, select the version of the Control Room.
 - b) In the **Control Room URL** field, enter the URL or the host name of the Control Room.
 - c) In **User Name** and **Password** field, enter your Bot Insight user name and password.
 5. Click **Submit** to connect to Bot Insight APIs.
 6. Select either **Business Information** or **Operational Information** in the Bot Insight window. If you are an **AAE_Admin**, you can choose between Audit APIs and Operations APIs.
 7. Click **Get Data**.
Bot Insight API retrieves information from the server.
 8. Click **Update Now** to gather all the data from Bot Insight in Tableau.
You can use the retrieved data from Bot Insight for data visualizations and analysis in Tableau.

Control Room APIs

The Automation Anywhere Control Room provides APIs that allow you to customize the way that you (and your bots) interact with Automation Anywhere. Control Room APIs allows you to perform tasks such as manage bot deployments, create and manage credentials in the Credential Vault, create and manage user accounts and roles, and create and manage queues.

Getting started with Control Room APIs

The Control Room APIs are built on HTTP and uses REST APIs with methods GET, POST, PUT, and DELETE. All requests must include an X-Authorization header with the JSON authentication token or **Authorization** header with a Bearer token for requests to the Control Room.

Note: The Bearer token is supported from Automation 360 v.27 release. It is unsupported and ignored in the previous releases. You must obtain the Bearer token from our OAuth services. Use either **X-Authorization** (using Authentication API) or **Authorization** (using OAuth) to authorize your access. You cannot use both in the same API.

Note: You can view the in the , but API functionality is limited. You need a licensed Edition to access the full functionality of the APIs.

Watch the following video to learn how to test Control Room APIs in Swagger and Postman:

Control Room support for several API clients, allowing you to explore the Control Room APIs. Download and install *Postman*, then click the <https://www.postman.com/collections/bb5cd3541d29e192cd43> to download the Control Room APIs collection. . For more detailed documentation of each APIs, visit the links below.

Bot Agent API: Auto registration

Automatically register and connect your device to a Control Room by using the `Auto registration` API.

This API uses the generic registration token from the `auto-registration.properties` file to register the device in the specified Control Room URL. You cannot autoregister the device if the Control Room URL is not available in the `auto-registration.properties` file. The `auto-registration.properties` file must be available on your local system, and you must not delete the file after the registration is complete.

Note: To register the device from the command line or API, you must set the `AA_DELAY_REGISTRATION_UNTIL_LOGIN MSI` parameter.

Request

```
POST http://127.0.0.1:22113/v1/registration/auto
```

Request body:

```
{
  "url": "https://{controlroom url}",
  "userName": "dpcreator"
```

```
}

```

Request parameters

Parameter	Type	Required	Description
url	String	Yes	Specify the Control Room URL to autoregister the device.
userName	String	No	Specify the Control Room user to associate the device as the default device.

Response

```
{
  "result": "REGISTERED",
  "deviceId": "11",
  "crUrl": "control_room_url",
  "userName": "dpcreator"
  "installationType": "SYSTEM_WIDE",
  "crSwitchAllowed": "false",
}
```

Response parameters

Parameter	Type	Description
result	String	Status of the device registration.
deviceId	Number	Unique ID of the device the Bot Agent is installed on.
crUrl	String	The Control Room URL where the device is autoregistered.
userName	String	The username for which the device is associated as default device.
installationType	String	The type of installation that is performed.
crSwitchAllowed	String	Indicates whether the device can be registered on a different Control

The REST API responds to each request with an HTTP response code. For response codes, see [API response codes](#).

Configure the Control Room

Before you start creating workflows for bot deployment and workload management using Control Room APIs, ensure you complete specific prerequisites and steps in the Control Room.

Ensure you have following licenses and permissions:

- One or more Bot Creator and unattended Bot Runner licenses.
- Control Room admin credentials to view, create, and configure users, roles, and device pools.

- The **Create device pools** feature permission or the **AAE_Pool Admin** role must be assigned to you.

Follow these steps to configure your Control Room with users, roles, and bots.

1. Log in to the Control Room as an admin.
2. Create a Control Room user.
Ensure that the user is assigned the **AAE_BASIC** role.
Create a user
3. Create a custom role to map the users you created to Bot Runners and `Bot` folders.
 - a) In the **Features** tab, ensure you select these permissions: **View my Scheduled Bots**, **Schedule my bots to run**, **Run my Bots**, **View my Bots**, and **Generate my API Key**.
 - b) In the **Automation** tab, expand the **Bots** folder and select the root folder or subfolders you want to provide access for use. Ensure you select these permissions: **Run and schedule** and **View content**.
 - c) In the **Run as** tab, select one or more Bot Runners from the list of **Available bot runners**.
 - d) In the **Users** tab, select the new user created in Step 1 to assign the custom role to this new user.
4. Create a new device pool.
In the **Consumers** tab, ensure you select the custom role you created in Step 3.
Create device pools
5. Log in to the Control Room as a Bot Creator and create bots to automate routine business tasks.
Build a Go be Great bot
Ensure you check in the bots in the `Bot` folder or folders selected when creating the custom role (Step 3). *Check in a bot*

Authentication API

Use the Authentication API to generate, refresh, and manage the JSON Web Tokens (JWTs) that are required for authentication and authorization in order to use the Control Room APIs.

Note: You can view the in the , but API functionality is limited. You need a licensed Edition to access the full functionality of the APIs.

Set up authentication or authorization for your application

1. Generate a token with one of the following endpoints:

Note: `apiKey` or `password` is used to generate a valid token. Both (`apiKey` and `password`) cannot be used together in a request body.

- *Authenticate (username and password)*

If you are trying out the Control Room APIs in Swagger or another REST client, use this authentication method.

- *Authenticate (username and apiKey)*

Use this authentication method to generate the token without the need for the user's password, such as for organizations that use single sign-on (SSO).

Note: Tokens have a default timeout of 20 minutes. Do not use an expired token for your API requests. Using an expired token will invalidate the current valid token.

2. *Validate token*

3. *Refresh token*

4. *Expire token*

Authenticate (username and password)

Use this API to authenticate access to your Control Room with a valid `username` and `password`. A successfully completed response generates a JSON Web Token. By default, a token is valid for 20 minutes.

Request

```
POST http://{{ControlRoomURL}}/v1/authentication
```

Request body:

```
{
  "username": "jdoe",
  "password": "mypassword@123"
}
```

Request body to generate Multi-login token:

```
{
  "username": "jdoe",
  "password": "mypassword@123",
  "multipleLogin": true
}
```

Note: `apiKey` or `password` is used to generate a valid token. Both (`apiKey` and `password`) cannot be used together in a request body.

```

    "groupNames": [
    ],
    "permissions": [
        ". . ."
    ],
    "licenseFeatures": [
        "RUNTIME"
    ],
    "emailVerified": true,
    "passwordSet": true,
    "questionsSet": true,
    "enableAutoLogin": false,
    "disabled": false,
    "clientRegistered": false,
    "description": "",
    "createdBy": 1,
    "createdOn": "2022-03-10T13:39:56-05:00",
    "updatedBy": 1,
    "updatedOn": "2022-03-13T02:09:38-05:00",
    "publicKey": null,
    "appType": null,
    "routingName": null,
    "appUrl": null
  }
}

```

Response Parameters

Parameter	Type	Description
token	String	Generated access token that acts as a session ID that your application will use for making requests. This token is equivalent to the user credentials and must be protected. Note: If <i>multipleLogin</i> is set to <i>true</i> , you will be able to use this token for multiple API sessions.

Parameter	Type	Description
user	Object	<p>The user object returned with all the details of the user.</p> <ul style="list-style-type: none"> • id - Id of the user. • email - Email id of the user. • username - User name of the user. • domain - Domain logged in to. • firstname - First name of the user. • lastname - Last name of the user. • roles - Roles assigned to the user. • sysAssignedRoles - System assigned roles. • permissions - Permissions assigned to the user. • licenseFeatures - License assigned to the user.

Insert the token in the request header of subsequent API requests.

Note: For an Control Room that is deployed on Cloud and has SAML authentication enabled, generate the web token with your `username` and `apiKey`.

Authenticate (username and apiKey)

Note: You can view the in the , but API functionality is limited. You need a licensed Edition to access the full functionality of the APIs.

The REST API responds to each request with an HTTP response code. For response codes, see [API response codes](#).

Related concepts

[Authentication API](#)

Use the Authentication API to generate, refresh, and manage the JSON Web Tokens (JWTs) that are required for authentication and authorization in order to use the Control Room APIs.

Authenticate (username and apiKey)

Use this API to authenticate access to a Control Room with the `username` and `apiKey`. A successful response generates a JSON Web Token. A generated token is valid for 20 minutes. You can generate the token without the need for the user's password, such as for organizations that use single sign-on (SSO).

To generate the token, you require the following:

- A custom role with the Generate API-Key permission

- Valid username and API-key to the Control Room. The API-Key is a 40-character string generated in the Control Room.

Create and assign API key generation role

Request

```
POST http://{{ControlRoomURL}}/v1/authentication
```

Request body:

```
{
  "username": "jdoe",
  "apiKey": "Vie;Z:IvtAhY0\\1RAD[SWl{NU7baRLYEeIYUJSKO"
}
```

Note: With `apiKey` you will be generating a multi session token. `multipleLogin` parameter is not applicable while you use `apiKey` to login.

Note: `apiKey` or `password` is used to generate a valid token. Both (`apiKey` and `password`) cannot be used together in a request body.

Request Parameters

Parameter	Type	Description
username	String	Enter your user name.
apikey	String	Enter your apikey. Note: With .24 or previous versions, you must replace any escape character '\ ' with '\\ ' in the API key. With .25 or later versions, the API key will no longer have any escape characters('\ ').

Response

```
{
  "token": "eyJhbGciOiJSUzUxMiJ9.eyJzdWIiOiIxIiwiaWF0Ij0iY2xpZW50VHlwZSI6IldFQiIsImxpY2Vuc2VzIjpbY2t1lCBg_cDGbwj5FvaBt9u5xKu5W5j3Nur6x3PF62NeB3ZIdxiUPaFBU0Br84mPJMD4_EpwBfbsVOMH6ngiItJYI...oV-U1Iw0JHiX2-Ug",
  "user": {
    "id": 9,
    "email": "a@a.com",
    "username": "jdoe",
    "domain": null,
    "firstName": "j",

```



```
"lastName":"doe",
"version":9,
"principalId":9,
"deleted":false,
"roles":[
  {
    "name":"API_Key_Generation",
    "id":23,
    "version":0
  },
  {
    "name":"AAE_Basic",
    "id":2,
    "version":0
  },
  {
    "name":"Docrole1",
    "id":18,
    "version":0
  }
],
"sysAssignedRoles":[
],
"groupNames":[
],
"permissions":[
  ". . ."
],
"licenseFeatures":[
  "RUNTIME"
],
"emailVerified":true,
"passwordSet":true,
"questionsSet":true,
"enableAutoLogin":false,
"disabled":false,
"clientRegistered":false,
"description:"",
"createdBy":1,
"createdOn":"2022-03-10T13:39:56-05:00",
"updatedBy":1,
"updatedOn":"2022-03-13T02:09:38-05:00",
"publicKey":null,
"appType":null,
"routingName":null,
"appUrl":null
}
}
```

Response Parameters

Parameter	Type	Description
token	String	Generated access token that acts as a session ID that your application will use for making requests. This token is equivalent to the user credentials and must be protected.
user	Object	<p>The user object returned with all the details of the user.</p> <ul style="list-style-type: none"> • id - Id of the user. • email - Email id of the user. • username - User name of the user. • domain - Domain logged in to. • firstname - First name of the user. • lastname - Last name of the user. • roles - Roles assigned to the user. • sysAssignedRoles - System assigned roles. • permissions - Permissions assigned to the user. • licenseFeatures - License assigned to the user.

Insert the token in the request header of subsequent API requests.

Related concepts

[Authentication API](#)

Use the Authentication API to generate, refresh, and manage the JSON Web Tokens (JWTs) that are required for authentication and authorization in order to use the Control Room APIs.

Related reference

[Authenticate \(username and password\)](#)

Use this API to authenticate access to your Control Room with a valid `username` and `password`. A successfully completed response generates a JSON Web Token. By default, a token is valid for 20 minutes.

Create and assign API key generation role

As an Administrator, you can create a custom role to generate an API key and assign that custom role to users. By default, the `Generate API-Key` parameter is not enabled for any of the System-created roles.

To create and assign a custom role to generate an API key:

1. Log in as an Administrator to the Automation 360 Control Room.

2. Navigate to: **Administration > Roles**.
3. Click **Create role**. For more information, see [Create a role](#).
4. Scroll down to the **API** section.
5. Select **Generate API-Key**.

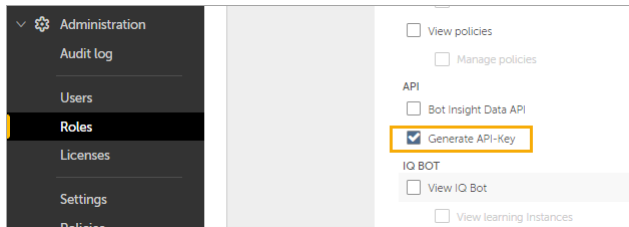

6. Enter a unique name in the **Role name** field.
7. Click **Create role**.
8. Navigate to: **Administration > Users**, and assign the custom role you just created to a non-Administration user.
9. Log in as the user you assigned the **Generate API-Key** role to.
10. Navigate to the username profile at the bottom left of the page and select **username > My settings**.
- 11.

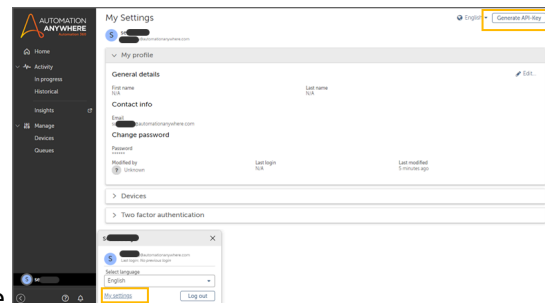

Click **Generate API-Key** at the top right of the page.

12. Copy the generated **API-Key** to your clipboard.

Use the **API-Key** to log in to a Control Room using SSO, or use the **API-Key** to log in as a user without a password.

Related reference

[Authenticate \(username and apiKey\)](#)

Use this API to authenticate access to a Control Room with the `username` and `apiKey`. A successful response generates a JSON Web Token. A generated token is valid for 20 minutes. You can generate the token without the need for the user's password, such as for organizations that use single sign-on (SSO).

Validate token

Verify if a JSON Web Token is valid.

Request

```
GET https://{{ControlRoomURL}}/v1/authentication/token?token=<token>
```

```
Header: X-Authorization <<authentication token>>
```

All API calls must contain either an authentication token from [Authentication API](#) (generates JSON Web token) or a bearer token from OAuth services. You cannot use both together in an API.

If the token is not valid, you must generate a token using one of the authentication methods:

[Authentication API](#)

Request Parameters

Parameter	Type	Required	Description
token	String	Yes	Enter the token you want to validate. To generate a token, see Authenticate (username and password and apiKey) .

Response

```
200 OK
```

```
{  
  "valid": true  
}
```

Response Parameters

Parameter	Type	Description
valid	Boolean	Returns <ol style="list-style-type: none"><code>true</code>, if the token is valid.<code>false</code>, if the token is invalid.

Note: You can view the in the , but API functionality is limited. You need a licensed Edition to access the full functionality of the APIs.

The REST API responds to each request with an HTTP response code. For response codes, see [API response codes](#).

Related concepts

[Authentication API](#)

```
"id": 3,
"username": "jdoe_user",
"domain": null,
"firstName": "John",
"lastName": "Doe",
"version": 268,
"principalId": 3,
"deleted": false,
"roles": [
  {
    "name": "Device_admin",
    "id": 24,
    "version": 3
  }
],
"sysAssignedRoles": [],
"groupNames": [],
"permissions": [
  {
    "id": 163,
    "action": "own",
    "resourceId": "1",
    "resourceType": "queue"
  },
  {
    "id": 141,
    "action": "cancelcheckout",
    "resourceId": null,
    "resourceType": "repositorymanager"
  },
  {
    "id": 165,
    "action": "own",
    "resourceId": "1",
    "resourceType": "pool"
  },
  {
    "id": 97,
    "action": "register",
    "resourceId": null,
    "resourceType": "devices"
  },
  {
    "id": 161,
    "action": "participate",
    "resourceId": "1",
    "resourceType": "queue"
  },
  {
    "id": 29,
    "action": "view",
    "resourceId": null,
    "resourceType": "repositorymanager"
  },
  {
    "id": 164,
    "action": "manage",
    "resourceId": "1",
    "resourceType": "pool"
  },
  {
    "id": 31,
    "action": "export",
    "resourceId": null,
```

```

        "resourceType": "repositorymanager"
      },
      {
        "id": 32,
        "action": "import",
        "resourceId": null,
        "resourceType": "repositorymanager"
      }
    ],
    "licenseFeatures": [
      "DEVELOPMENT"
    ],
    "emailVerified": true,
    "passwordSet": true,
    "questionsSet": true,
    "enableAutoLogin": true,
    "disabled": false,
    "clientRegistered": false,
    "description": "",
    "createdBy": 1,
    "createdOn": "2022-03-17T19:33:06Z",
    "updatedBy": 1,
    "updatedOn": "2022-04-08T21:54:29Z",
    "publicKey": null,
    "appType": null,
    "routingName": null,
    "appUrl": null,
    "email": "jdoe@aa.com",
    "lastLoginTime": "2022-04-08T21:54:15Z",
    "deviceCredentialAttested": false,
    "multipleLoginAllowed": true
  },
  "tenantUuid": "282978c4-6386-c13a-92ac-5009e3cfd6b3",
  "mfaAuthResponse": null
}

```

Response Parameters

Parameter	Type	Description
token	String	Generated access token that acts as a session ID that your application will use for making requests. This token is equivalent to the user credentials and must be protected. Note: If <i>multipleLogin</i> is set to <i>true</i> , you will be able to use this token for multiple API sessions.

Parameter	Type	Description
user	Object	<p>The user object returned with all the details of the user.</p> <ul style="list-style-type: none"> • id - Id of the user. • email - Email id of the user. • username - User name of the user. • domain - Domain logged in to. • firstname - First name of the user. • lastname - Last name of the user. • roles - Roles assigned to the user. • sysAssignedRoles - System assigned roles. • permissions - Permissions assigned to the user. • licenseFeatures - License assigned to the user.

Note: You can view the in the , but API functionality is limited. You need a licensed Edition to access the full functionality of the APIs.

The REST API responds to each request with an HTTP response code. For response codes, see [API response codes](#).

Related concepts

[Authentication API](#)

Use the Authentication API to generate, refresh, and manage the JSON Web Tokens (JWTs) that are required for authentication and authorization in order to use the Control Room APIs.

Expire token

Immediately log out the user and invalidate their JSON Web Token so that it cannot be used for authentication.

Request

```
POST https://{ControlRoomURL}/v1/authentication/logout
```

```
Header: X-Authorization: <<authentication token>> or Authorization: Bearer <<bearer token>>
```

All API calls must contain either an authentication token from [Authentication API](#) (generates JSON Web token) or a bearer token from OAuth services. You cannot use both together in an API.

Request body:

```
{
  "token":
  "eyJhbGciOiJSUzUxMiJ9.eyJzdWIiOiIxIiwiaWF0IjoiY2xpZW50VHlwZSI6IldFQIIsImxpY2Vuc2VzIjpbXSwiYW5hbnR7cmFDpLxZ28xLnFJYhaIuMNdW9dWDVquBWTQSpYGNJd56D-tFFHBodwVdNamqWHxaQebq1zMyUyQV6Q-gKdgubpT5gwuXnp-BwScjHOYM3Fpj_nt0nEbJC5uWpJNtLQBpVzhsRwwlRKNOHQVbo6X7zkvKBoij8ewa5FWQwX7T-760BeqfssR6mmX5PcyCkrVJju2XqItQ9XMGNP7h_MaUDotU_CJyguPZA"
}
```

Request Parameters

Parameter	Type	Required	Description
token	String	Yes	Enter the session's token that you want to logout. To generate a token, see Authenticate (username and password and apiKey) .

Response

```
204 No Response
```

Note: You can view the in the , but API functionality is limited. You need a licensed Edition to access the full functionality of the APIs.

The REST API responds to each request with an HTTP response code. For response codes, see [API response codes](#).

Related reference[Authenticate \(username and apiKey\)](#)

Use this API to authenticate access to a Control Room with the `username` and `apikey`. A successful response generates a JSON Web Token. A generated token is valid for 20 minutes. You can generate the token without the need for the user's password, such as for organizations that use single sign-on (SSO).

User management APIs

Use `User Management` APIs to create, search, update, or delete roles and users in your Control Room.

Note: You can view the in the , but API functionality is limited. You need a licensed Edition to access the full functionality of the APIs.

User Management Roles

Users need the following permissions in order to create and manage users and roles.

- **View users**

You need an administrator permission to create and manage users and roles. It is recommended that non-administrator users be given limited permissions for creating and managing users. Learn how to [create a role with limited permissions](#) that can be assigned to users.

- **Create users**

Create new users in the Control Room.

- **Edit users**

Edit all users in the Control Room, including users created by other administrators.

- **Delete users**

Delete any user in the Control Room.

- **View roles**

Users with this permission can view roles to which they have access.

- **Manage roles**

Users can create, edit and delete roles to which they have access.

- **View licenses**

Users with these permissions are able to view and manage device licenses. Device licenses are required to enable users to perform specific tasks. For example, Bot Creators require a **DEVELOPMENT** device license in order to create bots.

- **Manage users device license**

Users with this permission can assign device licenses to other users.

Role APIs

Use `Role` APIs to List Roles, create a role, retrieve a specific role using an object ID, update a role, or delete a role.

List roles

Retrieves current roles based on search criteria, such as filtering, sorting, and pagination.

```
POST http://<your_control_room_url>/v1/usermanagement/roles/list
```

Create role

Creates a new role with a new role name.

```
POST http://<your_control_room_url>/v1/usermanagement/roles
```

Retrieve role

Retrieves a specific role based on a unique role ID.

```
GET http://<your_control_room_url>/v1/usermanagement/roles/{id}
```

Update role

Modifies an existing role name based on a unique role ID.

```
PUT http://<your_control_room_url>/v1/usermanagement/roles/{id}
```

Delete role

Deletes an existing role based on a unique role ID.

```
DELETE http://  
<your_control_room_url>/v1/  
usermanagement/roles/{id}
```

User APIs

Use `User` APIs to create a user, search for users, retrieve a user details based on a user ID, update a specific user details, or delete a user.

Create user

Creates a user with a new user name.

```
POST http://<your_control_room_url>/  
v1/usermanagement/users
```

Search for users API

Retrieves current users based on search criteria, such as filtering, sorting, and pagination.

```
POST http://<your_control_room_url>/  
v1/usermanagement/users/list
```

Retrieve a specific user details API

Retrieves user details based on a unique user ID.

```
GET http://<your_control_room_url>/  
v1/usermanagement/users/{uid}
```

Update an existing user details API

Modifies an existing user name based on a unique user ID.

```
PUT http://<your_control_room_url>/  
v1/usermanagement/users/{uid}
```

Delete an existing user API

Deletes an existing user based on a unique user ID.

```
DELETE http://  
<your_control_room_url>/v1/  
usermanagement/users/{uid}
```

Related concepts

[Authentication API](#)

Use the Authentication API to generate, refresh, and manage the JSON Web Tokens (JWTs) that are required for authentication and authorization in order to use the Control Room APIs.

Related reference

[Roles and permissions](#)

Assign roles from the Automation 360 Administration user interface or through the User Management API to enable users to access features. You can assign a system-created role or create a custom role with specific permissions.

Create role

Use `Create role` API to create a new role with permissions in the Control Room.

Request

```
POST https://{ControlRoomURL}/v1/usermanagement/roles
```

```
Header: X-Authorization: <<authentication token>> or Authorization: Bearer <<bearer token>>
```

All API calls must contain either an authentication token from [Authentication API](#) (generates JSON Web token) or a bearer token from OAuth services. You cannot use both together in an API.

Request body:

```
{
  "name": "Trigger Manager",
  "description": "View and Manage the triggers",
  "permissions": [
    {
      "id": 148,
      "action": "view",
      "resourceType": "dashboard",
      "resourceId": null
    },
    {
      "id": 58,
      "action": "myschedule",
      "resourceType": "taskscheduling",
      "resourceId": null
    },
    {
      "id": 59,
      "action": "managecredentials",
      "resourceType": "credentials",
      "resourceId": null
    },
    {
      "id": 30,
      "action": "view",
      "resourceType": "devices",
      "resourceId": null
    },
    {
      "id": 150,
      "action": "manage",
      "resourceType": "eventtriggers",
      "resourceId": null
    },
    {
      "id": 149,
      "action": "view",
      "resourceType": "eventtriggers",

```

```

    "resourceId":null
  },
  {
    "id":131,
    "action":"managemytriggers",
    "resourceType":"eventtriggers",
    "resourceId":null
  }
],
"principals":[
  {
    "id":3
  }
]
}

```

Request Parameters

Parameter	Type	Required	Description
name	String	Yes	Name of the role.
description	String	No	Description of the role.
permissions	Array	No	An array of permissions that will be granted for the role. mandatory parameters. For more details on the parameter, see Permissions .
principals	Array	No	An array/collection of principals (users) who will be granted the role. For more information on the parameters, see below.

permission array parameters

Parameter	Type	Required	Description
id	Integer	No	The numeric value that uniquely identifies the permission.
action	String	No	The action the permission enables.
resourceId	String	No	The resource id to which the action belongs.
resourceType	Array	No	The resource group to which the action belongs. Typically a user is given the role permission in conjunction with a resource type permission. Roles and permissions

principals array parameters

Parameter	Type	Required	Description
id	Integer	No	Id of the user.
username	String	No	User name of the user.
subjectId	String	No	Subject Id of the user.
domain	String	No	Active directory domain, if the user is an AD User.
autoLoginEnabled	Boolean	No	Flag to indicate if auto login is enabled or not.
deleted	Boolean	No	Flag to indicate if user is deleted or not.

Parameter	Type	Required	Description
emailVerified	Boolean	No	Flag to indicate if email is verified or not.
pwdExpired	Boolean	No	Flag to indicate if password is expired or not.

Response

201 Created

```
{
  "id":25,
  "createdBy":1,
  "createdOn":"2022-04-11T11:53:03Z",
  "updatedBy":1,
  "updatedOn":"2022-04-11T11:53:03Z",
  "tenantId":1,
  "version":0,
  "tenantUuid":"282978c4-6386-c13a-92ac-5009e3cfd6b3",
  "description":"View and Manage the triggers",
  "name":"Trigger Manager",
  "permissions":[
    {
      "id":59,
      "createdBy":0,
      "createdOn":"2022-02-28T23:49:21Z",
      "updatedBy":0,
      "updatedOn":"2022-02-28T23:49:21Z",
      "tenantId":1,
      "version":0,
      "tenantUuid":"282978c4-6386-c13a-92ac-5009e3cfd6b3",
      "action":"managecredentials",
      "resourceId":null,
      "resourceType":"credentials"
    },
    {
      "id":131,
      "createdBy":0,
      "createdOn":"2022-02-28T23:49:31Z",
      "updatedBy":0,
      "updatedOn":"2022-02-28T23:49:31Z",
      "tenantId":1,
      "version":0,
      "tenantUuid":"282978c4-6386-c13a-92ac-5009e3cfd6b3",
      "action":"managemytriggers",
      "resourceId":null,
      "resourceType":"eventtriggers"
    },
    {
      "id":149,
      "createdBy":0,
      "createdOn":"2022-02-28T23:49:42Z",
      "updatedBy":0,
      "updatedOn":"2022-02-28T23:49:42Z",
      "tenantId":1,
      "version":0,
      "tenantUuid":"282978c4-6386-c13a-92ac-5009e3cfd6b3",
      "action":"view",
      "resourceId":null,
    }
  ]
}
```

```

    "resourceType":"eventtriggers"
  },
  {
    "id":58,
    "createdBy":0,
    "createdOn":"2022-02-28T23:49:21Z",
    "updatedBy":0,
    "updatedOn":"2022-02-28T23:49:21Z",
    "tenantId":1,
    "version":0,
    "tenantUuid":"282978c4-6386-c13a-92ac-5009e3cfd6b3",
    "action":"myschedule",
    "resourceId":null,
    "resourceType":"taskscheduling"
  },
  {
    "id":148,
    "createdBy":0,
    "createdOn":"2022-02-28T23:49:38Z",
    "updatedBy":0,
    "updatedOn":"2022-02-28T23:49:38Z",
    "tenantId":1,
    "version":0,
    "tenantUuid":"282978c4-6386-c13a-92ac-5009e3cfd6b3",
    "action":"view",
    "resourceId":null,
    "resourceType":"dashboard"
  },
  {
    "id":150,
    "createdBy":0,
    "createdOn":"2022-02-28T23:49:42Z",
    "updatedBy":0,
    "updatedOn":"2022-02-28T23:49:42Z",
    "tenantId":1,
    "version":0,
    "tenantUuid":"282978c4-6386-c13a-92ac-5009e3cfd6b3",
    "action":"manage",
    "resourceId":null,
    "resourceType":"eventtriggers"
  },
  {
    "id":30,
    "createdBy":0,
    "createdOn":"2022-02-28T23:49:21Z",
    "updatedBy":0,
    "updatedOn":"2022-02-28T23:49:21Z",
    "tenantId":1,
    "version":0,
    "tenantUuid":"282978c4-6386-c13a-92ac-5009e3cfd6b3",
    "action":"view",
    "resourceId":null,
    "resourceType":"devices"
  }
],
"countPrincipals":0,
"systemRole":false,
"principals":[
  {
    "id":3,
    "createdBy":1,
    "createdOn":"2022-03-17T19:33:06Z",
    "updatedBy":1,
    "updatedOn":"2022-04-08T21:54:29Z",

```

```

    "tenantId":1,
    "version":274,
    "tenantUuid":"282978c4-6386-c13a-92ac-5009e3cfd6b3",
    "username":"john_doe",
    "description":"","
    "deleted":false,
    "disabled":false,
    "email":"aa@aa.com",
    "firstName":"John",
    "lastName":"Doe",
    "autoLoginEnabled":true,
    "emailVerified":true,
    "clientRegistered":false,
    "passwordSet":true,
    "questionsSet":true,
    "activeDirectory":false,
    "passwordChangedOn":"2022-03-17T19:33:59Z",
    "deviceCredentialAttested":false,
    "multipleLoginAllowed":true
  }
]
}

```

Response Parameters

Parameter	Type	Description
id	Integer	Unique identifier representing the new role created.
name	String	Name of the role created.
description	String	Description of the role created.
version	Integer	Version of the role instance.
createdBy	Integer	Id of the user who created the role.
createdOn	String	The creation timestamp of the role.
updatedBy	Integer	Id of the user who made a latest update to the role.
updatedOn	String	The latest update timestamp of the role.
permissions	Array	An array of unique permissions that have been assigned to the role.
principals	Array	An array of unique users that have been assigned to the role.

Note: You can view the in the , but API functionality is limited. You need a licensed Edition to access the full functionality of the APIs.

The REST API responds to each request with an HTTP response code. For response codes, see [API response codes](#).

List roles

Use the `List Roles` API to retrieve a list of roles in the Control Room. The endpoint supports pagination, sorting, and filtering.

Request

```
POST http://{{ControlRoomURL}}/v1/usermanagement/roles/list
```

```
Header: X-Authorization: <<authentication token>> or Authorization: Bearer <<bearer token>>
```

All API calls must contain either an authentication token from [Authentication API](#) (generates JSON Web token) or a bearer token from OAuth services. You cannot use both together in an API.

Request body without filters:

```
{
  "sort": [
    {
      "field": "name",
      "direction": "asc"
    }
  ],
  "filter": {
  },
  "page": {
    "offset": 0,
    "total": 100,
    "totalFilter": 100,
    "length": 200
  }
}
```

Request body with filters:

```
{
  "sort": [
    {
      "field": "name",
      "direction": "asc"
    }
  ],
  "filter": {
    "operator": "and",
    "operands": [
      {
        "operator": "substring",
        "field": "name",
        "value": "Device"
      },
      {
        "operator": "gt",
        "field": "createdOn",
        "value": "2022-02-01T00:00:00.989Z"
      }
    ]
  }
}
```

```

      "operator": "lt",
      "field": "createdOn",
      "value": "2022-03-20T23:00:00.123Z"
    }
  ]
},
"page": {
  "offset": 0,
  "total": 100,
  "totalFilter": 100,
  "length": 200
}
}

```

Request Parameters

Parameter	Type	Required	Description
sort	Array	No	By default, search results are sorted in descending order with respect to their ids. An alternative sorting is specified using the sort query parameter. Enter the field by which you want to sort along with the direction <code>asc</code> (ascending) or <code>desc</code> (descending).
filter	Object	No	Filters the result.
page	Object	No	The page object allows you to get the desired pages.

For more information on Filtering, Pagination, and Sorting, see [Filtering, pagination, and sorting](#).

Response

```

{
  "page": {
    "offset": 0,
    "total": 21,
    "totalFilter": 1
  },
  "list": [
    {
      "id": 24,
      "name": "Device_admin",
      "description": "This is a device admin role",
      "countPrincipals": 1,
      "version": 1,
      "createdBy": 1,
      "createdOn": "2022-03-17T19:32:20.620Z",
      "updatedBy": 1,
      "updatedOn": "2022-03-24T02:20:13.787Z",
      "systemRole": false
    }
  ]
}

```

Response Parameters

Parameter	Type	Description
offset	Integer	The starting list offset, used for pagination.
total	Integer	Total number of records.
totalFilter	Integer	Number of records after applying the filter.
List	Array	The array of List roles object.
List roles object		
id	Integer	The unique Id of a specific role.
name	String	Name of role.
description	String	Description of role.
countPrincipals	Integer	Count of Principals (users) who are granted with this role.
version	Integer	Version of the role instance.
createdBy	Integer	Id of the user who created the role.
createdOn	String	The creation timestamp of the role.
updatedBy	Integer	Id of the user who made a latest update to the role.
updatedOn	String	The latest update timestamp of the role.
systemRole	Boolean	Flag to indicate if this role is system role or not.

Note: You can view the in the , but API functionality is limited. You need a licensed Edition to access the full functionality of the APIs.

The REST API responds to each request with an HTTP response code. For response codes, see [API response codes](#).

Retrieve role

Use the `Get role by ID` API to retrieve a specific role in the Control Room.

Request

```
GET https://{{ControlRoomURL}}/v1/usermanagement/roles/<role ID>
```

```
Header: X-Authorization: <<authentication token>> or Authorization: Bearer <<bearer token>>
```

All API calls must contain either an authentication token from [Authentication API](#) (generates JSON Web token) or a bearer token from OAuth services. You cannot use both together in an API.

Request Parameters

Parameter	Type	Required	Description
role ID	Integer	Yes	Enter the Id of the role.

Response

200 OK

```
{
  "id": 264,
  "createdBy": 10,
  "createdOn": "2022-04-12T12:12:39Z",
  "updatedBy": 10,
  "updatedOn": "2022-04-12T12:12:39Z",
  "tenantId": 1,
  "version": 0,
  "tenantUuid": "06e42523-b44a-49f4-82dc-b8d420896761",
  "description": "",
  "name": "Device admin",
  "permissions": [
    {
      "id": 1345,
      "createdBy": 0,
      "createdOn": "2022-04-11T19:46:24Z",
      "updatedBy": 1,
      "updatedOn": "2022-04-11T19:46:24Z",
      "tenantId": 1,
      "version": 0,
      "tenantUuid": "06e42523-b44a-49f4-82dc-b8d420896761",
      "action": "managecredentials",
      "resourceId": null,
      "resourceType": "credentials"
    },
    {
      "id": 1424,
      "createdBy": 0,
      "createdOn": "2022-04-11T19:46:24Z",
      "updatedBy": 1,
      "updatedOn": "2022-04-11T19:46:24Z",
      "tenantId": 1,
      "version": 0,
      "tenantUuid": "06e42523-b44a-49f4-82dc-b8d420896761",
      "action": "delete",
      "resourceId": null,
      "resourceType": "devices"
    },
    {
      "id": 1425,
      "createdBy": 0,
      "createdOn": "2022-04-11T19:46:24Z",
      "updatedBy": 1,
      "updatedOn": "2022-04-11T19:46:24Z",
      "tenantId": 1,
      "version": 0,
      "tenantUuid": "06e42523-b44a-49f4-82dc-b8d420896761",
      "action": "edit",

```

```
    "resourceId": null,
    "resourceType": "devices"
  },
  {
    "id": 1344,
    "createdBy": 0,
    "createdOn": "2022-04-11T19:46:24Z",
    "updatedBy": 1,
    "updatedOn": "2022-04-11T19:46:24Z",
    "tenantId": 1,
    "version": 0,
    "tenantUuid": "06e42523-b44a-49f4-82dc-b8d420896761",
    "action": "myschedule",
    "resourceId": null,
    "resourceType": "taskscheduling"
  },
  {
    "id": 1426,
    "createdBy": 0,
    "createdOn": "2022-04-11T19:46:24Z",
    "updatedBy": 1,
    "updatedOn": "2022-04-11T19:46:24Z",
    "tenantId": 1,
    "version": 0,
    "tenantUuid": "06e42523-b44a-49f4-82dc-b8d420896761",
    "action": "view",
    "resourceId": null,
    "resourceType": "dashboard"
  },
  {
    "id": 1414,
    "createdBy": 0,
    "createdOn": "2022-04-11T19:46:24Z",
    "updatedBy": 1,
    "updatedOn": "2022-04-11T19:46:24Z",
    "tenantId": 1,
    "version": 0,
    "tenantUuid": "06e42523-b44a-49f4-82dc-b8d420896761",
    "action": "attestcredentials",
    "resourceId": null,
    "resourceType": "devices"
  },
  {
    "id": 1381,
    "createdBy": 0,
    "createdOn": "2022-04-11T19:46:24Z",
    "updatedBy": 1,
    "updatedOn": "2022-04-11T19:46:24Z",
    "tenantId": 1,
    "version": 0,
    "tenantUuid": "06e42523-b44a-49f4-82dc-b8d420896761",
    "action": "register",
    "resourceId": null,
    "resourceType": "devices"
  },
  {
    "id": 1321,
    "createdBy": 0,
    "createdOn": "2022-04-11T19:46:24Z",
    "updatedBy": 1,
    "updatedOn": "2022-04-11T19:46:24Z",
    "tenantId": 1,
    "version": 0,
    "tenantUuid": "06e42523-b44a-49f4-82dc-b8d420896761",
```

```

        "action": "view",
        "resourceId": null,
        "resourceType": "devices"
    },
    {
        "id": 1423,
        "createdBy": 0,
        "createdOn": "2022-04-11T19:46:24Z",
        "updatedBy": 1,
        "updatedOn": "2022-04-11T19:46:24Z",
        "tenantId": 1,
        "version": 0,
        "tenantUuid": "06e42523-b44a-49f4-82dc-b8d420896761",
        "action": "all",
        "resourceId": null,
        "resourceType": "devices"
    }
],
"countPrincipals": 0,
"systemRole": false,
"principals": [
    {
        "id": 21,
        "createdBy": 10,
        "createdOn": "2022-04-12T12:12:19Z",
        "updatedBy": 21,
        "updatedOn": "2022-04-13T03:37:08Z",
        "tenantId": 1,
        "version": 19,
        "tenantUuid": "06e42523-b44a-49f4-82dc-b8d420896761",
        "username": "john_user",
        "description": "User",
        "deleted": false,
        "disabled": false,
        "email": "john.doe@aa.com",
        "firstName": "John",
        "lastName": "Doe",
        "autoLoginEnabled": true,
        "emailVerified": true,
        "clientRegistered": false,
        "passwordSet": true,
        "questionsSet": true,
        "activeDirectory": false,
        "passwordChangedOn": "2022-04-12T12:13:35Z",
        "deviceCredentialAttested": false,
        "multipleLoginAllowed": true
    }
]
}

```

Response Parameters

Parameter	Type	Description
id	Integer	Unique identifier representing the new role created.
name	String	Name of the role created.
description	String	Description of the role created.

Parameter	Type	Description
version	Integer	Version of the role instance.
createdBy	Integer	Id of the user who created the role.
createdOn	String	The creation timestamp of the role.
updatedBy	Integer	Id of the user who made a latest update to the role.
updatedOn	String	The latest update timestamp of the role.
permissions	Array	An array of unique permissions that have been assigned to the role.
principals	Array	An array of unique users that have been assigned to the role.

Note: You can view the in the , but API functionality is limited. You need a licensed Edition to access the full functionality of the APIs.

The REST API responds to each request with an HTTP response code. For response codes, see [API response codes](#).

Update role

Use the `Update role` API to update an existing role in the Control Room.

Request

```
PUT https://{ControlRoomURL}/v1/usermanagement/roles/<role ID>
```

```
Header: X-Authorization: <<authentication token>> or Authorization: Bearer <<bearer token>>
```

All API calls must contain either an authentication token from [Authentication API](#) (generates JSON Web token) or a bearer token from OAuth services. You cannot use both together in an API.

Request body:

```
{
  "id":25,
  "name":"Trigger Manager",
  "principals":[
    {
      "id":3
    },
    {
      "id":4
    }
  ],
}
```

```

"description":"View and Manage the triggers",
"permissions":[
  {
    "id":148,
    "action":"view",
    "resourceType":"dashboard",
    "resourceId":null
  },
  {
    "id":58,
    "action":"myschedule",
    "resourceType":"taskscheduling",
    "resourceId":null
  },
  {
    "id":149,
    "action":"view",
    "resourceType":"eventtriggers",
    "resourceId":null
  },
  {
    "id":150,
    "action":"manage",
    "resourceType":"eventtriggers",
    "resourceId":null
  },
  {
    "id":131,
    "action":"managemytriggers",
    "resourceType":"eventtriggers",
    "resourceId":null
  },
  {
    "id":59,
    "action":"managecredentials",
    "resourceType":"credentials",
    "resourceId":null
  },
  {
    "id":30,
    "action":"view",
    "resourceType":"devices",
    "resourceId":null
  }
],
"existingRepositoryPermissions":[
],
"version":0
}

```

Request Parameters

Parameter	Type	Required	Description
name	String	Yes	Enter the name of the role.
description	String	No	Description of the role.
permissions	Array	No	An array of permissions that will be granted for the role. mandatory parameters. For more details on the parameter

Parameter	Type	Required	Description
principals	Array	No	An array/collection of principals (users) who will be granted the permission. For more information on the parameters, see below.

permission array parameters

Parameter	Type	Required	Description
id	Integer	No	The numeric value that uniquely identifies the permission.
action	String	No	The action the permission enables.
resourceId	String	No	The resource id to which the action belongs.
resourceType	Array	No	The resource group to which the action belongs. Typically a user is given the role permission in conjunction with the resource permission. Roles and permissions

principals array parameters

Parameter	Type	Required	Description
id	Integer	No	Id of the user.
username	String	No	User name of the user.
subjectId	String	No	Subject Id of the user.
domain	String	No	Active directory domain, if the user is an AD User.
autoLoginEnabled	Boolean	No	Flag to indicate if auto login is enabled or not.
deleted	Boolean	No	Flag to indicate if user is deleted or not.
emailVerified	Boolean	No	Flag to indicate if email is verified or not.
pwdExpired	Boolean	No	Flag to indicate if password is expired or not.

Response

200 OK

```
{
  "id":25,
  "createdBy":1,
  "createdOn":"2022-04-11T11:53:03Z",
  "updatedBy":1,
  "updatedOn":"2022-04-11T12:01:31Z",
  "tenantId":1,
  "version":1,
  "tenantUuid":"282978c4-6386-c13a-92ac-5009e3cfd6b3",
  "description":"View and Manage the triggers",
  "name":"Trigger Manager",
  "permissions":[
    {
      "id":59,
      "createdBy":0,
```

```

    "createdOn": "2022-02-28T23:49:21Z",
    "updatedBy": 0,
    "updatedOn": "2022-02-28T23:49:21Z",
    "tenantId": 1,
    "version": 0,
    "tenantUuid": "282978c4-6386-c13a-92ac-5009e3cfd6b3",
    "action": "managecredentials",
    "resourceId": null,
    "resourceType": "credentials"
  },
  {
    "id": 131,
    "createdBy": 0,
    "createdOn": "2022-02-28T23:49:31Z",
    "updatedBy": 0,
    "updatedOn": "2022-02-28T23:49:31Z",
    "tenantId": 1,
    "version": 0,
    "tenantUuid": "282978c4-6386-c13a-92ac-5009e3cfd6b3",
    "action": "managemytriggers",
    "resourceId": null,
    "resourceType": "eventtriggers"
  },
  {
    "id": 149,
    "createdBy": 0,
    "createdOn": "2022-02-28T23:49:42Z",
    "updatedBy": 0,
    "updatedOn": "2022-02-28T23:49:42Z",
    "tenantId": 1,
    "version": 0,
    "tenantUuid": "282978c4-6386-c13a-92ac-5009e3cfd6b3",
    "action": "view",
    "resourceId": null,
    "resourceType": "eventtriggers"
  },
  {
    "id": 58,
    "createdBy": 0,
    "createdOn": "2022-02-28T23:49:21Z",
    "updatedBy": 0,
    "updatedOn": "2022-02-28T23:49:21Z",
    "tenantId": 1,
    "version": 0,
    "tenantUuid": "282978c4-6386-c13a-92ac-5009e3cfd6b3",
    "action": "myschedule",
    "resourceId": null,
    "resourceType": "taskscheduling"
  },
  {
    "id": 148,
    "createdBy": 0,
    "createdOn": "2022-02-28T23:49:38Z",
    "updatedBy": 0,
    "updatedOn": "2022-02-28T23:49:38Z",
    "tenantId": 1,
    "version": 0,
    "tenantUuid": "282978c4-6386-c13a-92ac-5009e3cfd6b3",
    "action": "view",
    "resourceId": null,
    "resourceType": "dashboard"
  },
  {
    "id": 150,

```

```

    "createdBy":0,
    "createdOn":"2022-02-28T23:49:42Z",
    "updatedBy":0,
    "updatedOn":"2022-02-28T23:49:42Z",
    "tenantId":1,
    "version":0,
    "tenantUuid":"282978c4-6386-c13a-92ac-5009e3cfd6b3",
    "action":"manage",
    "resourceId":null,
    "resourceType":"eventtriggers"
  },
  {
    "id":30,
    "createdBy":0,
    "createdOn":"2022-02-28T23:49:21Z",
    "updatedBy":0,
    "updatedOn":"2022-02-28T23:49:21Z",
    "tenantId":1,
    "version":0,
    "tenantUuid":"282978c4-6386-c13a-92ac-5009e3cfd6b3",
    "action":"view",
    "resourceId":null,
    "resourceType":"devices"
  }
],
"countPrincipals":0,
"systemRole":false,
"principals":[
  {
    "id":3,
    "createdBy":1,
    "createdOn":"2022-03-17T19:33:06Z",
    "updatedBy":1,
    "updatedOn":"2022-04-08T21:54:29Z",
    "tenantId":1,
    "version":274,
    "tenantUuid":"282978c4-6386-c13a-92ac-5009e3cfd6b3",
    "username":"john_user",
    "description":"","
    "deleted":false,
    "disabled":false,
    "email":"john.doe@aa.com",
    "firstName":"John",
    "lastName":"Doe",
    "autoLoginEnabled":true,
    "emailVerified":true,
    "clientRegistered":false,
    "passwordSet":true,
    "questionsSet":true,
    "activeDirectory":false,
    "passwordChangedOn":"2022-03-17T19:33:59Z",
    "deviceCredentialAttested":false,
    "multipleLoginAllowed":true
  },
  {
    "id":4,
    "createdBy":1,
    "createdOn":"2022-04-04T15:32:38Z",
    "updatedBy":1,
    "updatedOn":"2022-04-04T15:32:38Z",
    "tenantId":1,
    "version":11,
    "tenantUuid":"282978c4-6386-c13a-92ac-5009e3cfd6b3",
    "username":"test_admin",

```

```

    "description": "",
    "deleted": false,
    "disabled": false,
    "email": "testadmin@aa.com",
    "firstName": "Test",
    "lastName": "Admin",
    "autoLoginEnabled": false,
    "emailVerified": true,
    "clientRegistered": false,
    "passwordSet": true,
    "questionsSet": true,
    "activeDirectory": false,
    "passwordChangedOn": "2022-04-04T15:33:22Z",
    "deviceCredentialAttested": false,
    "multipleLoginAllowed": true
  }
]
}

```

Response Parameters

Parameter	Type	Description
id	Integer	Unique identifier representing the new role created.
name	String	Name of the role created.
description	String	Description of the role created.
version	Integer	Version of the role instance.
createdBy	Integer	Id of the user who created the role.
createdOn	String	The creation timestamp of the role.
updatedBy	Integer	Id of the user who made a latest update to the role.
updatedOn	String	The latest update timestamp of the role.
permissions	Array	An array of unique permissions that have been assigned to the role.
principals	Array	An array of unique users that have been assigned to the role.

Note: You can view the in the , but API functionality is limited. You need a licensed Edition to access the full functionality of the APIs.

The REST API responds to each request with an HTTP response code. For response codes, see [API response codes](#).

Delete role

Use the `Delete role` API to delete an existing role in the Control Room.

Request

```
DELETE https://{ControlRoomURL}/v1/usermanagement/roles/<role ID>
```

```
Header: X-Authorization: <<authentication token>> or Authorization: Bearer <<bearer token>>
```

All API calls must contain either an authentication token from [Authentication API](#) (generates JSON Web token) or a bearer token from OAuth services. You cannot use both together in an API.

Request Parameters

Parameter	Type	Required	Description
role ID	Integer	Yes	Enter the Id of the role.

Response

```
200 OK
```

Note: You can view the in the , but API functionality is limited. You need a licensed Edition to access the full functionality of the APIs.

The REST API responds to each request with an HTTP response code. For response codes, see [API response codes](#).

Create user

Use the `Create user` API to create a new user in the Control Room.

Request

```
POST https://{ControlRoomURL}/v1/usermanagement/users
```

```
Header: X-Authorization: <<authentication token>> or Authorization: Bearer <<bearer token>>
```

All API calls must contain either an authentication token from [Authentication API](#) (generates JSON Web token) or a bearer token from OAuth services. You cannot use both together in an API.

Request body:

```
{
```

```

"roles": [
  {
    "id": 185
  }
],
"email": "aaa@a.com",
"enableAutoLogin": true,
"username": "test1",
"description": "",
"firstName": "joe",
"lastName": "doe",
"disabled": false,
"password": "aa360aa360",
"licenseFeatures": [
  "DEVELOPMENT"
],
"sysAssignedRoles": [],
"deviceCredentialAttested": false
}

```

Request Parameters

Parameter	Type	Required	Description
roles	Integer	Yes	Id of the role. To find an ID of a role, see List roles .
domain	string	No	ActiveDirectory domain
email	String	No	Email of the user
enableAutoLogin	Boolean	No	Flag to enable or disable Auto login.
username	String	Yes	Username of the user.
password	String	Yes	Password of the user.
firstName	String	No	First name of the user
lastName	String	No	Last name of the user
disabled	boolean	No	Enable or disable the user
description	String	Yes	Provide a description.
licenseFeatures	String	No	License allocated to the user. You will be able to retrieve the available licenses using List Control Room licenses . Note: licenseFeatures is case sensitive and must be entered in ALL CAPS. Valid licenseFeatures inputs include: DEVELOPMENT, RUNTIME, ANALYTICSCLIENT, ATTENDED, DISCOVERYBOTANALYZER, DISCOVERYBOTRECORDER, AARIUSER, CITIZENDEVELOPER, and CLOUDBOTRUNNER
sysAssignedRoles	Integer	No	System assigned roles

Parameter	Type	Required	Description
deviceCredential	String	No	Device Credential attested.

Response

201 Created

```
{
  "id": 129,
  "username": "test1",
  "domain": null,
  "firstName": "joe",
  "lastName": "doe",
  "version": 0,
  "principalId": 129,
  "deleted": false,
  "roles": [
    {
      "name": "AAE_Basic",
      "id": 185,
      "version": 1
    }
  ],
  "sysAssignedRoles": [],
  "groupNames": [],
  "permissions": [
    {
      "id": 1381,
      "action": "register",
      "resourceId": null,
      "resourceType": "devices"
    },
    {
      "id": 1346,
      "action": "createstandard",
      "resourceId": null,
      "resourceType": "credentialattribute"
    },
    {
      "id": 1378,
      "action": "view",
      "resourceId": null,
      "resourceType": "botstore"
    },
    {
      "id": 1417,
      "action": "viewuserrolebasicinfo",
      "resourceId": null,
      "resourceType": "usermanagement"
    },
    {
      "id": 1426,
      "action": "view",
      "resourceId": null,
      "resourceType": "dashboard"
    },
    {
      "id": 1376,
```

```

        "action": "view",
        "resourceId": null,
        "resourceType": "packagemanager"
    },
    {
        "id": 1305,
        "action": "run",
        "resourceId": null,
        "resourceType": "repositorymanager"
    },
    {
        "id": 1320,
        "action": "view",
        "resourceId": null,
        "resourceType": "repositorymanager"
    }
],
"licenseFeatures": [
    "DEVELOPMENT"
],
"emailVerified": true,
"passwordSet": false,
"questionsSet": false,
"enableAutoLogin": true,
"disabled": false,
"clientRegistered": false,
"description": "",
"createdBy": 21,
"createdOn": "2022-10-16T17:52:14Z",
"updatedBy": 21,
"updatedOn": "2022-10-16T17:52:14Z",
"publicKey": null,
"appType": null,
"routingName": null,
"appUrl": null,
"email": "aaa@a.com",
"lastLoginTime": null,
"deviceCredentialAttested": false,
"multipleLoginAllowed": false
}

```

Response Parameters

Parameter	Type	Description
id	Integer	Unique identifier representing the new user created.
Roles		
name	String	Name of the role.
id	Integer	Id of the role
version	Integer	Version of the role instance.
Permissions		
permissions	Array	An array of unique permissions that have been assigned to the user.
id	Integer	Id of the permission.

Parameter	Type	Description
action	String	Action associated with the permission.
resourceId	Integer	Resource Id
resourceType	String	Type of resource
createdBy	Integer	Id of the user who created the user.
createdOn	String	The creation timestamp of the user.
updatedBy	Integer	Id of the user who made a latest update to the user.
updatedOn	String	The latest update timestamp of the user.

Note: You can view the in the , but API functionality is limited. You need a licensed Edition to access the full functionality of the APIs.

The REST API responds to each request with an HTTP response code. For response codes, see [API response codes](#).

Search for users API

Use the `Search for users` API to search for all users in the Control Room.

Request

```
POST http://{{ControlRoomURL}}/v1/usermanagement/users/list
```

```
Header: X-Authorization: <<authentication token>> or Authorization: Bearer <<bearer token>>
```

All API calls must contain either an authentication token from [Authentication API](#) (generates JSON Web token) or a bearer token from OAuth services. You cannot use both together in an API.

To search for users, you must have one of the following:

- **Admin** role
- Custom role with **View Users** permission

Request body:

```
{
  "filter": {
    "operator": "and",
    "operands": [
      "substring"
    ],
    "field": "name",
    "value": "device"
  },
  "sort": [
    {
      "field": "name",
      "direction": "asc"
    }
  ]
}
```

```

    }
  ],
  "page": {
    "offset": 0,
    "total": 100,
    "totalFilter": 100
  }
}

```

Request Parameters

Parameter	Type	Required	Description
sort	Array	No	By default, search results are sorted in descending order of the IDs. To specify an alternate sorting, use the sort query parameter. Enter the field by which you want to sort along with the direction <code>asc</code> (ascending) or <code>desc</code> (descending).
filter	Object	No	Filters the result.
page	Object	No	The page object allows you to get the desired number of pages.

For more information on Filtering, Pagination, and Sorting, see [Filtering, pagination, and sorting](#).

Response

```

{
  {
    "page": {
      "offset": 0,
      "total": 100,
      "totalFilter": 100
    },
    "list": [
      {
        "id": 110,
        "roles": [
          {
            "id": 0,
            "name": "string"
          }
        ],
        "permissions": [
          {
            "id": 59,
            "action": "managecredentials",
            "resourceId": null,
            "resourceType": "credentials"
          }
        ],
        "licenseFeatures": [
          "DEVELOPMENT"
        ],
        "principalId": 110,
        "domain": null,

```

```

    "email": "xyz@automationanywhere.com",
    "emailVerified": true,
    "passwordSet": true,
    "questionsSet": true,
    "enableAutoLogin": true,
    "username": "bot_creator",
    "firstName": "Mike",
    "lastName": "Bots",
    "description": "User to manage bots",
    "disabled": true,
    "clientRegistered": true,
    "createdBy": 27,
    "createdOn": "2022-03-17T19:32:20.620Z",
    "updatedBy": 29,
    "updatedOn": "2022-03-24T02:20:13.787Z"
  }
]
}

```

Response Parameters

Parameter	Type	Description
offset	Integer	The starting list offset, used for pagination.
total	Integer	Total number of records.
totalFilter	Integer	Number of records after applying the filter.
List	Array	The array of List roles object.
List roles object		
id	Integer	The unique Id of a specific role.
name	String	Name of role.
permissions	Array	Collection of unique permissions that have been assigned to the role.
licenseFeatures	String	License features that include - DEVELOPMENT - RUNTIME - IQBOTRUNTIME - ANALYTICSCLIENT - ANALYTICSAPI
description	String	Description of the role.
principalId	Number	Unique ID of the principal user.
email	Integer	Email ID of the user.
emailVerified	Boolean	Indicates if the email ID has been verified.
passwordSet	Boolean	Indicates if the user had set his password.
enableAutoLogin	Boolean	Indicates if auto login is enabled for the user.
username	String	User log in name.
firstName	String	First name specified for the user.
lastName	String	Last name specified for the user.
createdBy	Integer	ID of the user who created the role.
createdOn	String	Timestamp when the role was created.
updatedBy	Integer	ID of the user who last updated the role.

Parameter	Type	Description
updatedOn	String	Timestamp when the role was last updated.
systemRole	Boolean	Indicates if this role is a system role or not.

Note: You can view the in the , but API functionality is limited. You need a licensed Edition to access the full functionality of the APIs.

The REST API responds to each request with an HTTP response code. For response codes, see [API response codes](#).

Retrieve a specific user details API

Use the `Get user details` API to retrieve a specific user details in the Control Room.

Request

```
GET http://{{ControlRoomURL}}/v1/usermanagement/users/{uid}
```

```
Header: X-Authorization: <<authentication token>> or Authorization: Bearer <<bearer token>>
```

All API calls must contain either an authentication token from [Authentication API](#) (generates JSON Web token) or a bearer token from OAuth services. You cannot use both together in an API.

Ensure you have an admin role or a custom role with **View Users** permission.

Request Parameters

Parameter	Type	Required	Description
uid	Integer	Yes	Enter the unique ID of the user.

Response

```
{
  "id": 110,
  "roles": [
    {
      "id": 0,
      "name": "string"
    }
  ],
  "permissions": [
    {
      "id": 59,
      "action": "managecredentials",
      "resourceId": null,
      "resourceType": "credentials"
    }
  ]
}
```

```

],
"licenseFeatures": [
  "DEVELOPMENT"
],
"principalId": 110,
"domain": null,
"email": "xyz@automationanywhere.com",
"emailVerified": true,
"passwordSet": true,
"questionsSet": true,
"enableAutoLogin": true,
"username": "bot_creator",
"firstName": "Mike",
"lastName": "Bots",
"description": "User to manage bots",
"disabled": true,
"clientRegistered": true,
"createdBy": 27,
"createdOn": "2022-03-17T19-32-20",
"updatedBy": 29,
"updatedOn": "2022-03-24T02-20-13"
}

```

Response Parameters

Parameter	Type	Description
id	Integer	Unique identifier representing a specific permission
roles		
id	Integer	Unique identifier representing a specific role
name	String	Name of role.
permissions	Array	Collection of unique permissions that have been assigned to the role.
licenseFeatures	String	License features that include - DEVELOPMENT - RUNTIME - IQBOTRUNTIME - ANALYTICSCLIENT - ANALYTICSAPI
description	String	Description of the role.
domain	String	ActiveDirectory(LDAP) domain
principalId	Number	Unique ID of the principal user.
email	Integer	Email ID of the user.
emailVerified	Boolean	Indicates if the email ID has been verified.
passwordSet	Boolean	Indicates if the user had set his password.
questionsSet	Boolean	Indicates if the user has set questions and answer.
enableAutoLogin	Boolean	Indicates if auto login is enabled for the user.
firstName	String	First name specified for the user.
lastName	String	Last name specified for the user.
disabled	Boolean	User enable/disable flag.
clientRegistered	Boolean	Flag to indicate if client/device is registered.

Parameter	Type	Description
createdBy	Integer	ID of the user who created the role.
createdOn	String	Timestamp when the role was created.
updatedBy	Integer	ID of the user who last updated the role.
updatedOn	String	Timestamp when the role was last updated.

Note: You can view the in the , but API functionality is limited. You need a licensed Edition to access the full functionality of the APIs.

The REST API responds to each request with an HTTP response code. For response codes, see [API response codes](#).

Update an existing user details API

Use the `Update user details` API to update an existing user information in the Control Room.

Ensure you have an admin role or a custom role with **Edit Users** permission.

```
Header: X-Authorization: <<authentication token>> or Authorization: Bearer <<bearer token>>
```

All API calls must contain either an authentication token from [Authentication API](#) (generates JSON Web token) or a bearer token from OAuth services. You cannot use both together in an API.

1. Add the authentication token or bearer token to the request header. You cannot use both in the same API.
2. Use the PUT method and endpoint URL: `<your_control_room_url>/v1/usermanagement/users/744`
3. In the request header, add an existing user ID you want to update. To find a user ID you want to update, execute the `Search for users` API.

If you want to add a new role ID to your request, perform the following steps:

- a) Execute the `Search for users` API. Use the POST method and endpoint URL: `<your_control_room_url>/v1/usermanagement/users/list`
- b) When you get all role IDs, add a new role to the existing role IDs. You will not able to add one role by itself, you must add it to the collection of role IDs.

The following request body is for an existing user ID: 744 and the existing role IDs: 169, 2, and 26. Modify other parameters as needed.

Request body

```
{
  "roles": [
    {
      "id": 169
    },
    {
      "id": 2
    },
    {
      "id": 26
    }
  ]
}
```

```

    ],
    "email": "Joe.Smith@automationanywhere.com",
    "enableAutoLogin": false,
    "firstName": "FN",
    "lastName": "LN",
    "description": "test",
    "disabled": false,
    "licenseFeatures": [
      "RUNTIME"
    ]
  }
}

```

4. Send the request.

The response body returns the updated details for the user ID: 744.

Response body:

```

{
  "id": 744,
  "username": "cs_runner",
  "domain": null,
  "firstName": "FN",
  "lastName": "LN",
  "version": 60,
  "principalId": 744,
  "deleted": false,
  "roles": [
    {
      "name": "AAE_Basic",
      "id": 2,
      "version": 0
    },
    {
      "name": "cs_role2",
      "id": 169,
      "version": 3
    },
    {
      "name": "all",
      "id": 26,
      "version": 54
    }
  ],
  "sysAssignedRoles": [],
  "groupNames": [],
  "permissions": [
    {
      "id": 2912,
      "action": "upload",
      "resourceId": "34241",
      "resourceType": "repositorymanager"
    },
    .....
    {
      "id": 4101,
      "action": "download",
      "resourceId": "34439",
      "resourceType": "repositorymanager"
    }
  ],
  "licenseFeatures": [
    "RUNTIME"
  ],
}

```

```

"emailVerified": true,
"passwordSet": true,
"questionsSet": true,
"enableAutoLogin": false,
"disabled": false,
"clientRegistered": false,
"description": "test",
"createdBy": 451,
"createdOn": "2020-08-25T07:27:58Z",
"updatedBy": 451,
"updatedOn": "2021-03-16T17:15:19Z",
"publicKey": null,
"appType": null,
"routingName": null,
"appUrl": null,
"email": "Joe.Smith@automationanywhere.com",
"lastLoginTime": "2021-02-25T18:01:40Z",
"deviceCredentialAttested": false
}

```

The REST API responds to each request with an HTTP response code. For details about the response codes, see [API response codes](#).

Delete an existing user API

Use the `Delete user` API to delete an existing user in the Control Room.

Request

```
DELETE https://{{ControlRoomURL}}/v1/usermanagement/users/<user ID>
```

```
Header: X-Authorization: <<authentication token>> or Authorization: Bearer <<bearer token>>
```

All API calls must contain either an authentication token from [Authentication API](#) (generates JSON Web token) or a bearer token from OAuth services. You cannot use both together in an API.

Request Parameters

Parameter	Type	Required	Description
user ID	Integer	Yes	Enter the Id of the user.

Response

```
200 OK
```

Note: You can view the in the , but API functionality is limited. You need a licensed Edition to access the full functionality of the APIs.

The REST API responds to each request with an HTTP response code. For response codes, see [API response codes](#).

Ensure you have an admin role or a custom role with **Edit Users** permission.

- URL: `http://<your_control_room_url>/v1/usermanagement/users/2 <user ID>`

Replace the content in the angle brackets with your Control Room URL.

- Method: **DELETE**

1. Add the authentication token or bearer token to the request header. You cannot use both in the same API.
2. In the request header, add an existing user ID you want to delete.
3. Use the **DELETE** method. and endpoint URL: `<your_control_room_url>/v1/usermanagement/users/2 <user ID>`
4. Send the request.

Response body:

```
{
  "id": 3014,
  "email": "a@a.com",
  "username": "docstest01",
  "domain": null,
  "firstName": null,
  "lastName": null,
  "version": 4,
  "principalId": 3014,
  "deleted": false,
  "roles": [],
  "sysAssignedRoles": [],
  "groupNames": [],
  "permissions": [],
  "licenseFeatures": [],
  "emailVerified": true,
  "passwordSet": false,
  "questionsSet": false,
  "enableAutoLogin": false,
  "disabled": false,
  "clientRegistered": false,
  "description": null,
  "createdBy": 2623,
  "createdOn": "2020-01-31T17:33:16Z",
  "updatedBy": 3215,
  "updatedOn": "2020-03-22T22:51:48Z",
  "publicKey": null,
  "appType": null,
  "routingName": null,
  "appUrl": null
}
```

The REST API responds to each request with an HTTP response code. For details about the response codes, see [API response codes](#).

Roles and permissions

Assign roles from the Automation 360 Administration user interface or through the User Management API to enable users to access features. You can assign a system-created role or create a custom role with specific permissions.

Roles are a logical container for permissions and have interdependencies with bots, users, and licenses. Users with the `AAE_Admin` role can create custom roles and assign roles to users.

The following topics provide descriptions of the features and the necessary information to create and assign roles with the [User Management API](#).

Related concepts

[Control Room APIs](#)

The Automation Anywhere Control Room provides APIs that allow you to customize the way that you (and your bots) interact with Automation Anywhere. Control Room APIs allows you to perform tasks such as manage bot deployments, create and manage credentials in the Credential Vault, create and manage user accounts and roles, and create and manage queues.

[Code analysis](#)

Code analysis enables you to evaluate a program without running the code. In Automation 360, the code analysis feature analyzes the code and displays a list of violations based on a set rules. You can review and fix any coding or stylistic errors for your automation.

Related reference

[Create role](#)

Use `Create role` API to create a new role with permissions in the Control Room.

[Feature permissions for a role](#)

A user with the **AAE_Admin** role or a custom role with the **Manage roles** permission can create and assign roles to users to provide them with access to features and operations.

System-created roles

Automation 360 includes predefined roles that cannot be edited or deleted. Each role has the standard permissions, plus the permissions necessary to perform the tasks within the scope of that role.

Standard permissions

All system-created roles include the following permissions:

- View dashboards
- View my in progress activity
- Manage my credentials and lockers
- Create standard attributes for a credential (except for Discovery Bot roles)
- View and manage my Bot runners, Bot creators, and devices
- View and manage my queues
- View users and roles basic information

System-created roles

Find the role IDs using the [List roles](#) and assign the role to a user in the [Create user](#) or [Update an existing user details API](#) endpoints.

Note: Since the role IDs vary for each cloud Control Room, you must look up the role ID by navigating to **Administration > Roles** and clicking the role name. The URL is `https://<control_room>/#/admin/roles/allroles/2/edit`, where 2 is the role name.

Name	Description
AAE_Admin	Allows access to all features, including creating other Admin users and access to all folders and files. The only role that can access Control Room settings.
AAE_Basic	Permissions to create credentials and set a standard attribute value, view and run their bots, view the Bot Store, register a device, and view packages.
AAE_Locker Admin	Can view all credentials and all lockers. They can change the owner of a credential that they do not own. For lockers they do not own, they can delete the locker, edit permissions, and remove credentials.
AAE_IQ Bot Validator	For a Bot Runner with an IQ Bot license. Permissions to access the IQ Bot Validator screen. Limited access to Control Room features.
AAE_Bot Insight Consumer	When combined with an Analytics license, this role grants the user the ability to view data in Bot Insight.
AAE_Bot Insight Expert	When combined with an Analytics license, this role grants the user the ability to view and manage data in Bot Insight.
AAE_IQ Bot Services	Permissions to access the IQ Bot console. Limited access to Control Room features.
AAE_Queue Admin	Permissions to view and manage all queues.
AAE_Pool Admin	Permissions to view and manage all device pools. Note: This role does not grant permission to view bots.
AAE_Bot Insight Admin	The only role that can use Bot Insight APIs to access the data logged by the Control Room, and by a task during Production runs.
AAE_IQ Bot Admin	Allows access to all IQ Bot features.
AAE_Bot Store Publisher	Permissions to submit bot package or Digital Worker to Bot Store.
AAE_Bot Developer	Permissions view, run, and import their bots, create folders, manage packages, and download bots and Digital Workers from the Bot Store to their private workspace. Note: This role does not grant permission to register a device, or check bots in or out of the public workspace.
AAE_Discovery Bot Admin	Allows access to view all Discovery Bot processes. Manages the creation, deletion, and editing of processes.

Name	Description
AAE_Discovery Bot User	Allows access to view the assigned Discovery Bot process assigned to a user. Create and run the Discovery Bot recorder for assigned business processes. Permissions to view, edit, and delete a user's own recordings.
AAE_Discovery Bot Analyst	Allows access to view and edit all approved recordings from assigned users for a given process. Permissions for system generated aggregated view of recordings to view, create, edit, and delete views. Permissions to create, view, edit, and delete opportunities for assigned processes. Export the opportunity to a word document and convert to a bot.
AAE_Robotic Interface Admin	Allows access to the Control Room and AARI on the web.
AAE_Robotic Interface Manager	Allows access to AARI on the web.
AAE_Robotic Interface User	Allows access to AARI on the web.

Related concepts

[Control Room APIs](#)

The Automation Anywhere Control Room provides APIs that allow you to customize the way that you (and your bots) interact with Automation Anywhere. Control Room APIs allows you to perform tasks such as manage bot deployments, create and manage credentials in the Credential Vault, create and manage user accounts and roles, and create and manage queues.

Related reference

[Create role](#)

Use `Create role` API to create a new role with permissions in the Control Room.

Administration permissions

Enable users to create and manage users and roles, to manage and update migrations, and to install Control Room licenses.

You will be able to use the [Retrieve role](#) endpoint with the role ID to retrieve the permissions assigned to any system or user defined roles.

Users and roles permissions

Action	Resource Type	Description
usermanagement	usermanagement	Allows you to only view all other users in the system. You cannot create, edit, or delete users. Note: You must assign this permission before assigning the <code>createuser</code> <code>updateuser</code> , or <code>deleteuser</code> permission.
deleteuser	usermanagement	Allows you to delete other users the Control Room.

Action	Resource Type	Description
createuser	usermanagement	Allows you to create new users in the Control Room.
updateuser	usermanagement	Allows you to edit all users in the system.
rolesview	rolesmanagement	Users with this permission are able to view the roles in the Control Room. Note: You must assign this permission before assigning the <code>rolesmanagement</code> permission.
rolesmanagement	rolesmanagement	Allows you to view and manage all roles in the Control Room.
viewuserrolebasicinfo	usermanagement	Allows you to view basic information on users and roles.

Migration permissions

Action	Resource Type	Description
view	migration	Allows you to view new migrations, but not run them Note: You must assign this permission before assigning the <code>manage</code> migration permission
manage	migration	Allows you to view and run new migrations
updatestatus	migration	Allows Bot Runner Run-as user to update the bot conversion status in the Control Room

Licenses permissions

Action	Resource Type	Description
licensemanagement	licensemanagement	Allows you to view the license details for the Control Room.
licenseinstall	licensemanagement	Allows you to install Automation 360 licenses for the Control Room.
licenseuserallocation	licensemanagement	Allows you to assign device licenses to other users.

Note: Only a user with the `AAE_Admin` role has the ability to view and manage settings in the Control Room. See [System-created roles](#).

Runtime Client Management permissions

Action	Resource Type	Description
runtimeclientsmanagement	runtimeclientsmanagement	Allows you to use the device mentioned in the resourceId for deployment. This permission is assigned when you are assigned a default device.
accessresourceany	runtimeclientsmanagement	Allows you to use any device for deployment. This permission is currently granted for all users with <u>AAE_ADMIN</u> role. ¹

Global Values Permissions

Action	Resource Type	Description
manageuserscopevalues	globalvalues	Manage tenant level global values, given to AAE_Admin only. This cannot be given to any custom role at the moment. ¹
managetenantscopevalues	globalvalues	Not used, created for future purpose. ¹

other permissions

Action	Resource Type	Description
systemadmin	system	This permission is given to AAE_Admin only. It is a system call and cannot be called manually. This permission is used to count the number of pages consumed against the entitled pages for the IQ bot application. It fetches a list of all the users with basic details and license information. ¹
view	settings	View settings. Note: You will be allowed to view settings only with the system-created Admin role to view Settings.
all	botrunners	Allows you to use any runAsUser for deployment. This permission is currently granted for all users with <u>AAE_ADMIN</u> role. ¹
operationroom	operationroom	Legacy, not used and will be removed from the future releases. ¹

¹ Not available in the UI and is seen only in the API response.

Action	Resource Type	Description
manage	mfa	Legacy, not used and will be removed from the future releases. ¹

Related reference

[Roles and permissions](#)

Assign roles from the Automation 360 Administration user interface or through the User Management API to enable users to access features. You can assign a system-created role or create a custom role with specific permissions.

[Create role](#)

Use `Create role` API to create a new role with permissions in the Control Room.

API permissions

Enables access to Bot Insight APIs and the ability to generate an API key.

Action	Resource Type	Description
botinsightapi	api	Allows access to Bot Insight RESTful APIs to the data logged by the Control Room and by a task during production runs.
generateapikey	api	<p>Generate an apiKey that can be used in the Authentication API.</p> <p><i>Authenticate (username and apiKey)</i></p> <hr/> <p>Note: Without the <code>generateapikey</code> permission, use APIs by authenticating using their username and password.</p> <p><i>Authenticate (username and password)</i></p> <hr/>
coadmin	botinsightapi	Reserved. Not used for now and will be used when COE dashboard is available in A360. Allows you to access the COE dashboard when it is made available in A360.
accessreportingapi	iqbotapi	Allows you to access reporting details via an API.
accessuploadanddownloadapi	iqbotapi	Allows you to upload a document and download the digitized result via an API.
accessnlpapi	iqbotapi	Allows you to access natural language processing capabilities of the IQ Bot portal via an API.

Related reference

[Roles and permissions](#)

Assign roles from the Automation 360 Administration user interface or through the User Management API to enable users to access features. You can assign a system-created role or create a custom role with specific permissions.

[Create role](#)

Use `Create role` API to create a new role with permissions in the Control Room.

Audit log permissions

View logs and details to record user activities. Enable users to view logs from the Control Room.

Action	Resource Type	Description
recentactivities	recentactivities	Allows you to view all audit log activity for the Control Room
archiveaudit	recentactivities	Allows you to archive all audit log activity for the Control Room

Related reference

[Roles and permissions](#)

Assign roles from the Automation 360 Administration user interface or through the User Management API to enable users to access features. You can assign a system-created role or create a custom role with specific permissions.

[Create role](#)

Use `Create role` API to create a new role with permissions in the Control Room.

Automation Anywhere Robotic Interface (AARI) permissions

Assign AARI permissions to a custom role.

Action	Resource Type	Description
aaricrossteamreadari		View all teams and see the team members
aaricrossprocessreadari		View all processes and see team members and managers
aariteammanagement		Create and view teams, edit team names, descriptions, and process tags. Add new teams, team members, and assigned processes
aaritaskmanagement		Submit and view tasks from processes that are assigned to the team
aaricasemanagement		Create and view requests from processes that are assigned to the team
aariglobalcasemanagement		View process requests and tasks. Note: This permission does not grant the ability to create a request or submit a task
aariglobalprocessmanagement		View checked-in public processes and assigned managers and teams, edit process tags, and assign managers and teams Note: This permission does not grant the ability to create a process.

Action	Resource Type	Description
aariglobalteammangement	aari	View teams and assigned users, edit team names and descriptions. Add new processes, managers and users to a team Note: This permission does not grant the ability to create a team.
aarischeduler	aari	Allows users to be used as AARI scheduler

Bot and bot credential permissions

Enables users to access features for managing bots and the credentials used by bots.

Bots permissions

Action	Resource Type	Description
view	repositorymanager	Allows you to view the bots they created and bots that were assigned to them. Note: You must assign this permission before assigning any other bots permissions.
run	repositorymanager	Allows you to run the bots they created and bots that were assigned to them.
export	repositorymanager	Allows you to export bots and related bot dependencies for which they have download permission.
import	repositorymanager	Allows you to import bots and bot dependencies for which they have upload permission.
createfolders	repositorymanager	Allows users to create folders within the folders that they have access to.
renamefolders	repositorymanager	Allows you to rename the folders they have access to. Note: Only empty folders can be renamed.
cancelcheckout	repositorymanager	Allows you to cancel bot checkout and unlock the file from the public repository.
forceunlock	repositorymanager	Allows you to unlock locked bots.
accessresourceany	repositorymanager	Allows you to get permissions to the resources. For example, <i>runtimeclientsmanagement, pool, queue</i> and so on.
setproductionversion	repositorymanager	Allows you to set the production version of bots.
all	repositorymanager	Allows you to get all the repository permissions.
gitrestore	repositorymanager	Allows you to get git restore permissions.

Credentials and lockers permissions

Action	Resource Type	Description
managecredentials	credentials	Allows you to create, edit, and delete their own credentials. In addition, the user can interact with credentials from their assigned lockers. Note: All roles have this permission by default.
create	locker	Allows you to create and manage their own lockers.
consume	locker	Allows you to consume a locker locker
createstandard	credentialattribute	Allows you to create a standard attribute for a credential that is shared across all users of that credential .
updateany	credentialattributevalue	Allows you to view and edit their own masked attributes.
botautologinapi	credentialattributevalue	Allows you to automate the login process to run bots remotely.
addcredential	credentialmanager	Legacy, not used and will be removed from the future releases.
updatecredential	credentialmanager	
deletecredential	credentialmanager	

Note: A user with the `AAE_Locker Admin` role can view all credentials and lockers in the Control Room. See [System-created roles](#).

Related reference

[Roles and permissions](#)

Assign roles from the Automation 360 Administration user interface or through the User Management API to enable users to access features. You can assign a system-created role or create a custom role with specific permissions.

[Create role](#)

Use `Create role` API to create a new role with permissions in the Control Room.

Bot Store permissions

Enables users to view and manage Bot Store packages.

Action	Resource Type	Description
view	botstore	Allows you to view Bot Store.
addfrom	botstore	Allows you to add bot packages from Bot Store to their Control Room private workspace.
submit	botstore	Allows you to submit bot packages to Bot Store.

Related reference

[Roles and permissions](#)

Assign roles from the Automation 360 Administration user interface or through the User Management API to enable users to access features. You can assign a system-created role or create a custom role with specific permissions.

[Create role](#)

Use `Create role` API to create a new role with permissions in the Control Room.

Dashboard and activity permissions

Enables all users to view dashboards. Activity permissions enable users to view, manage, and schedule bot activities.

Dashboard and Activity Permissions

Action	Resource Type	Description
view	dashboard	View dashboard. Note: All roles have this permission by default.
myschedule	taskscheduling	All users can view their own activity. Note: All roles have this permission by default.
managemyschedule	taskscheduling	All users can pause, resume, or cancel their own activity and move their finished activities to history.
manageeveryone	taskscheduling	A user can monitor ongoing automations where a user has either run or schedule access on the respective bot. The user can monitor and manage ongoing automations.
view	taskscheduling	Users can see their scheduled bots regardless of which user scheduled the bot.
addschedule	taskscheduling	It requires permission to view and manage Bot Runners.
updateschedule	taskscheduling	Users can edit their scheduled bots, even if the bots are scheduled by a different user.
deleteschedule	taskscheduling	Users can delete schedules for any of their bots regardless of which users scheduled the bot.
manageallmyfolders	taskscheduling	Users can view, edit, and delete all the schedules on the bot folders that the user has access to. This includes the schedules that the user created or schedules created by other users.
manageallschedules	taskscheduling	Users can view, edit, and delete all the schedules in the system. This includes the schedules that the user created or schedules created by other users.
setautomationpriority	taskscheduling	Users can set the automation priority to high from the default medium. Automations with high priority are deployed ahead of automations with medium and low priority.
everyone	taskscheduling	Users can monitor those ongoing automations where they have either run or schedule access on the respective TaskBot.

Related reference[Roles and permissions](#)

Assign roles from the Automation 360 Administration user interface or through the User Management API to enable users to access features. You can assign a system-created role or create a custom role with specific permissions.

[Create role](#)

Use `Create role` API to create a new role with permissions in the Control Room.

Devices permissions

Enable you to register, view, and manage devices used to run bots.

Action	Resource Type	Description
register	devices	Allows you to register a localhost device.
all	devices	Allows you to view and manage all devices in the Control Room.
delete	devices	Allows you to delete devices that they registered.
edit	devices	<p>Allows you to edit the devices that they have permission to see.</p> <p>Allows you to view and manage all (registered and non-registered) devices from a specific accessible group.</p> <hr/> <p>Note: To view and manage registered and non-registered devices,</p> <ul style="list-style-type: none"> The Control Room administrator must grant access to manage a specific set of devices. You must select Devices from my device pool(s) to edit devices from device pools and Run as user(s) default device to edit Run as user(s) default device options in the Edit devices permission. <hr/>
view	devices	<p>Allows you to view and manage Bot Creators, Bot Runners, and device pools.</p> <hr/> <p>Note: All roles have this permission by default.</p> <hr/>
attestcredentials	devices	Allows you to deploy the bot during a session on the user's device without system password.
create	pool	Allows you to create and manage their own device pools.

Note: A user with the `AAE_Pool Admin` role is able to manage all device pools in the Control Room. See [System-created roles](#).

Related reference[Roles and permissions](#)

Assign roles from the Automation 360 Administration user interface or through the User Management API to enable users to access features. You can assign a system-created role or create a custom role with specific permissions.

[Create role](#)

Use `Create role` API to create a new role with permissions in the Control Room.

Discovery Bot permissions

Enable users to view or manage Discovery Bot processes, recordings, aggregations, and opportunities.

Process permissions

Action	Resource Type	Description
viewprocess	processdiscovery	Allows users to view assigned processes. Note: This is the standard permission. You must assign this permission before assigning any process discovery permissions.
viewallprocess	processdiscovery	Allows users to view all the defined processes.
editprocess	processdiscovery	Allows users to create and edit processes.

Recording permissions

Action	Resource Type	Description
viewrecording	processdiscovery	Allows users to view their own recording. Note: You must assign this permission before assigning any of the permissions below.
createrecording	processdiscovery	Allows users to run recorder and create recording.
editrecording	processdiscovery	Allows users to edit their own recording.
deleterecording	processdiscovery	Allows users to delete their own recording.
viewallrecording	processdiscovery	Allows users to view all recordings.
editallrecording	processdiscovery	Allows users to edit all recordings.

Aggregation permissions

Action	Resource Type	Description
viewmanualaggregation	processdiscovery	Allows users to view their own aggregations.
viewallaggregations	processdiscovery	Allows users to view all aggregations.
createdeletemanualaggregation	processdiscovery	Allows users to create and delete aggregations.
updatemanualaggregation	processdiscovery	Allows users to update aggregations.
viewsystemaggregation	processdiscovery	Allows users to view system aggregations.

Opportunity permissions

Action	Resource Type	Description
viewopportunity	processdiscovery	Allows users to view opportunities within an assigned process. Note: You must assign this permission before assigning any of the opportunity permissions.
editopportunity	processdiscovery	Allows users to edit opportunities within an assigned process.
viewalloppportunity	processdiscovery	Allows users to view all the opportunities.
createdeleteopportunity	processdiscovery	Allows users to create and delete opportunities within the assigned process.
converttobot	processdiscovery	Allows users to convert an opportunity to a bot.
exportopportunity	processdiscovery	Allows users to export an opportunity.

Related reference

[Roles and permissions](#)

Assign roles from the Automation 360 Administration user interface or through the User Management API to enable users to access features. You can assign a system-created role or create a custom role with specific permissions.

[Create role](#)

Use `Create role` API to create a new role with permissions in the Control Room.

Event triggers permissions

Enable users to run bots automatically depending on a specific event, such as a new window opening. You can limit users ability to only view or to view and manage triggers.

Action	Resource type	Description
view	eventtriggers	Allows users to view event triggers.
manage	eventtriggers	Allows users to view and manage event triggers.
managemytriggers	eventtriggers	Allows users to view and manage event triggers from their private repository, on their local devices.

Additionally, you must enable the view packages permission as well:

Action	Resource type	Description
view	packagemanager	Allows users to view packages

Related reference

[Roles and permissions](#)

Assign roles from the Automation 360 Administration user interface or through the User Management API to enable users to access features. You can assign a system-created role or create a custom role with specific permissions.

Create role

Use `Create role` API to create a new role with permissions in the Control Room.

Package manager permissions

Enable users to view and manage packages.

IQ Bot permissions

Enable users to view IQ Bot permissions, create and manage learning instances, import and export domains, and manage IQ Bot configuration settings and migration.

IQ Bot permissions

Action	Resource Type	Description
viewiqbot	iqbot	Allows you to view the default dashboards in the IQ Bot portal. Note: You must assign this permission before assigning any of the permissions below.
view	iqbotpages	Allows to view the iqbot pages licensed
utilize	iqbotpages	Allows to utilize the iqbot pages licensed

Learning instance permissions

Action	Resource Type	Description
viewlearninginstance	viewiqbot	Allows you to view their learning instances in the IQ Bot portal. Note: You must assign this permission before assigning any other learning instance permission.
viewlearninginstancefromdomain	viewlearninginstance	Allows you to view learning instances created by other you with the same role in the IQ Bot portal.
assignroletolearninginstance	viewlearninginstance	Allows you to assign some custom roles to a learning instance.
viewalllearninginstances	viewlearninginstance	Allows you to view all learning instances in the IQ Bot portal.
launchvalidator	viewlearninginstance	Allows you to access the IQ Bot Validator to review and update documents with exceptions.
createlearninginstances	viewlearninginstance	Allows you to create learning instances in the IQ Bot portal.
editlearninginstances	viewlearninginstance	Allows you to edit learning instances in the IQ Bot portal.

Action	Resource Type	Description
deletelearninginstances	viewlearninginstance	Allows you to delete their learning instances in the IQ Bot portal.
sendlearninginstances	viewlearninginstance	Allows you to send their learning instances to production in the IQ Bot portal.
trainlearninginstancegroups	viewlearninginstance	Allows you to train their learning instance groups in the IQ Bot portal.

Domains permissions

Action	Resource Type	Description
viewdomain	viewiqbot	Allows you to view all domains in the IQ Bot portal. Note: You must assign this permission before assigning any other domain permissions.
createdomains	viewdomain	Allows you to create domains in the IQ Bot portal.
editdomains	viewdomain	Allows you to edit domains in the IQ Bot portal.
importdomains	viewdomain	Allows you to import domains in the IQ Bot portal.
exportdomains	viewdomain	Allows you to export domains in the IQ Bot portal.
deletedomains	viewdomain	Allows you to delete domains in the IQ Bot portal.

Administration permissions

Action	Resource Type	Description
viewadministration	viewiqbot	Allows you to access the Administration tab in the IQ Bot portal. Note: You must assign this permission before assigning any other administration permissions.
viewandmanagesettings	viewadministration	Allows you to manage the IQ Bot portal advanced configuration settings.
viewandmanagemigration	viewadministration	Allows you to access the migration utility to import and export learning instances in the IQ Bot portal.

Related reference

[Roles and permissions](#)

Assign roles from the Automation 360 Administration user interface or through the User Management API to enable users to access features. You can assign a system-created role or create a custom role with specific permissions.

[Create role](#)

Use `Create role` API to create a new role with permissions in the Control Room.

MetaBot permission

MetaBots are obsolete in Automation 360. However, this permission is valid to ensure that all functionality previously available is supported in Automation 360.

Access to MetaBot Designer

Permission/feature ID is not available.

Bot Creator users can access MetaBot Designer to view, create, and update MetaBots.

Note: This feature is available for internal use only.

Related reference

[Roles and permissions](#)

Assign roles from the Automation 360 Administration user interface or through the User Management API to enable users to access features. You can assign a system-created role or create a custom role with specific permissions.

Package manager permissions

Enable users to view and manage packages.

Action	Resource Type	Description
view	packagemanager	Allows you to view packages.
manage	packagemanager	Allows you to view and manage packages.

Related reference

[Roles and permissions](#)

Assign roles from the Automation 360 Administration user interface or through the User Management API to enable users to access features. You can assign a system-created role or create a custom role with specific permissions.

[Create role](#)

Use `Create role` API to create a new role with permissions in the Control Room.

Workload permissions

Enable you to create and manage workitems, workitem models, queues, and automations in the Control Room.

Action	Resource Type	Description
myschedule	taskscheduling	Allows you to view and manage their own schedules.
view	queue	Allows you to view their own queues.
create	queue	Allows you to create and manage their own queues.
calculate	sla	Allows you to calculate workload Service Level Agreements (SLA).
view	workload	Legacy, not used and will be removed from the future releases.

Action	Resource Type	Description
accessresourceany	queue	Legacy, not used and will be removed from the future releases.

Note: A user with the `AAE_Queue Admin` role has all the above permissions. In addition, the `AAE_Queue Admin` is able to manage all the queues in the Control Room. See [System-created roles](#).

Related reference

[Roles and permissions](#)

Assign roles from the Automation 360 Administration user interface or through the User Management API to enable users to access features. You can assign a system-created role or create a custom role with specific permissions.

[Create role](#)

Use `Create role` API to create a new role with permissions in the Control Room.

Audit API

Use the Audit API to request audit data for a given input combination of date filter, sorting mechanism, and pagination.

Note: You can view the in the , but API functionality is limited. You need a licensed Edition to access the full functionality of the APIs.

- All API calls must contain either an authentication token from [Authentication API](#) (generates JSON Web token) or a bearer token from OAuth services. You cannot use both together in an API.
 - Users with the **AAE_Admin** role or users with the **View everyone audit log actions** permission can view audit logs for the Control Room.
- All API calls must contain either an authentication token from [Authentication API](#) (generates JSON Web token) or a bearer token from OAuth services. You cannot use both together in an API.
 - Apply filters to perform basic conditional queries and pagination control for processing web pages. There are three basic features related to filtering: filtering conditions, sorting columns, and pagination parameters.

[Filtering, pagination, and sorting](#)

- Use the POST method and endpoint URL: `<your_control_room_url>/v1/audit/messages/list`.

The following example requests unsuccessful login attempts for the month of December, 2019.

Request body:

```
{
  "sort": [
    {
      "field": "createdOn",
      "direction": "desc"
    }
  ],
  "filter": {
    "operator": "and",
    "operands": [
      {
        "operator": "gt",
```

```

    "field": "createdOn",
    "value": "2019-12-01T00:00:00.001Z"
  },
  {
    "operator": "lt",
    "field": "createdOn",
    "value": "2019-12-31T23:59:59.999Z"
  },
  {
    "operator": "eq",
    "field": "status",
    "value": "Unsuccessful"
  },
  {
    "operator": "substring",
    "field": "activityType",
    "value": "LOGIN"
  },
  {
    "operator": "substring",
    "field": "userName",
    "value": "joe.typical@myemiil.com"
  }
]
},
"page": {
  "length": "1000",
  "offset": "0"
}
}

```

4. Send the request.

The response for this example returns data for the date filter, sorting, and pagination. If no filtering is used in the request, a successful response returns all pages for the specified Control Room.

Response body:

```

{
  "page": {
    "offset": 0,
    "total": 731064850,
    "totalFilter": 9
  },
  "list": [
    {
      "id": "XlHj6G4BFXSp00ji5B7S",
      "eventDescription": "User does not exist in Control Room.",
      "activityType": "LOGIN",
      "environmentName": "",
      "hostName": "12.xxx.xx.x",
      "userName": "joe.typical@myemiil.com",
      "status": "Unsuccessful",
      "source": "Control Room",
      "objectName": "N/A",
      "detail": "",
      "createdOn": "2019-12-09T04:21:19Z",
      "requestId": "04965c2e-82e0-4ce4-a88d-bebe1dc3a2a8",
      "createdBy": "0"
    },
    {
      "id": "g1Hj6G4BFXSp00ji2Rwx",
      "eventDescription": "User does not exist in Control Room.",
      "activityType": "LOGIN",

```

```

    "environmentName": "",
    "hostName": "12.xxx.xx.x",
    "userName": "joe.typical@myemiil.com",
    "status": "Unsuccessful",
    "source": "Control Room",
    "objectName": "N/A",
    "detail": "",
    "createdOn": "2019-12-09T04:21:16Z",
    "requestId": "61672553-477d-4012-ab47-2a27f6553c4e",
    "createdBy": "0"
  },
  .....
  {
    "id": "ETyk6G4BFXSp0OjiaJjt",
    "eventDescription": "User does not exist in Control Room.",
    "activityType": "LOGIN",
    "environmentName": "",
    "hostName": "12.xxx.xx.x",
    "userName": "joe.typical@myemiil.com",
    "status": "Unsuccessful",
    "source": "Control Room",
    "objectName": "N/A",
    "detail": "",
    "createdOn": "2019-12-09T03:11:58Z",
    "requestId": "ebeb01de-1f81-4a7c-8978-405806e146bd",
    "createdBy": "0"
  }
]
}

```

The REST API responds to each request with an HTTP response code. For response codes, see [API response codes](#).

Related concepts

[Example of createdOndate and userName filters in Audit API](#)

Create a filter that retrieves audit log entries for a specified date range for a user with a specific value in the **userName** field.

Example of createdOndate and userName filters in Audit API

Create a filter that retrieves audit log entries for a specified date range for a user with a specific value in the **userName** field.

Use filtering to help narrow your results. The following example identifies unsuccessful login attempts for users with the value "john,doe" in the **userName** field from December 1, 2020 through December 31, 2020.

Request body:

```

{
  "sort": [
    {
      "field": "createdOn",
      "direction": "desc"
    }
  ],
  "filter": {
    "operator": "and",
    "operands": [

```

```

    {
      "operator": "gt",
      "field": "createdOn",
      "value": "2020-12-01T00:00:00.001Z"
    },
    {
      "operator": "lt",
      "field": "createdOn",
      "value": "2020-12-31T23:59:59.999Z"
    },
    {
      "operator": "eq",
      "field": "status",
      "value": "Unsuccessful"
    },
    {
      "operator": "substring",
      "field": "activityType",
      "value": "LOGIN"
    },
    {
      "operator": "substring",
      "field": "userName",
      "value": "john,doe"
    }
  ]
},
"page": {
  "length": "1000",
  "offset": "0"
}
}

```

This request identified three audit log entries out of 731,148.339 entries from this Control Room log entries.

Response body:

```

{
  "page": {
    "offset": 0,
    "total": 731148339,
    "totalFilter": 3
  },
  "list": [
    {
      "id": "kLjB8G4BFXSp00jiomK1",
      "eventDescription": "User does not exist in Control Room.",
      "activityType": "LOGIN",
      "environmentName": "",
      "hostName": "50.xxx.xxx.xx",
      "userName": "john,doe@mycompany.com",
      "status": "Unsuccessful",
      "source": "Control Room",
      "objectName": "N/A",
      "detail": "",
      "createdOn": "2020-12-10T17:00:52Z",
      "requestId": "3c0f8e47-5820-43e8-b2b3-83b2f1cb86c9",
      "createdBy": "0"
    },
    {
      "id": "SLjB8G4BFXSp00jikl5i",
      "eventDescription": "User does not exist in Control Room.",

```

```

    "activityType": "LOGIN",
    "environmentName": "",
    "hostName": "50.xxx.xxx.xx",
    "userName": "john.doe@mycompany.com",
    "status": "Unsuccessful",
    "source": "Control Room",
    "objectName": "N/A",
    "detail": "",
    "createdOn": "2020-12-10T17:00:48Z",
    "requestId": "eba3e5a7-0034-440a-a786-110a84fea7c9",
    "createdBy": "0"
  },
  {
    "id": "7bjB8G4BFXSp00jicEGO",
    "eventDescription": "User does not exist in Control Room.",
    "activityType": "LOGIN",
    "environmentName": "",
    "hostName": "50.xxx.xxx.xx",
    "userName": "john.doe",
    "status": "Unsuccessful",
    "source": "Control Room",
    "objectName": "N/A",
    "detail": "",
    "createdOn": "2020-12-10T17:00:39Z",
    "requestId": "64184450-aad5-4024-bcf5-491fb5276d0c",
    "createdBy": "0"
  }
]
}

```

The REST API responds to each request with an HTTP response code. For response codes, see [API response codes](#).

Related concepts

[Filtering, pagination, and sorting](#)

The Control Room API supports filtering, pagination, and sorting for endpoints that return arrays of resources.

Related tasks

[Audit API](#)

Use the Audit API to request audit data for a given input combination of date filter, sorting mechanism, and pagination.

Device API

Identify all available users with unattended Bot Runner licenses, or filter for users by name.

Note: You can view the in the , but API functionality is limited. You need a licensed Edition to access the full functionality of the APIs.

[Return available Bot Runners](#)

Return a list of available users with unattended Bot Runner licenses. This endpoint returns the user id, which is a numeric value that is used by APIs to identify users.

```
POST <control_room_URL>/v1/devices/runasusers/list
```

List available unattended Bot Runners API

Return a list of available users with unattended Bot Runner licenses. This endpoint returns the user id, which is a numeric value that is used by APIs to identify users.

Note: You can view the in the , but API functionality is limited. You need a licensed Edition to access the full functionality of the APIs.

- All API calls must contain either an authentication token from [Authentication API](#) (generates JSON Web token) or a bearer token from OAuth services. You cannot use both together in an API.
- You must be assigned a custom role that is associated with a Run As user device.

1. Add the authentication token or bearer token to the request header. You cannot use both in the same API.
2. Use the POST method and endpoint URL: <your_control_room_url>/v1/devices/runasusers/list.

Request body:

```
{
  "sort": [
    {
      "field": "username",
      "direction": "asc"
    }
  ],
  "filter": {},
  "page": {}
}
```

Filtering, pagination, and sorting

3. Send the request.

Response body: In a successful request, this endpoint returns the following data:

- **id:** a unique numeric identifier for a user with the Bot Runner license.
- **device:** if the user is configured with a default device, the device name is returned. For example, DESKTOP-DBO6SIE. Otherwise, this parameter returns the message Picked at run time, indicating that a device must be selected from a device pool in order to run a bot.

```
{
  "page": {
    "offset": 0,
    "total": 6,
    "totalFilter": 6
  },
  "list": [
    {
      "id": "9",
      "username": "ubr01_rt",
      "device": "DESKTOP-DBO6SIE",
      "deviceId": "3"
    },
    {
      "id": "10",
      "username": "ubr02_rt",
      "device": "DESKTOP-DBO6SIE",
      "deviceId": "3"
    }
  ]
}
```

```

    },
    {
      "id": "11",
      "username": "ubr03_rt",
      "device": "DESKTOP-DBO6SIE",
      "deviceId": "3"
    },
    {
      "id": "12",
      "username": "ubr04_rt",
      "device": "Picked at run time",
      "deviceId": "-1"
    },
    {
      "id": "13",
      "username": "ubr05_rt",
      "device": "Picked at run time",
      "deviceId": "-1"
    },
    {
      "id": "14",
      "username": "ubr06_rt",
      "device": "Picked at run time",
      "deviceId": "-1"
    }
  ]
}

```

If you are performing the steps to deploy a bot or to create an automation schedule, and the user associated with the Bot Runner license does not have a default device assigned or if you want to select a different device, perform this task: [List device pools API](#).

To deploy a bot that runs on the default device assigned to the Bot Runner user, perform this task: [Bot deployment - V3](#).

To create an automation schedule with a bot that runs on the default device assigned to the Bot Runner user, perform this task: [Schedule bot to run API](#).

Related reference

[Bot deployment - V3](#)

As a user with a Bot Runner license, deploy bots on your assigned devices. You can also pass variables to bots when they are deployed.

Assign default device API

Use the default device allocation API to set a specific device as the default deployment device for the specific user.

Note: You can view the in the , but API functionality is limited. You need a licensed Edition to access the full functionality of the APIs.

- All API calls must contain either an authentication token from [Authentication API](#) (generates JSON Web token) or a bearer token from OAuth services. You cannot use both together in an API.
- You must have User management rights or admin rights.

1. Add the authentication token or bearer token to the request header. You cannot use both in the same API.

- Use the POST, PUT, GET, DELETE method and endpoint URL: <your_control_room_url>/runasusers/default.

Request body:

Enter the valid deviceId and userId.

```
{
  "deviceId": 1046,
  "userId": 589
}
```

- Send the request.

When the request is successful, a default device is allocated to the specified user. Now this device will be used as default for the deployment.

Response body:

In this example, the deviceId with value 1046 is allocated as default device for the specified user with userId 589.

```
{
  "deviceId": 1046,
  "userId": 589
}
```

The REST API responds to each request with an HTTP response code. For response codes, see [API response codes](#).

Trigger API

Map triggers to users or roles for an attended Bot Runner user by using the Trigger API. With the Trigger API, you can also create and delete event triggers.

Note: You can view the in the , but API functionality is limited. You need a licensed Edition to access the full functionality of the APIs.

Create an event trigger

Create an event trigger for a Bot Runner user, role, or bot file. Ensure that the associated users and roles have a Bot Runner license.

Request

```
POST http://{{ControlRoomURL}}/v1/triggers/triggermapping
```

```
Header: X-Authorization: <<authentication token>> or Authorization: Bearer <<bearer token>>
```

All API calls must contain either an authentication token from [Authentication API](#) (generates JSON Web token) or a bearer token from OAuth services. You cannot use both together in an API.

Request body for users:

```
{
```

```

"botFileId":106587,
"botFileLabel":"string",
"users":{
  "userIds":[
    "985"
  ]
}
}

```

Request body for roles:

```

{
  "botFileId":106587,
  "botFileLabel":"string",
  "roles":{
    "roleIds":[
      721, 645
    ]
  }
}

```

Request Parameters

Parameter	Type	Required	Description
botFileId	Integer	Yes	Unique identifier of the bot file.
botFileLabel	String	No	Bot file label. It can be PRODUCTION or empty for the latest version.
userIds	Array	Yes*	<p>Enter the IDs of the user. Only the users listed here will be associated with the trigger.</p> <hr/> <p>Note: The user associated with these <code>userIds</code> must have a Bot Runner license to run the API.</p>
roleIds	Array		<p>Enter the IDs of the role. Only the roles listed here will be associated with the trigger.</p> <hr/> <p>Note: The users associated with these <code>roleIds</code> must have a Bot Runner license to run the API.</p>
*One of the previously mentioned parameters is required to create an event trigger.			

Response

```

{
  "triggerMappings": [
    {
      "id": "399",
      "userId": "985",
      "botPath": "Automation Anywhere\\Bots\\botA",
      "modifiedBy": "289",
      "lastModified": "2022-04-06T09:09:43.893256Z",
      "botName": "botA",

```

```

    "botId": "106587",
    "botLabel": "string"
  }
]
}

```

Response Parameters

Parameter	Type	Description
triggerMappings	Array	<p>The triggerMappings array returns with all the details of the triggerMapping created. Each array element contains the following values:</p> <ul style="list-style-type: none"> • id: ID of the trigger mapping • userId: ID of the user • roleId: ID of the role • botPath: The path of the bot • modifiedBy: The ID of the user that did the triggerMapping • lastModified: The timestamp of the triggerMapping • botName: The name of the bot that got the triggerMapping. • botId - The Id of the bot that got the triggerMapping • botLabel: The label of the bot that got the triggerMapping • licenseFeatures: License assigned to the user

Delete an event trigger

Delete an event trigger that is associated with a user, role, or bot.

Request

```
DELETE http://{{ControlRoomURL}}/v1/triggers/triggermapping/{id}
```

```
Header: X-Authorization: <<authentication token>> or Authorization: Bearer <<bearer token>>
```

All API calls must contain either an authentication token from [Authentication API](#) (generates JSON Web token) or a bearer token from OAuth services. You cannot use both together in an API.

Request Parameters

Parameter	Type	Description
Id	Integer	Event trigger identifier that you want to delete

Response

```
204 No Content
The relationship was deleted.
```

For more information about return codes, see [API response codes](#).

Credential Vault APIs

As an Control Room user with **Manage my credentials and lockers** feature permissions, you have the option to use the Credential Vault API to manage your attributes, credentials, and lockers in the Control Room.

Note: You can view the in the , but API functionality is limited. You need a licensed Edition to access the full functionality of the APIs.

By default, all users can create credentials. You are the Credential owner of any credentials that you created. As a Credential owner, you can update, delete, and transfer the ownership of your credentials.

Configure the Credential Vault for your organization

As a Locker admin, configure a locker and a credential, then assign the credential to the locker. It is also acceptable to first configure a credential, then a locker.

1. [Authenticate the user.](#)
Use the POST method to generate an authentication JSON Web Token.
2. [Configure a locker using API](#)
3. [Configure a credential with attribute values using API](#)
4. [Assign credential to locker API](#)

Manage your credentials

Authenticate yourself as a basic user to retrieve the list of credentials that you have access to then assign a value to a specific attribute.

1. [Authenticate the user.](#)
Use the POST method to generate an authentication JSON Web Token.
2. [List credentials using API](#)

3. *Update attribute values*

Retrieve masked credentials

You will be able to retrieve your masked credentials, if you have **View and edit ALL credentials attributes value** permissions.

1. *Authenticate the user.*

Use the POST method to generate an authentication JSON Web Token.

2. Get the Masked Attribute Value (For more information, see [Get Masked credentials](#))

- a. Get Credential ID.
- b. Get Credential Attribute ID.
- c. Use the Credential ID and Credential Attributed ID to retrieve the masked attribute value.

Set device login credentials API

Use the login setting endpoint of the Credential Vault API to update the user name and password for a device. You can use this endpoint to set or update the login credentials for your own device without additional permissions.

Request

To set or update the login credentials on other users' devices, for example, to deploy bots on unattended Bot Runners, you must have the AAE_admin role or a custom role with the Bot Auto-Login Credentials API permission. To update the credentials for your own device, you only need the device username and password:

```
PUT http://{{ControlRoomURL}}/v2/credentialvault/loginsetting
```

```
Header: X-Authorization: <<authentication token>> or Authorization: Bearer <<bearer token>>
```

All API calls must contain either an authentication token from [Authentication API](#) (generates JSON Web token) or a bearer token from OAuth services. You cannot use both together in an API.

Request body:

```
{
  "loginUsername": "aai\\jane.doe",
  "loginPassword": "Automation123"
}
```

To update the credentials for another user's device, you must also include either the username or userid of that user, as demonstrated in this code example:

```
{
  "loginUsername": "aai\\jane.doe",
  "loginPassword": "Automation123",
  "username": "john-doe"
}
```

```
}

```

Request Parameters

Parameter	Type	Description
loginUsername	String	Enter the device login user name.
loginPassword	String	Enter the device login password.
username	String	Enter the user name of the user's device you want to update/set.

Response

```
"Credentials updated for jane"

```

Note: For an Control Room that is deployed on Cloud and has SAML authentication enabled, generate the web token with your `username` and `apiKey`.

[Authenticate \(username and apiKey\)](#)

Configure a locker using API

Use a combination of endpoints to create a locker and assign locker access permissions to users.

Note: You can view the in the , but API functionality is limited. You need a licensed Edition to access the full functionality of the APIs.

- All API calls must contain either an authentication token from [Authentication API](#) (generates JSON Web token) or a bearer token from OAuth services. You cannot use both together in an API.
- You must be assigned the **AAE_Admin**, **AAE_Locker Admin** role or have a custom role that includes the `Manage my lockers` permission.

You will provide the role ID to assign consumer access to users [List roles](#).

1. Add the authentication token or bearer token to the request header. You cannot use both in the same API.
2. Use the POST method and endpoint URL: `<your_control_room_url>/v2/credentialvault/lockers` to create the locker.

Request body:

```
{
  "name": "HumanResourcesCredentials",
  "description": "Login credentials for the HR dept"
}
```

3. Send the request.

Response body: In a successful request, this endpoint returns the `id`, which is a unique numeric identifier for the locker. Use the locker ID in subsequent API requests, such as to add consumers or credentials to the locker.

```
{
  "id": "1551",
  "name": "HumanResourcesCredentials",
  "description": "Login credentials for the HR dept",
  "createdBy": "1508",
  "createdOn": "2020-12-28T22:24:40.462253Z",
  "updatedBy": "1508",
  "updatedOn": "2020-12-28T22:24:40.462259Z",
  "version": "0"
}
```

The REST API responds to each request with an HTTP response code. For response codes, see [API response codes](#).

Assign locker access permissions to users. [Locker permissions](#)

4. Optional: Assign another locker owner. Use the PUT method and endpoint

URL:<your_control_room_url>/v2/credentialvault/lockers/{lockerId}/members/{userId}.

Note: The locker creator is automatically assigned the locker owner permission.

Request body:

```
{
  "permissions": [
    "own"
  ]
}
```

5. Send the request.

Response body: This endpoint does not return data.

6. Optional: Assign a locker manager. Use the PUT method and endpoint

URL:<your_control_room_url>/v2/credentialvault/lockers/{lockerId}/members/{userId}.

Request body:

```
{
  "permissions": [
    "manage"
  ]
}
```

7. Send the request.

Response body: This endpoint does not return data.

8. Optional: Assign a locker participant. Use the PUT method and endpoint

URL:<your_control_room_url>/v2/credentialvault/lockers/{lockerId}/members/{userId}.

Request body:

```
{
  "permissions": [
    "participate"
  ]
}
```

```
}

```

9. Send the request.

Response body: This endpoint does not return data.

10. Assign locker consumers. Use the POST method and endpoint URL:: <your_control_room_url>/v2/credentialvault/lockers/{lockerId}/consumers

Request body: Provide the role ID. All users who are assigned that custom role can build and run bots using the credentials in this locker, as well as enter values into credentials that accept user-provided attribute values.

```
{
  "id": "516"
}
```

11. Send the request.

Response body: This endpoint does not return data.

If you are following the steps to configure your Credential Vault, do this next: [Assign credential to locker API](#).

Configure a credential with attribute values using API

Create a credential with a standard attribute and add two additional attributes with user-input values.

Note: You can view the in the , but API functionality is limited. You need a licensed Edition to access the full functionality of the APIs.

- All API calls must contain either an authentication token from [Authentication API](#) (generates JSON Web token) or a bearer token from OAuth services. You cannot use both together in an API.
- All roles have the `Manage my credentials` and `lockers` permission that is necessary to configure credentials and attributes. No additional permissions are necessary to use this endpoint.

In this example, you configure a credential with three attributes to hold email hostname, username, and password.

1. Add the authentication token or bearer token to the request header. You cannot use both in the same API.

Create a credential:

2. Use the POST method and endpoint URL: <your_control_room_url>/v2/credentialvault/credentials.

Request body: This example request includes the following required parameters:

- `userProvided`: a boolean value that configures whether the attribute requires a user's input (**true**) or is standard for all users (**false**).
- `masked`: a boolean value that configures whether the attribute value is masked with asterisks (**true**) or is visible to users (**false**).

```
{
  "name": "Email",
  "attributes": [
    {
      "name": "hostname",
      "userProvided": false,
      "masked": false
    }
  ]
}
```

3. Send the request.

Response body: In a successful request, this endpoint returns the following data:

- `id`: a unique numeric identifier for the credential.
- `attributes.id`: a unique numeric identifier for attribute.

```
{
  "id": "1630",
  "name": "Email",
  "description": "",
  "ownerId": "1508",
  "attributes": [
    {
      "id": "3335",
      "name": "hostname",
      "description": "",
      "userProvided": false,
      "masked": false,
      "createdBy": "1508",
      "createdOn": "2020-12-28T22:04:41.366448Z",
      "updatedBy": "1508",
      "updatedOn": "2020-12-28T22:04:41.366450Z",
      "version": "0",
      "passwordFlag": false
    }
  ],
  "createdBy": "1508",
  "createdOn": "2020-12-28T22:04:41.366460Z",
  "updatedBy": "1508",
  "updatedOn": "2020-12-28T22:04:41.366464Z",
  "version": "0"
}
```

The REST API responds to each request with an HTTP response code. For response codes, see [API response codes](#).

Assign a standard value to the hostname attribute to the credential:

4. Use the POST method and endpoint URL: <your_control_room_url>/v2/credentialvault/credentials/{credentialId}/attributevalues.

```
{
  "list": [
    {
      "credentialAttributeId": "3335",
      "value": "mail.example.com"
    }
  ]
}
```

5. Send the request.

Response body:

```
{
  "list": [
    {
      "id": "1630",
      "credentialAttributeId": "3335",
      "value": "mail.example.com",
      "userId": "1508",
      "createdBy": "1508",
      "createdOn": "2020-12-28T22:04:41.366460Z",
    }
  ]
}
```

```

    "updatedBy": "1508",
    "updatedOn": "2020-12-28T22:04:41.366464Z",
    "version": "0"
  }
]
}

```

6. Add the `username` and `password` attributes to the `Email` credential. Use the `PUT` method and endpoint URL: `<your_control_room_url>/v2/credentialvault/credentials/{credentialId}`.

Note: You must include the existing attributes along with the new attributes in the request, otherwise the current attributes will be overwritten.

Request body: Since you have specified the credential ID in the request URL, it is not required to include the credential ID or name in the request body. In this example request body, the `username` and `password` attributes are configured with values that accept a different input from each user. Additionally, the `password` attribute is configured to mask the entered value with asterisks.

```

{
  "attributes": [
    {
      "name": "username",
      "userProvided": true,
      "masked": false
    },
    {
      "name": "password",
      "userProvided": true,
      "masked": true
    },
    {
      "name": "hostname",
      "userProvided": false,
      "masked": false
    }
  ]
}

```

7. Send the request.

Response body: The response body returns the credential with details of the three attributes.

```

{
  "id": "1630",
  "name": "Email",
  "description": "",
  "ownerId": "1508",
  "attributes": [
    {
      "id": "3335",
      "name": "hostname",
      "description": "",
      "userProvided": false,
      "masked": false,
      "createdBy": "1508",
      "createdOn": "2020-12-28T22:04:41.366448Z",
      "updatedBy": "1508",
      "updatedOn": "2020-12-28T22:04:41.366450Z",
      "version": "0",
      "passwordFlag": false
    },
    {

```

```

        "id": "3336",
        "name": "username",
        "description": "",
        "userProvided": true,
        "masked": false,
        "createdBy": "1508",
        "createdOn": "2020-12-28T22:04:41.366450Z",
        "updatedBy": "1508",
        "updatedOn": "2020-12-28T22:04:41.366450Z",
        "version": "0",
        "passwordFlag": false
    },
    {
        "id": "3337",
        "name": "password",
        "description": "",
        "userProvided": true,
        "masked": true,
        "createdBy": "1508",
        "createdOn": "2020-12-28T22:04:41.366450Z",
        "updatedBy": "1508",
        "updatedOn": "2020-12-28T22:04:41.366450Z",
        "version": "0",
        "passwordFlag": false
    }
],
"createdBy": "1508",
"createdOn": "2020-12-28T22:04:41.366460Z",
"updatedBy": "1508",
"updatedOn": "2020-12-28T22:06:35.366464Z",
"version": "2"
}

```

If you are following the steps to configure your Credential Vault, do this next: [Assign credential to locker API](#).

Assign credential to locker API

Add a credential to a locker to enable other users to access the credential to build and run bots.

Note: You can view the in the , but API functionality is limited. You need a licensed Edition to access the full functionality of the APIs.

- All API calls must contain either an authentication token from [Authentication API](#) (generates JSON Web token) or a bearer token from OAuth services. You cannot use both together in an API.
- You must have **own**, **manage**, or **participate** access permissions to the locker.

To assign a credential to a locker, you provide the credential and locker IDs in the URL.

1. Add the authentication token or bearer token to the request header. You cannot use both in the same API.
2. Use the PUT method and endpoint URL:: <your_control_room_url>/v2/credentialvault/lockers/{lockerId}/credentials/{credentialId}.
Request body: This endpoint does not have a request body.
3. Send the request.
Response body: This endpoint does not return data.

List credentials using API

Return a list of the credentials for which you are the owner or have access through a locker. If you have the **AAE_Locker Admin** role, this endpoint returns all the credentials in the Control Room.

Request

```
POST http://{{ControlRoomURL}}/v2/credentialvault/credentials/list
```

```
Header: X-Authorization: <<authentication token>> or Authorization: Bearer <<bearer token>>
```

All API calls must contain either an authentication token from [Authentication API](#) (generates JSON Web token) or a bearer token from OAuth services. You cannot use both together in an API.

You must have access to the credential, either as the credential owner or through a locker.

Request body:

```
{
  "filter": {
    "operator": "and",
    "operands": [
      {
        "operator": "gt",
        "field": "createdOn",
        "value": "2022-10-12T00:00:00.123Z"
      },
      {
        "operator": "lt",
        "field": "createdOn",
        "value": "2022-10-12T23:00:00.123Z"
      }
    ]
  },
  "sort": [
    {
      "field": "name",
      "direction": "asc"
    }
  ],
  "page": {
    "offset": 0,
    "length": 100
  }
}
```

Request Parameters

Parameter	Type	Required	Description
consumed	Boolean	No	Filter credentials by fact if credential is user Provided and consumed by current user.

Parameter	Type	Required	Description
sort	Array	No	By default, search results are sorted in ascending order of the IDs. To specify an alternate sorting, use the sort query parameter. Enter the field by which you want to sort along with the direction <code>asc</code> (ascending) or <code>desc</code> (descending).
filter	Object	No	Filters the result based on operator, field, or value. operator Allowed enumerations are NONE, lt, le, eq, ne, ge, gt, substring, and, or, not. field Allowed values are name, lastModified, path, or folder. value Specify a value for the name, lastModified, path, or folder that you have selected in the field parameter.
page	Object	No	The page object allows you to get the desired number of pages.

For more information on Filtering, Pagination, and Sorting, see [Filtering, pagination, and sorting](#).

Response

```
{
  "page": {
    "offset": 0,
    "total": 7,
    "totalFilter": 1
  },
  "list": [
    {
      "id": "307",
      "name": "Sample-Credential",
      "description": "Test credential Created from API request",
      "completed": true,
      "lockerId": "15",
      "ownerId": "21",
      "attributes": [
        {
          "id": "916",
          "name": "Username",
          "description": "Username for a sample API call",
          "userProvided": false,
          "masked": false,
          "passwordFlag": false,
          "createdBy": "21",
          "createdOn": "2022-10-28T00:15:09.319987Z",
          "updatedBy": "21",
          "updatedOn": "2022-10-28T00:15:09.319988Z",
          "version": "0"
        }
      ]
    }
  ]
}
```

```

    }
  ],
  "createdBy": "21",
  "createdOn": "2022-10-12T20:42:32.896315Z",
  "updatedBy": "21",
  "updatedOn": "2022-10-12T20:42:32.896317Z",
  "version": "0"
}
]
}
400
Bad Request

```

Response parameters

Parameter	Type	Description
offset	Integer	The starting list offset, used for pagination.
total	Integer	Total number of records.
totalFilter	Integer	Number of records after applying the filter.
List	Array	The list of directories and files.
List objects		
id	Integer	The unique ID of the credential.
name	String	Name of the credential.
description	String	Description of credential
completed	Boolean	Shows if consumer(s) needs to provide a value for user-provided attr
lockerId	String	Id of the locker which has this credential, can be null if the credential assigned to any locker
ownerId	String	Id of Credential owner User

Parameter	Type	Description
attributes	Object	Displays the credential attributes: <ul style="list-style-type: none"> id Id of credential attribute name Name of credential description Description of credential attribute userProvided A flag to indicate if the credential attribute is user-provided or system-provided masked A flag to indicate if the credential attribute value is masked passwordFlag A flag to indicate if the credential attribute is used for password input fields createdBy Id of the user who created the object createdOn Creation date of the object updatedBy Id of the user who made a latest update on the object updatedOn Latest updated date of the object version Version of the object, has to be provided by the client to track simultaneous updates
createdBy	String	Id of the user who created the object
createdOn	String	Creation date of the object.
updatedBy	String	Id of the user who made a latest update on the object
updatedOn	String	Latest updated date of the object
version	String	Version of the object, has to be provided by the client to track simultaneous updates

Now that you have the IDs of attributes that accept a user-input value, next [Update attribute values](#).

Note: You can view the [Credential Attributes](#) in the [Control Room](#), but API functionality is limited. You need a licensed [Enterprise](#) Edition to access the full functionality of the APIs.

The REST API responds to each request with an HTTP response code. For response codes, see [API response codes](#).

Update attribute values

Update either a standard or user-input value to an attribute, based on your access permissions to the credential. A standard value is accessible by all users of the credential; an attribute with a user-input value enables each user to provide their own value which the other users cannot access.

Request

```
POST https://{{ControlRoomURL}}/v2/credentialvault/credentials/
{{credentialId}}/attributevalues
```

```
Header: X-Authorization: <<authentication token>> or Authorization: Bearer
<<bearer token>>
```

All API calls must contain either an authentication token from [Authentication API](#) (generates JSON Web token) or a bearer token from OAuth services. You cannot use both together in an API.

Tip:

- To set the standard value, you must have access to the credential, either as the credential owner or as a locker Admin or Manager.
- To set the user-input value, you must have access to the credential, either as the credential owner or as a locker consumer.
- Verify whether the attribute accepts a standard or user-input value. This is indicated in the userProvided output parameter. [List credentials using API](#).

Request body:

```
{
  "list": [
    {
      "credentialAttributeId": "890",
      "value": "aVerySecurePassword"
    }
  ]
}
```

Request Parameters

Parameter	Type	Required	Description
credentialAttributeId	String	Yes	Id of credential attribute.
value	String	Yes	Value of credential attribute.

Response

```
201 Created
```

For more information on the return codes, see [API response codes](#).

```
{
  "list": [
    {
      "id": "131",
      "credentialAttributeId": "890",
      "value": "00172qLH9JgAHUB21vCGj4ZheVokDL6unV1HIX8rWUw=",
      "userId": "38",
      "createdBy": "38",
      "createdOn": "2022-09-22T14:42:02.876540Z",
      "updatedBy": "38",
      "updatedOn": "2022-09-22T14:42:02.876544Z",
      "version": "0",
      "password": false
    }
  ]
}
```

Response Parameters

Parameter	Type	Description
id	String	Id of credential attribute value.
credentialAttributeId	String	Id of credential attribute.
value	String	Value of credential attribute.
userId	String	Id of user to which the value belongs to.
createdBy	String	Id of the user who created the Credential.
createdOn	String	Date of creation of the Credential.
updatedBy	String	Id of the user who made a latest update on the Credential.
updatedOn	String	Date of the latest update of the Credential.
version	String	Version of the Credential, has to be provided by the client to track successive updates.
password	Boolean	Flag to indicate if there is a password set to the Credential.

Note: You can view the `credentialAttributeId` in the `list`, but API functionality is limited. You need a licensed `Enterprise` Edition to access the full functionality of the APIs.

The REST API responds to each request with an HTTP response code. For response codes, see [API response codes](#).

Get Masked credentials

Use the `credentialAttributeValues` endpoint of the Credential Vault API to get the masked credentials.

Note: You can view the `credentialAttributeId` in the `list`, but API functionality is limited. You need a licensed `Enterprise` Edition to access the full functionality of the APIs.

- All API calls must contain either an authentication token from [Authentication API](#) (generates JSON Web token) or a bearer token from OAuth services. You cannot use both together in an API.
- You will be able to retrieve your masked attributes using the API and with **View and edit ALL credentials attributes** permission.

1. Use the POST method and endpoint URL: <control_room_URL>/v2/credentialvault/credentials/list.

Request body:

The following example will look for the credential called *ED10355* using POST with the endpoint <control_room_URL>/v2/credentialvault/credentials/list

```
{
  "filter":{
    "operator":"and",
    "operands":[
      {
        "operator":"eq",
        "field":"name",
        "value":"ED10355"
      }
    ]
  }
}
```

2. Send the request.

Response body:

```
{
  "page": {
    "offset": 0,
    "total": 6,
    "totalFilter": 1
  },
  "list": [
    {
      "id": "25",
      "name": "ED10355",
      "description": "",
      "ownerId": "132",
      "attributes": [
        {
          "id": "90",
          "name": "name",
          "description": "",
          "userProvided": false,
          "masked": true,
          "createdBy": "132",
          "createdOn": "2022-01-28T19:21:59.388237Z",
          "updatedBy": "132",
          "updatedOn": "2022-01-28T19:45:57.351698900Z",
          "version": "2",
          "passwordFlag": false
        }
      ]
    },
    {
      "createdBy": "132",
      "createdOn": "2022-01-28T19:21:59.388237Z",
      "updatedBy": "132",
      "updatedOn": "2022-01-28T19:45:57.353647200Z",
      "version": "2",
      "completed": false,
    }
  ]
}
```

```

    "externalVaultCredentialName": ""
  }
]
}

```

Note: The response shows the credential id ("id": "25") and credential attribute id ("id": "90"). In case if you want to retrieve the attribute id, to see if it has masked values or not. Use the GET method with the `v2/credentialvault/credentials/25` to list the attributes pertaining to the credential id ("id": "25").

- To get the masked attribute value, use the GET method with the endpoint `<control_room_URL>/v2/credentialvault/credentials/25/attributevalues?credentialAttributeId=90`

Note: You will be able to view your masked credential attributes, only if you have the **View and edit ALL credentials attributes**. You will not be able to view the masked credential attributes of other users.

- Send the request.

Response body:

```

{
  "list": [
    {
      "id": "46",
      "credentialAttributeId": "90",
      "value": "maskedsecret",
      "createdBy": "132",
      "createdOn": "2022-01-28T19:21:59.635310800Z",
      "updatedBy": "132",
      "updatedOn": "2022-01-28T19:40:04.495291100Z",
      "version": "1",
      "password": false
    }
  ]
}

```

The REST API responds to each request with an HTTP response code. For details about the response codes, see [API response codes](#).

Bot Execution Orchestrator API

As a Control Room administrator or a user with **View and Manage Scheduled Activity** permission, you can monitor the bot progress using a set of Control Room APIs.

Note: You can view the in the , but API functionality is limited. You need a licensed Edition to access the full functionality of the APIs.

High-level process for monitoring bots

Searchable fields for devices:

- hostName:** The host name of the device configured as a Bot Runner. If a naming convention is used for host names, searching on a unique **substring** in the host name is an effective way to identify Bot Runner devices.

- **userId:** The unique numeric identification for a specific user also identifies the Bot Runner device. Unique user naming conventions can be used to identify users and devices that are licensed and configured as Bot Runners.

Searchable fields for bots:

- **name:** The unique name of a bot. You can search on the exact name (**eq**) or a text string (**substring**) that is contained in the bots name.
- **path:** The relative path of a folder in the Control Room. You can search on a full path or a **substring** contained in the path.

Request device details

Use this API to retrieve a list of devices that are available for bot deployment.

Roles and license

You have to authenticate as a user with an **Unattended bot runner license**.

- **URL:**

```
http://<your_control_room_url>/v2/devices/list
```

- **Method: POST**

Supported filterable parameters:

id

The numeric identifier for a device.

- **Field:** id
- **Type:** integer

```
{
  "filter": {
    "operator": "eq",
    "value": "7",
    "field": "id"
  }
}
```

hostName

The name of the registered device.

- **Field:** hostName
- **Type:** string

```
{
  "filter": {
    "operator": "substring",
    "value": "AA",
    "field": "hostName"
  }
}
```

userId

A unique numeric identifier for the user associated with the registered device.

- **Field:** userId

- **Type: long**

```
{
  "filter": {
    "operator": "eq",
    "value": "13",
    "field": "userId"
  }
}
```

status

The connection status of device.

- **Field: status**
- **Type: string**

```
{
  "filter": {
    "operator": "eq",
    "value": "CONNECTED",
    "field": "status"
  }
}
```

This task requests a list of all devices with a specific string in the hostname parameter and specific status of the device. Use the list in the response to identify which devices are connected and available to run bots.

All API calls must contain either an authentication token from [Authentication API](#) (generates JSON Web token) or a bearer token from OAuth services. You cannot use both together in an API.

1. Select the **POST** method.
2. Enter the URL for the API:

```
https://<your_control_room_url>/v2/devices/list
```

3. In the request body, add the filtering, sorting, and pagination rules to retrieve the device list that you want to deploy.

Note: The `fields` array filter parameter in the request body is currently not supported. When you send the field name in the request body to restrict the number of fields in the response, it does not work as expected and instead returns all the fields.

For example, this request body uses "and" as `operator` and the device "status" and "hostname" as `field` to filter the required results. The results will be sorted in "descending" order based on "status".

```
{
  "sort": [
    {
      "field": "status",
      "direction": "desc"
    }
  ],
  "filter": {
    "operator": "and",
    "operands": [
      {
        "operator": "eq",
        "value": "CONNECTED",

```

```

    "field": "status"
  },
  {
    "operator": "substring",
    "value": "win",
    "field": "hostName"
  }
]
},
"page": {
  "offset": 0,
  "total": 71,
  "totalFilter": 18,
  "length": 100
}
}

```

4. Send the request.

- In a REST client, click **SEND**.
- In the Swagger interface, click **Execute**.

Response body:

The response returns the details of two devices that are in the "connected" status and for which the hostName starts with "win" based on the requested filter criteria.

```

{
  "page": {
    "offset": 0,
    "total": 71,
    "totalFilter": 7
  },
  "list": [{
    "id": "163",
    "type": "ATTENDED_BOT_RUNNER",
    "hostName": "winwlm-2",
    "userId": "",
    "userName": "",
    "status": "CONNECTED",
    "poolName": "",
    "fullyQualifiedHostName": "-",
    "updatedBy": "b2",
    "updatedOn": "2020-07-07T08:24:56.091061Z",
    "botAgentVersion": "12.1"
  }, {
    "id": "162",
    "type": "ATTENDED_BOT_RUNNER",
    "hostName": "winwlm-1",
    "userId": "",
    "userName": "",
    "status": "CONNECTED",
    "poolName": "",
    "fullyQualifiedHostName": "-",
    "updatedBy": "b1",
    "updatedOn": "2020-07-07T08:24:55.982047Z",
    "botAgentVersion": "12.1"
  }
}

```

You can use the device IDs received in the response to deploy the bots on Bot Runners.

Activity list

You can returns a list of bot executions based on filtering, ordering, and pagination rules. Use this API to fetch execution details for specific automation IDs as returned by the deployment API, with the exception of bot output variables and callback information.

Note: If you want to get the `botOutVariables` or `callbackInfo`, use [Activity job execution](#).

Request

```
POST https://{{ControlRoomURL}}/v3/activity/list
```

```
Header: X-Authorization: <<authentication token>> or Authorization: Bearer <<bearer token>>
```

All API calls must contain either an authentication token from [Authentication API](#) (generates JSON Web token) or a bearer token from OAuth services. You cannot use both together in an API.

Request body:

```
{
  "sort": [
    {
      "field": "endDateTime",
      "direction": "desc"
    }
  ],
  "filter": {
    "operator": "eq",
    "value": "UPDATE",
    "field": "status"
  },
  "page": {
    "length": 100,
    "offset": 0
  }
}
```

Filter the results using `automationId`, `deviceId`, `status`, or `deploymentId`. You can also use a combination of these filters to optimize your search results.

Request body using deployment ID:

```
{
  "filter": {
    "operator": "eq",
    "field": "deploymentId",
    "value": "14c2b6f8-c2a0-4a57-959d-ef413df0d179"
  }
}
```

Note: Use the empty filter or no filter to retrieve all the information in the search results.

Request parameters

Parameter	Type	Required	Description
sort	Array	No	By default, search results are sorted in descending order with respect to the sort query parameter. Enter the field by which you want to sort along with the direction <code>asc</code> (ascending) or <code>desc</code> (descending). For more information on sorting, see Filtering, pagination, and sorting .
filter	Object	No	Filters the result. For more information on sorting, see Filtering, pagination, and sorting .
fields	Array	No	Filter the result based on the fields.
page	Object	No	The page object allows you to get the desired pages. For more information on pagination rules, see Filtering, pagination, and sorting .

Response

200 OK

For more information on return codes, see [API response codes](#).

```
{
  "page": {
    "offset": 0,
    "total": 2387,
    "totalFilter": 2
  },
  "list": [
    {
      "id": "44266e73-4688-4c5a-bad4-11f4c734804d_653a835e07a597fc",
      "automationName": "7 Minutes Bot.22.04.22.13.01.23.chintan-
runner",
      "fileName": "7 Minutes Bot",
      "filePath": "",
      "type": "RUN_NOW",
      "startDateTime": "2022-04-22T07:31:44.527762800Z",
      "endDateTime": "1970-01-01T00:00:00Z",
      "command": "",
      "status": "UPDATE",
      "progress": 0,
      "automationId": "",
      "userId": "1141",
      "deviceId": "352",
      "currentLine": 5,
      "totalLines": 0,
      "fileId": "139836",
      "modifiedBy": "1140",
      "createdBy": "1140",
      "modifiedOn": "2022-04-22T07:31:45.265728Z",
      "createdOn": "",
      "deploymentId": "b969e264-65bc-480c-a7db-071bbeedc9ba",
      "queueName": "",
      "queueId": "",
      "usingRdp": false,
      "message": ""
    }
  ]
}
```



```

        "canManage": true,
        "deviceName": "AAIN243FQGYE",
        "userName": "joe-doe-runner",
        "tenantUuid": "b6e4eb84-f7ef-4dfd-a432-725b71de8142",
        "automationPriority": "PRIORITY_MEDIUM",
        "callbackInfo": "",
        "runElevated": false,
        "botLabel": "",
        "currentBotName": ""
    },
    {
        "id": "5e55db1e-c6ec-422b-8718-49224b2f3ce3_03a0f7f8bb373597",
        "automationName": "ButtonBot.2022.05.02.08.07.24.ritesh",
        "fileName": "ButtonBot",
        "filePath": "",
        "type": "RUN_NOW",
        "startDateTime": "2022-05-02T15:07:29.004749Z",
        "endDateTime": "1970-01-01T00:00:00Z",
        "command": "",
        "status": "UPDATE",
        "progress": 0,
        "automationId": "",
        "userId": "291",
        "deviceId": "161",
        "currentLine": 0,
        "totalLines": 0,
        "fileId": "142853",
        "modifiedBy": "291",
        "createdBy": "291",
        "modifiedOn": "2022-05-02T08:07:31.548640Z",
        "createdOn": "",
        "deploymentId": "05a192ec-967e-47f3-8b81-185a161d9424",
        "queueName": "",
        "queueId": "",
        "usingRdp": false,
        "message": "",
        "canManage": true,
        "deviceName": "form-builder",
        "userName": "johndoe",
        "tenantUuid": "b6e4eb84-f7ef-4dfd-a432-725b71de8142",
        "automationPriority": "PRIORITY_MEDIUM",
        "callbackInfo": "",
        "runElevated": false,
        "botLabel": "",
        "currentBotName": ""
    }
]
}

```

Response parameters

Parameter	Type	Description
offset	Integer	The starting list offset, used for pagination
total	Integer	Total number of records
totalFilter	Integer	Number of records after applying the filter
List	Array	The array of List activity objects
List activity object		

Parameter	Type	Description
id	Integer	The unique ID of a specific activity
automationName	String	Name of the automation
fileName	String	Bot file name
filePath	String	<p>The file path of the bot</p> <hr/> <p>Note: As filePath is deprecated, use <i>Get Immediate Parents API</i>, endpoint <code>GET http://{{ControlRoomURL}}/v2/repository/files/parents</code> to retrieve the file path based on the input file ID.</p>
type	String	<p>File type associated with the bot. Following are the possible values for type:</p> <ul style="list-style-type: none"> • WORKORDER: Depicts the status of the workitems uploaded from the automation • WLM_TASK: A Workload management bot • EXPORT: Bot export • API: A bot that is run from an API • AARI: A process bot • RUN_NOW: A run as a users bot • SCHEDULED: A scheduled bot • TRIGGER: A triggered bot • AUDIT_EXPORT: Audit export • QUEUE_EXPORT: Queue export • QUEUE_IMPORT: Queue import • WORKITEM_EXPORT: List of workitems export in CSV
startDate	String	The date and time of when this bot started
endDate	String	The date and time of when this bot ended
command	String	The current command the bot is on
status	String	<p>The status of the bot. Following values are possible:</p> <ul style="list-style-type: none"> • COMPLETED: Bot successfully completed execution. • DEPLOYED: Autologin is successful, and bot is deployed to a device. • DEPLOY_FAILED: Bot failed to deploy to the device because, for example, autologin failed. • QUEUED: Requested user or device is busy running another execution. • PENDING_EXECUTION: Device has been selected, but bot has not yet been deployed to that device • RUNNING or UPDATE: Bot is executing on a device. • RUN_FAILED: Bot failed after being deployed to a device. • RUN_PAUSED: User paused the bot. • RUN_TIMED_OUT: Bot failed to complete tasks within a specific time. • UNKNOWN: Connection between the service and the device was lost.
progress	Integer	The progress of the bot in percentage.
totalLines	Integer	Total number of command lines the bot contains.

Parameter	Type	Description
currentLine	Integer	The current line the bot is processing.
timeTaken	Integer	Time taken in milliseconds by the bot to complete the operation.
progress	Integer	The progress of the bot in percentage.
automationId	Integer	The ID of the automation.
userId	Integer	The ID of the user.
deviceId	Integer	The ID of the device.
fileId	Integer	Unique identifier of the bot file.
modifiedBy	Integer	The ID of the user who modified the activity.
createdBy	Integer	The ID of the user who created the activity.
modifiedOn	String	The timestamp when it was modified.
createdOn	String	The creation timestamp of the activity.
deploymentId	String	The deployment ID of the bot.
queueName	String	Name of the queue.
queueId	String	ID of the queue.
usingRdp	Boolean	Flag that shows whether or not the bot is using remote deployment p
message	String	Error message that returns details about the state of the execution.
canManage	Boolean	Flag to show whether the bot can be managed.
deviceName	String	Name of the device.
userName	String	The user name of the user who is running the bot.
tenantUuid	String	The tenant's unique UUID.
automationPriority	String	The automation priority. By default it is set to <code>PRIORITY_MEDIUM</code> . P for <code>automationPriority</code> include: <code>PRIORITY_MEDIUM</code> , <code>PRIORIT</code> <code>PRIORITY_LOW</code> .
callbackInfo	Object	No value is returned for this parameter; will need individual bot API t information
runElevated	Boolean	Flag showing whether the bot was deployed using elevated permission Possible values include <code>false</code> and <code>true</code> .
botLabel	String	Label for the bot. It can be used to distinguish bots from categories s production and testing.
currentBotName	String	Current name of the bot. It can change during execution.

Note: You can view the in the , but API functionality is limited. You need a licensed Edition to access the full functionality of the APIs.

The REST API responds to each request with an HTTP response code. For response codes, see [API response codes](#).

Activity job execution

Fetch the execution details for a specific execution ID by using the `/v3/activity/execution/<id>` endpoint.

Request

```
GET https://{{ControlRoomURL}}/v3/activity/execution/<id>
```

```
Header: X-Authorization: <<authentication token>> or Authorization: Bearer <<bearer token>>
```

All API calls must contain either an authentication token from [Authentication API](#) (generates JSON Web token) or a bearer token from OAuth services. You cannot use both together in an API.

Sample Call

```
GET https://{{ControlRoomURL}}/v3/activity/execution/ed880baa-675a-4569-bd82-985f7e8260f7_7df4a4fb6307ebdb
```

Request parameters

Parameter	Type	Required	Description
id	String	Yes	The unique ID of a specific activity. You can retrieve the ID from Activity list .

Response

```
200 OK
```

```
{
  "id": "ed880baa-675a-4569-bd82-985f7e8260f7_7df4a4fb6307ebdb",
  "automationName": "v3_activity_test.2022.08.29.21.27.46.bot_user",
  "fileName": "v3_activity_test",
  "filePath": "",
  "type": "RUN_NOW",
  "startDateTime": "2022-08-29T21:27:54.361035200Z",
  "endDateTime": "2022-08-29T21:28:23.375972Z",
  "command": "messageBox",
  "status": "COMPLETED",
  "progress": 100,
  "automationId": "",
  "userId": "21",
  "deviceId": "22",
  "currentLine": 1,
  "totalLines": 1,
  "fileId": "1020",
  "modifiedBy": "21",
  "createdBy": "21",
  "modifiedOn": "2022-08-29T21:28:24.442884Z",
  "createdOn": "2022-08-29T21:27:48.636638Z",
```

```

"deploymentId": "6729052c-a56e-4a10-977d-387f3d45229f",
"queueName": "",
"queueId": "",
"usingRdp": false,
"message": "",
"canManage": true,
"deviceName": "AAUS3414D0D7",
"userName": "bot_user",
"botOutVariables": {
  "values": {
    "Test1": {
      "type": "STRING",
      "expression": "",
      "string": "1",
      "number": "",
      "boolean": "",
      "repository": "",
      "variableName": "",
      "packageId": "",
      "packageName": "",
      "iteratorId": "",
      "iteratorName": "",
      "conditionalId": "",
      "conditionalName": "",
      "list": [],
      "dictionary": [],
      "exceptionName": "",
      "thumbnailMetadataPath": "",
      "screenshotMetadataPath": "",
      "properties": [],
      "triggerName": "",
      "formElementId": "",
      "formElementType": "",
      "formInstanceId": "",
      "queueName": "",
      "taskbotSelf": false,
      "variableMapFilter": [],
      "sessionTarget": "NONE",
      "securelyRecorded": false
    }
  }
},
"tenantUuid": "06e42523-b44a-49f4-82dc-b8d420896761",
"automationPriority": "PRIORITY_MEDIUM",
"callbackInfo": "",
"runElevated": false,
"botLabel": "",
"currentBotName": "v3_activity_test"
}

```

Response parameters

Parameter	Type	Description
id	Integer	The unique ID of a specific activity.
automationName	String	Name of the automation.
fileName	String	Bot file name.

Parameter	Type	Description
filePath	String	<p>The file path of the bot.</p> <hr/> <p>Note: As filePath is deprecated, use the Get Immediate Parents API endpoint to retrieve the file path based on the input file id:</p> <pre>GET http://{{ControlRoomURL}}/v2/repository/files/ parents</pre> <hr/>
type	String	<p>File type associated with the bot. Following are the possible values for type:</p> <ul style="list-style-type: none"> • WORKORDER: Depicts the status of the workitems uploaded from the bot • WLM_TASK: A Workload management bot • EXPORT: Bot export • API: A bot that is run from an API • AARI: A process bot • RUN_NOW: A run as a users bot • SCHEDULED: A scheduled bot • TRIGGER: A triggered bot • AUDIT_EXPORT: Audit export • QUEUE_EXPORT: Queue export • QUEUE_IMPORT: Queue import • WORKITEM_EXPORT: List of workitems export in CSV
startDate	String	The date and time of when this bot started.
endDate	String	The date and time of when this bot ended.
command	String	The current command the bot is on.
status	String	<p>The status of the bot. Following values are possible:</p> <ul style="list-style-type: none"> • COMPLETED: Bot successfully completed execution. • DEPLOYED: Autologin is successful and bot is deployed to a device. • DEPLOY_FAILED: Bot failed to deploy to the device, for example, the device is not available or the bot failed. • QUEUED: Requested user or device is busy running another execution. • PENDING_EXECUTION: Device has been selected, but bot has not yet been deployed to that device. • RUNNING or UPDATE: Bot is running on a device. • RUN_FAILED: Bot failed after being deployed to a device. • RUN_PAUSED: User paused the bot. • RUN_TIMED_OUT: Bot failed to complete tasks within a specific time. • UNKNOWN: Connection between the service and the device was lost.
progress	Integer	The progress of the bot in percentage.
totalLines	Integer	Total number of command lines the bot contains.
currentLine	Integer	The line that the bot is processing currently.
timeTaken	Integer	Time taken in milliseconds by the bot to complete the operation.
progress	Integer	The progress of the bot in percentage.

Parameter	Type	Description
automationId	Integer	The ID of the automation.
userId	Integer	The ID of the user.
deviceId	Integer	The ID of the device.
currentLine	Integer	The line that the bot is processing currently.
totalLines	Integer	Total number of command lines the bot contains.
fileId	Integer	Unique identifier of the bot file.
modifiedBy	Integer	The ID of the user who modified the activity.
createdBy	Integer	ID of the user who created the activity.
modifiedOn	String	The timestamp when it got modified.
createdOn	String	The creation timestamp of the activity.
deploymentId	String	The deployment ID of the bot.
queueName	String	Name of the queue.
queueId	String	ID of the queue.
usingRdp	Boolean	Flag that shows whether or not the bot is using remote deployment p
message	String	Error message that returns details about the state of the execution.
canManage	Boolean	Flag to show whether the bot can be managed.
deviceName	String	Name of the device.
userName	String	The user name of the user who is running the bot.
tenantUuid	String	The tenant's unique UUID.
automationPriority	String	The automation Priority. By default it is set to <code>PRIORITY_MEDIUM</code> . P values for <code>automationPriority</code> include the following: <code>PRIORITY_MEDIUM</code> , <code>PRIORITY_HIGH</code> , and <code>PRIORITY_LOW</code> .
callbackInfo	String	<code>callbackInfo</code> provides the callback API URL (For example, <code>https://callbackserver.com/storeBotExecutionStatus</code>) and authentication token for the callback server. After the bot is deployed, the Control Room sends deployment status and output variable values to this callback server. Note: The callback server must accept POST calls to receive the bot's output data and the deployment status from the Control Room.
runElevated	Boolean	Flag showing whether the bot deployed using elevated permissions or not. Values include the following: <code>false</code> , <code>true</code>
botLabel	String	Label for the bot. It can be used to distinguish bots based on category like production and testing.
currentBotName	String	The bot's current bot name. It can change during the execution.
botOutVariables object		
Output	varies	A data structure containing all the output objects. More details follow

Parameter	Type	Description
type*	Any	Possible values for <code>type</code> include the following: STRING, NUMBER, BOOLEAN, FILE, ITERATOR, LIST, DICTIONARY, TABLE, VARIABLE, CONDITION, WINDOW, TASKBOT, DATETIME, UIOBJECT, RECORD, EXCEPTION, COORDINATE, IMAGE, REGION, PROPERTIES, TRIGGER, CONDITIONAL FORM, FORMELEMENT, HOTKEY, and WORKITEM.
*The structure of the output varies depending on the output.		

Note: You can view the in the , but API functionality is limited. You need a licensed Edition to access the full functionality of the APIs.

The REST API responds to each request with an HTTP response code. For response codes, see [API response codes](#).

Bot Scheduler APIs

Use the Bot Scheduler APIs to create, update, delete, and return details on scheduled automations.

Note: You can view the in the , but API functionality is limited. You need a licensed Edition to access the full functionality of the APIs.

Prerequisites

Ensure that you are allocated the following resources:

- **Schedule my bots to run** feature permission
- **Run and schedule** permissions for the folders that contain the bots.
- Access to the Bot Runner licensed users.
- Access to either a default device or a device pool

Note: If the user associated with the license has a default device assigned to their account, the deploys on that device. If no default device is assigned, or you want to select a different device, then you must specify a device pool.

Create an automation schedule

1. [Authenticate the user](#)
2. [List files and folders by workspace API](#)
3. [List available unattended Bot Runners API](#)
4. **Optional:** [List device pools API](#)
5. [Schedule bot to run API](#)

Schedule bot to run API

Schedule a bot to run on an unattended Bot Runner either one time or on a recurring basis.

Note: You can view the in the , but API functionality is limited. You need a licensed Edition to access the full functionality of the APIs.

- All API calls must contain either an authentication token from [Authentication API](#) (generates JSON Web token) or a bearer token from OAuth services. You cannot use both together in an API.
- Ensure that you are allocated the following resources:
 - **View and Run my bots** feature permission
 - **Run and schedule** permissions for the folders that contain the bots
 - Access to Bot Runner licensed users
 - Access to either a default device or a device pool

Note: If the user associated with the license has a default device assigned to their account, the deploys on that device. If no default device is assigned, or you want to select a different device, then you must specify a device pool.

To schedule a bot, you provide the following information to the API:

Parameter	Required	Type	Description
fileId	Yes	Number	Identifier for the bot. List files and folders by workspace API
runAsUserIds	Yes	Number	Identifier for a user that is registered with your Control Room as an Unattended bot runner. List available unattended Bot Runners API
status	Yes	String	Indicates whether to create an active or draft schedule. Enter either <code>ACTIVE</code> or <code>DRAFT</code> .
poolIds	No	Number	Identifier of a device pool that has at least one active device. List device pools API
overrideDefaultDevice	No	Boolean	If the Bot Runner user is assigned to a default device and you want to use a device pool, set this parameter to <code>true</code> . If deploying to the default device, set this parameter to <code>false</code> .

1. Add the authentication token or bearer token to the request header. You cannot use both in the same API.
2. Use the POST method and endpoint URL: `<control_room_url>/v1/schedule/automations`.

Request body:

This example request body contains the required parameters to schedule a bot to run one time.

```
{
  "name": "UpdateInventory.20.12.16.10.40.48",
  "fileId": 14277,
  "poolIds": [
    "27"
  ],
  "timeZone": "Asia/Calcutta",
  "runAsUserIds": [
    "472",
    "480",
  ]
}
```

```

    "80"
  ],
  "startDate": "2020-12-16",
  "startTime": "15:00",
  "scheduleType": "NONE",
  "status": "ACTIVE"
}

```

This example request body contains the required parameters to schedule a bot to run on a recurring basis.

```

{
  "name": "UpdateInventory.20.12.16.10.40.48",
  "fileId": 14277,
  "poolIds": [
    "27"
  ],
  "timeZone": "Australia/Melbourne",
  "runAsUserIds": [
    "1103",
    "36",
    "80"
  ],
  "startDate": "2020-12-16",
  "repeatOccurrence": {
    "endTime": "23:59",
    "runEvery": "1",
    "timeUnit": "HOURS"
  },
  "repeatEnabled": true,
  "endDate": "2020-12-24",
  "startTime": "20:45",
  "weeklyRecurrence": {
    "interval": "1",
    "daysOfWeek": [
      "TUE",
      "THU",
      "FRI"
    ]
  },
  "scheduleType": "WEEKLY",
  "status": "ACTIVE"
}

```

3. Send the request.

Response body: The two example responses include the following information about the automation:

- **id:** the numerical value that identifies the automation. Use this parameter in the `Update automations` or `Delete automations` APIs.
- **zonedNextRunDateTime:** the date and time of the next time the bot is scheduled to run.

This is an example response for a bot scheduled to run one time.

```

{
  "id": "989",
  "name": "UpdateInventory.20.12.16.10.40.48",
  "fileId": 14277,
  "status": "ACTIVE",
  "deviceIds": [],
  "description": "",
  "rdpEnabled": false,

```

```

"scheduleType": "NONE",
"timeZone": "Asia/Calcutta",
"startDate": "2021-12-16",
"endDate": "",
"startTime": "15:00",
"repeatEnabled": false,
"zonedNextRunDateTime": "2021-12-16T09:30:00Z",
"createdBy": "1103",
"createdOn": "2021-01-11T18:57:18.932407Z",
"updatedBy": "1103",
"updatedOn": "2021-01-11T18:57:18.932422Z",
"tenantId": "1",
"fileName": "appsheet",
"filePath": "Automation Anywhere\\Bots\\appsheet",
"runAsUserIds": [
  "480",
  "80",
  "472"
],
"botInput": {},
"tenantUuid": "e100fbce-008c-04ec-4063-7af0af91fb2f",
"poolId": [
  "11"
],
"overrideDefaultDevice": false,
"runElevated": false
}

```

This is an example response for a bot scheduled to run on a recurring basis.

```

{
  "id": "990",
  "name": "UpdateInventory.20.12.16.10.40.48",
  "fileId": 14277,
  "status": "ACTIVE",
  "deviceIds": [],
  "description": "",
  "rdpEnabled": false,
  "scheduleType": "WEEKLY",
  "weeklyRecurrence": {
    "interval": 1,
    "daysOfWeek": [
      "TUE",
      "THU",
      "FRI"
    ]
  },
  "timeZone": "Australia/Melbourne",
  "startDate": "2021-01-16",
  "endDate": "2021-12-24",
  "startTime": "20:45",
  "repeatEnabled": true,
  "repeatOccurrence": {
    "runEvery": "1",
    "timeUnit": "HOURS",
    "endTime": "23:59"
  },
  "zonedNextRunDateTime": "2021-01-19T09:45:00Z",
  "createdBy": "1103",
  "createdOn": "2021-01-11T18:59:31.182663Z",
  "updatedBy": "1103",
  "updatedOn": "2021-01-11T18:59:31.182669Z",
  "tenantId": "1",
}

```

```

    "fileName": "a_trigger",
    "filePath": "Automation Anywhere\\Bots\\a_trigger",
    "runAsUserIds": [
      "80",
      "36",
      "1103"
    ],
    "botInput": {},
    "tenantUuid": "e100fbce-008c-04ec-4063-7af0af91fb2f",
    "poolId": [
      "7"
    ],
    "overrideDefaultDevice": false,
    "runElevated": false
  }

```

The REST API responds to each request with an HTTP response code. For response codes, see [API response codes](#).

Use the [List automation schedules API](#) to retrieve details on all the scheduled automations.

List automation schedules API

Retrieve details of the automation schedules that you have permissions to view.

Note: You can view the in the , but API functionality is limited. You need a licensed Edition to access the full functionality of the APIs.

- All API calls must contain either an authentication token from [Authentication API](#) (generates JSON Web token) or a bearer token from OAuth services. You cannot use both together in an API.
- You must be assigned a role that includes the View and manage all scheduled activity from my Folders permission.

In this example, you list all the scheduled automations sorted by the next run date and time.

1. Add the authentication token or bearer token to the request header. You cannot use both in the same API.
2. Use the POST method and endpoint URL: <control_room_url>/v1/schedule/automations/list.

Request body:

```

{
  "sort": [
    {
      "field": "zonedNextRunDateTime",
      "direction": "asc"
    }
  ]
}

```

3. Send the request.

Response body: The response includes the following data about each automation:

- **id:** the numerical value that identifies the automation. Use this parameter in the `Update automations` or `Delete automations` APIs.
- **status:** returns whether the scheduled automation is `ACTIVE` or `INACTIVE`.

```
{
  "page": {
    "offset": 0,
    "total": 3,
    "totalFilter": 3
  },
  "list": [
    {
      "id": "661",
      "name": "eodReport_28.20.10.12.23.02.48",
      "fileId": 6598,
      "status": "ACTIVE",
      "deviceIds": [],
      "description": "",
      "rdpEnabled": false,
      "scheduleType": "DAILY",
      "dailyRecurrence": {
        "interval": 3
      },
      "timeZone": "America/Los Angeles",
      "startDate": "2020-10-12",
      "endDate": "",
      "startTime": "23:30",
      "repeatEnabled": true,
      "repeatOccurrence": {
        "runEvery": "3",
        "timeUnit": "HOURS",
        "endTime": "23:59"
      },
      "zonedNextRunDateTime": "2021-01-14T07:30:00Z",
      "createdBy": "251",
      "createdOn": "2020-10-13T06:01:51.992433Z",
      "updatedBy": "251",
      "updatedOn": "2021-01-11T07:30:00.082057Z",
      "tenantId": "1",
      "fileName": "wlm_28",
      "filePath": "Automation Anywhere\\Bots\\West Coast",
      "runAsUserIds": [
        "251"
      ],
      "botInput": {},
      "tenantUuid": "e100fbce-008c-04ec-4063-7af0af91fb2f",
      "poolId": [
        "23"
      ],
      "overrideDefaultDevice": false,
      "runElevated": false
    },
    {
      "id": "990",
      "name": "accounts.20.12.16.10.51.59",
      "fileId": 12501,
      "status": "ACTIVE",
      "deviceIds": [],
      "description": "",

```

```

"rdpEnabled": false,
"scheduleType": "WEEKLY",
"weeklyRecurrence": {
  "interval": 1,
  "daysOfWeek": [
    "TUE",
    "THU",
    "FRI"
  ]
},
"timeZone": "Australia/Melbourne",
"startDate": "2021-01-16",
"endDate": "2021-12-24",
"startTime": "20:45",
"repeatEnabled": true,
"repeatOccurrence": {
  "runEvery": "1",
  "timeUnit": "HOURS",
  "endTime": "23:59"
},
"zonedNextRunDateTime": "2021-01-19T09:45:00Z",
"createdBy": "1103",
"createdOn": "2021-01-11T18:59:31.182663Z",
"updatedBy": "1103",
"updatedOn": "2021-01-11T18:59:31.182669Z",
"tenantId": "1",
"fileName": "a_trigger",
"filePath": "Automation Anywhere\\Bots\\APAC",
"runAsUserIds": [
  "80",
  "36",
  "1103"
],
"botInput": {},
"tenantUuid": "e100fbce-008c-04ec-4063-7af0af91fb2f",
"poolId": [
  "7"
],
"overrideDefaultDevice": false,
"runElevated": false
},
{
  "id": "989",
  "name": "UpdateInventory.20.12.16.10.40.48",
  "fileId": 11201,
  "status": "ACTIVE",
  "deviceIds": [],
  "description": "",
  "rdpEnabled": false,
  "scheduleType": "NONE",
  "timeZone": "Asia/Calcutta",
  "startDate": "2021-12-16",
  "endDate": "",
  "startTime": "15:00",
  "repeatEnabled": false,
  "zonedNextRunDateTime": "2021-12-16T09:30:00Z",
  "createdBy": "1103",
  "createdOn": "2021-01-11T18:57:18.932407Z",
  "updatedBy": "1103",
  "updatedOn": "2021-01-11T18:57:18.932422Z",
  "tenantId": "1",
  "fileName": "appsheets",
  "filePath": "Automation Anywhere\\Bots\\spreadsheets",
  "runAsUserIds": [

```

```

        "480",
        "80",
        "472"
    ],
    "botInput": {},
    "tenantUuid": "e100fbce-008c-04ec-4063-7af0af91fb2f",
    "poolId": [
        "11"
    ],
    "overrideDefaultDevice": false,
    "runElevated": false
  }
]
}

```

The REST API responds to each request with an HTTP response code. For response codes, see [API response codes](#).

Repository Management APIs

Use the Repository Management APIs to return information on or to delete the objects (bots, folders, and files) that you have permissions to access in the Control Room.

Note: You can view the in the , but API functionality is limited. You need a licensed Edition to access the full functionality of the APIs.

The Automation 360 repository is comprised of the private and public workspaces, which contain folders of bots and their dependency files. The private workspace holds objects that are only accessible to the logged-in user. Bots in the private workspace can only be run on that user's device. The public workspace holds objects that are accessible to all users who have the necessary permissions. When a bot is checked-in from a private workspace to the public workspace, it can be checked out by another user to their private workspace for editing or deployed to a Bot Runner.

Note:

- To view objects in your private workspace, you must have a Bot Creator license and a role that includes the `View my bots` feature permission.
 - To view objects in the public workspace, you must be assigned a role that includes the `View my bots` feature permission and the `View content bot` permission to folders in the public workspace.
-

Choosing a Repository Management list API

The following Repository Management APIs return information on objects (bots, files, and folders), based on the access granted by the user's role.

- `/file/list` returns details on all the objects for which you have access permissions.

[List files API](#)

- `/folders/{folderid}/list` returns details on only the objects in a specific folder.

[List files and folders in a specific folder API](#)

- `/workspaces/{workspaceType}/files/list` returns details on only the objects in either the public or private workspace.

List files and folders by workspace API

Supported filterable fields

Use the following filters in the request bodies of the list APIs to narrow down the response data.

createdBy

The numeric identifier for the user who created a folder or bot.

```
{
  "operator": "eq",
  "field": "createdBy",
  "value": "2587"
}
```

folder

This example searches for only folders. Set the value to `false` to search for only bots and files.

```
{
  "operator": "eq",
  "field": "folder",
  "value": "true"
}
```

name

This example searches for objects that are named **Finance** or **finance**. This search is not case-sensitive.

- **Field:** name
- **Type:** string

```
{
  "filter": {
    "operator": "eq",
    "value": "finance",
    "field": "name"
  }
}
```

path

This example searches for objects that contain the string **Finance** in the path parameter. This search is not case-sensitive.

- **Field:** path
- **Type:** string

```
{
  "filter": {
    "operator": "substring",
    "value": "Finance",
    "field": "path"
  }
}
```

Related concepts[Bot permissions for a role](#)Assign bot permissions when creating a role with the **View my bots** feature permission.

List files API

Use the `List files` API to view the details of all the objects (file, folder, or bot) in the Control Room. This API returns an `id` parameter as the response, which is a numeric value that can be used in different APIs to identify the file, folder, or bot.

Note: The List files API will be deprecated from version Automation 360 v.29. This API has the following limitations:

- If you use it as an `AAE_Admin`, you can view bots from the private repository in the response.
- If you use it as a bot creator, you can view system bots (recorder) in the response.

As a workaround, you can use the [List files and folders by workspace API](#).

Request

```
POST http://{{ControlRoomURL}}/v2/repository/file/list
```

```
Header: X-Authorization: <<authentication token>> or Authorization: Bearer <<bearer token>>
```

All API calls must contain either an authentication token from [Authentication API](#) (generates JSON Web token) or a bearer token from OAuth services. You cannot use both together in an API.

- To view objects in your private workspace, you must have a Bot Creator license and a role that includes the `View my bots` feature permission.
- To view objects in the public workspace, you must be assigned a role that includes the `View my bots` feature permission and the `View content` bot permission to folders in the public workspace.

You can send an API request with or without filter parameters. An API request without any filter parameters specified retrieves the details of all the objects in the Control Room. You can use the filter parameters to retrieve a specific set of file or folder objects instead of fetching all objects in the Control Room. For more information, see [Filtering, pagination, and sorting](#).

Request body without filters:

```
{
  "filter": null,
  "sort": [
    {
      "field": "directory",
      "direction": "desc"
    },
    {
      "field": "name",
      "direction": "asc"
    }
  ],
  "page": {
    "offset": 0,
    "length": 100
  }
}
```

```

    }
  }
}

```

Request body with filters:

```

{
  "filter": {
    "operator": "substring",
    "value": "bot",
    "field": "name"
  },
  "sort": [
    {
      "field": "directory",
      "direction": "desc"
    },
    {
      "field": "name",
      "direction": "asc"
    }
  ],
  "page": {
    "offset": 0,
    "length": 100
  }
}

```

Request parameters

Parameter	Type	Required	Description
filter	Object	No	Filters the result based on operator, field, or value. operator Allowed enumerations are NONE, lt, le, eq, ne, ge, gt, substring, and, or, not. field Allowed values are name, lastModified, path, or folder. value Specify a value for the name, lastModified, path, or folder that you have selected in the field parameter.
sort	Array	No	By default, search results are sorted in descending order of their IDs. To specify an alternative sorting, use the sort query parameter. Enter the field by which you want to sort along with the direction <code>asc</code> (ascending) or <code>desc</code> (descending).
page	Object	No	The page object allows you to get the desired pages.

Response

```

{
  "page": {
    "offset": 0,
    "total": 4619,
    "totalFilter": 100
  },
  "list": [
    {
      "id": "137169",
      "parentId": "111492",
      "name": ".25Bot",
      "permission": {
        "delete": true,
        "download": true,
        "upload": true,
        "run": true,
        "publishBotstore": false
      },
      "lastModified": "2022-04-11T10:28:18.098323Z",
      "lastModifiedBy": "291",
      "path": "Automation Anywhere\\Bots\\.25Bot",
      "directory": false,
      "size": "2615",
      "locked": false
    }
  ]
}

```

Response parameters

Parameter	Type	Description
offset	Integer	The starting list offset, used for pagination.
total	Integer	Total number of records.
totalFilter	Integer	Number of records after applying the filter.
List	Array	The list of directories and files.
List objects		
id	Integer	The unique ID of the displayed objects (bots, folders, or files).
parentId	Integer	The unique ID of the parent folder.
name	String	Name of the file or folder.

Parameter	Type	Description
permission	Object	Displays permissions for the current user with the values True or False. delete Indicates whether the current user has rights to delete the bot. download Indicates whether the current user has rights to download the bot. upload Indicates whether the current user has rights to upload the bot. run Indicates whether the current user has rights to run the bot. publishBotstore Indicates whether the current user has rights to publish to the bot store.
lastModified	Integer	Date and time when the bot was last updated.
lastModifiedBy	String	ID of the user who last updated the bot or file.
path	Integer	Path of the file or folder in the repository.
directory	String	Flag for directory.
size	Integer	Size of the file. It is available only if the item type is file.
locked	String	Indicates whether the file is locked. It is available only if the item type is file.

Note: You can view the `permissions` property in the `bot` object, but API functionality is limited. You need a licensed `Automation Anywhere` Edition to access the full functionality of the APIs.

The REST API responds to each request with an HTTP response code. For response codes, see [API response codes](#).

Create folder

Use the `Create a folder` API to create a folder within a parent folder. You can create a folder in either the private workspace or the public workspace in the Control Room.

Request

```
POST http://{{ControlRoomURL}}/v2/repository/folders/{folderid}
```

```
Header: X-Authorization: <<authentication token>> or Authorization: Bearer <<bearer token>>
```

All API calls must contain either an authentication token from [Authentication API](#) (generates JSON Web token) or a bearer token from OAuth services. You cannot use both together in an API.

You must specify the ID of a parent folder. To view the ID of the parent folder, use the [List files and folders in a specific folder API](#) endpoint.

Request body:

```
{
  "folderName": "my_bots"
}
```

Request parameters

Parameter	Type	Required	Description
folderId	Integer	Yes	Unique ID of the parent folder.
folderName	String	Yes	Name of the new folder that you want to create.

Response

```
{
  "id": "155524",
  "parentId": "108889",
  "name": "new marks bots",
  "permission": {
    "delete": true,
    "download": true,
    "upload": true,
    "run": true
  },
  "lastModified": "2022-07-19T23:08:49.150494Z",
  "lastModifiedBy": "275",
  "path": "Automation Anywhere\\\\\\\\Bots\\\\\\\\new marks bots",
  "directory": false,
  "size": 947,
  "locked": true,
  "productionVersion": null,
  "lockedBy": "0",
  "latestVersion": null,
  "fileLastModified": "2022-07-19T23:08:49.150494Z"
}
```

Response parameters

Parameter	Type	Description
id	String	Unique ID of the folder created.
parentId	String	Unique ID of the parent folder.
name	String	Name specified for the folder.

Parameter	Type	Description
permission	Object	Displays permissions for the current user with the values True or False. delete Indicates whether the current user has rights to delete the folder. download Indicates whether the current user has rights to download the folder. upload Indicates whether the current user has rights to upload the folder. run Indicates whether the current user has rights to run on folder.
lastModified	String	Date and time when the folder was last updated.
lastModifiedBy	String	ID of the user who last updated the folder.
path	String	Path of the folder in the repository.
directory	String	Flag for directory.
size	Integer	Size of the folder in KB.
locked	String	Indicates whether the folder is locked. It is available only if the item is locked.
productionVersion	String	Current production version of the folder (applicable only with VCS ON).
lockedBy	String	User ID who has locked the folder (applicable only with VCS ON).
latestVersion	String	Latest version of the folder (applicable only with VCS ON).
fileLastModified	String	Date and time when the folder was last updated.

Note: You can view the in the , but API functionality is limited. You need a licensed Edition to access the full functionality of the APIs.

The REST API responds to each request with an HTTP response code. For response codes, see [API response codes](#).

Delete folder

Use the `Delete folder` API to delete a folder.

Request

```
DELETE https://{ControlRoomURL}/v2/repository/folders/{folderid}
```

```
Header: X-Authorization: <<authentication token>> or Authorization: Bearer <<bearer token>>
```

All API calls must contain either an authentication token from [Authentication API](#) (generates JSON Web token) or a bearer token from OAuth services. You cannot use both together in an API.

Request parameters

You must specify the folder ID. To view the folder ID, use the [List files and folders in a specific folder API](#) endpoint.

Parameter	Type	Required	Description
folderid	Integer	Yes	Unique ID of the folder to be deleted.

Response

```
200 OK
```

Note: You can view the in the , but API functionality is limited. You need a licensed Edition to access the full functionality of the APIs.

The REST API responds to each request with an HTTP response code. For response codes, see [API response codes](#).

Edit details of folder

Use the `Edit details` endpoint to edit the details of a folder, such as name, parent folder ID, and description.

Request

```
PUT http://{{ControlRoomURL}}/v2/repository/folders/{folderid}
```

```
Header: X-Authorization: <<authentication token>> or Authorization: Bearer <<bearer token>>
```

All API calls must contain either an authentication token from [Authentication API](#) (generates JSON Web token) or a bearer token from OAuth services. You cannot use both together in an API.

You must specify the unique folder ID to edit or update the folder details. To view the folder ID, use the [List files and folders in a specific folder API](#) endpoint.

Request body:

```
{
  "folderId": "164086",
  "name": "my_bots",
  "description": "My sample bots",
  "parentId": "14"
}
```

Request parameters

Parameter	Type	Required	Description
folderId	Integer	Yes	Unique ID of the folder.
name	String	No	Name of the folder.
description	String	No	Description of the folder.
parentId	String	No	Unique ID of the parent folder.

Response

```
{
  "id": "155524",
  "parentId": "108889",
  "name": "new marks bots",
  "permission": {
    "delete": true,
    "download": true,
    "upload": true,
    "run": true
  },
  "lastModified": "2022-07-19T23:08:49.150494Z",
  "lastModifiedBy": "275",
  "path": "Automation Anywhere\\\\\\\\Bots\\\\\\\\new marks bots",
  "directory": false,
  "size": 947,
  "locked": true,
  "productionVersion": null,
  "lockedBy": "0",
  "latestVersion": null,
  "fileLastModified": "2022-07-19T23:08:49.150494Z"
}
```

Response parameters

Parameter	Type	Description
id	String	Unique ID of the folder created.
parentId	String	Unique ID of the parent folder.
name	String	Name specified for the folder.

Parameter	Type	Description	
permission	Object	delete	Indicates whether the current user has rights to delete the folder.
		download	Indicates whether the current user has rights to download the folder.
		upload	Indicates whether the current user has rights to upload the folder.
		run	Indicates whether the current user has rights to run on folder.
lastModified	String	Date and time when the folder was last updated.	
lastModifiedBy	String	ID of the user who last updated the folder.	
path	String	Path of the folder in the repository.	
directory	String	Flag for directory.	
size	Integer	Size of the folder in KB.	
locked	String	Indicates whether the folder is locked. It is available only if the item is locked.	
productionVersion	String	Current production version of the folder (applicable only with VCS ON).	
lockedBy	String	User ID who has locked the folder (applicable only with VCS ON).	
latestVersion	String	Latest version of the folder (applicable only with VCS ON).	
fileLastModified	String	Date and time when the folder was last updated.	

Note: You can view the `permission` in the `Folder` object, but API functionality is limited. You need a licensed `Automation Anywhere` Edition to access the full functionality of the APIs.

The REST API responds to each request with an HTTP response code. For response codes, see [API response codes](#).

List files and folders in a specific folder API

Return details about objects (bots, folders, and files) in a specific parent folder. This endpoint returns the object id, which is a numeric value that is used in other APIs to identify the file, folder or bot.

Note: You can view the `Folder` object in the `Folder` object, but API functionality is limited. You need a licensed `Automation Anywhere` Edition to access the full functionality of the APIs.

- All API calls must contain either an authentication token from [Authentication API](#) (generates JSON Web token) or a bearer token from OAuth services. You cannot use both together in an API.
- To view objects in your private workspace, you must have a Bot Creator license and a role that includes the `View my bots` feature permission.
- To view objects in the public workspace, you must be assigned a role that includes the `View my bots` feature permission and the `View content bot` permission to folders in the public workspace.

- You require the folder ID for the folder you want to search in. Use one of the following Repository Management APIs to retrieve the object ID:
 - [List files API](#)
 - [List files and folders by workspace API](#)

The example in this task searches for subfolders that contain the string **finance**.

- Add the authentication token or bearer token to the request header. You cannot use both in the same API.
- Use the POST method and endpoint URL: <control_room_url>/v2/repository/folders/{folderId}/list

{folderId} is the object ID of the folder that in which you want to search.

Request body: The following example request searches for folders that contain the word **finance** in the name.

```
{
  "filter": {
    "operator": "and",
    "operands": [
      {
        "operator": "substring",
        "field": "name",
        "value": "finance"
      },
      {
        "operator": "eq",
        "field": "folder",
        "value": "true"
      }
    ]
  }
}
```

Supported filterable fields

- Send the request.

Response body: In a successful request, this endpoint returns the following data:

- id:** a unique numeric identifier for the object that matches the search parameters.
- parentId:** a unique numeric identifier for the parent folder.
- folder:** a boolean value that returns `true` if the object is a folder and `false` if it is a bot or other file.

In this example response, the endpoint returns a folder with the object `id` of 40378.

```
{
  "page": {
    "offset": 0,
    "total": 329,
    "totalFilter": 1
  },
  "list": [
    {
      "id": "40378",
      "parentId": "2",
      "name": "EOD-finance-reports",
      "path": "Automation Anywhere\\Bots\\APAC\\EOD-finance-reports",
      "description": "",
      "type": "application/vnd.aa.directory",
    }
  ]
}
```

```

    "size": "0",
    "folder": true,
    "folderCount": "0",
    "productionVersion": "",
    "latestVersion": "",
    "locked": false,
    "lockedBy": "0",
    "createdBy": "2587",
    "lastModifiedBy": "2587",
    "lastModified": "2020-09-02T05:26:51.162916Z",
    "permission": {
      "delete": true,
      "download": false,
      "upload": false,
      "run": true,
      "publishBotstore": false,
      "viewContent": true,
      "clone": false,
      "editContent": true,
      "createFolder": true,
      "move": true,
      "cancelCheckout": false,
      "revertCheckout": false
    },
    "workspaceId": "0",
    "botStatus": "DRAFT",
    "hasErrors": false,
    "workspaceType": "UNKNOWN",
    "metadata": false,
    "uri": "",
    "version": "0",
    "hasTriggers": false
  }
]
}

```

Use the numeric identifier, such as an id in subsequent APIs.

Related reference

[Start migration API](#)

Use this API to migrate bots (TaskBots and MetaBots) created using the Enterprise Client version 11.x to Automation 360.

List files and folders by workspace API

Return details on objects (files, folders, and bots) in either the public or private workspace. This endpoint returns the object id, which is a numeric value that is used in other APIs to identify the file, folder or bot.

Note: You can view the in the , but API functionality is limited. You need a licensed Edition to access the full functionality of the APIs.

- All API calls must contain either an authentication token from [Authentication API](#) (generates JSON Web token) or a bearer token from OAuth services. You cannot use both together in an API.
- To view objects in your private workspace, you must have a Bot Creator license and a role that includes the `View my bots` feature permission.

- To view objects in the public workspace, you must be assigned a role that includes the `View my bots` feature permission and the `View content` bot permission to folders in the public workspace.

1. Add the authentication token or bearer token to the request header. You cannot use both in the same API.
2. Use the POST method and endpoint URL: `<control_room_url>/v2/repository/workspaces/{workspaceType}/files/list`

{workspaceType} specifies whether to search in the public or private workspace.

The following example request searches for objects that contain the string **finance** in the name.

Request body:

```
{
  "filter": {
    "operator": "substring",
    "field": "name",
    "value": "finance"
  }
}
```

Supported filterable fields

3. Send the request.

Response body:

In this example response, this endpoint returns a bot with the object `id` of 14277.

```
{
  "page": {
    "offset": 0,
    "total": 1114,
    "totalFilter": 1
  },
  "list": [
    {
      "id": "14277",
      "parentId": "9",
      "name": "financeWeeklyReport",
      "path": "Automation Anywhere\\Bots\\exampleBots",
      "description": "v1",
      "type": "application/vnd.aa.taskbot",
      "size": "799",
      "folder": false,
      "folderCount": "0",
      "productionVersion": "",
      "latestVersion": "",
      "locked": false,
      "lockedBy": "0",
      "createdBy": "22",
      "lastModifiedBy": "22",
      "lastModified": "2020-10-21T17:42:10.140037Z",
      "permission": {
        "delete": false,
        "download": false,
        "upload": false,
        "run": true,
        "publishBotstore": false,
        "viewContent": false,
        "clone": false
      },
      "workspaceId": "0",
      "botStatus": "PUBLIC",
    }
  ]
}
```

```

    "hasErrors": false,
    "workspaceType": "UNKNOWN",
    "metadata": false,
    "uri": "",
    "version": "3",
    "hasTriggers": false,
    "isModified": false
  }
]
}

```

Response parameters:

- `id`: a unique numeric identifier for the object that matches the search parameters.
- `parentId`: a unique numeric identifier for the parent folder.
- `folder`: a boolean value that returns `true` if the object is a folder and `false` if it is a bot or other file.

The REST API responds to each request with an HTTP response code. For details about the response codes, see [API response codes](#).

If you are performing the steps to run a bot or to create an automation schedule, perform this task: [List available unattended Bot Runners API](#)

Get Immediate Parents API

Use this API to get the immediate parents of a Task Bot. The Get Immediate Parents API gets a `fileId` as input and lists the immediate parent details.

Request

```
GET http://{{ControlRoomURL}}/v2/repository/files/{fileid}/parents
```

```
Header: X-Authorization: <<authentication token>> or Authorization: Bearer <<bearer token>>
```

All API calls must contain either an authentication token from [Authentication API](#) (generates JSON Web token) or a bearer token from OAuth services. You cannot use both together in an API.

Request Parameters

Parameter	Type	Required	Description
fileid	Integer	Yes	File id for which you want to view the parents.

```
GET http://{{ControlRoomURL}}/v2/repository/files/698/parents
```

Response

```
{
  "dependencies": [
    {
      "id": "349",
      "name": "Parent",
      "path": "Automation Anywhere\\Bots\\demo_test\\Parent",
      "size": "1536",
      "type": "application/vnd.aa.taskbot",
      "dependencyType": "SCANNED",
      "url": "",
      "requiredByFileId": "349",
      "version": "0",
      "lockedBy": "0",
      "botStatus": "PUBLIC",
      "permission": {
        "delete": true,
        "download": true,
        "upload": true,
        "run": true,
        "publishBotstore": false,
        "viewContent": true,
        "clone": true,
        "editContent": false,
        "createFolder": false,
        "move": false,
        "cancelCheckout": false,
        "revertCheckout": false,
        "viewHistory": false,
        "labelBots": false
      },
      "versionNumber": "0",
      "label": ""
    }
  ]
}
```

Response Parameters

Parameter	Type	Description
id	Integer	File Id of the parent.
name	String	Name of the parent.
path	String	Path of the parent file.
size	Integer	Size of the parent file.
type	String	Type of the parent.

Parameter	Type	Description
dependencyType	String	The type of the related object. <ul style="list-style-type: none"> NONE: It is the relation with the parent file. Parent to parent relation. SCANNED: It is the relation with the child bots or files which are scanned and found automatically. MANUAL: It is the relation with the bots or files that are added to the parent bot manually.
url	String	Not pertinent to this API.
requiredByFileId	Integer	The Id of the parent bot that is calling the child bot.
version	Integer	Version of the parent file.
lockedBy	Integer	The user that has checked out this file.
botStatus	String	<i>bot</i> status. Possible values can be: NEW, CHECKED_OUT, CLONED, and PUBLIC.
permission	Object	Lists all the permissions of the parent.

Delete file/folder API

Use this API to delete objects (bots, files, or folders) from the public or your private workspace.

Note: You can view the in the , but API functionality is limited. You need a licensed Edition to access the full functionality of the APIs.

- All API calls must contain either an authentication token from [Authentication API](#) (generates JSON Web token) or a bearer token from OAuth services. You cannot use both together in an API.
 - You can delete bots, files, or folders from your private workspace. To delete objects from the public workspace, you must be assigned a role that contains the `Delete` bot permission on the folder that contains the objects that you want to delete.
 - If you are deleting a folder, ensure that it is empty. Only empty folders can be deleted.
 - To delete a file or folder, you must provide the object ID. Use one of the Repository Management list APIs to retrieve the object ID. [Choosing a Repository Management list API](#)
- Add the authentication token or bearer token to the request header. You cannot use both in the same API.
 - Use the DELETE method and endpoint URL: `<control_room_URL>/v2/repository/files/{id}`
{id} is the object id of the file or folder that you want to delete.

3. Send the request.

Response body: A successful request returns the following message

```
204 Successful delete
```

The REST API responds to each request with an HTTP response code. For details about the response codes, see [API response codes](#).

File dependencies

Use the `Get file dependencies` API to view all the dependencies for a particular file in the Control Room workspace.

Request

```
GET https://{ControlRoomURL}/v2/repository/files/{fileid}/dependencies
```

```
Header: X-Authorization: <<authentication token>> or Authorization: Bearer <<bearer token>>
```

All API calls must contain either an authentication token from [Authentication API](#) (generates JSON Web token) or a bearer token from OAuth services. You cannot use both together in an API.

Request parameters

Parameter	Type	Required	Description
file ID	Integer	Yes	Enter the unique ID of the file.

Response

```
200 OK
```

```
{
  "dependencies": [
    {
      "id": "1008",
      "name": "sample.txt",
      "path": "Automation Anywhere\\\\\\\\Bots\\\\\\\\Example_bots\\\\\\\\sample.txt",
      "size": "72",
      "type": "text/plain",
      "dependencyType": "NONE",
      "url": "https://contorlroom.com/v1/repository/97/1008/download?
version=latest",
      "requiredByFileId": "0",
      "lockedBy": "0",
      "botStatus": "New",
      "permission": {
        "delete": true,
        "download": true,
```



```

    "clone": true,
    "upload": true,
    "run": true,
    "viewContent": true,
    "publishBotstore": true,
    "editContent": true,
    "createFolder": true,
    "move": true,
    "cancelCheckout": true,
    "revertCheckout": true,
    "viewHistory": true,
    "labelBots": true
  },
  "versionNumber": "0",
  "label": null
}
]
}

```

Response parameters

Parameter	Type	Description
dependencies	Array	Lists the dependencies associated with the file. The parameters mentioned below are a subset of the dependencies.
Dependencies objects		
id	Integer	Unique identifier representing the file.
name	String	Name of the file created.
path	String	Path of the file in the repository.
size	Integer	Size of the file. Only available in case the item type is file.
type	String	The content type, also known as MIME type, of the file. Indicates whether the file type is text or plain.
dependencyType	String	Dependency type of the file with another file or folder.
URL	String	URL of the bot or file.
requiredByFileId	String	Parent file or folder ID.
lockedBy	String	User ID who has locked the file. Only available if the item type is bot and VCS is ON.
botStatus	String	Status of the bot [Public/Checkout/New/Clone].

Parameter	Type	Description
permission	Object	Permissions associated with the logged-in user to delete, download, clone, upload, run, view content, and other actions for the file.
versionNumber	String	Version number of the file.
label	String	Label associated with the file.

Note: You can view the in the , but API functionality is limited. You need a licensed Edition to access the full functionality of the APIs.

The REST API responds to each request with an HTTP response code. For response codes, see [API response codes](#).

Update file dependencies

Use the `Update File dependencies` API to update the manual dependencies of a file. You can update the dependencies for files that are residing only in the private workspace.

Request

```
PUT https://{ControlRoomURL}/v2/repository/files/{fileid}/dependencies/
{workspaceId}
```

```
Header: X-Authorization: <<authentication token>> or Authorization: Bearer
<<bearer token>>
```

All API calls must contain either an authentication token from [Authentication API](#) (generates JSON Web token) or a bearer token from OAuth services. You cannot use both together in an API.

Request parameters

You must specify the file ID and your private workspace ID to update the dependencies.

```
{
  "childFileIds": [1042, 1048]
}
```

Parameter	Type	Required	Description
file ID	Integer	Yes	Enter the unique ID of the file.
workspaceId	Integer	Yes	Enter the unique private workspace ID.
childFileIds	Array	Yes	Array of integers indicating the child file IDs that must be added as a dependency to the specified parent file ID.

Response

```
200 OK
```

Note: You can view the in the , but API functionality is limited. You need a licensed Edition to access the full functionality of the APIs.

The REST API responds to each request with an HTTP response code. For response codes, see [API response codes](#).

Bot Insight API

Users with the `AAE_Bot_Insight_Admin` or `AAE_Admin` role and the `Bot_Insight` license can access the Bot Insight API to retrieve business and operations data.

Automation Anywhere bots are built, run, and monitored in the Control Room. Bot Insight accesses real-time business insights and digital workforce performance data to use content-level productivity data from the bots that are deployed.

Business data

The Business data endpoints return Bot Insight data retrieved from deployed bots.

- [Delete task log data](#)

Delete the business data that is logged in the Bot Insight database on a deployed bot.

```
DELETE /v2/botinsight/data/api/deletetasklogdata
```

- [Get bot variables data](#)

Retrieve information about the variables in deployed bots, such as the variable name, data type, minimum value, and maximum value.

```
GET /v2/botinsight/data/api/gettaskvariableprofile
```

- [Get task log data](#)

Use the get task log data to retrieve the analytical variables data that is logged during a bot run.

```
GET /v2/botinsight/data/api/gettasklogdata
```

Operations data

The Operations data endpoints return information about bots that were deployed to Bot Runner devices. You can use this information to enhance productivity and take measures based on real-time information for RPA deployments.

- [Get audit trail data](#)

Retrieve information about Control Room events.

```
GET /v2/botinsight/data/api/getaudittraildata
```

- [Get bot run data](#)

Retrieve information about a bot run, such as the server information and whether it ran successfully or encountered an error.

```
GET /v2/botinsight/data/api/getbotrundata
```

Get task log data

Use the get task log data to retrieve the analytical variables data that is logged during a bot run.

Request

```
GET https://{{ControlRoomURL}}/v2/botinsight/data/api/gettasklogdata?
botname=ATMReconciliation&fromdate=2022-07-04T00%3A00%3A00&todate=2022-07-07T23%3A59%3A
```

```
Header: X-Authorization: <<authentication token>> or Authorization: Bearer
<<bearer token>>
```

All API calls must contain either an authentication token from [Authentication API](#) (generates JSON Web token) or a bearer token from OAuth services. You cannot use both together in an API.

The URL includes the example query parameter botname. For large datasets, use the pageno and limit parameters to avoid a timeout error.

- You must have the **AAE_Bot Insight Admin** role and the Bot Insight license.
- The bot must run at least for one time with the Bot Creator (Private workspace).
- The bot must be checked in and deployed to the public workspace.

Request Parameters

Parameter	Type	Required	Description
botname	string	No	Name of the bots for which you retrieve data Enter up to 10 bot names and separate each name with a comma. If you do not provide this parameter, the API will return data on all the bots.
pageno	integer	No	Page number from which to retrieve the data

Parameter	Type	Required	Description
limit	integer	No	<p>Specifies the number of parts in which the information is retrieved</p> <p>For example, if you specify the limit as 2500 to retrieve a total of 10000 records, then the information retrieved is as follows:</p> <ul style="list-style-type: none"> • 0 page returns 1 - 2500 • 1st page returns 2501 - 5000 • 2nd page returns 5001 - 7500 • 3rd page returns 7501 - 10000 • Min value: 1
fromdate	date	No	<p>Start date of the period for which to retrieve the data</p> <p>If you do not provide this parameter, the API will return all available data.</p> <p>Format: <code>yyyy-mm-ddThh:mm:ss</code>.</p>
todate	date	No	<p>End date of the period for which to retrieve the data</p> <ul style="list-style-type: none"> • Format: <code>yyyy-mm-ddThh:mm:ss</code> • Default: current date

Note: View the migration status using the [List migration results API](#).

Response

This response example contains data on the *ATMReconciliation* bot and the first record returned.

```
{
  "businessData": [
    {
      "totalRecords": 1,
      "count": 1,
      "pageNo": 1,
      "botId": "PROD_581",
      "botName": "ATMReconciliation",
      "repositoryPath": "repository:///Automation%20Anywhere/Bots/Gettasklogdata?fileId=580&workspace=PRIVATE&version=0&label=",
      "list": [
        {
          "transactionName": "Default",
          "transactions": [
            {
              "runId": "e29732ad-5339-4012-941b-e9a1eb47806c_1a82fe211fc8865e",
              "transactionId": "2bda3a08-3049-4147-9e2b-8dc9dd8d7665",
              "dateLogged": "2022-07-06T10:33:11",
              "variables": {
```

```

    "variable1": "123.0",
    "variable3": "789.0",
    "variable2": "456.0"
  }
}
]
}
]
}
]
}
}

```

The REST API responds to each request with an HTTP response code. For response codes, see [API response codes](#).

Response Parameters

Parameter	Type	Description
runId	String	Identifier for the bot run that retrieved this data. All the transactions in a single run have a common <code>runId</code> .
transactionId	String	Identifier for the data set that was retrieved in a single loop iteration.
dateLogged	date	Date and time the bot retrieved the data. Format: <code>yyyy-mm-ddThh:mm:ss</code>
variables	Any	Variable names and values.

Note: You can view the in the , but API functionality is limited. You need a licensed Edition to access the full functionality of the APIs.

Delete task log data

Delete the business data that is logged in the Bot Insight database on a deployed bot.

Note: You can view the in the , but API functionality is limited. You need a licensed Edition to access the full functionality of the APIs.

- All API calls must contain either an authentication token from [Authentication API](#) (generates JSON Web token) or a bearer token from OAuth services. You cannot use both together in an API.
- You must have the **AAE_Bot Insight Admin** role and the Bot Insight license.

To delete data from the Bot Insight database, you provide the following information to the API in the request body:

Parameter	Required	Type	Description
botname	yes	string	Name of the bot for which you retrieve data
repositorypath	yes	string	Control Room repository path of the bot
environment	yes	string	Specifies the environment: DEV or PROD

Parameter	Required	Type	Description
runId	no	string	ID number that is generated when the bot runs. Use the get task log data to retrieve the runId: Get task log data.
fromDate	no	date	Start date of the period for which to retrieve the data Format: yyyy-mm-ddThh:mm:ss If you do not provide this parameter, the API will return all available data. <hr/> Note: Do not provide this parameter if you provide the runId parameter.
toDate	no	date	End date of the period for which to retrieve the data <ul style="list-style-type: none">Format: yyyy-mm-ddThh:mm:ssDefault: current date <hr/> Note: Do not provide this parameter if you provide the runId parameter.

1. Add the authentication token or bearer token to the request header. You cannot use both in the same API.
2. Use the DELETE method and endpoint URL:<control_room_url>/v2/botinsight/data/api/deletetasklogdata

Request body:

```
{
  "botName": "AnalyticsMortgageProcessing",
  "runId": "a4e706f2-6806-49eb-8d8f-4b915f9a67b0_aaa8b68b1ef888a0",
  "repositoryPath": "repository:///Automation%20Anywhere/Bots/
folder8092/AnalyticsMortgageProcessing?fileId=40642&workspace=PRIVATE",
  "environment": "Prod"
}
```

3. Send the request.

Response body: This example response returns the one thousand rows of data that were deleted.

```
{
  "botName": "AnalyticsMortgageProcessing",
  "repositoryPath": "repository:///Automation%20Anywhere/Bots/
folder8092/AnalyticsMortgageProcessing?fileId=40642&workspace=PRIVATE",
  "deleteCount": 1000
}
```

The REST API responds to each request with an HTTP response code. For response codes, see [API response codes](#).

Get bot run data

Retrieve information about a bot run, such as the server information and whether it ran successfully or encountered an error.

Request

```
GET http://{{ControlRoomURL}}/v2/botinsight/data/api/getbotrundata?
pageno={pageno}&limit={limit}&fromDate={fromDate}&toDate={toDate}
```

```
Header: X-Authorization: <<authentication token>> or Authorization: Bearer
<<bearer token>>
```

- All API calls must contain either an authentication token from [Authentication API](#) (generates JSON Web token) or a bearer token from OAuth services. You cannot use both together in an API.
- To view the bot run data, you must have one of the following:
 - **AAE_BOT_INSIGHT_ADMIN** role
 - ANALYTICSCCLIENT_VALUE license along with **AAE_ADMIN** role

Request parameters

Parameter	Type	Required	Description
pageno	Integer	No	The page number of the Bot Run Data that you want to retrieve.
limit	Integer	No	Limits the number of results returned. Defaults to 1000. For example, if you specify the limit as 2500 to retrieve a total of 10000 records, then the information retrieved is as follows: <ul style="list-style-type: none"> • 0 page returns 1 - 2500 • 1st page returns 2501 - 5000 • 2nd page returns 5001 - 7500 • 3rd page returns 7501 - 10000

Parameter	Type	Required	Description
fromDate	String	No	<p>The starting timestamp for the date range.</p> <p>If you do not provide this parameter, the API will return all available data.</p> <p>Format: yyyy-mm-ddThh:mm:ss</p>
toDate	String	No	<p>The ending timestamp for the date range.</p> <ul style="list-style-type: none"> Format: yyyy-mm-ddThh:mm:ss Default: current date

```
GET http://{{ControlRoomURL}}/v2/botinsight/data/api/getbotrundata?
pageno=1&limit=2&fromDate=2022-01-27T00%3A30%3A00Z&toDate=2022-02-27T06%3A30%3A00Z
```

Response

```
{
  "totalRecords":2,
  "botRunDataList":[
    {
      "id":60,
      "userName":"runner",
      "hostName":"WIN-MT6N77BI0C2",
      "fileName":"newtestbot27",
      "fileType":"RUN_NOW",
      "startDate":"2022-01-27T06:36:36Z",
      "endDate":"2022-01-27T06:36:36Z",
      "status":"FAILED",
      "totalLines":3,
      "currentLine":3,
      "timeTaken":1852,
      "progress":100
    },
    {
      "id":30,
      "userName":"runner",
      "hostName":"WIN-MT6N77BI0C2",
      "fileName":"Blm_test_bot",
      "fileType":"RUN_NOW",
      "startDate":"2022-01-28T11:33:25Z",
      "endDate":"2022-01-28T11:33:26Z",
      "status":"COMPLETED",
      "totalLines":3,
      "currentLine":3,
      "timeTaken":1820,
      "progress":100
    }
  ]
}
```

```
]
}
```

Response Parameters

Parameter	Type	Description
totalRecords	Integer	Total Records that has been retrieved as part of the request.
botRunDataList	Array	The array of Bot Run Data objects.
botRunDataList Object		
id	Integer	The bot run unique Id for the particular run.
userName	String	The user name of the user who is running the bot.
hostName	String	The host name.
fileName	String	Bot file name.
fileType	String	File Type associated to this bot. Following are the possible values for <ul style="list-style-type: none"> • WORKORDER: Depicts the status of the workitems uploaded from t • WLM_TASK: A Workload management bot • EXPORT: Bot export • API: A bot that is run from an API • AARI: A process bot • RUN_NOW: A run as a users bot • SCHEDULED: A scheduled bot • TRIGGER: A triggered bot • AUDIT_EXPORT: Audit export • QUEUE_EXPORT: Queue export • QUEUE_IMPORT: Queue import • WORKITEM_EXPORT: List of workitems export in CSV
startDate	String	The date and time of when this bot started.
endDate	String	The date and time of when this bot ended.
status	String	The status of the bot. Following values are possible: <ul style="list-style-type: none"> • COMPLETED: bot successfully completed execution. • DEPLOYED: auto-login is successful and bot is deployed to a device • DEPLOY_FAILED: bot failed to deploy to the device. For example failed. • QUEUED: requested user or device is busy running another execut • PENDING_EXECUTION: device has been selected, but bot has no deployed to that device. • RUNNING or UPDATE: bot is executing on a device. • RUN_FAILED: bot failed after being deployed to a device. • RUN_PAUSED: user paused the bot. • RUN_TIMED_OUT: bot failed to complete tasks within a specific ti • UNKNOWN: connection between the service and the device was los
totalLines	Integer	Total number of command lines the bot contains.

Parameter	Type	Description
currentLine	Integer	The current line the bot is processing.
timeTaken	Integer	Time taken in milliseconds by the bot to complete the operation.
progress	Integer	The progress of the bot in percentage.

Note: You can view the in the , but API functionality is limited. You need a licensed Edition to access the full functionality of the APIs.

The REST API responds to each request with an HTTP response code. For response codes, see [API response codes](#).

Get Bot Insight audit trail data

Retrieve information about Control Room events.

Note: You can view the in the , but API functionality is limited. You need a licensed Edition to access the full functionality of the APIs.

- All API calls must contain either an authentication token from [Authentication API](#) (generates JSON Web token) or a bearer token from OAuth services. You cannot use both together in an API.
- You must have the **AAE_Admin** role or a custom role with the `View everyone's audit log actions` permission.

To retrieve information about Control Room events, you provide the following query parameters to the API:

Parameter	Required	Type	Description
pageno	no	integer	Page number from which to retrieve the data
limit	no	integer	Specifies the number of parts in which the information is retrieved For example, if you specify the limit as 2500 to retrieve a total of 10000 records, then the information retrieved is as follows: <ul style="list-style-type: none"> • 0 page returns 1 - 2500 • 1st page returns 2501 - 5000 • 2nd page returns 5001 - 7500 • 3rd page returns 7501 - 10000
fromDate	no	date	Start date of the period for which to retrieve the data If you do not provide this parameter, the API will return all available data. Format: <code>yyyy-mm-ddThh:mm:ss</code>

Parameter	Required	Type	Description
toDate	no	date	End date of the period for which to retrieve the data. <ul style="list-style-type: none"> Format: yyyy-mm-ddThh:mm:ss Default: current date

1. Add the authentication token or bearer token to the request header. You cannot use both in the same API.
2. Use the GET method and endpoint URL:<control_room_URL>/v2/botinsight/data/api/getaudittraildata
3. Send the request.

Response body:

```
{
  "totalRecords": 10000,
  "auditTrailDataList": [
    {
      "activityType": "BI_LOAD_DASHBOARD",
      "createdBy": 1121,
      "createdOn": "2021-01-11T11:15:06Z",
      "detail": {},
      "environmentName": "DEV",
      "eventDescription": "BI Load Dashboard",
      "hostName": "192.xxx.xxx.xxx",
      "id": "AnalyticsMortgageProcessing",
      "objectName": "N/A",
      "requestId": "f36e040e-02a6-4fae-8415-9ff57067b7a3",
      "source": "Bot Insight",
      "status": "Successful",
      "userName": "ram"
    },
    // The remaining data is omitted from this code example.
  ]
}
```

The REST API responds to each request with an HTTP response code. For response codes, see [API response codes](#).

Get bot variables data

Retrieve information about the variables in deployed bots, such as the variable name, data type, minimum value, and maximum value.

Note: You can view the in the , but API functionality is limited. You need a licensed Edition to access the full functionality of the APIs.

- All API calls must contain either an authentication token from [Authentication API](#) (generates JSON Web token) or a bearer token from OAuth services. You cannot use both together in an API.
- You must have the **AAE_Bot Insight Admin** role and the Bot Insight license.
- The bot must be checked into the public workspace.
- You must publish at least one dashboard to get the results using this API.

To retrieve information about the variables in a deployed bot, you provide the following query parameters to the API:

Parameter	Required	Type	Description
botname	no	string	Name of the bot for which data is retrieved
repositorypath	no	string	Control Room repository path of the bot

1. Add the authentication token or bearer token to the request header. You cannot use both in the same API.
2. Use the GET method and endpoint URL:<control_room_URL>/v2/botinsight/data/api/gettaskvariableprofile
3. Send the request.

Response body: This response example contains data on the AnalyticsMortgageProcessing bot and the first record returned. To keep this block of code short, the remaining data is omitted.

```
{
  "dataProfiles": [
    {
      "botId": "PROD_40642",
      "botName": "AnalyticsMortgageProcessing",
      "standardDashboardName": "",
      "profileVariables": [
        {
          "variableName": "state",
          "displayName": "State",
          "attributeType": "US_STATE_CODE",
          "sumOfValue": 0.0,
          "minimumValue": "",
          "maximumValue": "",
          "averageOfValues": 0.0,
          "totalDistinct": "53",
          "enabled": "Y",
          "isTransactionVariable": ""
        }
      ],
      // The remaining data is omitted from this code example.
    }
  ]
}
```

The REST API responds to each request with an HTTP response code. For response codes, see [API response codes](#).

Bot Lifecycle Management API

Use the Bot Lifecycle Management API to export and import bots with dependent files and command packages for comprehensive automation lifecycle management. Users can export bots from public workspace and import to a private workspace in another Control Room and check into a public workspace.

Note: You can view the in the , but API functionality is limited. You need a licensed Edition to access the full functionality of the APIs.

Overview

You can use the Control Room Export and Import REST API to manage your automation TaskBots, including dependent files in different environments such as development, testing, and production based on your organization's automation requirements.

For example, you can move bots that are verified as production-ready from test to production.

Import Enterprise 11 bots in Automation 360 for migration

The Bot Lifecycle Management import feature also support to import your Enterprise 11 bots from Enterprise 11 Control Room instance to Automation 360. This enables you to consolidate the Enterprise 11 bots from multiple Control Room repository in a single Automation 360 repository.

Permissions required to move bots

To export bots from the Control Room, you must have the following permissions:

- **Export bot** and **View packages** feature permissions
- **Check in** or **Check out** folder permissions

To import bots to the Control Room, you must have the following permissions:

- **Import bot** and **Manage package** feature permissions
- **Check in** folder permission
- Bot Creator license

Moving a bot

To move a bot from one environment to another, follow these steps:

1. Use the Export API to export the bot from the Control Room in the source environment.
[Export files using API](#)
2. Use the Import API to import the bot into the Control Room in the destination environment.
[Import files using API](#)

Related concepts

[Bot Lifecycle Management](#)

The Bot Lifecycle Management feature enables you to move a bot from one environment to another. For example, you can move a bot from the development or testing environment to the production environment.

Export files using API

You can export bots with their dependent files using the Export API.

Note: You can view the in the , but API functionality is limited. You need a licensed Edition to access the full functionality of the APIs.

- You must have Export bots, View package, and Check in or Check out permissions to the required folders.
- All API calls must contain either an authentication token from [Authentication API](#) (generates JSON Web token) or a bearer token from OAuth services. You cannot use both together in an API.
- A file ID of the bot you want to export from the public folder.

[List files and folders by workspace API](#)

Note: Users can only view the folders and subfolders they have permissions to access.

- The following API URLs:
 - `https://<your_control_room_url>/v2/blm/export`: To export repository bots
 - `https://<your_control_room_url>/v2/blm/status/{requestId}`: To get export status by request ID
 - `https://<your_control_room_url>/v2/blm/download/{downloadFileId}`: To download the exported bot

1. Add the authentication token or bearer token to the request header. You cannot use both in the same API.

2. Search for one or more file IDs of the bot you want to export.

3. Use the POST method and endpoint URL: `https://<your_control_room_url>/v2/blm/export`.

The following example request body, exports the bot with `fileId` 2197 along with the packages required for bot.

Request body:

```
{
  "name": "export-docs",
  "fileIds": [
    2197
  ],
  "includePackages": true
}
```

4. Send the request.

The following response body returns the `requestId`.

Response body:

```
{
  "requestId": "987c0de3-b158-4e71-975e-27d10b9a83fb"
}
```

5. Use the GET method and endpoint URL: `<your_control_room_url>/v2/blm/status/{requestId}`

Enter the `requestId` generated in Step 4 to know the status of export.

```
https://192.0.2.0/v2/blm/status/987c0de3-b158-4e71-975e-27d10b9a83fb
```

6. Send the request.

The following response body returns the `status` and `downloadFileId`.

Response body:

```
{
  "requestId": "987c0de3-b158-4e71-975e-27d10b9a83fb",
  "type": "EXPORT",
  "status": "COMPLETED",
  "downloadFileName": "export-docs",
  "downloadFileId": "ZXhwb3J0LWRvY3M=",
  "errorMessage": ""
}
```

- Use the GET method and endpoint URL: `<your_control_room_url>/v2/blm/download/{downloadFileId}`

Enter the `downloadFileId` generated in Step 6.

```
https://192.0.2.0/v2/blm/download/ZXhwb3J0LWRvY3M=
```

- Send the request.
The dialog box appears. Browse the path and save the exported package in zip file format.
The REST API responds to each request with an HTTP response code. For response codes, see [API response codes](#).

Import the exported file in the private folder of the target Control Room.

Related tasks

Export bots

You can export a bot from one Control Room to another.

Import files using API

You can import bots with their dependent files using the Import API.

Note: You can view the in the , but API functionality is limited. You need a licensed Edition to access the full functionality of the APIs.

- You must have following permissions and licenses:
 - Import bots
 - Manage package
 - Check in permissions to the necessary folders to import bots in the public workspace
 - Bot Creator license to import bots in the private workspace
- All API calls must contain either an authentication token from [Authentication API](#) (generates JSON Web token) or a bearer token from OAuth services. You cannot use both together in an API.
- The following API URLs:
 - `https://<your_control_room_url>/v2/blm/import`: To import repository bot
 - `https://<your_control_room_url>/v2/blm/status/{requestId}`: To get import status by request ID
- To import the Enterprise 11 bots into your Control Room, you must have the required `aapkg` package that you created using the Bot Lifecycle Management Export API in the Enterprise 11 Control Room instance.

The `aapkg` package must be present in the same Automation 360 machine where you want to import the Enterprise 11 bots.

You can import the password-protected `aapkg` packages using the Import API only.

- Add the authentication token or bearer token to the request header. You cannot use both in the same API.

2. Use the POST method and endpoint URL: `https://<your_control_room_url>/v2/blm/import`.

Provide the following parameters for the request header.

- `upload`: Choose the required zip file that you want to import in your Control Room.
Choose the required `aapkg` file to import Enterprise 11 bots to your Control Room.
- `actionIfExists`: Select either the `SKIP` or `OVERWRITE` option if the file you are importing already exists.
- `publicWorkspace`: This is a Boolean value. Select either `true` or `false`. Enter `true` if you want to import the file to the public workspace.

3. Send the request.
The following response body returns `requestId`.

Response body:

```
{
  "requestId": "eafef543-2d7a-47f5-81d0-490d09dd68d2"
}
```

4. Use the GET method and endpoint URL: `<your_control_room_url>/v2/blm/status/{requestId}`

Enter the `requestId` generated in Step 3 to know the status of import.

5. Send the request.
The following response body returns the `status`.

Response body:

```
{
  "requestId": "fa4b0c56-fab8-42ef-8d96-fc6b53e1cbaa",
  "type": "IMPORT",
  "status": "COMPLETED",
  "downloadFileName": "",
  "downloadFileId": "",
  "errorMessage": ""
}
```

The `COMPLETED` status indicates that the file is successfully imported. You can find the imported file in your Control Room

Enterprise 11 bots migration:

- a. The Enterprise 11 bots are imported in the **Bots > My Tasks** folder or **Bots > My Metabots** folder in the `.atmx` or `.mbot` file format.
- b. Use the migration wizard to convert the Enterprise 11 bots files into the `.bot` format that is supported in Automation 360.

The REST API responds to each request with an HTTP response code. For response codes, see [API response codes](#).

Related tasks

[Import bots](#)

You can import bots with their dependencies from one Control Room to another. The source environment can be Automation 360 Control Room, Enterprise 11, or Enterprise 10 Control Room instance.

Device pool API

Identify all available device pools or filter device pools by name. Retrieve detailed device pool information for a device by searching for its unique numeric identifier (ID).

A device pool is a logical grouping of devices used by a Bot Runner to distribute and manage the running of unattended bots.

Note: You can view the in the , but API functionality is limited. You need a licensed Edition to access the full functionality of the APIs.

List device pools API

List all available device pools in your Control Room, or filter the list by the name of the device pool.

Note: You can view the in the , but API functionality is limited. You need a licensed Edition to access the full functionality of the APIs.

- All API calls must contain either an authentication token from [Authentication API](#) (generates JSON Web token) or a bearer token from OAuth services. You cannot use both together in an API.
- You must be assigned a role that includes the `View and manage all devices` permission.

This task searches for all device pools that contain the string **finance** in the name.

1. Add the authentication token or bearer token to the request header. You cannot use both in the same API.
2. Use the POST and endpoint URL: `<your_control_room_url>/v2/devices/pools/list`.

```
{
  "filter": {
    "operator": "substring",
    "field": "name",
    "value": "finance"
  }
}
```

[Filtering, pagination, and sorting](#)

3. Send the request.

Response body:

```
{
  "page": {
    "offset": 0,
    "total": 15,
    "totalFilter": 1
  },
  "list": [
    {
      "id": "27",
      "name": "finance-device-pool",
      "status": "CONNECTED",
      "detailedStatus": "ALL_DISCONNECTED",
    }
  ]
}
```

```

    "automationCount": "0",
    "ownerIds": [
      "48"
    ],
    "deviceCount": "3"
  }
]
}

```

A successful response lists one or more device pools. Use the ID of a device pool to view the details.

Retrieve details of device pool by ID

If you are performing the steps to run a bot perform this task: [Bot deployment - V3](#)

If you are performing the steps to create an automation schedule perform this task: [Schedule bot to run API](#)

Retrieve details of device pool by ID

Retrieve the details of a specific device pool by its numeric identifier (ID).

Note: You can view the in the , but API functionality is limited. You need a licensed Edition to access the full functionality of the APIs.

Ensure you have the following to use this API:

- View and manage ALL device(s): View and manage all the devices, including devices registered by other users.
- All API calls must contain either an authentication token from [Authentication API](#) (generates JSON Web token) or a bearer token from OAuth services. You cannot use both together in an API.
- Device pool id: The unique numeric identifier of the device pool for which you want to retrieve details.

This task searches in the Control Room for a specific device pool. The API passes the device pool {id} as part of the URL string. No request body is required.

1. Add the authentication token or bearer token to the request header. You cannot use both in the same API.

[Authentication API](#)

2. Use the GET method and endpoint URL: <your_control_room_url>/v2/devices/pools/{id}. Enter the device pool ID in the URL.

In this example, the device pool ID is **27**.

```
https://<your_control_room_url>/v2/devices/pools/27
```

3. Send the request.

When the request is successful, all the details associated with the passed device pools ID are returned in response body.

In this example, the name, automation scheme, status, Bot Runners, owners, and consumers, associated with the device pool ID **27** are returned in the response body

Response body:

```

{
  "id": "27",
  "name": "finance-device-pool",
  "description": "Finance department device pool",
  "automationScheme": "ROUND_ROBIN",

```

```

"status": "CONNECTED",
"timeSlice": "5",
"timeSliceUnit": "MINUTES",
"deviceIds": [
  "10",
  "23",
  "41"
],
"ownerIds": [
  "48"
],
"consumerIds": [],
"detailedStatus": "ALL_DISCONNECTED",
"updatedBy": "48",
"updatedOn": "2020-04-27T14:29:05.655896Z",
"createdBy": "48",
"createdOn": "2020-04-25T10:46:44.642586Z",
"tenantUuid": "c0a8f10a-717f-130b-8171-7f4762280000",
"tenantId": "4"
}

```

Review the details of the listed device pool to determine if it meets your bot deployment requirements. Some of the fields in the response are used as input to other APIs.

Evaluate these details:

id	The id uniquely identifies this device pool in the Control Room. Use this id as input for the poolIds for bot deployment. <i>Bot deployment - V3</i>
name	This is the user-defined name for the device pool. Filter the device pool name using filters in the list device pools task. <i>List device pools API</i>
deviceIds	List of the unique numeric IDs for Bot Runner devices that are part of this device pool.
ownerIds	The IDs of the owners of this device pool. Device pool owners can view, edit, or delete the device pool.
consumerIds	The IDs for users who can view this device while running automations.

The REST API responds to each request with an HTTP response code. For response codes, see [API response codes](#).

Create device pool API

Device pools are a logical grouping of devices or similar Bot Runner machines on which you can run your workload management automations or scheduled automations. Create a device pool using an API with a unique name and add unattended Bot Runners to the device pool.

Note: You can view the in the , but API functionality is limited. You need a licensed Edition to access the full functionality of the APIs.

Ensure you have the following:

- AAE_Pool_Admin role and View and manage ALL device(s) permission
- All API calls must contain either an authentication token from [Authentication API](#) (generates JSON Web token) or a bearer token from OAuth services. You cannot use both together in an API.
- Endpoint URLs:
 - <your_control_room_url>/v2/devices/pools
 - <your_control_room_url>/v2/devices/list

1. Add the authentication token or bearer token to the request header. You cannot use both in the same API.

2. Use the POST method and endpoint URL: <your_control_room_url>/v2/devices/pools.

If you want to search or get a list of all the available **deviceIds**, use the following endpoint URL:

https://<your_control_room_url>/v2/devices/list

[Request device details](#)

For example:

```
POST https://192.0.2.0/v2/devices/pools
```

The this example request body enables you to add automation scheme, unattended Bot Runners, owners, and consumers in the device pool.

Request body:

```
{
  "name": "Finance-device-pool",
  "description": "Pool for Finance RPA",
  "deviceIds": [
    "1",
    "10"
  ],
  "automationScheme": "ROUND_ROBIN",
  "ownerIds": [
    "1",
    "24",
    "26"
  ],
  "consumerIds": [
    "21",
    "22"
  ]
}
```

3. Send the request.

When the request is successful, a unique device pool **id** is returned in the response body. The details of the devices, owners, and consumers associated with the device pool are also provided.

In this example, the response body returns the unique device pool **id** as 4.

Response body:

```
{
  "id": "4",
  "name": "Finance-device-pool",
  "description": "Pool for Finance RPA",
  "automationScheme": "ROUND_ROBIN",
  "status": "CONNECTED",
  "timeSlice": "5",
}
```

```

"timeSliceUnit": "MINUTES",
"deviceIds": [
  "1",
  "10"
],
"ownerIds": [
  "1",
  "24",
  "26"
],
"consumerIds": [
],
"detailedStatus": "SOME_CONNECTED",
"updatedBy": "24",
"updatedOn": "2020-05-26T09:26:54.556280800Z",
"createdBy": "24",
"createdOn": "2020-05-26T09:26:54.556280800Z",
"tenantUuid": "4db5b32c-5c4b-4aee-8ca0-f53ec241563c",
"tenantId": "4"
}

```

The REST API responds to each request with an HTTP response code. For response codes, see [API response codes](#).

If you are performing the steps to [Create workload automation](#), next [Run bot with queue API](#).

If you are performing the steps to [Deploy a bot](#), next [Bot deployment - V3](#).

License API

The License API contains endpoints to retrieve Control Room license details (such as expiration date and license mode) and manually sync the Control Room with the license server after license reallocation or renewal.

Note: You can view the in the , but API functionality is limited. You need a licensed Edition to access the full functionality of the APIs.

Manage licenses

1. [Authenticate the user](#).

Use the POST method to generate an authentication JSON Web Token.

2. [Retrieve Control Room license details API](#).

Retrieve details of the Control Room license, including license type, expiration date, Fail-Safe status, and license server sync status.

3. If the `controlRoomLicenseServerSyncStatus` parameter returns `False`, use the Sync endpoint to update the license allocations and expiration date from the license server.

List the license allocations

1. *Authenticate the user.*

Use the POST method to generate an authentication JSON Web Token.

2. **If the license is cloud-based:** If new licenses were purchased, or if licenses were reallocated between Control Room instances, use the Sync endpoint to update the license allocations and expiration date from the license server.

3. *List Control Room licenses*

Retrieve Control Room metadata including the license type, number of available licenses, number of licenses used in a specific Control Room instance, and number of licenses used in all Control Room instances.

Related reference

[Automation 360 licenses](#)

The **All Licenses** page displays detailed information about current product and device licenses.

Retrieve Control Room license details API

Retrieve details of the Control Room license, including license type, expiration date, Fail-Safe status, and license server sync status.

1. Use the GET method and endpoint URL: `<your_control_room_url>/v2/license/details`.
2. Send the request.

Response body: In a successful request, this endpoint returns the following data:

- `failSafeStatus`: A numerical value that represents the Fail-Safe status of the Cloud Control Room. Values: 0 means the Control Room is connected, 1 means the Control Room is in Fail-Safe mode, and 2 means the Fail-Safe status has expired.

If the Control Room was configured with a file license, the returned value is always 0.

Control Room fail-safe status

- `controlRoomLicenseServerSyncStatus`: A Boolean value that determines whether the license allocations in this Control Room are in sync with the license server.
- `licenseMode`: Whether the Control Room license was configured from a file or through a connection with the license server.

Automation 360 licenses

In this first example response, the `licenseMode` confirms that the Control Room is on a file-based license, thus the `failSafeStatus` is 0 and no value is returned for the `installedCrId`.

```
{
  "type": "PURCHASED",
  "installationDate": "2020-09-09T15:06:05.211Z",
  "expirationDate": "2021-06-30T18:29:59.999Z",
  "failSafeStatus": 0,
  "controlRoomLicenseServerSyncStatus": true,
  "installedCrId": "",
  "licenseMode": "FileLicense"
}
```

In the second example response, the `licenseMode` confirms that the Control Room is on a cloud-based license, the `failSafeStatus` has returned 1, which means that requests to other

Control Room APIs will fail until the connection with the license server is reestablished, and the `controlRoomLicenseServerSyncStatus` has returned `false`.

```
{
  "type": "PURCHASED",
  "installationDate": "2020-09-14T18:30:00Z",
  "expirationDate": "2021-04-27T18:30:00Z",
  "failSafeStatus": 1,
  "controlRoomLicenseServerSyncStatus": false,
  "installedCrId": "b96edac7-b7e3-57bf-b857-ad14ac754674",
  "licenseMode": "CloudLicense"
}
```

The REST API responds to each request with an HTTP response code. For details about the response codes, see [API response codes](#).

If the `controlRoomLicenseServerSyncStatus` parameter returns `False`, use the Sync endpoint to update the license allocations and expiration date from the license server.

List Control Room licenses

Retrieve Control Room metadata including the license type, number of available licenses, number of licenses used in a specific Control Room instance, and number of licenses used in all Control Room instances.

Request

```
POST https://{ControlRoomURL}/v2/license/product/list
```

```
Header: X-Authorization: <<authentication token>> or Authorization: Bearer <<bearer token>>
```

All API calls must contain either an authentication token from [Authentication API](#) (generates JSON Web token) or a bearer token from OAuth services. You cannot use both together in an API.

You can send this API request with or without filter parameters. An API request without any filter parameters specified retrieves the details of all the objects in the Control Room. You can use the filter parameters to retrieve a specific set of file or folder objects instead of fetching all objects in the Control Room. For more information, see [Filtering, pagination, and sorting](#).

Request body without filters:

```
{
  "filter": null,
  "sort": [
    {
      "field": "id",
      "direction": "desc"
    }
  ],
  "page": {
    "offset": 0,
    "length": 100
  }
}
```

Request body with filters:

```

{
  "filter":{
    "operator":"and",
    "operands":[
      {
        "operator":"lt",
        "field":"purchasedCount",
        "value":"31"
      },
      {
        "operator":"gt",
        "field":"usedCountByThisCr",
        "value":3
      }
    ]
  },
  "sort":[
    {
      "field":"id",
      "direction":"asc"
    }
  ],
  "page":{
    "offset":0,
    "length":1000
  }
}

```

Request parameters

Parameter	Type	Required	Description
filter	Object	No	Filters the result based on operator, field, or value. <ul style="list-style-type: none"> operator - Allowed enumerations are NONE, lt, le, eq, ne, ge, gt, substring, and, or, not. field - Allowed values are name, lastModified, path, or folder. value - Specify a value for the name, lastModified, path, or folder that you have selected in the field parameter.
sort	Array	No	By default, search results are sorted in descending order of their IDs. To specify an alternative sorting, use the sort query parameter. Enter the field by which you want to sort along with the direction <code>asc</code> (ascending) or <code>desc</code> (descending).
page	Object	No	The page object allows you to get the desired pages.

Response

200 OK

```

{
  "page": {
    "offset": 0,
    "total": 12,
    "totalFilter": 1
  },
  "list": [
    {
      "id": 64,
      "name": "ControlRoom",
      "feature": {
        "id": 85,
        "name": "Development",
        "enable": true,
        "purchasedCount": 30,
        "usedCountByThisCr": 5,
        "usedCountByAllCr": 5,
        "availableCount": 25,
        "licenseCountUnit": "NUMBER"
      },
      "licenseType": "NONE",
      "productMetrics": [
    ]
  ]
}

```

Response Parameters

Parameter	Type	Description
offset	Integer	The starting list offset, used for pagination.
total	Integer	Total number of records.
totalFilter	Integer	Number of records after applying the filter.
List	Array	The array of List object.
List object		
name	String	Returns the product license name, such as <code>ControlRoom</code> , <code>Analytics</code> , <code>BotFarm</code> , <code>Cognitive</code> , <code>DiscoveryBot</code> , and <code>AutomationAnywhereRoboticInterface</code> .
Feature object		
id	Integer	Unique ID of the feature.
name	String	Returns the device license, such as <code>Development for Bot Creator</code> , <code>Runtime for unattended Bot Runner</code> , and <code>AttendedRuntime for attended Bot Runner licenses</code> .

Parameter	Type	Description
Enable	Boolean	A flag indicating if a license is enabled or disabled. If the returned value is <code>False</code> , that license cannot be assigned to a user.
PurchasedCount	Integer	The total number of licenses purchased.
usedCountByThisCr	Integer	The number of licenses used in this Control Room instance.
usedCountByAllCr	Integer	The total number of licenses that are used. If the license is file-based, this number matches the number in the <code>usedCountByThisCr</code> parameter. If the license is cloud-based, this parameter returns the total number of licenses used in all of the customer's Control Room instances.
availableCount	Integer	The number of licenses that are available for allocation.
licenseType	String	Shows whether the license is purchased or is a trial license.

Note: You can view the in the , but API functionality is limited. You need a licensed Edition to access the full functionality of the APIs.

All API calls must contain either an authentication token from [Authentication API](#) (generates JSON Web token) or a bearer token from OAuth services. You cannot use both together in an API.

Deploy bots using API

Use a combination of endpoints to deploy bots from the public workspace to Bot Runner devices.

Note: You can view the in the , but API functionality is limited. You need a licensed Edition to access the full functionality of the APIs.

Prerequisites to deploy a bot

Ensure that you are allocated the following resources:

- **View and Run my bots** feature permission
- **Run and schedule** permissions for the folders that contain the bots
- Access to Bot Runner licensed users
- Access to either a default device or a device pool

Note: If the user associated with the license has a default device assigned to their account, the deploys on that device. If no default device is assigned, or you want to select a different device, then you must specify a device pool.

Deploy a bot

1. [Authenticate \(username and password\)](#)
2. [List files and folders by workspace API](#)
3. [List available unattended Bot Runners API](#)

4. **Optional:** [List device pools API](#)
5. [Bot deployment - V3](#)
6. [Bot deployment - V4](#)

Related concepts

[User management APIs](#)

Use `User Management` APIs to create, search, update, or delete roles and users in your Control Room.

Related tasks

[List available unattended Bot Runners API](#)

Return a list of available users with unattended Bot Runner licenses. This endpoint returns the user id, which is a numeric value that is used by APIs to identify users.

Bot deployment - V3

As a user with a Bot Runner license, deploy bots on your assigned devices. You can also pass variables to bots when they are deployed.

Request

```
POST https://{{ControlRoomURL}}/v3/automations/deploy
```

```
Header: X-Authorization: <<authentication token>> or Authorization: Bearer
<<bearer token>>
```

All API calls must contain either an authentication token from [Authentication API](#) (generates JSON Web token) or a bearer token from OAuth services. You cannot use both together in an API.

Note: Bot deploy request can be made without any input fields. If you specify inputs, make sure that the bot to successfully receive these mapped in values, the variable for that bot must be marked as input. Additionally, the name of the variable in the bot has to match the value that is being mapped in the request body.

Request body with LIST input:

```
{
  "fileId": 86,
  "runAsUserIds": [
    3
  ],
  "poolIds": [],
  "overrideDefaultDevice": false,
  "callbackInfo": {
    "url": "https://callbackserver.com/storeBotExecutionStatus",
    "headers": {
      "X-Authorization": "{{token}}"
    }
  },
  "botInput": {
    "iTestList": {
      "type": "LIST", //Type can be [ STRING, NUMBER, BOOLEAN, LIST,
      DICTIONARY, DATETIME ]
      "list": [
        { "type":"STRING",
```

```

    "string": "TestValues1"
  },
  { "type": "STRING",
    "string": "TestValues2"
  }
] //key must match type, in this case string
}
}
}

```

Request body with STRING input:

```

{
  "fileId": 87,
  "runAsUserIds": [
    3
  ],
  "poolIds": [],
  "overrideDefaultDevice": false,
  "callbackInfo": {
    "url": "https://eogplyk2wlo3ec2.m.pipedream.net",
    "headers": {
      "X-Authorization": "{{token}}"
    }
  },
  "botInput": {
    "sInput1": {
      "type": "STRING",
      "string": "Test Values1"
    },
    "sInput2": {
      "type": "STRING",
      "string": "Test Values2"
    }
  }
}

```

Request body with NUMBER input:

```

{
  "fileId": 87,
  "runAsUserIds": [
    3
  ],
  "poolIds": [],
  "overrideDefaultDevice": false,
  "callbackInfo": {
    "url": "https://eogplyk2wlo3ec2.m.pipedream.net",
    "headers": {
      "X-Authorization": "{{token}}"
    }
  },
  "botInput": {
    "sInput1": {
      "type": "NUMBER",
      "number": 123
    },
    "sInput2": {
      "type": "NUMBER",
      "number": 345
    }
  }
}

```

```
}

```

Request body with DICTIONARY input:

```
{
  "fileId": 86,
  "runAsUserIds": [
    3
  ],
  "botInput": {
    "iTestList": {
      "type": "DICTIONARY", //Type can be [ STRING, NUMBER, BOOLEAN, LIST,
DICTIONARY, DATETIME ]
      "dictionary": [
        {
          "key": "key1",
          "value": {
            "type": "STRING",
            "string": "value1"
          }
        },
        {
          "key": "key2",
          "value": {
            "type": "STRING",
            "string": "value2"
          }
        }
      ] //key must match type, in this case string
    }
  }
}
```

Request body with DATE TIME input:

```
{
  "fileId": 87,
  "runAsUserIds": [
    3
  ],
  "botInput": {
    "dt_input1": {
      "type": "DATETIME",
      "string": "2022-04-07T00:15:00-06:00[USA/New York]"
    },
    "dt_input2": {
      "type": "DATETIME",
      "string": "2022-04-07T00:15:05-06:00[USA/New York]"
    }
  }
}
```

Request Parameters

Parameter	Type	Required	Description
fileId	Integer	Yes	File Id of bot to be deployed. <i>List files and folders by workspace API</i>

Parameter	Type	Required	Description
automationName	String	No	Name of the automation to be deployed.
runAsUserIds	Integer	Yes	List of runAs user ids to deploy bot. The bot will be deployed on one of the devices provided. <i>List available unattended Bot Runners API</i>
callbackInfo	String	No	<code>callbackInfo</code> provides the callback API URL (For example <code>callbackserver.com/storeBotExecutionStatus</code>) and the token for the callback server. After the bot is deployed, the callback server will return the deployment status and output variable values to this callback URL. To test the callback you can create an account in <i>Pipedream</i> (similar to <code>https://eogp1yk2w1o3ec2.m.pipedream.net</code>) and return the status and the output variable values. Note: The callback server must accept POST calls to receive the deployment status from the Control Room.
poolIds	Integer	No	You will define the <code>poolIds</code> only when you are running the automation on a pool of runners instead of an individual runner. Identifier of at least one active device. If you enter multiple pool IDs, one of which you want the API to check for available devices. If no device is available at the time of deployment, the automation is queued. Note: If the user associated with the license has a default device account, the automation deploys on that device. If no default device is selected, then you must specify a device. <i>List device pools API</i>
overrideDefaultDevice	Boolean	No	If the Bot Runner user is assigned to a default device and a device pool, set this parameter to <code>true</code> . If deploying to the default device, set this parameter to <code>false</code> .
runElevated	Array	No	Whether to deploy the bot using elevated permissions on the device. <code>false, true</code> .
numOfRunAsUsersToUse	Integer	No	Specifies how many Bot Runners to use from the list of runners. The weighted system algorithm selects the Bot Runners with the highest weight. <ul style="list-style-type: none">System will pick the specified number of <code>runAsUserIds</code> from the list of runners tasks queued for the user at the moment of deployment.If 0 then all the users will be used.If the number is greater than the number of <code>runAsUserIds</code> it will error out.
automationPriority	String	No	The automation Priority. By default it is set to <code>PRIORITY_MEDIUM</code> . for <code>automationPriority</code> includes: <code>PRIORITY_MEDIUM</code> , <code>PRIORITY_LOW</code> .
botLabel	String	No	Label for the bot to be deployed.
botInput	Object	No	A data structure containing a botInput Object. See below.

Parameter	Type	Required	Description
botInput Object			
type*	Any	No	By default it is <code>STRING</code> . Possible values for <code>type</code> include <code>BOOLEAN</code> , <code>FILE</code> , <code>ITERATOR</code> , <code>LIST</code> , <code>DICTIONARY</code> , <code>TAB</code> , <code>CONDITIONAL</code> , <code>WINDOW</code> , <code>TASKBOT</code> , <code>DATETIME</code> , <code>UIOBJ</code> , <code>CREDENTIAL</code> , <code>COORDINATE</code> , <code>IMAGE</code> , <code>REGION</code> , <code>PROPER</code> , <code>CONDITIONALGROUP</code> , <code>FORM</code> , <code>FORMELEMENT</code> , <code>HOTKEY</code> ,
*The structure of the input varies depending on the type you want to input. This topic provides you with a few of			

Response

200 OK

For more information on the return codes, see [API response codes](#).

```
{
  "deploymentId": "340a2949-aa44-41ab-af9b-f9343ae2581c",
  "automationName": "Sample-bot-deploy"
}
```

Tip: Check the bot deployment status and the bot output variables using [Activity list](#).

Response Parameters

Parameter	Type	Description
deploymentId	String	The deployment Id created.
automationName	String	Name of the deployed automation. If this name is not supplied in the request, a random name is assigned to the deployed automation.

Note: You can view the response in the `Response` tab, but API functionality is limited. You need a licensed `Enterprise` Edition to access the full functionality of the APIs.

The REST API responds to each request with an HTTP response code. For response codes, see [API response codes](#).

Related tasks

[List available unattended Bot Runners API](#)

Return a list of available users with unattended Bot Runner licenses. This endpoint returns the user id, which is a numeric value that is used by APIs to identify users.

Related reference

[Search for users API](#)

Use the `Search for users` API to search for all users in the Control Room.

[Create user](#)

Use the `Create user` API to create a new user in the Control Room.

[Create role](#)

Use `Create role` API to create a new role with permissions in the Control Room.

Bot deployment - V4

As a user with a Bot Runner license, you can perform either attended or unattended deployments. You can also pass variables to bots when they are deployed.

Request

```
POST https://{{ControlRoomURL}}/v4/automations/deploy
```

```
Header: X-Authorization: <<authentication token>> or Authorization: Bearer <<bearer token>>
```

All API calls must contain either an authentication token from [Authentication API](#) (generates JSON Web token) or a bearer token from OAuth services. You cannot use both together in an API.

Tip: V4 Bot Deploy API has all the functionalities of the V3 Bot Deploy API. The reason V4 Bot Deploy is introduced is to clearly segregate between attended and unattended deployments. The parameters for the attended deployment is different from the unattended deployment parameters. Unlike V3 Bot Deploy API, V4 Bot Deploy API is extendable for any new use cases. It is recommended to use the enhanced V4 Bot Deploy API over the V3 Bot Deploy API.

Note: Bot deployment requests can be made without any input fields. If you specify inputs, make sure that the bot successfully receives these mapped-in values and that the variable for that bot is marked as input. Additionally, the name of the variable in the bot must match the value that is being mapped in the request body.

Request body with LIST input (Attended sample):

```
{
  "botId":21,
  "automationName":"Sample-bot-deploy",
  "deployInput":{
    "attendedRequest":{
      "deploymentDeviceId":1,
      "queueDeployment":false,
      "launchInChildWindow":false
    }
  },
  "runElevated":true,
  "hideBotAgentUi":true,
  "callbackInfo":{
    "url":"https://callbackserver.com/storeBotExecutionStatus",
    "headers":{
      "X-Authorization":"eyJhbGciOiJSUzUxMiJ9.eyJzdWIiOiI0Ii"
    }
  },
  "automationPriority":"PRIORITY_MEDIUM",
  "botInput":{
    "iTestList":{
      "type":"LIST",
      "list":[
        {
          "type":"STRING",
          "string":"TestValues1"
        }
      ]
    }
  }
}
```

```

    },
    {
      "type": "STRING",
      "string": "TestValues2"
    }
  ]
}
}
}

```

Request body with LIST input (Unattended sample)

```

{
  "botId": 21,
  "deployInput": {
    "unattendedRequest": {
      "runAsUserIds": [
        "639"
      ],
      "poolIds": [
      ],
      "deviceUsageType": "RUN_ONLY_ON_DEFAULT_DEVICE"
    }
  },
  "hideBotAgentUi": true,
  "callbackInfo": {
    "url": "https://callbackserver.com/storeBotExecutionStatus",
    "headers": {
      "X-Authorization": "eyJhbGciOiJSUzUxMiJ9.eyJzdWIiOiI0Ii"
    }
  },
  "automationPriority": "PRIORITY_MEDIUM",
  "botInput": {
    "iTestList": {
      "type": "LIST",
      "list": [
        {
          "type": "STRING",
          "string": "TestValues1"
        },
        {
          "type": "STRING",
          "string": "TestValues2"
        }
      ]
    }
  }
}

```

Request parameters

Parameter	Type	Required	Description
botId	Integer	Yes	Bot Id of bot to be deployed. To list all the bot IDs, you can use this API: List files and
automationName	String	No	Name of the automation to be deployed

Parameter	Type	Required	Description
callbackInfo	String	No	<p>callbackInfo provides the callback API URL (for example, <code>callbackserver.com/storeBotExecutionStatus</code>) and the token for the callback server. After the bot is deployed, the deployment status and output variable values to this callback. To test the callback, you can create an account in Pipedrive (similar to <code>https://eogp1yk2w1o3ec2.m.pipedrive.com</code>) and provide the status and the output variable values.</p> <p>Note: The callback server must accept POST calls to receive the deployment status from the Control Room.</p>
runElevated	Boolean	No	Whether to deploy the bot using elevated permissions on the device. <code>false</code> and <code>true</code> .
automationPriority	String	Yes	Automation priority. By default, it is set to <code>PRIORITY_MEDIUM</code> . Possible values for automationPriority include <code>PRIORITY_MEDIUM</code> , <code>PRIORITY_HIGH</code> , and <code>PRIORITY_LOW</code> .
botLabel	String	No	Label for the bot to be deployed.
botInput	Object	No	A data structure containing a botInput object. More details are available in the Bot Input section.
hideBotAgentUi	Boolean	No	Flag to indicate whether you want to hide the bot agent UI.
botInput Object			
type*	Any	No	By default, it is <code>STRING</code> . Possible values for type include <code>BOOLEAN</code> , <code>FILE</code> , <code>ITERATOR</code> , <code>LIST</code> , <code>DICTIONARY</code> , <code>TAB</code> , <code>CONDITIONAL</code> , <code>WINDOW</code> , <code>TASKBOT</code> , <code>DATETIME</code> , <code>UIOBJECT</code> , <code>CREDENTIAL</code> , <code>COORDINATE</code> , <code>IMAGE</code> , <code>REGION</code> , <code>PROPERTY</code> , <code>CONDITIONALGROUP</code> , <code>FORM</code> , <code>FORMELEMENT</code> , <code>HOTKEY</code> , and <code>TEXT</code> .
*The structure of the input varies depending on the type you want to input.			
Attended parameters			
deploymentDeviceId	Integer	No	Specify the deployment device.
queueDeployment	Boolean	No	Flag to indicate whether you want to queue the deployment.
launchInChildWindow	Boolean	No	Flag to indicate whether you want to launch in the child window.
Unattended parameters			
deviceUsageType	String	Yes	<p>Specifies the device usage type. Following values are possible:</p> <ul style="list-style-type: none"> <code>PREFER_DEFAULT_DEVICE</code>: Prefer using the default device. Devices in the pool will be used only if the default device is not available. <code>RUN_ON_POOL_DEVICE</code>: Deployment will use device from the pool if available, otherwise use the default device. <code>RUN_ONLY_ON_DEFAULT_DEVICE</code>: Deployment will use the default device even when a device pool is present.
runAsUserIds	Integer	Yes	<p>List of runAs user IDs to deploy bot. The bot will be deployed on the device for each runAsUserIds or on one of the device if not provided.</p> <p><i>List available unattended Bot Runners API</i></p>

Parameter	Type	Required	Description
poolIds	Integer	No	<p>You will define the <code>poolIds</code> only when you are running a pool of runners instead of an individual runner. Identifier of at least one active device. If you enter multiple pool IDs, the first ID in which you want the API to check for available devices. If no devices are available at the time of deployment, the automation is queued.</p> <p>Note: If the user associated with the license has a default device account, the automation deploys on that device. If no default device is selected, then you must specify a device.</p> <p>List device pools API</p>
numOfRunAsUsersToUse	Integer	No	<p>Specifies how many Bot Runners to use from the list of runners. The weighted system algorithm selects the Bot Runners with the most runners for the tasks.</p> <ul style="list-style-type: none"> System will pick the specified number of <code>runAsUsers</code> for the tasks queued for the user at the moment of deployment. If 0, then all the users will be used. If the number is greater than the number of <code>runAsUsers</code>, it will error out.

Response

200 OK

For more information on the return codes, see [API response codes](#).

```
{
  "deploymentId": "120a1243-a434-22aa-ab3f-f1123ae2523b",
  "automationName": "Sample-bot-deploy"
}
```

Response parameters

Parameter	Type	Description
deploymentId	String	The deployment ID created.
automationName	String	Name of the deployed automation. If this name is not supplied in the request, a random name is assigned to the deployed automation.

Note: You can view the response in the REST API, but API functionality is limited. You need a licensed [Automation Anywhere](#) Edition to access the full functionality of the APIs.

The REST API responds to each request with an HTTP response code. For response codes, see [API response codes](#).

Workload Management API

Use the Workload Management API to programmatically manage and create Work Item models, queues, Work Items, and automations in your Control Room.

Note: You can view the in the , but API functionality is limited. You need a licensed Edition to access the full functionality of the APIs.

Prerequisites

To create a *Workload Management* automation process, ensure that you are allocated the following roles and permissions:

- AAE_Pool Admin role and View all devices permission
- AAE_Queue Admin role or Create queues permission
- Run bot permission
- Run or schedule permission on the bots folder
- Device pool consumer permission

Create workload automation

1. *Authenticate the user.*

Use the POST method to generate an authentication JSON Web Token.

2. Create workload management queues:

- Create Work Item model API*
- Create queues API*
- Add queue owner or member API*
- Add queue participants API*
- Add queue consumer API*
- Add Work Items to the queue API*

3. *Create device pool API*

4. *Run bot with queue API*

Retrieve workload management entities using list APIs

When you create workload management queues for workload automation (see previous section), you can use the Workload Management list APIs to retrieve a list of workload management entities such as Work Item models, queues, and Work Items in queues associated with the Control Room.

Workload Management list APIs

Create Work Item model API

Define a Work Item structure (model) for processing in a queue. This enables you to manually upload the Work Item from the system in the absence of ready data in a file.

You must have the following:

- Create queues or AAE_Queue Admin permission
- The endpoint URL: <your_control_room_url>/v3/wlm/workitemmodels

1. Use the POST method and endpoint URL: <your_control_room_url>/v3/wlm/workitemmodels.

Enter the parameters such as Work Item model **name**, **attribute** names, and **type** value in the request body to create a Work Item structure. The value of **type** can be TEXT, NUMBER, or DATE, depending on the **attribute** value format.

For example:

```
POST https://192.0.2.0/v3/wlm/workitemmodels
```

In this example, the Work Item model **name** is Finance-template and it includes the first_name, last_name, and email as **attributes**. For these attributes, use TEXT value as the **type** parameter.

Request body:

```
{
  "name": "Finance-template",
  "attributes": [
    {
      "name": "first_name",
      "type": "TEXT"
    },
    {
      "name": "last_name",
      "type": "TEXT"
    },
    {
      "name": "email",
      "type": "TEXT"
    }
  ]
}
```

2. Send the request.

When the request is successful, the Work Item model **id** and the display column **id** are returned in the response. You will use these IDs when you create queues.

In this example, the response body returns the Work Item model **id** as 10 and the display column **id** as 59, 60, 61 for the first_name, last_name, and email, respectively.

Response body:

```
{
  "id": 10,
  "createdBy": 24,
  "createdOn": "2020-05-26T06:14:27.520336200Z",
  "updatedBy": 24,
  "updatedOn": "2020-05-26T06:14:27.520336200Z",
  "tenantId": 1,
  "version": 0,
  "displayColumnId": 59,
  "displayColumnId": 60,
  "displayColumnId": 61
}
```

```
"tenantUuid": "4db5b32c-5c4b-4aee-8ca0-f53ec241563c",
"name": "fin",
"attributes": [
  {
    "id": 59,
    "name": "first_name",
    "type": "TEXT"
  },
  {
    "id": 60,
    "name": "last_name",
    "type": "TEXT"
  },
  {
    "id": 61,
    "name": "email",
    "type": "TEXT"
  }
]
```

The REST API responds to each request with an HTTP response code. For details about the response codes, see [API response codes](#).

[Create queues](#)

Related tasks

[List Work Item models](#)

Use the Work Item model list API to get the list of all the Work Item templates that are associated with the specified Control Room.

Create queues API

A queue is one of the main building blocks of workload management. It holds specific sets of data that your bot is expecting for automation.

Ensure you have the following:

- Create queues or AAE_Queue Admin permission

- The endpoint URLs:

- <your_control_room_url>/v3/wlm/queues
- <your_control_room_url>/v3/wlm/workitemmodels/list

1. Use the POST method and endpoint URL: <your_control_room_url>/v3/wlm/queues.

Enter values for the following parameters to create a queue. Use the same **workItemModelId** and **displayColumnIds** that you received in response when you created the Work Item model.

Note: If you want to search or get a list of all the available **workItemModelId**, use the endpoint URL <your_control_room_url>/v3/wlm/workitemmodels/list.

[List workload management queues](#)

For example:

```
POST https://192.0.2.0/v3/wlm/queues
```

In this example, use **workItemModelId** as 10 and **displayColumnIds** as 59, 60, 61.

Request body:

```
{
  "name": "Finance-Q",
  "description": "Queue for Finance",
  "reactivationThreshold": 1,
  "displayColumns": [
    "first_name",
    "last_name",
    "email"
  ],
  "workItemProcessingOrders": [
  ],
  "workItemModelId": 10,
  "displayColumnIds": [
    59,
    60,
    61
  ]
}
```

2. Send the request.

When the request is successful, a queue **id** is returned in the response body. This queue **id** will be used in the subsequent tasks when you add owners, participants, consumers, and Work Items in the queue.

In this example, the response body returns the queue **id** as 17.

Response body:

```
{
  "id": "17",
  "createdBy": "24",
  "createdOn": "2020-05-26T06:13:57.644499300Z",
  "updatedBy": "24",
  "updatedOn": "2020-05-26T06:13:57.644499300Z",
  "tenantId": "1",
  "version": "0",
  "tenantUuid": "4db5b56c-5c2b-4aee-8ca0-f53ec241563c",
  "name": "Finance-Q",
}
```



```
"description": "Queue for Finance",
"reactivationThreshold": "1",
"status": "NOT_IN_USE",
"manualProcessingTime": "0",
"manualProcessingTimeUnit": "",
"workItemProcessingOrders": [

],
"workItemModelId": "10",
"displayColumnIds": [
  "59",
  "60",
  "61"
],
"considerReactivationThreshold": false
}
```

The REST API responds to each request with an HTTP response code. For details about the response codes, see [API response codes](#).

[Add queue owner or member](#)

Related reference

[List workload management queues](#)

Use the Workload Management queues list API to get the list of all the queues that are associated with the specified Control Room. To execute this API, you must have Queue Consumer permission.

Add queue owner or member API

Add queue owners who can create, edit, and view queues. The queue creator is the default queue owner and can add other Control Room users as queue owners if required.

You must have the following:

- Create queues or AAE_Queue Admin permission

- The endpoint URLs:

- <your_control_room_url>/v3/wlm/queues/{queueId}/members/{userId}
- <your_control_room_url>/v1/usermanagement/users/list
- <your_control_room_url>/v3/wlm/queues/list

1. Use the PUT method and endpoint URL: <your_control_room_url>/v3/wlm/queues/{queueId}/members/{userId}.

Enter the **queueId** to which you want to add the owner and the **userId** that will be the owner of the queue. This **queueId** is the same ID that was returned when you created the queue.

Note:

- If you want to search or get a list of all the available **queueId**, use the endpoint URL <your_control_room_url>/v3/wlm/queues/list.

[List workload management queues](#)

- If you want to search or get a list of all the **userId**, use the endpoint URL: <your_control_room_url>/v1/usermanagement/users/list.

[Search for users API](#)

For example, use **queueId** as 17 and **userId** as 1.

```
PUT https://192.0.2.0/v3/wlm/queues/17/members/1
```

Add one or more **permissions** in the request body to allow the user to perform the specific queue actions. In this example, `manage` and `own` permissions are added.

Request body:

```
{
  "permissions": [
    "manage",
    "own"
  ]
}
```

2. Send the request.

When the request is successful, the required user is added as a queue owner.

In this example, the user with **userId** as 1 is added as a queue owner.

Response body:

```
{
  "id": 1,
  "permissions": [
    "own",
    "manage"
  ]
}
```

The REST API responds to each request with an HTTP response code. For details about the response codes, see [API response codes](#).

[Add queue participants](#)

Add queue participants API

Add queue participants from different roles defined in the Control Room.

You must have the following:

- Create queues or AAE_Queue Admin permission
- The endpoint URLs:
 - `<your_control_room_url>/v3/wlm/queues/{queueId}/participants`
 - `<your_control_room_url>/v3/wlm/queues/list`

1. Use the POST method and endpoint URL: `<your_control_room_url>/v3/wlm/queues/{queueId}/participants`.

Enter the **queueId** to which you want to add the participants. This **queueId** is the same ID that was returned when you created the queue.

Note: If you want to search or get a list of all the available **queueId**, use the endpoint URL `<your_control_room_url>/v3/wlm/queues/list`.

[List workload management queues](#)

For example, use **queueId** as 17.

```
POST https://192.0.2.0/v3/wlm/queues/17/participants
```

Enter one or more role **id** in the request body that you want to add as queue participants. In this example, one role **id** as 21 is added as queue participant.

Request body:

```
[
  {
    "id": 21
  }
]
```

2. Send the request.

When the request is successful, the participants are added to the queue.

In this example, the participant with role **id** as 21 is added to the queue.

Response body:

```
[
  {
    "id": 21,
    "createdBy": null,
    "createdOn": null,
    "updatedBy": null,
    "updatedOn": null,
    "tenantId": null,
    "version": 0,
    "tenantUuid": null,
    "description": null,
    "name": null,
    "accessRestriction": null,
    "permissions": [
    ],
  },
]
```

```

    "countPrincipals": 0,
    "principals": [
      ]
    }
  ]

```

The REST API responds to each request with an HTTP response code. For details about the response codes, see [API response codes](#).

[Add queue consumer](#)

Add queue consumer API

Add queue consumers from different roles defined in the Control Room.

You must have the following:

- Create queues or AAE_Queue Admin permission
- The endpoint URLs:
 - `<your_control_room_url>/v3/wlm/queues/{queueId}/consumers`
 - `<your_control_room_url>/v3/wlm/queues/list`

1. Use the POST method and endpoint URL: `<your_control_room_url>/v3/wlm/queues/{queueId}/consumers`.

Enter the **queueId** to which you want to add the consumers. This **queueId** is the same ID that was returned when you created the queue.

Note: If you want to search or get a list of all the available **queueId**, use the endpoint URL `<your_control_room_url>/v3/wlm/queues/list`.

[List workload management queues](#)

For example, use **queueId** as 17.

```
POST https://192.0.2.0/v3/wlm/queues/17/consumers
```

Enter one or more role **id** in the request body that you want to add as queue consumers. In this example, one role **id** as 21 is added as queue consumer.

Request body:

```

[
  {
    "id": 21
  }
]

```

2. Send the request.

When the request is successful, the consumers are added to the queue.

In this example, the consumer with role **id** as 21 is added to the queue.

Response body:

```

[
  {
    "id": 21,

```

```

    "createdBy": null,
    "createdOn": null,
    "updatedBy": null,
    "updatedOn": null,
    "tenantId": null,
    "version": 0,
    "tenantUuid": null,
    "description": null,
    "name": null,
    "accessRestriction": null,
    "permissions": [

    ],
    "countPrincipals": 0,
    "principals": [

    ]
  }
]

```

The REST API responds to each request with an HTTP response code. For details about the response codes, see [API response codes](#).

[Add Work Items to the queue](#)

Add Work Items to the queue API

Add or insert Work Items to an existing queue in the Control Room per the defined model or structure.

- The user must be a Queue owner and participant
- You must have the endpoint URLs:
 - `<your_control_room_url>/v3/wlm/queues/{queueId}/workitems`
 - `<your_control_room_url>/v3/wlm/queues/list`

1. Use the POST method and endpoint URL: `<your_control_room_url>/v3/wlm/queues/{queueId}/workitems`.

Enter the **queueId** to which you want to add a Work Item in the queue.

Note: If you want to search or get a list of all the available **queueId**, use the endpoint URL `<your_control_room_url>/v3/wlm/queues/list`.

[List workload management queues](#)

For example, use **queueId** as 17.

```
POST https://192.0.2.0/v3/wlm/queues/17/workitems
```

Enter a **workitem** in the request body.

Note: In the request body, ensure there are no hidden, invalid, new line, or EOL characters. You can check for these using text or source code editors.

Request body:

```
{
  "workItems": [
```

```

{
  "json": {
    "first_name": "Jane",
    "last_name": "Doe",
    "email": "jane.doe@example.com"
  }
}
]
}

```

2. Send the request.

When the request is successful, a unique Work Item **id** is returned in the response body and the Work Items are added to the queue per the defined Work Item model or structure.

In this example, the Work Item with the **first_name** as Jane, **last_name** as Doe, and **email** as jane.doe@example.com is added to the queue based on the defined structure.

Response body: (truncated output)

```

{
  "id": 77,
  "createdBy": 24,
  "createdOn": "2020-05-19T17:41:57.602092100Z",
  "updatedby": 24,
  "updatedOn": "2020-05-26T09:13:31.090241700Z",
  "version": 2,
  "json": {
    "first_name": "Jane",
    "last_name": "Doe",
    "email": "jane.doe@example.com"
  },
  "result": "",
  "deviceId": 0,
  "status": "NEW",
  "col1": "1.0",
  "col2": "",
  "...",
  "co21": "",
  "deviceUserId": 0,
  "queueId": 5,
  "comment": "",
  "automationId": 0,
  "totalPausedTime": 0,
  "error": ""
}

```

3. Optional: If you want to add multiple Work Items, call the API using a list of Work Item JSON objects.

Request body:

```

{
  "workItems": [
    {
      "json": {
        "DATA": "mydata",
        "TRN_ID": "A11"
      }
    },
    {
      "json": {
        "DATA": "mydata",
        "TRN_ID": "A11"
      }
    }
  ]
}

```

```
]
}
```

Response body:

```
{
  "list": [
    {
      "id": "40957",
      "createdBy": "25",
      "createdOn": "2021-11-24T01:53:10.175335900Z",
      "updatedBy": "25",
      "updatedOn": "2021-11-24T01:53:10.175335900Z",
      "version": "0",
      "json": {
        "TRN_ID": "A11",
        "DATA": "mydata"
      },
      "result": "",
      "deviceId": "0",
      "status": "NEW",
      "col1": "A11",
      "col2": "",
      "col3": "",
      "col4": "",
      "col5": "",
      "deviceUserId": "0",
      "queueId": "0",
      "comment": "",
      "automationId": "0",
      "totalPausedTime": "0",
      "error": "",
      "col6": "",
      "col7": "",
      "col8": "",
      "col9": "",
      "col10": "",
      "jobExecutionId": ""
    },
    {
      "id": "40958",
      "createdBy": "25",
      "createdOn": "2021-11-24T01:53:10.198337200Z",
      "updatedBy": "25",
      "updatedOn": "2021-11-24T01:53:10.198337200Z",
      "version": "0",
      "json": {
        "TRN_ID": "A11",
        "DATA": "mydata"
      },
      "result": "",
      "deviceId": "0",
      "status": "NEW",
      "col1": "A11",
      "col2": "",
      "col3": "",
      "col4": "",
      "col5": "",
      "deviceUserId": "0",
      "queueId": "0",
      "comment": "",
      "automationId": "0",
      "totalPausedTime": "0",

```

```

        "error": "",
        "col6": "",
        "col7": "",
        "col8": "",
        "col9": "",
        "col10": "",
        "jobExecutionId": ""
    }
]
}

```

4. Optional: If you want to update the Work Item data, when the automation is running, you need to perform the following steps:
 - a) Pause the automation. Use the PUT method and the following endpoint URL:
`<your_control_room_url>/v3/wlm/automations/{id}`
 - b) Update the Work Item by using queue ID and Work Item ID. Use the PUT method and the following endpoint URL: `<your_control_room_url>/v3/wlm/queues/{id}/workitems/{workitemId}`
 - c) Resume the automation. Use the PUT method and the following endpoint URL:
`<your_control_room_url>/v3/wlm/automations/{id}`

Create an automation to run a bot with a queue

Related tasks

[List Work Items in queue](#)

Use the Workload Management Work Item list API to get the list of all the Work Items in the queues that are associated with the specified Control Room.

Run bot with queue API

Create an automation to collectively process all the Work Items of a queue across all the Bot Runners present in one or more device pools using the API.

- You must have the following permissions:
 - Run bot
 - Run or schedule permission on the bot folder
 - Queue consumer
 - Device pool consumer

- You must have the endpoint URLs:
 - <your_control_room_url>/v3/wlm/automations
 - <your_control_room_url>/v1/usermanagement/users/list
 - <your_control_room_url>/v3/wlm/queues/list
 - <your_control_room_url>/v2/devices/pools/list
- 1. Use the POST method and endpoint URL:** <your_control_room_url>/v3/wlm/automations. Enter parameters such as **name** of the automation, **fileId**, **filename**, **queueID**, **queueName**, **runAsUserIds**, and **poolId**.
- If you want to search or get a list of all the available **queueId**, use the endpoint URL <your_control_room_url>/v3/wlm/queues/list.
List workload management queues
 - If you want to search or get a list of all the **runAsUserIds**, use the endpoint URL: <your_control_room_url>/v1/usermanagement/users/list.
Search for users API
 - If you want to search or get a list of all the **poolId**, use the endpoint URL: <your_control_room_url>/v2/devices/pools/list.
List device pools API

In this example, the parameters are entered as follows:

- Automation **name** as Finance-RPA-Run
- Bot **fileName** as wlmql
- **runAsUserIds** as 4 and 5 that will log in to the device to run the automation
- **queueID** as 17, associated with the queue to run the automation
- **poolId** as 1 that is associated with the pool

Request body:

```
{
  "name": "Finance-RPA-Run",
  "automationName": "Finance-RPA-Run",
  "fileName": "wlmql",
  "botInput": {
  },
  "status": "ACTIVE",
  "description": "WLM for Finance",
  "rdpEnabled": false,
  "setAsDefaultDevice": false,
  "poolIds": [
  ],
  "workspaceName": "public",
  "timeZone": "Asia/Calcutta",
  "runAsUserIds": [
    "4",
    "5"
  ],
  "queueId": "17",
  "poolId": "1"
}
```

2. Send the request.

When the request is successful, a unique automation **id** is returned in the response body after the workload management automation run successfully. The details of the associated queue name and ID, and the user name IDs for which the automation is run are also provided.

In this example, the response body returns the unique automation **id** as 12.

Response body:

```
{
  "id": "12",
  "name": "Finance-RPA-Run",
  "status": "ACTIVE",
  "description": "WLM for Finance",
  "rdpEnabled": false,
  "priority": "1",
  "queueId": "17",
  "queueName": "Finance-Q",
  "poolId": "1",
  "runAsUserIds": [
    "4",
    "5"
  ],
  "fileId": "17",
  "startedOn": "2020-05-26T09:42:51.958893800Z",
  "startedBy": "24",
  "createdBy": "24",
  "createdOn": "2020-05-26T09:42:51.958893800Z",
  "updatedBy": "24",
  "updatedOn": "2020-05-26T09:42:51.958893800Z",
  "tenantId": "1",
  "version": "0",
  "tenantUuid": "4db5b32c-5c4b-4aee-8ca0-f53ec241563c"
}
```

The REST API responds to each request with an HTTP response code. For details about the response codes, see [API response codes](#).

Workload Management list APIs

List APIs use the POST method to return the list of the entities. You can use the Workload Management list APIs and get the list of workload management entities, for example, Work Item models, queues, and Work Items in the queues.

Use the following Workload Management APIs to get the list of the workload management entities:

- [List Work Item models](#)
- [List workload management queues](#)
- [List Work Items in queue](#)

List Work Item models

Use the Work Item model list API to get the list of all the Work Item templates that are associated with the specified Control Room.

You must Queue Consumer permission.

1. Add the authentication token or bearer token to the request header. You cannot use both in the same API.

2. Use the POST method and endpoint URL: <your_control_room_url>/v3/wlm/workitemmodels/list.
Use the following URL and leave the request body blank to request information about all available Work Item models:

```
https://192.0.2.0/v3/wlm/workitemmodels/list
```

3. Send the request.

Because there is no filtering used in the request, a successful response returns all of the queues for the specified Control Room. In this example, the response returned data for two Work Item models.

Response body:

```
{
  "page": {
    "offset": 0,
    "total": 50,
    "totalFilter": 50
  },
  "list": [
    {
      "id": "1",
      "name": "q1",
      "attributes": [
        {
          "name": "Customer Name",
          "type": "TEXT",
          "id": "2"
        },
        {
          "name": "email",
          "type": "TEXT",
          "id": "4"
        }
      ]
    },
    {
      "id": "2",
      "name": "q2",
      "attributes": [
        {
          "name": "Customer Name",
          "type": "TEXT",
          "id": "7"
        },
        {
          "name": "email",
          "type": "TEXT",
          "id": "9"
        }
      ]
    }
  ]
}
```

Related tasks

[Create Work Item model API](#)

Define a Work Item structure (model) for processing in a queue. This enables you to manually upload the Work Item from the system in the absence of ready data in a file.

List workload management queues

Use the Workload Management queues list API to get the list of all the queues that are associated with the specified Control Room. To execute this API, you must have Queue Consumer permission.

Request

```
POST http://{{ControlRoomURL}}/v3/wlm/queues/list
```

```
Header: X-Authorization: <<authentication token>> or Authorization: Bearer <<bearer token>>
```

All API calls must contain either an authentication token from [Authentication API](#) (generates JSON Web token) or a bearer token from OAuth services. You cannot use both together in an API.

Request body without filters:

```
{
  "sort": [
    {
      "field": "name",
      "direction": "asc"
    }
  ],
  "filter": {
  },
  "page": {
    "offset": 0,
    "total": 100,
    "totalFilter": 100,
    "length": 200
  }
}
```

Request body with filters:

```
{
  "sort": [
    {
      "field": "name", //set sort by criteria
      "direction": "asc"
    }
  ],
  "filter": {
    "operator": "and",
    "operands": [
      {
        "operator": "eq",
        "value": "DRAFT",
        "field": "status"
      },
      {
        "operator": "substring",
        "value": "Test",
        "field": "name"
      }
    ]
  }
}
```

```

    }
  ]
},
"fields": [],
"page": { //return a limited number of results with offset for pagination
  "offset": 0,
  "total": 100,
  "totalFilter": 100,
  "length": 200
}
}
}

```

Request Parameters

Parameter	Type	Required	Description
sort	Array	No	By default, search results are sorted in descending order with respect to their ids. An alternative sorting is specified using the sort query parameter. Enter the field by which you want to sort along with the direction <code>asc</code> (ascending) or <code>desc</code> (descending). For more information on sorting, see Filtering, pagination, and sorting
filter	Object	No	Filters the result. For more information on sorting, see Filtering, pagination, and sorting
fields	Array	No	Filter the result based on the fields.
page	Object	No	The page object allows you to get the desired pages. For more information on pagination rules, see Filtering, pagination, and sorting

For the above sample request, the response returns all the details of the queue that has `Test` in their name and `NOT_IN_USE` as status.

Response

```

{
  "page": {
    "offset": 0,
    "total": 17,
    "totalFilter": 1
  },
  "list": [
    {
      "id": "32",
      "createdBy": "873",
      "createdOn": "2022-03-02T05:51:53.855636Z",
      "updatedBy": "873",
      "updatedOn": "2022-03-02T05:54:18.745722Z",
      "tenantId": "1",
      "version": "1",
      "tenantUuid": "b6e4eb84-f7ef-4dfd-a432-725b71de8142",
      "name": "for-docs-test",
      "description": ""
    }
  ]
}

```

```

        "reactivationThreshold": "1",
        "status": "NOT_IN_USE",
        "manualProcessingTime": "0",
        "manualProcessingTimeUnit": "SECONDS",
        "workItemProcessingOrders": [],
        "workItemModelId": "28",
        "displayColumnIds": [
            "156",
            "157",
            "158",
            "159",
            "160"
        ],
        "considerReactivationThreshold": false
    }
}
}

```

Response Parameters

Parameter	Type	Description
offset	Integer	The starting list offset, used for pagination.
total	Integer	Total number of records.
totalFilter	Integer	Number of records after applying the filter.
List	Array	The array of List of queues.
List roles object		
id	Integer	The unique Id of a specific queue.
createdBy	Integer	Id of the user who created the role.
createdOn	String	The creation timestamp of the role.
updatedBy	Integer	Id of the user who made a latest update to the role.
updatedOn	String	The latest update timestamp of the role.
tenantId	Integer	Id of the tenant.
version	Integer	Version of the role instance.
tenantUuid	String	Unique Id of the tenant.
name	String	Name of queue.
description	String	Description of queue.
reactivationThreshold	Integer	Minimum number of workItems in the queue to reactivate queue.
status	String	The current status of the queue. The values can be DRAFT, IN_USE, NOT_IN_USE.
manualProcessingTime	Integer	Efforts required to process the queue manually.
manualProcessingTimeUnit	String	Unit of the manual Processing time. The values can be SECONDS, MINUTES, HOURS, or DAYS.
workItemProcessingOrders	Array	An array of work item processing orders.
workItemModelId	Integer	Id of the Work Item Model.

Parameter	Type	Description
displayColumnIds	Array	An array displaying the list of column Ids.
considerReactivationThreshold	Boolean	Flag to indicate if the Reactivation Threshold is required or not.

Note: You can view the in the , but API functionality is limited. You need a licensed Edition to access the full functionality of the APIs.

The REST API responds to each request with an HTTP response code. For response codes, see [API response codes](#).

Related tasks

[Create queues API](#)

A queue is one of the main building blocks of workload management. It holds specific sets of data that your bot is expecting for automation.

List Work Items in queue

Use the Workload Management Work Item list API to get the list of all the Work Items in the queues that are associated with the specified Control Room.

You must have the following:

- Queue Consumer permission
- All API calls must contain either an authentication token from [Authentication API](#) (generates JSON Web token) or a bearer token from OAuth services. You cannot use both together in an API.
- The endpoint URL: <your_control_room_url>/v3/wlm/queues/{queueId}/workitems/list

Leave the request body blank to request information on all available Work Items. Add one or more filter parameters in the request body to limit the information returned from all available workload management Work Items.

Supported filterable parameters:

status

The status of queue for example: New, On hold, Failed, Completed, Data error, Active, and Ready to run.

- **Field:** status
- **Type:** string

```
{
  "filter": {
    "operator": "eq",
    "value": "ACTIVE",
    "field": "status"
  }
}
```

result

The Work Item result string. For example, the Work Item was completed or skipped.

- **Field:** result
- **Type:** string

```
{
```

col

```

    "filter": {
      "operator": "substring",
      "value": "skipped",
      "field": "result"
    }
  }
}

```

The column number corresponding to the custom column name. For example, email, firstname, and lastname.

- **Field:** col
- **Type:** string

```

{
  "filter": {
    "operator": "substring",
    "value": "Brian",
    "field": "col1"
  }
}

```

1. Use the POST method to generate an authentication JSON Web Token.

[Authentication API](#)

2. Use the POST method and endpoint URL: <your_control_room_url>/v3/wlm/queues/{queueId}/workitems/list

For example, enter the queueId as 20 in the following URL for which you want to get the Work Items:

```
https://192.0.2.0/v3/wlm/queues/20/workitems/list
```

Use filters in the request body to retrieve the list of all the Work Items that are in NEW status and have Brian in their first_name (col1).

Request body:

```

{
  "sort": [
    {
      "field": "computedStatus",
      "direction": "asc"
    }
  ],
  "filter": {
    "operator": "and",
    "operands": [
      {
        "operator": "eq",
        "value": "NEW",
        "field": "status"
      },
      {
        "operator": "substring",
        "value": "Brian",
        "field": "col1"
      }
    ]
  }
},
"page": {

```



```

    "offset": 0,
    "total": 5,
    "totalFilter": 1,
    "length": 100
  }
}

```

3. Send the request.

- In the REST Client, click **SEND**.
- In the Swagger interface, click **Execute**.

The response returns all the details of the Work Item that has `Brian` in their `first_name` (`col1`) and status is `NEW`.

Response body:

```

{
  "page": {
    "offset": 0,
    "total": 5,
    "totalFilter": 1
  },
  "list": [
    {
      "id": "11804",
      "createdBy": "24",
      "createdOn": "2020-05-26T10:19:34.786711300Z",
      "updatedBy": "24",
      "updatedOn": "2020-05-26T10:19:34.786711300Z",
      "version": "1",
      "json": {},
      "result": "",
      "deviceId": "0",
      "status": "NEW",
      "col1": "Brian",
      "col2": "Matthews",
      "col3": "bmatthews0@example.com",
      "col4": "",
      "col5": "",
      "deviceUserId": "0",
      "queueId": "20",
      "comment": "",
      "automationId": "0",
      "totalPausedTime": "0",
      "error": "",
      "col6": "",
      "col7": "",
      "col8": "",
      "col9": "",
      "col10": ""
    }
  ]
}

```

Related tasks

[Add Work Items to the queue API](#)

Add or insert Work Items to an existing queue in the Control Room per the defined model or structure.

Migration APIs

Use migration APIs to migrate MetaBots and TaskBots that were created in Enterprise client versions Enterprise 11 and Enterprise 10 to Automation 360. Use this page to review the migration prerequisites and access Enterprise 11 and Enterprise 10 Migration APIs.

Note: You can view the in the , but API functionality is limited. You need a licensed Edition to access the full functionality of the APIs.

Prerequisites

Complete the prerequisites before migrating Enterprise 11 bots to Automation 360. [Prerequisite tasks for migrating bots](#)

Enterprise 11 Migration APIs

1. [Start migration API](#)
2. [Migrate all bots in a sub-folder API](#)
3. [List migration results API](#)
4. [Bot migration results by id API](#)
5. [Migration action mapping results API](#)

Enterprise 10 Migration APIs

1. [Connect to Enterprise 10 database](#)
2. [Validate master key and repository path](#)
3. [Initiate Enterprise 10 data migration process](#)

(Optional) Use any the following APIs to retrieve the migration results.

- [Retrieve migrated roles](#)
- [Retrieve migrated users](#)
- [Retrieve migrated credentials](#)
- [Retrieve migrated bots](#)
- [Retrieve migrated schedules](#)

Start migration API

Use this API to migrate bots (TaskBots and MetaBots) created using the Enterprise Client version 11.x to Automation 360.

Request

```
POST https://{{ControlRoomURL}}/v3/migration/start
```

```
Header: X-Authorization: <<authentication token>> or Authorization: Bearer <<bearer token>>
```

All API calls must contain either an authentication token from [Authentication API](#) (generates JSON Web token) or a bearer token from OAuth services. You cannot use both together in an API.

Request body:

```
{
  "name": "Migration.migrator.22.07.06.17.59.47",
  "description": "Migrating Legacy Bot",
  "overwriteBots": true,
  "botIds": [
    13
  ],
  "userIds": [
    5
  ],
  "legacyExcelCellRow": true,
  "includeChildFolders": false,
  "folderIds": [
  ],
  "emailEwsSettings": true,
  "emailEwsExchangeVersion": "Exchange2010",
  "emailEwsAuthenticationType": "Basic",
  "convertToEdgeWithIeMode": true,
  "botAnalytics": true,
  "webServicesProxySettings": true,
  "excludeBotDependencies": true
}
```

Note: Complete the prerequisite tasks before migrating Enterprise 11 bots to Automation 360. [Prerequisite tasks for migrating bots](#)

Request parameters

Parameter	Type	Required	Description
name	String	Yes	The name for the migration entity.
description	String	No	A short description for the migration.
overwriteBots	Boolean	No	Set this parameter to <code>true</code> if you want to migrate already migrated bots again. The default value is <code>false</code> .

Parameter	Type	Required	Description
botIds	integer	Yes	Bot IDs to run the migration.
userIds	Integer	Yes	Bot Runner users' IDs where this migration will be run on.
legacyExcelCellRow	Boolean	No	Set this parameter to <code>true</code> if you want to use the "Excel Cell Row" legacy behavior. If you are migrating from 11.3.0 or earlier, select this option. The default value is <code>false</code> .
includeChildFolders	Boolean	No	Set this parameter to <code>true</code> if you want to include the child folders during the migration. The default value is <code>false</code> .
folderIds	Integer	No	Folder IDs for all the bots contained in the subfolder with the <i>folderIds</i> .
emailEwsSettings	Boolean	No	Set this parameter to <code>true</code> if you have used EWS in Enterprise 11. The default value is <code>false</code> .
emailEwsExchangeVersion	String	No	This is used to specify the version of the EWS server configured in Enterprise 11. When you set <i>emailEwsSettings</i> to <code>true</code> , you can set a value to the email exchange server (<i>emailEwsExchangeVersion</i>). The possible values are as follows: <i>Exchange2010</i> , <i>Exchange2010_SP1</i> , <i>Exchange2010_SP2</i> , <i>Exchange2007_SP1</i> , and <i>Exchange2013</i> .
emailEwsAuthenticationType	String	No	This is used to specify the authentication type set for the EWS server configured in Enterprise 11. The possible values are as follows: <i>Basic</i> and <i>OAuth2</i> .
convertToEdgeWithIeMode	Boolean	No	Set this parameter to <code>true</code> if you want to migrate bots that use Internet Explorer to use Microsoft Edge with IE mode. The default value is <code>false</code> .
botAnalytics	Boolean	No	Set this parameter to <code>true</code> if you want to tag bots and variables for analytics through Bot Insight. If you are not using Bot Insight in legacy bots, set it to <code>false</code> . The default value is <code>false</code> .
webServicesProxySettings	Boolean	No	Set this parameter to <code>true</code> if you want to migrate along with the web services proxy host and port. If this value is true, precreated global values will be available to the bot for connecting with the web services proxy. The default value is <code>false</code> .
excludeBotDependencies	Boolean	No	Set this to <code>true</code> if you want all the bot dependencies to be excluded during migration. The default value is <code>false</code> .

Note: View the migration status using [List migration results API](#).

Response

```
200 OK
```

The successful response includes a 200 success response and an empty body.

The REST API responds to each request with an HTTP response code. For response codes, see [API response codes](#).

Note: You can view the in the , but API functionality is limited. You need a licensed Edition to access the full functionality of the APIs.

See also

- [Migrate all bots in a sub-folder API](#)
- [Migration action mapping results API](#)

Migrate all bots in a sub-folder API

Migrate all the bots separately as well as from a given folder and all if its sub-folders in your Control Room repository.

- Find the folder ID you want to migrate. The [List files and folders by workspace API](#) searches for files and folders in the private or public Control Room repositories. Filter the results to identify the folder ids to be used in the request body.
 - For one or more users with a RUNTIME device license. Use `userIds` for registered users in the Control Room as unattended bot runners with a RUNTIME device license and registered device. [Search for users API](#)
 - You must have an admin role to migrate bots and folders.
1. Add the authentication token or bearer token to the request header. You cannot use both in the same API.
 2. Use the POST method and endpoint URL: `<your_control_room_url>/v3/migration/start`

Request parameters:

Parameter	Required	Type	Description
folderIds	Yes	Integer	Folder IDs for all the bots contained in the sub-folder with th
userIds	Yes	Integer	User IDs for an unattended Bot Runner user.

Parameter	Required	Type	Description
includeChildFolders	No	Boolean	Set this parameter to true if you want to include child folders migration. The default value is false.

This following request starts a migration for all the bots contained in the sub-folder with the folderIds: 7 and userIds: 18.

Request body:

```
{
  "name": "Follow a convention that is meaningful and easy to search.",
  "description": "Add a meaningful description.",
  "overwriteBots": true,
  "userIds": [
    18
  ],
  "folderIds": [
    7
  ],
  "includeChildFolders": true
}
```

3. Send the request.

The successful response includes a 200 success code and an empty body.

```
{ }
```

The REST API responds to each request with an HTTP response code. For response codes, see [API response codes](#).

You can view the status of the migration using the [List migration results API](#).

List migration results API

List the overall migration results for each migration you run. Filter by selected fields to get the specific results.

Note: You can view the in the , but API functionality is limited. You need a licensed Edition to access the full functionality of the APIs.

You must have an admin role or a custom role with **View Migration** permission.

Supported filterable fields: Use the following filters in the request body to narrow the results.

- name: The migration name.
- status: The migration status.
 - Success
 - Skipped
 - Failed

- migrationType: The migration type: BOT, ROLE, or AUDIT_DATA.
1. Add the authentication token or bearer token to the request header. You cannot use both in the same API.
 2. Use the POST method and endpoint URL: <your_control_room_url>/v3/migration/list.

Request body:

This request searches for migrations that contain the word **HRBotMigration** in the name field that was started between the specified dates.

```
{
  "sort": [
    {
      "field": "startTime",
      "direction": "desc"
    }
  ],
  "filter": {
    "operator": "substring",
    "value": "HRBotMigration",
    "field": "name"
  },
  "page": {
    "offset": 0,
    "total": 100,
    "totalFilter": 100,
    "length": 200
  }
}
```

3. Send the request.

Response body:

The example response returned the migration name, startTime and endTime, migration status, migrationType and other details.

```
{
  "page": {
    "offset": 0,
    "total": 17,
    "totalFilter": 1
  },
  "list": [
    {
      "id": 3,
      "name": " HRBotMigration ",
      "startTime": "2021-01-20T14:26:27.347Z",
      "endTime": "2021-01-20T14:27:36.617Z",
      "createdBy": 1,
      "duration": "69s",
      "numSuccess": 1,
      "numFailed": 0,
      "numSkipped": 0,
      "numTotal": 1,
      "status": "SUCCESSFUL",
      "updatedOn": "2021-01-20T14:26:47.850Z",
      "updatedBy": 1,
      "durationMillis": 69270,
      "migrationType": "BOT"
    }
  ]
}
```

```
}

```

Note: There are some response fields that are not used for Enterprise 11 migration:

- duration: A legacy field that is no longer used for migration.
- migrationType: It is used for Enterprise 10 migrations only. It is not used for Enterprise 11 migration.

The REST API responds to each request with an HTTP response code. For response codes, see [API response codes](#).

To view details about a specific migration, enter a specific migration id in the [Bot migration results by id API](#).

Bot migration results by id API

List bot migration results by a unique numeric identifier, migrationId and filter the results by selected fields.

Note: You can view the in the , but API functionality is limited. You need a licensed Edition to access the full functionality of the APIs.

- You must have an admin role or a custom role with **View Migration** permission.
- Use the numeric identifier, migrationId for the migration you want to view.

Supported filterable fields:

Use the following filters in the request body to narrow the search results:

- sourceName: Source bot name.
 - sourceType: Source bot type.
 - status: Migration status.
 - Success
 - Skipped
 - Failed
 - reason: A reason why this bot migration is failed.
 - targetName: Migrated bot target name.
 - targetType: Migrated bot target type.
1. Add the authentication token or bearer token to the request header. You cannot use both in the same API.
 2. Use the POST method and endpoint URL: <your_control_room_url>/v3/migration/<migrationId>/results/list
Enter the migration ID you want to view.
 3. Create a request to find the search results. This filter searches for a string in the sourceName of the migrated bot.

Request body:

```
{
  "sort": [
    {
      "field": "sourceName",
      "direction": "asc"
    }
  ]
}
```



```

    }
  ],
  "filter": {
    "operator": "substring",
    "value": "mbot-dep",
    "field": "sourceName"
  },
  "page": {
    "offset": 0,
    "total": 100,
    "totalFilter": 100,
    "length": 200
  }
}

```

4. Send the request.

Response body:

```

{
  "page": {
    "offset": 0,
    "total": 3,
    "totalFilter": 1
  },
  "list": [
    {
      "sourceId": 24,
      "sourceName": "mbot-dep01.mbot",
      "sourcePath": "Automation Anywhere\\Bots\\My MetaBots\\mbot-
dep01.mbot",
      "sourceType": "application/vnd.aa.mbot",
      "targetId": 941,
      "status": "SUCCESS",
      "reason": "",
      "selectedByUser": true,
      "userId": 9,
      "id": 469,
      "targetName": "logic-launchweb01",
      "targetPath": "Automation Anywhere\\Bots\\My MetaBots\\mbot-
dep01\\logic-launchweb01",
      "targetType": "application/vnd.aa.taskbot"
    }
  ]
}

```

The response returned 1 out of 3 responses for bot migration results.

add link to the next API Migration Action mapping results.

The REST API responds to each request with an HTTP response code. For response codes, see [API response codes](#).

To view the list action mapping results, see [Migration action mapping results API](#).

Migration action mapping results API

List action mapping results for bots by unique numeric identifiers for the migration <migration ID> and the journal <journal ID>, and then filter the results by selected fields.

Request

```
POST https://{{ControlRoomURL}}/v3/migration/<migration ID>/journal/<journal ID>/actionmappings/list
```

```
Header: X-Authorization: <<authentication token>> or Authorization: Bearer <<bearer token>>
```

All API calls must contain either an authentication token from [Authentication API](#) (generates JSON Web token) or a bearer token from OAuth services. You cannot use both together in an API.

Request body

```
{
  "sort": [
    {
      "field": "targetLineNumber",
      "direction": "asc"
    }
  ],
  "filter": {
    "field": "reviewRequired",
    "operator": "eq",
    "value": "true"
  },
  "page": {
    "offset": 0,
    "length": 100
  }
}
```

Make sure you have the following:

- You have an admin role or a custom role with **View migration** permission.
- The numeric identifier, <migration ID>, for the migration you want to view.
- The numeric value for the <journal ID> associated with the migration identifier. See [How to find a migration journalid](#)

Request parameters

Parameter	Type	Required	Description
sort	Array	No	By default, search results are sorted in descending order with respect to their IDs. An alternative sorting is specified using the sort query parameter. Enter the field by which you want to sort along with the direction <code>asc</code> (ascending) or <code>desc</code> (descending).
filter	Object	No	Filters the result.

Parameter	Type	Required	Description
page	Object	No	The page object allows you to get the desired pages.

For more information on filtering, pagination, and sorting, see [Filtering, pagination, and sorting](#).

Response

```
{
  "page": {
    "offset": 0,
    "total": 1,
    "totalFilter": 1
  },
  "list": [
    {
      "targetLineNumber": 1,
      "targetAction": "TerminalEmulator-connectV2",
      "isReviewRequired": true,
      "reason": "'Terminal Emulator - Connect' action has been migrated.\n\nThe connection type is configured as 'SSH2' since 'SSH1' is not supported in A360.\n\nNo further action required.\n\nMessage Code: R114",
      "remarks": "",
      "id": 1309,
      "sourceLineNumber": 1,
      "sourceAction": "TE-Connect",
      "targetNodeUid": "ba97973a-e231-44b3-b208-1056dc2520d8",
      "targetPackageName": "TerminalEmulator",
      "targetPackageVersion": "4.3.0-20211016-070439",
      "isActionRequired": false,
      "actionRequiredReason": "",
      "reviewRequiredReasonMarkdown": "",
      "actionRequiredReasonMarkdown": ""
    }
  ]
}
```

The REST API responds to each request with an HTTP response code. For response codes, see [API response codes](#).

Response parameters

Parameter	Type	Description
targetLineNumber	Integer	The target line number in the migrated bot.
targetAction	String	The target action in the migrated bot.
isReviewRequired	Boolean	Specifies whether the action migrated requires your review.
reason	String	Describes the reason for the review required.
remarks	String	Provides more information on this migrated action.
id	Integer	ID of the migration action mapping result.
sourceLineNumber	Integer	Source line number in source bot.

Parameter	Type	Description
sourceAction	String	Source action in source bot
targetNodeUid	String	Target node UID
targetPackageName	String	Target action package name
targetPackageVersion	String	Target action package version
isActionRequired	Boolean	Specifies whether the action migrated requires your action
actionRequiredReason	String	Describes what action is required
reviewRequiredReasonMarkdow	String	Review required reason with support help link for the message code
actionRequiredReasonMarkdow	String	Action required reason with support help link for the message code

Note: You can view the in the , but API functionality is limited. You need a licensed Edition to access the full functionality of the APIs.

How to find a migration journalid

Migrations can have more than one journalid. You can find the journalid in the response of a results list for a specific migration id.

In this request, we searched for results for the migration with the id **16**.

```
<your_control_room_url>/v3/migration/16/results/list
```

The request returned the id in each object list as the journalid. In this example, there are two journal identifiers, 30 and 31, for the migration id 16.

```
{
  "page": {
    "offset": 0,
    "total": 2,
    "totalFilter": 2
  },
  "list": [
    {
      "sourceId": 12,
      "sourceName": "Dependency of IGN-23437.mbot",
      "sourcePath": "Automation Anywhere\\Bots\\My MetaBots\\
Dependency of IGN-23437.mbot",
      "sourceType": "application/vnd.aa.mbot",
      "targetId": 0,
      "status": "FAILED",
      "reason": "The logic IGN-23437 has some commands or actions
which are not yet supported for migration.",
      "selectedByUser": true,
      "userId": 9,
      "id": 30,
      "targetName": "",
      "targetPath": "",
      "targetType": ""
    },
  ],
}
```

```

    {
      "sourceId": 12,
      "sourceName": "Dependency of IGN-23437.mbot",
      "sourcePath": "Automation Anywhere\\Bots\\My MetaBots\\
Dependency of IGN-23437.mbot",
      "sourceType": "application/vnd.aa.mbot",
      "targetId": 0,
      "status": "FAILED",
      "reason": "Migration of MetaBot failed.",
      "selectedByUser": false,
      "userId": 9,
      "id": 31,
      "targetName": "",
      "targetPath": "",
      "targetType": ""
    }
  ]
}

```

You can use the migration id and journal id in an action mapping request.

```
<your_control_room_url>/v3/migration/16/journal/31/actionmappings/list
```

Enterprise 10 Migration APIs

Use migration APIs to migrate MetaBots and TaskBots that were created in Enterprise Client version Enterprise 10 to Automation 360. With these APIs, you can connect to the Enterprise 10 Control Room database, validate the master key and the repository path, and then start copying the Enterprise 10 data to Automation 360.

- Complete the prerequisites before migrating Enterprise 10 bots to Automation 360. See [Prerequisite tasks for migrating bots](#).
- You must have an admin role or the Manage Migration permission to validate connection parameters, connect to the Enterprise 10 database, and start 10.x migration process. If you want to retrieve a list of roles, users, credentials, and schedules, you need an admin role or the View Migration permission.
- Execute the following three APIs in order they are listed below. You can retrieve roles, users, credentials, bots, or schedules after you executed the mandatory APIs.

Connect to Enterprise 10 database

Use this API to connect to the Enterprise 10 Control Room database from which you can copy the data to Automation 360.

Note: You can view the in the , but API functionality is limited. You need a licensed Edition to access the full functionality of the APIs.

- Review the prerequisites before migrating bots to Automation 360.

[Prerequisite tasks for migrating bots](#)

- You must have an admin role or a custom role with **Manage Migration** permission to validate connection parameters and connect to the Enterprise 10 database.

1. All API calls must contain either an authentication token from [Authentication API](#) (generates JSON Web token) or a bearer token from OAuth services. You cannot use both together in an API.

- Use the POST method and endpoint URL: <your_control_room_url>/v2/migration/connection

Request body:

```
{
  "host": "10.000.000.000",
  "port": 1433,
  "databaseName": "CRDB",
  "username": "Admin",
  "password": "<password>",
  "integratedSecurity": false,
  "encrypt": false
}
```

Request parameters:

Parameter	Required	Type	Description
host	Yes	String	SQL server host name or IP address
port	Yes	Integer	SQL server port number
databaseName	Yes	String	Source Control Room database name
userName	Yes	String	A user name to connect to the database
password	Yes	String	Password to connect to the database
integratedSecurity	Yes	Boolean	Set this to <code>true</code> if you want use Windows authentication value is <code>false</code> .
encrypt	Yes	Boolean	Set this to <code>true</code> if you want to use a secure connection to database. The default value is <code>false</code> .

- Send the request.

Response body:

It returns a success response code and an empty string.

```
{ }
```

The REST API responds to each request with an HTTP response code. For response codes, see [API response codes](#).

Validate master key and repository path

Validate master key and repository path

Use this API to validate the Credential Vault master key and the repository path.

- You must have an admin role or a custom role with **Manage Migration** permission to validate the master key and the repository path.
- Complete this step [Connect to Enterprise 10 database](#) before executing this API.

- Add the authentication token or bearer token to the request header. You cannot use both in the same API.

- Use the POST method and endpoint URL:<your_control_room_url>/v2/migration/masterkey

Request body:

```
{
  "privateKey": "<CV master key value>",
  "repoPath": "C:\\Migration\\10X\\A2019.14\\Automation Anywhere Server Files"
}
```

If you are not able to get a response, add an additional backslash in the repoPath or use a single forward slash.

Request parameters:

Parameter	Required	Type	Description
privateKey	Yes	String	The master key to connect to Enterprise 10 Credential Vault. This is available for configuration during the initial Control Room setup.
repoPath	Yes	String	The shared repository path where the Control Room Enterprise 10 is located.

- Send the request.

Response body:

It returns a success response code and an empty string.

```
{ }
```

The REST API responds to each request with an HTTP response code. For response codes, see [API response codes](#).

Initiate the 10.x data migration process

Initiate Enterprise 10 data migration process

Use this API to start the Enterprise 10 data migration.

- You must have an admin role or a custom role with **Manage Migration** permission to start the Enterprise 10 data migration.
- Complete this step [Validate master key and repository path](#) before executing this API.

- Add the authentication token or bearer token to the request header. You cannot use both in the same API.

- Use the POST method and endpoint URL:<your_control_room_url>/v2/migration/start

Request body:

```
{
  "name": "Migration-10x-001",
  "description": "10x bot migration to A2019 001"
}
```

```
}

```

Request parameters:

Parameter	Required	Type	Description
name	Yes	String	The name for the migration entity.
description	No	String	A short description for the migration.

3. Send the request.**Response body:**

```
{
  "id": "1",
  "name": "Migration-10x-001",
  "createdBy": "10",
  "migrationType": "ROLE",
  "entities": []
}
```

Response parameters:

Parameter	Description
id	The migration ID This is used for internal purpose only.
name	The migration name.
createdBy	ID of the user who has initiated this migration.
migrationType	Indicates the data migration type: Role or Bot This is used for Enterprise 10 migration only.
entities	List of migration entities.

The REST API responds to each request with an HTTP response code. For response codes, see [API response codes](#).

[Retrieve a list of migration roles](#)

Retrieve migrated roles

Use this API to retrieve Enterprise 10 roles that are copied to the Automation 360 database.

You must have an admin role or a custom role with **View Migration** permission to retrieve migrated roles.

1. Add the authentication token or bearer token to the request header. You cannot use both in the same API.
2. Use the ID from the API response body as the migrationId.
See [Initiate Enterprise 10 data migration process](#).

3. Use the POST method and endpoint URL:<your_control_room_url>/v2/migration/{migrationId}/roles/list

Request body:

```
{
  "sort": [],
  "filter": {},
  "page": {
    "offset": 0,
    "total": 100,
    "totalFilter": 100,
    "length": 200
  }
}
```

Request parameters:

Parameter	Required	Type	Description
sort	No	String	Sort directions
filter	No	String	Filter rules
page	Yes	Integer	Pagination rules
offset	Yes	Integer	Page starting index
total	No	Integer	Total number of items
totalFilter	No	Integer	Total number of items matching the filter
length	Yes	Integer	Number of items to be returned

4. Send the request.

Response body:

```
{
  "page": {
    "offset": 0,
    "total": 9,
    "totalFilter": 9
  },
  "list": [
    {
      "id": 1,
      "type": "ROLE",
      "sourceId": "1",
      "targetId": 1,
      "name": "Admin",
      "status": "SUCCESS",
      "reason": "",
      "targetPath": ""
    },
    {
      "id": 2,
      "type": "ROLE",
      "sourceId": "2",
      "targetId": 2,
      "name": "Basic",
      "status": "SUCCESS",
      "reason": "",
      "targetPath": ""
    }
  ],
}
```

```

.....
{
  "id": 9,
  "type": "ROLE",
  "sourceId": "9",
  "targetId": 24,
  "name": "Admin_Role01",
  "status": "SUCCESS",
  "reason": "",
  "targetPath": ""
}
]
}

```

Response parameters:

Parameter	Description
list	List of roles.
id	The role ID. This ID is used for UI purposes only.
type	The migration type.
sourceId	The source (database) role ID.
targetId	The migrated role ID.
name	A role name.
status	The migration status Valid values: Success, Skipped, or Failed.
reason	The reason why the migration failed.
targetPath	The migrated bot file location. It is only applicable for the bot migration.

The REST API responds to each request with an HTTP response code. For response codes, see [API response codes](#).

Retrieve a list of migrated users

Retrieve migrated users

Use this API to retrieve Enterprise 10 database users that are copied to the Automation 360 database.

You must have an admin role or a custom role with **View Migration** permission to retrieve migrated users.

1. Add the authentication token or bearer token to the request header. You cannot use both in the same API.
2. Use the ID from the API response as the migrationId.
See [Initiate Enterprise 10 data migration process](#).

3. Use the POST method and endpoint URL:<your_control_room_url>/v2/migration/{migrationId}/users/list

Request body:

```
{
  "sort": [],
  "filter": {},
  "page": {
    "offset": 0,
    "total": 100,
    "totalFilter": 100,
    "length": 200
  }
}
```

Request parameters:

Parameter	Required	Type	Description
sort	No	String	Sort directions
filter	No	String	Filter rules
page	Yes	Integer	Pagination rules
offset	Yes	Integer	Page starting index
total	No	Integer	Total number of items
totalFilter	No	Integer	Total number of items matching filter
length	Yes	Integer	Number of items to be returned

4. Send the request.

Response body:

```
{
  "page": {
    "offset": 0,
    "total": 5,
    "totalFilter": 5
  },
  "list": [
    {
      "id": 10,
      "type": "USER",
      "sourceId": "1",
      "targetId": 11,
      "name": "admin_1",
      "status": "SUCCESS",
      "reason": "The user admin has been renamed to admin_1 as the user
with same name already exists",
      "targetPath": ""
    },
    .....
    {
      "id": 14,
      "type": "USER",
      "sourceId": "5",
      "targetId": 15,
      "name": "admin10503",
      "status": "SUCCESS",
      "reason": "",

```

```

    "targetPath": ""
  }
]
}

```

Response parameters:

Parameter	Description
list	List of users
id	The user ID It is used for UI purpose only.
type	The migration type
sourceId	The source (database) user ID
targetId	The migrated user ID
name	A user name
status	The migration status Valid values: Success, Skipped, or Failed.
reason	The reason why the migration failed.
targetPath	The migrated bot file location It is only applicable for bot migration.

The REST API responds to each request with an HTTP response code. For response codes, see [API response codes](#).

Retrieve a list of migrated credentials

Retrieve migrated credentials

Use this API to retrieve Enterprise 10 database credentials that are copied to the Automation 360 database.

You must have an admin role or a custom role with **View Migration** permission to retrieve migrated credentials.

1. Add the authentication token or bearer token to the request header. You cannot use both in the same API. Use the HTTP request syntax (URL):
2. Use the ID from the API response body as the migrationId.
See [Initiate Enterprise 10 data migration process](#).
3. Use the POST method and endpoint URL: <your_control_room_url>/v2/migration/{migrationId}/credentials/list

Request body:

```

{
  "sort": [],
  "filter": {},
  "page": {
    "offset": 0,
    "total": 100,

```

```

    "totalFilter": 100,
    "length": 200
  }
}

```

Request parameters:

Parameter	Required	Type	Description
sort	No	String	Sort directions
filter	No	String	Filter rules
page	No	Integer	Pagination rules
offset	Yes	Integer	Page starting index
total	No	Integer	Total number of items
totalFilter	No	Integer	Total number of items matching the filter
length	Yes	Integer	Number of items to be returned

4. Send the request.**Response body:**

```

{
  "page": {
    "offset": 0,
    "total": 2,
    "totalFilter": 2
  },
  "list": [
    {
      "id": 15,
      "type": "CREDENTIAL",
      "sourceId": "4",
      "targetId": 2,
      "name": "admin10501 - Email Settings",
      "status": "SUCCESS",
      "reason": "",
      "targetPath": ""
    },
    {
      "id": 16,
      "type": "CREDENTIAL",
      "sourceId": "5",
      "targetId": 2,
      "name": "admin10502 - Email Settings",
      "status": "SUCCESS",
      "reason": "",
      "targetPath": ""
    }
  ]
}

```

Response parameters:

Parameter	Description
list	List of credentials
id	The credential ID

Parameter	Description
type	The migration type
sourceId	The source (database) credential ID
targetId	The migrated credential ID
name	A credential name
status	The migration status Valid values: Success, Skipped, or Failed.
reason	The reason why the migration failed
targetPath	The migrated bot file location It is only applicable for the bot migration.

The REST API responds to each request with an HTTP response code. For response codes, see [API response codes](#).

Retrieve a list of migrated bots

Retrieve migrated bots

Use this API to retrieve a list of Enterprise 10 migrated bots that are copied to the Automation 360 database.

You must have an admin role or a custom role with **View Migration** permission to retrieve migrated bots.

1. Add the authentication token or bearer token to the request header. You cannot use both in the same API. Use the HTTP request syntax (URL):
2. Use the ID from the API response body as the migrationId.
See [Initiate Enterprise 10 data migration process](#).
3. Use the POST method and endpoint URL: <your_control_room_url>/v2/migration/{migrationId}/bots/list

Request body:

```
{
  "sort": [],
  "filter": {},
  "page": {
    "offset": 0,
    "total": 100,
    "totalFilter": 100,
    "length": 200
  }
}
```

Request parameters:

Parameter	Required	Type	Description
sort	No	String	Sort directions
filter	No	String	Filter rules

Parameter	Required	Type	Description
page	No	Integer	Pagination rules
offset	Yes	Integer	Page starting index
total	No	Integer	Total number of items
totalFilter	No	Integer	Total number of items matching the filter
length	Yes	Integer	Number of items to be returned

4. Send the request.Send the request.

Response body:

```
{
  "page": {
    "offset": 0,
    "total": 1004,
    "totalFilter": 1004
  },
  "list": [
    {
      "id": 17,
      "type": "BOT",
      "sourceId": "186",
      "targetId": 15,
      "name": "DelayLoop - Copy (129).atmx",
      "status": "SUCCESS",
      "reason": "",
      "targetPath": "Automation Anywhere\\Bots\\My Tasks\\Migration
Extra"
    },
    {
      "id": 18,
      "type": "BOT",
      "sourceId": "438",
      "targetId": 17,
      "name": "DelayLoop - Copy (115).atmx",
      "status": "SUCCESS",
      "reason": "",
      "targetPath": "Automation Anywhere\\Bots\\My Tasks\\Migration Extra
\\RM-APIAutomation"
    },
    .....
    {
      "id": 216,
      "type": "BOT",
      "sourceId": "703",
      "targetId": 221,
      "name": "DelayLoop - Copy (132).atmx",
      "status": "SUCCESS",
      "reason": "",
      "targetPath": "Automation Anywhere\\Bots\\My Tasks"
    }
  ]
}
```

Response parameters:

Parameter	Description
list	List of bots

Parameter	Description
id	The bot ID
type	The migration type
sourceId	The source (database) bot ID
targetId	The migrated bot ID
name	The bot name
status	The migration status Valid values: Success, Skipped, or Failed.
reason	The reason why the migration failed
targetPath	The migrated bot file location

The REST API responds to each request with an HTTP response code. For response codes, see [API response codes](#).

Retrieve a list of migrated schedules

Retrieve migrated schedules

Use this API to retrieve a list of Enterprise 10 migrated schedules that are copied to the Automation 360 database.

You must have an admin role or a custom role with **View Migration** permission to retrieve migrated schedules.

1. Add the authentication token or bearer token to the request header. You cannot use both in the same API.
2. Use the ID from the API response body as the migrationId .
See [Initiate Enterprise 10 data migration process](#).
3. Use the POST method and endpoint URL:<your_control_room_url>/v2/migration/{migrationId}/schedules/list

Request body:

```
{
  "sort": [],
  "filter": {},
  "page": {
    "offset": 0,
    "total": 100,
    "totalFilter": 100,
    "length": 200
  }
}
```

Request parameters:

Parameter	Required	Type	Description
sort	No	String	Sort directions
filter	No	String	Filter rules

Parameter	Required	Type	Description
page	No	Integer	Pagination rules
offset	Yes	Integer	Page starting index
total	No	Integer	Total number of items
totalFilter	No	Integer	Total number of items matching the filter
length	Yes	Integer	Number of items to be returned

4. Send the request.

Response body:

```
{
  "page": {
    "offset": 0,
    "total": 7,
    "totalFilter": 7
  },
  "list": [
    {
      "id": 1173,
      "type": "SCHEDULE",
      "sourceId": "3",
      "targetId": 2,
      "name": "Monthly",
      "status": "SUCCESS",
      "reason": "",
      "targetPath": ""
    },
    {
      "id": 1174,
      "type": "SCHEDULE",
      "sourceId": "5",
      "targetId": 3,
      "name": "alternatemonths",
      "status": "SUCCESS",
      "reason": "",
      "targetPath": ""
    },
    .....
    {
      "id": 1179,
      "type": "SCHEDULE",
      "sourceId": "15",
      "targetId": 8,
      "name": "none",
      "status": "SUCCESS",
      "reason": "",
      "targetPath": ""
    }
  ]
}
```

Response parameters:

Parameter	Description
list	List of schedules
id	The schedule ID

Parameter	Description
type	The migration type
sourceId	The source (database) schedule ID
targetId	The migrated schedule ID
name	The schedule name
status	The migration status Valid values: Success, Skipped, or Failed.
reason	The reason why the migration failed
targetPath	The migrated bot file location It is only applicable for the bot migration.

The REST API responds to each request with an HTTP response code. For response codes, see [API response codes](#).

Filtering, pagination, and sorting

The Control Room API supports filtering, pagination, and sorting for endpoints that return arrays of resources.

The filtering mechanism filters the required resources, the sorting mechanism places the resources in order; and the pagination mechanism then returns a specific range of those ordered resources. This topic provides you the details to filter and sort the results of an API requests and also guides to handle the pagination of large result sets returned from an API request.

Note:

- Sorting and filtering are supported for substrings. For example, if you want to search for bots or files that have `fin` in their names, enter `fin` as the search criterion. All the bots and files that contain `fin` in the names will be displayed, for example, Finance, Finder, DeltaFinance, and Dolfin.
 - Wildcards are not supported for searching and filtering bots or files.
-

Filtering

Filtering allows you to apply Boolean condition against a collection of returned resources in order to subset the collection to only those resources for which the condition is `true`. The most basic operation in an Control Room API filters is to compare a field to a given value. It is possible to use *equality comparison*, *range comparison*, or *logical* . Use the following operators to compare a field to a constant value.

Operation	Description	Example
Equality comparison		
eq	Equals	UserEmailAddress, eq first.last@aa.com

Operation	Description	Example
ne	Not Equals	UserEmailAddress, ne first.last@aa.com
Range comparison		
lt	Less than	Quantity lt 1500
le	Less Than or Equal	Quantity le 1500
ge	Greater Than or Equal	CreatedDateUtc ge 2021-03-15
gt	Greater Than	CreatedDateUtc gt 2021-03-15
Logical		
and	And	Field1 eq 'abc' and Field2 eq 'def'
or	Or	Field1 eq 'abc' or Field2 eq 'def'

The `filter` query parameter allows you to apply basic, multiple, and convention oriented filters to a request. The filters in the Control Room APIs are applied with single parameter or with multiple parameters.

Single parameter filter

Single parameter filter allows the API request to select the responses by matching one or more members of the response to the value passed in the query. The single parameter filter is represented in the following image:

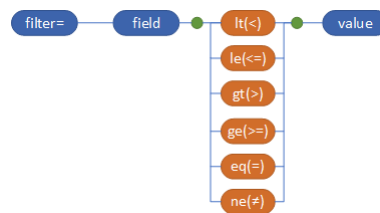

The JSON equivalent of the above image (single parameter filter) looks like:

```

{
  "filter": {
    "operator": "<NONE, lt, le, eq, ne, ge, gt, substring, and, or, not>",
    "field": "string",
    "value": "string"
  }
}

```

For example, to list all the device pools that has a substring `finance`, use the following single parameter filter:

```
POST http://{{ControlRoomURL}}/v2/devices/pools/list
```

```

{
  "filter": {
    "operator": "substring",
    "field": "name",
    "value": "finance"
  }
}

```

For more detailed sample on a single parameter filter, see [List device pools API](#).

Multiple parameter filter

Multiple parameter filter allows you to filter the results based on combining multiple conditions wrapped in logical operands `and` and `or`.

- `and`: A binary operator that evaluates to `true` if all the conditions in the operands evaluate to `true`.

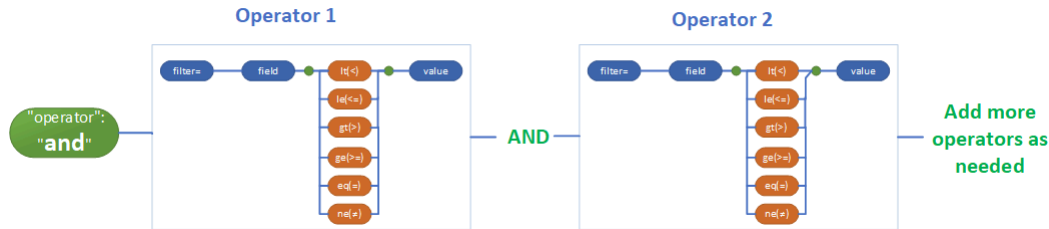

- `or`: A binary operator that evaluates to `true` if atleast one of the conditions in the operands evaluate to `true`.

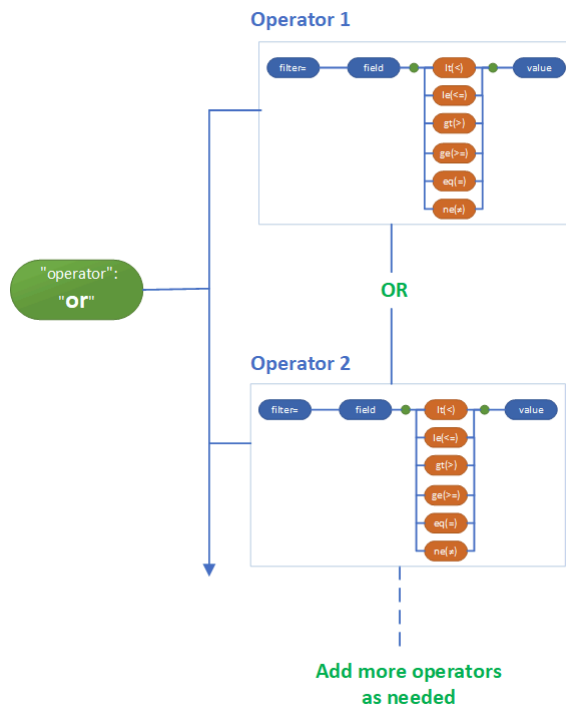

The JSON equivalent of the above image (multiple parameter filter) looks like:

```
{
  "filter": {
    "operator": "<and, or>",
    "operands": [
      {
        "operator": "<NONE, lt, le, eq, ne, ge, gt, substring, and, or, not>",
        "field": "string",
        "value": "string"
      },
      {
        "operator": "<NONE, lt, le, eq, ne, ge, gt, substring, and, or, not>",
        "field": "string",

```

```

    "value": "string"
  }
]
}
}

```

For example, to list all the roles that has a substring `Device`, `createdOn` is after `2022-04-01`, and `createdOn` is before `2022-05-31`, use the multiple parameter filtering with logical `and` operator as follows:

```
POST http://{{ControlRoomURL}}/v1/usermanagement/roles/list
```

```

{
  "filter":{
    "operator":"and",
    "operands":[
      {
        "operator":"substring",
        "field":"name",
        "value":"Device"
      },
      {
        "operator":"gt",
        "field":"createdOn",
        "value":"2022-04-01T00:00:00.989Z"
      },
      {
        "operator":"lt",
        "field":"createdOn",
        "value":"2022-05-31T23:00:00.123Z"
      }
    ]
  }
}

```

For more detailed sample on a single parameter filter, see [List roles](#).

Pagination

Pagination allows you to:

- Retrieve a limited collection of results.
- Offset a collection of results.

All Control Room APIs that returns a collection of records are paginated. API methods that support pagination takes two (optional) parameters:

Operation	Description
offset	The offset parameter controls the starting point within the collection of response results. Default value is 0.
length	The length parameter is the maximum number of records to retrieve starting from the offset. Default value is 200.

The JSON snippet for pagination looks like:

```
"page": {
```

```

    "offset":5,
    "length":10
  }

```

For more detailed sample on a single parameter filter, see [List roles](#).

Sorting

Sorting allows you to order the results by any field, in ascending or descending order. For example, if you are returning the roles, you can sort the roles by last modified date.

```

"sort": [
  {
    "field": "string",
    "direction": "<asc, desc>"
  }
]

```

Direction

Type: Enum [desc, asc]

- asc = ascending (smallest to largest, 0 to 9, A to Z)
- desc = descending (largest to smallest, 9 to 0, Z to A)

For more detailed sample on a single parameter filter, see [List roles](#).

API response codes

Review the HTTP status codes of responses for Automation 360 APIs.

Status code	HTTP name	Description
200	OK	Success
201	Created	Success, for POST, PATCH or PUT requests.
202	Accepted	Indicates that the request has been accepted for processing, but the processing has not been completed.
204	No content	Success, for DELETE requests and some PATCH requests.
400	Bad request	Request URL or request parameters are incorrect.
401	Authentication required	Provide authentication details.
403	Unauthorized access	The operation is not authorized.
404	Not found	Control Room server did not find the requested URL.
409	Conflict	The request could not be completed because the code conflicts with the current state of the resource, for example, a duplicate entry.

Status code	HTTP name	Description
500	Internal server error	Indicates that the server encountered a problem. Clear the cookies and cache, and then reload the page.

Comparing Automation 360 and Enterprise 11 APIs

Compare Automation 360 and Enterprise 11 APIs to understand the contract changes when you migrate from Enterprise 11 to Automation 360.

API details	Enterprise 11	Automation 360
Authentication API: Use this API to obtain the authentication token. The token is then used for all subsequent API calls.		
Method	POST	POST
Endpoint	v1/authentication	v1/authentication
Request body changes	Not applicable	No change
Response body changes	Not applicable	<ul style="list-style-type: none"> Multi-factor authentication is not supported Automation 360 response returns the <code>tenantUUID</code>
Auto login credentials API: Use this API to set the Windows credentials for a Bot Runner. These credentials are used for automatically login (auto-login).		
Method	POST	PUT
Endpoint	v1/credentialvault/external/credentials/loginsetting	v2/credentialvault/loginsetting
Request body changes	Not applicable	Endpoint version change
Response body changes	Not applicable	<p>Message displayed after successfully updating the credentials: Credentials updated for <username>.</p> <p>Enterprise 11 displays this message: Credentials were successfully updated.</p>
Automation management API: Use this API to create automations (schedule bots), and edit and delete automations.		
Method	POST, PUT, and DELETE	POST, PUT, GET, and DELETE
Endpoint	v1/schedule	v1/schedule
Request body changes	Not applicable	Minor change in request body to pass bot input variables
Response body changes	Not applicable	Detailed response with bot input variable details

API details	Enterprise 11	Automation 360
User Management API: Use this API to create, edit, and delete users and roles.		
Method	POST, PUT, GET, and DELETE	POST, PUT, GET, and DELETE
Endpoint	v1/usermanagement	v1/usermanagement
Request body changes	Not applicable	No change
Response body changes	Not applicable	No change
Migration API: Use this API to migrate bots from Enterprise 11 or Enterprise 10 to Automation 360		
Method	GET and POST	GET and POST
Endpoint	<ul style="list-style-type: none"> v1/migration v2/migration 	v2/migration
Response body changes	Not applicable	<ul style="list-style-type: none"> Endpoint version change APIs used to connect to the Enterprise 10 database to migrate users, roles, schedules, and bots
Request body changes	Not applicable	Because the endpoints and request body are different, the response body is also different.
Manual Dependency API: Use this API to add or remove a dependency (data files and such) to or from a bot.		
Method	POST and DELETE	Not available
Endpoint	v1/files/ manualdependencies/	Not available
Request body changes	Not applicable	Not available
Response body changes	Not applicable	Not available
Repository Management API: Use this API to get bots and files from the Control Room repository.		
Method	POST, DELETE, and GET	POST, DELETE, and GET
Endpoint	v1/repository	v1/repository
Request body changes	Not applicable	Additional APIs added to get folder permissions
Response body changes	Not applicable	No change
File Dependency API: Use this API to get the file dependency metadata to run and schedule bots.		
Method	GET	Not available
Endpoint	v1/files/ manualdependencies/	Not available
Request body changes	Not applicable	Not available

API details	Enterprise 11	Automation 360
Response body changes	Not applicable	Not available
Bot Lifecycle Management (BLM) API: Use this API to move (export or import) bots and dependent files across different Control Room environments.		
Method	POST	POST
Endpoint	v1/blm	v2/blm
Request body changes	Not applicable	<ul style="list-style-type: none"> Endpoint version change You cannot choose dependencies when exporting and importing
Response body changes	Not applicable	No change
Audit API: Use this API to get audit information about the product.		
Method	POST	POST
Endpoint	v1/audit	v1/audit
Request body changes	Not applicable	No change
Response body changes	Not applicable	No change
Two-factor Authentication (2FA) API: Use this API to generate a 2FA token		
Method	GET and POST	Not available
Endpoint	v1/mfa	Not available
Request body changes	Not applicable	Not available
Response body changes	Not applicable	Not available
Credential Vault API: Use this API to create, edit, and delete credentials and lockers.		
Method	POST, PUT, GET, and DELETE	POST, PUT, GET, and DELETE
Endpoint	v2/credentialvault	v2/credentialvault
Request body changes	Not applicable	No change
Response body changes	Not applicable	No change
Bot Execution Orchestration API: Use this API to get the repository, automations, and devices list.		
Method	POST	POST, PUT, GET, and DELETE
Endpoint	v2/automations/deploy	v3/automations/deploy
Request body changes	Not applicable	Bot deployment includes run-as users
Response body changes	Not applicable	Returns <code>deploymentID</code> . Enterprise 11 API response returns <code>automationID</code> .
License API: Use this API to get product license information.		
Method	GET	GET

API details	Enterprise 11	Automation 360
Endpoint	v2/license	v2/license
Request body changes	Not applicable	No change
Response body changes	Not applicable	Additional APIs added to update with license server and additional details
Workload Management (WLM) API: Use this API to create, edit, and delete workload queues, templates, and work items.		
Method	POST, PUT, GET, and DELETE	POST, PUT, GET, and DELETE
Endpoint	v2/wlm	v3/wlm
Request body changes	Not applicable	No change
Response body changes	Not applicable	More APIs to manage WLM entities
Bot Insight API: Use this API to get Bot Insight data for an automation.		
Method	POST, GET, and DELETE	POST, GET, and DELETE
Endpoint	v2/botinsight/data/api	v2/botinsight/data/api
Request body changes	Not applicable	No change
Response body changes	Not applicable	No change
Bot Insight JSON API: Use to get business insights for an automation.		
Method	GET	Not applicable
Endpoint	v2/botinsight/data/api	Not applicable
Request body changes	Not applicable	Not applicable
Response body changes	Not applicable	Merged with Bot Insight API

Related concepts

[Control Room APIs](#)

The Automation Anywhere Control Room provides APIs that allow you to customize the way that you (and your bots) interact with Automation Anywhere. Control Room APIs allows you to perform tasks such as manage bot deployments, create and manage credentials in the Credential Vault, create and manage user accounts and roles, and create and manage queues.

Index

Numerics

10x migration apis [2906](#)
11x migration apis [2906](#)

A

a-people access [2684](#), [2686](#)
a2019 [1006](#)
A2019 [2689](#)
A2019 IQ Bot [964](#), [975](#)
A2019 IQ Bot installation [964](#), [975](#), [1006](#)
A2019 IQBot [964](#), [975](#)
aa settings [1121](#)
AA Settings [1121](#)
aasettings [1121](#)
access authconfig app [2523](#)
acs [873](#)
action [1819](#)
action mapping
 migration [2914](#)
action package [2402](#)
action package sdk [2151](#)
active [2373](#)
Active Directory
 create
 user [2446](#)
activity
 historical [2383](#)
 in-progress [2383](#)
Activity List [2815](#), [2820](#)
Activity table [2376](#), [2378](#)
activity type [2373](#)
add ip [2492](#)
add-bots [2555](#)
add-device-pools [2556](#)
add-queue-owners [2548](#)
add-queues [2556](#)
Administration
 overview [2413](#)
administrator mode [864](#), [886](#)
advanced
 bots [2151](#)
analytics [1337](#), [1534](#), [1586](#), [1588](#), [1590](#), [1592](#)
introduction to Bot Insight [2709](#)
analytics connector [2716](#)
analyze [2574](#)
Analyze [2689](#)
annotation
 creation [2197](#), [2198](#)
 function [2197](#), [2198](#)
 validation [2197](#), [2200](#)
annotations [2197](#), [2198](#), [2200](#)
anti-virus settings [860](#)
api [2866](#)
 See also device pool
api filters [2930](#)
API Migration [1216](#)

Apigee [1267](#), [1267](#), [1270](#)
Apigee actions [1267](#)
Apigee Connect [1267](#)
Apigee package [1267](#)
asynchronous [862](#)
asynchronous replication [793](#), [1017](#)
attended bot runner
 license [904](#)
attributes [2703](#), [2704](#)
Audit API [2788](#)
audit log controls [2413](#)
audit logs [2413](#), [2441](#)
authconfig app [2522](#)
authconfig app control rooms [2524](#)
authconfig app refresh tokens [2527](#)
authconfig app saml [2527](#)
auto mode [878](#)
auto-update bot agent [943](#)
auto-update package [2483](#)
automation
 priority [2397](#), [2398](#)
automation 360 cloud [51](#)
Automation Anywhere Enterprise
 operating system compatibility [731](#), [752](#)
aws cloud integration [2642](#)
aws configuration postinstallation [2640](#)
aws credential retrieval [2643](#)
aws installation [2637](#)
aws integration [2636](#), [2637](#)
aws onprem authentication type [2639](#)
aws onprem installation [2638](#)
aws onprem installation requirements [2638](#)
aws onprem integration [2638](#)
AWS Secrets Manager [2593](#)
Azure
 cluster configuration [835](#)
 customize cluster [831](#)
azure cloud integration [2628](#)
Azure cluster environment [830](#)
azure configuration postinstallation [2626](#)
azure credential retrieval [2629](#)
azure installation [2623](#)
azure integration [2622](#), [2623](#)
Azure Key Vault [2593](#)
azure onprem authentication type [2626](#)
azure onprem installation [2624](#)
azure onprem installation requirements [2624](#)
azure onprem integration [2625](#)

B

background process [1615](#), [1781](#)
backup
 databases [747](#)
 DR [797](#)
basic auth eol [697](#), [703](#)
Boomi [1281](#), [1282](#), [1283](#), [1284](#), [1285](#), [1286](#), [1287](#), [1288](#),
[1289](#), [1290](#)

Boomi actions [1281](#), [1282](#), [1283](#), [1284](#), [1285](#), [1286](#), [1287](#),
[1288](#), [1289](#), [1290](#)
 Boomi Convert Atom list to CSV [1284](#)
 Boomi Convert Process list to CSV [1286](#), [1288](#)
 Boomi Convert Process list to Table [1287](#)
 Boomi List Atoms [1283](#)
 Boomi List execution records [1289](#)
 Boomi List Processes [1285](#)
 Boomi package [1281](#)
 Boomi Session End [1290](#)
 Boomi Session Start [1282](#)
 bot agent resiliency [44](#)
 bot creator
 license [904](#)
 Bot Creator
 ports required [760](#)
 bot creator credentials [2574](#)
 bot insight
 license [904](#)
 Bot Insight
 using [2709](#)
 bot insight migration [1077](#)
 Bot Insight overview [2689](#)
 bot migration wizard [1102](#)
 Bot Permissions [2777](#)
 Bot Runner
 ports required [760](#)
 Bot Runners
 disaster recovery [794](#), [1018](#)
 bots
 advanced [2151](#)
 first [954](#)
 hello world [954](#)
 browsers [766](#)
 bulk update package [2411](#)
 business data [25](#)

C

c [1395](#)
 cache storage [862](#)
 caching [862](#)
 capture image [1551](#), [1552](#), [1553](#), [1554](#), [1555](#)
 Certificate [804](#)
 certificates
 required [860](#)
 change [2451](#)
 change key vault [2649](#)
 change password [2662](#)
 changed features [521](#), [531](#), [538](#), [544](#), [550](#), [557](#), [558](#)
 chat-bot [2571](#)
 check in [2465](#)
 check out [2465](#)
 client
 prerequisites [746](#)
 client service
 disaster recovery [794](#), [1018](#)
 Close [1265](#)
 cloud
 install [727](#)
 Cloud communication ports [736](#)
 cloud enabled [25](#), [870](#)

cloud faq [51](#)
 cloud integration aws secrets manager [2642](#)
 cloud integration azure key vault [2628](#)
 cloud integration cyberark password vault [2615](#)
 cloud license [910](#)
 cloud security [25](#)
 cloud services faq [51](#)
 cloud updates [664](#)
 cloud-enabled [870](#)
 cluster
 Control Room on Azure [831](#)
 processes [1013](#)
 Cluster [813](#)
 cluster mode [978](#)
 cluster setup [800](#)
 code analysis [2537](#)
 codes [2934](#)
 communication ports [736](#)
 compatibility version [1843](#)
 concurrent operations [744](#)
 configuration
 AD mode [878](#)
 control room [874](#)
 DR [793](#), [1017](#)
 configure
 Azure cluster [835](#)
 configure build files [2158](#)
 configure saml [2527](#)
 configuring Control Room with HTTPS [989](#), [991](#), [991](#), [992](#)
 configuring IQ Bot with HTTP [989](#), [991](#), [991](#), [992](#)
 confirm installation [982](#)
 connect 10x database [2917](#)
 connected [2388](#)
 Connection
 Credential Vault [2497](#)
 Control Room
 Azure cluster configuration [835](#)
 Azure install [831](#)
 customize cluster [831](#)
 data center components [19](#)
 database [747](#)
 disaster recovery [794](#), [1018](#)
 HA and DR [1011](#)
 ports required [760](#)
 prerequisites [746](#)
 control room api [2866](#)
 control room configuration
 workflow [874](#)
 control room login [915](#)
 control room resiliency [44](#)
 control room service [862](#)
 copy bot [1831](#)
 Create
 role [2452](#)
 Create Event Trigger API [2793](#)
 create folder [2575](#)
 Create Iterator [2176](#)
 create repository [2575](#)
 create role [2574](#)
 Create role [2740](#)
 Create Role API [2740](#)
 create user [2574](#), [2576](#)

- Create user
 - Active Directory [2446](#)
- create worksheet [1403](#)
- create-queue [2547](#)
- createdOn [2788](#)
- creation annotation [2197](#), [2198](#)
- credential [2587](#)
- Credential
 - edit [2588](#)
- credential allow password [2201](#)
- credential locker [2589](#)
- credential name [2585](#)
- credential vault [2585](#)
- Credential Vault
 - connection [2497](#)
 - email notification [2591](#)
- credentials
 - required [860](#)
 - requirements [755](#)
- Credentials
 - overview [2584](#)
- cryptographic provider [34](#)
- csv [2388](#), [2441](#)
- current bot [2373](#)
- current command [2373](#)
- custom install [800](#)
- custom installation [876](#), [878](#), [884](#)
- custom launch cycle [876](#), [878](#), [884](#)
- custom mode [819](#), [876](#), [878](#), [884](#)
- custom variables [2168](#)
- cyberark cloud integration [2615](#)
- cyberark configuration postinstallation [2612](#)
- cyberark credential retrieval [2617](#)
- cyberark installation [2609](#)
- cyberark integration [2602](#), [2609](#)
- cyberark onprem installation [2610](#)
- CyberArk Password Vault [2593](#)

D

- dashboards [2690](#), [2692](#), [2695](#), [2698](#), [2703](#), [2704](#), [2711](#), [2712](#)
- data center
 - Control Room [19](#)
- data privacy [25](#)
- data security [25](#)
- database
 - control room [747](#)
 - disaster recovery [794](#), [1018](#)
 - server requirements [747](#)
 - SQL [747](#)
- database management system [742](#)
- database replication [790](#), [1016](#)
- databases
 - backup [747](#)
 - recovery [747](#)
- delete
 - scheduled [2383](#)
- Delete Event Trigger API [2795](#)
- delete task [1819](#)
- delete-work-item [2570](#)
- delta migration [1097](#)

- dependencies
 - uploading [1871](#)
- deploy
 - HA [789](#), [790](#), [1015](#), [1016](#)
 - load balancer [758](#)
 - model options [784](#)
- Deploy [2876](#), [2881](#)
- Deploy API [2876](#), [2881](#)
- deployment
 - concurrent operations [744](#)
 - time to start [744](#)
- deprecated [521](#), [531](#), [538](#), [544](#), [550](#), [557](#), [558](#)
- developer [2151](#)
- developer sdk [2151](#)
- device licenses [2539](#)
- device pool
 - create [2395](#), [2399](#)
 - details [2396](#)
 - edit [2397](#), [2398](#)
 - update [2397](#), [2398](#)
 - view [2396](#)
- device pool api [2866](#)
- device pool consumer [2866](#)
- device pool owner [2866](#)
- devices [2388](#)
- dictionary type variables [1927](#)
- disaster recovery
 - failover steps [794](#), [1018](#)
 - HA [790](#), [1016](#)
 - sites [797](#)
- Disaster Recovery (DR) [1011](#)
- disconnected [2388](#)
- disk space [742](#)
- do not repeat [1727](#)
- Document Validator Task [2340](#)
- domain user account [750](#)
- DR
 - pre-configuration requirements [793](#), [1017](#)
 - prepare [797](#)
 - restore primary site [1018](#)
- draw down [910](#)
- draw downs [910](#)

E

- Edit
 - credential [2588](#)
 - locker [2590](#)
- edit profile [2662](#)
- edit sql [865](#), [2498](#)
- edit task [1819](#)
- edit-work-item [2570](#)
- elasticsearch [862](#)
- Email
 - notifications
 - Credential Vault [2591](#)
- embedded, aari, extensions, deploy, blueprint [2058](#)
- enable oauth services [2522](#)
- entry list rest web services [2170](#)
- eol [667](#)
- equal to [1291](#)
- Error codes [2934](#)

example [1892](#), [2465](#), [2574](#), [2575](#), [2576](#), [2585](#)
 example bulk update [1919](#)
 example repository [2575](#)
 example, Genesys [2064](#)
 example, ServiceNow, SAP, embedded automation [2079](#)
 example, Workday [2070](#)
 excel action [1414](#)
 Execute Integration [1270](#)
 Expire [2736](#)
 Expire token [2736](#)
 expiry [896](#), [912](#)
 export [2441](#)
 express launch cycle [875](#)
 express mode [819](#), [875](#)
 external key vault [2591](#), [2593](#)
 external key vault on-premises integration [804](#)
 extract text from image [1551](#), [1552](#), [1553](#), [1554](#), [1555](#)

F

failover mode [790](#), [1016](#)
 failover steps [794](#), [1018](#)
 failsafe [896](#)
 faq [51](#)
 feature (comparison) (matrix)) [636](#)
 file name [1337](#), [1534](#), [1586](#), [1588](#), [1590](#), [1592](#)
 file2 attribute [2172](#)
 filter apis [2930](#)
 filters [2703](#), [2704](#), [2930](#)
 find [1414](#)
 first bot [954](#)
 first time configuration
 control room [874](#)
 fixed features [521](#), [531](#), [538](#), [544](#), [550](#), [557](#), [558](#)
 function annotation [2197](#), [2198](#)

G

gcp migration [141](#)
 generate API key [2730](#)
 Genesys, action, contact [1446](#)
 Genesys, action, division [1444](#)
 Genesys, action, group [1447](#)
 Genesys, action, organization, company [1449](#)
 Genesys, action, package [1443](#)
 Genesys, action, queue, route [1452](#)
 Genesys, action, role, permission [1453](#)
 Genesys, action, skill [1455](#)
 Genesys, action, user, agent [1457](#)
 Genesys, language, action [1448](#)
 Genesys, phone, routing, action [1451](#)
 Get bot run data API [2856](#)
 Get Immediate Parents [2845](#)
 Get task log data [2852](#)
 Gettasklogdata [2852](#)
 getting started [875](#), [876](#), [878](#), [884](#)
 Getting started
 Control Room [729](#)
 Git repository [2507](#)

H

HA
 processes [1013](#)
 HA high availability [789](#), [790](#), [1015](#), [1016](#)
 handle session [2188](#)
 hardware requirements [964](#)
 healthcheck api response [1005](#)
 heuristic feedback [2337](#), [2359](#)
 High Availability [813](#)
 High Availability (HA) [1011](#)
 historical
 Activity [2376](#)
 historical activity [2376](#)
 how to filter [2930](#)
 HTTPS [758](#)
 https [864](#), [886](#)

I

ie eol [201](#)
 IE EOL [676](#)
 import certificate [864](#), [886](#)
 input types [2167](#)
 install
 cloud [727](#)
 on Azure cluster [830](#)
 Install A2019 iqbot [964](#), [975](#)
 Install IQ Bot [964](#), [975](#)
 Install IQBot [964](#), [975](#)
 install token [870](#)
 installation
 configuration requirements [860](#)
 prerequisites [746](#)
 installation path [864](#), [886](#)
 installing IQ Bot Platform [978](#)
 integrate aws secrets manager [2636](#)
 integrate azure key vault [2622](#)
 integrate cyberark password vault [2602](#)
 ip addresses
 required [860](#)
 ipall [750](#)
 iq bot custom logic [2291](#)
 IQ Bot Custom Logic [2291](#)
 IQ Bot Custom Logic examples [2294](#)
 IQ Bot custom logic user guide [2294](#)
 IQ Bot Custom Logic User Guide [2294](#)
 IQ Bot Validator task [2340](#)
 IQBot Custom Logic [2291](#)
 Iterator [2176](#)

J

journalid [2914](#)

K

key vault [2591](#), [2593](#)
 key vault names [2598](#)
 key vault naming convention [2598](#)
 key vault utility [2649](#)
 key vault utility aws [2640](#)

key vault utility azure [2626](#)
 key vault utility cyberark [2612](#)
 Kiwi Syslog Server [2499](#)
 known limitations [521](#), [531](#), [538](#), [544](#), [550](#), [557](#), [558](#)

L

language settings [860](#)
 License
 overview [904](#)
 trial [889](#)
 license expiry [896](#)
 License expiry [912](#)
 license portal [910](#)
 license server [904](#), [2540](#)
 list migration results [2910](#)
 List Roles API [2745](#)
 load balancer [758](#)
 locker [2585](#), [2589](#)
 Locker
 edit [2590](#)
 log in authconfig app [2523](#)
 log on [915](#)
 logging [2413](#)
 login [915](#)
 login steps [915](#)
 logs [2413](#)

M

maintenance
 databases [747](#)
 maintenance updates [664](#)
 manage bot ideas [2686](#)
 manage-work-item [2570](#)
 manual mode [876](#), [884](#)
 master key [875](#), [876](#), [878](#), [884](#)
 MatchesRegex [2171](#)
 messaging [862](#)
 Microsoft SQL server [789](#), [1015](#), [1016](#)
 Microsoft SQL Server [742](#)
 Microsoft Windows Server [742](#)
 migrate a360 [1020](#)
 migrated credentials [2924](#)
 migrated users [2922](#)
 migration [1020](#), [2914](#)
 migration API [2914](#)
 migration api filters [2930](#)
 migration apis [2906](#)
 migration journal id [2914](#)
 migration to gcp [141](#)
 migration, migrate [1293](#)
 monitor migration [2914](#)
 Multi login [2450](#)
 Multi login user [2450](#)
 Multi-login [2450](#)
 my devices [2388](#)
 my profile [2662](#)

N

.NET Framework [742](#)

netmask [2492](#)
 new features [521](#), [531](#), [538](#), [544](#), [550](#), [557](#), [558](#)
 non-active directory [915](#)
 notification [1337](#), [1534](#), [1586](#), [1588](#), [1590](#), [1592](#), [1845](#)
 NTP settings [860](#)
 numeric [2703](#), [2704](#)

O

ocr [1551](#), [1552](#), [1553](#), [1554](#), [1555](#)
 offline [2388](#)
 Open [1265](#)
 operating systems
 compatibility [731](#), [752](#)
 operational data [25](#)
 operations
 repository [744](#)
 organize actions [2166](#)
 Overview
 Administration [2413](#)
 credentials [2584](#)
 users [2443](#)

P

package
 manage [2402](#)
 package management [2409](#)
 package sdk [2151](#)
 Package SDK [628](#)
 Package SDK input types [2167](#)
 package sdk regex [2172](#)
 Package SDK Release notes [628](#)
 package updates [86](#)
 package versions [86](#)
 packages rbac [2403](#)
 parse JSON [2216](#)
 password [875](#), [876](#), [878](#), [884](#), [2451](#)
 password limitation [800](#)
 pause task [1823](#)
 paused [2373](#)
 paused for input [2373](#)
 permissions
 required [860](#)
 personal data [25](#)
 pool id [2866](#)
 ports required [760](#)
 postgresSQL [800](#)
 postgresSQL server [789](#), [1015](#), [1016](#)
 Power BI [2716](#)
 prerequisites [746](#)
 primary site
 disaster recovery [790](#), [794](#), [1016](#), [1018](#)
 HA [789](#), [1015](#)
 privacy [25](#)
 product licenses [2539](#)
 profile [2662](#)
 properties [1337](#), [1534](#), [1586](#), [1588](#), [1590](#), [1592](#)
 Python [2216](#)

Q

queue [2373](#)
 queue-consumers [2548](#)
 queue-participants [2548](#)

R

Rabbit MQ startup failure [1005](#)
 RAM [742](#)
 rbac packages [2408](#)
 record task [1819](#)
 recovery
 databases [747](#), [747](#)
 recovery site [790](#), [794](#), [1016](#), [1018](#)
 Refresh Authentication API [2733](#)
 Refresh token API [2733](#)
 refresh tokens [2527](#)
 region settings [860](#)
 release notes [59](#), [521](#), [531](#), [538](#), [544](#), [550](#), [557](#), [558](#)
 remote git [2507](#)
 rename task [1819](#)
 repeat [1337](#), [1534](#), [1586](#), [1588](#), [1590](#), [1592](#), [1727](#)
 repeat a task [1727](#)
 repository
 concurrent operations [744](#)
 repository management api filters [2930](#)
 repository requirements [765](#)
 requirements
 credentials [755](#)
 reset [2451](#)
 Rest API GET [1632](#)
 Rest Web Service Put method [1636](#)
 retirement [667](#)
 retrieve migrated bots [2926](#)
 Retrieve role [2747](#), [2848](#), [2850](#)
 Retrieve Role API [2747](#), [2848](#), [2850](#)
 Return codes [2934](#)
 return values [2164](#)
 reverse proxy [862](#)
 review control rooms [2524](#)
 Role
 create [2452](#)
 new [2452](#)
 roles [2465](#), [2576](#)
 run [1822](#)
 run a bot [1822](#), [2378](#)
 run bot [1822](#), [2388](#)
 run bot now [1822](#)
 run task [1819](#), [1823](#)
 run-as-user [2556](#)
 running a task [1823](#)

S

Salesforce, action, attachment [1651](#)
 Salesforce, action, authentication, authorization, auth [1638](#)
 Salesforce, action, delete, record [1646](#)
 Salesforce, action, download file, attachment [1648](#), [1653](#)
 Salesforce, action, Get, Read, record [1644](#)
 Salesforce, action, Insert, record [1642](#)
 Salesforce, action, package [1638](#)

Salesforce, action, query, soql [1649](#)
 Salesforce, action, Update, record [1645](#)
 saml [889](#), [2494](#)
 saml access [2685](#), [2686](#)
 saml idp [873](#)
 SAP [1654](#)
 SAP automation [1654](#)
 SAP integration [1654](#)
 schedule
 activity [2383](#)
 change [2381](#)
 schedule a bot [2378](#)
 scheduled activity
 delete [2383](#)
 edit [2381](#)
 Scheduled activity [2378](#)
 SDK [2151](#)
 SDK expose property [2165](#)
 secondary site
 disaster recovery [790](#), [794](#), [1016](#), [1018](#)
 HA [789](#), [1015](#)
 security [1337](#), [1534](#), [1586](#), [1588](#), [1590](#), [1592](#)
 security question [875](#), [876](#), [878](#), [884](#)
 self-signed [804](#), [864](#), [886](#)
 self-signed certificate [864](#), [886](#)
 send to task [1819](#)
 server
 hardware prerequisites [746](#)
 server message block (SMB) file share [789](#), [1015](#), [1016](#)
 servers
 databases [747](#)
 service provider [873](#)
 service status site [659](#), [667](#)
 Service_Credentials [807](#)
 Servicenow, action, package [1676](#)
 ServiceNow, trigger, new record [2025](#)
 ServiceNow, update record, trigger [2026](#)
 Setting Sumo Logic [2518](#), [2519](#), [2521](#)
 setup [742](#)
 shared session [2191](#)
 SIEM [2518](#), [2519](#), [2521](#)
 SIEM integration [2517](#)
 single-sign on [800](#)
 single sign-on [876](#), [878](#), [884](#)
 smart card [881](#)
 smart card administrator [883](#)
 SMB file share [789](#), [1015](#), [1016](#)
 SMB share
 disaster recovery [1018](#)
 software development kit [2151](#)
 software requirements [964](#)
 speed [1337](#), [1534](#), [1586](#), [1588](#), [1590](#), [1592](#)
 Splunk [2499](#)
 sql [750](#)
 SQL
 database [747](#)
 sql authentication [865](#), [2498](#)
 sql server [750](#)
 SQL server [789](#), [1015](#), [1016](#)
 sql server configuration manager [750](#)
 sql settings [865](#), [2498](#)
 sso, Okta [890](#), [891](#), [892](#), [893](#), [894](#)

stop task [1823](#)
 storage
 databases [797](#)
 subnet [2492](#)
 subversion [742](#)
 subversion (SVN) server [789](#), [1015](#), [1016](#)
 Sumo Logic [2517](#)
 SVN repository [742](#)
 SVN server [789](#), [1015](#), [1016](#)
 switch control room [946](#)
 synchronization
 time [860](#)
 Syslog [2499](#)
 system variable [1849](#)

T

Table
 Activity [2378](#)
 task [1823](#)
 task list [1819](#)
 TCP [758](#)
 technical architecture [20](#), [20](#)
 test [1823](#)
 time [2703](#), [2704](#)
 time-based event-based triggers [2182](#)
 timeout [1845](#)
 TLS [804](#)
 token [2515](#)
 Trial
 license [889](#)
 Trigger event [2793](#)
 Trigger mapping [2793](#)
 Trigger mapping API [2793](#), [2795](#)
 Triggermapping API [2793](#), [2795](#)
 troubleshoot key vaults [2651](#)
 tuning
 parallel repository operations [744](#)

U

unattended bot runner
 license [904](#)
 uninstalling IQ Bot [1011](#)
 uninstalling platform [1011](#)
 update a2019 [957](#)
 update a2019 on-prem [957](#)
 update enterprise a2019 [957](#)
 Update role [2751](#)
 Update Role API [2751](#)
 update to latest a2019 [957](#)
 update to latest enterprise a2019 [957](#)
 update window [664](#)
 upgrade a360 [1020](#)
 upgrade automation 360 [1020](#)
 upgrade automation anywhere [1020](#)
 upload custom package [2161](#)
 upload packages [2409](#)
 upload task [1819](#)
 user management api filters [2930](#)
 userName [2788](#)
 users [2576](#)

Users
 overview [2443](#)
 using excel action [1414](#)
 using ocr action [1551](#), [1552](#), [1553](#), [1554](#), [1555](#)
 using variables [1849](#)

V

V4 Bot Deploy [2881](#)
 validation annotation [2197](#)
 validation annotations [2200](#)
 variables [1849](#)
 Verify [2731](#)
 Verify API [2731](#)
 verify key vault [2650](#)
 Verify token API [2731](#)
 version
 release notes [59](#)
 version control [2504](#)
 versions
 browsers supported [766](#)
 view licenses [2539](#)
 view log [1337](#), [1534](#), [1586](#), [1588](#), [1590](#), [1592](#)
 view-work-item [2570](#)
 view-work-item-result [2571](#)
 view-work-items [2571](#)
 visual basic [1909](#)

W

white list [734](#), [869](#)
 whitelist [734](#), [869](#), [2492](#)
 whitelisting [734](#), [869](#)
 windows services [862](#)
 windows authentication [750](#)
 Windows services
 required [860](#)
 Windows_Services [807](#)
 wizard [875](#), [876](#), [878](#), [884](#)
 wlm [2543](#)
 work-item-structure [2549](#)
 workload management [2543](#)
 workload-maintenance [2557](#)
 workload-queues [2545](#)